



# TEST REPORT

**Report Reference No.**..... : **TRE1710013301** R/C.....: 92383

**FCC ID**..... : **2AGY3BHS630**

**Applicant's name**..... : **DAGUI TECHNOLOGY (SHENZHEN) CO.,LTD.**

**Address**..... : 28h,1 unit,5th period,Xinghai Building,the intersection of Shennan Road and Qianhai Road, Nanshan District,Shenzhen, Guangdong,China

**Manufacturer**..... : **DAGUI TECHNOLOGY (SHENZHEN) CO.,LTD.**

**Address**..... : 28h,1 unit,5th period,Xinghai Building,the intersection of Shennan Road and Qianhai Road, Nanshan District,Shenzhen, Guangdong,China

**Test item description** ..... : **Bluetooth Headset**

**Trade Mark** ..... : Phaiser

**Model/Type reference**..... : BHS-630

**Listed Model(s)** ..... : -

**Standard** ..... : **FCC CFR Title 47 Part 15 Subpart C Section 15.247**

**Date of receipt of test sample**..... : Oct. 26, 2017

**Date of testing**..... : Oct. 26, 2017 - Nov. 06, 2017

**Date of issue**..... : Nov. 06, 2017

**Result**..... : **PASS**

Compiled by  
( Position+Printed name+Signature): File administrators Becky Liang

Supervised by  
(Position+Printed name+Signature): Project Engineer Jerry Wang

Approved by  
(Position+Printed name+Signature): RF Manager Hans Hu

**Testing Laboratory Name** ..... : **Shenzhen Huatongwei International Inspection Co., Ltd.**

**Address**..... : 1/F, Bldg 3, Hongfa Hi-tech Industrial Park, Genyu Road, Tianliao, Gongming, Shenzhen, China

**Shenzhen Huatongwei International Inspection Co., Ltd. All rights reserved.**

This publication may be reproduced in whole or in part for non-commercial purposes as long as the Shenzhen Huatongwei International Inspection Co., Ltd. is acknowledged as copyright owner and source of the material. Shenzhen Huatongwei International Inspection Co., Ltd. takes no responsibility for and will not assume liability for damages resulting from the reader's interpretation of the reproduced material due to its placement and context.

*The test report merely correspond to the test sample.*

## Contents

<b>1.</b>	<b><u>TEST STANDARDS AND REPORT VERSION</u></b>	<b>3</b>
1.1.	Test Standards	3
1.2.	Report version	3
<b>2.</b>	<b><u>TEST DESCRIPTION</u></b>	<b>4</b>
<b>3.</b>	<b><u>SUMMARY</u></b>	<b>5</b>
3.1.	Client Information	5
3.2.	Product Description	5
3.3.	Operation state	6
3.4.	EUT configuration	6
3.5.	Modifications	6
<b>4.</b>	<b><u>TEST ENVIRONMENT</u></b>	<b>7</b>
4.1.	Address of the test laboratory	7
4.2.	Test Facility	7
4.3.	Environmental conditions	8
4.4.	Statement of the measurement uncertainty	8
4.5.	Equipments Used during the Test	9
<b>5.</b>	<b><u>TEST CONDITIONS AND RESULTS</u></b>	<b>10</b>
5.1.	Antenna requirement	10
5.2.	Conducted Emissions (AC Main)	11
5.3.	Conducted Peak Output Power	14
5.4.	20 dB Bandwidth	18
5.5.	Carrier Frequencies Separation	22
5.6.	Hopping Channel Number	24
5.7.	Dwell Time	26
5.8.	Pseudorandom Frequency Hopping Sequence	33
5.9.	Restricted band (radiated)	34
5.10.	Band edge and Spurious Emissions (conducted)	36
5.11.	Spurious Emissions (radiated)	52
<b>6.</b>	<b><u>TEST SETUP PHOTOS</u></b>	<b>56</b>
<b>7.</b>	<b><u>EXTERANAL AND INTERNAL PHOTOS</u></b>	<b>58</b>

## 1. TEST STANDARDS AND REPORT VERSION

### 1.1. Test Standards

The tests were performed according to following standards:

[FCC Rules Part 15.247](#): Frequency Hopping, Direct Spread Spectrum and Hybrid Systems that are in operation within the bands of 902-928 MHz, 2400-2483.5 MHz, and 5725-5850 MHz

[ANSI C63.10-2013](#): American National Standard for Testing Unlicensed Wireless Devices

### 1.2. Report version

Version No.	Date of issue	Description
00	Nov. 06, 2017	Original

## **2. TEST DESCRIPTION**

<b>Test Item</b>	<b>Section in CFR 47</b>	<b>Result</b>	<b>Test Engineer</b>
Antenna Requirement	15.203/15.247 (c)	Pass	Jerry Wang
AC Power Line Conducted Emissions	15.207	Pass	Shower Dai
Conducted Peak Output Power	15.247 (b)(1)	Pass	Baozhu Hu
20 dB Bandwidth	15.247 (a)(1)	Pass	Baozhu Hu
Carrier Frequencies Separation	15.247 (a)(1)	Pass	Baozhu Hu
Hopping Channel Number	15.247 (a)(1)	Pass	Baozhu Hu
Dwell Time	15.247 (a)(1)	Pass	Baozhu Hu
Pseudorandom Frequency Hopping Sequence	15.247(b)(4)	Pass	Baozhu Hu
Restricted band	15.247(d)/15.205	Pass	Baozhu Hu
Radiated Emissions	15.247(d)/15.209	Pass	Shower Dai

Note: The measurement uncertainty is not included in the test result.

### 3. SUMMARY

#### 3.1. Client Information

Applicant:	DAGUI TECHNOLOGY (SHENZHEN) CO.,LTD.
Address:	28h,1 unit,5th period,Xinghai Building,the intersection of Shennan Road and Qianhai Road, Nanshan District,Shenzhen, Guangdong,China
Manufacturer:	DAGUI TECHNOLOGY (SHENZHEN) CO.,LTD.
Address:	28h,1 unit,5th period,Xinghai Building,the intersection of Shennan Road and Qianhai Road, Nanshan District,Shenzhen, Guangdong,China

#### 3.2. Product Description

Name of EUT:	Bluetooth Headset
Trade Mark:	Phaiser
Model No.:	BHS-630
Listed Model(s):	-
Power supply:	DC 3.7V from internal battery
Adapter information:	-
Hardware version:	V1.3
Software version:	1.0
<b>Bluetooth</b>	
Version:	Supported BT4.0+EDR
Modulation:	GFSK, $\pi/4$ DQPSK, 8DPSK
Operation frequency:	2402MHz~2480MHz
Channel number:	79
Channel separation:	1MHz
Antenna type:	Integral Antenna
Antenna gain:	1.20 dBi

### 3.3. Operation state

➤ **Test frequency list**

According to section 15.31(m), regards to the operating frequency range over 10 MHz, must select three channel which were tested. the Lowest frequency, the middle frequency, and the highest frequency of channel were selected to perform the test, please see the above gray bottom.

Channel	Frequency (MHz)
00	2402
01	2403
⋮	⋮
39	2441
⋮	⋮
77	2479
78	2480

➤ **TEST MODE**

For RF test items:
The engineering test program was provided and enabled to make EUT continuous transmit
For AC power line conducted emissions:
The EUT was set to connect with the Bluetooth instrument under large package sizes transmission.
For Radiated suprious emissions test item:
The engineering test program was provided and enabled to make EUT continuous transmit. The EUT in each of three orthogonal axis emissions had been tested ,but only the worst case (X axis) data recorded in the report.

### 3.4. EUT configuration

The following peripheral devices and interface cables were connected during the measurement:

- - supplied by the manufacturer
- - supplied by the lab

/	Manufacturer:	/
	Model No.:	/
/	Manufacturer:	/
	Model No.:	/

### 3.5. Modifications

No modifications were implemented to meet testing criteria.

## **4. TEST ENVIRONMENT**

### **4.1. Address of the test laboratory**

Laboratory: Shenzhen Huatongwei International Inspection Co., Ltd.

Address: 1/F, Bldg 3, Hongfa Hi-tech Industrial Park, Genyu Road, Tianliao, Gongming, Shenzhen, China

### **4.2. Test Facility**

#### **CNAS-Lab Code: L1225**

Shenzhen Huatongwei International Inspection Co., Ltd. has been assessed and proved to be in compliance with CNAS-CL01 Accreditation Criteria for Testing and Calibration Laboratories (identical to ISO/IEC17025: 2005 General Requirements) for the Competence of Testing and Calibration Laboratories.

#### **A2LA-Lab Cert. No.: 3902.01**

Shenzhen Huatongwei International Inspection Co., Ltd. EMC Laboratory has been accredited by A2LA for technical competence in the field of electrical testing, and proved to be in compliance with ISO/IEC 17025: 2005 General Requirements for the Competence of Testing and Calibration Laboratories and any additional program requirements in the identified field of testing.

#### **FCC-Registration No.: 762235**

Shenzhen Huatongwei International Inspection Co., Ltd. EMC Laboratory has been registered and fully described in a report filed with the FCC (Federal Communications Commission). The acceptance letter from the FCC is maintained in our files.

#### **IC-Registration No.:5377B-1**

Two 3m Alternate Test Site of Shenzhen Huatongwei International Inspection Co., Ltd. has been registered by Certification and Engineering Bureau of Industry Canada for the performance of radiated measurements with Registration No.: 5377B-1.

#### **ACA**

Shenzhen Huatongwei International Inspection Co., Ltd. EMC Laboratory can also perform testing for the Australian C-Tick mark as a result of our A2LA accreditation.

### 4.3. Environmental conditions

During the measurement the environmental conditions were within the listed ranges:

Temperature:	15~35°C
Relative Humidity:	30~60 %
Air Pressure:	950~1050mba

### 4.4. Statement of the measurement uncertainty

The data and results referenced in this document are true and accurate. The reader is cautioned that there may be errors in calibration limits of the equipment and facilities. The measurement uncertainty was calculated for all measurements listed in this test report according to TR-100028-01 "Electromagnetic compatibility and Radio spectrum Matters (ERM); Uncertainties in the measurement of mobile radio equipment characteristics; Part 1" and TR-100028-02 "Electromagnetic compatibility and Radio spectrum Matters (ERM); Uncertainties in the measurement of mobile radio equipment characteristics; Part 2" and is documented in the Shenzhen Huatongwei International Inspection Co., Ltd. quality system according to ISO/IEC 17025. Furthermore, component and process variability of devices similar to that tested may result in additional deviation. The manufacturer has the sole responsibility of continued compliance of the device.

Here after the best measurement capability for Shenzhen Huatongwei International Inspection Co., Ltd. is reported:

Test Items	Measurement Uncertainty	Notes
Transmitter power conducted	0.57 dB	(1)
Transmitter power Radiated	2.20 dB	(1)
Conducted spurious emissions 9kHz~40GHz	1.60 dB	(1)
Radiated spurious emissions 9kHz~40GHz	2.20 dB	(1)
Conducted Emissions 9kHz~30MHz	3.39 dB	(1)
Radiated Emissions 30~1000MHz	4.24 dB	(1)
Radiated Emissions 1~18GHz	5.16 dB	(1)
Radiated Emissions 18~40GHz	5.54 dB	(1)
Occupied Bandwidth	-----	(1)

(1) This uncertainty represents an expanded uncertainty expressed at approximately the 95% confidence level using a coverage factor of  $k=1.96$ .



#### 4.5. Equipments Used during the Test

Conducted Emissions					
Item	Test Equipment	Manufacturer	Model No.	Serial No.	Last Cal.
1	Artificial Mains	Rohde&Schwarz	ESH2-Z5	100028	2016/11/13
2	EMI Test Receiver	Rohde&Schwarz	ESCI3	100038	2016/11/13
3	Pulse Limiter	Rohde&Schwarz	ESHSZ2	100044	2016/11/13
4	EMI Test Software	Rohde&Schwarz	ES-K1 V1.71	-	-

Radiated Emissions					
Item	Test Equipment	Manufacturer	Model No.	Serial No.	Last Cal.
1	EMI test receiver	Rohde&Schwarz	ESI 26	100009	2016/11/13
2	Loop Antenna	Rohde&Schwarz	HFH2-Z2	100020	2016/11/13
3	Ultra-Broadband Antenna	ShwarzBeck	VULB9163	538	2016/11/13
4	Horn antenna	ShwarzBeck	9120D	1011	2016/11/13
5	Horn Antenna	SCHWARZBECK	BBHA9170	25841	2016/11/13
6	Amplifier	Sonoma	310N	E009-13	2016/11/13
7	JS Amplifier	Rohde&Schwarz	JS4-00101800-28-5A	F201504	2016/11/13
8	Amplifier	Compliance Direction systems	PAP1-4060	120	2016/11/13
9	High pass filter	Compliance Direction systems	BSU-6	34202	2016/11/13
10	EMI test Software	Rohde&Schwarz	ESK1	-	-
11	EMI test Software	Audix	E3	-	-
12	TURNTABLE	MATURO	TT2.0	-	-
13	ANTENNA MAST	MATURO	TAM-4.0-P	-	-

RF Conducted methods					
Item	Test Equipment	Manufacturer	Model No.	Serial No.	Last Cal.
1	Spectrum Analyzer	Rohde&Schwarz	FSP	1164.4391.40	2016/11/13
2	MXA Signal Analyzer	Agilent Technologies	N9020A	MY5050187	2016/11/13

The Cal.Interval was one year.

## 5. TEST CONDITIONS AND RESULTS

### 5.1. Antenna requirement

#### Requirement

##### **FCC CFR Title 47 Part 15 Subpart C Section 15.203:**

An intentional radiator shall be designed to ensure that no antenna other than that furnished by the responsible party shall be used with the device. The use of a permanently attached antenna or of an antenna that uses a unique coupling to the intentional radiator, the manufacturer may design the unit so that a broken antenna can be replaced by the user, but the use of a standard antenna jack or electrical connector is prohibited.

##### **FCC CFR Title 47 Part 15 Subpart C Section 15.247(c) (1)(i):**

(i) Systems operating in the 2400~2483.5 MHz band that is used exclusively for fixed. Point-to-point operations may employ transmitting antennas with directional gain greater than 6 dBi provided the maximum conducted output power of the intentional radiator is reduced by 1 dB for every 3 dB that the directional gain of the antenna exceeds 6 dBi.

#### Test Result:

**Passed**       **Not Applicable**

The directional gain of the antenna less than 6 dBi, please refer to the below antenna photo.

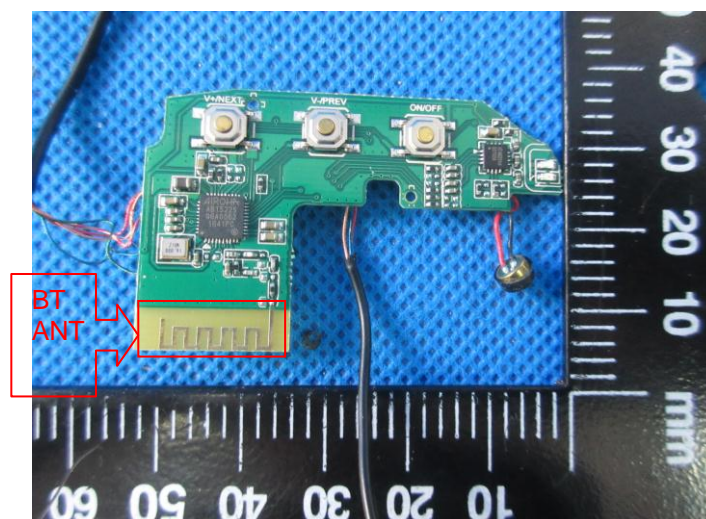

## 5.2. Conducted Emissions (AC Main)

### LIMIT

FCC CFR Title 47 Part 15 Subpart C Section 15.207

Frequency range (MHz)	Limit (dBuV)	
	Quasi-peak	Average
0.15-0.5	66 to 56*	56 to 46*
0.5-5	56	46
5-30	60	50

\* Decreases with the logarithm of the frequency.

### TEST CONFIGURATION

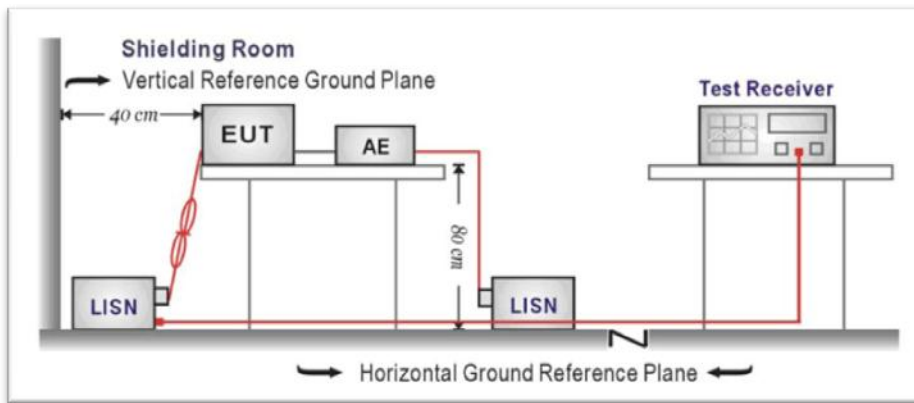

### TEST PROCEDURE

1. The EUT was setup according to ANSI C63.10:2013 requirements.
2. The EUT was placed on a platform of nominal size, 1 m by 1.5 m, raised 80 cm above the conducting ground plane. The vertical conducting plane was located 40 cm to the rear of the EUT. All other surfaces of EUT were at least 80 cm from any other grounded conducting surface.
3. The EUT and simulators are connected to the main power through a line impedances stabilization network (LISN). The LISN provides a 50 ohm /50uH coupling impedance for the measuring equipment.
4. The peripheral devices are also connected to the main power through a LISN. (Please refer to the block diagram of the test setup and photographs)
5. Each current-carrying conductor of the EUT power cord, except the ground (safety) conductor, was individually connected through a LISN to the input power source.
6. The excess length of the power cord between the EUT and the LISN receptacle were folded back and forth at the center of the lead to form a bundle not exceeding 40 cm in length.
7. Conducted emissions were investigated over the frequency range from 0.15MHz to 30MHz using a receiver bandwidth of 9 kHz.
8. During the above scans, the emissions were maximized by cable manipulation.

### TEST RESULTS

Passed       Not Applicable

Note:

- 1) Transd= Cable lose + Pulse Limiter Factor + Artificial Mains Factor
- 2) Margin= Limit - Level

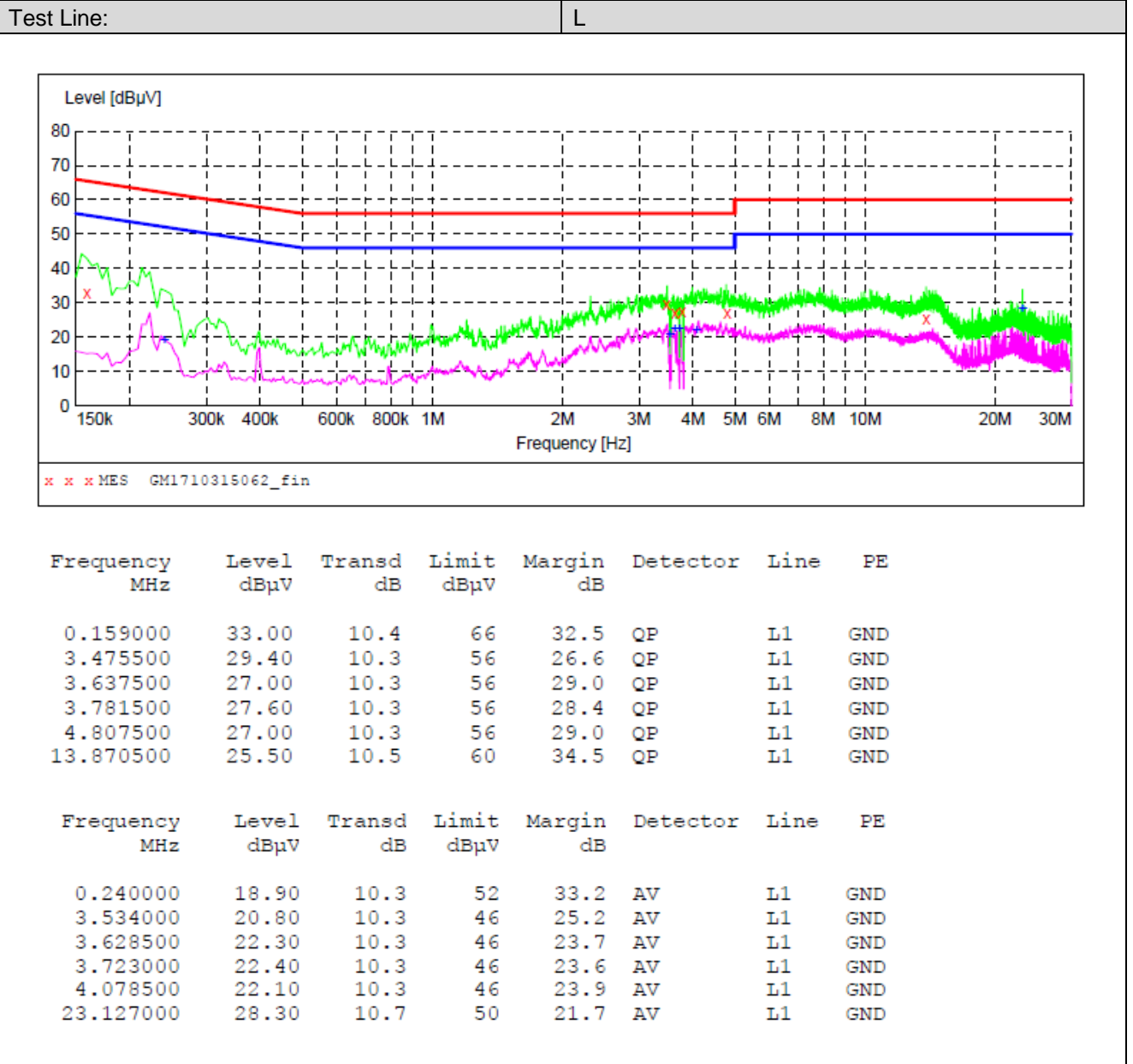

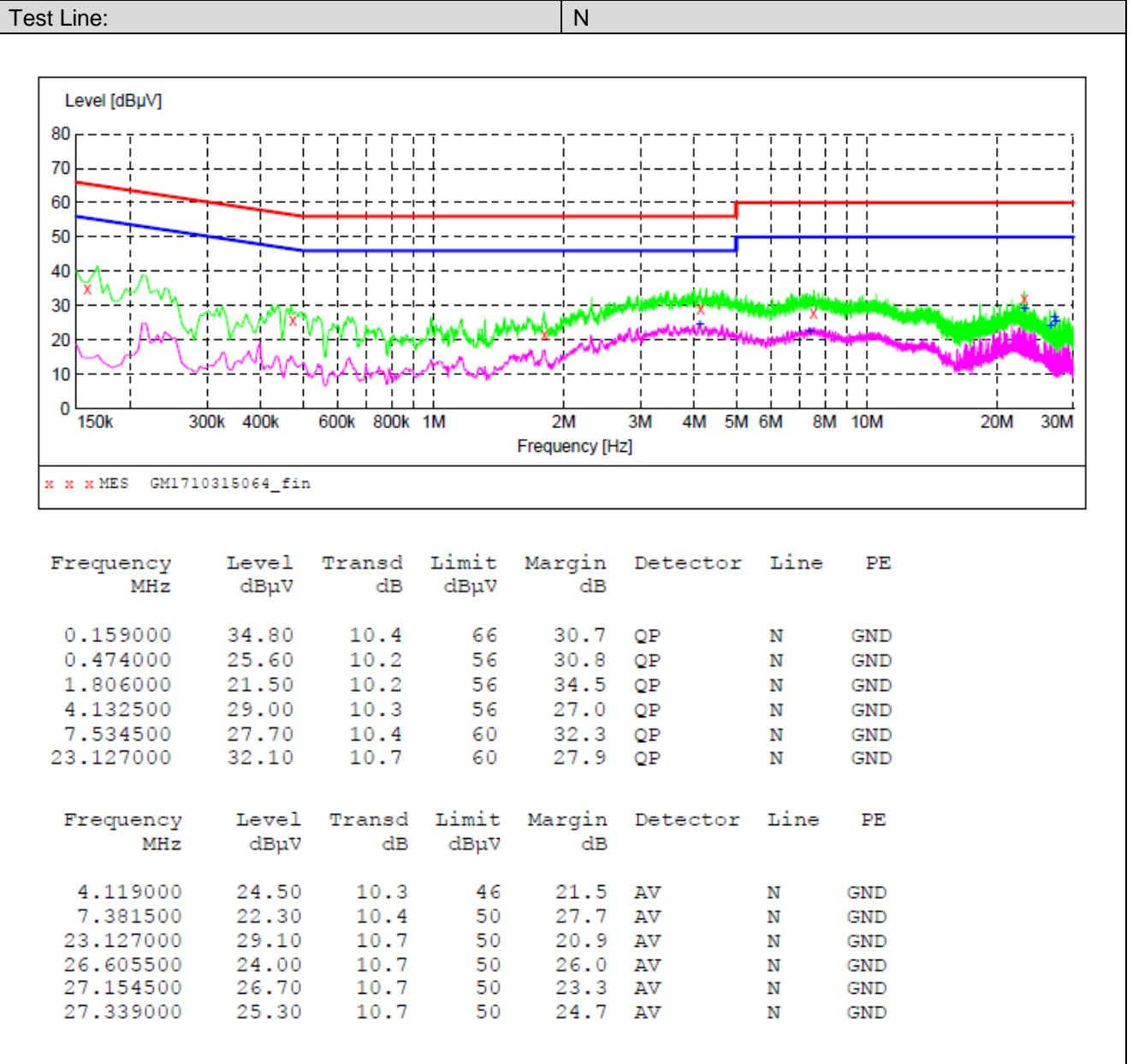

### 5.3. Conducted Peak Output Power

#### LIMIT

FCC CFR Title 47 Part 15 Subpart C Section 15.247 (b)(1): For frequency hopping systems operating in the 2400-2483.5 MHz band employing at least 75 non-overlapping hopping channels, and all frequency hopping systems in the 5725-5850 MHz band: 1 watt. For all other frequency hopping systems in the 2400-2483.5 MHz band: 0.125 watts.

#### TEST CONFIGURATION

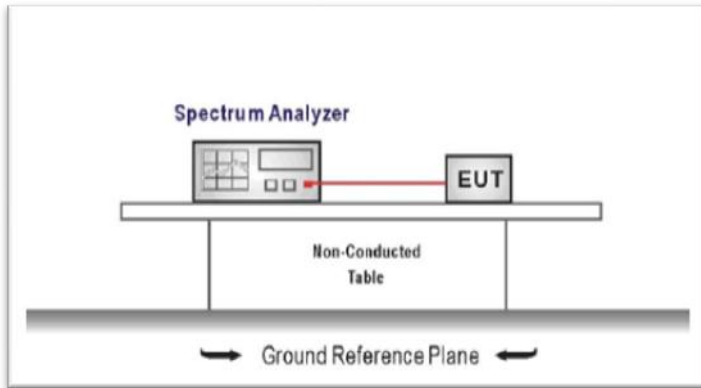

#### TEST PROCEDURE

1. The transmitter output was connected to the spectrum analyzer through an attenuator, the pathloss was compensated to the results for each measurement.
2. Set to the maximum power setting and enable the EUT transmit continuously
3. Use the following spectrum analyzer settings:  
 Span = approximately 5 times the 20 dB bandwidth, centered on a hopping channel  
 RBW ≥ the 20 dB bandwidth of the emission being measured, VBW ≥ RBW  
 Sweep = auto, Detector function = peak, Trace = max hold
4. Measure and record the results in the test report.

#### TEST MODE:

Please refer to the clause 3.3

#### TEST RESULTS

Passed       Not Applicable

Modulation type	Channel	Output power (dBm)	Limit (dBm)	Result
GFSK	00	-0.04	≤ 30.00	Pass
	39	0.02		
	78	-0.54		
π/4DQPSK	00	-1.34	≤ 21.00	Pass
	39	-1.23		
	78	-1.74		
8DPSK	00	-1.18	≤ 21.00	Pass
	39	-0.97		
	78	-1.56		

Modulation Type:		GFSK	
CH00		<p>Agilent Spectrum Analyzer - Swept SA          Center Freq 2.40200000 GHz          #Avg Type: RMS          AvgHold: 500/500          Ref Offset 0.5 dB          Ref 20.00 dBm          Mkr1 2.401860 GHz          -0.035 dBm          Center 2.402000 GHz          #Res BW 1.0 MHz          #VBW 3.0 MHz          Span 5.000 MHz          Sweep 1.000 ms (1001 pts)</p>	<p>Frequency</p> <p>Auto Tune</p> <p>Center Freq 2.40200000 GHz</p> <p>Start Freq 2.399500000 GHz</p> <p>Stop Freq 2.404500000 GHz</p> <p>CF Step 500.000 kHz Auto Man</p> <p>Freq Offset 0 Hz</p>
CH39		<p>Agilent Spectrum Analyzer - Swept SA          Center Freq 2.44100000 GHz          #Avg Type: RMS          AvgHold: 500/500          Ref Offset 0.5 dB          Ref 20.00 dBm          Mkr1 2.441155 GHz          0.015 dBm          Center 2.441000 GHz          #Res BW 1.0 MHz          #VBW 3.0 MHz          Span 5.000 MHz          Sweep 1.000 ms (1001 pts)</p>	<p>Frequency</p> <p>Auto Tune</p> <p>Center Freq 2.44100000 GHz</p> <p>Start Freq 2.438500000 GHz</p> <p>Stop Freq 2.443500000 GHz</p> <p>CF Step 500.000 kHz Auto Man</p> <p>Freq Offset 0 Hz</p>
CH78		<p>Agilent Spectrum Analyzer - Swept SA          Center Freq 2.48000000 GHz          #Avg Type: RMS          AvgHold: 500/500          Ref Offset 0.5 dB          Ref 20.00 dBm          Mkr1 2.479925 GHz          -0.544 dBm          Center 2.480000 GHz          #Res BW 1.0 MHz          #VBW 3.0 MHz          Span 5.000 MHz          Sweep 1.000 ms (1001 pts)</p>	<p>Frequency</p> <p>Auto Tune</p> <p>Center Freq 2.48000000 GHz</p> <p>Start Freq 2.477500000 GHz</p> <p>Stop Freq 2.482500000 GHz</p> <p>CF Step 500.000 kHz Auto Man</p> <p>Freq Offset 0 Hz</p>

Modulation Type:		$\pi/4$ DQPSK
CH00		<p>Agilent Spectrum Analyzer - Swept SA</p> <p>Center Freq 2.40200000 GHz</p> <p>Mkr1 2.402 140 GHz -1.337 dBm</p> <p>Center 2.402000 GHz</p> <p>Span 5.000 MHz</p> <p>#Res BW 1.0 MHz</p> <p>#VBW 3.0 MHz</p> <p>Sweep 1.000 ms (1001 pts)</p>
CH39		<p>Agilent Spectrum Analyzer - Swept SA</p> <p>Center Freq 2.44100000 GHz</p> <p>Mkr1 2.440 840 GHz -1.234 dBm</p> <p>Center 2.441000 GHz</p> <p>Span 5.000 MHz</p> <p>#Res BW 1.0 MHz</p> <p>#VBW 3.0 MHz</p> <p>Sweep 1.000 ms (1001 pts)</p>
CH78		<p>Agilent Spectrum Analyzer - Swept SA</p> <p>Center Freq 2.48000000 GHz</p> <p>Mkr1 2.480 100 GHz -1.743 dBm</p> <p>Center 2.480000 GHz</p> <p>Span 5.000 MHz</p> <p>#Res BW 1.0 MHz</p> <p>#VBW 3.0 MHz</p> <p>Sweep 1.000 ms (1001 pts)</p>



Modulation Type:		8DPSK
CH00	<p>Agilent Spectrum Analyzer - Swept SA                  Center Freq 2.40200000 GHz                  Ref Offset 0.5 dB                  Ref 20.00 dBm                  Mkr1 2.401 985 GHz                  -1.183 dBm                  Center 2.402000 GHz                  #Res BW 1.0 MHz                  #VBW 3.0 MHz                  Span 5.000 MHz                  Sweep 1.000 ms (1001 pts)</p>	Frequency Auto Tune Center Freq 2.40200000 GHz Start Freq 2.395500000 GHz Stop Freq 2.404500000 GHz CF Step 500.000 kHz Freq Offset 0 Hz
CH39	<p>Agilent Spectrum Analyzer - Swept SA                  Center Freq 2.44100000 GHz                  Ref Offset 0.5 dB                  Ref 20.00 dBm                  Mkr1 2.440 990 GHz                  -0.972 dBm                  Center 2.441000 GHz                  #Res BW 1.0 MHz                  #VBW 3.0 MHz                  Span 5.000 MHz                  Sweep 1.000 ms (1001 pts)</p>	Frequency Auto Tune Center Freq 2.44100000 GHz Start Freq 2.435500000 GHz Stop Freq 2.443500000 GHz CF Step 500.000 kHz Freq Offset 0 Hz
CH78	<p>Agilent Spectrum Analyzer - Swept SA                  Center Freq 2.48000000 GHz                  Ref Offset 0.5 dB                  Ref 20.00 dBm                  Mkr1 2.479 965 GHz                  -1.563 dBm                  Center 2.480000 GHz                  #Res BW 1.0 MHz                  #VBW 3.0 MHz                  Span 5.000 MHz                  Sweep 1.000 ms (1001 pts)</p>	Frequency Auto Tune Center Freq 2.48000000 GHz Start Freq 2.477500000 GHz Stop Freq 2.482500000 GHz CF Step 500.000 kHz Freq Offset 0 Hz

## 5.4. 20 dB Bandwidth

### LIMIT

N/A

### TEST CONFIGURATION

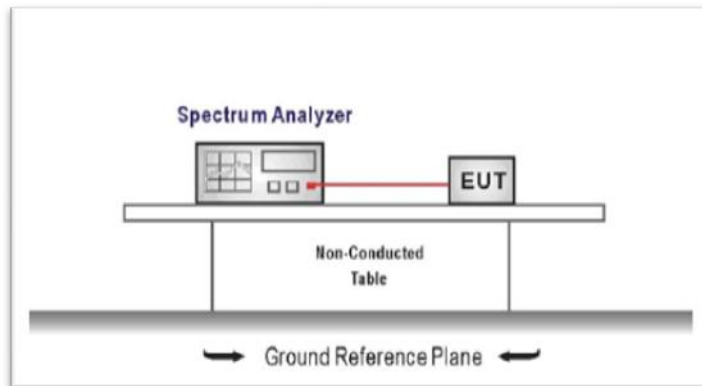

### TEST PROCEDURE

1. The transmitter output was connected to the spectrum analyzer through an attenuator, the path loss was compensated to the results for each measurement.
2. Set to the maximum power setting and enable the EUT transmit continuously
3. Use the following spectrum analyzer settings:  
Span = approximately 2 to 3 times the 20 dB bandwidth, centered on a hopping channel  
RBW  $\geq$  1% of the 20 dB bandwidth, VBW  $\geq$  RBW  
Sweep = auto, Detector function = peak, Trace = max hold
4. Measure and record the results in the test report.

### TEST MODE:

Please refer to the clause 3.3

### TEST RESULTS

 Passed       Not Applicable

Modulation type	Channel	20 dB Bandwidth (MHz)	Limit (MHz)	Result
GFSK	00	0.972	-	Pass
	39	0.976		
	78	0.954		
$\pi/4$ DQPSK	00	1.311	-	Pass
	39	1.314		
	78	1.291		
8DPSK	00	1.287	-	Pass
	39	1.293		
	78	1.289		

Modulation Type:		GFSK	
CH00		<p>Agilent Spectrum Analyzer - Occupied BW</p> <p>Center Freq 2.40200000 GHz</p> <p>Center Freq: 2.402000000 GHz</p> <p>Mkr1 2.40216 GHz</p> <p>-2.3506 dBm</p> <p>Occupied Bandwidth 899.94 kHz</p> <p>Total Power 7.51 dBm</p> <p>Transmit Freq Error 3.313 kHz</p> <p>OBW Power 99.00 %</p> <p>x dB Bandwidth 972.1 kHz</p> <p>x dB -20.00 dB</p>	<p>Frequency</p> <p>Center Freq 2.40200000 GHz</p> <p>CF Step 250.000 kHz</p> <p>Freq Offset 0 Hz</p>
CH39		<p>Agilent Spectrum Analyzer - Occupied BW</p> <p>Center Freq 2.441000000 GHz</p> <p>Center Freq: 2.441000000 GHz</p> <p>Mkr1 2.4411625 GHz</p> <p>-2.2517 dBm</p> <p>Occupied Bandwidth 891.57 kHz</p> <p>Total Power 7.44 dBm</p> <p>Transmit Freq Error 2.735 kHz</p> <p>OBW Power 99.00 %</p> <p>x dB Bandwidth 976.0 kHz</p> <p>x dB -20.00 dB</p>	<p>Frequency</p> <p>Center Freq 2.441000000 GHz</p> <p>CF Step 250.000 kHz</p> <p>Freq Offset 0 Hz</p>
CH78		<p>Agilent Spectrum Analyzer - Occupied BW</p> <p>Center Freq 2.480000000 GHz</p> <p>Center Freq: 2.480000000 GHz</p> <p>Mkr1 2.480165 GHz</p> <p>-2.7838 dBm</p> <p>Occupied Bandwidth 898.11 kHz</p> <p>Total Power 6.76 dBm</p> <p>Transmit Freq Error 4.500 kHz</p> <p>OBW Power 99.00 %</p> <p>x dB Bandwidth 954.1 kHz</p> <p>x dB -20.00 dB</p>	<p>Frequency</p> <p>Center Freq 2.480000000 GHz</p> <p>CF Step 250.000 kHz</p> <p>Freq Offset 0 Hz</p>

Modulation Type:		$\pi/4$ DQPSK	
CH00		<p>Agilent Spectrum Analyzer - Occupied BW          Center Freq 2.40200000 GHz          Center Freq: 2.402000000 GHz          Trig: Free Run          Avg/Hold: 500/500          Radio Std: None          Radio Device: BTS</p> <p>Ref Offset 0.5 dB          Ref 20.00 dBm          Mkr1 2.402165 GHz          -5.0570 dBm</p> <p>Center 2.402 GHz          #Res BW 30 kHz          #VBW 100 kHz          Span 2.5 MHz          Sweep 2.667 ms</p> <p>Occupied Bandwidth 1.1791 MHz          Total Power 5.24 dBm</p> <p>Transmit Freq Error 2.059 kHz          OBW Power 99.00 %          x dB Bandwidth 1.311 MHz          x dB -20.00 dB</p>	<p>Frequency</p> <p>Center Freq 2.402000000 GHz</p> <p>CF Step 250.000 kHz          Auto Man</p> <p>Freq Offset 0 Hz</p>
CH39		<p>Agilent Spectrum Analyzer - Occupied BW          Center Freq 2.441000000 GHz          Center Freq: 2.441000000 GHz          Trig: Free Run          Avg/Hold: 500/500          Radio Std: None          Radio Device: BTS</p> <p>Ref Offset 0.5 dB          Ref 20.00 dBm          Mkr1 2.4411675 GHz          -4.8628 dBm</p> <p>Center 2.441 GHz          #Res BW 30 kHz          #VBW 100 kHz          Span 2.5 MHz          Sweep 2.667 ms</p> <p>Occupied Bandwidth 1.1788 MHz          Total Power 5.30 dBm</p> <p>Transmit Freq Error 1.823 kHz          OBW Power 99.00 %          x dB Bandwidth 1.314 MHz          x dB -20.00 dB</p>	<p>Frequency</p> <p>Center Freq 2.441000000 GHz</p> <p>CF Step 250.000 kHz          Auto Man</p> <p>Freq Offset 0 Hz</p>
CH78		<p>Agilent Spectrum Analyzer - Occupied BW          Center Freq 2.480000000 GHz          Center Freq: 2.480000000 GHz          Trig: Free Run          Avg/Hold: 500/500          Radio Std: None          Radio Device: BTS</p> <p>Ref Offset 0.5 dB          Ref 20.00 dBm          Mkr1 2.4801675 GHz          -5.1999 dBm</p> <p>Center 2.48 GHz          #Res BW 30 kHz          #VBW 100 kHz          Span 2.5 MHz          Sweep 2.667 ms</p> <p>Occupied Bandwidth 1.1716 MHz          Total Power 4.99 dBm</p> <p>Transmit Freq Error 1.234 kHz          OBW Power 99.00 %          x dB Bandwidth 1.291 MHz          x dB -20.00 dB</p>	<p>Frequency</p> <p>Center Freq 2.480000000 GHz</p> <p>CF Step 250.000 kHz          Auto Man</p> <p>Freq Offset 0 Hz</p>

Modulation Type:		8DPSK
CH00	<p>Agilent Spectrum Analyzer - Occupied BW                  Center Freq 2.40200000 GHz                  Center Freq: 2.402000000 GHz                  Trig: Free Run                  Avg/Hold: 500/500                  Radio Std: None                  Radio Device: BTS</p> <p>Ref Offset 0.5 dB                  Ref 20.00 dBm                  Mkr1 2.4021625 GHz                  -3.9188 dBm</p> <p>Center 2.402 GHz                  #Res BW 30 kHz                  #VBW 100 kHz                  Span 2.5 MHz                  Sweep 2.667 ms</p> <p>Occupied Bandwidth 1.1769 MHz                  Total Power 5.41 dBm</p> <p>Transmit Freq Error 1.730 kHz                  OBW Power 99.00 %                  x dB Bandwidth 1.287 MHz                  x dB -20.00 dB</p>	<p>Frequency</p> <p>Center Freq 2.40200000 GHz</p> <p>CF Step 250.000 kHz                  Auto Man</p> <p>Freq Offset 0 Hz</p>
CH39	<p>Agilent Spectrum Analyzer - Occupied BW                  Center Freq 2.44100000 GHz                  Center Freq: 2.441000000 GHz                  Trig: Free Run                  Avg/Hold: 500/500                  Radio Std: None                  Radio Device: BTS</p> <p>Ref Offset 0.5 dB                  Ref 20.00 dBm                  Mkr1 2.44116 GHz                  -3.8298 dBm</p> <p>Center 2.441 GHz                  #Res BW 30 kHz                  #VBW 100 kHz                  Span 2.5 MHz                  Sweep 2.667 ms</p> <p>Occupied Bandwidth 1.1780 MHz                  Total Power 5.54 dBm</p> <p>Transmit Freq Error 2.657 kHz                  OBW Power 99.00 %                  x dB Bandwidth 1.293 MHz                  x dB -20.00 dB</p>	<p>Frequency</p> <p>Center Freq 2.44100000 GHz</p> <p>CF Step 250.000 kHz                  Auto Man</p> <p>Freq Offset 0 Hz</p>
CH78	<p>Agilent Spectrum Analyzer - Occupied BW                  Center Freq 2.48000000 GHz                  Center Freq: 2.480000000 GHz                  Trig: Free Run                  Avg/Hold: 500/500                  Radio Std: None                  Radio Device: BTS</p> <p>Ref Offset 0.5 dB                  Ref 20.00 dBm                  Mkr1 2.480165 GHz                  -4.3535 dBm</p> <p>Center 2.48 GHz                  #Res BW 30 kHz                  #VBW 100 kHz                  Span 2.5 MHz                  Sweep 2.667 ms</p> <p>Occupied Bandwidth 1.1793 MHz                  Total Power 4.68 dBm</p> <p>Transmit Freq Error 3.070 kHz                  OBW Power 99.00 %                  x dB Bandwidth 1.289 MHz                  x dB -20.00 dB</p>	<p>Frequency</p> <p>Center Freq 2.48000000 GHz</p> <p>CF Step 250.000 kHz                  Auto Man</p> <p>Freq Offset 0 Hz</p>

### 5.5. Carrier Frequencies Separation

**LIMIT**

FCC CFR Title 47 Part 15 Subpart C Section 15.247 (a)(1):Frequency hopping systems shall have hopping channel carrier frequencies separated by minimum of 25 kHz or the 2/3\*20 dB bandwidth of the hopping channel, whichever is greater.

**TEST CONFIGURATION**

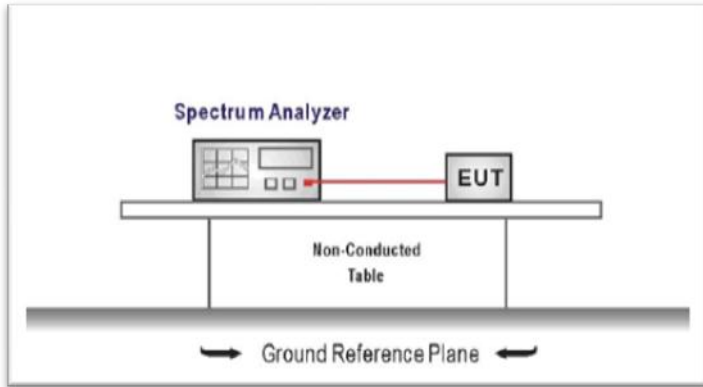

**TEST PROCEDURE**

1. The transmitter output was connected to the spectrum analyzer through an attenuator, the path loss was compensated to the results for each measurement.
2. Set to the maximum power setting and enable the EUT transmit continuously
3. Use the following spectrum analyzer settings:  
 Span = wide enough to capture the peaks of two adjacent channels  
 RBW ≥ 1% of the span, VBW ≥ RBW  
 Sweep = auto, Detector function = peak, Trace = max hold
4. Measure and record the results in the test report.

**TEST MODE:**

Please refer to the clause 3.3



**TEST RESULTS**

Passed       Not Applicable

Modulation type	Channel	Carrier Frequencies Separation (MHz)	Limit (MHz) *	Result
GFSK	39	1.00	≥0.976	Pass
π/4DQPSK	39	1.00	≥0.873	Pass
8DPSK	39	1.01	≥0.862	Pass

Note:

- \*: GFSK limit = The maximum 20 dB Bandwidth for GFSK modulation on the section 5.4.
- π/4DQPSK limit = 2/3 \* The maximum 20 dB Bandwidth for π/4DQPSK modulation on the section 5.4.
- 8DPSK limit = 2/3 \* The maximum 20 dB Bandwidth for 8DPSK modulation on the section 5.4

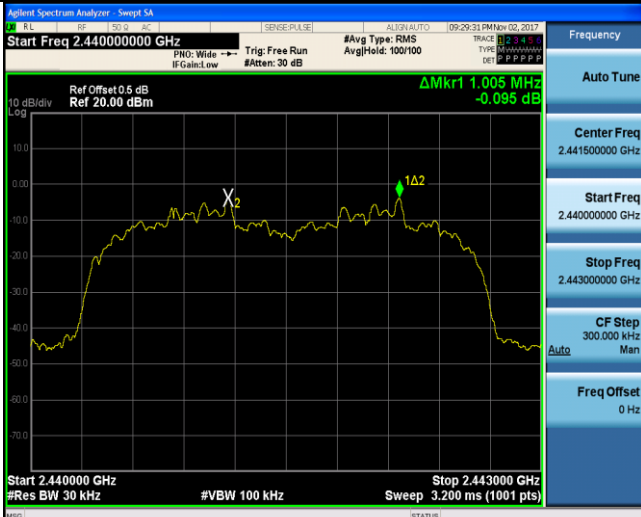
<p>GFSK</p>		
<p><math>\pi/4</math>DQPSK</p>		
<p>8DPSK</p>		<p>Frequency</p> <ul style="list-style-type: none"><li>Auto Tune</li><li>Center Freq: 2.441500000 GHz</li><li>Start Freq: 2.440000000 GHz</li><li>Stop Freq: 2.443000000 GHz</li><li>CF Step: 300.000 kHz (Auto)</li><li>Freq Offset: 0 Hz</li></ul>

## 5.6. Hopping Channel Number

### LIMIT

FCC CFR Title 47 Part 15 Subpart C Section 15.247 (a)(1):Frequency hopping systems in the 2400–2483.5 MHz band shall use at least **15** channels.

### TEST CONFIGURATION

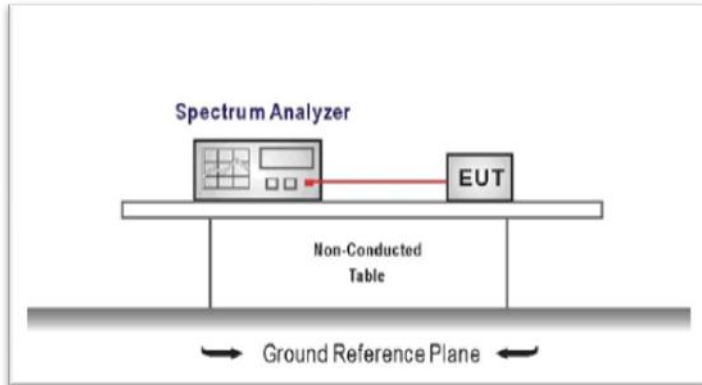

### TEST PROCEDURE

1. The transmitter output was connected to the spectrum analyzer through an attenuator, the path loss was compensated to the results for each measurement.
2. Set to the maximum power setting and enable the EUT transmit continuously
3. Use the following spectrum analyzer settings:  
 Span = the frequency band of operation  
 RBW  $\geq$  1% of the span, VBW  $\geq$  RBW  
 Sweep = auto, Detector function = peak, Trace = max hold
4. Measure and record the results in the test report.

### TEST MODE:

Please refer to the clause 3.3

### TEST RESULTS

Passed       Not Applicable

Modulation type	Channel number	Limit	Result
GFSK	79	$\geq 15.00$	Pass
$\pi/4$ DQPSK	79		
8DPSK	79		



<p>GFSK</p>		
<p><math>\pi/4</math>DQPSK</p>		
<p>8DPSK</p>		

### 5.7. Dwell Time

#### LIMIT

FCC CFR Title 47 Part 15 Subpart C Section 15.247 (a)(1):The average time of occupancy on any channel shall not be greater than 0.4 seconds within a pe-riod of 0.4 seconds multiplied by the number of hopping channels employed.

#### TEST CONFIGURATION

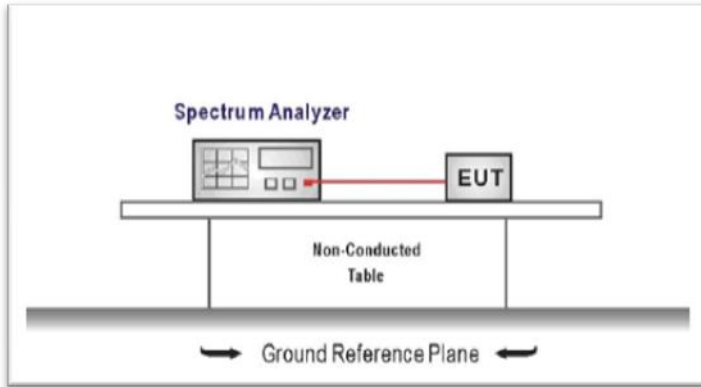

#### TEST PROCEDURE

1. The transmitter output was connected to the spectrum analyzer through an attenuator, the path loss was compensated to the results for each measurement.
2. Set to the maximum power setting and enable the EUT transmit continuously
3. Use the following spectrum analyzer settings:  
Span = zero span, centered on a hopping channel, RBW= 1 MHz, VBW ≥ RBW  
Sweep = as necessary to capture the entire dwell time per hopping channel,  
Detector function = peak, Trace = max hold
4. Measure and record the results in the test report.

#### TEST MODE:

Please refer to the clause 3.3

#### TEST RESULTS

Passed       Not Applicable

Modulation type	Channel	Burst Width [ms/hop/ch]	Total Hops[hop*ch]	Dwell time (Second)	Limit (Second)	Result
GFSK	DH1	0.37	311.00	0.11	≤ 0.40	Pass
	DH3	1.63	159.00	0.26		
	DH5	2.87	116.00	0.33		
π/4DQPSK	2DH1	0.38	315.00	0.12	≤ 0.40	Pass
	2DH3	1.63	157.00	0.26		
	2DH5	2.88	106.00	0.31		
8DPSK	3DH1	0.38	314.00	0.12	≤ 0.40	Pass
	3DH3	1.63	151.00	0.25		
	3DH5	2.88	111.00	0.32		

Note:

1. We have tested all mode at high,middle and low channel,and recoreded worst case at middle channel.
2. Dwell time=Pulse time (ms) × (1600 ÷ 2 ÷ 79) ×31.6 Second for DH1, 2DH1, 3DH1  
Dwell time=Pulse time (ms) × (1600 ÷ 4 ÷ 79) ×31.6 Second for DH3, 2DH3, 3DH3  
Dwell time=Pulse time (ms) × (1600 ÷ 6 ÷ 79) ×31.6 Second for DH5, 2DH5, 3DH5

Modulation Type:		GFSK	
DH1		<p>Agilent Spectrum Analyzer - Swept SA</p> <p>Center Freq 2.441000000 GHz</p> <p>Trig Delay 2.000 ms #Avg Type: RMS</p> <p>Ref 20.00 dBm</p> <p>ΔMkr1 367.3 μs 0.47 dB</p> <p>Center 2.441000000 GHz Span 0 Hz</p> <p>Res BW 1.0 MHz #VBW 3.0 MHz Sweep 10.13 ms (8001 pts)</p>	<p>Frequency</p> <p>Auto Tune</p> <p>Center Freq 2.441000000 GHz</p> <p>Start Freq 2.441000000 GHz</p> <p>Stop Freq 2.441000000 GHz</p> <p>CF Step 1.000000 MHz</p> <p>Freq Offset 0 Hz</p>
		<p>Agilent Spectrum Analyzer - Swept SA</p> <p>Center Freq 2.441000000 GHz</p> <p>Trig Delay 0.000 s #Avg Type: RMS</p> <p>Ref 20.00 dBm</p> <p>ΔMkr1 1.625 ms 9.62 dB</p> <p>Center 2.441000000 GHz Span 0 Hz</p> <p>Res BW 510 kHz #VBW 3.0 MHz Sweep 31.60 s (30001 pts)</p>	<p>Frequency</p> <p>Auto Tune</p> <p>Center Freq 2.441000000 GHz</p> <p>Start Freq 2.441000000 GHz</p> <p>Stop Freq 2.441000000 GHz</p> <p>CF Step 510.000 kHz</p> <p>Freq Offset 0 Hz</p>
DH3		<p>Agilent Spectrum Analyzer - Swept SA</p> <p>Center Freq 2.441000000 GHz</p> <p>Trig Delay 2.000 ms #Avg Type: RMS</p> <p>Ref 20.00 dBm</p> <p>ΔMkr1 1.625 ms 9.62 dB</p> <p>Center 2.441000000 GHz Span 0 Hz</p> <p>Res BW 1.0 MHz #VBW 3.0 MHz Sweep 10.13 ms (8001 pts)</p>	<p>Frequency</p> <p>Auto Tune</p> <p>Center Freq 2.441000000 GHz</p> <p>Start Freq 2.441000000 GHz</p> <p>Stop Freq 2.441000000 GHz</p> <p>CF Step 1.000000 MHz</p> <p>Freq Offset 0 Hz</p>

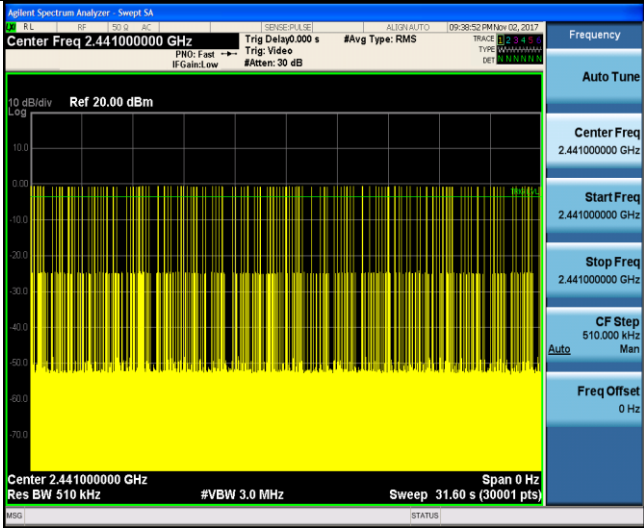
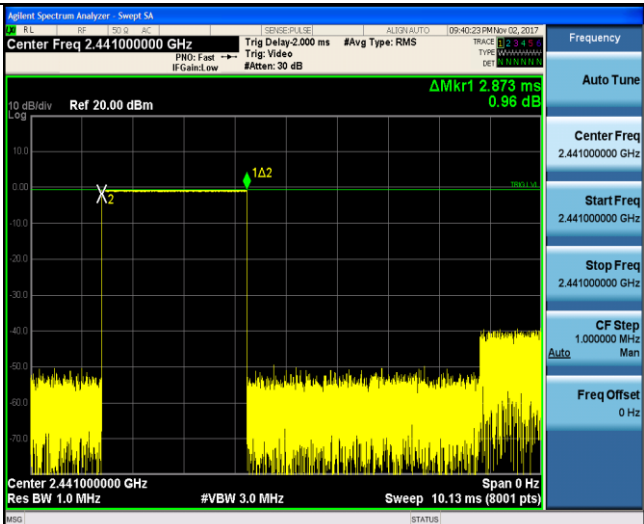
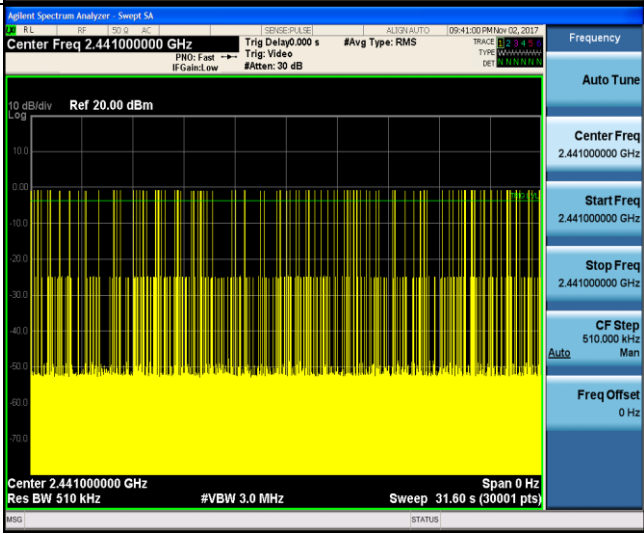
	 <p>Agilent Spectrum Analyzer - Swept SA</p> <p>Center Freq 2.441000000 GHz</p> <p>Ref 20.00 dBm</p> <p>Center 2.441000000 GHz</p> <p>Res BW 510 kHz</p> <p>#VBW 3.0 MHz</p> <p>Sweep 31.60 s (30001 pts)</p> <p>Span 0 Hz</p> <p>Frequency</p> <p>Auto Tune</p> <p>Center Freq 2.441000000 GHz</p> <p>Start Freq 2.441000000 GHz</p> <p>Stop Freq 2.441000000 GHz</p> <p>CF Step 510.000 kHz</p> <p>Freq Offset 0 Hz</p>
	 <p>Agilent Spectrum Analyzer - Swept SA</p> <p>Center Freq 2.441000000 GHz</p> <p>Ref 20.00 dBm</p> <p><math>\Delta</math>Mkr1 2.873 ms</p> <p>0.96 dB</p> <p>Center 2.441000000 GHz</p> <p>Res BW 1.0 MHz</p> <p>#VBW 3.0 MHz</p> <p>Sweep 10.13 ms (8001 pts)</p> <p>Span 0 Hz</p> <p>Frequency</p> <p>Auto Tune</p> <p>Center Freq 2.441000000 GHz</p> <p>Start Freq 2.441000000 GHz</p> <p>Stop Freq 2.441000000 GHz</p> <p>CF Step 1.000000 MHz</p> <p>Freq Offset 0 Hz</p>
DH5	 <p>Agilent Spectrum Analyzer - Swept SA</p> <p>Center Freq 2.441000000 GHz</p> <p>Ref 20.00 dBm</p> <p>Center 2.441000000 GHz</p> <p>Res BW 510 kHz</p> <p>#VBW 3.0 MHz</p> <p>Sweep 31.60 s (30001 pts)</p> <p>Span 0 Hz</p> <p>Frequency</p> <p>Auto Tune</p> <p>Center Freq 2.441000000 GHz</p> <p>Start Freq 2.441000000 GHz</p> <p>Stop Freq 2.441000000 GHz</p> <p>CF Step 510.000 kHz</p> <p>Freq Offset 0 Hz</p>

Modulation Type:		$\pi/4$ DQPSK
2DH1		<p>Agilent Spectrum Analyzer - Swept SA</p> <p>Center Freq 2.441000000 GHz</p> <p>Trig Delay 2.000 ms #Avg Type: RMS</p> <p>Ref 20.00 dBm</p> <p><math>\Delta</math>Mkr1 376.2 <math>\mu</math>s 22.82 dB</p> <p>Center 2.441000000 GHz</p> <p>Res BW 1.0 MHz #VBW 3.0 MHz</p> <p>Sweep 10.13 ms (8001 pts)</p>
2DH2		<p>Agilent Spectrum Analyzer - Swept SA</p> <p>Center Freq 2.441000000 GHz</p> <p>Trig Delay 0.000 s #Avg Type: RMS</p> <p>Ref 20.00 dBm</p> <p><math>\Delta</math>Mkr1 376.2 <math>\mu</math>s 22.82 dB</p> <p>Center 2.441000000 GHz</p> <p>Res BW 510 kHz #VBW 3.0 MHz</p> <p>Sweep 31.60 s (30001 pts)</p>
2DH3		<p>Agilent Spectrum Analyzer - Swept SA</p> <p>Center Freq 2.441000000 GHz</p> <p>Trig Delay 2.000 ms #Avg Type: RMS</p> <p>Ref 20.00 dBm</p> <p><math>\Delta</math>Mkr1 1.629 ms 2.72 dB</p> <p>Center 2.441000000 GHz</p> <p>Res BW 1.0 MHz #VBW 3.0 MHz</p> <p>Sweep 10.13 ms (8001 pts)</p>

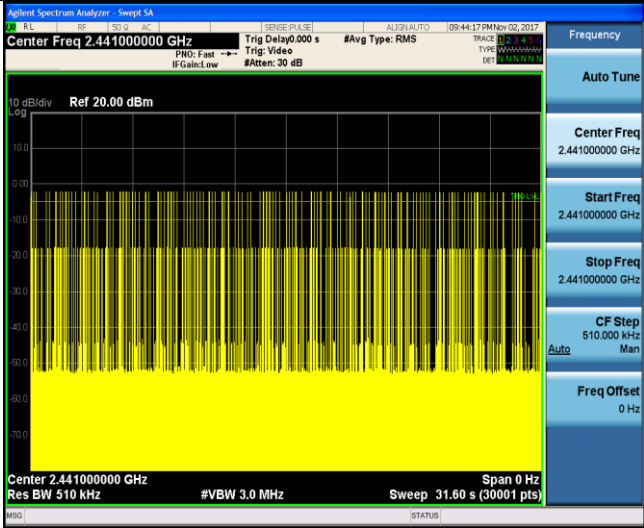
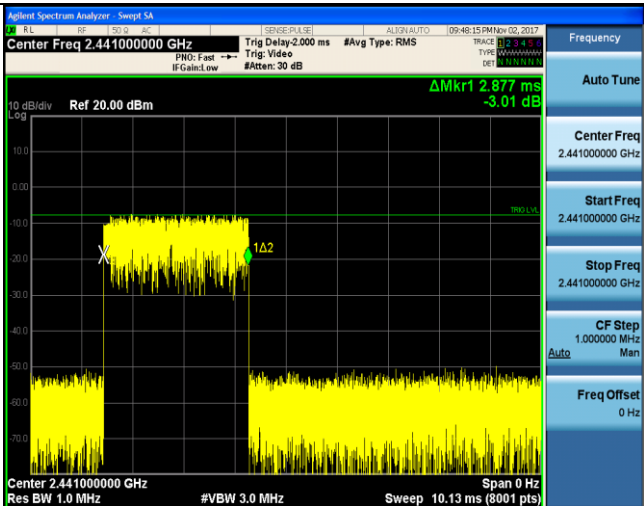
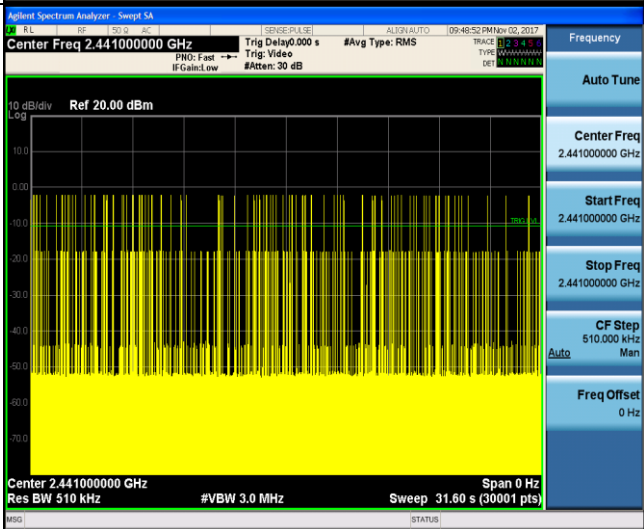
	 <p>Agilent Spectrum Analyzer - Swept SA</p> <p>Center Freq 2.441000000 GHz</p> <p>Trig Delay 0.000 s</p> <p>#Avg Type: RMS</p> <p>Ref 20.00 dBm</p> <p>10 dB/div</p> <p>Log</p> <p>Center 2.441000000 GHz</p> <p>Res BW 510 kHz</p> <p>#VBW 3.0 MHz</p> <p>Sweep 31.60 s (30001 pts)</p> <p>Span 0 Hz</p> <p>Frequency</p> <p>Auto Tune</p> <p>Center Freq 2.441000000 GHz</p> <p>Start Freq 2.441000000 GHz</p> <p>Stop Freq 2.441000000 GHz</p> <p>CF Step 510.000 kHz</p> <p>Freq Offset 0 Hz</p>
	 <p>Agilent Spectrum Analyzer - Swept SA</p> <p>Center Freq 2.441000000 GHz</p> <p>Trig Delay 2.000 ms</p> <p>#Avg Type: RMS</p> <p>Ref 20.00 dBm</p> <p>10 dB/div</p> <p>Log</p> <p>Center 2.441000000 GHz</p> <p>Res BW 1.0 MHz</p> <p>#VBW 3.0 MHz</p> <p>Sweep 10.13 ms (8001 pts)</p> <p>Span 0 Hz</p> <p>Frequency</p> <p>Auto Tune</p> <p>Center Freq 2.441000000 GHz</p> <p>Start Freq 2.441000000 GHz</p> <p>Stop Freq 2.441000000 GHz</p> <p>CF Step 1.000000 MHz</p> <p>Freq Offset 0 Hz</p> <p><math>\Delta</math>Mkr1 2.877 ms</p> <p>-3.01 dB</p>
2DH5	 <p>Agilent Spectrum Analyzer - Swept SA</p> <p>Center Freq 2.441000000 GHz</p> <p>Trig Delay 0.000 s</p> <p>#Avg Type: RMS</p> <p>Ref 20.00 dBm</p> <p>10 dB/div</p> <p>Log</p> <p>Center 2.441000000 GHz</p> <p>Res BW 510 kHz</p> <p>#VBW 3.0 MHz</p> <p>Sweep 31.60 s (30001 pts)</p> <p>Span 0 Hz</p> <p>Frequency</p> <p>Auto Tune</p> <p>Center Freq 2.441000000 GHz</p> <p>Start Freq 2.441000000 GHz</p> <p>Stop Freq 2.441000000 GHz</p> <p>CF Step 510.000 kHz</p> <p>Freq Offset 0 Hz</p>

Modulation Type:		8DPSK
3DH1		
3DH3		

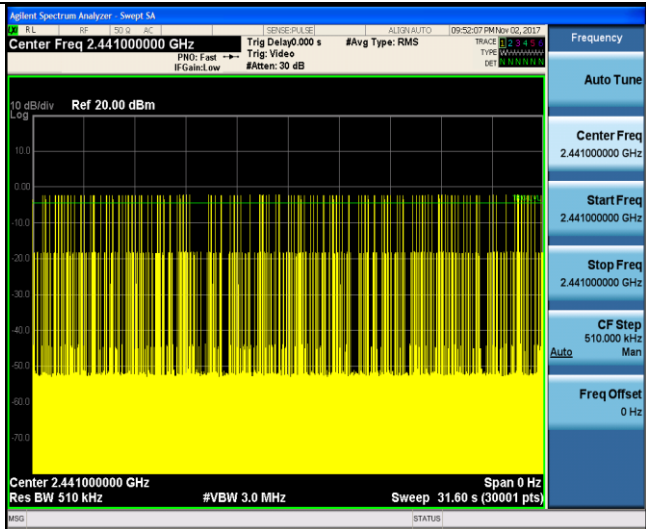
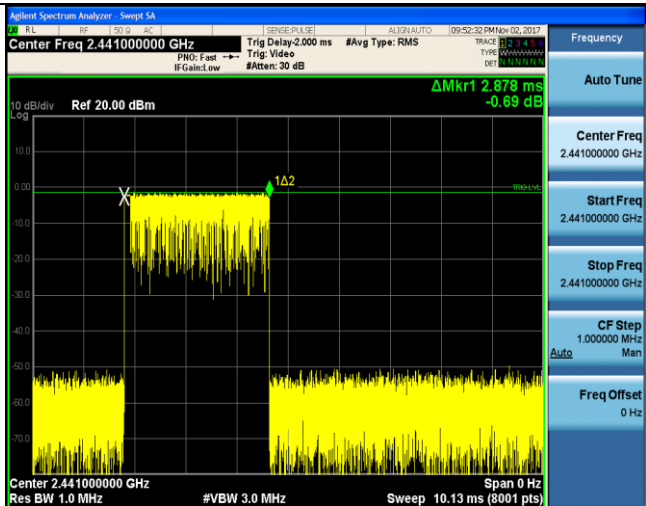
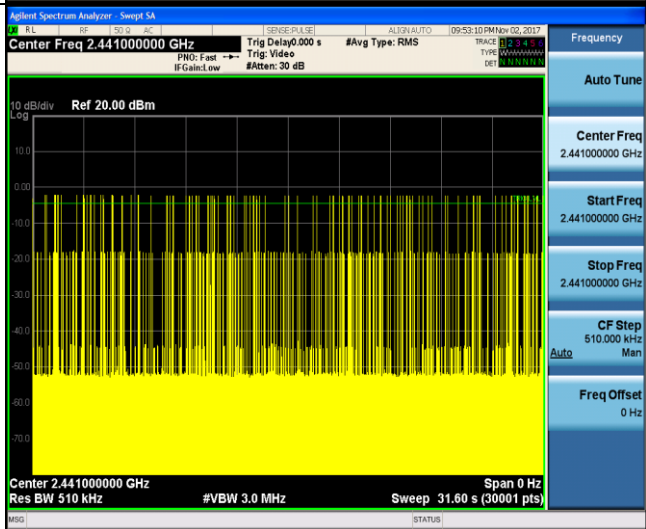
	
3DH5	
	



### 5.8. Pseudorandom Frequency Hopping Sequence

#### LIMIT

FCC CFR Title 47 Part 15 Subpart C Section 15.247 (a)(1):Frequency hopping systems shall have hopping channel carrier frequencies separated by a minimum of 25 kHz or the 20 dB bandwidth of the hopping channel, whichever is greater. Alternatively, frequency hopping systems operating in the 2400–2483.5 MHz band may have hopping channel carrier frequencies that are separated by 25 kHz or two-thirds of the 20 dB bandwidth of the hopping channel, whichever is greater, provided the systems operate with an output power no greater than 125 mW. The system shall hop to channel frequencies that are selected at the system hopping rate from a pseudo randomly ordered list of hopping frequencies. Each frequency must be used equally on the average by each transmitter. The system receivers shall have input bandwidths that match the hopping channel bandwidths of their corresponding transmitters and shall shift frequencies in synchronization with the transmitted signals.

#### TEST RESULTS

The pseudorandom frequency hopping sequence may be generated in a nine-stage shift register whose 5<sup>th</sup> and 9<sup>th</sup> stage outputs are added in a modulo-two addition stage. And the result is fed back to the input of the first stage. The sequence begins with the first one of 9 consecutive ones, for example: the shift register is initialized with nine ones.

- Number of shift register stages: 9
- Length of pseudo-random sequence:  $2^9 - 1 = 511$  bits
- Longest sequence of zeros: 8 (non-inverted signal)

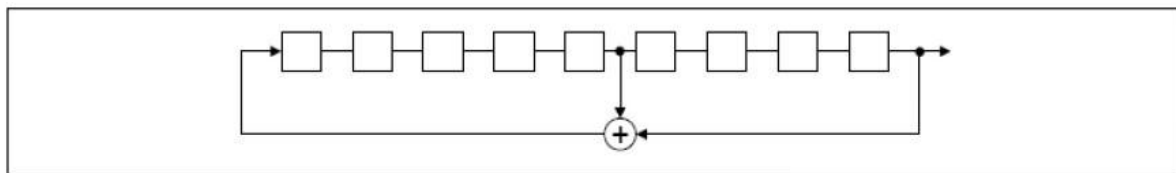

*Linear Feedback Shift Register for Generation of the PRBS sequence*

An example of pseudorandom frequency hopping sequence as follows:

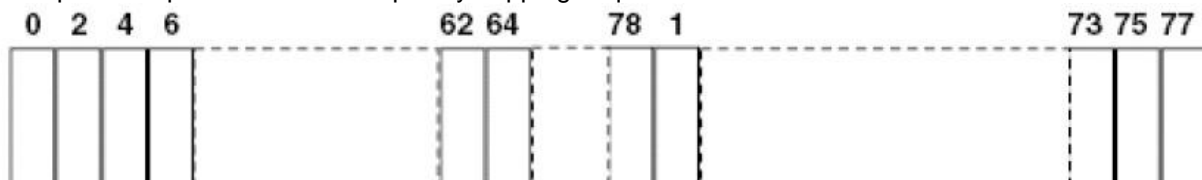

Each frequency used equally one the average by each transmitter. The system receiver have input bandwidths that match the hopping channel bandwidths of their corresponding transmitter and shift frequencies in synchronization with the transmitted signals.

**5.9. Restricted band (radiated)**

**LIMIT**

**FCC CFR Title 47 Part 15 Subpart C Section 15.247 (d):**

In any 100 kHz bandwidth outside the frequency band in which the spread spectrum or digitally modulated intentional radiator is operating, Radiated Emissions which fall in the restricted bands, as defined in §15.205(a), must also comply with the Radiated Emissions limits specified in §15.209(a) (see §15.205(c)).

**TEST CONFIGURATION**

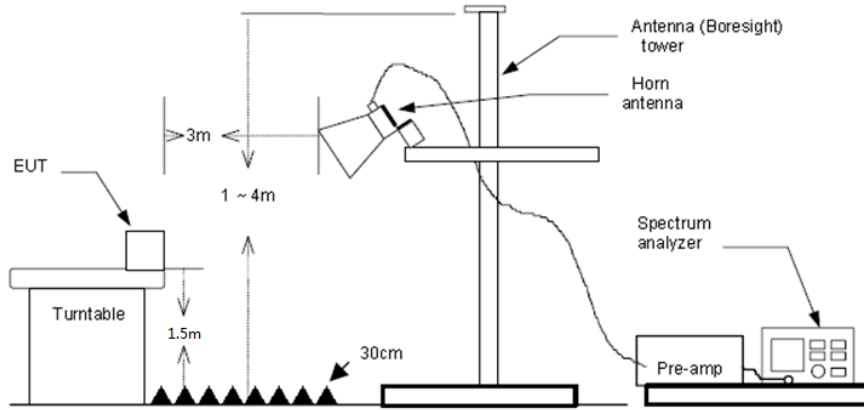

**TEST PROCEDURE**

1. The EUT was setup and tested according to ANSI C63.10:2013 for compliance to FCC 47CFR 15.247 requirements.
2. The EUT is placed on a turn table which is 1.5 meter above ground. The turn table is rotated 360 degrees to determine the position of the maximum emission level.
3. The EUT was positioned such that the distance from antenna to the EUT was 3 meters.
4. The antenna is scanned from 1 meter to 4 meters to find out the maximum emission level. This is repeated for both horizontal and vertical polarization of the antenna. In order to find the maximum emission, all of the interface cables were manipulated according to ANSI C63.10:2013 on radiated measurement.
5. The receiver set as follow:  
 RBW=1 MHz, VBW=3 MHz Peak detector for Peak value  
 RBW=1 MHz, VBW=10 Hz Peak detector for Average value.

**TEST MODE:**

Please refer to the clause 3.3

**TEST RESULTS**

**Passed**       **Not Applicable**

**Note:**

- 1) Final level= Read level + Antenna Factor+ Cable Loss- Preamp Factor
- 2) Have pre-scan all modulation mode, found the GFSK modulation which it was worst case, so only the worst case's data on the test report.
- 3) The peak level is lower than average limit(54 dBuV/m), this data is the too weak instrument of signal is unable to test.

CH00									
Frequency (MHz)	Read Level (dBuV)	Antenna Factor (dB/m)	Cable Loss (dB)	Preamp Factor (dB)	Level (dBuV/m)	Limit Line (dBuV/m)	Over Limit (dB)	Polarization	Test value
2310.00	32.97	28.05	6.62	37.65	29.99	74.00	-44.01	Horizontal	Peak
2390.03	33.40	27.65	6.75	37.87	29.93	74.00	-44.07	Horizontal	Peak
2310.00	33.61	28.05	6.62	37.65	30.63	74.00	-43.37	Vertical	Peak
2390.03	33.45	27.65	6.75	37.87	29.98	74.00	-44.02	Vertical	Peak
2310.00	21.96	28.05	6.62	37.65	18.98	54.00	-35.02	Horizontal	Average
2390.03	21.61	27.65	6.75	37.87	18.14	54.00	-35.86	Horizontal	Average
2310.00	21.41	28.05	6.62	37.65	18.43	54.00	-35.57	Vertical	Average
2390.03	20.91	27.65	6.75	37.87	17.44	54.00	-36.56	Vertical	Average

CH78									
Frequency (MHz)	Read Level (dBuV)	Antenna Factor (dB/m)	Cable Loss (dB)	Preamp Factor (dB)	Level (dBuV/m)	Limit Line (dBuV/m)	Over Limit (dB)	Polarization	Test value
2483.50	53.97	27.26	6.83	37.87	50.19	74.00	-23.81	Horizontal	Peak
2500.00	34.12	27.20	6.84	37.87	30.29	74.00	-43.71	Horizontal	Peak
2483.50	45.29	27.26	6.83	37.87	41.51	74.00	-32.49	Vertical	Peak
2500.00	34.75	27.20	6.84	37.87	30.92	74.00	-43.08	Vertical	Peak
2483.50	40.50	27.26	6.83	37.87	36.72	54.00	-17.28	Horizontal	Average
2500.00	21.25	27.20	6.84	37.87	17.42	54.00	-36.58	Horizontal	Average
2483.50	33.99	27.26	6.83	37.87	30.21	54.00	-23.79	Vertical	Average
2500.00	21.38	27.20	6.84	37.87	17.55	54.00	-36.45	Vertical	Average

## 5.10. Band edge and Spurious Emissions (conducted)

### LIMIT

FCC CFR Title 47 Part 15 Subpart C Section 15.247 (d): In any 100 kHz bandwidth outside the frequency band in which the spread spectrum intentional radiator is operating, the radio frequency power that is produced by the intentional radiator shall be at least 20 dB below that in the 100 kHz bandwidth within the band that contains the highest level of the desired power, based on either an RF conducted or a radiated measurement.

### TEST CONFIGURATION

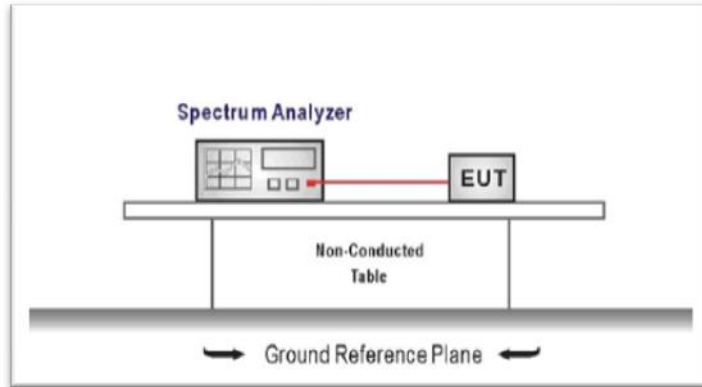

### TEST PROCEDURE

1. The transmitter output was connected to the spectrum analyzer through an attenuator, the path loss was compensated to the results for each measurement.
2. Set to the maximum power setting and enable the EUT transmit continuously
3. Use the following spectrum analyzer settings:  
RBW = 100 kHz, VBW  $\geq$  RBW  
Sweep = auto, Detector function = peak, Trace = max hold
4. Measure and record the results in the test report.

### TEST MODE:

Please refer to the clause 3.3

### TEST RESULTS

Passed       Not Applicable

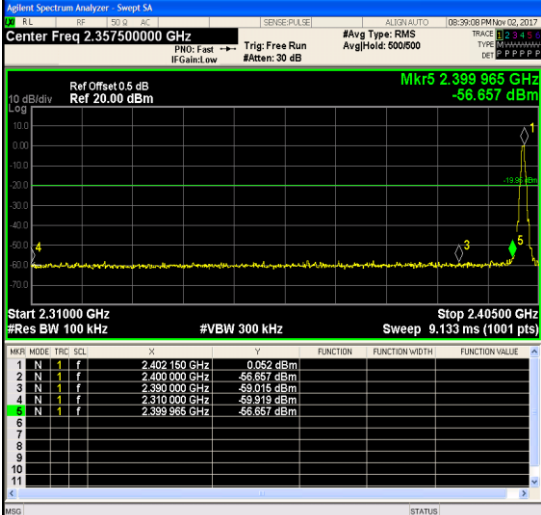
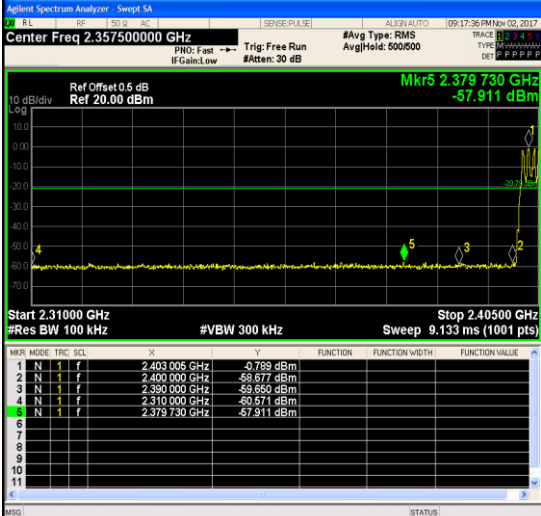
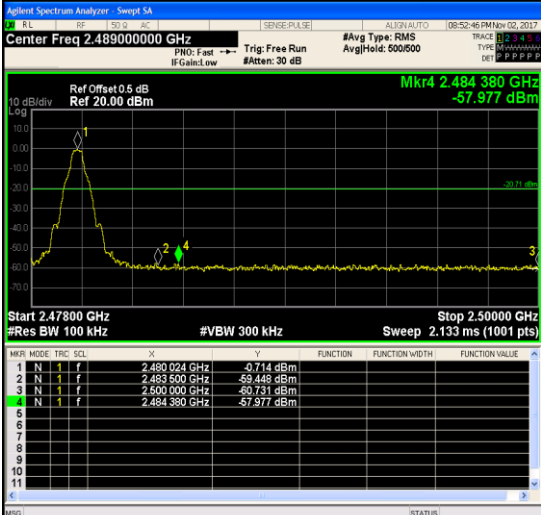
Test Item:	Band edge	Modulation type:	GFSK
<p>CH00 No hopping mode</p>			<p>Frequency</p> <p>Auto Tune</p> <p>Center Freq 2.357500000 GHz</p> <p>Start Freq 2.310000000 GHz</p> <p>Stop Freq 2.405000000 GHz</p> <p>CF Step 9.500000 MHz</p> <p>Freq Offset 0 Hz</p>
<p>CH00 Hopping mode</p>			<p>Frequency</p> <p>Auto Tune</p> <p>Center Freq 2.357500000 GHz</p> <p>Start Freq 2.310000000 GHz</p> <p>Stop Freq 2.405000000 GHz</p> <p>CF Step 9.500000 MHz</p> <p>Freq Offset 0 Hz</p>
<p>CH78 No hopping mode</p>			<p>Frequency</p> <p>Auto Tune</p> <p>Center Freq 2.489000000 GHz</p> <p>Start Freq 2.478000000 GHz</p> <p>Stop Freq 2.500000000 GHz</p> <p>CF Step 2.200000 MHz</p> <p>Freq Offset 0 Hz</p>