

FCC RF Test Report

(2.4G Wi-Fi)

Report No.: JYTSZ-R12-2400864
Applicant: Aratek Biometrics Co., Ltd.
Address of Applicant: 1F, T2-B building, Shenzhen Hi-tech Industrial Park, 518057, Shenzhen, China

Equipment Under Test (EUT)

Product Name: Marshall 8 Plus
Model No.: Marshall 8 Plus
Trade Mark: ARATEK
FCC ID: 2AGUJM8PLUS
Applicable Standards: FCC CFR Title 47 Part 15C (§15.247)
Date of Sample Receipt: 09 May, 2024
Date of Test: 10 May, to 19 Aug., 2024
Date of Report Issued: 20 Aug., 2024
Test Result: PASS

Project by: _____

Date: _____

20 Aug., 2024

Reviewed by: _____

Date: _____

20 Aug., 2024

Approved by: _____

Date: _____

20 Aug., 2024

Manager

This equipment has been shown to be capable of compliance with the applicable technical standards as indicated in the measurement report and was tested in accordance with the measurement procedures specified in above the application standard version. Test results reported herein relate only to the item(s) tested.

This document cannot be reproduced except in full, without prior written approval of the Company. Any unauthorized alteration, forgery or falsification of the content or appearance of this document is unlawful and offenders may be prosecuted to the fullest extent of the law. Unless otherwise stated the results shown in this test report refer only to the sample(s) tested and such sample(s) are retained for 90 days only.

1 Version

Version No.	Date	Description
00	20 Aug., 2024	Original

2 Contents

Page

Cover Page	1
1 Version	2
2 Contents	3
3 General Information	4
3.1 Client Information	4
3.2 General Description of E.U.T.	4
3.3 Test Mode and Environment	5
3.4 Description of Test Auxiliary Equipment	5
3.5 Measurement Uncertainty	5
3.6 Additions to, Deviations, or Exclusions from the Method	5
3.7 Laboratory Facility	6
3.8 Laboratory Location	6
3.9 Test Instruments List	7
4 Measurement Setup and Procedure	9
4.1 Test Channel	9
4.2 Test Setup	9
4.3 Test Procedure	11
5 Test Results	12
5.1 Summary	12
5.1.1 Clause and Data Summary	12
5.1.2 Test Limit	13
5.2 Antenna Requirement	14
5.3 AC Power Line Conducted Emission	15
5.4 Emissions in Restricted Frequency Bands	17
5.5 Emissions in Non-restricted Frequency Bands	33

3 General Information

3.1 Client Information

Applicant:	Aratek Biometrics Co., Ltd.
Address:	1F, T2-B building, Shenzhen Hi-tech Industrial Park, 518057, Shenzhen, China
Manufacturer:	Aratek Biometrics Co., Ltd.
Address:	1F, T2-B building, Shenzhen Hi-tech Industrial Park, 518057, Shenzhen, China

3.2 General Description of E.U.T.

Product Name:	Marshall 8 Plus
Model No.:	Marshall 8 Plus
Operation Frequency:	2412 MHz - 2462 MHz (802.11b, g, n-HT20) 2422 MHz - 2452 MHz (802.11n-HT40)
Channel Numbers:	11 (802.11b, g, n-HT20) 7 (802.11n-HT40)
Channel Separation:	5MHz
Modulation Technology: (IEEE 802.11b)	DSSS-DBPSK, DQPSK, CCK
Modulation Technology: (IEEE 802.11g/802.11n)	OFDM-BPSK, QPSK, 16QAM, 64QAM
Antenna Type:	Internal Antenna
Antenna Gain:	5.57 dBi (declare by applicant)
Antenna Transmit Mode:	SISO (1TX, 1RX)
Power Supply:	Rechargeable Li-ion Polymer Battery DC3.7V, 10000mAh
AC Adapter:	Model: ES015C-U120150XYE Input: AC100-240V, 50/60Hz, 0.6A Output: DC 5.0V, 3.0A 15.0W or 9.0V, 2.0A 18.0W or 12.0V, 1.5A 18.0W
Test Sample Condition:	The test samples were provided in good working order with no visible defects.

3.3 Test Mode and Environment

Test Mode:	
Transmitting mode:	Keep the EUT in continuous transmitting with modulation
Per-scan all kind of data rate, the follow list were the worst case:	
Mode	Data rate
802.11b	1Mbps
802.11g	6Mbps
802.11n-HT20	6.5Mbps
802.11n-HT40	13.5Mbps
Remark:	
<ol style="list-style-type: none"> For AC power line conducted emission and radiated spurious emission (below 1GHz), pre-scan 802.11b, g, n modulation mode, found 802.11b modulation mode was worse case mode. The report only reflects the test data of worst mode. Channel Low, Mid and High for each type band with rated data rate were chosen for full testing. The field strength of spurious radiation emission was measured as EUT stand-up position (H mode) and lie down position (E1, E2 mode) for these modes. Just the worst case position (H mode) shown in report. 	
Operating Environment:	
Temperature:	Normal: 15°C ~ 35°C
Humidity:	20 % ~ 75 % RH
Atmospheric Pressure:	1008 mbar
Voltage:	Nominal: 3.70 Vdc, Extreme: Low 3.50 Vdc, High 4.25 Vdc
Test Engineer:	Logan Li (Conducted measurement) Robin Gu (Radiated measurement)

3.4 Description of Test Auxiliary Equipment

The EUT has been tested as an independent unit.

3.5 Measurement Uncertainty

Parameter	Expanded Uncertainty (Confidence of 95%(U = 2Uc(y)))
Conducted Emission for LISN (9kHz ~ 150kHz)	3.57 dB
Conducted Emission for LISN (150kHz ~ 30MHz)	3.14 dB
Radiated Emission (30MHz ~ 200MHz) (10m SAC)	4.3 dB
Radiated Emission (200MHz ~ 1000MHz) (10m SAC)	4.3 dB
Radiated Emission (1GHz ~ 6GHz) (3m FAR)	4.95 dB
Radiated Emission (6GHz ~ 18GHz) (3m FAR)	5.23 dB
Radiated Emission (18GHz ~ 40GHz) (3m FAR)	5.32 dB

Note: All the measurement uncertainty value were shown with a coverage k=2 to indicate 95% level of confidence. The measurement data show herein meets or exceeds the CISPR measurement uncertainty values specified in CISPR 16-4-2 and can be compared directly to specified limit to determine compliance.

3.6 Additions to, Deviations, or Exclusions from the Method

No

3.7 Laboratory Facility

The test facility is recognized, certified, or accredited by the following organizations:

- **FCC - Designation No.: CN1211**

JianYan Testing Group Shenzhen Co., Ltd. has been accredited as a testing laboratory by FCC(Federal Communications Commission). The test firm Registration No. is 727551.

- **ISED – CAB identifier.: CN0021**

The 3m Semi-anechoic chamber and 10m Semi-anechoic chamber of JianYan Testing Group Shenzhen Co., Ltd. has been Registered by Certification and Engineering Bureau of Industry Canada for radio equipment testing with Registration No.: 10106A-1.

- **CNAS - Registration No.: CNAS L15527**

JianYan Testing Group Shenzhen Co., Ltd. is accredited to ISO/IEC 17025:2017 General Requirements for the Competence of Testing and Calibration laboratories for the competence of testing. The Registration No. is CNAS L15527.

- **A2LA - Registration No.: 4346.01**

This laboratory is accredited in accordance with the recognized International Standard ISO/IEC 17025:2017 General requirements for the competence of testing and calibration laboratories. The test scope can be found as below link: <https://portal.a2la.org/scopepdf/4346-01.pdf>

3.8 Laboratory Location

JianYan Testing Group Shenzhen Co., Ltd.

Address: No.101, Building 8, Innovation Wisdom Port, No.155 Hongtian Road, Huangpu Community, Xinqiao Street, Bao'an District, Shenzhen, Guangdong, People's Republic of China.

Tel: +86-755-23118282, Fax: +86-755-23116366

Email: info-JYTee@lets.com, Website: <http://jyt.lets.com>

3.9 Test Instruments List

Radiated Emission(3m FAR):					
Test Equipment	Manufacturer	Model No.	Manage No.	Cal. Date (mm-dd-yy)	Cal. Due date (mm-dd-yy)
3m FAR	YUNYI	9m*6m*6m	WXJ097	06-15-2023	06-14-2028
BiConiLog Antenna	Schwarzbeck	VULB9163	WXJ097-2	07-13-2023	07-12-2024
				07-01-2024	06-30-2025
Biconical Antenna	Schwarzbeck	VUBA9117	WXJ002-1	07-02-2021	07-01-2024
				07-01-2024	06-30-2027
Horn Antenna	Schwarzbeck	BBHA9120D	WXJ097-3	07-14-2023	07-13-2024
				06-16-2024	06-15-2025
Horn Antenna	Schwarzbeck	BBHA9120D	WXJ002-3	12-28-2023	12-27-2024
Horn Antenna	Schwarzbeck	BBHA9170	WXJ002-5	12-28-2023	12-27-2024
Horn Antenna	Schwarzbeck	BBHA9170	WXJ002-6	12-28-2023	12-27-2024
Pre-amplifier (30MHz ~ 1GHz)	YUNYI	PAM-310N	WXJ097-5	04-24-2024	04-23-2025
Pre-amplifier (1GHz ~ 18GHz)	YUNYI	PAM-118N	WXJ097-6	04-24-2024	04-23-2025
Pre-amplifier (18GHz ~ 40GHz)	RF System	TRLA-180400G45B	WXJ002-7	12-28-2023	12-27-2024
EMI Test Receiver	Rohde & Schwarz	ESCI3	WXJ003	12-27-2023	12-26-2024
Spectrum Analyzer	Rohde & Schwarz	FSP 30	WXJ004	12-27-2023	12-26-2024
Spectrum Analyzer	KEYSIGHT	N9020B	WXJ081-1	06-13-2023	06-12-2024
				06-11-2024	06-10-2025
Coaxial Cable (30MHz ~ 1GHz)	JYTSZ	JYT3M-1G-NN-13M	WXG097-1	08-01-2023	07-31-2024
				07-30-2024	07-29-2025
Coaxial Cable (1GHz ~ 18GHz)	JYTSZ	JYT3M-18G-NN-8M	WXG097-2	08-01-2023	07-31-2024
				07-30-2024	07-29-2025
Coaxial Cable (18GHz ~ 40GHz)	JYTSZ	JYT3M-40G-SS-8M	WXG097-3	08-01-2023	07-31-2024
				07-30-2024	07-29-2025
High Band Reject Filter Group	Tonscend	JS0806-F	WXJ089	N/A	
Low Band Reject Filter Group	Tonscend	JS0806-F	WXJ097-4	N/A	
Test Software	Tonscend	TS+	Version: 5.0.0		

Radiated Emission(10m SAC):					
Test Equipment	Manufacturer	Model No.	Manage No.	Cal. Date (mm-dd-yy)	Cal. Due date (mm-dd-yy)
10m SAC	ETS	RFSD-100-F/A	WXJ090	04-28-2021	04-27-2026
BiConiLog Antenna	SCHWARZBECK	VULB 9168	WXJ090-1	01-05-2024	01-04-2025
BiConiLog Antenna	SCHWARZBECK	VULB 9168	WXJ090-2	12-28-2023	12-27-2024
EMI Test Receiver	R&S	ESR 3	WXJ090-3	12-27-2023	12-26-2024
EMI Test Receiver	R&S	ESR 3	WXJ090-4	12-27-2023	12-26-2024
Low Pre-amplifier	Bost	LNA 0920N	WXJ090-6	12-27-2023	12-26-2024
Low Pre-amplifier	Bost	LNA 0920N	WXJ090-7	12-27-2023	12-26-2024
Cable	Bost	JYT10M-1G-NN-10M	WXG002-7	01-17-2024	01-16-2025
Cable	Bost	JYT10M-1G-NN-10M	WXG002-8	01-17-2024	01-16-2025
Test Software	R&S	EMC32	Version: 10.50.40		

Conducted Emission:					
Test Equipment	Manufacturer	Model No.	Manage No.	Cal. Date (mm-dd-yy)	Cal. Due date (mm-dd-yy)
EMI Test Receiver	Rohde & Schwarz	ESR3	WXJ003-2	07-05-2023	07-04-2024
				06-11-2024	06-10-2025
LISN	Schwarzbeck	NSLK 8127	QCJ001-13	12-27-2023	12-26-2024
LISN	Rohde & Schwarz	ESH3-Z5	WXJ005-1	12-27-2023	12-26-2024
LISN Coaxial Cable (9kHz ~ 30MHz)	JYTSZ	JYTCE-1G-NN-2M	WXG003-1	01-17-2024	01-16-2025
RF Switch	TOP PRECISION	RSU0301	WXG003	N/A	
Test Software	AUDIX	E3	Version: 6.110919b		

Conducted Method:					
Test Equipment	Manufacturer	Model No.	Manage No.	Cal. Date (mm-dd-yy)	Cal. Due date (mm-dd-yy)
Spectrum Analyzer	Keysight	N9010B	WXJ004-3	11-01-2023	10-31-2024
Temperature Humidity Chamber	ZHONG ZHI	CZ-A-80D	WXJ032-3	01-09-2023	01-08-2025
Power Detector Box	MWRFTTEST	MW100-PSB	WXJ007-4	09-25-2023	09-24-2024
DC Power Supply	Keysight	E3642A	WXJ025-2	N/A	
RF Control Unit	MWRFTTEST	MW100-RFCB	WXG006	N/A	
Test Software	MWRFTTEST	MTS 8310	Version: 2.0.0.0		

4 Measurement Setup and Procedure

4.1 Test Channel

According to ANSI C63.10-2013 chapter 5.6.1 Table 4 requirement, select lowest channel, middle channel, and highest channel in the frequency range in which device operates for testing. The detailed frequency points are as follows:

802.11b, 802.11g, 802.11n-HT20					
Lowest channel		Middle channel		Highest channel	
Channel No.	Frequency (MHz)	Channel No.	Frequency (MHz)	Channel No.	Frequency (MHz)
1	2412	6	2437	11	2462

802.11n-HT40					
Lowest channel		Middle channel		Highest channel	
Channel No.	Frequency (MHz)	Channel No.	Frequency (MHz)	Channel No.	Frequency (MHz)
3	2422	6	2437	9	2452

4.2 Test Setup

1) Conducted emission measurement:

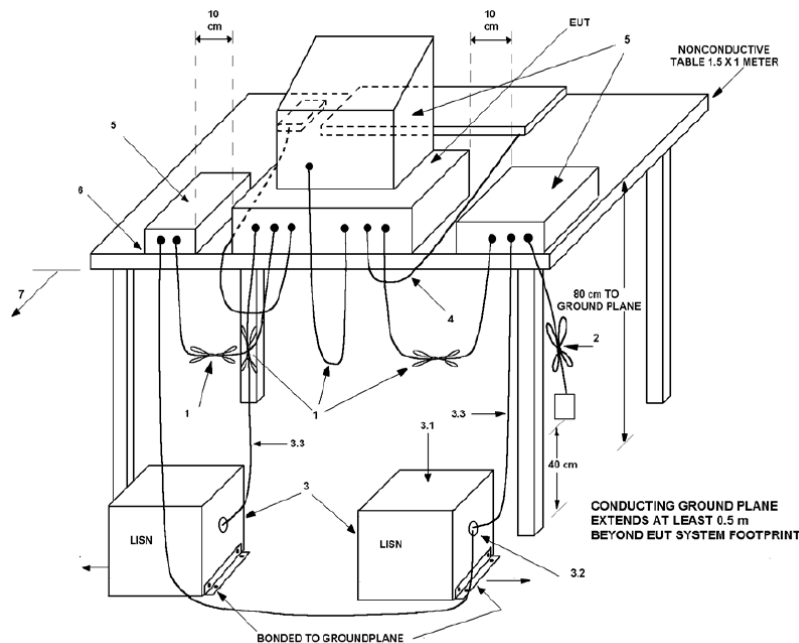

Note: The detailed descriptions please refer to Figure 8 of ANSI C63.4:2014.

2) Radiated emission measurement:

Below 1GHz (10m SAC)

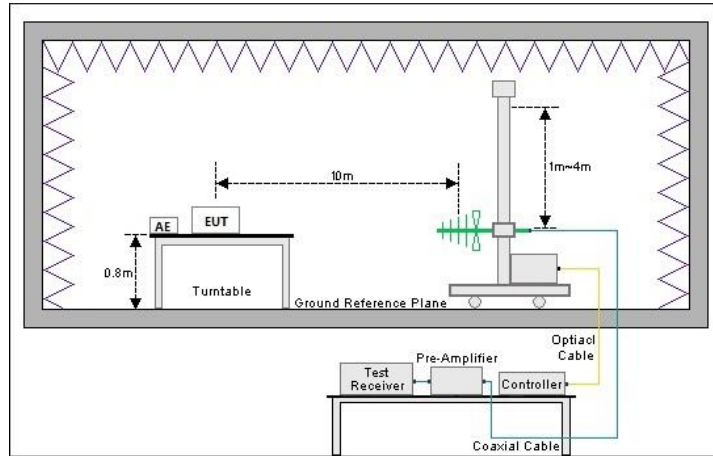

Above 1GHz (3m SAC)

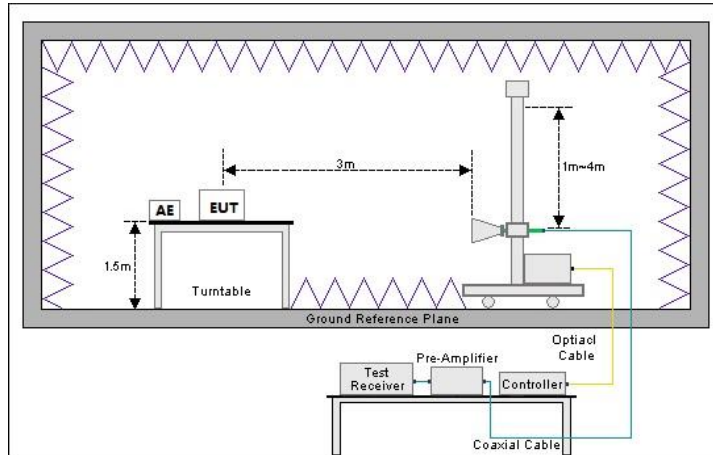

3) Conducted test method

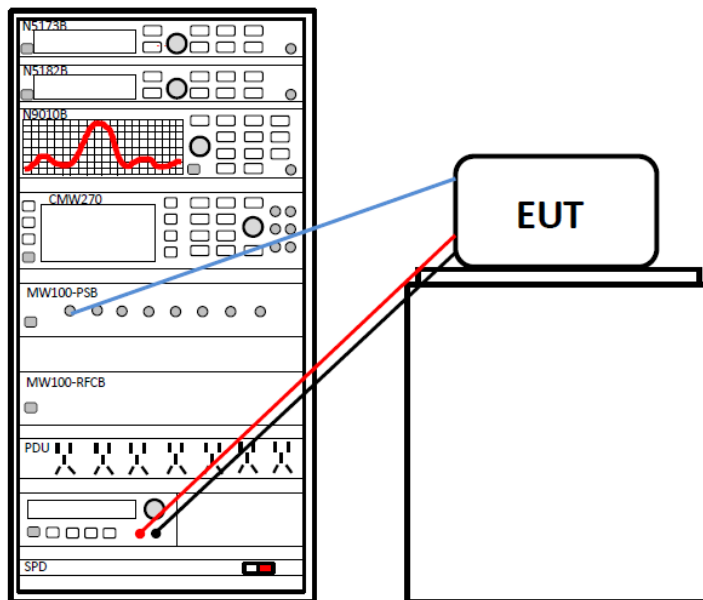

4.3 Test Procedure

Test method	Test step
Conducted emission	<ol style="list-style-type: none"> The E.U.T and simulators are connected to the main power through a line impedance stabilization network (L.I.S.N.). This provides a 50ohm/50uH coupling impedance for the measuring equipment. The peripheral devices are also connected to the main power through a LISN that provides a 50ohm/50uH coupling impedance with 50ohm termination. (Please refer to the block diagram of the test setup and photographs). Both sides of A.C. line are checked for maximum conducted interference. In order to find the maximum emission, the relative positions of equipment and all of the interface cables must be changed according to ANSI C63.10 on conducted measurement.
Radiated emission	<p>For below 1GHz:</p> <ol style="list-style-type: none"> The EUT was placed on the tabletop of a rotating table 0.8 m the ground at a 10 m semi anechoic chamber. The measurement distance from the EUT to the receiving antenna is 10 m. EUT works in each mode of operation that needs to be tested , and having the EUT continuously working, respectively on 3 axis (X, Y & Z) and considered typical configuration to obtain worst position. The highest signal levels relative to the limit shall be determined by rotating the EUT from 0° to 360° and with varying the measurement antenna height between 1 m and 4 m in vertical and horizontal polarizations. Open the test software to control the test antenna and test turntable. Perform the test, save the test results, and export the test data. <p>For above 1GHz:</p> <ol style="list-style-type: none"> The EUT was placed on the tabletop of a rotating table 1.5 m the ground at a 3 m fully anechoic room. The measurement distance from the EUT to the receiving antenna is 3 m. EUT works in each mode of operation that needs to be tested , and having the EUT continuously working, respectively on 3 axis (X, Y & Z) and considered typical configuration to obtain worst position. The highest signal levels relative to the limit shall be determined by rotating the EUT from 0° to 360° and with varying the measurement antenna height between 1 m and 4 m in vertical and horizontal polarizations. Open the test software to control the test antenna and test turntable. Perform the test, save the test results, and export the test data.
Conducted test method	<ol style="list-style-type: none"> The Wi-Fi antenna port of EUT was connected to the test port of the test system through an RF cable. The EUT is keeping in continuous transmission mode and tested in all modulation modes. Open the test software, prepare a test plan, and control the system through the software. After the test is completed, the test report is exported through the test software.

5 Test Results

5.1 Summary

5.1.1 Clause and Data Summary

Test items	Standard clause	Test data	Result
Antenna Requirement	15.203 15.247 (b)(4)	See Section 5.2	Pass
AC Power Line Conducted Emission	15.207	See Section 5.3	Pass
Duty Cycle	ANSI C63.10-2013	Appendix – 2.4G Wi-Fi	Pass
Conducted Output Power	15.247 (b)(3)	Appendix – 2.4G Wi-Fi	Pass
6dB Emission Bandwidth 99% Occupied Bandwidth	15.247 (a)(2)	Appendix – 2.4G Wi-Fi	Pass
Power Spectral Density	15.247 (e)	Appendix – 2.4G Wi-Fi	Pass
Band-edge Emission Conduction Spurious Emission	15.247 (d)	Appendix – 2.4G Wi-Fi	Pass
Emissions in Restricted Frequency Bands	15.205 15.247 (d)	See Section 5.4	Pass
Emissions in Non-restricted Frequency Bands	15.209 15.247(d)	See Section 5.5	Pass
<p>Remark:</p> <ol style="list-style-type: none"> 1. Pass: The EUT complies with the essential requirements in the standard. 2. N/A: Not Applicable. 3. The cable insertion loss used by “RF Output Power” and other conduction measurement items is 0.5dB (provided by the customer). 			
Test Method:	ANSI C63.10-2013 KDB 558074 D01 15.247 Meas Guidance v05r02		

5.1.2 Test Limit

Test items	Limit																														
AC Power Line Conducted Emission	<table border="1"> <thead> <tr> <th rowspan="2">Frequency (MHz)</th> <th colspan="2">Limit (dBμV)</th> </tr> <tr> <th>Quasi-Peak</th> <th>Average</th> </tr> </thead> <tbody> <tr> <td>0.15 – 0.5</td> <td>66 to 56 <small>Note 1</small></td> <td>56 to 46 <small>Note 1</small></td> </tr> <tr> <td>0.5 – 5</td> <td>56</td> <td>46</td> </tr> <tr> <td>5 – 30</td> <td>60</td> <td>50</td> </tr> </tbody> </table> <p>Note 1: The limit level in dBμV decreases linearly with the logarithm of frequency. Note 2: The more stringent limit applies at transition frequencies.</p>	Frequency (MHz)	Limit (dB μ V)		Quasi-Peak	Average	0.15 – 0.5	66 to 56 <small>Note 1</small>	56 to 46 <small>Note 1</small>	0.5 – 5	56	46	5 – 30	60	50																
Frequency (MHz)	Limit (dB μ V)																														
	Quasi-Peak	Average																													
0.15 – 0.5	66 to 56 <small>Note 1</small>	56 to 46 <small>Note 1</small>																													
0.5 – 5	56	46																													
5 – 30	60	50																													
Conducted Output Power	For systems using digital modulation in the 902-928 MHz, 2400-2483.5 MHz, and 5725-5850 MHz bands: 1 Watt.																														
6dB Emission Bandwidth	The minimum 6 dB bandwidth shall be at least 500 kHz.																														
99% Occupied Bandwidth	N/A																														
Power Spectral Density	For digitally modulated systems, the power spectral density conducted from the intentional radiator to the antenna shall not be greater than 8 dBm in any 3 kHz band during any time interval of continuous transmission.																														
Band-edge Emission Conduction Spurious Emission	In any 100 kHz bandwidth outside the frequency band in which the spread spectrum or digitally modulated intentional radiator is operating, the radio frequency power that is produced by the intentional radiator shall be at least 20 dB below that in the 100 kHz bandwidth within the band that contains the highest level of the desired power, based on either an RF conducted or a radiated measurement, provided the transmitter demonstrates compliance with the peak conducted power limits. If the transmitter complies with the conducted power limits based on the use of RMS averaging over a time interval, as permitted under paragraph (b)(3) of this section, the attenuation required under this paragraph shall be 30 dB instead of 20 dB. Attenuation below the general limits specified in §15.209(a) is not required. In addition, radiated emissions which fall in the restricted bands, as defined in §15.205(a), must also comply with the radiated emission limits specified in §15.209(a) (see §15.205(c)).																														
Emissions in Restricted Frequency Bands Emissions in Non-restricted Frequency Bands	<table border="1"> <thead> <tr> <th rowspan="2">Frequency (MHz)</th> <th colspan="2">Limit (dBμV/m)</th> <th rowspan="2">Detector</th> </tr> <tr> <th>@ 3m</th> <th>@ 10m</th> </tr> </thead> <tbody> <tr> <td>30 – 88</td> <td>40.0</td> <td>30.0</td> <td>Quasi-peak</td> </tr> <tr> <td>88 – 216</td> <td>43.5</td> <td>33.5</td> <td>Quasi-peak</td> </tr> <tr> <td>216 – 960</td> <td>46.0</td> <td>36.0</td> <td>Quasi-peak</td> </tr> <tr> <td>960 – 1000</td> <td>54.0</td> <td>44.0</td> <td>Quasi-peak</td> </tr> </tbody> </table> <p>Note: The more stringent limit applies at transition frequencies.</p> <table border="1"> <thead> <tr> <th rowspan="2">Frequency</th> <th colspan="2">Limit (dBμV/m) @ 3m</th> </tr> <tr> <th>Average</th> <th>Peake</th> </tr> </thead> <tbody> <tr> <td>Above 1 GHz</td> <td>54.0</td> <td>74.0</td> </tr> </tbody> </table> <p>Note: The measurement bandwidth shall be 1 MHz or greater.</p>	Frequency (MHz)	Limit (dB μ V/m)		Detector	@ 3m	@ 10m	30 – 88	40.0	30.0	Quasi-peak	88 – 216	43.5	33.5	Quasi-peak	216 – 960	46.0	36.0	Quasi-peak	960 – 1000	54.0	44.0	Quasi-peak	Frequency	Limit (dB μ V/m) @ 3m		Average	Peake	Above 1 GHz	54.0	74.0
Frequency (MHz)	Limit (dB μ V/m)		Detector																												
	@ 3m	@ 10m																													
30 – 88	40.0	30.0	Quasi-peak																												
88 – 216	43.5	33.5	Quasi-peak																												
216 – 960	46.0	36.0	Quasi-peak																												
960 – 1000	54.0	44.0	Quasi-peak																												
Frequency	Limit (dB μ V/m) @ 3m																														
	Average	Peake																													
Above 1 GHz	54.0	74.0																													

5.2 Antenna Requirement

Standard Requirement:	FCC Part 15 C Section 15.203/15.247 (b)(4)
<p>15.203 requirement: An intentional radiator shall be designed to ensure that no antenna other than that furnished by the responsible party shall be used with the device. The use of a permanently attached antenna or of an antenna that uses a unique coupling to the intentional radiator, the manufacturer may design the unit so that a broken antenna can be replaced by the user, but the use of a standard antenna jack or electrical connector is prohibited.</p> <p>15.247 (b)(4) requirement: The conducted output power limit specified in paragraph (b) of this section is based on the use of antennas with directional gains that do not exceed 6 dBi. Except as shown in paragraph (c) of this section, if transmitting antennas of directional gain greater than 6 dBi are used, the conducted output power from the intentional radiator shall be reduced below the stated values in paragraphs (b)(1), (b)(2), and (b)(3) of this section, as appropriate, by the amount in dB that the directional gain of the antenna exceeds 6 dBi.</p>	
E.U.T Antenna:	
<p>The Wi-Fi antenna is an internal antenna which cannot replace by end-user, the best case gain of the antenna is 5.57 dBi. See product internal photos for details.</p>	

5.3 AC Power Line Conducted Emission

Product name:	Marshall 8 Plus	Product model:	Marshall 8 Plus
Test by:	Asher Zhang	Test mode:	2.4G Wi-Fi mode
Test frequency:	150 kHz ~ 30 MHz	Phase:	Line
Test voltage:	AC 120 V/60 Hz		

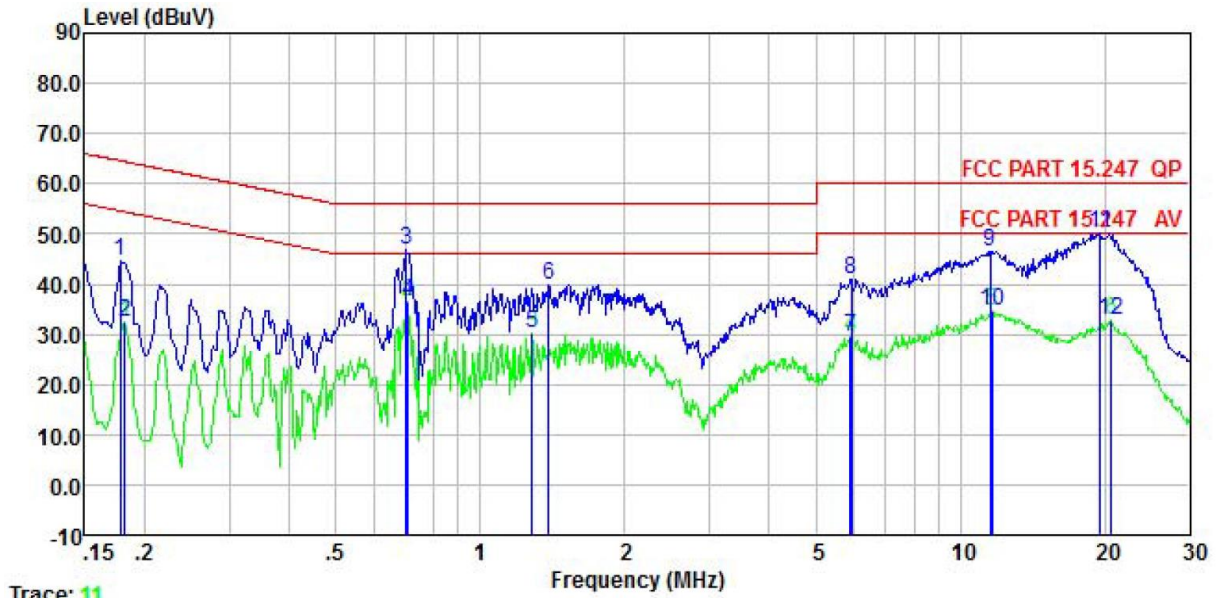

Trace: 11

	Read Freq	Read Level	LISN Factor	Aux Factor	Aux2 Factor	Cable Loss	Level	Limit Line	Over Limit	Remark
	MHz	dBuV	dB	dB	dB	dB	dBuV	dBuV	dB	
1	0.178	34.43	0.20	0.00	9.88	0.01	44.52	64.59	-20.07	QP
2	0.182	22.44	0.20	0.00	9.88	0.01	32.53	54.42	-21.89	Average
3	0.701	36.79	0.20	0.00	9.88	0.03	46.90	56.00	-9.10	QP
4	0.708	26.46	0.20	0.00	9.88	0.03	36.57	46.00	-9.43	Average
5	1.282	19.95	0.20	0.00	9.88	0.11	30.14	46.00	-15.86	Average
6	1.388	29.70	0.20	0.00	9.88	0.13	39.91	56.00	-16.09	QP
7	5.898	19.34	0.20	0.00	9.90	0.09	29.53	50.00	-20.47	Average
8	5.929	30.85	0.20	0.00	9.90	0.09	41.04	60.00	-18.96	QP
9	11.559	36.30	0.23	0.00	9.92	0.11	46.56	60.00	-13.44	QP
10	11.621	24.45	0.24	0.00	9.92	0.11	34.72	50.00	-15.28	Average
11	19.532	39.67	0.39	0.00	9.96	0.15	50.17	60.00	-9.83	QP
12	20.594	22.16	0.40	0.00	9.97	0.18	32.71	50.00	-17.29	Average

Remark:

1. Level = Read level + LISN Factor + Cable Loss.

Product name:	Marshall 8 Plus	Product model:	Marshall 8 Plus
Test by:	Asher Zhang	Test mode:	2.4G Wi-Fi mode
Test frequency:	150 kHz ~ 30 MHz	Phase:	Neutral
Test voltage:	AC 120 V/60 Hz		

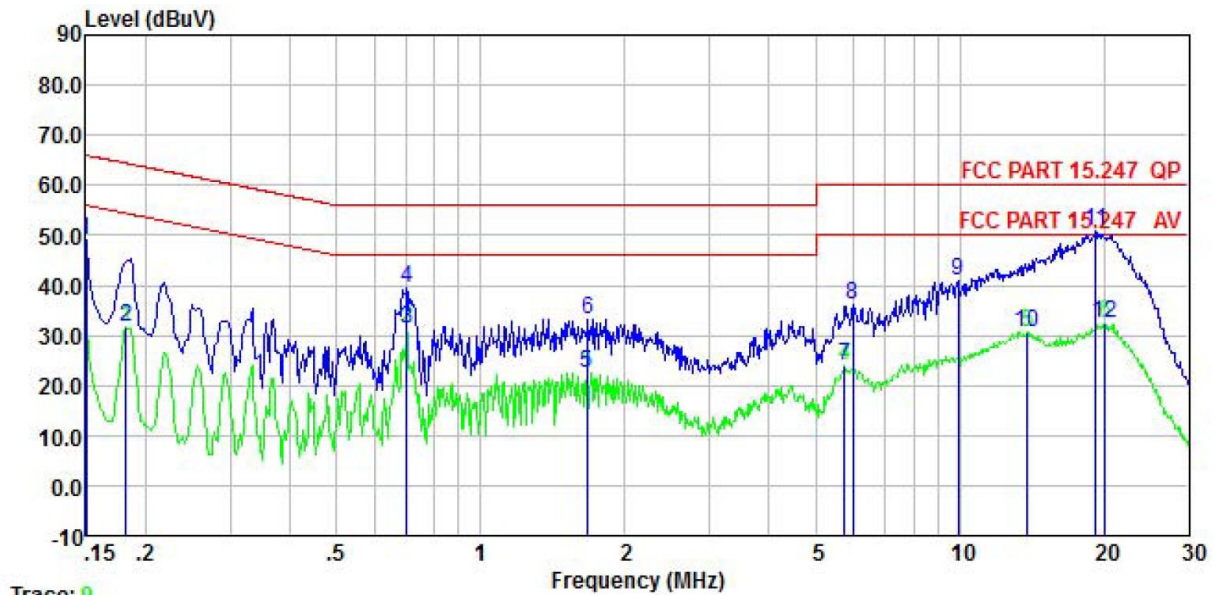

	Read Freq	Read Level	LISN Factor	Aux Factor	Aux2 Factor	Cable Loss	Level	Limit Line	Over Limit	Remark
	MHz	dBuV	dB	dB	dB	dB	dBuV	dBuV	dB	
1	0.150	39.10	0.20	0.00	9.88	0.01	49.19	66.00	-16.81	QP
2	0.182	21.48	0.20	0.00	9.88	0.01	31.57	54.42	-22.85	Average
3	0.701	21.33	0.20	0.00	9.88	0.03	31.44	46.00	-14.56	Average
4	0.701	29.39	0.20	0.00	9.88	0.03	39.50	56.00	-16.50	QP
5	1.662	12.28	0.27	0.00	9.88	0.17	22.60	46.00	-23.40	Average
6	1.671	22.84	0.27	0.00	9.88	0.17	33.16	56.00	-22.84	QP
7	5.744	13.80	0.30	0.00	9.90	0.09	24.09	50.00	-25.91	Average
8	5.993	25.78	0.30	0.00	9.90	0.09	36.07	60.00	-23.93	QP
9	9.913	30.39	0.40	0.00	9.91	0.13	40.83	60.00	-19.17	QP
10	13.841	20.21	0.40	0.00	9.93	0.12	30.66	50.00	-19.34	Average
11	19.224	40.35	0.40	0.00	9.96	0.15	50.86	60.00	-9.14	QP
12	20.056	22.04	0.40	0.00	9.96	0.19	32.59	50.00	-17.41	Average

Remark:

1. Level = Read level + LISN Factor + Cable Loss.

5.4 Emissions in Restricted Frequency Bands

Product Name:	Marshall 8 Plus	Product Model:	Marshall 8 Plus
Test By:	Robin Gu	Test mode:	802.11b Tx mode
Test Channel:	Lowest channel	Polarization:	Vertical
Test Voltage:	DC 3.7V		

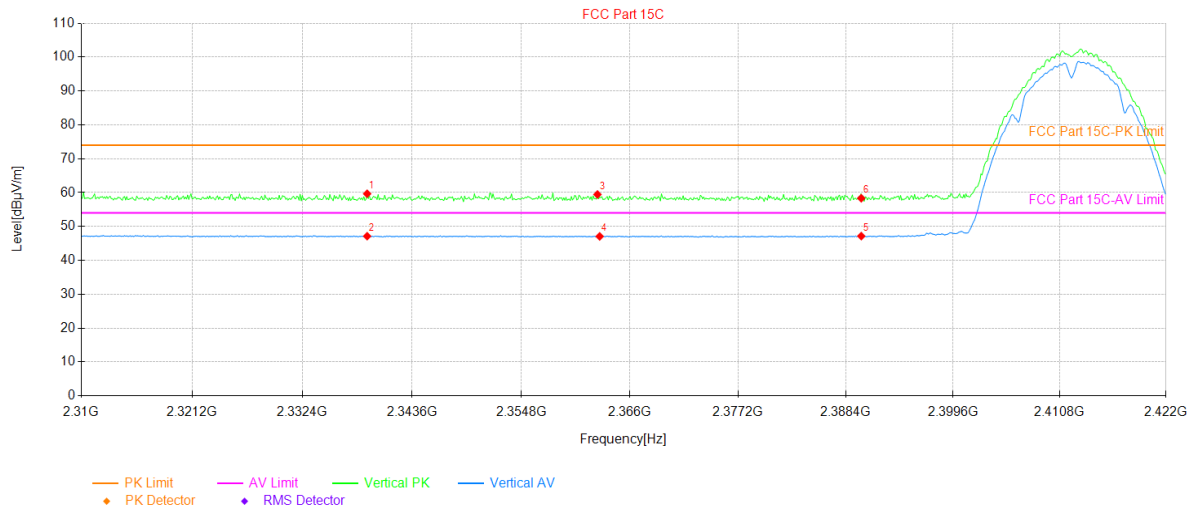

Suspected Data List										
NO.	Freq. [MHz]	Reading [dBµV]	Factor [dB/m]	Level [dBµV/m]	Limit [dBµV/m]	Margin [dB]	Angle [°]	Detector	Verdict	Polarity
1	2339.01	23.46	36.20	59.66	74.00	14.34	310	PK	PASS	Vertical
2	2339.01	10.94	36.20	47.14	54.00	6.86	58	AV	PASS	Vertical
3	2362.64	23.11	36.34	59.45	74.00	14.55	58	PK	PASS	Vertical
4	2362.86	10.74	36.34	47.08	54.00	6.92	8	AV	PASS	Vertical
5	2390.00	10.69	36.47	47.16	54.00	6.84	50	AV	PASS	Vertical
6	2390.00	21.87	36.47	58.34	74.00	15.66	317	PK	PASS	Vertical

Remark:

1. Level = Reading + Factor(Antenna Factor + Cable Loss – Preamplifier Factor)

Product Name:	Marshall 8 Plus	Product Model:	Marshall 8 Plus
Test By:	Robin Gu	Test mode:	802.11b Tx mode
Test Channel:	Lowest channel	Polarization:	Horizontal
Test Voltage:	DC 3.7V		

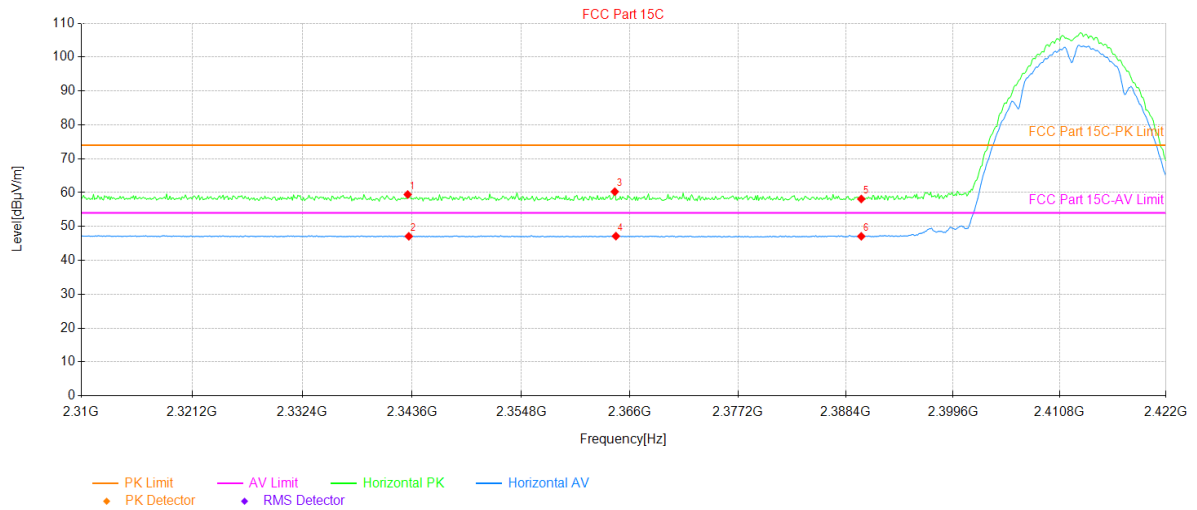

Suspected Data List										
NO.	Freq. [MHz]	Reading [dBµV]	Factor [dB/m]	Level [dBµV/m]	Limit [dBµV/m]	Margin [dB]	Angle [°]	Detector	Verdict	Polarity
1	2343.15	23.21	36.22	59.43	74.00	14.57	315	PK	PASS	Horizontal
2	2343.26	10.88	36.22	47.10	54.00	6.90	239	AV	PASS	Horizontal
3	2364.43	23.93	36.34	60.27	74.00	13.73	360	PK	PASS	Horizontal
4	2364.54	10.81	36.34	47.15	54.00	6.85	174	AV	PASS	Horizontal
5	2390.00	21.65	36.47	58.12	74.00	15.88	2	PK	PASS	Horizontal
6	2390.00	10.63	36.47	47.10	54.00	6.90	155	AV	PASS	Horizontal

Remark:

1. Level = Reading + Factor(Antenna Factor + Cable Loss – Preamplifier Factor)

Product Name:	Marshall 8 Plus	Product Model:	Marshall 8 Plus
Test By:	Robin Gu	Test mode:	802.11b Tx mode
Test Channel:	Highest channel	Polarization:	Vertical
Test Voltage:	DC 3.7V		

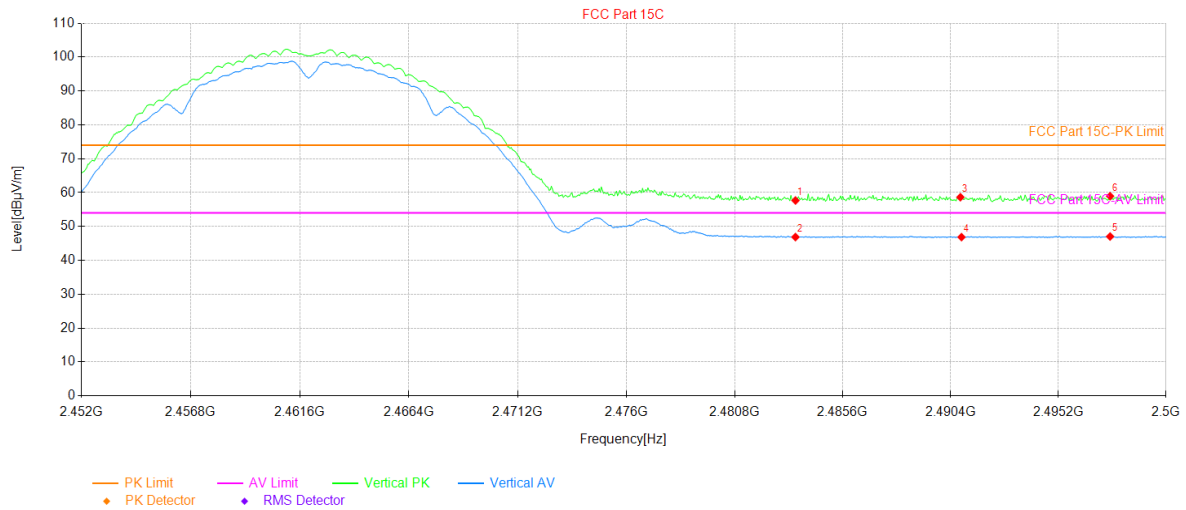

Suspected Data List										
NO.	Freq. [MHz]	Reading [dBµV]	Factor [dB/m]	Level [dBµV/m]	Limit [dBµV/m]	Margin [dB]	Angle [°]	Detector	Verdict	Polarity
1	2483.50	21.56	36.11	57.67	74.00	16.33	205	PK	PASS	Vertical
2	2483.50	10.77	36.11	46.88	54.00	7.12	292	AV	PASS	Vertical
3	2490.83	22.50	36.14	58.64	74.00	15.36	122	PK	PASS	Vertical
4	2490.88	10.73	36.14	46.87	54.00	7.13	247	AV	PASS	Vertical
5	2497.50	10.87	36.17	47.04	54.00	6.96	224	AV	PASS	Vertical
6	2497.50	22.77	36.17	58.94	74.00	15.06	352	PK	PASS	Vertical

Remark:

1. Level = Reading + Factor(Antenna Factor + Cable Loss – Preamplifier Factor)

Product Name:	Marshall 8 Plus	Product Model:	Marshall 8 Plus
Test By:	Robin Gu	Test mode:	802.11b Tx mode
Test Channel:	Highest channel	Polarization:	Horizontal
Test Voltage:	DC 3.7V		

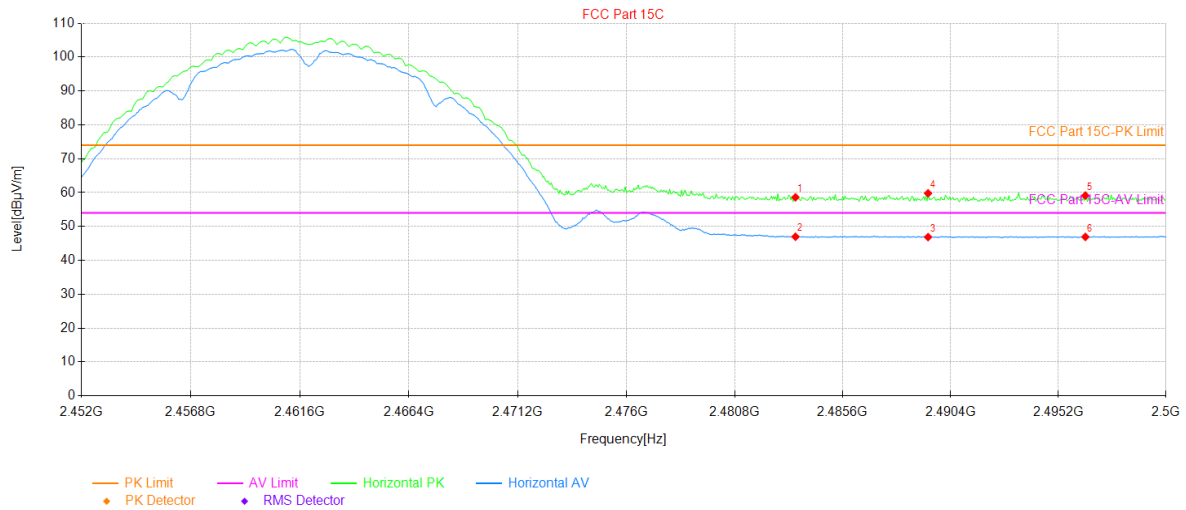

Suspected Data List										
NO.	Freq. [MHz]	Reading [dBµV]	Factor [dB/m]	Level [dBµV/m]	Limit [dBµV/m]	Margin [dB]	Angle [°]	Detector	Verdict	Polarity
1	2483.50	22.50	36.11	58.61	74.00	15.39	236	PK	PASS	Horizontal
2	2483.50	10.87	36.11	46.98	54.00	7.02	121	AV	PASS	Horizontal
3	2489.39	10.74	36.13	46.87	54.00	7.13	346	AV	PASS	Horizontal
4	2489.39	23.65	36.13	59.78	74.00	14.22	59	PK	PASS	Horizontal
5	2496.40	22.96	36.16	59.12	74.00	14.88	285	PK	PASS	Horizontal
6	2496.40	10.77	36.16	46.93	54.00	7.07	75	AV	PASS	Horizontal

Remark:

1. Level = Reading + Factor(Antenna Factor + Cable Loss – Preamplifier Factor)

Product Name:	Marshall 8 Plus	Product Model:	Marshall 8 Plus
Test By:	Robin Gu	Test mode:	802.11g Tx mode
Test Channel:	Lowest channel	Polarization:	Vertical
Test Voltage:	DC 3.7V		

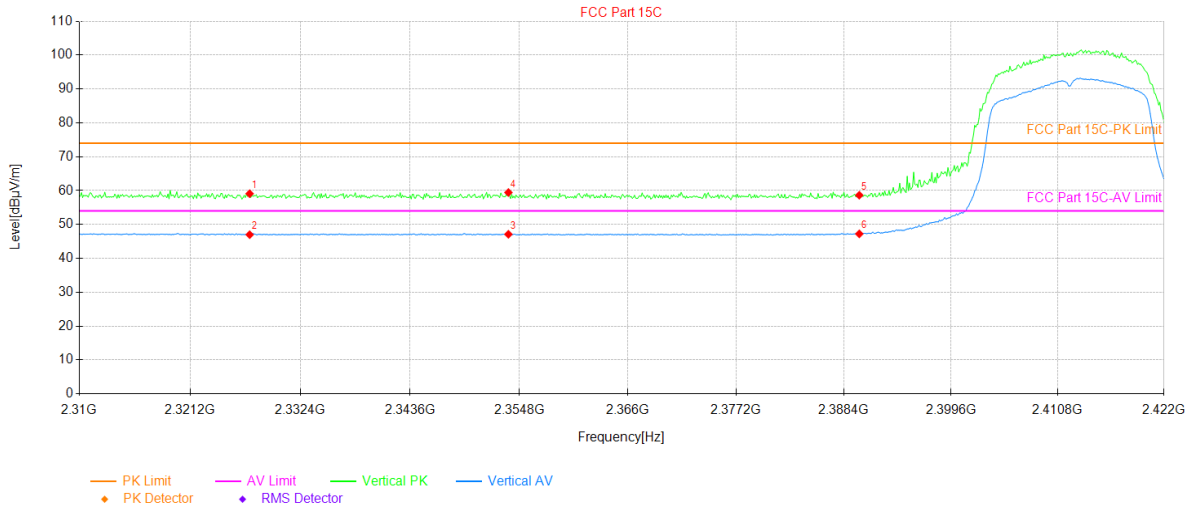

Suspected Data List										
NO.	Freq. [MHz]	Reading [dBµV]	Factor [dB/m]	Level [dBµV/m]	Limit [dBµV/m]	Margin [dB]	Angle [°]	Detector	Verdict	Polarity
1	2327.25	22.97	36.12	59.09	74.00	14.91	55	PK	PASS	Vertical
2	2327.25	10.87	36.12	46.99	54.00	7.01	150	AV	PASS	Vertical
3	2353.68	10.82	36.29	47.11	54.00	6.89	196	AV	PASS	Vertical
4	2353.68	23.14	36.29	59.43	74.00	14.57	0	PK	PASS	Vertical
5	2390.00	22.17	36.47	58.64	74.00	15.36	59	PK	PASS	Vertical
6	2390.00	10.76	36.47	47.23	54.00	6.77	59	AV	PASS	Vertical

Remark:

1. Level = Reading + Factor(Antenna Factor + Cable Loss – Preamplifier Factor)

Product Name:	Marshall 8 Plus	Product Model:	Marshall 8 Plus
Test By:	Robin Gu	Test mode:	802.11g Tx mode
Test Channel:	Lowest channel	Polarization:	Horizontal
Test Voltage:	DC 3.7V		

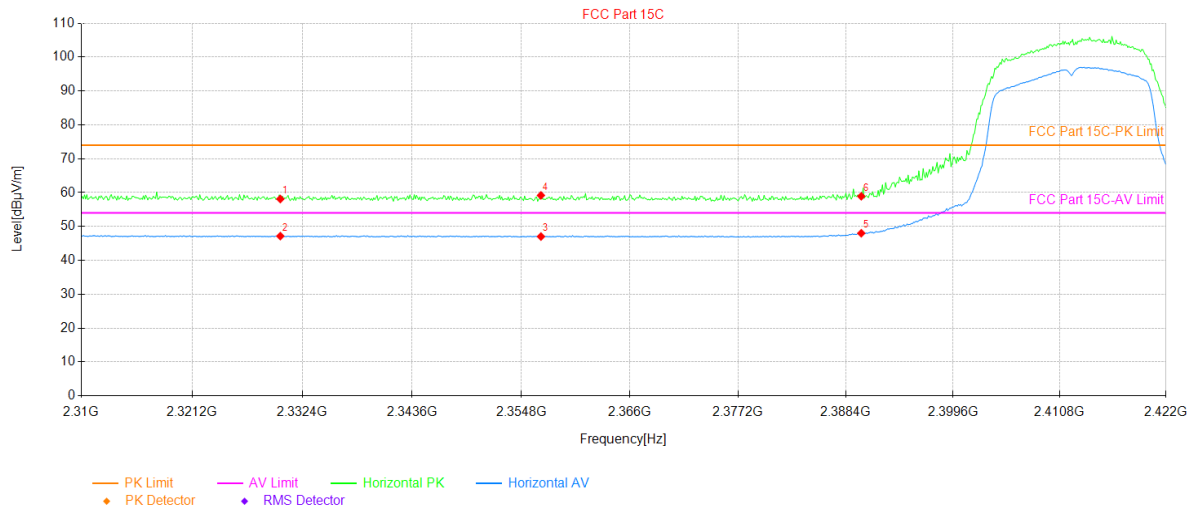

Suspected Data List										
NO.	Freq. [MHz]	Reading [dBµV]	Factor [dB/m]	Level [dBµV/m]	Limit [dBµV/m]	Margin [dB]	Angle [°]	Detector	Verdict	Polarity
1	2330.16	21.98	36.13	58.11	74.00	15.89	124	PK	PASS	Horizontal
2	2330.16	11.03	36.13	47.16	54.00	6.84	131	AV	PASS	Horizontal
3	2356.82	10.73	36.30	47.03	54.00	6.97	250	AV	PASS	Horizontal
4	2356.82	22.87	36.30	59.17	74.00	14.83	234	PK	PASS	Horizontal
5	2390.00	11.54	36.47	48.01	54.00	5.99	162	AV	PASS	Horizontal
6	2390.00	22.45	36.47	58.92	74.00	15.08	158	PK	PASS	Horizontal

Remark:

1. Level = Reading + Factor(Antenna Factor + Cable Loss – Preamplifier Factor)

Product Name:	Marshall 8 Plus	Product Model:	Marshall 8 Plus
Test By:	Robin Gu	Test mode:	802.11g Tx mode
Test Channel:	Highest channel	Polarization:	Vertical
Test Voltage:	DC 3.7V		

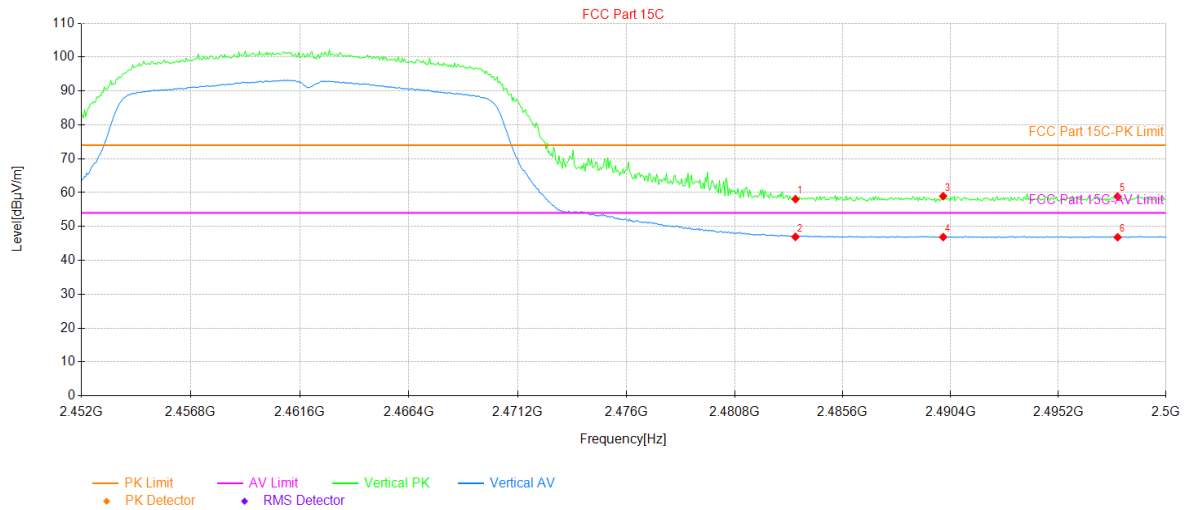

Suspected Data List										
NO.	Freq. [MHz]	Reading [dBµV]	Factor [dB/m]	Level [dBµV/m]	Limit [dBµV/m]	Margin [dB]	Angle [°]	Detector	Verdict	Polarity
1	2483.50	21.96	36.11	58.07	74.00	15.93	248	PK	PASS	Vertical
2	2483.50	10.83	36.11	46.94	54.00	7.06	29	AV	PASS	Vertical
3	2490.06	22.80	36.14	58.94	74.00	15.06	175	PK	PASS	Vertical
4	2490.06	10.73	36.14	46.87	54.00	7.13	225	AV	PASS	Vertical
5	2497.84	22.68	36.17	58.85	74.00	15.15	279	PK	PASS	Vertical
6	2497.84	10.66	36.17	46.83	54.00	7.17	159	AV	PASS	Vertical

Remark:

1. Level = Reading + Factor(Antenna Factor + Cable Loss – Preamplifier Factor)

Product Name:	Marshall 8 Plus	Product Model:	Marshall 8 Plus
Test By:	Robin Gu	Test mode:	802.11g Tx mode
Test Channel:	Highest channel	Polarization:	Horizontal
Test Voltage:	DC 3.7V		

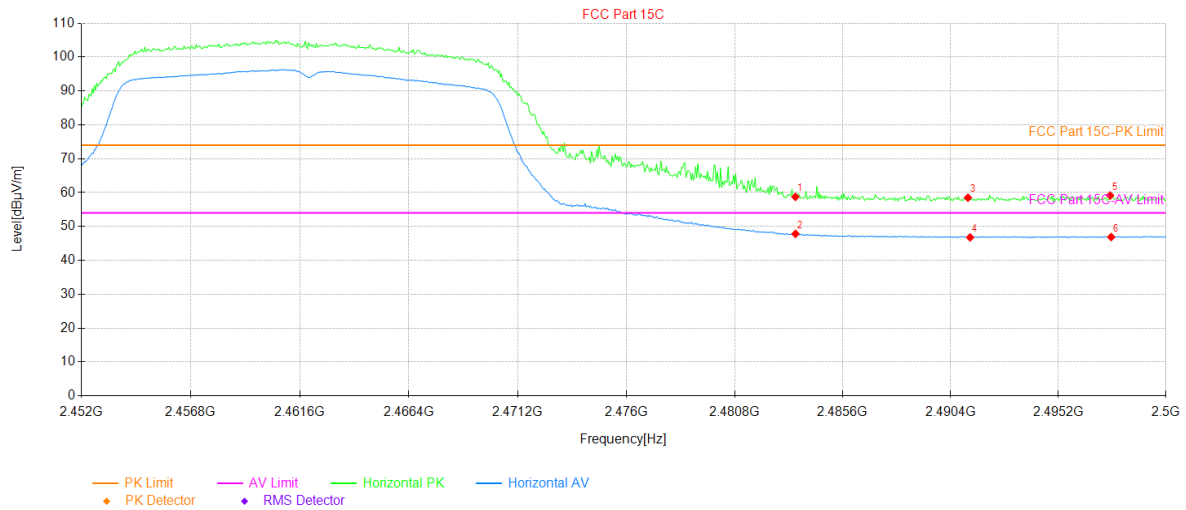

Suspected Data List										
NO.	Freq. [MHz]	Reading [dBµV]	Factor [dB/m]	Level [dBµV/m]	Limit [dBµV/m]	Margin [dB]	Angle [°]	Detector	Verdict	Polarity
1	2483.50	22.63	36.11	58.74	74.00	15.26	146	PK	PASS	Horizontal
2	2483.50	11.71	36.11	47.82	54.00	6.18	134	AV	PASS	Horizontal
3	2491.17	22.35	36.14	58.49	74.00	15.51	200	PK	PASS	Horizontal
4	2491.26	10.63	36.14	46.77	54.00	7.23	110	AV	PASS	Horizontal
5	2497.50	22.96	36.17	59.13	74.00	14.87	46	PK	PASS	Horizontal
6	2497.55	10.72	36.17	46.89	54.00	7.11	226	AV	PASS	Horizontal

Remark:

1. Level = Reading + Factor(Antenna Factor + Cable Loss – Preamplifier Factor)

Product Name:	Marshall 8 Plus	Product Model:	Marshall 8 Plus
Test By:	Robin Gu	Test mode:	802.11n-HT20 Tx mode
Test Channel:	Lowest channel	Polarization:	Vertical
Test Voltage:	DC 3.7V		

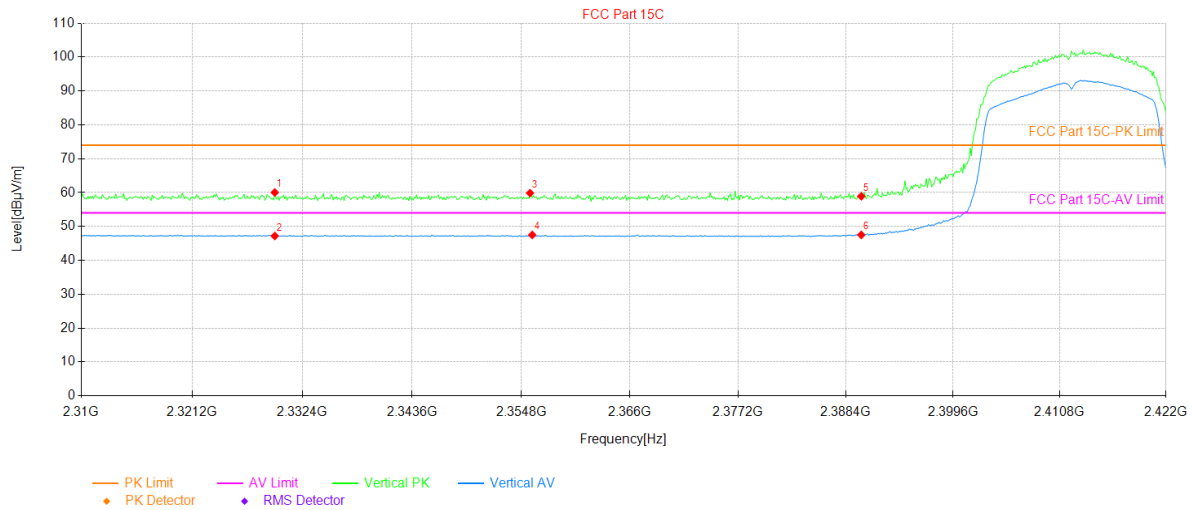

Suspected Data List										
NO.	Freq. [MHz]	Reading [dBµV]	Factor [dB/m]	Level [dBµV/m]	Limit [dBµV/m]	Margin [dB]	Angle [°]	Detector	Verdict	Polarity
1	2329.60	23.91	36.13	60.04	74.00	13.96	88	PK	PASS	Vertical
2	2329.60	11.06	36.13	47.19	54.00	6.81	225	AV	PASS	Vertical
3	2355.70	23.56	36.30	59.86	74.00	14.14	210	PK	PASS	Vertical
4	2355.92	11.20	36.30	47.50	54.00	6.50	187	AV	PASS	Vertical
5	2390.00	22.43	36.47	58.90	74.00	15.10	251	PK	PASS	Vertical
6	2390.00	11.05	36.47	47.52	54.00	6.48	1	AV	PASS	Vertical

Remark:

1. Level = Reading + Factor(Antenna Factor + Cable Loss – Preamplifier Factor)

Product Name:	Marshall 8 Plus	Product Model:	Marshall 8 Plus
Test By:	Robin Gu	Test mode:	802.11n-HT20 Tx mode
Test Channel:	Lowest channel	Polarization:	Horizontal
Test Voltage:	DC 3.7V		

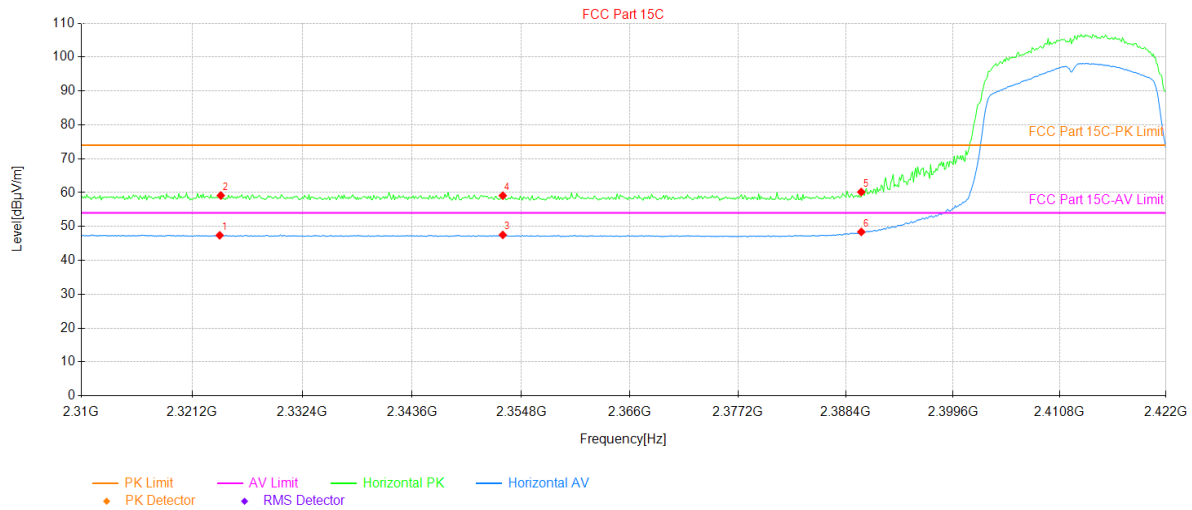

Suspected Data List										
NO.	Freq. [MHz]	Reading [dBµV]	Factor [dB/m]	Level [dBµV/m]	Limit [dBµV/m]	Margin [dB]	Angle [°]	Detector	Verdict	Polarity
1	2324.00	11.27	36.12	47.39	54.00	6.61	310	AV	PASS	Horizontal
2	2324.11	23.02	36.12	59.14	74.00	14.86	182	PK	PASS	Horizontal
3	2352.90	11.22	36.29	47.51	54.00	6.49	23	AV	PASS	Horizontal
4	2352.90	22.81	36.29	59.10	74.00	14.90	38	PK	PASS	Horizontal
5	2390.00	23.71	36.47	60.18	74.00	13.82	137	PK	PASS	Horizontal
6	2390.00	11.93	36.47	48.40	54.00	5.60	152	AV	PASS	Horizontal

Remark:

1. Level = Reading + Factor(Antenna Factor + Cable Loss – Preamplifier Factor)

Product Name:	Marshall 8 Plus	Product Model:	Marshall 8 Plus
Test By:	Robin Gu	Test mode:	802.11n-HT20 Tx mode
Test Channel:	Highest channel	Polarization:	Vertical
Test Voltage:	DC 3.7V		

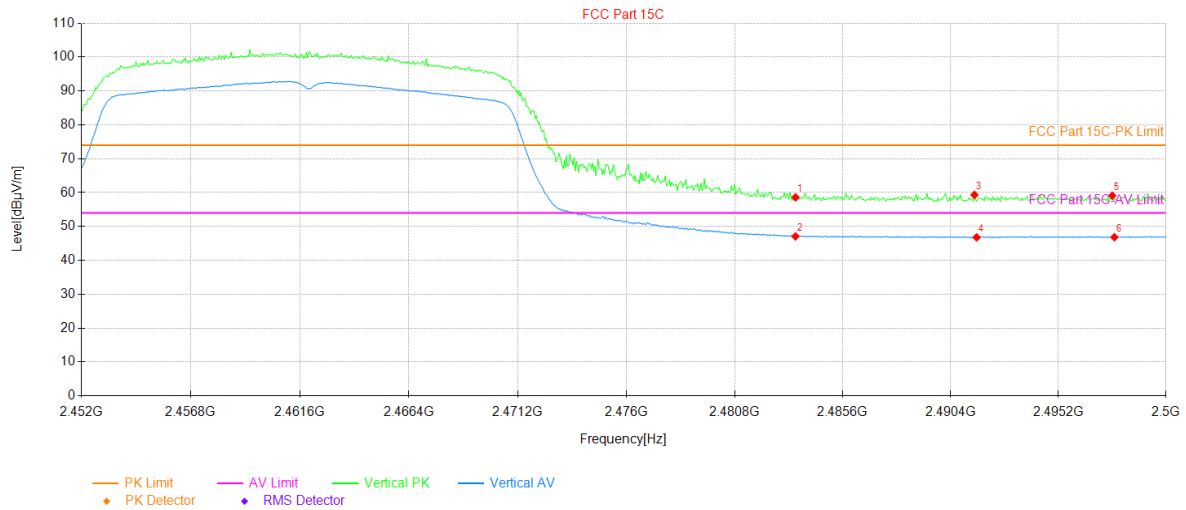

Suspected Data List										
NO.	Freq. [MHz]	Reading [dBµV]	Factor [dB/m]	Level [dBµV/m]	Limit [dBµV/m]	Margin [dB]	Angle [°]	Detector	Verdict	Polarity
1	2483.50	22.49	36.11	58.60	74.00	15.40	44	PK	PASS	Vertical
2	2483.50	10.98	36.11	47.09	54.00	6.91	0	AV	PASS	Vertical
3	2491.46	23.18	36.14	59.32	74.00	14.68	9	PK	PASS	Vertical
4	2491.55	10.65	36.14	46.79	54.00	7.21	162	AV	PASS	Vertical
5	2497.60	22.92	36.17	59.09	74.00	14.91	104	PK	PASS	Vertical
6	2497.70	10.66	36.17	46.83	54.00	7.17	120	AV	PASS	Vertical

Remark:

1. Level = Reading + Factor(Antenna Factor + Cable Loss – Preamplifier Factor)

Product Name:	Marshall 8 Plus	Product Model:	Marshall 8 Plus
Test By:	Robin Gu	Test mode:	802.11n-HT20 Tx mode
Test Channel:	Highest channel	Polarization:	Horizontal
Test Voltage:	DC 3.7V		

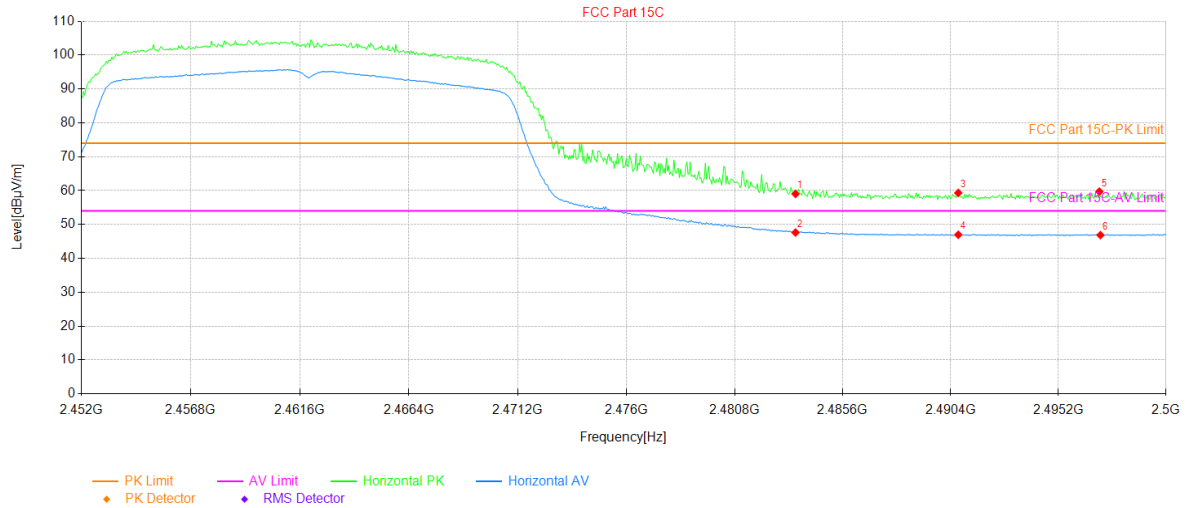

Suspected Data List										
NO.	Freq. [MHz]	Reading [dBµV]	Factor [dB/m]	Level [dBµV/m]	Limit [dBµV/m]	Margin [dB]	Angle [°]	Detector	Verdict	Polarity
1	2483.50	22.92	36.11	59.03	74.00	14.97	180	PK	PASS	Horizontal
2	2483.50	11.52	36.11	47.63	54.00	6.37	123	AV	PASS	Horizontal
3	2490.74	23.17	36.14	59.31	74.00	14.69	310	PK	PASS	Horizontal
4	2490.74	10.82	36.14	46.96	54.00	7.04	345	AV	PASS	Horizontal
5	2497.02	23.53	36.17	59.70	74.00	14.30	287	PK	PASS	Horizontal
6	2497.07	10.69	36.17	46.86	54.00	7.14	135	AV	PASS	Horizontal

Remark:

1. Level = Reading + Factor(Antenna Factor + Cable Loss – Preamplifier Factor)

Product Name:	Marshall 8 Plus	Product Model:	Marshall 8 Plus
Test By:	Robin Gu	Test mode:	802.11n-HT40 Tx mode
Test Channel:	Lowest channel	Polarization:	Vertical
Test Voltage:	DC 3.7V		

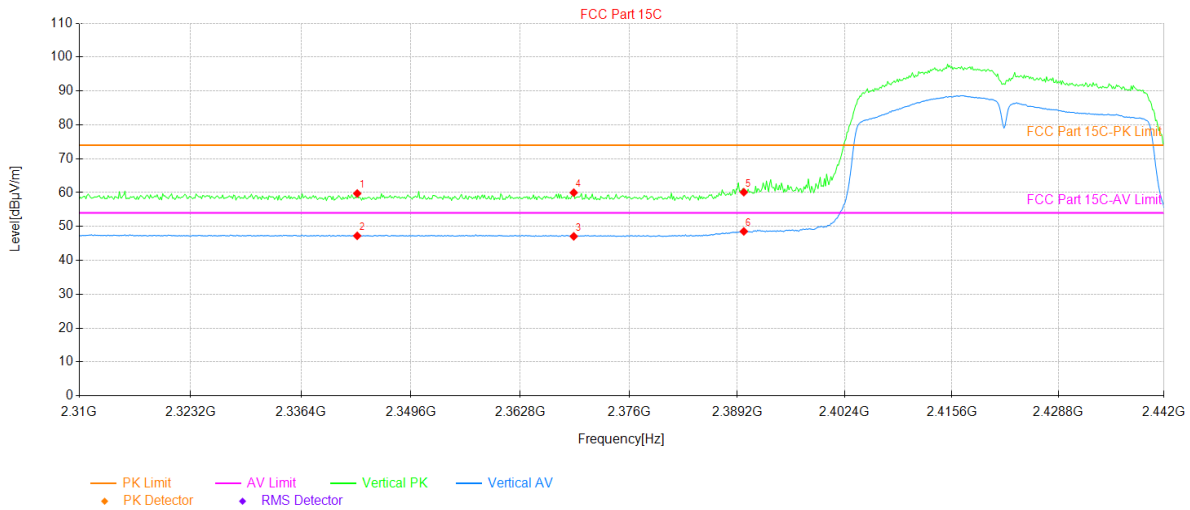

Suspected Data List										
NO.	Freq. [MHz]	Reading [dBµV]	Factor [dB/m]	Level [dBµV/m]	Limit [dBµV/m]	Margin [dB]	Angle [°]	Detector	Verdict	Polarity
1	2343.13	23.51	36.22	59.73	74.00	14.27	305	PK	PASS	Vertical
2	2343.13	11.02	36.22	47.24	54.00	6.76	79	AV	PASS	Vertical
3	2369.27	10.72	36.37	47.09	54.00	6.91	94	AV	PASS	Vertical
4	2369.27	23.62	36.37	59.99	74.00	14.01	166	PK	PASS	Vertical
5	2390.00	23.64	36.47	60.11	74.00	13.89	33	PK	PASS	Vertical
6	2390.00	12.08	36.47	48.55	54.00	5.45	33	AV	PASS	Vertical

Remark:

1. Level = Reading + Factor(Antenna Factor + Cable Loss – Preamplifier Factor)

Product Name:	Marshall 8 Plus	Product Model:	Marshall 8 Plus
Test By:	Robin Gu	Test mode:	802.11n-HT40 Tx mode
Test Channel:	Lowest channel	Polarization:	Horizontal
Test Voltage:	DC 3.7V		

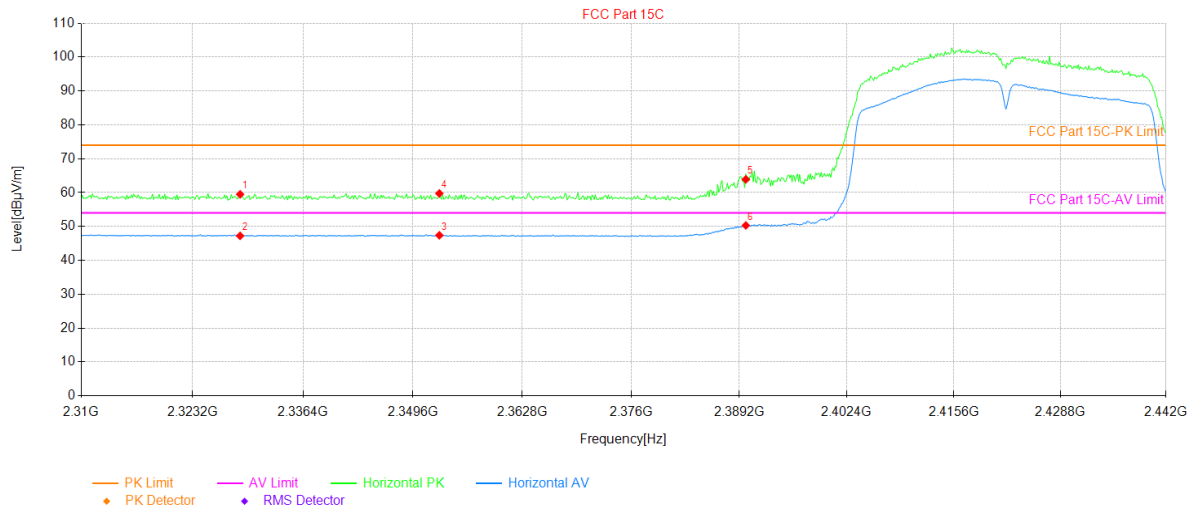

Suspected Data List										
NO.	Freq. [MHz]	Reading [dBµV]	Factor [dB/m]	Level [dBµV/m]	Limit [dBµV/m]	Margin [dB]	Angle [°]	Detector	Verdict	Polarity
1	2328.88	23.36	36.13	59.49	74.00	14.51	234	PK	PASS	Horizontal
2	2328.88	11.11	36.13	47.24	54.00	6.76	281	AV	PASS	Horizontal
3	2352.77	11.11	36.29	47.40	54.00	6.60	58	AV	PASS	Horizontal
4	2352.77	23.46	36.29	59.75	74.00	14.25	326	PK	PASS	Horizontal
5	2390.00	27.43	36.47	63.90	74.00	10.10	145	PK	PASS	Horizontal
6	2390.00	13.84	36.47	50.31	54.00	3.69	152	AV	PASS	Horizontal

Remark:

1. Level = Reading + Factor(Antenna Factor + Cable Loss – Preamplifier Factor)

Product Name:	Marshall 8 Plus	Product Model:	Marshall 8 Plus
Test By:	Robin Gu	Test mode:	802.11n-HT40 Tx mode
Test Channel:	Highest channel	Polarization:	Vertical
Test Voltage:	DC 3.7V		

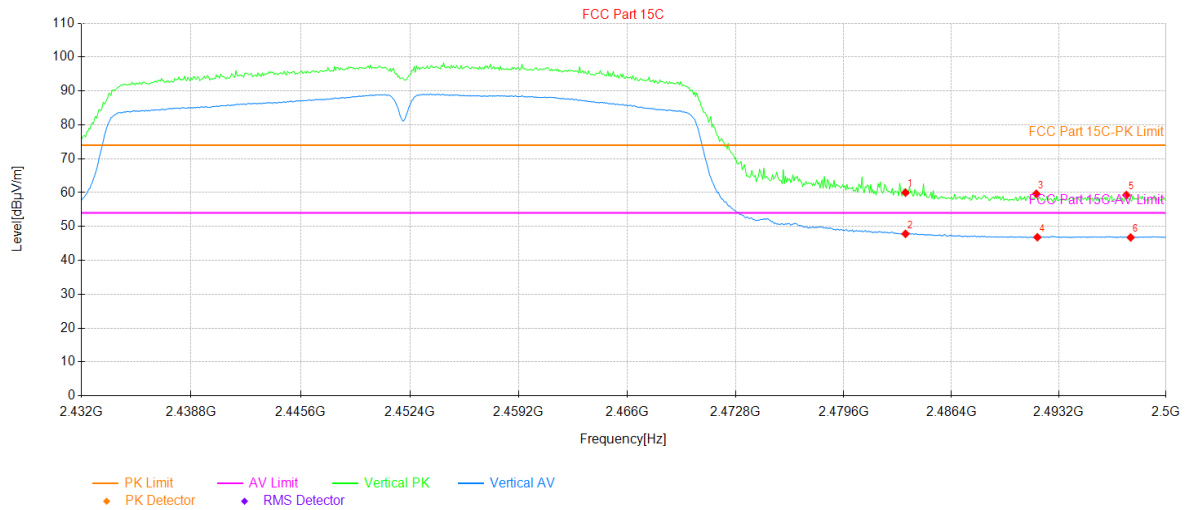

Suspected Data List										
NO.	Freq. [MHz]	Reading [dBµV]	Factor [dB/m]	Level [dBµV/m]	Limit [dBµV/m]	Margin [dB]	Angle [°]	Detector	Verdict	Polarity
1	2483.50	23.89	36.11	60.00	74.00	14.00	10	PK	PASS	Vertical
2	2483.50	11.72	36.11	47.83	54.00	6.17	28	AV	PASS	Vertical
3	2491.77	23.51	36.14	59.65	74.00	14.35	107	PK	PASS	Vertical
4	2491.84	10.69	36.14	46.83	54.00	7.17	167	AV	PASS	Vertical
5	2497.48	23.10	36.17	59.27	74.00	14.73	330	PK	PASS	Vertical
6	2497.76	10.59	36.17	46.76	54.00	7.24	122	AV	PASS	Vertical

Remark:

1. Level = Reading + Factor(Antenna Factor + Cable Loss – Preamplifier Factor)

Product Name:	Marshall 8 Plus	Product Model:	Marshall 8 Plus
Test By:	Robin Gu	Test mode:	802.11n-HT40 Tx mode
Test Channel:	Highest channel	Polarization:	Horizontal
Test Voltage:	DC 3.7V		

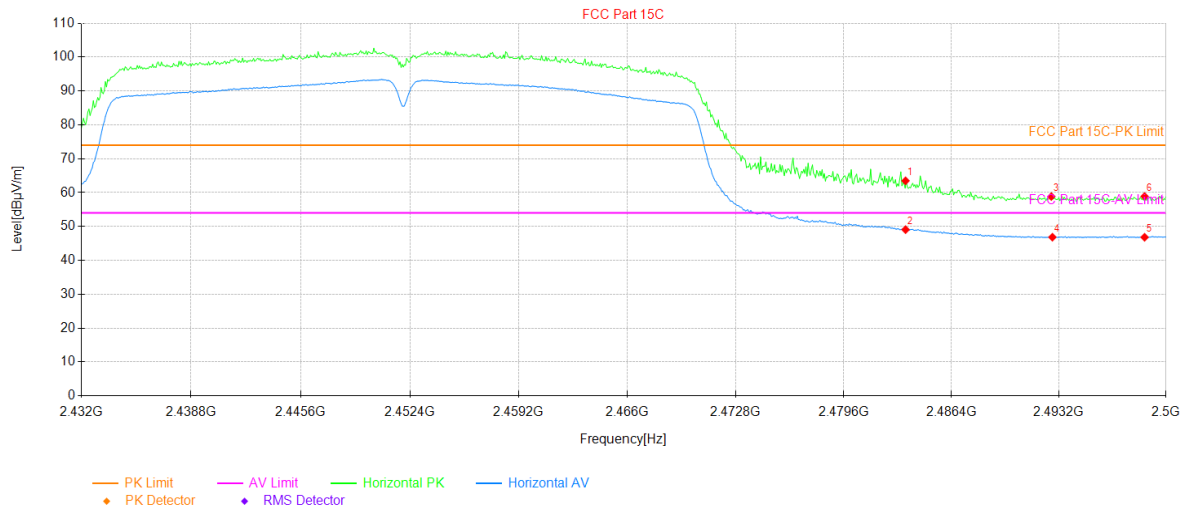

Suspected Data List										
NO.	Freq. [MHz]	Reading [dBµV]	Factor [dB/m]	Level [dBµV/m]	Limit [dBµV/m]	Margin [dB]	Angle [°]	Detector	Verdict	Polarity
1	2483.50	27.37	36.11	63.48	74.00	10.52	99	PK	PASS	Horizontal
2	2483.50	12.96	36.11	49.07	54.00	4.93	118	AV	PASS	Horizontal
3	2492.72	22.69	36.15	58.84	74.00	15.16	110	PK	PASS	Horizontal
4	2492.79	10.69	36.15	46.84	54.00	7.16	194	AV	PASS	Horizontal
5	2498.64	10.64	36.17	46.81	54.00	7.19	202	AV	PASS	Horizontal
6	2498.64	22.70	36.17	58.87	74.00	15.13	202	PK	PASS	Horizontal

Remark:

1. Level = Reading + Factor(Antenna Factor + Cable Loss – Preamplifier Factor)

5.5 Emissions in Non-restricted Frequency Bands

Below 1GHz:

Product Name:	Marshall 8 Plus	Product Model:	Marshall 8 Plus
Test By:	Kiran Zeng	Test mode:	2.4G Wi-Fi mode
Test Frequency:	30 MHz ~ 1 GHz	Polarization:	Vertical & Horizontal
Test Voltage:	DC 3.7V		

Full Spectrum

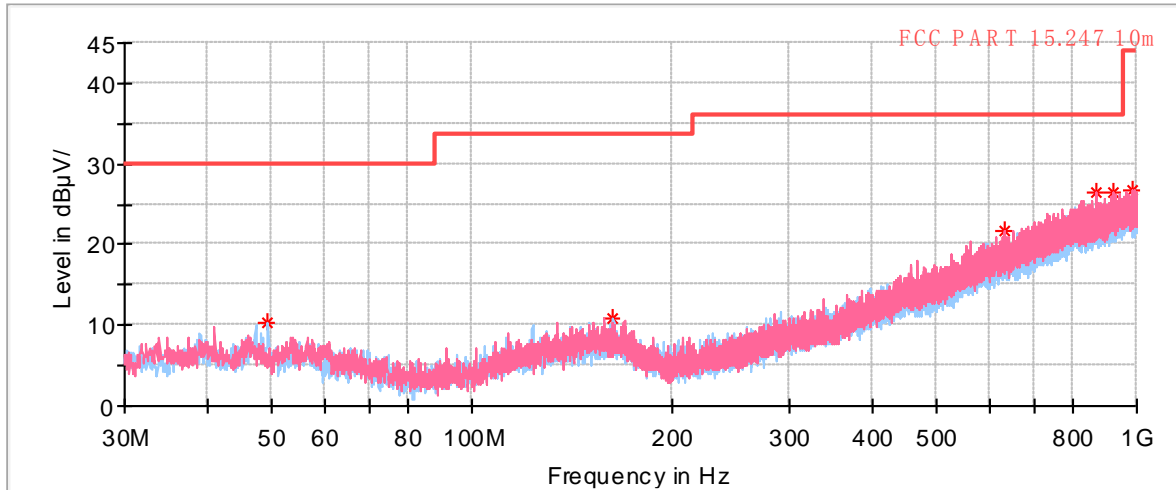

* Critical_Freqs PK+
 — FCC PART 15.247 10m
 ◆ Final_Result QPK
— Preview Result 1H-PK+
 — Preview Result 1V-PK+

Critical_Freqs

Frequency (MHz)	MaxPeak (dB µ V/m)	Limit (dB µ V/m)	Margin (dB)	Height (cm)	Pol	Azimuth (deg)	Corr. (dB/m)	Comment
49.351500	10.36	30.00	19.64	100.0	H	105.0	-16.2	14:21:33 - 2024/5/20
163.229500	10.91	33.50	22.59	100.0	H	126.0	-15.4	14:21:33 - 2024/5/20
632.612500	21.64	36.00	14.36	100.0	V	159.0	-5.8	14:23:16 - 2024/5/20
866.964500	26.36	36.00	9.64	100.0	V	25.0	-1.8	14:23:13 - 2024/5/20
921.284500	26.40	36.00	9.60	100.0	V	280.0	-0.8	14:21:33 - 2024/5/20
984.431500	26.77	44.00	17.23	100.0	V	239.0	-0.1	14:23:22 - 2024/5/20

Remark:

1. Level = Reading + Factor(Antenna Factor + Cable Loss - Preamplifier Factor)

Above 1GHz

802.11b						
Test channel: Lowest channel						
Detector: Peak Value						
Frequency (MHz)	Read Level (dBμV)	Factor (dB)	Level (dBμV/m)	Limit (dBμV/m)	Margin (dB)	Polarization
4824.00	50.97	-7.92	43.05	74.00	30.95	Vertical
4824.00	50.74	-7.92	42.82	74.00	31.18	Horizontal
Detector: Average Value						
Frequency (MHz)	Read Level (dBμV)	Factor (dB)	Level (dBμV/m)	Limit (dBμV/m)	Margin (dB)	Polarization
4824.00	42.28	-7.92	34.36	54.00	19.64	Vertical
4824.00	43.26	-7.92	35.34	54.00	18.66	Horizontal
Test channel: Middle channel						
Detector: Peak Value						
Frequency (MHz)	Read Level (dBμV)	Factor (dB)	Level (dBμV/m)	Limit (dBμV/m)	Margin (dB)	Polarization
4874.00	50.91	-7.55	43.36	74.00	30.64	Vertical
4874.00	49.55	-7.55	42.00	74.00	32.00	Horizontal
Detector: Average Value						
Frequency (MHz)	Read Level (dBμV)	Factor (dB)	Level (dBμV/m)	Limit (dBμV/m)	Margin (dB)	Polarization
4874.00	41.52	-7.55	33.97	54.00	20.03	Vertical
4874.00	43.01	-7.55	35.46	54.00	18.54	Horizontal
Test channel: Highest channel						
Detector: Peak Value						
Frequency (MHz)	Read Level (dBμV)	Factor (dB)	Level (dBμV/m)	Limit (dBμV/m)	Margin (dB)	Polarization
4924.00	50.16	-7.21	42.95	74.00	31.05	Vertical
4924.00	50.27	-7.21	43.06	74.00	30.94	Horizontal
Detector: Average Value						
Frequency (MHz)	Read Level (dBμV)	Factor (dB)	Level (dBμV/m)	Limit (dBμV/m)	Margin (dB)	Polarization
4924.00	41.08	-7.21	33.87	54.00	20.13	Vertical
4924.00	43.10	-7.21	35.89	54.00	18.11	Horizontal
Remark:						
1. Level = Reading + Factor.						
2. Test Frequency up to 25GHz, and the emission levels of other frequencies are lower than the limit 20dB, not show in test report.						

802.11g						
Test channel: Lowest channel						
Detector: Peak Value						
Frequency (MHz)	Read Level (dBμV)	Factor (dB)	Level (dBμV/m)	Limit (dBμV/m)	Margin (dB)	Polarization
4824.00	50.17	-7.92	42.25	74.00	31.75	Vertical
4824.00	49.63	-7.92	41.71	74.00	32.29	Horizontal
Detector: Average Value						
Frequency (MHz)	Read Level (dBμV)	Factor (dB)	Level (dBμV/m)	Limit (dBμV/m)	Margin (dB)	Polarization
4824.00	41.79	-7.92	33.87	54.00	20.13	Vertical
4824.00	42.80	-7.92	34.88	54.00	19.12	Horizontal
Test channel: Middle channel						
Detector: Peak Value						
Frequency (MHz)	Read Level (dBμV)	Factor (dB)	Level (dBμV/m)	Limit (dBμV/m)	Margin (dB)	Polarization
4874.00	49.77	-7.55	42.22	74.00	31.78	Vertical
4874.00	49.52	-7.55	41.97	74.00	32.03	Horizontal
Detector: Average Value						
Frequency (MHz)	Read Level (dBμV)	Factor (dB)	Level (dBμV/m)	Limit (dBμV/m)	Margin (dB)	Polarization
4874.00	41.27	-7.55	33.72	54.00	20.28	Vertical
4874.00	42.69	-7.55	35.14	54.00	18.86	Horizontal
Test channel: Highest channel						
Detector: Peak Value						
Frequency (MHz)	Read Level (dBμV)	Factor (dB)	Level (dBμV/m)	Limit (dBμV/m)	Margin (dB)	Polarization
4924.00	50.82	-7.21	43.61	74.00	30.39	Vertical
4924.00	50.72	-7.21	43.51	74.00	30.49	Horizontal
Detector: Average Value						
Frequency (MHz)	Read Level (dBμV)	Factor (dB)	Level (dBμV/m)	Limit (dBμV/m)	Margin (dB)	Polarization
4924.00	41.76	-7.21	34.55	54.00	19.45	Vertical
4924.00	42.41	-7.21	35.20	54.00	18.80	Horizontal
Remark:						
1. Level = Reading + Factor.						
2. Test Frequency up to 25GHz, and the emission levels of other frequencies are lower than the limit 20dB, not show in test report.						

802.11n-HT20						
Test channel: Lowest channel						
Detector: Peak Value						
Frequency (MHz)	Read Level (dBμV)	Factor (dB)	Level (dBμV/m)	Limit (dBμV/m)	Margin (dB)	Polarization
4824.00	50.12	-7.92	42.20	74.00	31.80	Vertical
4824.00	50.59	-7.92	42.67	74.00	31.33	Horizontal
Detector: Average Value						
Frequency (MHz)	Read Level (dBμV)	Factor (dB)	Level (dBμV/m)	Limit (dBμV/m)	Margin (dB)	Polarization
4824.00	41.85	-7.92	33.93	54.00	20.07	Vertical
4824.00	43.25	-7.92	35.33	54.00	18.67	Horizontal
Test channel: Middle channel						
Detector: Peak Value						
Frequency (MHz)	Read Level (dBμV)	Factor (dB)	Level (dBμV/m)	Limit (dBμV/m)	Margin (dB)	Polarization
4874.00	49.90	-7.55	42.35	74.00	31.65	Vertical
4874.00	50.45	-7.55	42.90	74.00	31.10	Horizontal
Detector: Average Value						
Frequency (MHz)	Read Level (dBμV)	Factor (dB)	Level (dBμV/m)	Limit (dBμV/m)	Margin (dB)	Polarization
4874.00	42.15	-7.55	34.60	54.00	19.40	Vertical
4874.00	42.25	-7.55	34.70	54.00	19.30	Horizontal
Test channel: Highest channel						
Detector: Peak Value						
Frequency (MHz)	Read Level (dBμV)	Factor (dB)	Level (dBμV/m)	Limit (dBμV/m)	Margin (dB)	Polarization
4924.00	50.10	-7.21	42.89	74.00	31.11	Vertical
4924.00	49.49	-7.21	42.28	74.00	31.72	Horizontal
Detector: Average Value						
Frequency (MHz)	Read Level (dBμV)	Factor (dB)	Level (dBμV/m)	Limit (dBμV/m)	Margin (dB)	Polarization
4924.00	41.05	-7.21	33.84	54.00	20.16	Vertical
4924.00	42.36	-7.21	35.15	54.00	18.85	Horizontal
Remark:						
1. Level = Reading + Factor.						
2. Test Frequency up to 25GHz, and the emission levels of other frequencies are lower than the limit 20dB, not show in test report.						

802.11n-HT40						
Test channel: Lowest channel						
Detector: Peak Value						
Frequency (MHz)	Read Level (dBμV)	Factor (dB)	Level (dBμV/m)	Limit (dBμV/m)	Margin (dB)	Polarization
4844.00	50.43	-7.83	42.60	74.00	31.40	Vertical
4844.00	50.48	-7.83	42.65	74.00	31.35	Horizontal
Detector: Average Value						
Frequency (MHz)	Read Level (dBμV)	Factor (dB)	Level (dBμV/m)	Limit (dBμV/m)	Margin (dB)	Polarization
4844.00	41.06	-7.83	33.23	54.00	20.77	Vertical
4844.00	42.70	-7.83	34.87	54.00	19.13	Horizontal
Test channel: Middle channel						
Detector: Peak Value						
Frequency (MHz)	Read Level (dBμV)	Factor (dB)	Level (dBμV/m)	Limit (dBμV/m)	Margin (dB)	Polarization
4874.00	50.26	-7.55	42.71	74.00	31.29	Vertical
4874.00	50.02	-7.55	42.47	74.00	31.53	Horizontal
Detector: Average Value						
Frequency (MHz)	Read Level (dBμV)	Factor (dB)	Level (dBμV/m)	Limit (dBμV/m)	Margin (dB)	Polarization
4874.00	41.22	-7.55	33.67	54.00	20.33	Vertical
4874.00	42.13	-7.55	34.58	54.00	19.42	Horizontal
Test channel: Highest channel						
Detector: Peak Value						
Frequency (MHz)	Read Level (dBμV)	Factor (dB)	Level (dBμV/m)	Limit (dBμV/m)	Margin (dB)	Polarization
4904.00	49.95	-7.27	42.68	74.00	31.32	Vertical
4904.00	49.56	-7.27	42.29	74.00	31.71	Horizontal
Detector: Average Value						
Frequency (MHz)	Read Level (dBμV)	Factor (dB)	Level (dBμV/m)	Limit (dBμV/m)	Margin (dB)	Polarization
4904.00	41.96	-7.27	34.69	54.00	19.31	Vertical
4904.00	42.97	-7.27	35.70	54.00	18.30	Horizontal
Remark:						
1. Level = Reading + Factor.						
2. Test Frequency up to 25GHz, and the emission levels of other frequencies are lower than the limit 20dB, not show in test report.						

-----End of report-----