



FCC RADIO TEST REPORT

FCC ID:2AGUJ-BM5510

Product: Fingerprint smart terminal

Trade Name:  Aratek

Model Number: BM5510

Serial Model: BM5500, BM5520, BM5530, VIU500-ATK100

Report No.: NTEK-2015NT1126170F4

Prepared for

ShenZhen Aratek Biometrics Technology Co.,Ltd.
2F,T2-A Building,ShenZhen Software Park,South Area,Hi-Tech
Park,ShenZhen,Guangdong,China

Prepared by

Shenzhen NTEK Testing Technology Co., Ltd.
1/F, Building E, Fenda Science Park, Sanwei Community,Xixiang Street
Bao'an District, Shenzhen P.R. China
Tel.: +86-0755-61156588 Fax.: +86-0755-61156599
Website:www.ntek.org.cn

TEST RESULT CERTIFICATION

Applicant's name.....: ShenZhen Aratek Biometrics Technology Co.,Ltd.
Address: 2F,T2-A Building,ShenZhen Software Park,South Area,Hi-Tech Park,ShenZhen,Guangdong,China
Manufacture's Name: ShenZhen Aratek Biometrics Technology Co.,Ltd.
Address: 2F,T2-A Building,ShenZhen Software Park,South Area,Hi-Tech Park,ShenZhen,Guangdong,China
Product name.....: Fingerprint smart terminal
Model and/or type reference ...: BM5510
Serial Model : BM5500, BM5520, BM5530, VIU500-ATK100
Standards.....: FCC Part 22H and 24E: 01 Oct. 2015
Test procedure: TIA/EIA 603D

This device described above has been tested by NTEK, and the test results show that the equipment under test (EUT) is in compliance with the FCC requirements. And it is applicable only to the tested sample identified in the report.

This report shall not be reproduced except in full, without the written approval of NTEK, this document may be altered or revised by NTEK, personal only, and shall be noted in the revision of the document.

Date of Test.....
Date (s) of performance of tests..... 26 Nov. 2015 ~02 Dec. 2015
Date of Issue 02 Dec. 2015
Test Result **Pass**

Testing Engineer : Eileen Liu.
(Eileen Liu)
Technical Manager : Brown Lu
(Brown Lu)
Authorized Signatory : Sam. Chen
(Sam Chen)

TABLE OF CONTENTS

- 1. GENERAL INFORMATION.....5
- 1. GENERAL INFORMATION.....5
- 1.1 PRODUCT DESCRIPTION 5
- 1.2 RELATED SUBMITTAL(S) / GRANT (S)..... 6
- 1.3 TEST METHODOLOGY..... 6
- 1.4 TEST FACILITY..... 6
- 1.5 MEASUREMENT INSTRUMENTS..... 6
- 1.6 SPECIAL ACCESSORIES..... 6
- 1.7 EQUIPMENT MODIFICATIONS 7
- 2. SYSTEM TEST CONFIGURATION8
- 2.1 EUT CONFIGURATION..... 8
- 2.2 EUT EXERCISE 8
- 2.3 GENERAL TECHNICAL REQUIREMENTS 8
- 2.4 CONFIGURATION OF EUT SYSTEM..... 9
- 3. SUMMARY OF TEST RESULTS 10
- 4. DESCRIPTION OF TEST MODES 10
- 5. OUTPUT POWER..... 11
- 5.1 Conducted Output Power..... 11
- 5.2 Radiated Output Power..... 14
- 6. SPURIOUS EMISSION..... 17
- 6.1 CONDUCTED SPURIOUS EMISSION..... 17
- 6.2 Radiated Spurious Emission 19
- 7. FREQUENCY STABILITY 23

7.1 MEASUREMENT METHOD	23
7.2 PROVISIONS APPLICABLE.....	23
7.3 MEASUREMENT RESULT	24
8. BANDWIDTH.....	26
8.1 APPLICABLE STANDARD	26
8.2 Test Procedure.....	26
8.3 MEASUREMENT RESULT	26
9. BAND EDGE	28
9.1 Applicable Standard	28
9.2 Test Procedure.....	28
9.3 MEASUREMENT RESULT	28
10. PEAK-TO-AVERAGE RATIO	29
10.1 MEASURING INSTRUMENTS	29
10.2 TEST PROCEDURES	29
10.3 TEST SETUP	29
10.4 TEST RESULT OF PEAK-TO-AVERAGE RATIO	30
TEST PLOTS FOR CONDUCTED SPURIOUS EMISSION	31
TEST PLOTS FOR OCCUPIED BANDWIDTH (99%).....	38
APPENDIX III.....	43
TEST PLOTS FOR BAND EDGES	43
APPENDIX IV	46
PHOTOGRAPHS OF TEST SETUP	46

1. GENERAL INFORMATION

1.1 PRODUCT DESCRIPTION

A major technical description of EUT is described as following:

Product Designation:	Fingerprint smart terminal
Hardware version:	--
Software version:	--
Frequency Bands:	<input checked="" type="checkbox"/> GSM 850 <input checked="" type="checkbox"/> PCS 1900 (U.S. Bands) <input type="checkbox"/> GSM 900 <input type="checkbox"/> DCS 1800 (Non-U.S. Bands) U.S. Bands: <input type="checkbox"/> UMTS FDD Band II <input type="checkbox"/> UMTS FDD Band V Non-U.S. Bands: <input type="checkbox"/> UMTS FDD Band I <input type="checkbox"/> UMTS FDD Band VIII
Antenna:	FPCB Antenna
Antenna gain:	1.0 dBi
Battery parameter:	DC 3.7V, 10000mAh
Adapter Input:	100-240V~,50/60 Hz
Adapter Output:	5.0V ---,2000mA
GPRS/EDGE Class	Multi-Class12 Only 4 timeslots are used for GPRS
SIM CARD	The Phone Two SIM Card sockets
Extreme Vol. Limits:	DC3.5 V to 4.2V (Nominal DC3.7 V)
Extreme Temp. Tolerance	-10°C to +50°C
** Note: The High Voltage 4.2V and Low Voltage 3.5V was declared by manufacturer, The EUT couldn't be operate normally with higher or lower voltage.	

1.2 RELATED SUBMITTAL(S) / GRANT (S)

This submittal(s) (test report) is intended for **FCC ID:2AGUJ-BM5510** filing to comply with the FCC Part 22H&24E .

1.3 TEST METHODOLOGY

The radiated emission testing was performed according to the procedures of A TIA/EIA 603D and FCC CFR 47 Rules of 2.1046, 2.1047, 2.1049, 2.1051, 2.1053, 2.1055, 2.1057.

1.4 TEST FACILITY

The test site used to collect the radiated data is located at:
NTEK Testing Technology Co., Ltd.
1/F, Building E, Fenda Science Park, Sanwei Community, Xixiang Street, Bao'an District, Shenzhen P.R. China.
FCC Registration No.:238937
IC Registration No.:9270A-1,
CNAS Registration No.:L5516

1.5 MEASUREMENT INSTRUMENTS

NAME OF EQUIPMENT	MANUFACTURER	MODEL	SERIAL NUMBER	NEXT CAL. DATE
SPECTRUM ANALYZER	AGILENT	E4440A	US44300399	2016.7.06
TEST RECEIVER	R&S	ESCI	A0304218	2016.7.06
COMMUNICATION TESTER	AGILENT	8960	3104A03367	2016.7.06
COMMUNICATION TESTER	R&S	CMU200	A0304247	2016.7.06
TEST RECEIVER	R&S	FCKL1528	A0304230	2016.7.06
LISN	SCHWARZBECK	NSLK8127	A0304233	2016.7.06
CLIMATE CHAMBER	ALBATROSS	--	--	2016.7.06
Biological Antenna (30~1000MHz)	A.H. Systems Inc.	SAS-521-4	VULB9168-438	2016.7.06
Biological Antenna (30~1000MHz)	A.H. Systems Inc.	SAS-521-4	VULB9168-439	2016.7.06
Horn Antenna (1000~18000MHz)	EM	EM-AH-10180	A052604	2016.7.06
Horn Antenna (1000~18000MHz)	EM	EM-AH-10180	A052605	2016.7.06

1.6 SPECIAL ACCESSORIES

The battery and the charger, earphone supplied by the applicant were used as accessories and being tested with EUT intended for FCC grant together.

1.7 EQUIPMENT MODIFICATIONS

Not available for this EUT intended for grant.

2. SYSTEM TEST CONFIGURATION

2.1 EUT CONFIGURATION

The EUT configuration for testing is installed on RF field strength measurement to meet the Commission's requirement and operating in a manner which intends to maximize its emission characteristics in a continuous normal application.

2.2 EUT EXERCISE

The Transmitter was operated in the maximum output power mode through Communication Tester. The TX frequency was fixed which was for the purpose of the measurements.

2.3 GENERAL TECHNICAL REQUIREMENTS

Item Number	Item Description		FCC Rules
1	Output Power	Conducted output power	22.913(a) / 24.232 (b)
		Radiated output power	
2	Spurious Emission	Conducted spurious emission	2.1051 / 22.917 / 24.238
		Radiated spurious emission	
3	Frequency Stability		2.1055 /24.235
4	Occupied Bandwidth		2.1049 (h)(i)
5	Emission Bandwidth		22.917(b) / 24.238 (b)
6	Band Edge		22.917(b) / 24.238 (b)
7	Peak-to-Average Ratio		24.232(d)

2.4 CONFIGURATION OF EUT SYSTEM

Fig. 2-1 Configuration of EUT System



Table 2-1 Equipment Used in EUT System

Item	Equipment	Model No.	ID or Specification	Note
1	Fingerprint smart terminal	BM5510	FCC ID:2AGUJ-BM5510	EUT

*Note: All the accessories have been used during the test.
the following "EUT" in setup diagram means EUT system.*

3. SUMMARY OF TEST RESULTS

Item Number	Item Description		FCC Rules	Result
1	Output Power	Conducted Output Power	22.913(a) / 24.232 (b)	Pass
		Radiated Output Power		
2	Spurious Emission	Conducted Spurious Emission	2.1051 / 22.917 / 24.238	Pass
		Radiated Spurious Emission		
3	Frequency Stability		2.1055 /24.235	Pass
4	Occupied Bandwidth		2.1049 (h)(i)	Pass
5	Emission Bandwidth		22.917(b) / 24.238 (b)	Pass
6	Band Edge		22.917(b) / 24.238 (b)	Pass

4. DESCRIPTION OF TEST MODES

During the testing, the EUT was controlled via Rhode & Schwarz Digital Radio Communication Tester (CMU 200) to ensure max power transmission and proper modulation. Three channels (The top channel, the middle channel and the bottom channel) were chosen for testing on both GPRS850 and GPRS1900 frequency band.

Note: GSM/GPRS 850, GSM/GPRS 1900 modes have been tested during the test. the worst condition (GSM850, GSM1900) be recorded in the test report if no other modes test data.

5. OUTPUT POWER

5.1 Conducted Output Power

5.1.1 MEASUREMENT METHOD

The EUT was setup for the max output power with pseudo random data modulation. Power was measured with Spectrum Analyzer. The measurements were performed on all modes(GSM/GPRS 850, GSM/GPRS 1900) at 3 typical channels(the Top Channel, the Middle Channel and the Bottom Channel) for each band.

5.1.2 MEASUREMENT RESULT

GSM 850:

Mode	Frequency (MHz)	Maximum Burst-Average Output Power
GSM850	824.2	32.11
	836.6	32.16
	848.8	32.17
GPRS850 (1 Slot)	824.2	32.1
	836.6	32.15
	848.8	32.17
GPRS850 (2 Slot)	824.2	31.53
	836.6	31.52
	848.8	31.54
GPRS850 (3 Slot)	824.2	29.97
	836.6	30.02
	848.8	30.04
GPRS850 (4 Slot)	824.2	29.05
	836.6	29.01
	848.8	29.05
EGPRS850 (1 Slot)	824.2	27.07
	836.6	26.99
	848.8	26.92
EGPRS850 (2 Slot)	824.2	25.74
	836.6	25.76
	848.8	25.69
EGPRS850 (3 Slot)	824.2	23.49
	836.6	23.44
	848.8	23.37
EGPRS850 (4 Slot)	824.2	22.25
	836.6	22.23
	848.8	22.15

PCS 1900:

Mode	Frequency (MHz)	Maximum Burst-Average Output Power
GSM1900	1850.2	29.24
	1880	29.22
	1909.8	29.36
GPRS1900 (1 Slot)	1850.2	29.37
	1880	29.43
	1909.8	29.39
GPRS1900 (2 Slot)	1850.2	28.59
	1880	28.64
	1909.8	28.63
GPRS1900 (3 Slot)	1850.2	26.78
	1880	26.85
	1909.8	26.86
GPRS1900 (4 Slot)	1850.2	25.76
	1880	25.86
	1909.8	25.87
EGPRS1900 (1 Slot)	1850.2	25.4
	1880	25.49
	1909.8	25.48
EGPRS1900 (2 Slot)	1850.2	24.19
	1880	24.2
	1909.8	24.17
EGPRS1900 (3 Slot)	1850.2	21.83
	1880	21.81
	1909.8	21.74
EGPRS1900 (4 Slot)	1850.2	20.45
	1880	20.49
	1909.8	20.37

5.2 Radiated Output Power

5.2.1 MEASUREMENT METHOD

The measurements procedures specified in TIA-603D-2004 were applied.

- 1 In an anechoic antenna test chamber, a half-wave dipole antenna for the frequency band of interest is placed at the reference centre of the chamber. An RF Signal source for the frequency band of interest is connected to the dipole with a cable that has been constructed to not interfere with the radiation pattern of the antenna. A known (measured) power (P_{in}) is applied to the input of the dipole, and the power received (P_r) at the chamber's probe antenna is recorded.
- 2 The substitution method is used. Substitution values at each frequency are measured before and saved to the test software. A "reference path loss" is established as $AR_{pl} = P_{in} + 2.15 - P_r$. The AR_{pl} is the attenuation of "reference path loss", and including the gain of receive antenna, the cable loss and the air loss. The measurement results are obtained as described below: $Power = P_{Mea} + AR_{pl}$
- 3 The EUT is substituted for the dipole at the reference centre of the chamber and a scan is performed to obtain the radiation pattern.
- 4 From the radiation pattern, the co-ordinates where the maximum antenna gain occurs are identified.
- 5 The EUT is then put into continuously transmitting mode at its maximum power level.
- 6 Power mode measurements are performed with the receiving antenna placed at the coordinates determined in Step 3 to determine the output power as defined in Rule 24.232 (b) and (c). The "reference path loss" from Step1 is added to this result.
- 7 This value is EIRP since the measurement is calibrated using a half-wave dipole antenna of known gain (2.15 dBi) and known input power (P_{in}).
- 8 ERP can be calculated from EIRP by subtracting the gain of the dipole, $ERP = EIRP - 2.15dBi$.
9. Both horizontal and vertical antenna polarities were tested and performed pretest to three orthogonal axis. The worst case emissions were reported

5.2.2 PROVISIONS APPLICABLE

This is the test for the maximum radiated power from the EUT. Rule Part 24.232(b) specifies, "Mobile/portable stations are limited to 2 watts e.i.r.p. Peak power" and 24.232(c) specifies that "Peak transmit power must be measured over any interval of continuous transmission using instrumentation calibrated in terms of an rms-equivalent voltage." Rule Part 22.913(a) specifies "Maximum ERP. The effective radiated power (ERP) of base transmitters and cellular repeaters must not exceed 500 Watts. The ERP of mobile transmitters and auxiliary test transmitters must not exceed 7 Watts."

Mode	Nominal Peak Power
GSM 850	≤ 38.45 dBm (7W)
PCS 1900	≤ 33 dBm (2W)

5.2.3 MEASUREMENT RESULT

Radiated Power (ERP) for GSM 850 MHZ				
Mode	Frequency	Result		Conclusion
		Max. Peak ERP (dBm)	Polarization Of Max. ERP	
GSM850	824.2	31.52	Horizontal	Pass
	824.2	30.14	Vertical	Pass
	836.6	30.95	Horizontal	Pass
	836.6	30.01	Vertical	Pass
	848.8	30.26	Horizontal	Pass
	848.8	30.62	Vertical	Pass

Radiated Power (E.I.R.P) for PCS 1900 MHZ				
Mode	Frequency	Result		Conclusion
		Max. Peak E.I.R.P.(dBm)	Polarization Of Max. E.I.R.P.	
PCS1900	1850.2	29.65	Horizontal	Pass
	1850.2	29.14	Vertical	Pass
	1880	29.37	Horizontal	Pass
	1880	29.56	Vertical	Pass
	1909.8	29.67	Horizontal	Pass
	1909.8	29.01	Vertical	Pass

Radiated Power (ERP) for GPRS 850 MHZ				
Mode	Frequency	Result		Conclusion
		Max. Peak ERP (dBm)	Polarization Of Max. ERP	
GPRS850	824.2	29.14	Horizontal	Pass
	824.2	29.01	Vertical	Pass
	836.6	29.33	Horizontal	Pass
	836.6	28.97	Vertical	Pass
	848.8	29.24	Horizontal	Pass
	848.8	29.31	Vertical	Pass

Radiated Power (E.I.R.P) for GPRS 1900 MHZ				
Mode	Frequency	Result		Conclusion
		Max. Peak E.I.R.P.(dBm)	Polarization Of Max. E.I.R.P.	
GPRS 1900	1850.2	28.96	Horizontal	Pass
	1850.2	28.47	Vertical	Pass
	1880	28.11	Horizontal	Pass
	1880	27.94	Vertical	Pass
	1909.8	28.63	Horizontal	Pass
	1909.8	27.68	Vertical	Pass

6. SPURIOUS EMISSION

6.1 CONDUCTED SPURIOUS EMISSION

6.1.1 MEASUREMENT METHOD

The following steps outline the procedure used to measure the conducted emissions from the EUT.

1, Determine frequency range for measurements: From CFR 2.1057 the spectrum should be investigated from the lowest radio frequency generated in the equipment up to at least the 10th harmonic of the carrier frequency. For the equipment of PCS1900 band, this equates to a frequency range of 30 MHz to 19.1 GHz, data taken from 30 MHz to 20 GHz. For GSM850, data taken from 30 MHz to 9 GHz.

2, Determine EUT transmit frequencies: the following typical channels were chosen to conducted emissions testing.

Typical Channels for testing of GSM/GPRS 850 MHz	
Channel	Frequency (MHz)
128	824.2
190	836.6
251	848.8

Typical Channels for testing of PCS/ GPRS 1900 MHz	
Channel	Frequency (MHz)
512	1850.2
661	1880.0
810	1909.8

6.1.2 PROVISIONS APPLICABLE

On any frequency outside frequency band of the USPCS spectrum, the power of any emission shall be attenuated below the transmitter power (P, in Watts) by at least $43+10\text{Log}(P)$ dB. For all power levels +30 dBm to 0 dBm, this becomes a constant specification limit of -13 dBm.

6.1.3 MEASUREMENT RESULT

PLEASE REFER TO : APPENDIX I TEST PLOTS FOR CONDUCTED SPURIOUS EMISSION

- Note:**
1. Below 30MHZ no Spurious found and The GSM modes is the worst condition.
 2. As no emission found in standby or receive mode, no recording in this report.

6.2 Radiated Spurious Emission

6.2.1 MEASUREMENT METHOD

The measurements procedures specified in TIA-603D-2004 were used for testing. The spectrum was scanned from 30 MHz to the 10th harmonic of the highest frequency generated within the equipment. The resolution bandwidth is set 1MHz as outlined in Part 24.238. The measurements were performed on all modes(GSM850, PCS 1900,) at 3 typical channels(the Top Channel, the Middle Channel and the Bottom Channel) for each band.Only shown the worst data.

The procedure of radiated spurious emissions is as follows:

a) Pre-calibration With pre-calibration method, the Radiated Spurious Emissions(RSE) is calculated as, $RSE = R_x \text{ (dBuV)} + CL \text{ (dB)} + SA \text{ (dB)} + Gain \text{ (dBi)} - 107 \text{ (dBuV to dBm)}$ The SA is calibrated using following setup.

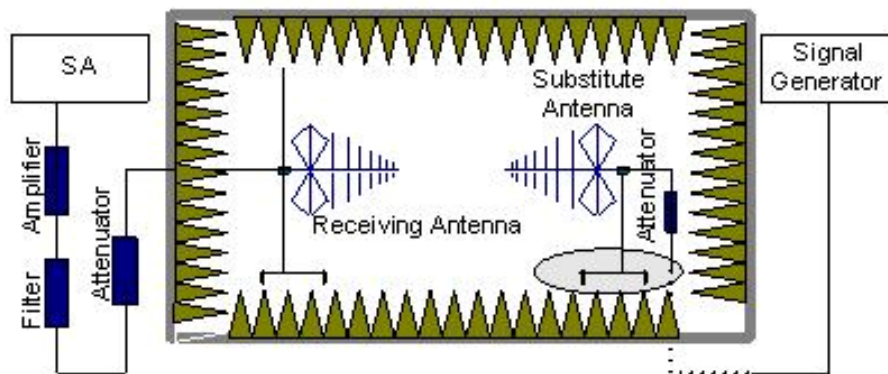

b) EUT was placed on a 0.8 meter high non-conductive stand at a 3 meter test distance from the receive antenna. A receiving antenna was placed on the antenna mast 3 meters from the test item for emission measurements. The height of receiving antenna is 0.8m. The test setup refers to figure below. Detected emissions were maximized at each frequency by rotating the test item and adjusting the receiving antenna polarization. The radiated emission measurements of all non-harmonic and harmonics of the transmit frequency through the 10th harmonic were measured with peak detector and 1MHz bandwidth.

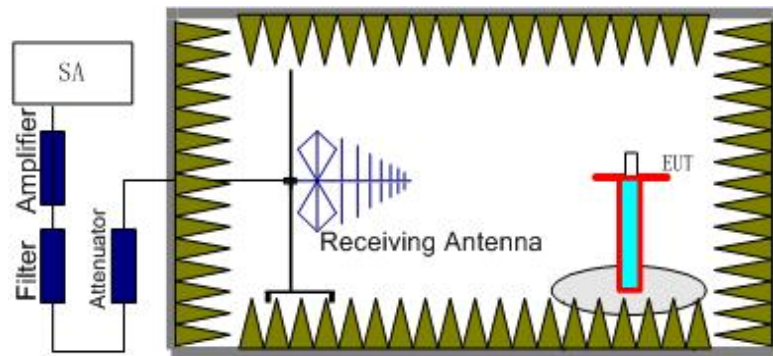

Radiated emissions measurements were made only at the upper, middle, and lower carrier frequencies of the PCS 1900 band (1850.2 MHz, 1880 MHz and 1909.8 MHz), GSM850 band (824.2MHz, 836.6MHz, 848.8MHz). It was decided that measurements at these three carrier frequencies would be sufficient to demonstrate compliance with emissions limits because it was seen that all the significant spurs occur well outside the band and no radiation was seen from a carrier in one block of any band into any of the other blocks.

The substitution method is used. Substitution values at each frequency are measured before and saved to the test software. A "reference path loss" is established and the A_{Rpl} is the attenuation of "reference path loss", and including the gain of receive antenna, the gain of the preamplifier, the cable loss and the air loss. The measurement results are obtained as described below: $Power = P_{Mea} + A_{Rpl}$

6.2.2 PROVISIONS APPLICABLE

(a) On any frequency outside a licensee's frequency block (e.g. A, D, B, etc.) within the USPCS spectrum, the power of any emission shall be attenuated below the transmitter power (P , in Watts) by at least $43 + 10 \log(P)$ dB. The specification that emissions shall be attenuated below the transmitter power (P) by at least $43 + 10 \log(P)$ dB, translates in the relevant power range (1 to 0.001 W) to -13 dBm. At 1 W the specified minimum attenuation becomes 43 dB and relative to a 30 dBm (1 W) carrier becomes a limit of -13 dBm. At 0.001 W (0 dBm) the minimum attenuation is 13 dB, which again yields a limit of -13 dBm. In this way a translation of the specification from relative to absolute terms is carried out.

Note: only result the worst condition of each test mode:

6.2.3 MEASUREMENT RESULT

GSM 850:

Test Results for Channel 128/824.2 MHz					
Frequency(MHz)	Power(dBm)	A _{Rpl} (dBm)	P _{Mea} (dBm)	Limit (dBm)	Polarity
1648.4	-31.25	7.8	-23.45	-13.00	Vertical
1648.4	-30.69	7.8	-22.89	-13.00	Horizontal
2472.6	-31.01	11	-20.01	-13.00	Vertical
2472.6	-29.97	11	-18.97	-13.00	Horizontal
3296.8	-30.02	12.3	-17.72	-13.00	Horizontal
3296.8	-29.67	12.3	-17.37	-13.00	Vertical
Test Results for Channel 190/836.6 MHz					
1673.2	-30.06	8	-22.06	-13.00	Vertical
1673.2	-31.64	8	-23.64	-13.00	Horizontal
2509.8	-29.01	11.2	-17.81	-13.00	Vertical
2509.8	-30.38	11.2	-19.18	-13.00	Horizontal
3346.4	-31.26	12.6	-18.66	-13.00	Horizontal
3346.4	-29.96	12.6	-17.36	-13.00	Vertical
Test Results for Channel 251/848.8 MHz					
1697.6	-30.14	8.1	-22.04	-13.00	Vertical
1697.6	-29.69	8.1	-21.59	-13.00	Horizontal
2546.4	-30.05	11.69	-18.36	-13.00	Vertical
2546.4	-29.97	11.69	-18.28	-13.00	Horizontal
3395.2	-29.98	12.92	-17.06	-13.00	Horizontal
3395.2	-29.11	12.92	-16.19	-13.00	Vertical

PCS 1900:

Test Results for Channel 512/1850.2MHz					
Frequency(MHz)	Power(dBm)	A _{Rpl} (dBm)	P _{Mea} (dBm)	Limit (dBm)	Polarity
3700.4	-35.62	13.42	-22.20	-13.00	Horizontal
3700.4	-34.14	13.42	-20.72	-13.00	Vertical
5550.6	-32.95	17.12	-15.83	-13.00	Vertical
5550.6	-33.64	17.12	-16.52	-13.00	Horizontal
7400.8	-34.15	19.26	-14.89	-13.00	Horizontal
7400.8	-34.87	19.26	-15.61	-13.00	Vertical
Test Results for Channel 661/1880.0MHz					
3760	-30.66	13.76	-16.9	-13.00	Horizontal
3760	-32.95	13.76	-19.19	-13.00	Vertical
5640	-34.14	17.56	-16.58	-13.00	Vertical
5640	-40.07	17.56	-22.51	-13.00	Horizontal
7520	-67.42	19.6	-47.82	-13.00	Horizontal
7520	-41.09	19.6	-21.49	-13.00	Vertical
Test Results for Channel 810/1909.8MHz					
3819.6	-40.14	13.87	-26.27	-13.00	Horizontal
3819.6	-35.29	13.87	-21.42	-13.00	Vertical
5729.4	-36.52	17.66	-18.86	-13.00	Vertical
5729.4	-34.78	17.66	-17.12	-13.00	Horizontal
7639.2	-36.57	19.75	-16.82	-13.00	Horizontal
7639.2	-40.15	19.75	-20.40	-13.00	Vertical

Note: Below 30MHz no Spurious found.

7. FREQUENCY STABILITY

7.1 MEASUREMENT METHOD

In order to measure the carrier frequency under the condition of AFC lock, it is necessary to make measurements with the EUT in a "call mode". This is accomplished with the use of R&S CMU200 DIGITAL RADIO COMMUNICATION TESTER.

- 1 , Measure the carrier frequency at room temperature.
- 2 , Subject the EUT to overnight soak at -10°C.
- 3 , With the EUT, powered via nominal voltage, connected to the CMU200 and in a simulated call on channel 661 for PCS 1900 band , channel 190 for GSM 850 band measure the carrier frequency. These measurements should be made within 2 minutes of Powering up the EUT, to prevent significant self-warming.
- 4 , Repeat the above measurements at 10°C increments from -10°C to +50°C. Allow at least 1 1/2 hours at each temperature, unpowered, before making measurements.
- 5 , Re-measure carrier frequency at room temperature with nominal voltage. Vary supply voltage from minimum voltage to maximum voltage, in 0.1Volt increments re-measuring carrier frequency at each voltage. Pause at nominal voltage for 1 1/2 hours unpowered, to allow any self-heating to stabilize, before continuing.
- 6 , Subject the EUT to overnight soak at +50°C.
- 7 , With the EUT, powered via nominal voltage, connected to the CMU200 and in a simulated call on the centre channel, measure the carrier frequency. These measurements should be made within 2 minutes of Powering up the EUT, to prevent significant self-warming.
- 8 , Repeat the above measurements at 10°C increments from +50°C to -10°C. Allow at least 1 1/2 hours at each temperature, unpowered, before making measurements.
- 9 , At all temperature levels hold the temperature to +/- 0.5°C during the measurement procedure.

7.2 PROVISIONS APPLICABLE

7.2.1 For Hand carried battery powered equipment

According to the JTC standard the frequency stability of the carrier shall be accurate to within 0.1 ppm of the received frequency from the base station. This accuracy is sufficient to meet Sec. 24.235, Frequency Stability. The frequency stability shall be sufficient to ensure that the fundamental emission stays within the authorized frequency block. As this transceiver is considered "Hand carried, battery powered equipment" Section 2.1055(d)(2) applies. This requires that the lower voltage for frequency stability testing be specified by the manufacturer. This transceiver is specified to operate with an input voltage of between 3.5VDC and 4.2VDC, with a nominal voltage of 3.7VDC. Operation above or below these voltage limits is prohibited by transceiver software in order to prevent improper operation as well as to protect components from overstress. These voltages represent a tolerance of -10 % and +12.5 %. For the purposes of measuring frequency stability these voltage limits are to be used.

7.2.2 For equipment powered by primary supply voltage

According to the JTC standard the frequency stability of the carrier shall be accurate to within 0.1 ppm of the received frequency from the base station. This accuracy is sufficient to meet Sec. 24.235, Frequency Stability. The frequency stability shall be sufficient to ensure that the fundamental emission stays within the authorized frequency block. For this EUT section 2.1055(d)(1) applies. This requires varying primary supply voltage from 85 to 115 percent of the nominal value for other than hand carried battery equipment, the normal environment temperature is 20°C.

7.3 MEASUREMENT RESULT

Frequency Error Against Voltage for GSM 850 band		
Voltage (V)	Frequency Error (Hz)	Frequency Error (ppm)
3.5	26	0.031
3.7	27	0.032
4.2	12	0.014

Frequency Error Against Temperature for GSM 850 band		
Temperature (°C)	Frequency Error (Hz)	Frequency Error (ppm)
-10	33	0.039
0	22	0.026
10	25	0.030
20	31	0.037
30	18	0.022
40	19	0.023
50	25	0.030

Note: The EUT doesn't work below -10°C

Frequency Error Against Voltage for PCS 1900 band		
Voltage (V)	Frequency Error (Hz)	Frequency Error (ppm)
3.5	34	0.018
3.7	36	0.019
4.2	28	0.015

Frequency Error Against Temperature for PCS 1900 band		
Temperature (°C)	Frequency Error (Hz)	Frequency Error (ppm)
-10	18	0.010
0	22	0.012
10	30	0.016
20	34	0.018
30	18	0.010
40	24	0.013
50	19	0.010

Note: The EUT doesn't work below -10°C

8. BANDWIDTH

8.1 APPLICABLE STANDARD

FCC §2.1049, §22.917, §22.905 and §24.238.

8.2 Test Procedure

1. The EUT was connected to Spectrum Analyzer and Base Station via power divider.
2. The 99% and 26 dB occupied bandwidth (BW) of the middle channel for the highest RF powers.
3. Details according with KDB 971168 section 4.1 & 4.2.

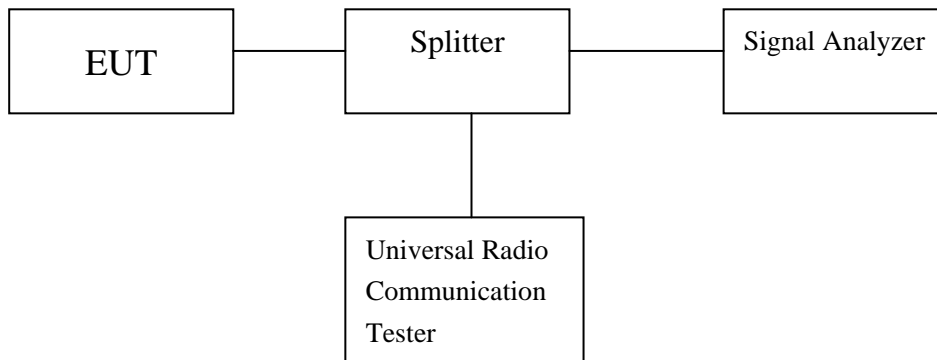

Test Equipment List and Details

Refer a test equipment and calibration data table in this test report.

8.3 MEASUREMENT RESULT

Occupied Bandwidth (99%) for GSM 850 band		
Mode	Frequency(MHz)	Occupied Bandwidth (99%)(kHz)
Low Channel	824.2	243.758
Middle Channel	836.6	244.921
High Channel	848.8	244.475

Occupied Bandwidth (99%) for PCS1900 band		
Mode	Frequency(MHz)	Occupied Bandwidth (99%)(kHz)
Low Channel	1850.2	247.217
Middle Channel	1880.0	247.329
High Channel	1909.8	246.733

Emission Bandwidth (-26dBc) for GSM 850 band		
Mode	Frequency(MHz)	Emission Bandwidth (-26dBc)(kHz)
Low Channel	824.2	317.420
Middle Channel	836.6	318.048
High Channel	848.8	312.865

Emission Bandwidth (-26dBc) for PCS 1900 band		
Mode	Frequency(MHz)	Emission Bandwidth (-26dBc)(kHz)
Low Channel	1850.2	319.993
Middle Channel	1880.0	312.829
High Channel	1909.8	316.999

9. BAND EDGE

9.1 Applicable Standard

According to § 22.917(a), the power of any emissions outside of the authorized operating frequency ranges must be attenuated below the transmitting power (P) by a factor of at least $43 + 10 \log(P)$ dB.

According to §24.238(a), the power of any emissions outside of the authorized operating frequency ranges must be attenuated below the transmitting power (P) by a factor of at least $43 + 10 \log(P)$ dB.

9.2 Test Procedure

1. The EUT was connected to Spectrum Analyzer and Base Station via power divider.
2. The Band Edges of low and high channels for the highest RF powers were measured. Setting RBW as roughly BW/100.
3. Details according with KDB 971168 section 6.0.

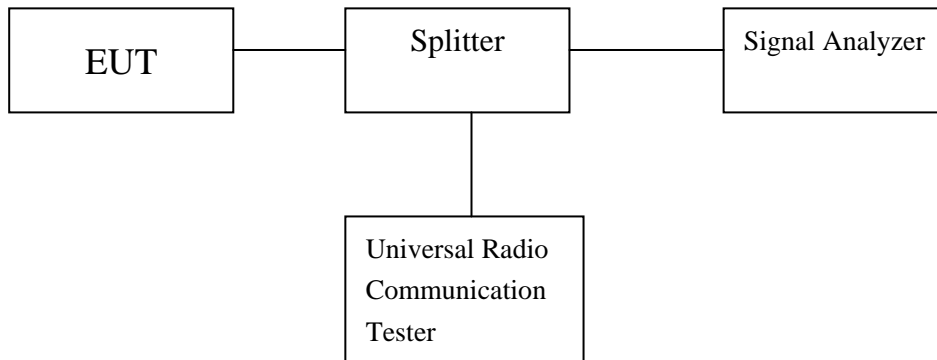

Test Equipment List and Details

Refer a test equipment and calibration data table in this test report.

9.3 MEASUREMENT RESULT

Please refers to Appendix III for compliance test plots for band edges

10. Peak-to-Average Ratio

DESCRIPTION OF THE PAR MEASUREMENT

The peak-to-average ratio (PAR) of the transmission may not exceed 13 dB.

10.1 MEASURING INSTRUMENTS

See list of measuring instruments of this test report.

10.2 TEST PROCEDURES

1. The EUT was connected to Spectrum Analyzer and Base Station via power divider.
2. The RF output of EUT was connected to the spectrum analyzer by RF cable and attenuator. The path loss was compensated to the results for each measurement.
3. For GSM/EGPRS operating modes:
 - a. Set the RBW = 1MHz, VBW = 1MHz, Peak detector in spectrum analyzer.
 - b. Set EUT in maximum power output, and triggered the burst signal.
 - c. Measured respectively the Peak level and Mean level, and the deviation was recorded as Peak to Average Ratio.

10.3 TEST SETUP

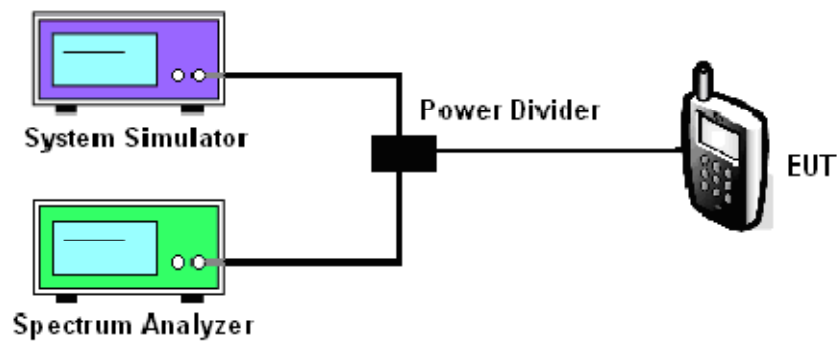

10.4 TEST RESULT OF PEAK-TO-AVERAGE RATIO

Cellular Band						
Modes	GSM850			GSM1900		
Channel	128 (Low)	190 (Mid)	251 (High)	512 (Low)	661 (Mid)	810 (High)
Frequency(MHz)	824.2	836.6	848.8	1850.2	1880	1909.8
Peak-to-Average Ratio (dB)	0.22	0.24	0.24	0.24	0.24	0.21

APPENDIX I

TEST PLOTS FOR CONDUCTED SPURIOUS EMISSION

CONDUCTED EMISSION IN GSM 850 BAND

Conducted Emission Transmitting Mode CH 128 30MHz – 5GHz

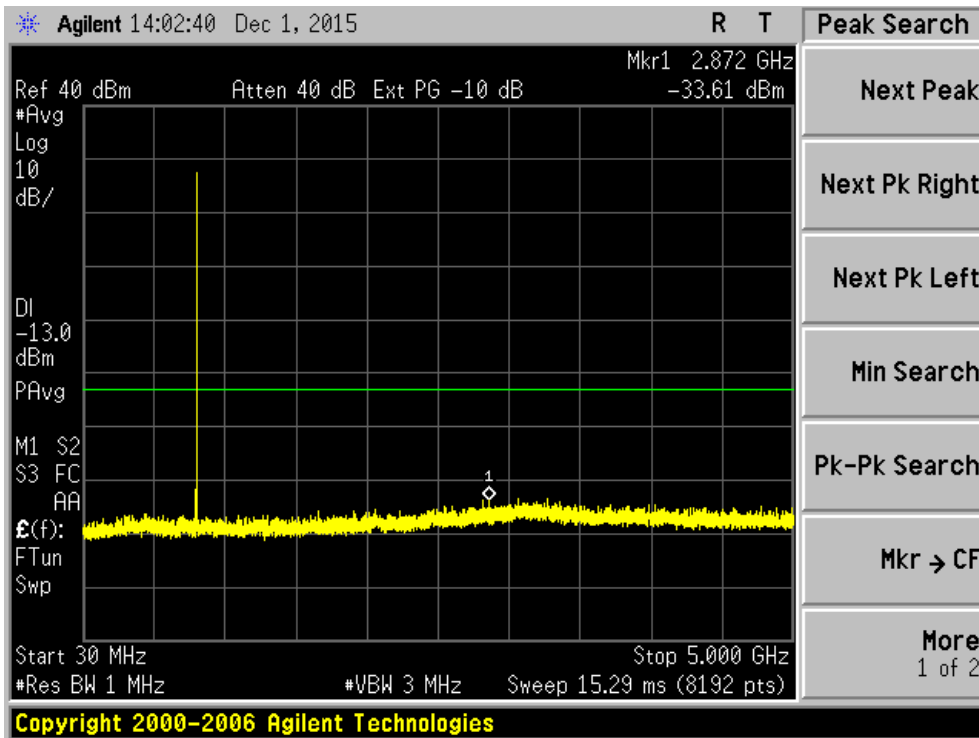

Conducted Emission Transmitting Mode CH 128 5GHz – 10GHz

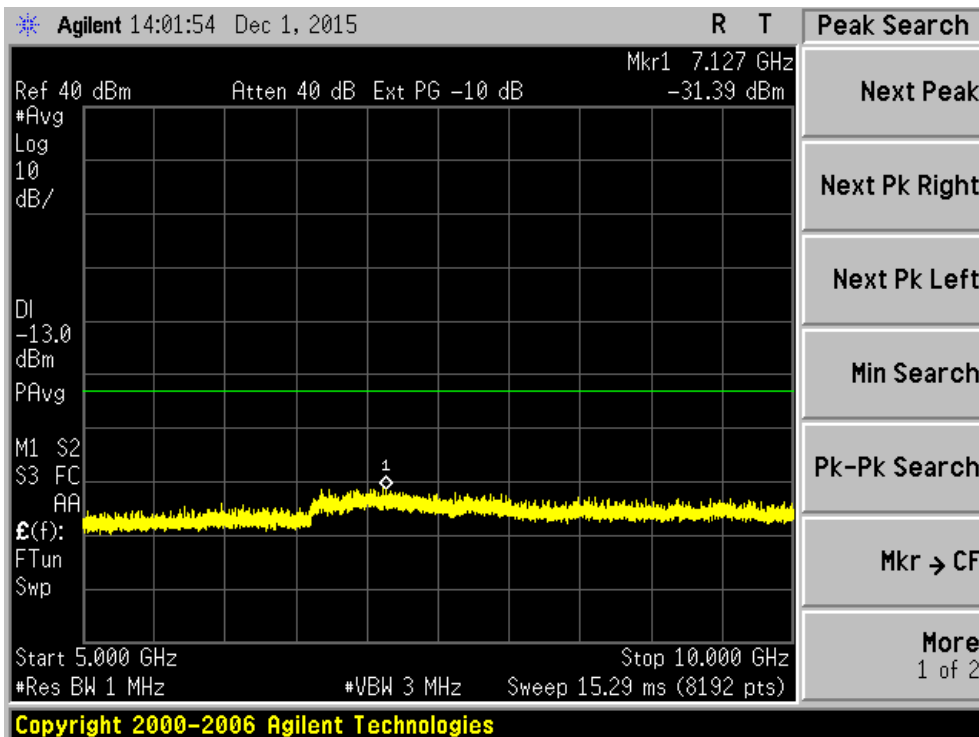

Conducted Emission Transmitting Mode CH 190 30MHz – 5GHz

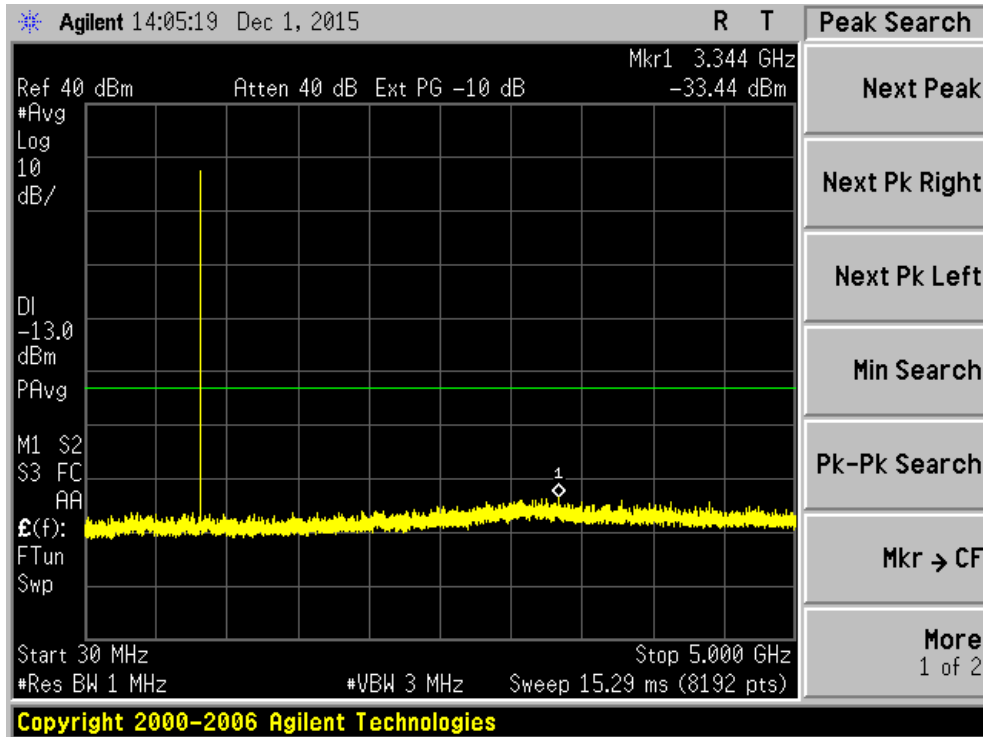

Conducted Emission Transmitting Mode CH 190 5GHz – 10GHz

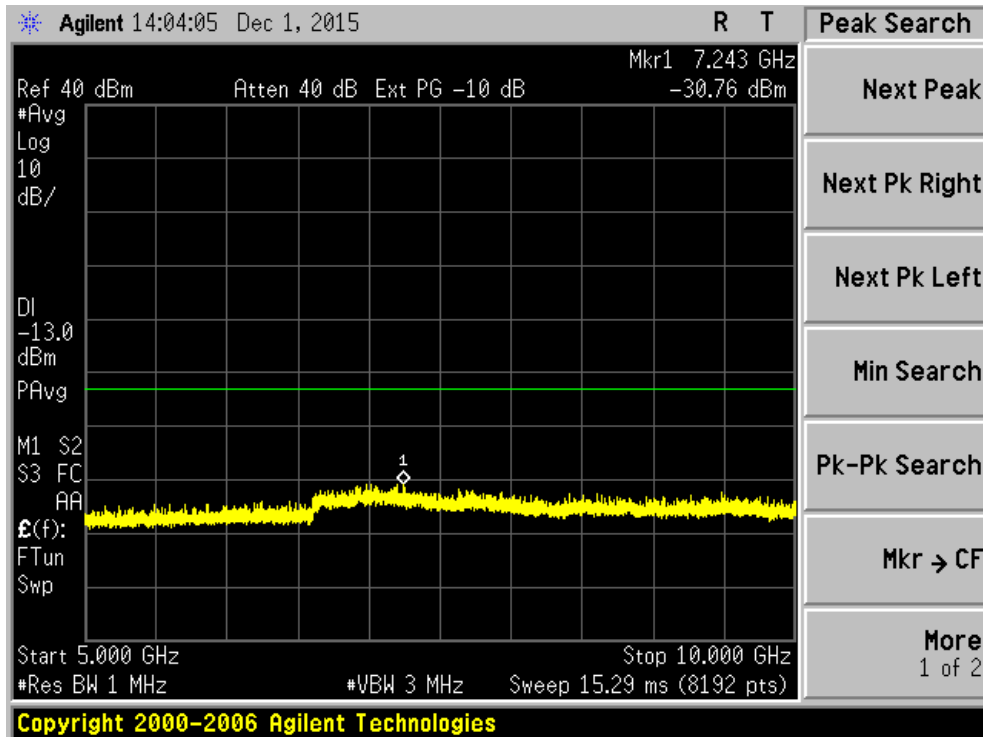

Conducted Emission Transmitting Mode CH 251 30MHz – 5GHz

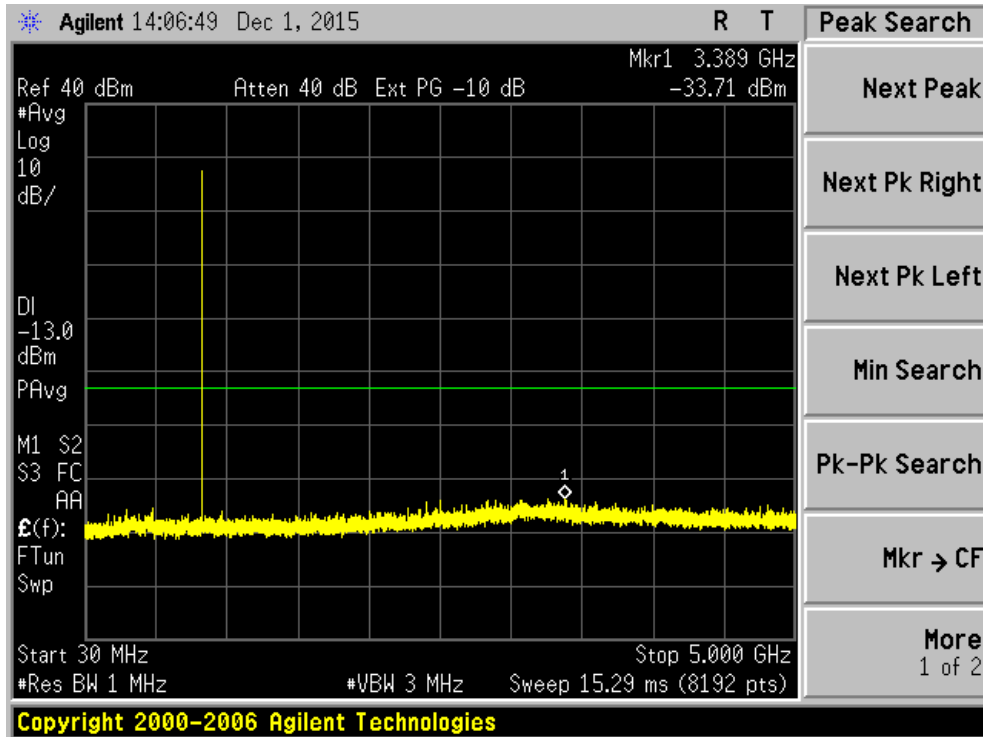

Conducted Emission Transmitting Mode CH 251 5GHz – 10GHz

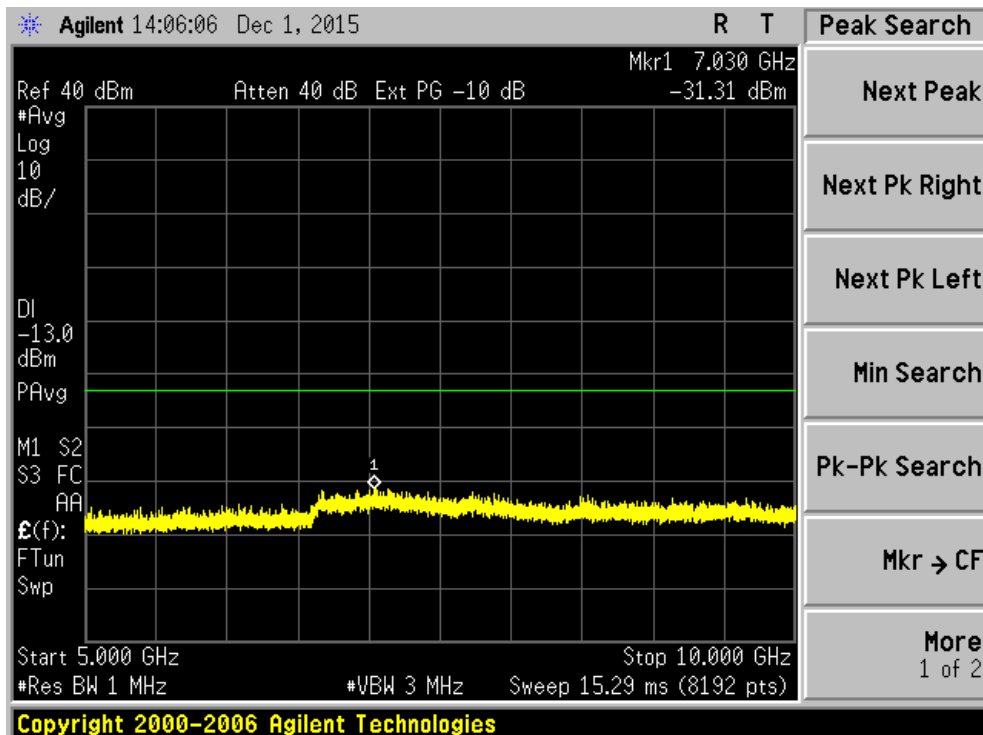

CONDUCTED EMISSION IN PCS1900 BAND
Conducted Emission Transmitting Mode CH 512 30MHz – 10GHz

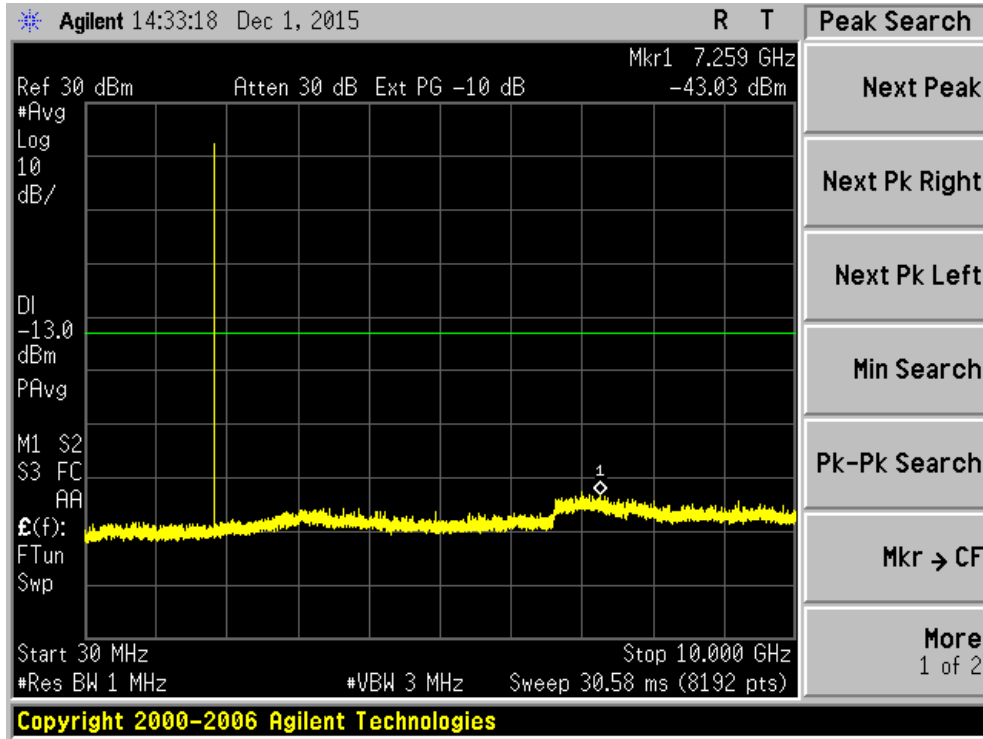

Conducted Emission Transmitting Mode CH 512 10GHz – 20GHz

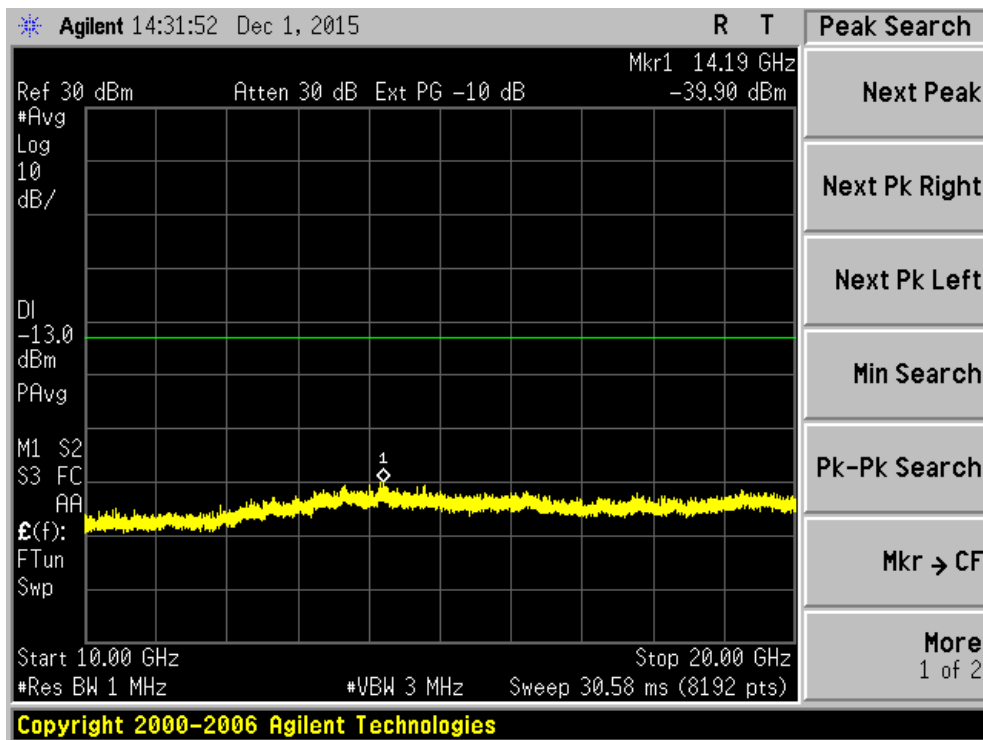

Conducted Emission Transmitting Mode CH 661 30MHz – 10GHz

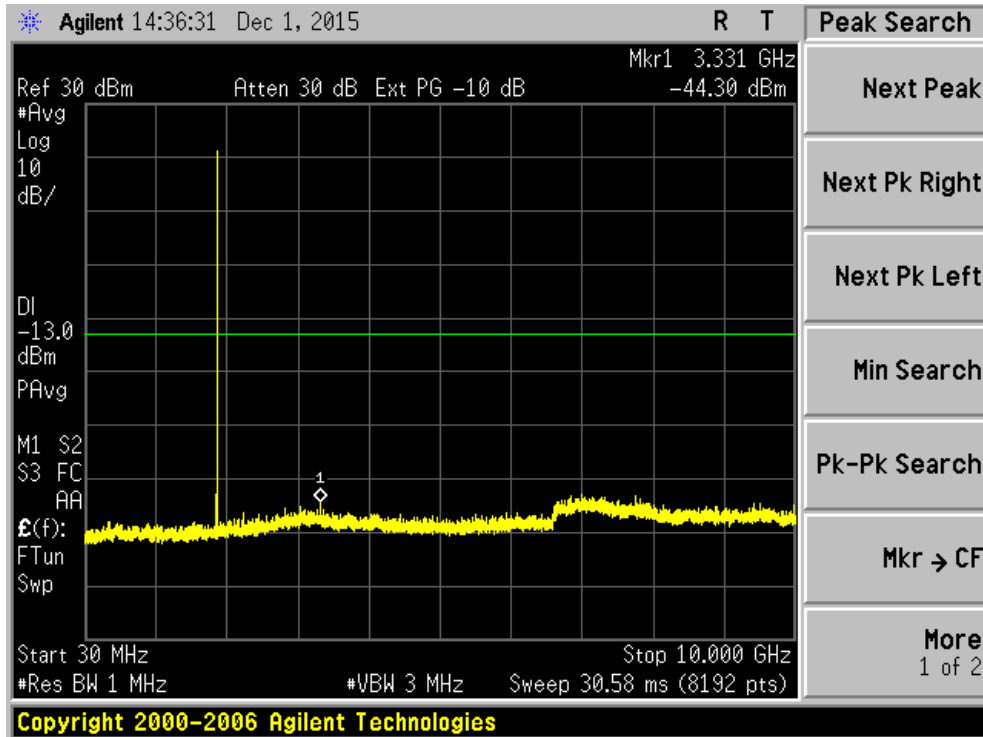

Conducted Emission Transmitting Mode CH 661 10GHz – 20GHz

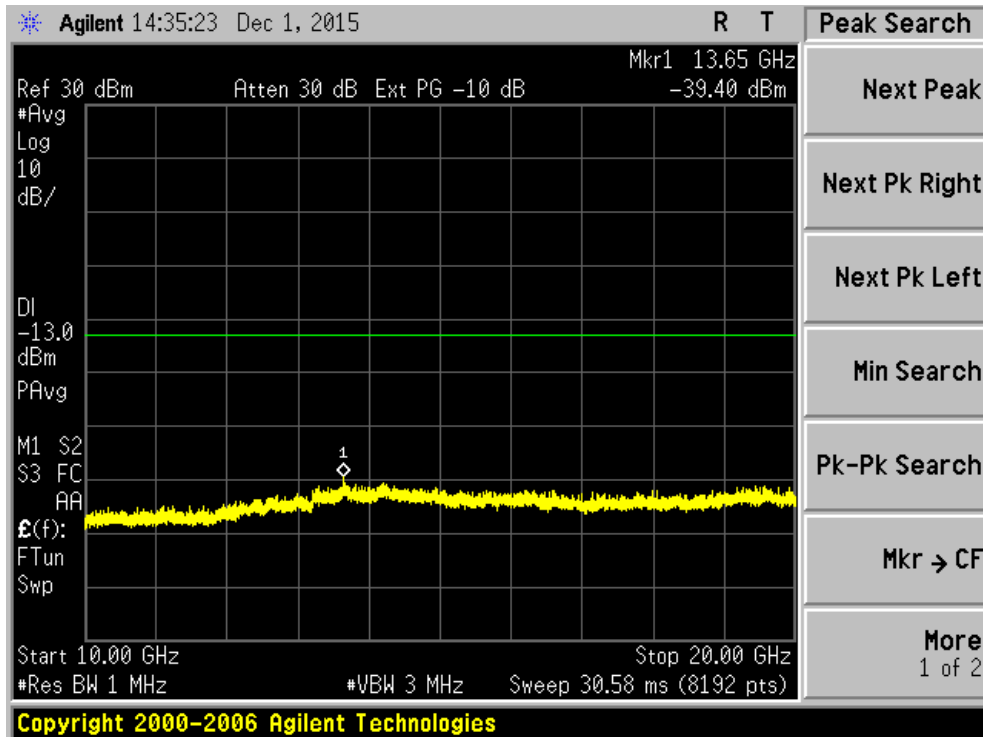

Conducted Emission Transmitting Mode CH 810 30MHz – 10GHz

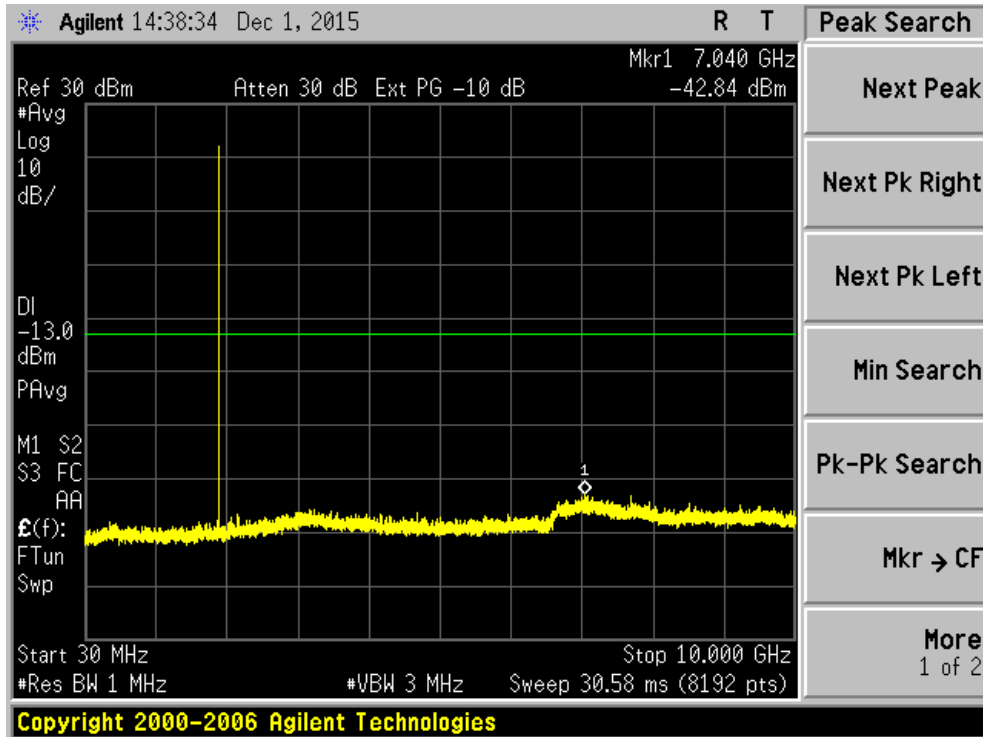

Conducted Emission Transmitting Mode CH 810 10GHz – 20GHz

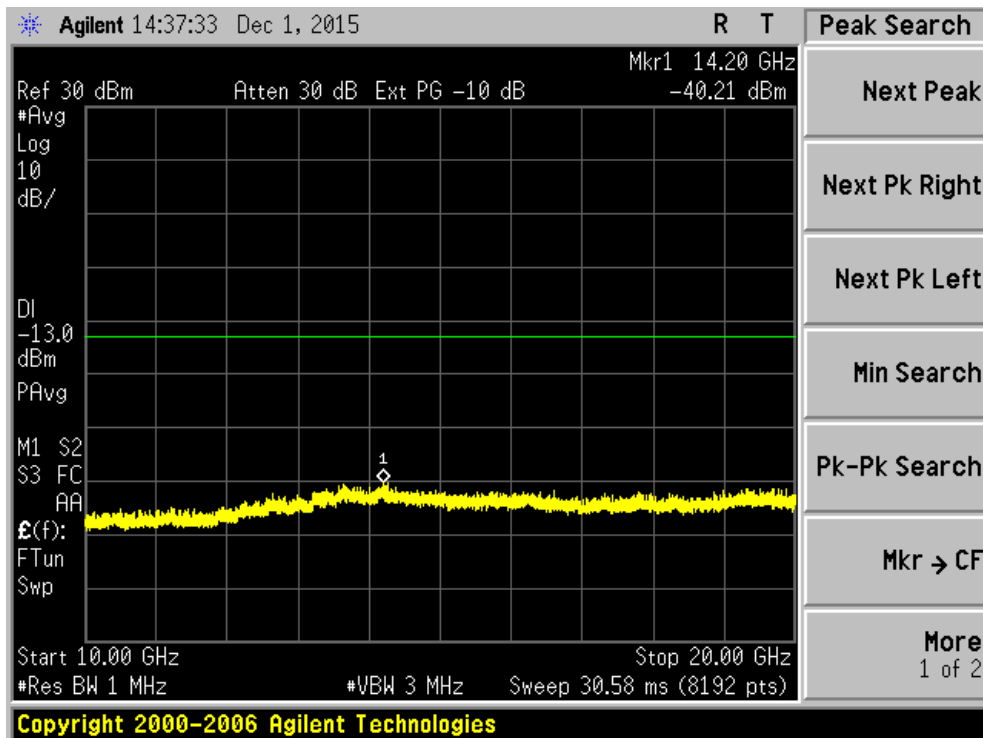

APPENDIX II
TEST PLOTS FOR OCCUPIED BANDWIDTH (99%)
EMISSION BANDWIDTH (-26dBC)

Occupied Bandwidth (99%) GSM 850 BAND CH 128

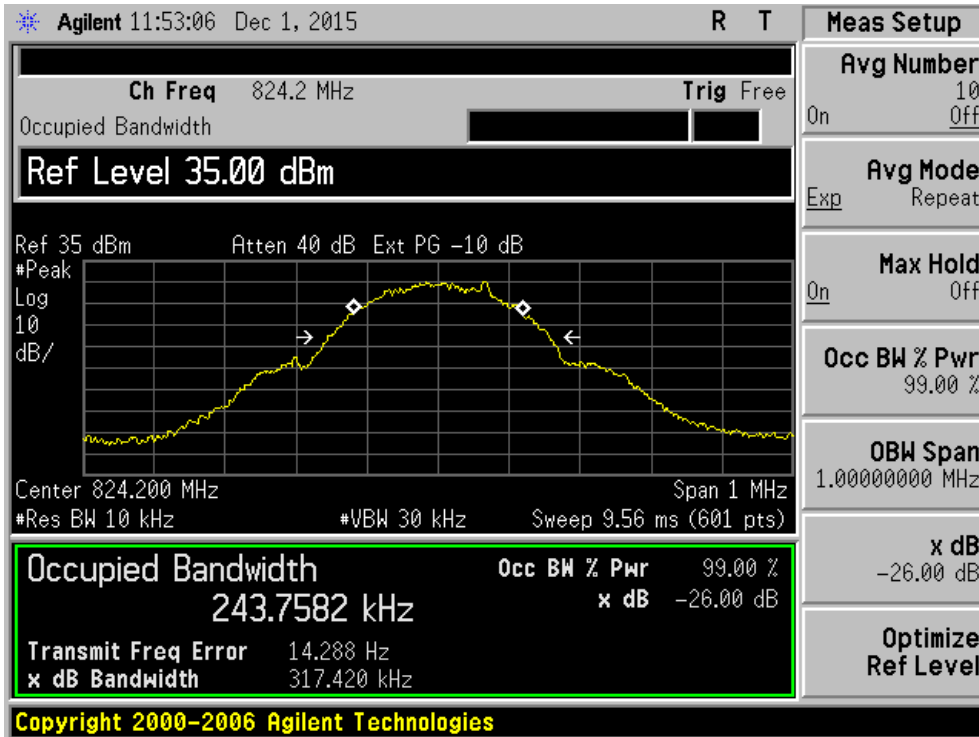

Occupied Bandwidth (99%) GSM 850 BAND CH 190

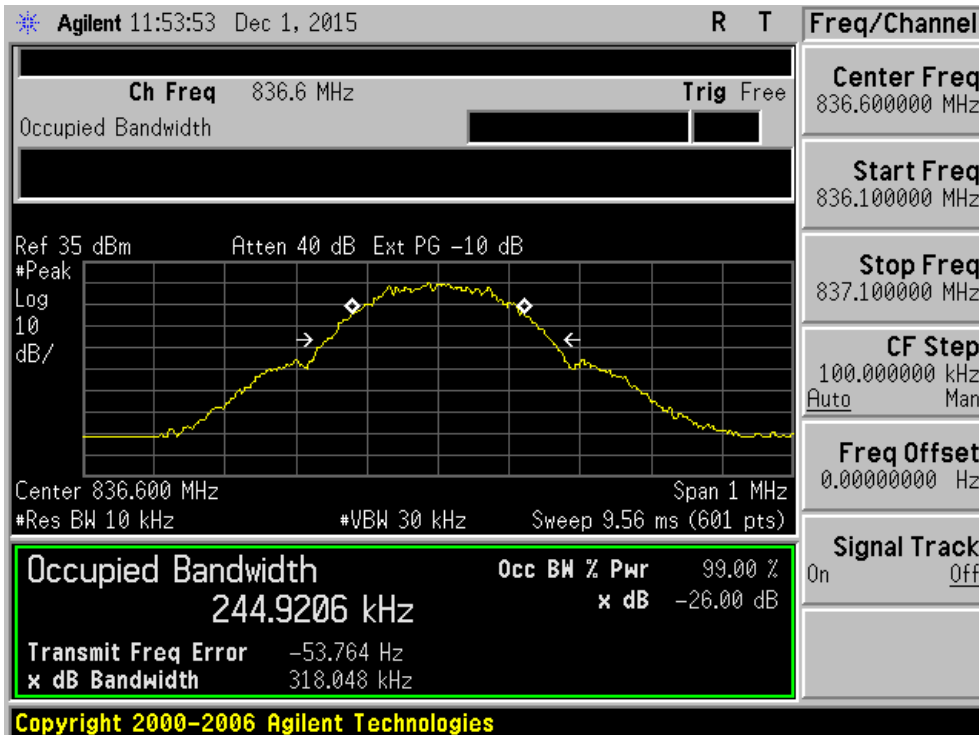

Occupied Bandwidth (99%) GSM 850 BAND CH 251

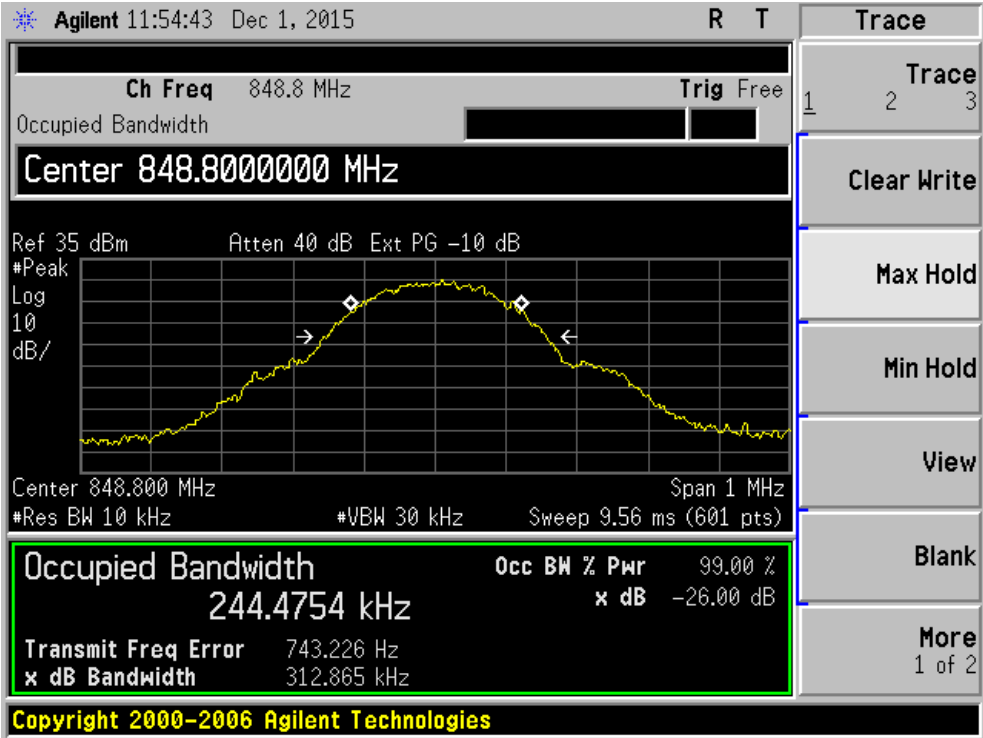

Occupied Bandwidth (99%) GSM 1900 BAND CH 512

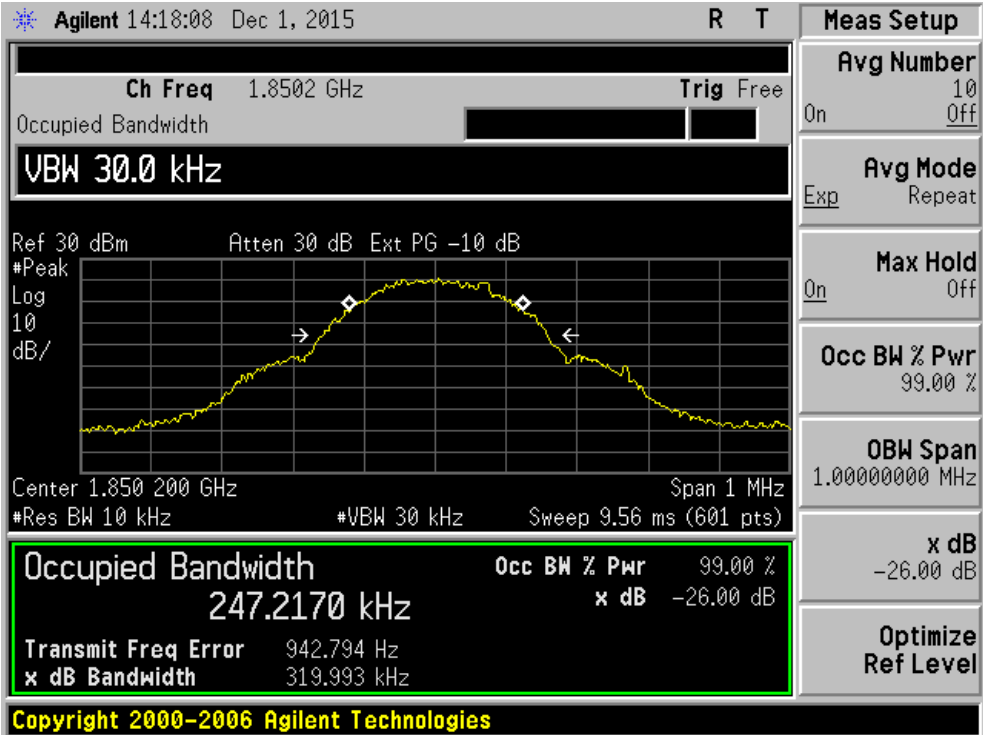

Occupied Bandwidth (99%) GSM 1900 BAND CH 661

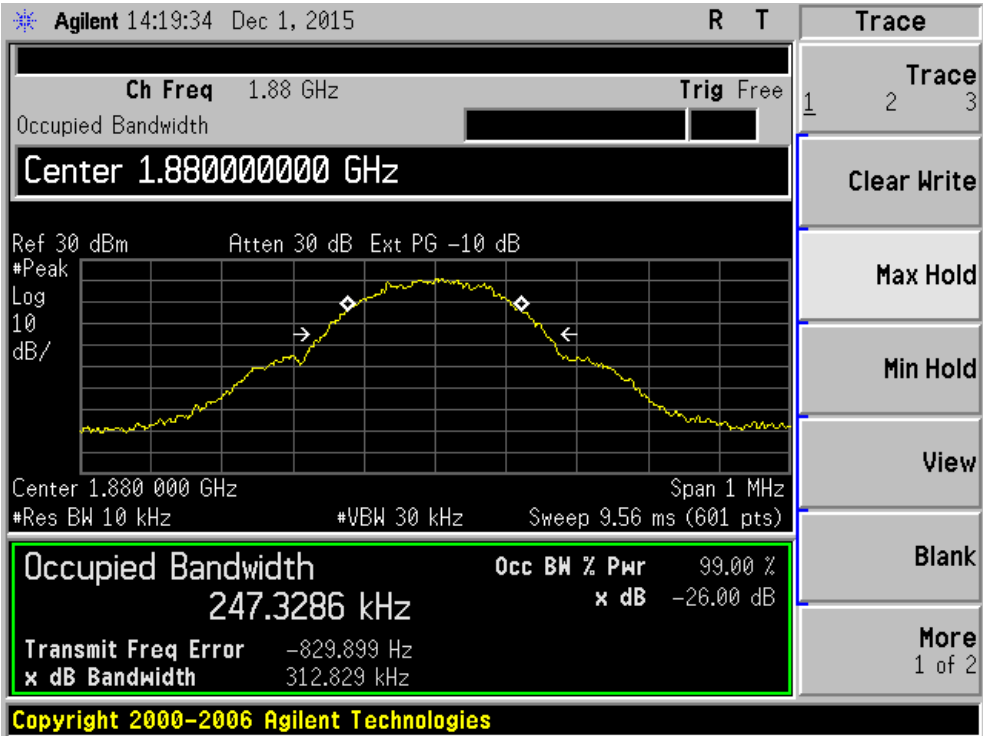

Occupied Bandwidth (99%) GSM 1900 BAND CH 810

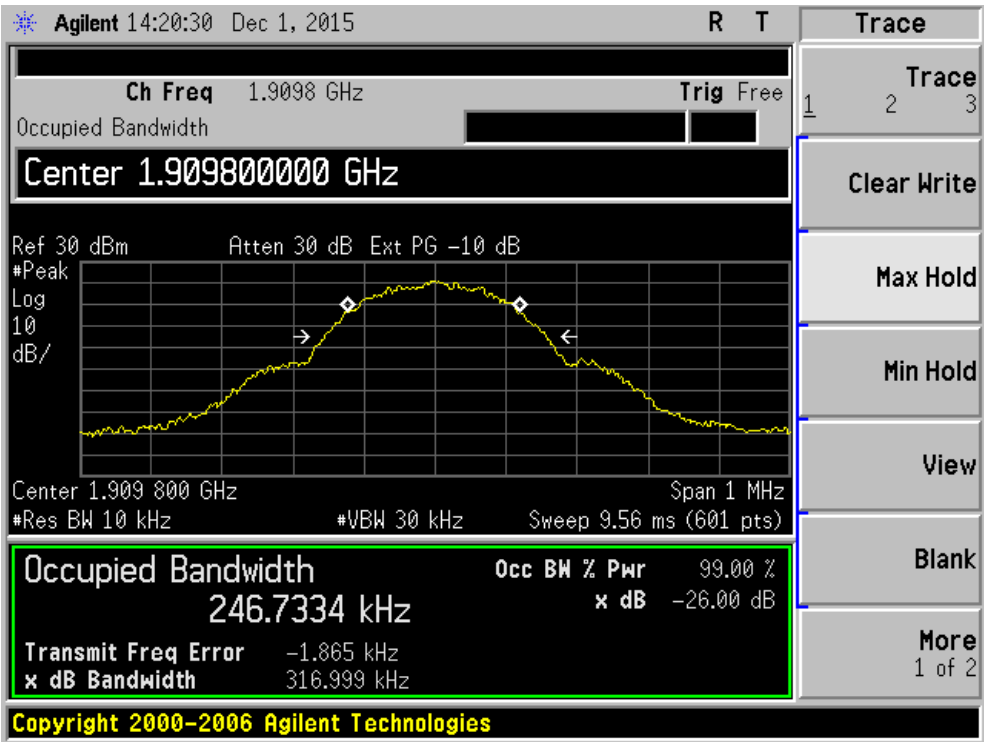

APPENDIX III
TEST PLOTS FOR BAND EDGES

Low Band Edge GSM 850 BAND CH 128

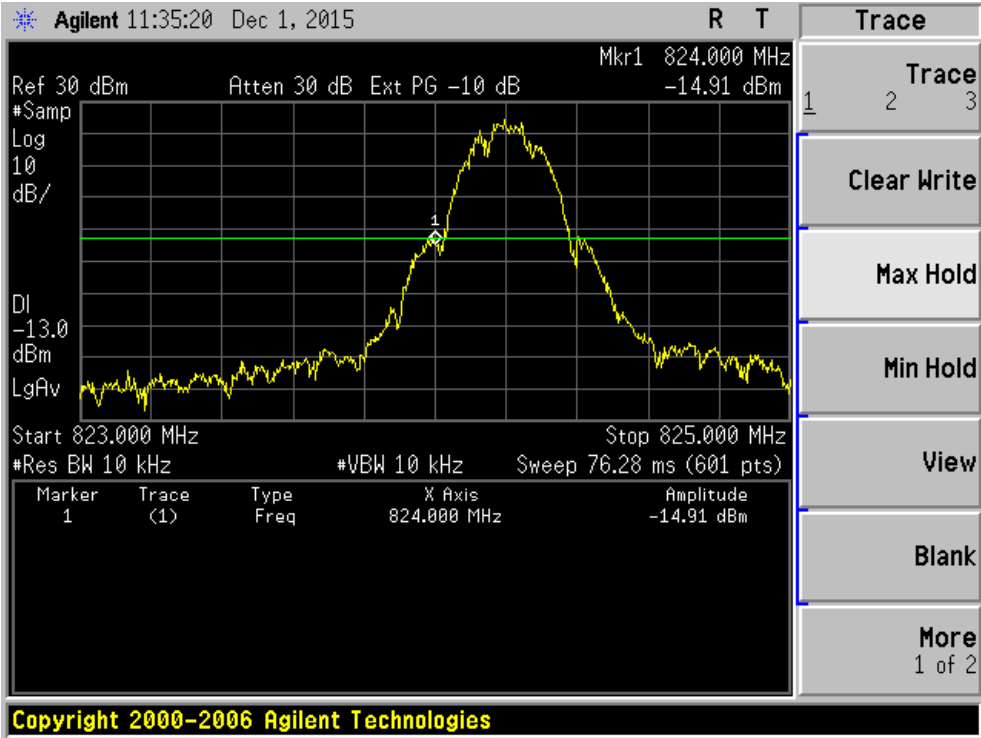

High Band Edge GSM 850 BAND CH 251

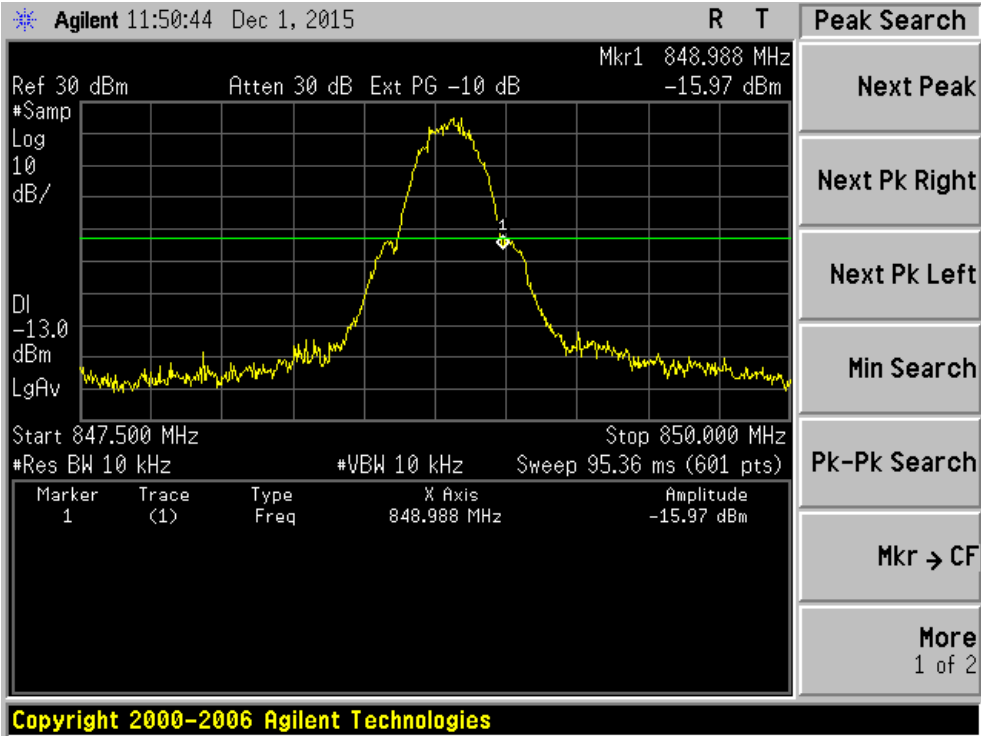

Low Band Edge GSM 1900 BAND CH 512

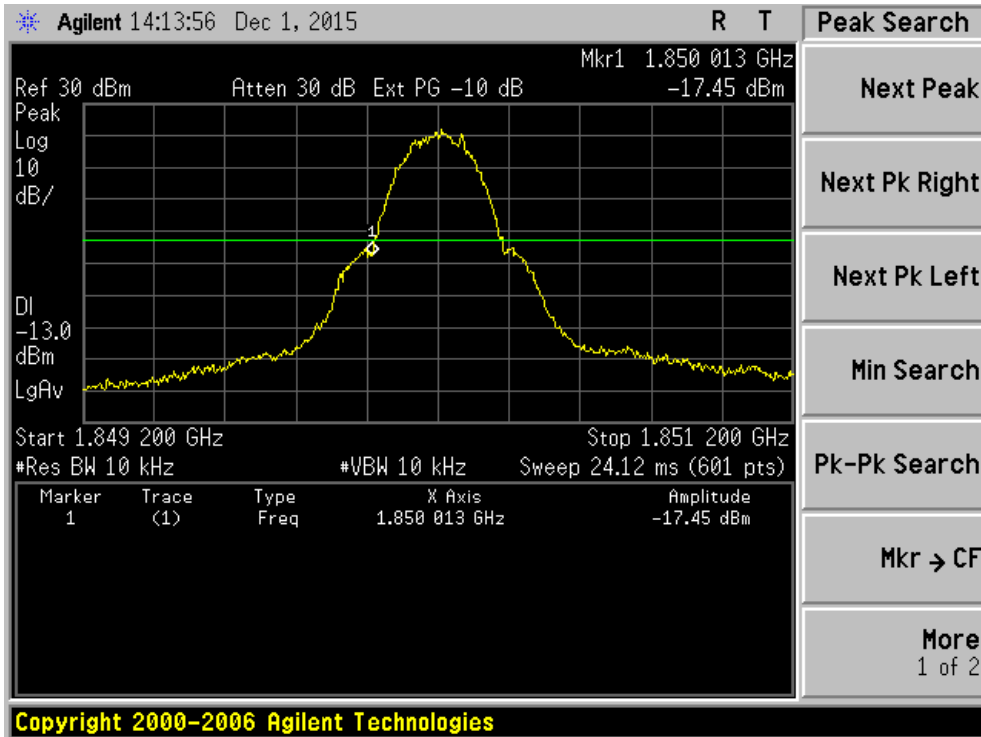

High Band Edge GSM 1900 BAND CH 810

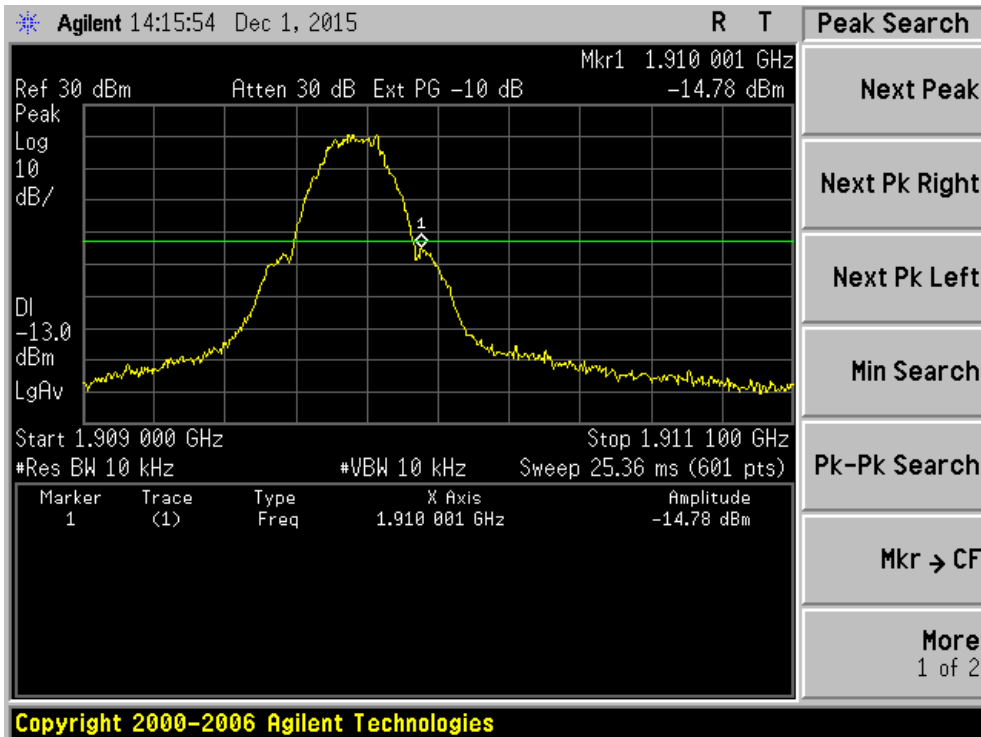

APPENDIX IV

PHOTOGRAPHS OF TEST SETUP

RADIATED SPURIOUS EMISSION

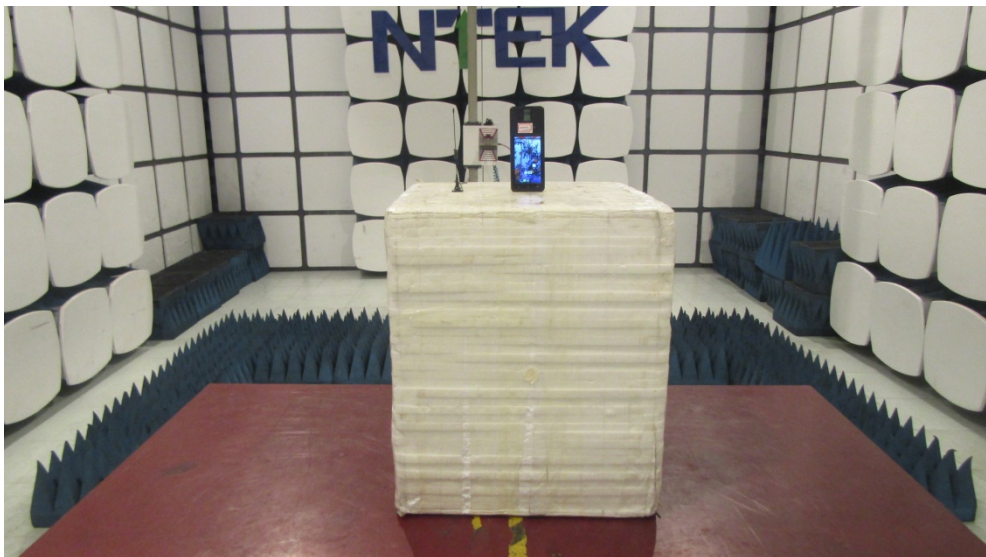
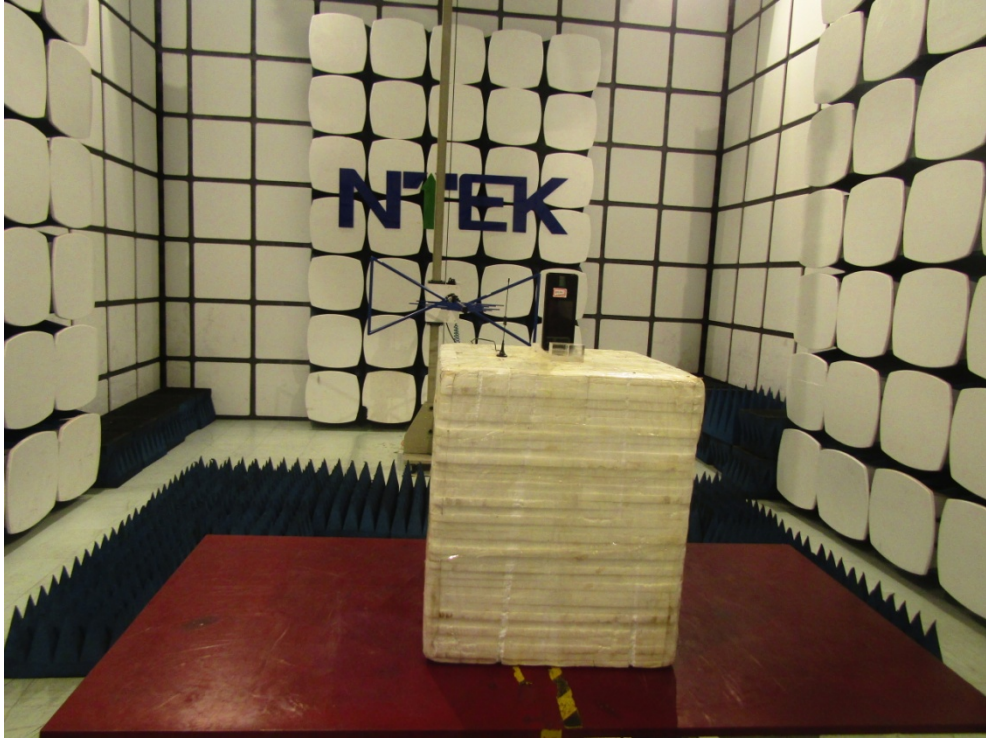

----END OF REPORT----