



FCC RADIO TEST REPORT

FCC ID: 2AGUJBM5510

Product: Fingerprint smart terminal

Trade Name:  Aratek

Model Number: BM5510

Serial Model: BM5500, BM5520, BM5530, VIU500-ATK100

Report No.: NTEK-2015NT1126170F4-01

Prepared for

ShenZhen Aratek Biometrics Technology Co.,Ltd.
2F,T2-A Building,ShenZhen Software Park,South Area,Hi-Tech
Park,ShenZhen,Guangdong,China

Prepared by

Shenzhen NTEK Testing Technology Co., Ltd.
1/F, Building E, Fenda Science Park, Sanwei Community,Xixiang Street
Bao'an District, Shenzhen P.R. China
Tel.: +86-0755-61156588 Fax.: +86-0755-61156599
Website:www.ntek.org.cn

TEST RESULT

Applicant's name: ShenZhen Aratek Biometrics Technology Co.,Ltd.
Address.....: 2F,T2-A Building,ShenZhen Software Park,South Area,Hi-Tech Park,ShenZhen,Guangdong,China
Manufacture's Name.....: ShenZhen Aratek Biometrics Technology Co.,Ltd.
Address.....: 2F,T2-A Building,ShenZhen Software Park,South Area,Hi-Tech Park,ShenZhen,Guangdong,China
Product name: Fingerprint smart terminal
Model and/or type reference: BM5510
Serial Model: BM5500, BM5520, BM5530, VIU500-ATK100
Standards: FCC Part 22H and 24E: 01 Oct. 2015
Test procedure: TIA/EIA 603D

This device described above has been tested by NTEK, and the test results show that the equipment under test (EUT) is in compliance with the FCC requirements. And it is applicable only to the tested sample identified in the report.

This report shall not be reproduced except in full, without the written approval of NTEK, this document may be altered or revised by NTEK, personnel only, and shall be noted in the revision of the document.

Date of Test

Date (s) of performance of tests..... 26 Nov. 2015 ~05 Nov. 2016

Date of Issue 05 Nov. 2016

Test Result **Pass**

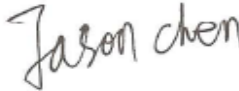
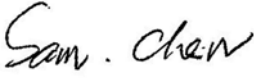
Testing Engineer : 
 (Eileen Liu)
Technical Manager : 
 (Jason Chen)
Authorized Signatory : 
 (Sam Chen)

Revision History

Revision	Issue Date	Revisions	Revised By
00	2016-11-05	Initial Issue	Sam Chen

Contents

1	<u>TEST STANDARDS.....</u>	5
2	<u>SUMMARY</u>	6
2.1	Product Description	6
2.2	Test frequency list	6
2.3	Short description of the Equipment under Test (EUT)	6
2.4	Block Diagram Showing the Configuration of Test System	7
2.5	General Test Conditions/Configurations	7
3	<u>TEST ENVIRONMENT.....</u>	8
3.1	Test Facility	8
3.2	Environmental conditions	8
3.3	Test Description	8
3.4	Measurement Uncertainty	9
3.5	Equipments Used during the Test	9
4	<u>TEST CONDITIONS AND RESULTS.....</u>	10
4.1	Output Power	10
4.2	Radiated Spurious Emission	15
4.3	Occupied Bandwidth and Emission Bandwidth	19
4.4	Band Edge Compliance	23
4.5	Spurious Emission on Antenna Port	26
4.6	Frequency Stability Test	34
4.7	Peak-to-Average Ratio (PAR)	37
5	<u>TEST SETUP PHOTOS OF THE EUT</u>	39
6	<u>EXTERNAL PHOTOS OF THE EUT.....</u>	40
7	<u>INTERNAL PHOTOS OF THE EUT.....</u>	40

1 TEST STANDARDS

The tests were performed according to following standards:

[FCC Part 22 Subpart H](#): PRIVATE LAND MOBILE RADIO SERVICES.

[FCC Part 24 Subpart E](#): PUBLIC MOBILE SERVICES

[TIA/EIA 603 D June 2010](#): Land Mobile FM or PM Communications Equipment Measurement and Performance Standards.

[47 CFR FCC Part 15 Subpart B](#): - Unintentional Radiators

[FCC Part 2](#): FREQUENCY ALLOCATIONS AND RADIO TREATY MATTERS; GENERAL RULES AND REGULATIONS

[ANSI C63.4:2014](#): Methods of Measurement of Radio-Noise Emissions from Low-Voltage Electrical and Electronic Equipment in the Range of 9 kHz to 40 GHz

[FCCKDB971168D01](#) Power Meas License Digital Systems

2 SUMMARY

2.1 Product Description

Product Designation:	Fingerprint smart terminal
Hardware version:	--
Software version:	--
Frequency Bands:	<input checked="" type="checkbox"/> GSM 850 <input checked="" type="checkbox"/> PCS 1900 (U.S. Bands) <input type="checkbox"/> GSM 900 <input type="checkbox"/> DCS 1800 (Non-U.S. Bands) U.S. Bands: <input checked="" type="checkbox"/> UMTS FDD Band II <input checked="" type="checkbox"/> UMTS FDD Band V Non-U.S. Bands: <input type="checkbox"/> UMTS FDD Band I <input type="checkbox"/> UMTS FDD Band VIII
Antenna:	FPCB Antenna
Antenna gain:	1.0 dBi
Battery parameter:	DC 3.7V, 10000mAh
Adapter Input:	100-240V~,50/60 Hz
Adapter Output:	5.0V---,2000mA
GPRS/EDGE Class	Multi-Class12
SIM CARD	The Phone Two SIM Card sockets
Extreme Vol. Limits:	DC 3.50 V to 4.20V (Nominal DC 3.70V)
Extreme Temp. Tolerance	-10°C to +50°C
** Note: The High Voltage 4.2V and Low Voltage 3.5V was declared by manufacturer, The EUT couldn't be operate normally with higher or lower voltage.	

2.2 Test frequency list

Test Mode	TX/RX	RF Channel		
		Low(L)	Middle (M)	High (H)
GSM850	TX	Channel 128	Channel 190	Channel 251
		824.2 MHz	836.6 MHz	848.8 MHz
	RX	Channel 128	Channel 190	Channel 251
		869.2 MHz	881.6 MHz	893.8 MHz
GSM1900	TX	Channel 512	Channel 661	Channel 810
		1850.2 MHz	1880.0 MHz	1909.8 MHz
	RX	Channel 512	Channel 661	Channel 810
		1930.2 MHz	1960.0 MHz	1989.8 MHz
WCDMA850	TX	Channel 4132	Channel 4183	Channel 4233
		826.4 MHz	836.6 MHz	846.6 MHz
	RX	Channel 4357	Channel 4407	Channel 4458
		871.4 MHz	881.4 MHz	891.6 MHz
WCDMA1900	TX	Channel 9262	Channel 9400	Channel 9538
		1852.4 MHz	1880.0 MHz	1907.6 MHz
	RX	Channel 9662	Channel 9800	Channel 9938
		1932.4 MHz	1960.0 MHz	1987.6 MHz

2.3 Short description of the Equipment under Test (EUT)

2.3.1 General Description

BM5510 is subscriber equipment in the WCDMA/GSM system. The HSPA/UMTS frequency band is Band I, Band II, Band V and Band VIII; The GSM/GPRS/EDGE frequency band includes GSM850 and GSM900 and DCS1800 and PCS1900, but only Band II, Band V, GSM850 and PCS1900 bands test data included in this report. BM5510 implements such functions as RF signal receiving/transmitting, HSPA/UMTS and GSM/GPRS/EDGE protocol processing, voice, video MMS service, GPS and WIFI etc. Externally it provides micro SD card interface, earphone port (to provide voice service) and SIM card interface. It also provides

Bluetooth module to synchronize data between a PC and the phone, or to use the built-in modem of the phone to access the Internet with a PC, or to exchange data with other Bluetooth devices.

NOTE: Unless otherwise noted in the report, the functional boards installed in the units shall be selected from the below list, but not means all the functional boards listed below shall be installed in one unit.

2.4 Block Diagram Showing the Configuration of Test System

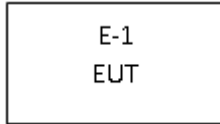

2.5 General Test Conditions/Configurations

2.5.1 Test Modes

NOTE: The test mode(s) are selected according to relevant radio technology specifications.

Test Mode	Test Modes Description
GSM/TM1	GSM system, GSM, GMSK modulation
GSM/TM2	GSM system, GPRS, GMSK modulation
GSM/TM3	GSM system, EDGE, 8DPSK modulation
UMTS/TM1	WCDMA system, QPSK modulation
UMTS/TM2	HSDPA system, QPSK modulation
UMTS/TM3	HSUPA system, QPSK modulation

Remark:

- As WCDMA, HSDPA and HSUPA with the same emission designator, test result recorded in this report at the worst case UMTS/TM1 only after exploratory scan.
- The GSM, GPRS with the same emission designator, test result recorded in this report at the worst case GSM/TM1 only after exploratory scan.
- GMSK modulation in EDGE same as in GPRS mode, not need measure EDGE in GMSK mode according to 3GPP TS 151 010;

2.5.2 Test Environment

Environment Parameter	Selected Values During Tests	
Relative Humidity	Ambient	
Temperature	TN	Ambient
Voltage	VL	3.50V
	VN	3.70V
	VH	4.20V

NOTE: VL=lower extreme test voltage VN=nominal voltage
 VH=upper extreme test voltage TN=normal temperature

3 TEST ENVIRONMENT

3.1 Test Facility

NTEK Testing Technology Co., Ltd

1/F, Building E, Fenda Science Park, Sanwei Community, Xixiang Street, Bao'an District, Shenzhen P.R. China.

There is one 3m semi-anechoic chamber and two line conducted labs for final test. The Test Sites meet the requirements in documents ANSI C63.4, CISPR 22/EN 55022 and CISPR16-4-1 SVSWR requirements.

FCC Registration No.:238937; IC Registration No.:9270A-1
 CNAS Registration No.:L5516

3.2 Environmental conditions

During the measurement the environmental conditions were within the listed ranges:

Temperature:	15-35 ° C
Humidity:	30-60 %
Atmospheric pressure:	950-1050mbar

3.3 Test Description

3.3.1 Cellular Band (824-849MHz paired with 869-894MHz)

Test Item	FCC Rule No.	Requirements	Verdict
Effective(Isotropic) Radiated Output Power	§2.1046, §22.913	FCC: ERP ≤ 7W.	Pass
Modulation Characteristics	§2.1047	Digital modulation	N/A
Bandwidth	§2.1049	OBW: No limit. EBW: No limit.	Pass
Band Edges Compliance	§2.1051, §22.917	≤-13dBm/1%*EBW, in 1MHz bands immediately outside and adjacent to The frequency block.	Pass
Spurious Emission at Antenna Terminals	§2.1051, §22.917	FCC: ≤ -13dBm/100kHz, from 9kHz to 10th harmonics but outside authorized operating frequency ranges.	Pass
Field Strength of Spurious Radiation	§2.1053, §22.917	FCC: ≤ -13dBm/100kHz.	Pass
Frequency Stability	§2.1055, §22.355	≤ ±2.5ppm.	Pass

NOTE 1: For the verdict, the "N/A" denotes "not applicable", the "N/T" de notes "not tested".

3.3.2 PCS Band (1850-1915MHz paired with 1930-1995MHz)

Test Item	FCC Rule No.	Requirements	Verdict
Effective(Isotropic) Radiated Output Power	§2.1046, §24.232	EIRP ≤ 2W	Pass
Peak-Average Ratio	§2.1046, §24.232	FCC:Limits≤13dB	Pass
Modulation Characteristics	§2.1047	Digital modulation	N/A
Bandwidth	§2.1049	OBW: No limit. EBW: No limit.	Pass
Band Edges Compliance	§2.1051, §24.238	≤ -13dBm/1%*EBW, In 1MHz bands immediately outside and adjacent to The frequency block.	Pass
Spurious Emission at Antenna Terminals	§2.1051, §24.238	≤-13dBm/1MHz, from 9kHz to10th harmonics but outside authorized Operating frequency ranges.	Pass
Field Strength of Spurious Radiation	§2.1053, §24.238	≤ -13dBm/1MHz.	Pass
Frequency Stability	§2.1055, §24.235	FCC: within authorized frequency block.	Pass

NOTE 1: For the verdict, the "N/A" denotes "not applicable", the "N/T" de notes "not tested".

Remark:

1. The measurement uncertainty is not included in the test result.

3.4 Measurement Uncertainty

The reported uncertainty of measurement $y \pm U$, where expended uncertainty U is based on a standard uncertainty multiplied by a coverage factor of $k=2$, providing a level of confidence of approximately 95 %.

No.	Item	Uncertainty
1	Conducted Emission Test	±1.38dB
2	RF power,conducted	±0.16dB
3	Spurious emissions,conducted	±0.21dB
4	All emissions,radiated(<1G)	±4.68dB
5	All emissions,radiated(>1G)	±4.89dB
6	Temperature	±0.5°C
7	Humidity	±2%

3.5 Equipments Used during the Test

Radiation Test equipment

Item	Kind of Equipment	Manufacturer	Type No.	Serial No.	Last calibration	Calibrated until	Calibration period
1	Spectrum Analyzer	Agilent	E4407B	MY45108040	2016/07/02	2017/07/01	1 year
2	Test Receiver	R&S	ESPI	101318	2016/07/02	2017/07/01	1 year
3	Bilog Antenna	TESEQ	CBL6111D	31216	2016/07/02	2017/07/01	1 year
4	50Ω Coaxial Switch	Anritsu	MP59B	6200264416	2016/07/02	2017/07/01	1 year
5	Communication Tester	R&S	CMU200	A0304247	2016/07/02	2017/07/01	1 year
6	Horn Antenna	EM	EM-AH-10180	2011071402	2016/07/02	2017/07/01	1 year
7	Horn Antenna	Schwarzbeck	BBHA 9170	9170-181	2016/07/02	2017/07/01	1 year
8	Amplifier	EM	EM-30180	060538	2015/12/18	2016/12/17	1 year
9	Loop Antenna	ARA	PLA-1030/B	1029	2016/07/02	2017/07/01	1 year
12	EMC Test Software	FALA	EZ	N/A	N/A	N/A	N/A

4 TEST CONDITIONS AND RESULTS

4.1 Output Power

TEST APPLICABLE

During the process of testing, the EUT was controlled via R&S Digital Radio Communication tester (CMU200) to ensure max power transmission and proper modulation. This result contains output power and EIRP measurements for the EUT. In all cases, output power is within the specified limits.

4.1.1 Conducted Output Power

TEST CONFIGURATION

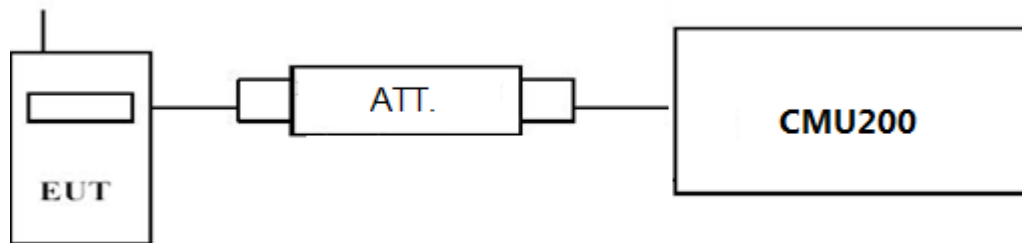

TEST PROCEDURE

Conducted Power Measurement:

- Place the EUT on a bench and set it in transmitting mode.
- Connect a low loss RF cable from the antenna port to a CMU200 by an Att.
- EUT Communicate with CMU200 then selects a channel for testing.
- Add a correction factor to the display CMU200, and then test.

TEST RESULTS

GSM850				
Function	Power step	Nominal output power (dBm)	Power & Multislot class	Operation class
GSM	5	33dBm(2W)	4	/
GPRS	3	33dBm(2W)	12	B
EDGE	8	27dBm(0.5W)	12	B

PCS1900				
Function	Power step	Nominal output power (dBm)	Power & Multislot class	Operation class
GSM	0	30dBm(1W)	1	/
GPRS	3	30dBm(1W)	12	B
EDGE	2	27dBm(0.5W)	12	B

See next page

GSM 850		Burst Average Conducted power (dBm)		
		Channel/Frequency(MHz)		
		128/824.2	190/836.6	251/848.8
GSM		32.11	32.16	32.17
GPRS (GMSK)	1TX slot	32.10	32.15	32.17
	2TX slot	31.53	31.52	31.54
	3TX slot	29.97	30.02	30.04
	4TX slot	29.05	29.01	29.05
EDGE (8PSK)	1TX slot	27.07	26.99	26.92
	2TX slot	25.74	25.76	25.69
	3TX slot	23.49	23.44	23.37
	4TX slot	22.25	22.23	22.15

UMTS Band II		Burst Average Conducted power (dBm)		
		Channel/Frequency(MHz)		
		512/1850.2	661/1880.0	810/1909.8
GSM		29.24	29.22	29.36
GPRS (GMSK)	1TX slot	29.37	29.43	29.39
	2TX slot	28.59	28.64	28.63
	3TX slot	26.78	26.85	26.86
	4TX slot	25.76	25.86	25.87
EDGE (8PSK)	1TX slot	25.40	25.49	25.48
	2TX slot	24.19	24.20	24.17
	3TX slot	21.83	21.81	21.74
	4TX slot	20.45	20.49	20.37

WCDMA Band V		Burst Average Conducted power (dBm)		
		Channel/Frequency(MHz)		
		4132/826.4	4183/836.6	4233/846.6
UMTS/TM1		22.69	22.78	22.98
UMTS/TM2	SubTest-1	21.27	21.69	21.51
	SubTest-2	21.25	21.74	21.46
	SubTest-3	21.16	21.35	21.14
	SubTest-4	21.09	21.29	21.11
UMTS/TM3	SubTest-1	21.58	22.01	21.86
	SubTest-2	21.55	21.98	21.81
	SubTest-3	21.53	22.04	21.93
	SubTest-4	21.49	21.96	21.74
	SubTest-5	21.13	21.35	21.16

WCDMA Band II		Burst Average Conducted power (dBm)		
		Channel/Frequency(MHz)		
		9262/1852.4	9400/1880.0	9538/1907.6
UMTS/TM1		21.69	22.56	21.99
UMTS/TM2	SubTest-1	20.31	21.43	20.88
	SubTest-2	20.29	21.41	20.93
	SubTest-3	20.12	21.24	20.35
	SubTest-4	20.09	21.18	20.36
UMTS/TM3	SubTest-1	20.43	21.30	20.82
	SubTest-2	20.41	21.29	20.88
	SubTest-3	20.40	21.35	20.83
	SubTest-4	20.39	21.42	20.78
	SubTest-5	21.01	21.56	21.26

4.1.2 Radiated Output Power

TEST DESCRIPTION

This is the test for the maximum radiated power from the EUT.

Rule Part 24.232(c) specifies, "Mobile/portable stations are limited to 2 watts e.i.r.p. Peak power" and 24.232(e) specifies that "Peak transmit power must be measured over any interval of continuous transmission using instrumentation calibrated in terms of an rms-equivalent voltage." Rule Part 22.913(a) specifies "The ERP of mobile transmitters and auxiliary test transmitters must not exceed 7 Watts."

TEST CONFIGURATION

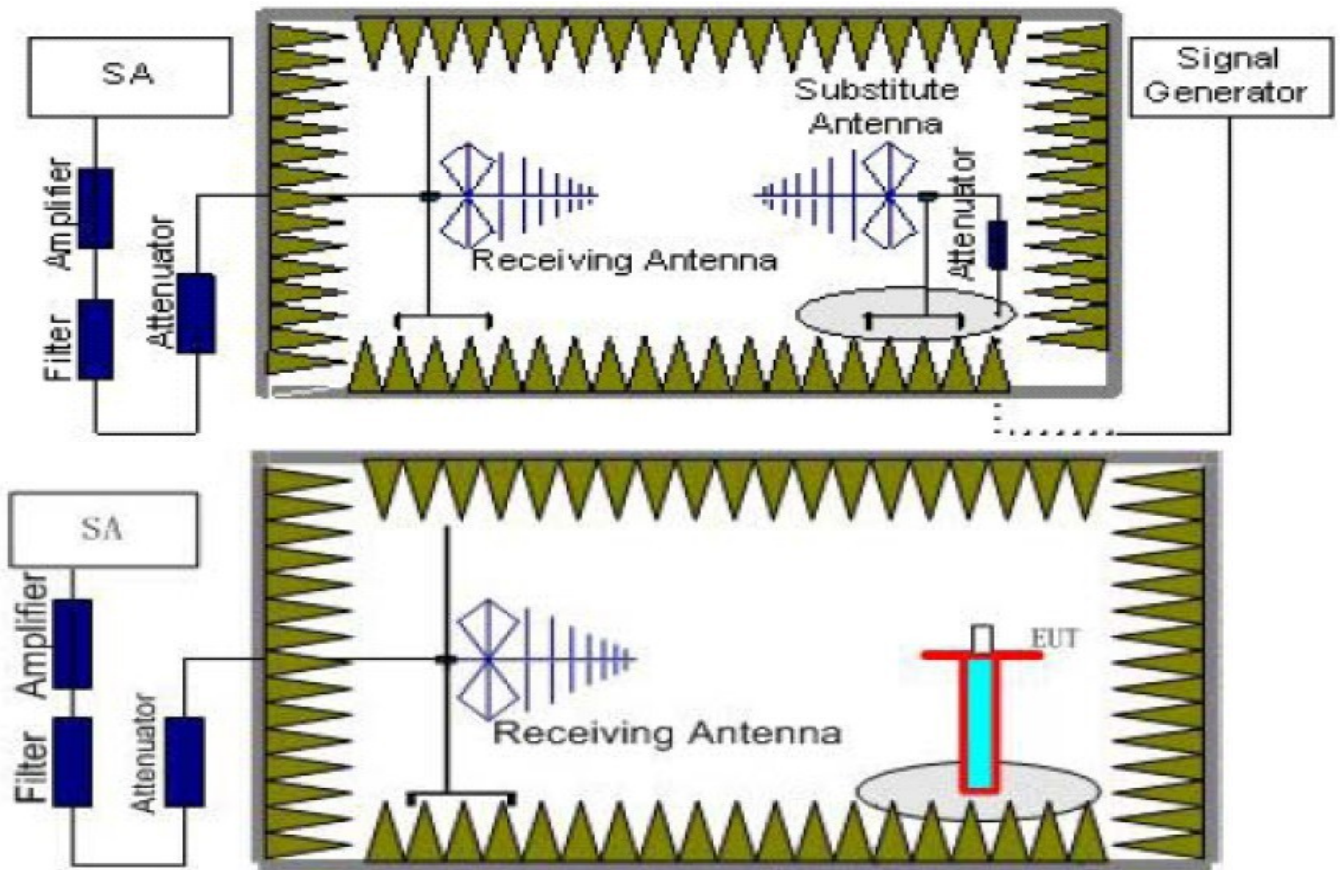

TEST PROCEDURE

1. EUT was placed on a 1.50 meter high non-conductive stand at a 3 meter test distance from the receive antenna. A receiving antenna was placed on the antenna mast 3 meters from the EUT for emission measurements. The height of receiving antenna is 1.50 meter. Detected emissions were maximized at each frequency by rotating the EUT through 360° and adjusting the receiving antenna polarization. The radiated emission measurements of all transmit frequencies in three channels (High, Middle, Low) were measured with peak detector.
2. A log-periodic antenna or double-ridged waveguide horn antenna shall be substituted in place of the EUT. The log-periodic antenna will be driven by a signal generator and the level will be adjusted till the same power value on the spectrum analyzer or receiver. The level of the spurious emissions can be calculated through the level of the signal generator, cable loss, the gain of the substitution antenna and the reading of the spectrum analyzer or receiver.
3. The EUT is then put into continuously transmitting mode at its maximum power level during the test. Set Test Receiver or Spectrum RBW=10MHz, VBW=10MHz, And the maximum value of the receiver should be recorded as (P_r).
4. The EUT shall be replaced by a substitution antenna. In the chamber, an substitution antenna for the frequency band of interest is placed at the reference point of the chamber. An RF Signal source for the frequency band of interest is connected to the substitution antenna with a cable that has been constructed to not interfere with the radiation pattern of the antenna. A power (P_{Mea}) is applied to the input of the substitution antenna, and adjust the level of the signal generator output until the value of the receiver

reach the previously recorded (P_r). The power of signal source (P_{Mea}) is recorded. The test should be performed by rotating the test item and adjusting the receiving antenna polarization.

5. A amplifier should be connected to the Signal Source output port. And the cable should be connect between the Amplifier and the Substitution Antenna. The cable loss (P_{cl}), the Substitution Antenna Gain (G_a) and the Amplifier Gain (P_{Ag}) should be recorded after test.

The measurement results are obtained as described below:

$$\text{Power(EIRP)} = P_{Mea} - P_{Ag} - P_{cl} + G_a$$

We used SMF100A microwave signal generator which signal level can up to 33dBm, so we not used power Amplifier for substitution test; The measurement results are amend as described below:

$$\text{Power(EIRP)} = P_{Mea} - P_{cl} + G_a$$

6. This value is EIRP since the measurement is calibrated using an antenna of known gain (2.15 dBi) and known input power.
7. ERP can be calculated from EIRP by subtracting the gain of the dipole, $ERP = EIRP - 2.15\text{dBi}$.

TEST LIMIT

According to 22.913(a), 24.232(c) the ERP(EIRP) should be not exceeding following table limits:

	Burst Average EIRP
UMTS Band II	≤33dBm (2W)
GSM	≤33dBm (2W)
GPRS	≤33dBm (2W)
EDGE	≤33dBm (2W)

	Burst Average ERP
UMTS Band V	≤38.45dBm (7W)
GSM	≤38.45dBm (7W)
GPRS	≤38.45dBm (7W)
EDGE	≤38.45dBm (7W)

TEST RESULTS

Remark:

1. We measured all Configuration refer 3GPP TS134 121 for UMTS and 3GPP TS 151 010 for GSM.
2. $EIRP = P_{Mea}(\text{dBm}) - P_{cl}(\text{dB}) + P_{Ag}(\text{dB}) + G_a(\text{dBi})$
3. $ERP = EIRP - 2.15\text{dBi}$ as EIRP by subtracting the gain of the dipole.
4. Margin = Emission Level – Limit
5. We test both Horizontal and Vertical direction, recorded worst case direction.

GSM/TM1/GSM850

Frequency (MHz)	P_{Mea} (dBm)	P_{cl} (dB)	G_a Antenna Gain(dB)	Correction (dB)	P_{Ag} (dB)	Burst Average ERP (dBm)	Limit (dBm)	Margin (dB)	Polarization
824.20	-2.07	5.16	5.79	2.15	35.11	31.52	38.45	-6.93	V
836.60	-2.61	5.22	5.79	2.15	35.14	30.95	38.45	-7.50	V
848.80	-2.99	5.24	5.81	2.15	35.19	30.62	38.45	-7.83	V

GSM/TM3/EDGE850

Frequency (MHz)	P_{Mea} (dBm)	P_{cl} (dB)	G_a Antenna Gain(dB)	Correction (dB)	P_{Ag} (dB)	Burst Average ERP (dBm)	Limit (dBm)	Margin (dB)	Polarization
824.20	-6.45	5.16	5.79	2.15	35.11	27.14	38.45	-11.31	V
836.60	-6.23	5.22	5.79	2.15	35.14	27.33	38.45	-11.12	V
848.80	-6.30	5.24	5.81	2.15	35.19	27.31	38.45	-11.14	V

GSM/TM1/GSM1900

Frequency (MHz)	P _{Mea} (dBm)	P _{cl} (dB)	G _a Antenna Gain(dB)	P _{Aq} (dB)	Burst Average EIRP (dBm)	Limit (dBm)	Margin (dB)	Polarization
1850.20	-9.48	6.19	9.13	36.19	29.65	33.01	-3.36	H
1880.00	-9.59	6.23	9.16	36.22	29.56	33.01	-3.45	H
1909.80	-9.46	6.28	9.18	36.23	29.67	33.01	-3.34	H

GSM/TM1/EDGE1900

Frequency (MHz)	P _{Mea} (dBm)	P _{cl} (dB)	G _a Antenna Gain(dB)	P _{Aq} (dB)	Burst Average EIRP (dBm)	Limit (dBm)	Margin (dB)	Polarization
1850.20	-12.17	6.19	9.13	36.19	26.96	33.01	-6.05	H
1880.00	-13.04	6.23	9.16	36.22	26.11	33.01	-6.90	H
1909.80	-12.50	6.28	9.18	36.23	26.63	33.01	-6.38	H

UMTS/TM1/UMTS Band II

Frequency (MHz)	P _{Mea} (dBm)	P _{cl} (dB)	G _a Antenna Gain (dB)	P _{Aq} (dB)	Burst Average EIRP (dBm)	Limit (dBm)	Margin (dB)	Polarization
1852.4	-17.04	6.19	9.13	36.19	22.09	33.01	-10.92	H
1880.0	-17.12	6.23	9.16	36.22	22.03	33.01	-10.98	H
1907.6	-17.12	6.28	9.18	36.23	22.01	33.01	-11.00	H

UMTS/TM1/UMTS Band V

Frequency (MHz)	P _{Mea} (dBm)	P _{cl} (dB)	G _a Antenna Gain (dB)	Correction (dB)	P _{Aq} (dB)	Burst Average ERP (dBm)	Limit (dBm)	Margin (dB)	Polarization
826.40	-11.94	5.16	5.79	2.15	35.11	21.65	38.45	-16.80	V
836.60	-11.62	5.22	5.79	2.15	35.14	21.94	38.45	-16.51	V
846.60	-12.18	5.24	5.81	2.15	35.19	21.43	38.45	-17.02	V

4.2 Radiated Spurious Emission

TEST APPLICABLE

According to the TIA/EIA 603D:2010 test method, The Receiver or Spectrum was scanned from 9 KHz to the 10th harmonic of the highest frequency generated within the equipment, which is the transmitted carrier that can be as high as 1910 MHz The resolution bandwidth is set as outlined in Part 24.238, Part 22.917. The spectrum is scanned with the mobile station transmitting at carrier frequencies that pertain to low, mid and high channels of WCDMA Band II / WCDMA Band V / GSM 850 / GSM 1900.

TEST CONFIGURATION

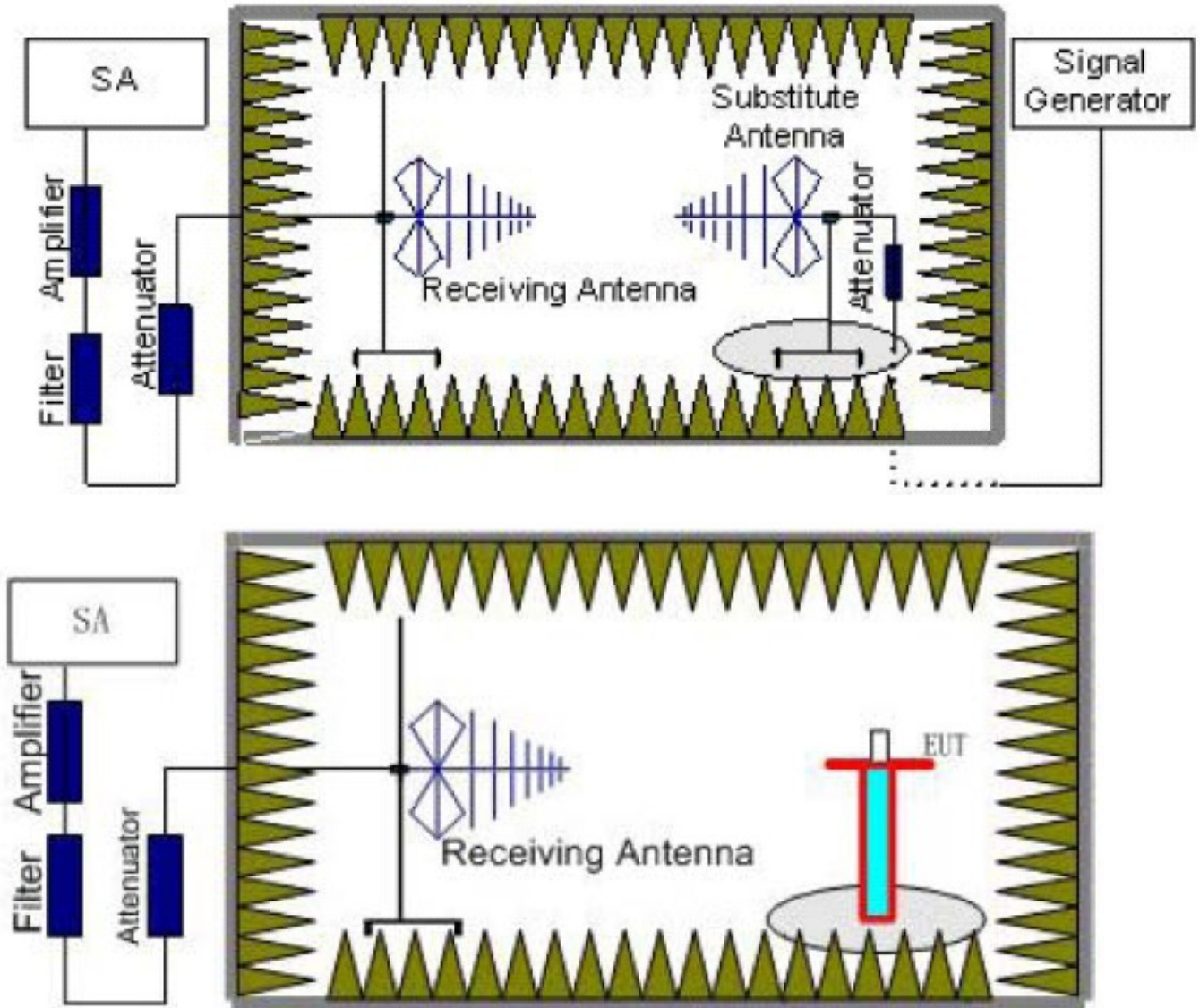

TEST PROCEDURE

1. EUT was placed on a 1.50 meter high non-conductive stand at a 3 meter test distance from the receive antenna. A receiving antenna was placed on the antenna mast 3 meters from the EUT for emission measurements. The height of receiving antenna is 1.50 meter. Detected emissions were maximized at each frequency by rotating the EUT through 360° and adjusting the receiving antenna polarization. The radiated emission measurements of all transmit frequencies in three channels (High, Middle, Low) were measured with peak detector.
2. A log-periodic antenna or double-ridged waveguide horn antenna shall be substituted in place of the EUT. The log-periodic antenna will be driven by a signal generator and the level will be adjusted till the same power value on the spectrum analyzer or receiver. The level of the spurious emissions can be calculated through the level of the signal generator, cable loss, the gain of the substitution antenna and the reading of the spectrum analyzer or receiver.

3. The EUT is then put into continuously transmitting mode at its maximum power level during the test. Set Test Receiver or Spectrum RBW=1MHz, VBW=3MHz, And the maximum value of the receiver should be recorded as (P_r).
4. The EUT shall be replaced by a substitution antenna. In the chamber, an substitution antenna for the frequency band of interest is placed at the reference point of the chamber. An RF Signal source for the frequency band of interest is connected to the substitution antenna with a cable that has been constructed to not interfere with the radiation pattern of the antenna. A power (P_{Mea}) is applied to the input of the substitution antenna, and adjust the level of the signal generator output until the value of the receiver reach the previously recorded (P_r). The power of signal source (P_{Mea}) is recorded. The test should be performed by rotating the test item and adjusting the receiving antenna polarization.
5. A amplifier should be connected to the Signal Source output port. And the cable should be connect between the Amplifier and the Substitution Antenna. The cable loss (P_{cl}), the Substitution Antenna Gain (G_a) and the Amplifier Gain (P_{Ag}) should be recorded after test. The measurement results are obtained as described below:
 $Power(EIRP) = P_{Mea} - P_{Ag} - P_{cl} + G_a$
6. This value is EIRP since the measurement is calibrated using an antenna of known gain (2.15 dBi) and known input power.
7. ERP can be calculated from EIRP by subtracting the gain of the dipole, $ERP = EIRP - 2.15dBi$.
8. In order to make sure test results more clearly, we set frequency range and sweep time for difference frequency range as follows table:

Working Frequency	Subrange (GHz)	RBW	VBW	Sweep time (s)
UMTS/TM1/ WCDMA Band V and TM1/GSM 850	0.00009~0.15	1KHz	3KHz	30
	0.00015~0.03	10KHz	30KHz	10
	0.03~1	100KHz	300KHz	10
	1~2	1 MHz	3 MHz	2
	2~5	1 MHz	3 MHz	3
	5~8	1 MHz	3 MHz	3
	8~10	1 MHz	3 MHz	3
UMTS/TM1/ WCDMA Band II and TM1/GSM 1900	0.00009~0.15	1KHz	3KHz	30
	0.00015~0.03	10KHz	30KHz	10
	0.03~1	100KHz	300KHz	10
	1~2	1 MHz	3 MHz	2
	2~5	1 MHz	3 MHz	3
	5~8	1 MHz	3 MHz	3
	8~11	1 MHz	3 MHz	3
	11~14	1 MHz	3 MHz	3
	14~18	1 MHz	3 MHz	3
18~20	1 MHz	3 MHz	2	

TEST LIMITS

According to 24.238, 22.917 specify that the power of any emission outside of the authorized operating frequency ranges must be attenuated below the transmitting power (P) by a factor of at least $43 + 10 \log(P)$ dB.

The specification that emissions shall be attenuated below the transmitter power (P) by at least $43 + 10 \log(P)$ dB, translates in the relevant power range (1 to 0.001 W) to -13 dBm. At 1 W the specified minimum attenuation becomes 43 dB and relative to a 30 dBm (1 W) carrier becomes a limit of -13 dBm. At 0.001 W (0 dBm) the minimum attenuation is 13 dB, which again yields a limit of -13 dBm. In this way a translation of the specification from relative to absolute terms is carried out.

Frequency	Channel	Frequency Range	Verdict
TM1/GSM 850	Low	9KHz-10GHz	PASS
	Middle	9KHz -10GHz	PASS
	High	9KHz -10GHz	PASS
UMTS/TM1/ WCDMA Band V	Low	9KHz-10GHz	PASS
	Middle	9KHz -10GHz	PASS
	High	9KHz -10GHz	PASS
UMTS/TM1/ WCDMA Band II	Low	9KHz -20GHz	PASS
	Middle	9KHz -20GHz	PASS
	High	9KHz -20GHz	PASS
TM1/GSM 1900	Low	9KHz -20GHz	PASS
	Middle	9KHz -20GHz	PASS
	High	9KHz -20GHz	PASS

TEST RESULTS

Remark:

1. We were tested all Configuration refer 3GPP TS134 121.
2. $EIRP = P_{Mea}(dBm) - P_{cl}(dB) + P_{Ag}(dB) + G_a(dBi)$
3. $ERP = EIRP - 2.15dBi$ as EIRP by subtracting the gain of the dipole.
6. Margin = Emission Level – Limit
7. We test both H direction and V direction, recorded worst case direction.

GSM/TM1/GSM850_ Low Channel

Frequency (MHz)	P _{Mea} (dBm)	P _{cl} (dB)	Diatance	G _a Antenna Gain(dB)	Peak EIRP (dBm)	Limit (dBm)	Margin (dB)	Polarization
1648.4	-26.02	5.98	3.00	9.11	-22.89	-13.00	-9.89	H
2472.6	-26.17	6.84	3.00	9.56	-23.45	-13.00	-10.45	H
1648.4	-22.10	5.98	3.00	9.11	-18.97	-13.00	-5.97	V
2472.6	-22.73	6.84	3.00	9.56	-20.01	-13.00	-7.01	V

GSM/TM1/GSM850_ Middle Channel

Frequency (MHz)	P _{Mea} (dBm)	P _{cl} (dB)	Diatance	G _a Antenna Gain(dB)	Peak EIRP (dBm)	Limit (dBm)	Margin (dB)	Polarization
1673.2	-25.19	5.98	3.00	9.11	-22.06	-13.00	-9.06	H
2509.8	-26.36	6.84	3.00	9.56	-23.64	-13.00	-10.64	H
1673.2	-20.94	5.98	3.00	9.11	-17.81	-13.00	-4.81	V
2509.8	-21.90	6.84	3.00	9.56	-19.18	-13.00	-6.18	V

GSM/TM1/GSM850_ High Channel

Frequency (MHz)	P _{Mea} (dBm)	P _{cl} (dB)	Diatance	G _a Antenna Gain(dB)	Peak EIRP (dBm)	Limit (dBm)	Margin (dB)	Polarization
1697.6	-24.72	5.98	3.00	9.11	-21.59	-13.00	-8.59	H
2546.4	-24.76	6.84	3.00	9.56	-22.04	-13.00	-9.04	H
1697.6	-21.41	5.98	3.00	9.11	-18.28	-13.00	-5.28	V
2546.4	-21.08	6.84	3.00	9.56	-18.36	-13.00	-5.36	V

GSM/TM1/GSM1900_ Low Channel

Frequency (MHz)	P _{Mea} (dBm)	P _{cl} (dB)	Diatance	G _a Antenna Gain(dB)	Peak EIRP (dBm)	Limit (dBm)	Margin (dB)	Polarization
3700.4	-23.71	6.89	3.00	9.88	-20.72	-13.00	-7.72	H
5550.6	-25.45	8.11	3.00	11.36	-22.20	-13.00	-9.20	H
3700.4	-18.82	6.89	3.00	9.88	-15.83	-13.00	-2.83	V
5550.6	-19.77	8.11	3.00	11.36	-16.52	-13.00	-3.52	V

GSM/TM1/GSM1900_ Middle Channel

Frequency (MHz)	P _{Mea} (dBm)	P _{cl} (dB)	Diatance	G _a Antenna Gain(dB)	Peak EIRP (dBm)	Limit (dBm)	Margin (dB)	Polarization
3760.0	-19.89	6.89	3.00	9.88	-16.90	-13.00	-3.90	H
5640.0	-22.44	8.11	3.00	11.36	-19.19	-13.00	-6.19	H
3760.0	-19.57	6.89	3.00	9.88	-16.58	-13.00	-3.58	V
5640.0	-25.76	8.11	3.00	11.36	-22.51	-13.00	-9.51	V

GSM/TM1/GSM1900_ High Channel

Frequency (MHz)	P _{Mea} (dBm)	P _{cl} (dB)	Diatance	G _a Antenna Gain(dB)	Peak EIRP (dBm)	Limit (dBm)	Margin (dB)	Polarization
3819.6	-24.41	6.89	3.00	9.88	-21.42	-13.00	-8.42	H
5729.4	-29.52	8.11	3.00	11.36	-26.27	-13.00	-13.27	H
3819.6	-20.11	6.89	3.00	9.88	-17.12	-13.00	-4.12	V
5729.4	-22.11	8.11	3.00	11.36	-18.86	-13.00	-5.86	V

UMTS/TM1/ WCDMA Band II _ Low Channel

Frequency (MHz)	P _{Mea} (dBm)	P _{cl} (dB)	Diatance	G _a Antenna Gain(dB)	Peak EIRP (dBm)	Limit (dBm)	Margin (dB)	Polarization
3704.8	-24.68	6.89	3.00	9.88	-21.69	-13.00	-8.69	H
5557.2	-26.34	8.11	3.00	11.36	-23.09	-13.00	-10.09	H
3704.8	-25.40	6.89	3.00	9.88	-22.41	-13.00	-9.41	V
5557.2	-27.73	8.11	3.00	11.36	-24.48	-13.00	-11.48	V

UMTS/TM1/ WCDMA Band II _ Middle Channel

Frequency (MHz)	P _{Mea} (dBm)	P _{cl} (dB)	Diatance	G _a Antenna Gain(dB)	Peak EIRP (dBm)	Limit (dBm)	Margin (dB)	Polarization
3760.0	-20.62	6.89	3.00	9.88	-17.63	-13.00	-4.63	H
5640.0	-22.75	8.11	3.00	11.36	-19.50	-13.00	-6.50	H
3760.0	-25.51	6.89	3.00	9.88	-22.52	-13.00	-9.52	V
5640.0	-26.85	8.11	3.00	11.36	-23.60	-13.00	-10.60	V

UMTS/TM1/ WCDMA Band II _ High Channel

Frequency (MHz)	P _{Mea} (dBm)	P _{cl} (dB)	Diatance	G _a Antenna Gain(dB)	Peak EIRP (dBm)	Limit (dBm)	Margin (dB)	Polarization
3815.2	-22.93	6.89	3.00	9.88	-19.94	-13.00	-6.94	H
5722.8	-24.32	8.11	3.00	11.36	-21.07	-13.00	-8.07	H
3815.2	-23.76	6.89	3.00	9.88	-20.77	-13.00	-7.77	V
5722.8	-26.14	8.11	3.00	11.36	-22.89	-13.00	-9.89	V

UMTS/TM1/ WCDMA Band V _ Low Channel

Frequency (MHz)	P _{Mea} (dBm)	P _{cl} (dB)	Diatance	G _a Antenna Gain(dB)	Peak EIRP (dBm)	Limit (dBm)	Margin (dB)	Polarization
1652.8	-24.89	5.98	3.00	9.11	-21.76	-13.00	-8.76	H
2479.2	-27.87	6.84	3.00	9.56	-25.15	-13.00	-12.15	H
1652.8	-26.70	5.98	3.00	9.11	-23.57	-13.00	-10.57	V
2479.2	-32.17	6.84	3.00	9.56	-29.45	-13.00	-16.45	V

UMTS/TM1/ WCDMA Band V _ Middle Channel

Frequency (MHz)	P _{Mea} (dBm)	P _{cl} (dB)	Diatance	G _a Antenna Gain(dB)	Peak EIRP (dBm)	Limit (dBm)	Margin (dB)	Polarization
1673.2	-25.10	5.98	3.00	9.11	-21.97	-13.00	-8.97	H
2509.8	-24.78	6.84	3.00	9.56	-22.06	-13.00	-9.06	H
1673.2	-20.87	5.98	3.00	9.11	-17.74	-13.00	-4.74	V
2509.8	-21.53	6.84	3.00	9.56	-18.81	-13.00	-5.81	V

UMTS/TM1/ WCDMA Band V _ High Channel

Frequency (MHz)	P _{Mea} (dBm)	P _{cl} (dB)	Diatance	G _a Antenna Gain(dB)	Peak EIRP (dBm)	Limit (dBm)	Margin (dB)	Polarization
1693.2	-26.19	5.98	3.00	9.11	-23.06	-13.00	-10.06	H
2539.8	-30.27	6.84	3.00	9.56	-27.55	-13.00	-14.55	H
1693.2	-22.00	5.98	3.00	9.11	-18.87	-13.00	-5.87	V
2539.8	-22.66	6.84	3.00	9.56	-19.94	-13.00	-6.94	V

4.3 Occupied Bandwidth and Emission Bandwidth

TEST APPLICABLE

Similar to conducted emissions; occupied bandwidth measurements are only provided for selected frequencies in order to reduce the amount of submitted data. Data were taken at the extreme and mid frequencies of WCDMA Band II / WCDMA band V / GSM 850 / GSM 1900. The table below lists the measured 99% Bandwidth and -26dBc Bandwidth.

TEST CONFIGURATION

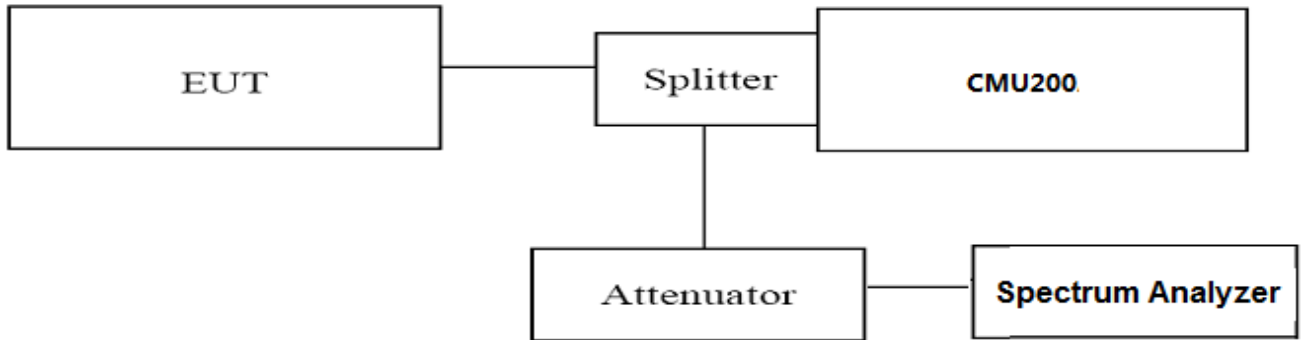

TEST PROCEDURE

1. The EUT was set up for the max output power with pseudo random data modulation;
2. Set RBW = 10 KHz, VBW = 30 KHz, Span = 1 MHz, SWT=Auto for GSM 850 / GSM 1900;
3. Set RBW = 100 KHz, VBW = 300 KHz, Span = 6 MHz, SWT=Auto for UMTS;
4. Set SPA Max hold and View, Set 99% Occupied Bandwidth/ Set -26dBc Occupied Bandwidth
5. These measurements were done at 3 frequencies for WCDMA Band II/ WCDMA Band V / GSM 850 / EDGE 850 / GSM 1900 / EDGE 1900. (low, middle and high of operational frequency range).

TEST RESULTS

Test Mode	Channel	Frequency (MHz)	Occupied Bandwidth (99% BW) (KHz)	Emission Bandwidth (-26 dBc BW) (KHz)	Verdict
GSM/TM1 /GSM850	128	824.2	243.758	317.420	PASS
	190	836.6	244.921	318.048	PASS
	251	848.8	244.475	312.865	PASS
GSM/TM3 /EDGE850	128	824.2	245.623	315.516	PASS
	190	836.6	247.224	320.804	PASS
	251	848.8	244.188	319.995	PASS
GSM/TM1 /GSM1900	512	1850.2	247.217	319.993	PASS
	661	1880.0	247.329	312.829	PASS
	810	1908.8	246.733	316.999	PASS
GSM/TM3 /EDGE1900	512	1850.2	250.107	330.905	PASS
	661	1880.0	245.540	321.186	PASS
	810	1908.8	246.766	320.201	PASS
UMTS/TM1/ WCDMA Band V	4132	826.4	4167.600	4704.000	PASS
	4183	836.6	4138.400	4769.000	PASS
	4233	846.6	4143.1000	4700.000	PASS
UMTS/TM1/ WCDMA Band II	9262	1852.4	4158.800	4708.000	PASS
	9400	1880.0	4156.400	4704.000	PASS
	9538	1907.6	4157.800	4721.000	PASS

Remark:

1. Test results including cable loss;
2. please refer to following plots;

Occupied Bandwidth and Emission Bandwidth

GSM/TM1/GSM850		GSM/TM3/EDGE850	
<p>Agilent 11:53:06 Dec 1, 2015 R T</p> <p>Ch Freq 824.2 MHz Trig Free</p> <p>Occupied Bandwidth</p> <p>Ref Level 35.00 dBm</p> <p>Ref 35 dBm Atten 40 dB Ext PG -10 dB</p> <p>Center 824.200 MHz Span 1 MHz</p> <p>Res BW 10 kHz #VBW 30 kHz Sweep 9.56 ms (601 pts)</p> <p>Occupied Bandwidth 243.7582 kHz</p> <p>Occ BW % Pwr 99.00 %</p> <p>x dB -26.00 dB</p> <p>Transmit Freq Error 14.288 Hz</p> <p>x dB Bandwidth 317.420 kHz</p> <p>Copyright 2000-2006 Agilent Technologies</p>	<p>Meas Setup</p> <p>Avg Number 10</p> <p>On Off</p> <p>Avg Mode Exp Repeat</p> <p>Max Hold On Off</p> <p>Occ BW % Pwr 99.00 %</p> <p>OBW Span 1.00000000 MHz</p> <p>x dB -26.00 dB</p> <p>Optimize Ref Level</p>	<p>Agilent L</p> <p>Ch Freq 824.2 MHz Trig Free</p> <p>Occupied Bandwidth</p> <p>Ref 40 dBm Atten 30 dB Ext PG -25 dB</p> <p>Center 824.200 MHz Span 1 MHz</p> <p>Res BW 10 kHz #VBW 30 kHz Sweep 9.56 ms (601 pts)</p> <p>Occupied Bandwidth 245.6226 kHz</p> <p>Occ BW % Pwr 99.00 %</p> <p>x dB -26.00 dB</p> <p>Transmit Freq Error -114.247 Hz</p> <p>x dB Bandwidth 315.516 kHz</p> <p>Copyright 2000-2004 Agilent Technologies</p>	<p>Trace</p> <p>Trace 1 2 3</p> <p>Clear Write</p> <p>Max Hold</p> <p>Min Hold</p> <p>View</p> <p>Blank</p>
Channel 128 / 824.2 MHz		Channel 128 / 824.2 MHz	
<p>Agilent 11:53:53 Dec 1, 2015 R T</p> <p>Ch Freq 836.6 MHz Trig Free</p> <p>Occupied Bandwidth</p> <p>Ref 35 dBm Atten 40 dB Ext PG -10 dB</p> <p>Center 836.600 MHz Span 1 MHz</p> <p>Res BW 10 kHz #VBW 30 kHz Sweep 9.56 ms (601 pts)</p> <p>Occupied Bandwidth 244.9206 kHz</p> <p>Occ BW % Pwr 99.00 %</p> <p>x dB -26.00 dB</p> <p>Transmit Freq Error -53.764 Hz</p> <p>x dB Bandwidth 318.048 kHz</p> <p>Copyright 2000-2006 Agilent Technologies</p>	<p>Freq/Channel</p> <p>Center Freq 836.600000 MHz</p> <p>Start Freq 836.100000 MHz</p> <p>Stop Freq 837.100000 MHz</p> <p>CF Step 100.000000 kHz Auto Man</p> <p>Freq Offset 0.00000000 Hz</p> <p>Signal Track On Off</p>	<p>Agilent L</p> <p>Ch Freq 836.6 MHz Trig Free</p> <p>Occupied Bandwidth</p> <p>Ref 40 dBm Atten 30 dB Ext PG -25 dB</p> <p>Center 836.600 MHz Span 1 MHz</p> <p>Res BW 10 kHz #VBW 30 kHz Sweep 9.56 ms (601 pts)</p> <p>Occupied Bandwidth 247.2240 kHz</p> <p>Occ BW % Pwr 99.00 %</p> <p>x dB -26.00 dB</p> <p>Transmit Freq Error -1.046 kHz</p> <p>x dB Bandwidth 320.804 kHz</p> <p>Copyright 2000-2004 Agilent Technologies</p>	<p>Trace</p> <p>Trace 1 2 3</p> <p>Clear Write</p> <p>Max Hold</p> <p>Min Hold</p> <p>View</p> <p>Blank</p>
Channel 190 / 836.6 MHz		Channel 190 / 836.6 MHz	
<p>Agilent 11:54:43 Dec 1, 2015 R T</p> <p>Ch Freq 848.8 MHz Trig Free</p> <p>Occupied Bandwidth</p> <p>Center 848.8000000 MHz</p> <p>Ref 35 dBm Atten 40 dB Ext PG -10 dB</p> <p>Center 848.800 MHz Span 1 MHz</p> <p>Res BW 10 kHz #VBW 30 kHz Sweep 9.56 ms (601 pts)</p> <p>Occupied Bandwidth 244.4754 kHz</p> <p>Occ BW % Pwr 99.00 %</p> <p>x dB -26.00 dB</p> <p>Transmit Freq Error 743.226 Hz</p> <p>x dB Bandwidth 312.865 kHz</p> <p>Copyright 2000-2006 Agilent Technologies</p>	<p>Trace</p> <p>Trace 1 2 3</p> <p>Clear Write</p> <p>Max Hold</p> <p>Min Hold</p> <p>View</p> <p>Blank</p> <p>More 1 of 2</p>	<p>Agilent L S Freq/Channel</p> <p>Ch Freq 848.8 MHz Trig Free</p> <p>Occupied Bandwidth</p> <p>Ref 40 dBm Atten 30 dB Ext PG -25 dB</p> <p>Center 848.800 MHz Span 1 MHz</p> <p>Res BW 10 kHz #VBW 30 kHz Sweep 9.56 ms (601 pts)</p> <p>Occupied Bandwidth 244.1884 kHz</p> <p>Occ BW % Pwr 99.00 %</p> <p>x dB -26.00 dB</p> <p>Transmit Freq Error -597.924 Hz</p> <p>x dB Bandwidth 319.995 kHz</p> <p>Copyright 2000-2004 Agilent Technologies</p>	<p>Center Freq 848.800000 MHz</p> <p>Start Freq 848.300000 MHz</p> <p>Stop Freq 849.300000 MHz</p> <p>CF Step 100.000000 kHz Auto Man</p> <p>Freq Offset 0.00000000 Hz</p> <p>Signal Track On Off</p>
Channel 251 / 848.8 MHz		Channel 251 / 848.8 MHz	

Occupied Bandwidth and Emission Bandwidth

GSM/TM1/GSM1900		GSM/TM3/EDGE1900	
<p>Agilent 14:18:08 Dec 1, 2015 R T</p> <p>Ch Freq 1.8502 GHz Trig Free</p> <p>Occupied Bandwidth</p> <p>VBW 30.0 kHz</p> <p>Ref 30 dBm Atten 30 dB Ext PG -10 dB</p> <p>#Peak Log 10 dB/</p> <p>Center 1.850 200 GHz Span 1 MHz</p> <p>#Res BW 10 kHz #VBW 30 kHz Sweep 9.56 ms (601 pts)</p> <p>Occupied Bandwidth 247.2170 kHz</p> <p>Occ BW % Pwr 99.00 %</p> <p>x dB -26.00 dB</p> <p>Transmit Freq Error 942.794 Hz</p> <p>x dB Bandwidth 319.993 kHz</p> <p>Copyright 2000-2006 Agilent Technologies</p>	<p>Meas Setup</p> <p>Avg Number 10</p> <p>On Off</p> <p>Avg Mode Exp Repeat</p> <p>Max Hold On Off</p> <p>Occ BW % Pwr 99.00 %</p> <p>OBW Span 1.00000000 MHz</p> <p>x dB -26.00 dB</p> <p>Optimize Ref Level</p>	<p>Agilent L S</p> <p>Ch Freq 1.8502 GHz Trig Free</p> <p>Occupied Bandwidth</p> <p>Center Freq 1.85020000 GHz</p> <p>Start Freq 1.84970000 GHz</p> <p>Stop Freq 1.85070000 GHz</p> <p>CF Step 100.000000 kHz Auto Man</p> <p>Freq Offset 0.00000000 Hz</p> <p>Signal Track On Off</p> <p>Copyright 2000-2004 Agilent Technologies</p>	<p>Agilent</p> <p>Ch Freq 1.8502 GHz Trig Free</p> <p>Occupied Bandwidth</p> <p>Center Freq 1.85020000 GHz</p> <p>Start Freq 1.84970000 GHz</p> <p>Stop Freq 1.85070000 GHz</p> <p>CF Step 100.000000 kHz Auto Man</p> <p>Freq Offset 0.00000000 Hz</p> <p>Signal Track On Off</p> <p>Copyright 2000-2004 Agilent Technologies</p>
<p>Channel 512 / 1850.2 MHz</p> <p>Agilent 14:19:34 Dec 1, 2015 R T</p> <p>Ch Freq 1.88 GHz Trig Free</p> <p>Occupied Bandwidth</p> <p>Center 1.880000000 GHz</p> <p>Ref 30 dBm Atten 30 dB Ext PG -10 dB</p> <p>#Peak Log 10 dB/</p> <p>Center 1.880 000 GHz Span 1 MHz</p> <p>#Res BW 10 kHz #VBW 30 kHz Sweep 9.56 ms (601 pts)</p> <p>Occupied Bandwidth 247.3286 kHz</p> <p>Occ BW % Pwr 99.00 %</p> <p>x dB -26.00 dB</p> <p>Transmit Freq Error -829.899 Hz</p> <p>x dB Bandwidth 312.829 kHz</p> <p>Copyright 2000-2006 Agilent Technologies</p>		<p>Channel 512 / 1850.2 MHz</p> <p>Agilent L S</p> <p>Ch Freq 1.88 GHz Trig Free</p> <p>Occupied Bandwidth</p> <p>Center Freq 1.88000000 GHz</p> <p>Start Freq 1.87950000 GHz</p> <p>Stop Freq 1.88050000 GHz</p> <p>CF Step 100.000000 kHz Auto Man</p> <p>Freq Offset 0.00000000 Hz</p> <p>Signal Track On Off</p> <p>Copyright 2000-2004 Agilent Technologies</p>	
<p>Channel 661 / 1880.0 MHz</p> <p>Agilent 14:20:30 Dec 1, 2015 R T</p> <p>Ch Freq 1.9098 GHz Trig Free</p> <p>Occupied Bandwidth</p> <p>Center 1.909800000 GHz</p> <p>Ref 30 dBm Atten 30 dB Ext PG -10 dB</p> <p>#Peak Log 10 dB/</p> <p>Center 1.909 800 GHz Span 1 MHz</p> <p>#Res BW 10 kHz #VBW 30 kHz Sweep 9.56 ms (601 pts)</p> <p>Occupied Bandwidth 246.7334 kHz</p> <p>Occ BW % Pwr 99.00 %</p> <p>x dB -26.00 dB</p> <p>Transmit Freq Error -1.865 kHz</p> <p>x dB Bandwidth 316.999 kHz</p> <p>Copyright 2000-2006 Agilent Technologies</p>		<p>Channel 661 / 1880.0 MHz</p> <p>Agilent L S</p> <p>Ch Freq 1.9098 GHz Trig Free</p> <p>Occupied Bandwidth</p> <p>Center Freq 1.90980000 GHz</p> <p>Start Freq 1.90930000 GHz</p> <p>Stop Freq 1.91030000 GHz</p> <p>CF Step 100.000000 kHz Auto Man</p> <p>Freq Offset 0.00000000 Hz</p> <p>Signal Track On Off</p> <p>Copyright 2000-2004 Agilent Technologies</p>	
<p>Channel 810 / 1908.8 MHz</p> <p>Agilent 14:20:30 Dec 1, 2015 R T</p> <p>Ch Freq 1.9098 GHz Trig Free</p> <p>Occupied Bandwidth</p> <p>Center 1.909800000 GHz</p> <p>Ref 30 dBm Atten 30 dB Ext PG -10 dB</p> <p>#Peak Log 10 dB/</p> <p>Center 1.909 800 GHz Span 1 MHz</p> <p>#Res BW 10 kHz #VBW 30 kHz Sweep 9.56 ms (601 pts)</p> <p>Occupied Bandwidth 246.7334 kHz</p> <p>Occ BW % Pwr 99.00 %</p> <p>x dB -26.00 dB</p> <p>Transmit Freq Error -1.865 kHz</p> <p>x dB Bandwidth 316.999 kHz</p> <p>Copyright 2000-2006 Agilent Technologies</p>		<p>Channel 810 / 1908.8 MHz</p> <p>Agilent L S</p> <p>Ch Freq 1.9098 GHz Trig Free</p> <p>Occupied Bandwidth</p> <p>Center Freq 1.90980000 GHz</p> <p>Start Freq 1.90930000 GHz</p> <p>Stop Freq 1.91030000 GHz</p> <p>CF Step 100.000000 kHz Auto Man</p> <p>Freq Offset 0.00000000 Hz</p> <p>Signal Track On Off</p> <p>Copyright 2000-2004 Agilent Technologies</p>	

Occupied Bandwidth and Emission Bandwidth

UMTS/TM1/ WCDMA Band V		UMTS/TM1/ WCDMA Band II	
<p>Agilent R T</p> <p>Ch Freq 826.4 MHz</p> <p>Occupied Bandwidth</p> <p>Ref 30 dBm Atten 30 dB</p> <p>Center 826.4 MHz</p> <p>#Res BW 100 kHz</p> <p>#VBW 300 kHz</p> <p>Sweep 5 ms (401 pts)</p> <p>Span 6 MHz</p> <p>Occupied Bandwidth 4.1676 MHz</p> <p>Occ BW % Pwr 99.00 %</p> <p>x dB -26.00 dB</p> <p>Transmit Freq Error -11.719 kHz</p> <p>x dB Bandwidth 4.704 MHz</p>	<p>Freq/Channel</p> <p>Center Freq 826.400000 MHz</p> <p>Start Freq 823.400000 MHz</p> <p>Stop Freq 829.400000 MHz</p> <p>CF Step 600.000000 kHz</p> <p>Freq Offset 0.00000000 Hz</p> <p>Signal Track On</p> <p>Scale Type Log</p>	<p>Agilent R T</p> <p>Ch Freq 1.8524 GHz</p> <p>Occupied Bandwidth</p> <p>Ref 30 dBm Atten 30 dB</p> <p>Center 1.852 GHz</p> <p>#Res BW 100 kHz</p> <p>#VBW 300 kHz</p> <p>Sweep 5 ms (401 pts)</p> <p>Span 6 MHz</p> <p>Occupied Bandwidth 4.1588 MHz</p> <p>Occ BW % Pwr 99.00 %</p> <p>x dB -26.00 dB</p> <p>Transmit Freq Error -12.919 kHz</p> <p>x dB Bandwidth 4.708 MHz</p>	<p>Freq/Channel</p> <p>Center Freq 1.85240000 GHz</p> <p>Start Freq 1.84940000 GHz</p> <p>Stop Freq 1.85540000 GHz</p> <p>CF Step 600.000000 kHz</p> <p>Freq Offset 0.00000000 Hz</p> <p>Signal Track On</p> <p>Scale Type Log</p>
Channel 4132 / 826.4 MHz		Channel 9262 / 1852.4 MHz	
<p>Agilent R T</p> <p>Ch Freq 836.6 MHz</p> <p>Occupied Bandwidth</p> <p>Ref 30 dBm Atten 30 dB</p> <p>Center 836.6 MHz</p> <p>#Res BW 100 kHz</p> <p>#VBW 300 kHz</p> <p>Sweep 5 ms (401 pts)</p> <p>Span 6 MHz</p> <p>Occupied Bandwidth 4.1384 MHz</p> <p>Occ BW % Pwr 99.00 %</p> <p>x dB -26.00 dB</p> <p>Transmit Freq Error -29.449 kHz</p> <p>x dB Bandwidth 4.697 MHz</p>	<p>Freq/Channel</p> <p>Center Freq 836.600000 MHz</p> <p>Start Freq 833.600000 MHz</p> <p>Stop Freq 839.600000 MHz</p> <p>CF Step 600.000000 kHz</p> <p>Freq Offset 0.00000000 Hz</p> <p>Signal Track On</p> <p>Scale Type Log</p>	<p>Agilent R T</p> <p>Ch Freq 1.88 GHz</p> <p>Occupied Bandwidth</p> <p>Ref 30 dBm Atten 30 dB</p> <p>Center 1.88 GHz</p> <p>#Res BW 100 kHz</p> <p>#VBW 300 kHz</p> <p>Sweep 5 ms (401 pts)</p> <p>Span 6 MHz</p> <p>Occupied Bandwidth 4.1564 MHz</p> <p>Occ BW % Pwr 99.00 %</p> <p>x dB -26.00 dB</p> <p>Transmit Freq Error -3.771 kHz</p> <p>x dB Bandwidth 4.704 MHz</p>	<p>Freq/Channel</p> <p>Center Freq 1.88000000 GHz</p> <p>Start Freq 1.87700000 GHz</p> <p>Stop Freq 1.88300000 GHz</p> <p>CF Step 600.000000 kHz</p> <p>Freq Offset 0.00000000 Hz</p> <p>Signal Track On</p> <p>Scale Type Log</p>
Channel 4183 / 836.6 MHz		Channel 9400 / 1880.0 MHz	
<p>Agilent R T</p> <p>Ch Freq 846.6 MHz</p> <p>Occupied Bandwidth</p> <p>Ref 30 dBm Atten 30 dB</p> <p>Center 846.6 MHz</p> <p>#Res BW 100 kHz</p> <p>#VBW 300 kHz</p> <p>Sweep 5 ms (401 pts)</p> <p>Span 6 MHz</p> <p>Occupied Bandwidth 4.1431 MHz</p> <p>Occ BW % Pwr 99.00 %</p> <p>x dB -26.00 dB</p> <p>Transmit Freq Error 6.467 kHz</p> <p>x dB Bandwidth 4.700 MHz</p>	<p>Freq/Channel</p> <p>Center Freq 846.600000 MHz</p> <p>Start Freq 843.600000 MHz</p> <p>Stop Freq 849.600000 MHz</p> <p>CF Step 600.000000 kHz</p> <p>Freq Offset 0.00000000 Hz</p> <p>Signal Track On</p> <p>Scale Type Log</p>	<p>Agilent R T</p> <p>Ch Freq 1.9076 GHz</p> <p>Occupied Bandwidth</p> <p>Ref 30 dBm Atten 30 dB</p> <p>Center 1.908 GHz</p> <p>#Res BW 100 kHz</p> <p>#VBW 300 kHz</p> <p>Sweep 5 ms (401 pts)</p> <p>Span 6 MHz</p> <p>Occupied Bandwidth 4.1578 MHz</p> <p>Occ BW % Pwr 99.00 %</p> <p>x dB -26.00 dB</p> <p>Transmit Freq Error -12.377 kHz</p> <p>x dB Bandwidth 4.721 MHz</p>	<p>Freq/Channel</p> <p>Center Freq 1.90760000 GHz</p> <p>Start Freq 1.90460000 GHz</p> <p>Stop Freq 1.91060000 GHz</p> <p>CF Step 600.000000 kHz</p> <p>Freq Offset 0.00000000 Hz</p> <p>Signal Track On</p> <p>Scale Type Log</p>
Channel 4233 / 846.6 MHz		Channel 9538 / 1907.6 MHz	

4.4 Band Edge Compliance

TEST APPLICABLE

During the process of testing, the EUT was controlled via Digital Radio Communication tester (CMU200) to ensure max power transmission and proper modulation.

TEST CONFIGURATION

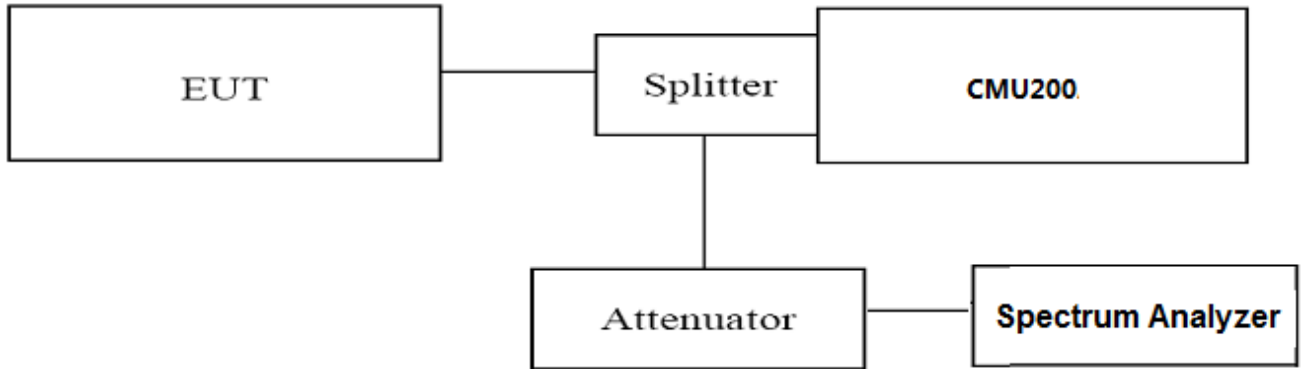

TEST PROCEDURE

1. The EUT was set up for the max output power with pseudo random data modulation;
2. Set RBW = 10 KHz, VBW = 10 KHz, Dector: RMS for GSM;
3. Set RBW =100 KHz,VBW = 300KHz,Dector: RMS for UMTS;
4. These measurements were done at 2 frequencies (low and high of operational frequency range).

TEST RESULTS

Test Mode	Channel	Frequency (MHz)	Band Edg Compliance (dBm)	Limits (dBm)	Verdict
GSM/TM1/GSM850	128	824.2	<-13dBm	-13dBm	PASS
	251	848.8	<-13dBm	-13dBm	
GSM/TM1/GSM1900	512	1850.2	<-13dBm	-13dBm	PASS
	810	1909.8	<-13dBm	-13dBm	
GSM/TM3/EDGE850	128	824.2	<-13dBm	-13dBm	PASS
	251	848.8	<-13dBm	-13dBm	
GSM/TM3/EDGE1900	512	1850.2	<-13dBm	-13dBm	PASS
	810	1909.8	<-13dBm	-13dBm	
UMTS/TM1/WCDMA Band V	4132	826.4	<-13dBm	-13dBm	PASS
	4233	846.6	<-13dBm	-13dBm	
UMTS/TM1/WCDMA Band II	9262	1852.4	<-13dBm	-13dBm	PASS
	9538	1907.6	<-13dBm	-13dBm	

Remark:

1. Test results including cable loss;
2. please refer to following plots;

Band-edge Compliance

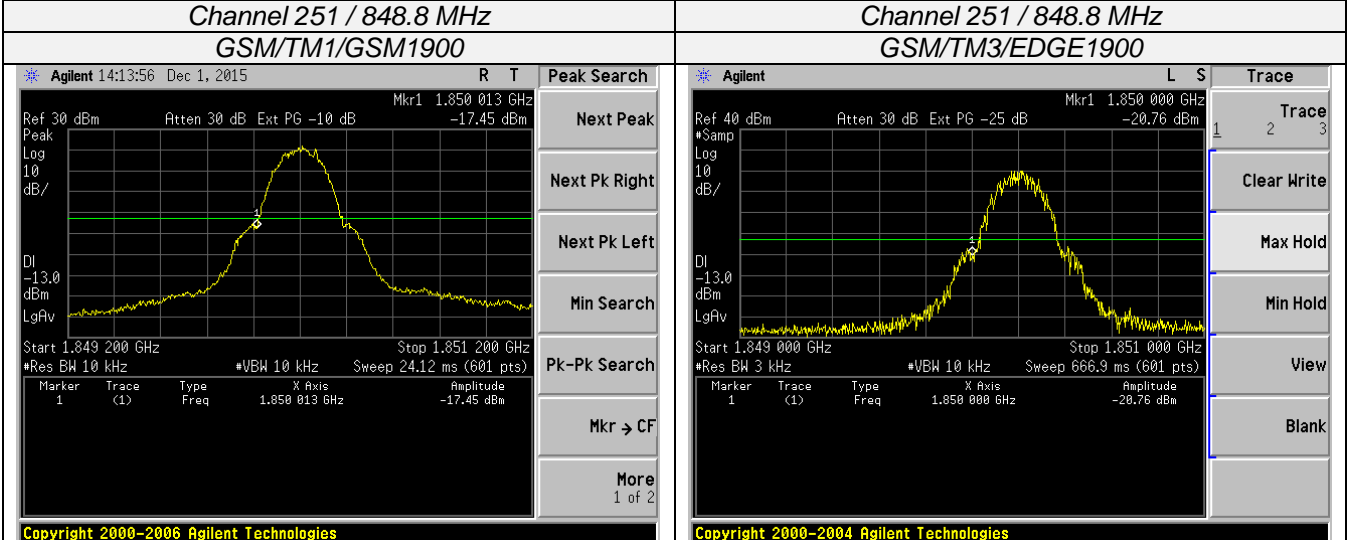
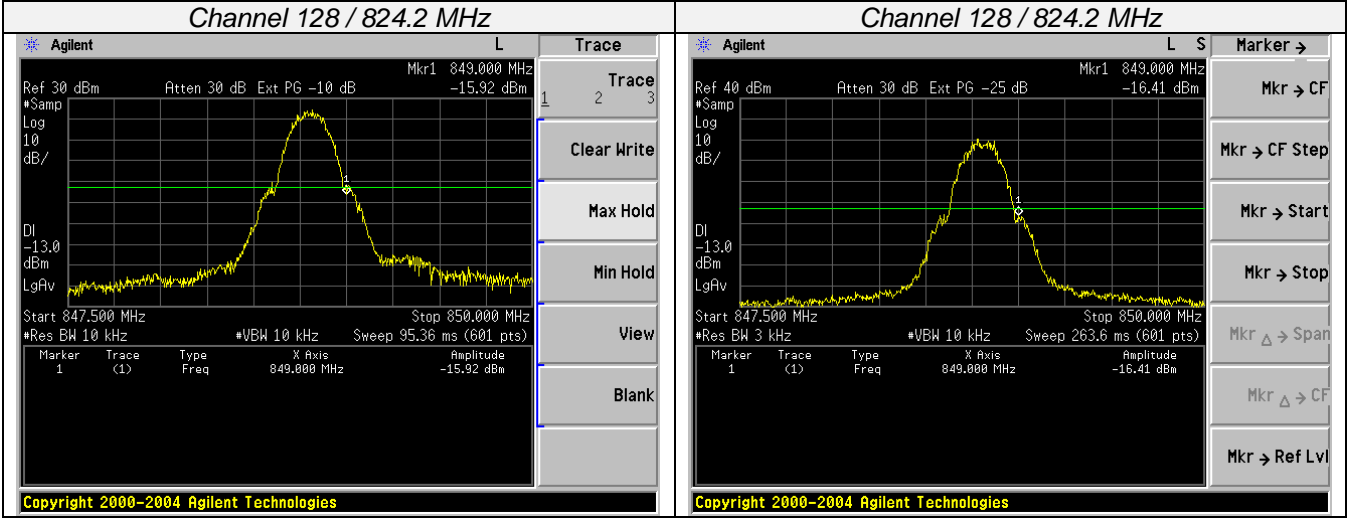
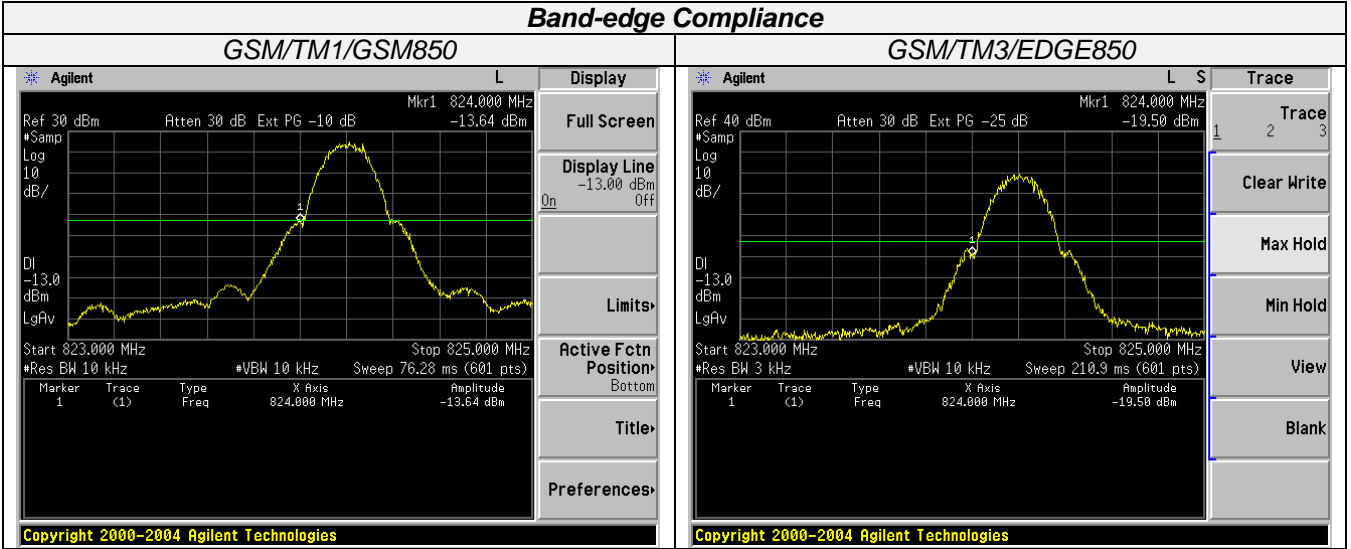

Channel 512 / 1850.2 MHz	Channel 512 / 1850.2 MHz
--------------------------	--------------------------

Band-edge Compliance

GSM/TM1/GSM1900

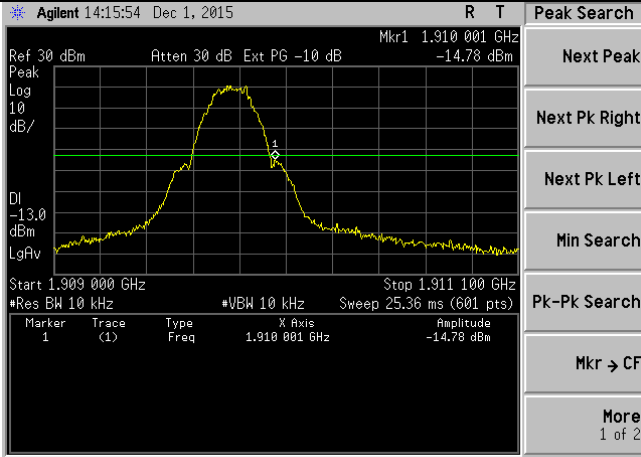

GSM/TM3/EDGE1900

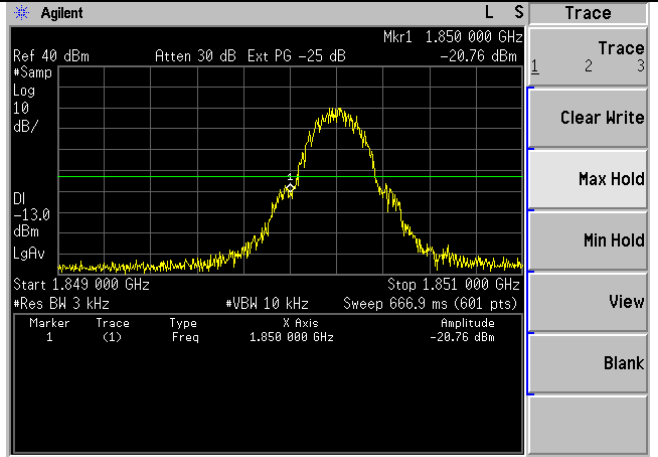

**Channel 810 / 1908.8 MHz
UMTS/TM1/WCDMA Band V**

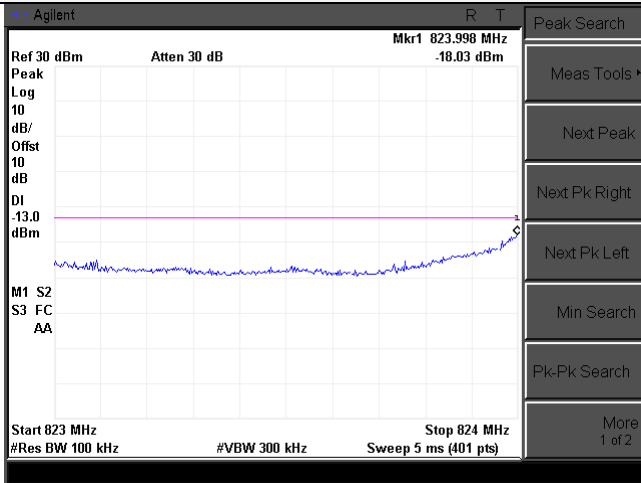

**Channel 810 / 1908.8 MHz
UMTS/TM1/WCDMA Band II**

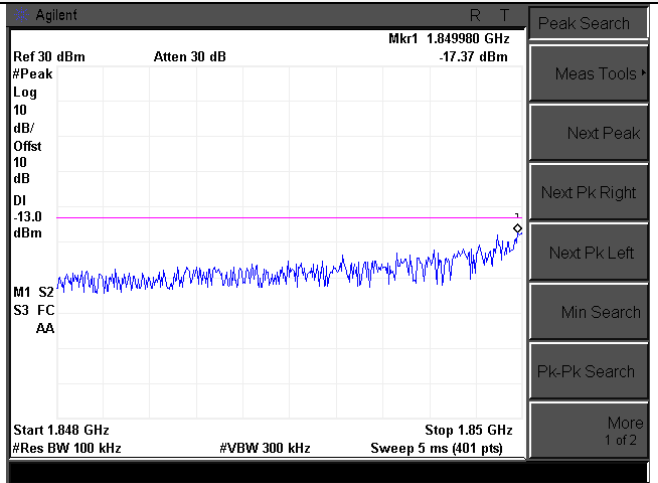

Channel 4132 / 826.4 MHz

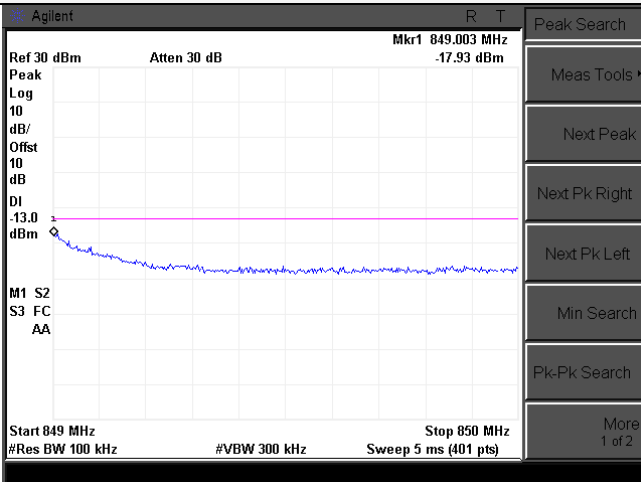

Channel 9262 / 1852.4 MHz

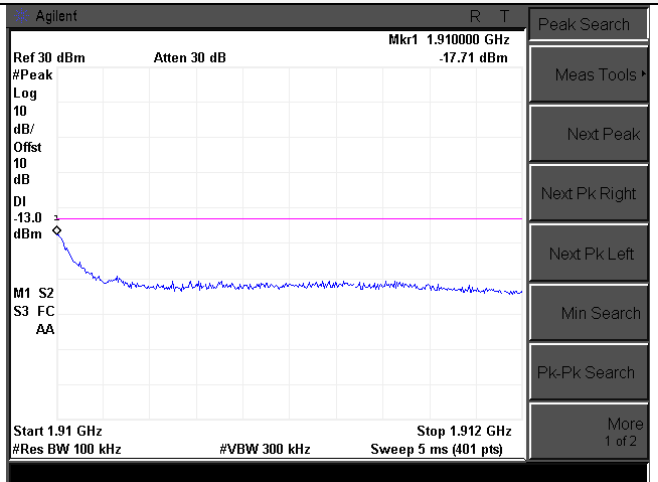

Channel 4233 / 846.6 MHz

Channel 9538 / 1907.6 MHz

4.5 Spurious Emission on Antenna Port

TEST APPLICABLE

The following steps outline the procedure used to measure the conducted emissions from the EUT.

1. Determine frequency range for measurements: From CFR 2.1057 the spectrum should be investigated from the lowest radio frequency generated in the equipment up to at least the 10th harmonic of the carrier frequency. For the equipment of WCDMA band II /GSM 1900 / EDGE 1900 / WCDMA Band V measured from 9 KHz to 20 GHz and data taken from 9 KHz to 20 GHz. For GSM 850 / EDGE 850, measured from 9 KHz to 10 GHz and data taken from 9 KHz to 10 GHz.
2. The sweep time is set automatically by instrument itself. That should be the optimal sweep time for the span and the RBW. If the sweep time is too short, that is sweep is too fast, the sweep result is not accurate; if the sweep time is too long, that is sweep is too low, some frequency components may be lost. The instrument will give an optimal sweep time according the selected span and RBW.
3. The procedure to get the conducted spurious emission is as follows:
The trace mode is set to MaxHold to get the highest signal at each frequency;
Wait 25 seconds; Get the result.
4. Determine EUT transmit frequencies: below outlines the band edge frequencies pertinent to conducted emissions testing.

TEST CONFIGURATION

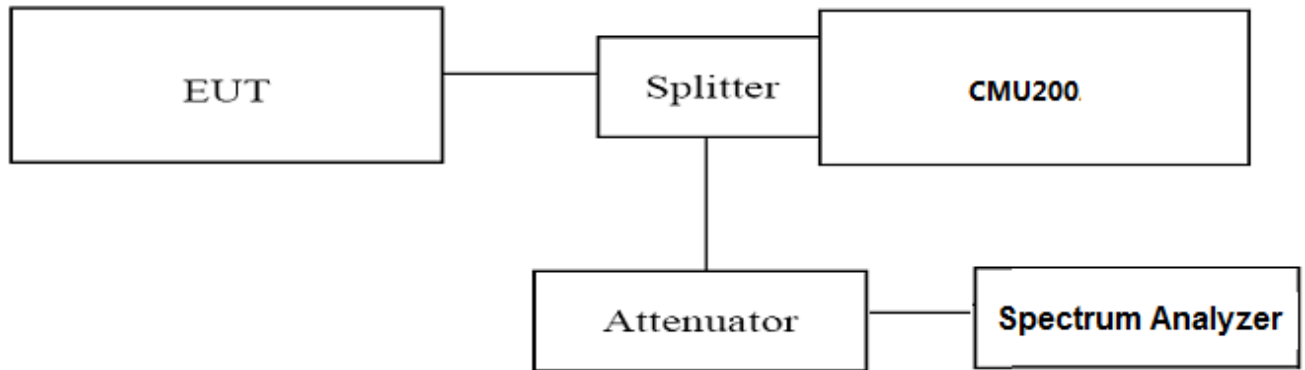

TEST PROCEDURE

1. The EUT was set up for the max output power with pseudo random data modulation;
2. These measurements were done at 3 frequencies (low, middle and high of operational frequency range) of each band.

TEST LIMIT

Part 24.238, Part 22.917 and Part 22.54 specify that the power of any emission outside of the authorized operating frequency ranges must be attenuated below the transmitting power (P) by a factor of at least $43 + 10 \log(P)$ dB.

The specification that emissions shall be attenuated below the transmitter power (P) by at least $43 + 10 \log(P)$ dB, translates in the relevant power range (1 to 0.001 W) to -13 dBm. At 1 W the specified minimum attenuation becomes 43 dB and relative to a 30 dBm (1 W) carrier becomes a limit of -13 dBm. At 0.001 W (0 dBm) the minimum attenuation is 13 dB, which again yields a limit of -13 dBm. In this way a translation of the specification from relative to absolute terms is carried out.

TEST RESULTS

Test Mode	Channel	Frequency (MHz)	Spurious RF Conducted Emission (dBm)	Limits (dBm)	Verdict
GSM/TM1/GSM850	128	824.2	<-13dBm	-13dBm	PASS
	190	836.6	<-13dBm	-13dBm	
	251	848.8	<-13dBm	-13dBm	
GSM/TM1/GSM1900	512	1850.2	<-13dBm	-13dBm	PASS
	661	1880.0	<-13dBm	-13dBm	
	810	1908.8	<-13dBm	-13dBm	
GSM/TM3/EDGE850	128	824.2	<-13dBm	-13dBm	PASS
	190	836.6	<-13dBm	-13dBm	
	251	848.8	<-13dBm	-13dBm	
GSM/TM3/EDGE1900	512	1850.2	<-13dBm	-13dBm	PASS
	661	1880.0	<-13dBm	-13dBm	
	810	1908.8	<-13dBm	-13dBm	
UMTS/TM1/WCDMA Band V	4132	826.40	<-13dBm	-13dBm	PASS
	4183	836.60	<-13dBm	-13dBm	
	4233	846.60	<-13dBm	-13dBm	
UMTS/TM1/WCDMA Band II	9262	1852.40	<-13dBm	-13dBm	PASS
	9400	1880.00	<-13dBm	-13dBm	
	9538	1907.60	<-13dBm	-13dBm	

Remark:

1. Test results including cable loss;
2. Not recorded measured data from 9 KHz to 30 MHz as the values 20 dB lower than limit;
3. please refer to following plots;

Spurious Emission on Antenna Port

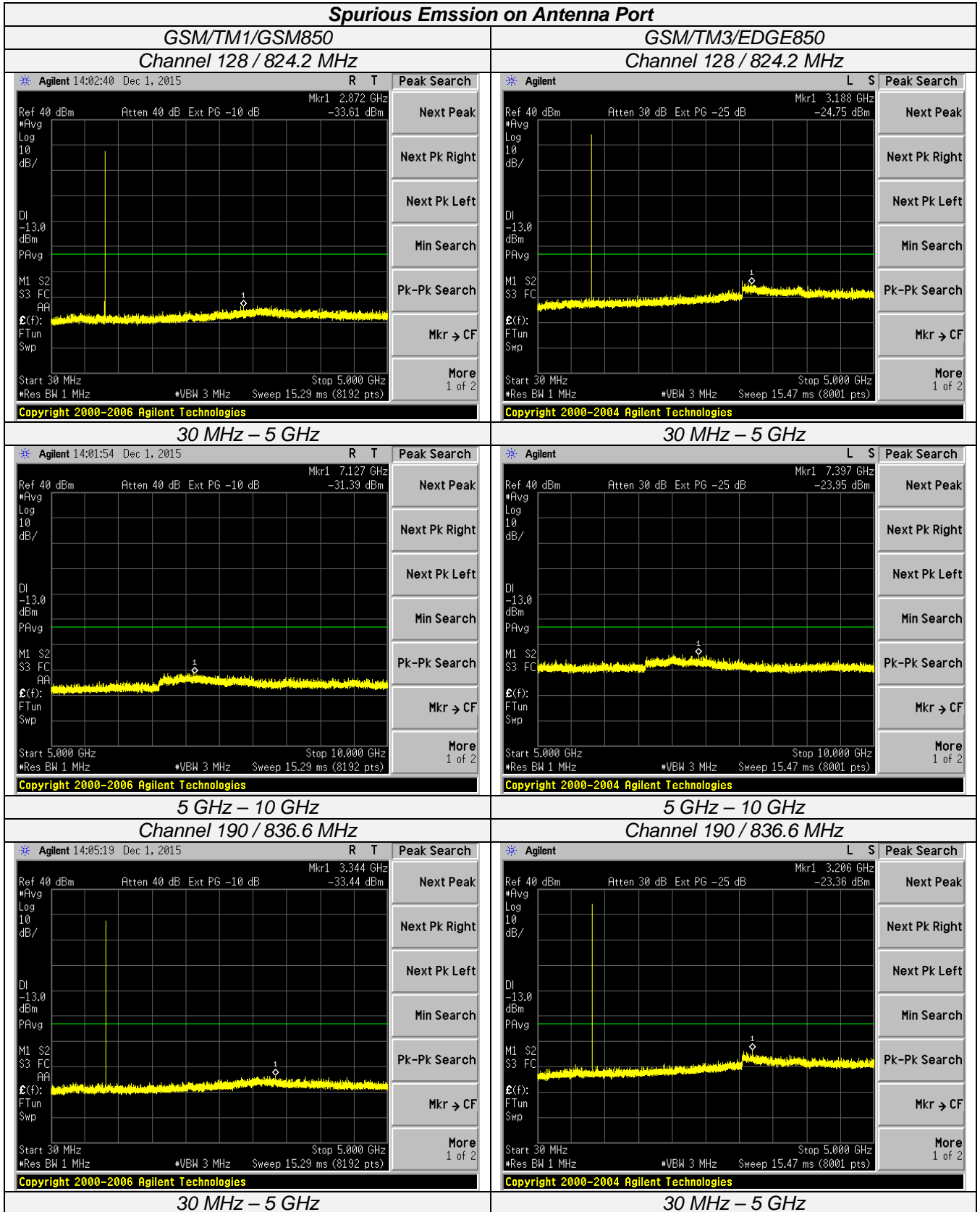

Spurious Emission on Antenna Port

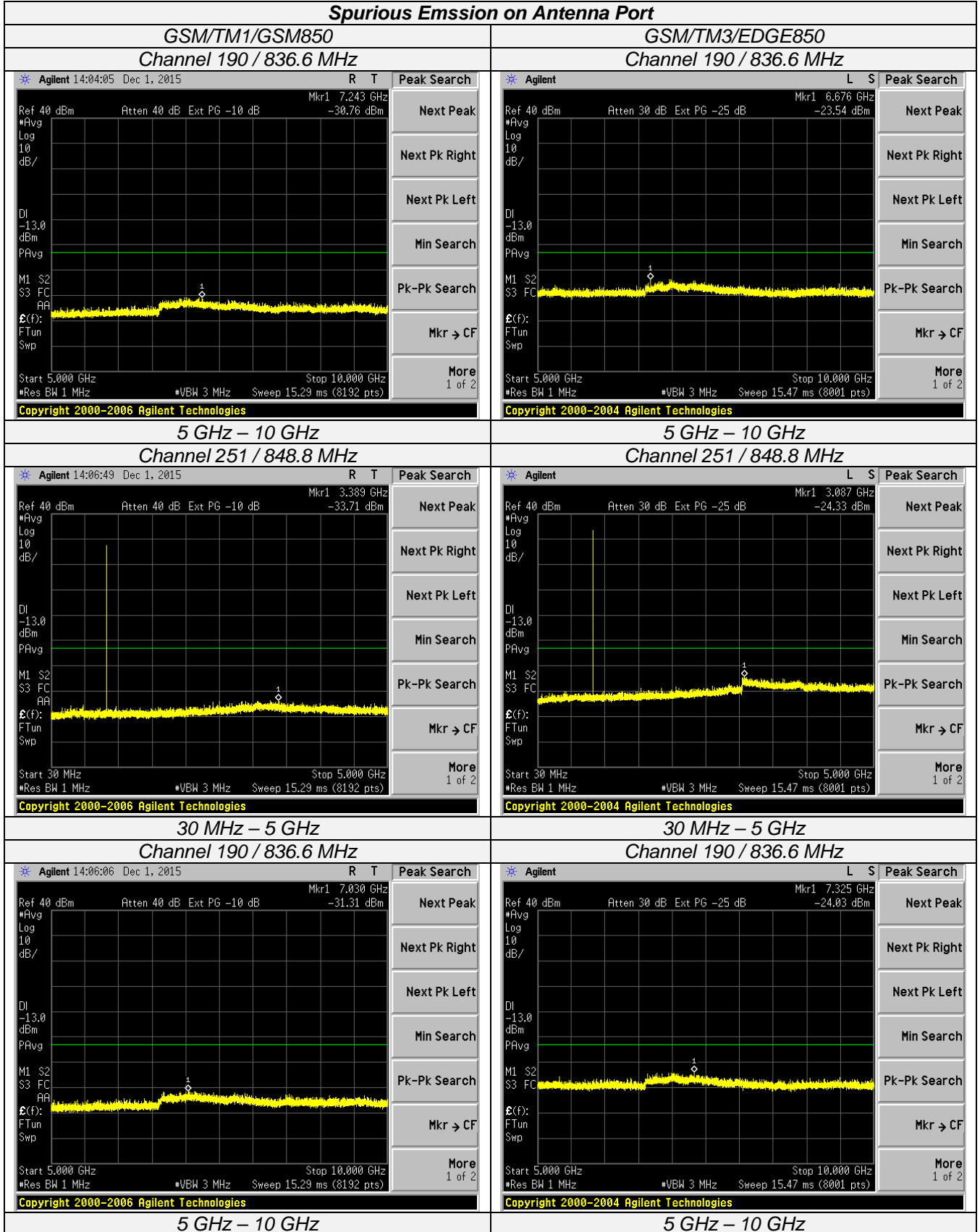

Spurious Emission on Antenna Port

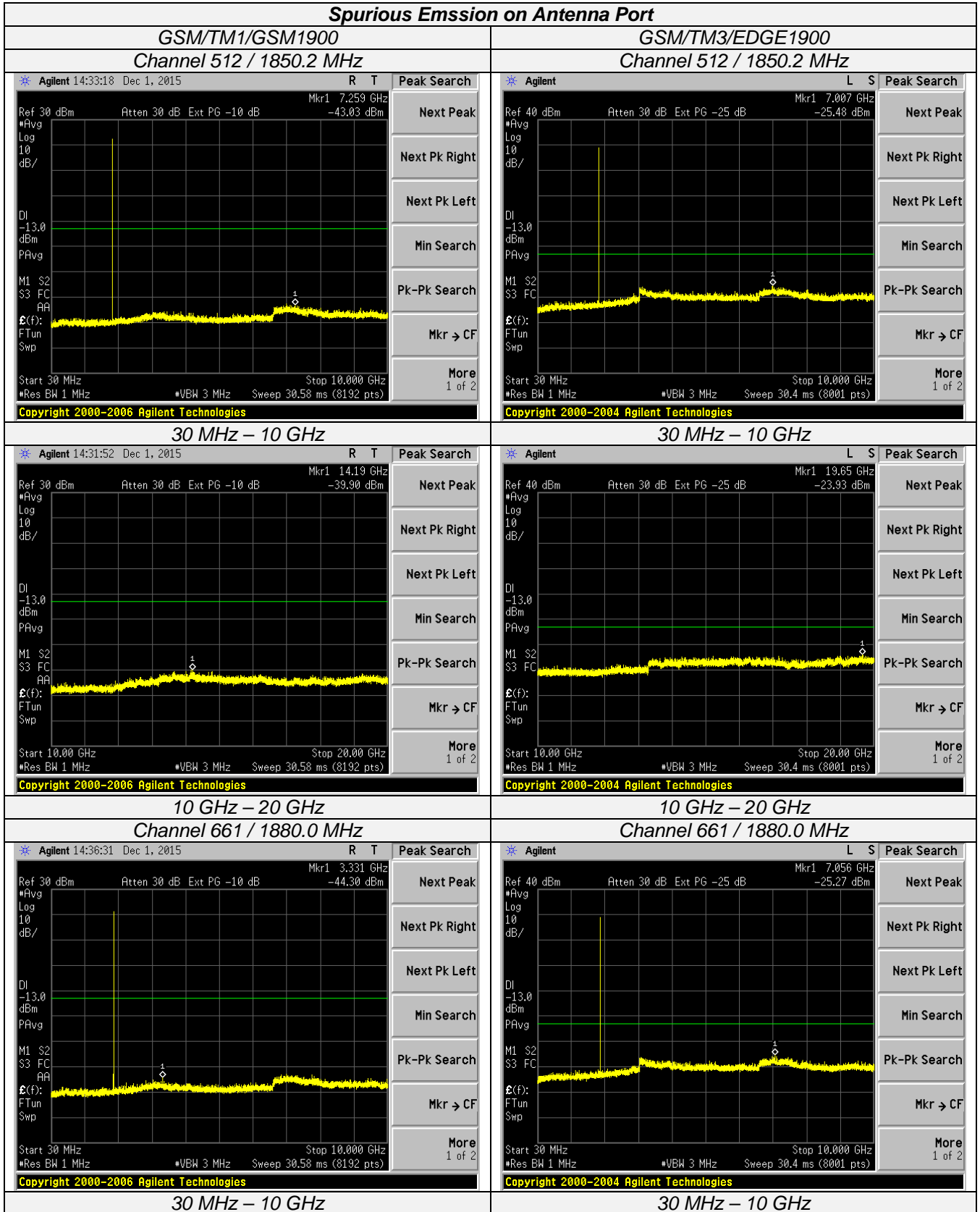

Spurious Emission on Antenna Port

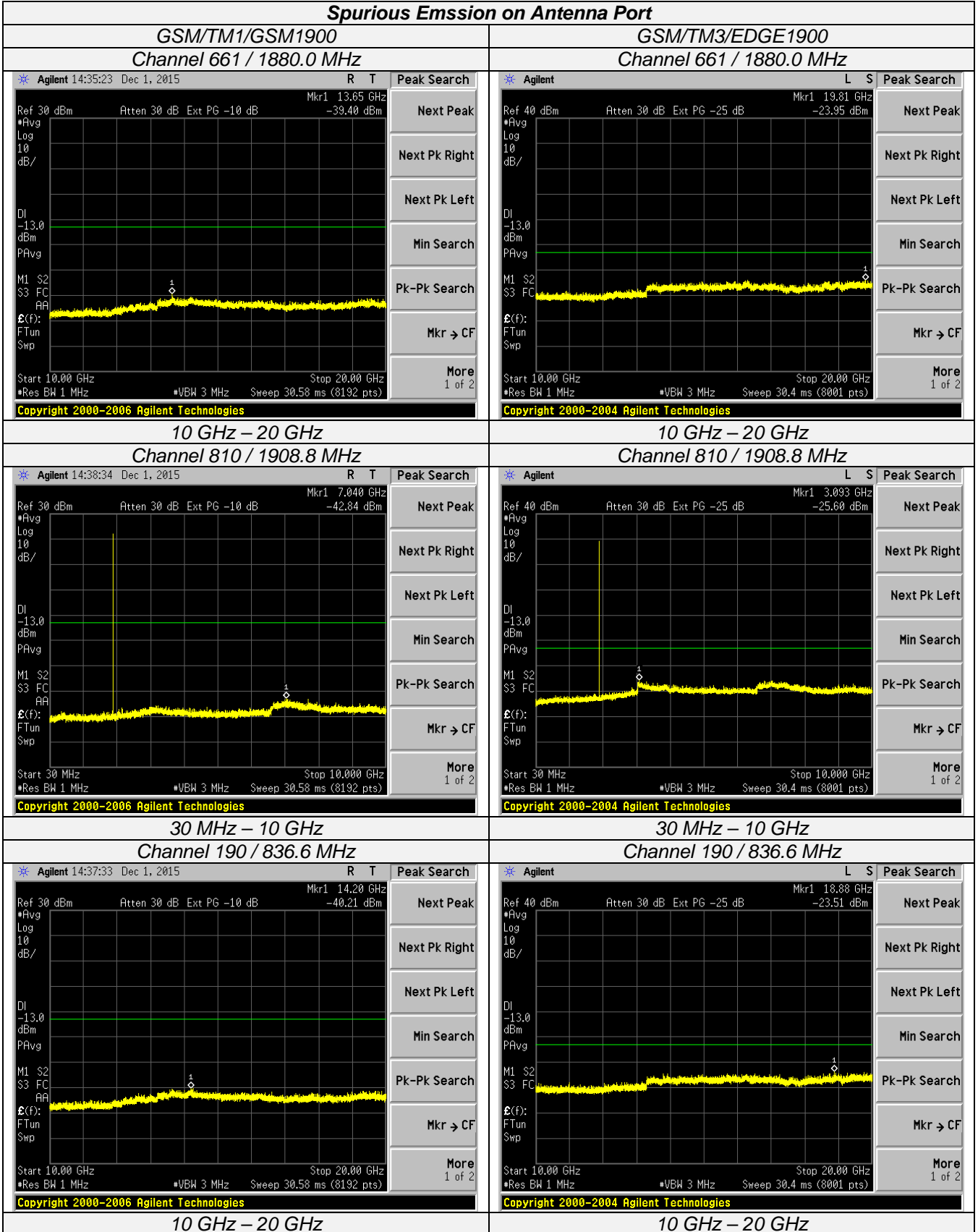

Spurious Emission on Antenna Port

UMTS/TM1/WCDMA Band V

Channel 4132 / 826.4 MHz

Channel 4183 / 836.6 MHz

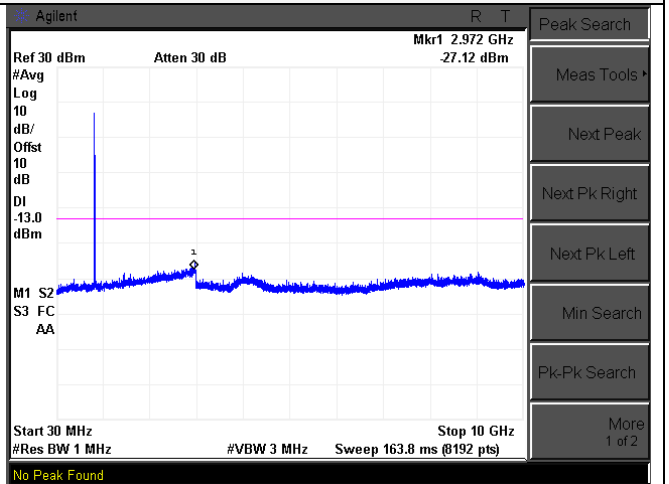
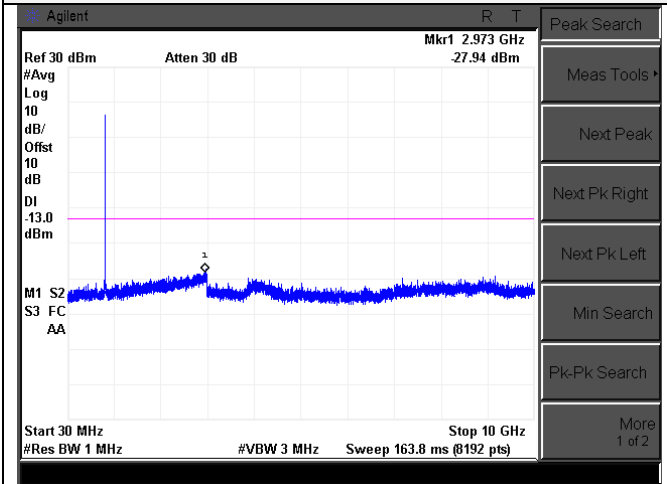

30 MHz – 10 GHz

30 MHz – 10 GHz

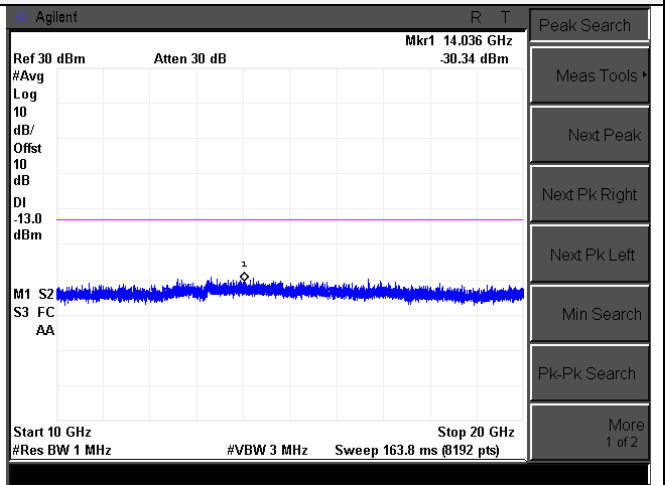
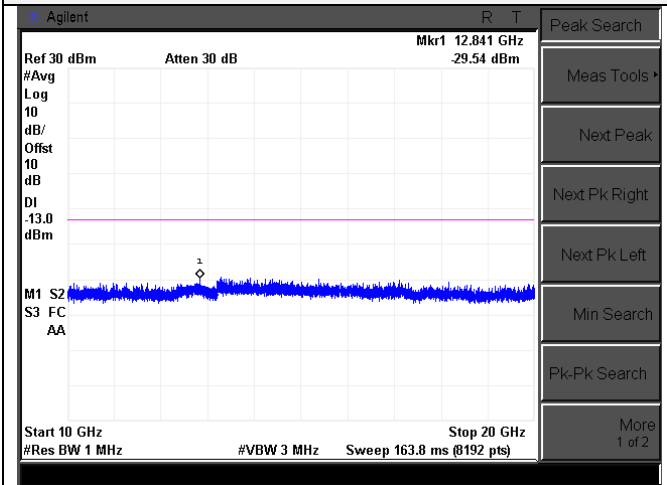

10 GHz – 20 GHz

10 GHz – 20 GHz

Channel 4233 / 846.6 MHz

Channel 4233 / 846.6 MHz

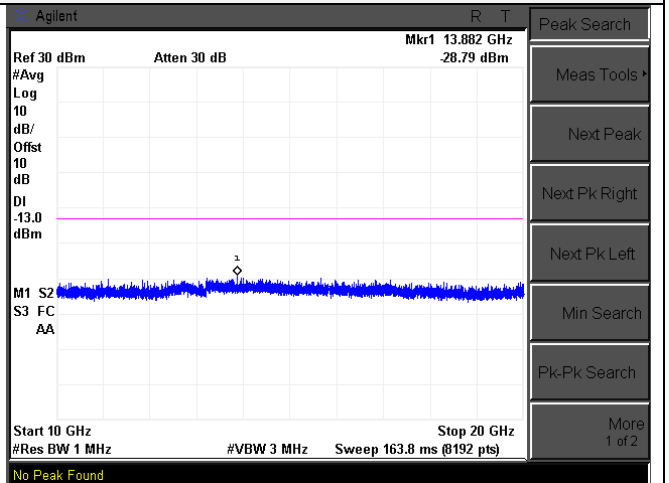
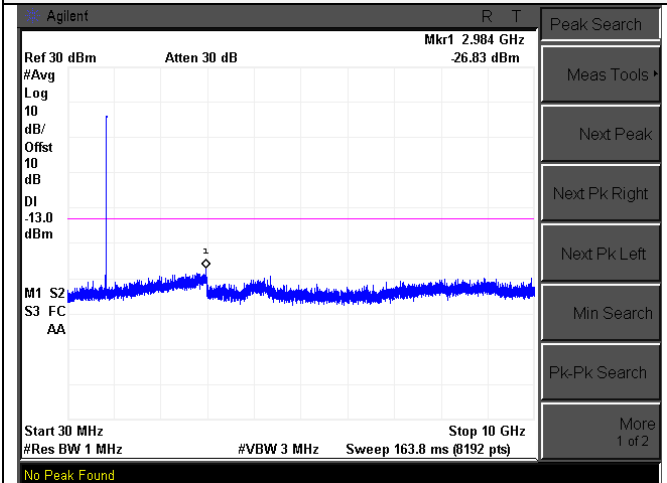

30 MHz – 10 GHz

10 GHz – 20 GHz

Spurious Emission on Antenna Port

UMTS/TM1/WCDMA Band II

Channel 9262 / 1852.4 MHz

Channel 9400 / 1880.0 MHz

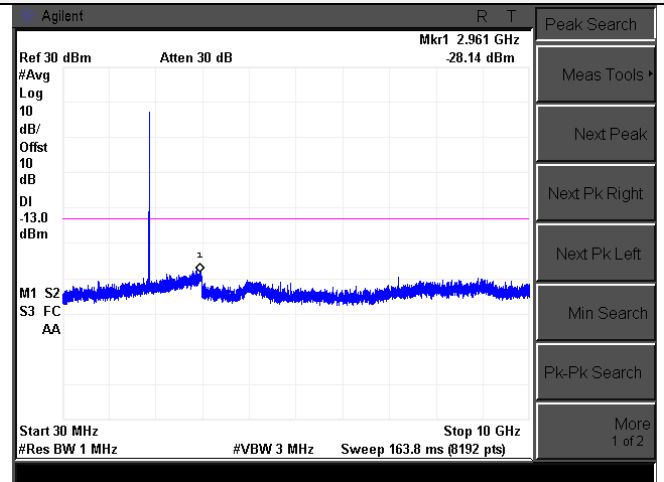
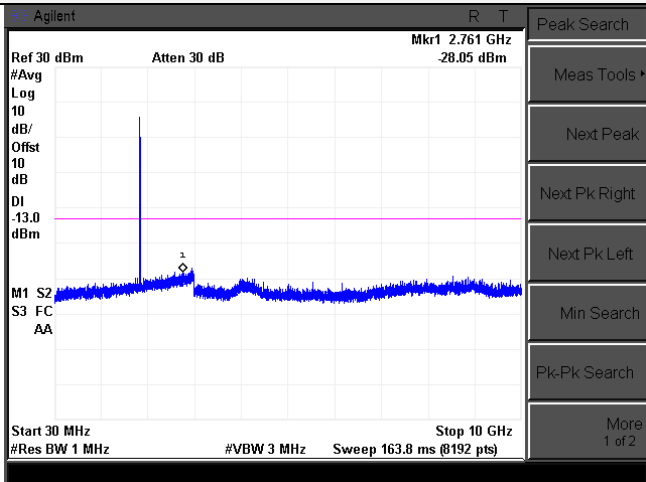

30 MHz – 10 GHz

30 MHz – 10 GHz

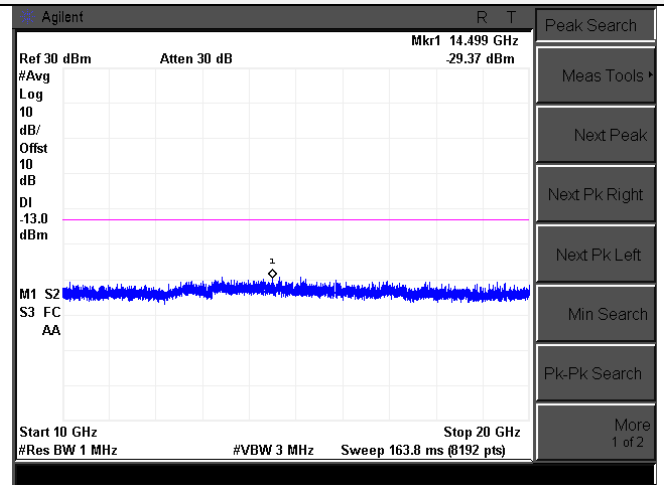
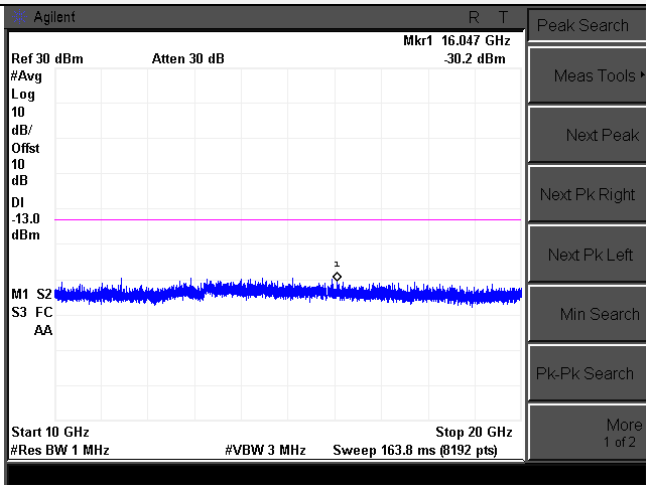

10 GHz – 20 GHz

10 GHz – 20 GHz

Channel 9538 / 1907.6 MHz

Channel 9538 / 1907.6 MHz

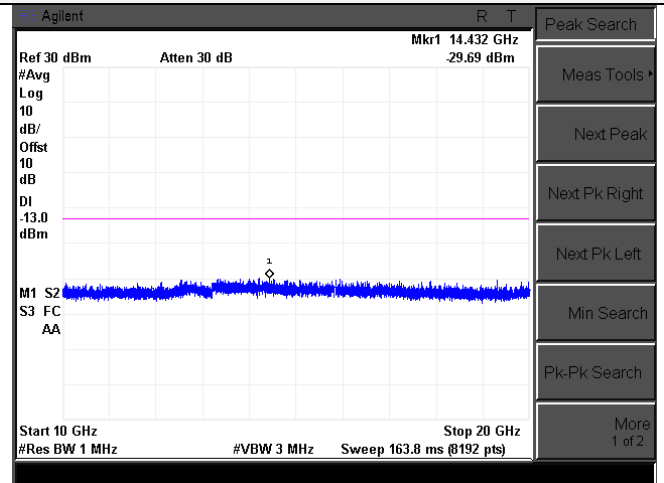
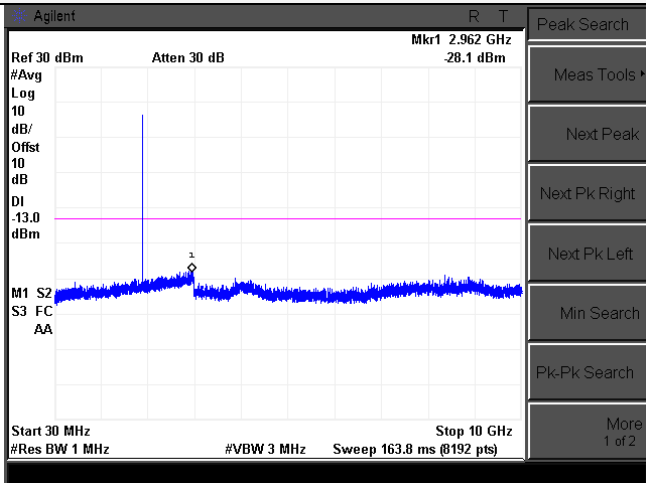

30 MHz – 10 GHz

10 GHz – 20 GHz

4.6 Frequency Stability Test

TEST APPLICABLE

1. According to FCC Part 2 Section 2.1055 (a)(1), the frequency stability shall be measured with variation of ambient temperature from -30°C to +50°C centigrade.
2. According to FCC Part 2 Section 2.1055 (E) (2), for battery powered equipment, the frequency stability shall be measured with reducing primary supply voltage to the battery operating end point, which is specified by the manufacture.
3. Vary primary supply voltage from 85 to 115 percent of the nominal value for other than hand carried voltage equipment and the end voltage point was 3.50V.

TEST PROCEDURE

In order to measure the carrier frequency under the condition of AFC lock, it is necessary to make measurements with the EUT in a "call mode". This is accomplished with the use of R&S CMU200 DIGITAL RADIO COMMUNICATION TESTER.

1. Measure the carrier frequency at room temperature;
2. Subject the EUT to overnight soak at -10°C;
3. With the EUT, powered via nominal voltage, connected to the CMU200 and in a simulated call on middle channel of GSM 850 / EDGE 850 /GSM 1900 / EDGE 1900 / WCDMA Band II/ WCDMA Band V, measure the carrier frequency. These measurements should be made within 2 minutes of Powering up the EUT, to prevent significant self-warming;
4. Repeat the above measurements at 10°C increments from -10°C to +50°C. Allow at least 0.5 hours at each temperature, unpowered, before making measurements;
5. Remeasure carrier frequency at room temperature with nominal voltage. Vary supply voltage from minimum voltage to maximum voltage, in 0.1Volt increments remeasuring carrier frequency at each voltage. Pause at nominal voltage for 0.5 hours unpowered, to allow any self-heating to stabilize, before continuing;
6. Subject the EUT to overnight soak at +50°C;
7. With the EUT, powered via nominal voltage, connected to the CMU200 and in a simulated call on the centre channel, measure the carrier frequency. These measurements should be made within 2 minutes of Powering up the EUT, to prevent significant self-warming;
8. Repeat the above measurements at 10°C increments from +50°C to -30°C. Allow at least 0.5 hours at each temperature, unpowered, before making measurements;
9. At all temperature levels hold the temperature to +/- 0.5°C during the measurement procedure;

TEST CONFIGURATION

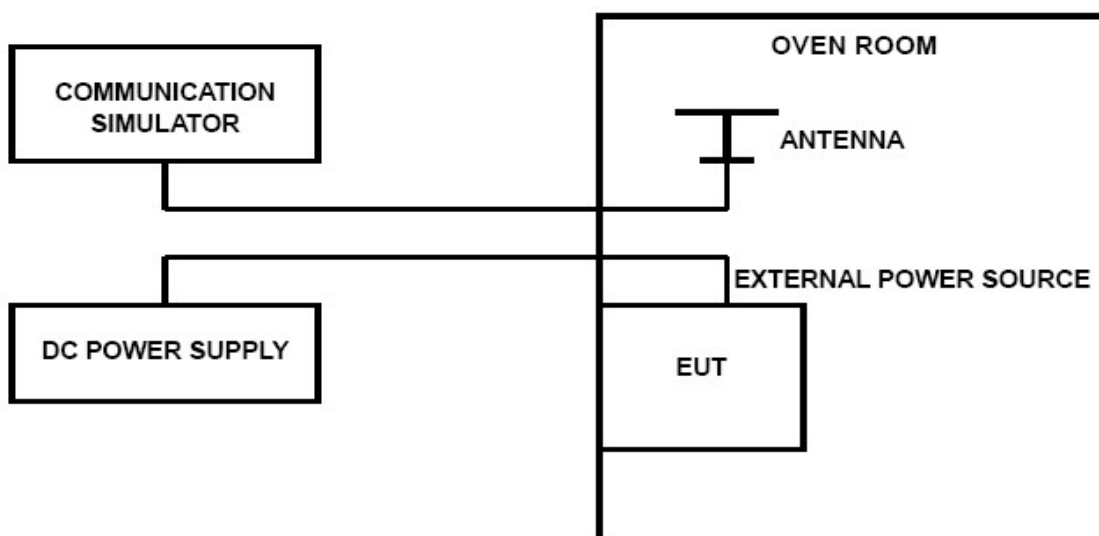

TEST LIMITS

For Hand carried battery powered equipment

According to the JTC standard the frequency stability of the carrier shall be accurate to within 0.1 ppm of the received frequency from the base station. This accuracy is sufficient to meet Sec. 24.235, Frequency Stability. The frequency stability shall be sufficient to ensure that the fundamental emission stays within the authorized

frequency block. As this transceiver is considered "Hand carried, battery powered equipment" Section 2.1055(d)(2) applies. This requires that the lower voltage for frequency stability testing be specified by the manufacturer. This transceiver is specified to operate with an input voltage of between 3.40VDC and 4.25VDC, with a nominal voltage of 3.80DC. Operation above or below these voltage limits is prohibited by transceiver software in order to prevent improper operation as well as to protect components from overstress. These voltages represent a tolerance of -10 % and +12.5 %. For the purposes of measuring frequency stability these voltage limits are to be used.

For equipment powered by primary supply voltage

According to the JTC standard the frequency stability of the carrier shall be accurate to within 0.1 ppm of the received frequency from the base station. This accuracy is sufficient to meet Sec. 24.235, Frequency Stability. The frequency stability shall be sufficient to ensure that the fundamental emission stays within the authorized frequency block. For this EUT section 2.1055(d)(1) applies. This requires varying primary supply voltage from 85 to 115 percent of the nominal value for other than hand carried battery equipment.

TEST RESULTS

Remark:

1. Subject the EUT to overnight soak at -10 °C;

GSM/TM1/GSM850					
DC Power	Temperature (°C)	Frequency error(Hz)	Frequency error(ppm)	Limit (ppm)	Verdict
3.50	20	26	0.031	2.50	PASS
3.70	20	27	0.032	2.50	PASS
4.20	20	12	0.014	2.50	PASS
3.70	-10	33	0.039	2.50	PASS
3.70	0	22	0.026	2.50	PASS
3.70	10	25	0.030	2.50	PASS
3.70	20	31	0.037	2.50	PASS
3.70	30	18	0.022	2.50	PASS
3.70	40	19	0.023	2.50	PASS
3.70	50	25	0.030	2.50	PASS

GSM/TM3/EDGE850					
DC Power	Temperature (°C)	Frequency error(Hz)	Frequency error(ppm)	Limit (ppm)	Verdict
3.50	25	21	0.025	2.50	PASS
3.70	25	9	0.011	2.50	PASS
4.20	25	24	0.029	2.50	PASS
3.70	-10	22	0.026	2.50	PASS
3.70	0	31	0.037	2.50	PASS
3.70	10	16	0.019	2.50	PASS
3.70	20	19	0.023	2.50	PASS
3.70	30	24	0.029	2.50	PASS
3.70	40	24	0.029	2.50	PASS
3.70	50	11	0.013	2.50	PASS

GSM/TM1/GSM1900					
DC Power	Temperature (°C)	Frequency error(Hz)	Frequency error(ppm)	Limit (ppm)	Verdict
3.50	25	34	0.018	2.50	PASS
3.70	25	36	0.019	2.50	PASS
4.20	25	28	0.015	2.50	PASS
3.70	-10	18	0.010	2.50	PASS
3.70	0	22	0.012	2.50	PASS
3.70	10	30	0.016	2.50	PASS
3.70	20	34	0.018	2.50	PASS
3.70	30	18	0.010	2.50	PASS
3.70	40	24	0.013	2.50	PASS
3.70	50	19	0.010	2.50	PASS

GSM/TM3/EDGE1900					
DC Power	Temperature (°C)	Frequency error(Hz)	Frequency error(ppm)	Limit (ppm)	Verdict
3.50	25	15	0.008	2.50	PASS
3.70	25	38	0.020	2.50	PASS
4.20	25	33	0.018	2.50	PASS
3.70	-10	29	0.015	2.50	PASS
3.70	0	14	0.007	2.50	PASS
3.70	10	30	0.016	2.50	PASS
3.70	20	26	0.014	2.50	PASS
3.70	30	30	0.016	2.50	PASS
3.70	40	22	0.012	2.50	PASS
3.70	50	8	0.004	2.50	PASS

UMTS/TM1/WCDMA Band II					
DC Power	Temperature (°C)	Frequency error(Hz)	Frequency error(ppm)	Limit (ppm)	Verdict
3.50	20	26	0.014	2.50	PASS
3.70	20	21	0.011	2.50	PASS
4.20	20	19	0.010	2.50	PASS
3.70	-10	33	0.018	2.50	PASS
3.70	0	21	0.011	2.50	PASS
3.70	10	18	0.010	2.50	PASS
3.70	20	17	0.009	2.50	PASS
3.70	30	24	0.013	2.50	PASS
3.70	40	32	0.017	2.50	PASS
3.70	50	29	0.015	2.50	PASS

UMTS/TM1/WCDMA Band V					
DC Power	Temperature (°C)	Frequency error(Hz)	Frequency error(ppm)	Limit (ppm)	Verdict
3.50	20	18	0.022	2.50	PASS
3.70	20	29	0.035	2.50	PASS
4.20	20	22	0.026	2.50	PASS
3.70	-10	25	0.030	2.50	PASS
3.70	0	24	0.029	2.50	PASS
3.70	10	33	0.039	2.50	PASS
3.70	20	26	0.031	2.50	PASS
3.70	30	21	0.025	2.50	PASS
3.70	40	19	0.023	2.50	PASS
3.70	50	27	0.032	2.50	PASS

4.7 Peak-to-Average Ratio (PAR)

LIMIT

The Peak-to-Average Ratio (PAR) of the transmission may not exceed 13 dB.

TEST CONFIGURATION

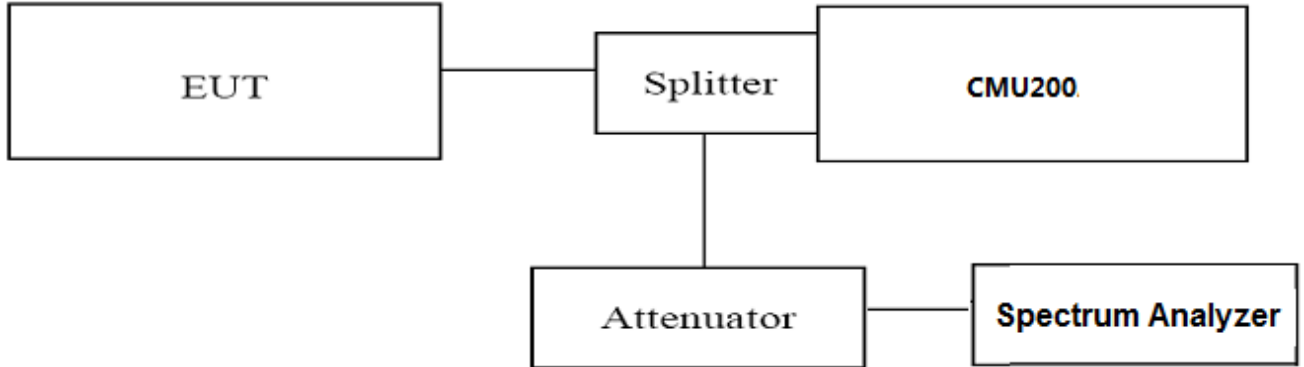

TEST PROCEDURE

For UMTS

1. Refer to instrument's analyzer instruction manual for details on how to use the power statistics/CCDF function;
2. Set resolution/measurement bandwidth \geq signal's occupied bandwidth;
3. Set the number of counts to a value that stabilizes the measured CCDF curve;
4. Set the measurement interval as follows:
 - 1). for continuous transmissions, set to 1 ms,
 - 2). for burst transmissions, employ an external trigger that is synchronized with the EUT burst timing sequence, or use the internal burst trigger with a trigger level that allows the burst to stabilize and set the measurement interval to a time that is less than or equal to the burst duration.
5. Record the maximum PAPR level associated with a probability of 0.1%.

For GSM/EDGE

Use spectrum to measure the total peak power and record as P_{Pk} . Use spectrum to measure the total average power and record as P_{Avg} . Both the peak and average power levels must be expressed in the same logarithmic units (e.g., dBm).

Determine the PAPR from:
 $PAPR (dB) = P_{Pk} (dBm) - P_{Avg} (dBm)$.

TEST RESULTS

Test Mode	Channel	Frequency (MHz)	PAPR Value (dB)	Limits (dB)	Verdict
GSM/TM1/ GSM1900	512	1850.2	0.24	13.0	PASS
	661	1880.0	0.24	13.0	
	810	1908.8	0.24	13.0	
GSM/TM3/ EDGE1900	512	1850.2	3.16	13.0	PASS
	661	1880.0	3.28	13.0	
	810	1908.8	3.22	13.0	
UMTS/TM1/ WCDMA Band II	9262	1852.4	2.83	13.0	PASS
	9400	1880.0	2.46	13.0	
	9538	1907.6	2.88	13.0	

Remark:

1. Test results including cable loss;
2. please refer to following plots;

Peak-to-Average Ratio (PAR)

UMTS/TM1/ WCDMA Band II

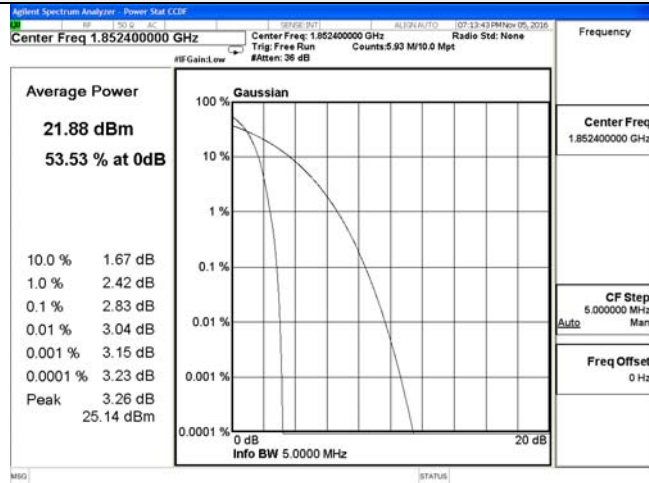

Channel 9262 / 1852.4 MHz

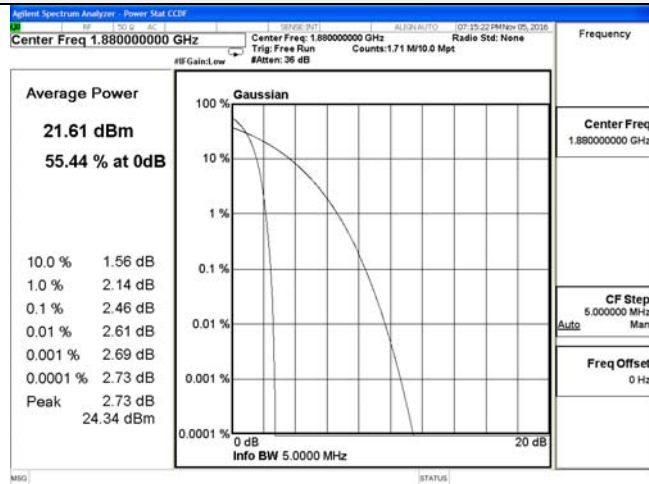

Channel 9400 / 1880.0 MHz

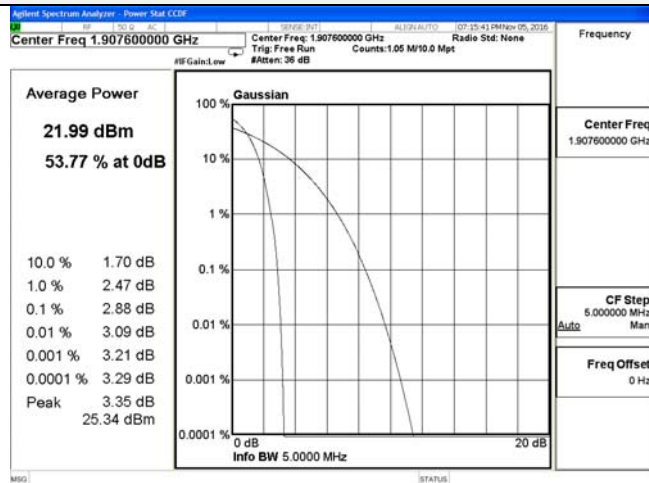

Channel 9538 / 1907.6 MHz

5 Test Setup Photos of the EUT

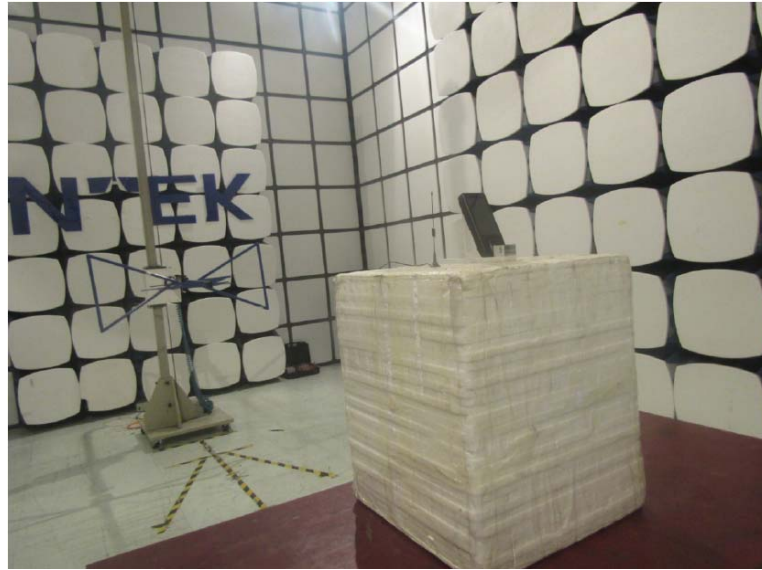

6 External Photos of the EUT

Please refer to separated files for External Photos of the EUT.

7 Internal Photos of the EUT

Please refer to separated files for Internal Photos of the EUT.

.....End of Report.....