

FCC/IC TEST REPORT

for

Audio Components International, Inc.

Wireless

Model Number: ES-SUB-WIRELESS-KIT,

ES-SUB-WIRELESS-RCVR

FCC ID:2AGTUWIRELESS

IC:20907-WIRELESS

Prepared for : Audio Components International, Inc.
Address : 27520 Hawthorne Blvd., Suite 169, Rolling Hills Estates,
CA 90274, USA

Prepared by : Keyway Testing Technology Co., Ltd.
Address : Baishun Industrial Zone, Zhangmutou Town,
Dongguan, Guangdong, China

Tel: 86-769-8718 2258
Fax: 86-769-8718 1058

Report No. : 16KWE094431F
Date of Test : Sep.05~Sep.26,2016
Date of Report : Sep.27, 2016

TABLE OF CONTENTS

	Page
Test Report Declaration	
1. TEST SUMMARY.....	4
2. GENERAL PRODUCT INFORMATION.....	5
2.1 Product Function	5
2.2 Description of Device (EUT).....	5
2.3 Test Supporting System.....	5
2.4 Independent Operation Modes.....	6
2.5 TEST SITES	6
2.6 List of Test and Measurement Instruments.....	7
3. TEST SET-UP AND OPERATION MODES	8
3.1 Principle of Configuration Selection	8
3.2 Block Diagram of Test Set-up	8
3.3 Special Accessories and Auxiliary Equipment.....	8
3.4 Countermeasures to Achieve EMC Compliance.....	8
4. EMISSION TEST RESULTS.....	9
4.1 Conducted Emission at the Mains Terminals Test	9
4.2 Radiated Emission Test	14
5. BAND EDGE COMPLIANCE TEST.....	32
5.1 Limits	32
5.2 Test setup.....	32
5.3 Test Data	32
6. 26DB AND 6DB BANDWIDTH TEST	36
6.1 Applicable Standard.....	36
6.2 Test Procedure	36
6.3 Test setup.....	36
7. OUTPUT POWER TEST	47
7.1 Limits	47
7.2 Test setup.....	47
7.3 Test result.....	48
8. PEAK POWER SPECTRAL DENSITY TEST.....	52
8.1 Limits	52
8.2 Test setup.....	52
8.3 Test data.....	52
9. FREQUENCY STABILITY TEST	60
9.1 limit	60
9.2 Test Configuration.....	60
9.3 test procedure.....	60
10. ANTENNA REQUIREMENTS.....	62
10.1 Limits.....	62
10.2 Result.....	62
11. PHOTOGRAPHS OF TEST SET-UP	63
12. PHOTOGRAPHS OF THE EUT	65

Keyway Testing Technology Co., Ltd.

Applicant: Address:	Audio Components International, Inc. 27520 Hawthorne Blvd., Suite 169, Rolling Hills Estates, CA 90274, USA		
Manufacturer: Address:	Audio Components International, Inc. 27520 Hawthorne Blvd., Suite 169, Rolling Hills Estates, CA 90274, USA		
E.U.T:	Wireless		
Model Number:	ES-SUB-WIRELESS-KIT, ES-SUB-WIRELESS-RCVR		
Trade Name:	Episode	Serial No.:	-----
Date of Receipt:	Sep.04,2016	Date of Test:	Sep.05~Sep.26,2016
Test Specification:	FCC Part 15, Subpart 15.407: 2015 ANSI C63.10:2013 KDB789033 D02 v01r03 RSS-247 Issue 1 May 2015 RSS-Gen Issue 4 November 2014		
Test Result:	The equipment under test was found to be compliance with the requirements of the standards applied.		
		Issue Date: Sep.27, 2016	
Tested by:	Reviewed by:	Approved by:	
			
_____ Keven Wu / Engineer	_____ Mike Xu / Supervisor	 _____ Andy Gao / Supervisor	
Other Aspects:	None.		
<i>Abbreviations: OK/P=passed fail/F=failed n.a/N=not applicable E.U.T=equipment under tested</i>			
<i>This test report is based on a single evaluation of one sample of above mentioned products. It is not permitted to be duplicated in extracts without written approval of Keyway Testing Technology Co., Ltd.</i>			

1. TEST SUMMARY

Test Items	Test Requirement	Result
Conducted Emissions	15.207 RSS-GEN, Section 8.8	PASS
Radiated Emissions	15.407(b), 15.209 &RSS-Gen §6.13	PASS
26dB bandwidth and 99%dB Bandwidth	15.407 (a) RSS-247 §5.2(1) &RSS-Gen§6.6	PASS
6dB bandwidth	15.407(e)	PASS
Power density	15.407 (a) & RSS-247 §6.2.1	PASS
Maximum Peak Output Power	15.407 (a) & RSS-247 §6.2.1	PASS
Emissions from out of band	15.407 (b) & RSS-247 §6.2.1	PASS
Frequency Stability	15.407 (g)	PASS
Antenna Requirement	15.203&RSS-Gen§8.3	PASS

2. GENERAL PRODUCT INFORMATION

2.1 Product Function

Refer to Technical Construction Form and User Manual.

2.2 Description of Device (EUT)

Product Name:	Wireless
Model No.:	ES-SUB-WIRELESS-KIT, ES-SUB-WIRELESS-RCVR
Model Difference	All the models are the same circuit and RF module, except the model names.
Operation Frequency:	5.18GHz ~ 5.24GHz, 5.736GHz~5.814GHz
Channel numbers:	3 Channel for 5.2G, 3 Channel for 5.8G
Modulation technology:	QPSK (DSSS)
Antenna Type:	PCB ANT
Antenna gain:	ANT A:2.408dBi ANT B:2.408dBi
Power supply:	DC 5V from adapter
Power supply:	Mode: GQ05-050050-CU Input: 100-240V~, 50/60Hz, 0.3A Max Output: 5V---,500mA

2.3 Channel List

Channel	Frequency (MHz)
01	5180
02	5210
03	5240
04	5736
05	5762
06	5814

2.4 Independent Operation Modes

The basic operation modes are:

EUT work TX mode, and frequency as below:

5.2G

Channel	Frequency
Low	5180
Middle	5210
High	5240

5.8G

Channel	Frequency
Low	5736
Middle	5762
High	5814

Remark: According to ANSI C63.10 standards, the test results are both the “worst case” and “worst setup”

2.5 Test Supporting System

Antenna A/ B are transmitting, two antennas simultaneously transmit. And the worst data is recorded for radiated emission and band edge.

For MIMO mode , Directional gain=GANT +10log(N)dbi =5.42dbi

The EUT has MIMO mode.

2.6 Product Version

Product SW version	100X-D1
Product HW version	100X-D1
Radio SW version	DWLC84-L2
Radio HW version	DWLC84-L2
Test SW Version	V1.0
RF power setting in TEST SW	3dBm for 5.2G, -6dBm for 5.8G

2.7 TEST SITES

Test Facilities

Lab Qualifications : Certificated by Industry Canada
 Registration No.: 9868A
 Date of registration: December 8, 2011

Certificated by FCC, USA
 Registration No.: 370994
 Date of registration: February 21, 2012

Certificated by CNAS China
 Registration No.: CNAS L5783
 Date of registration: August 8, 2012

2.8 List of Test and Measurement Instruments

For conducted emission at the mains terminals test

Equipment	Manufacturer	Model No.	Serial No.	Last Cal.	Next Cal.
EMI Test Receiver	Rohde&Schwarz	ESCI	101156	Apr. 27,16	Apr. 27,17
Artificial Mains Network	Rohde&Schwarz	ENV216	101315	Apr. 27,16	Apr. 27,17
Artificial Mains Network (AUX)	Rohde&Schwarz	ENV216	101314	Apr. 27,16	Apr. 27,17
RF Cable	FUJIKURA	3D-2W	944 Cable	Apr. 27,16	Apr. 27,17

For radiated emission test

Equipment	Manufacturer	Model No.	Serial No.	Last Cal.	Next Cal.
EMI Test Receiver	Rohde&Schwarz	ESCI	101156	Apr. 27,16	Apr. 27,17
System Simulator	Agilent	E5515C	GB43130245	Apr. 27,16	Apr. 27,17
Power Splitter	Weinschel	1506A	NW425	Apr. 27,16	Apr. 27,17
Bilog Antenna	ETS-LINDGREEN	3142D	135452	Apr. 27,16	Apr. 27,17
Spectrum Analyzer	Agilent	E4407B	MY4511304	Apr. 27,16	Apr. 27,17
Spectrum Analyzer	R&S	FSV40	132.1.3008K39-100967	Apr. 27,16	Apr. 27,17
3m Semi-anechoic Chamber	ETS-LINDGREEN	966	KW01	Apr. 27,16	Apr. 27,17
Signal Amplifier	SONOMA	310	187016	Apr. 27,16	Apr. 27,17
Signal Amplifier	Agilent	8449B	3008A00251	Apr. 27,16	Apr. 27,17
RF Cable	IMRO	IMRO-400	966 Cable 1#	N/A	N/A
MULTI-DEVICE Controller	ETS-LINDGREEN	2090	126913	N/A	N/A
Horn Antenna	DAZE	ZN30701	11003	Apr. 27,16	Apr. 27,17
Horn Antenna	SCHWARZBECK	BBHA9170	9170-068	Apr. 27,16	Apr. 27,17
Spectrum Analyzer	Agilent	8593E	3911A04271	Apr. 27,16	Apr. 27,17
Spectrum Analyzer	Agilent	E4408B	MY44211125	Apr. 27,16	Apr. 27,17
Signal Amplifier	DAZE	ZN3380C	11001	Apr. 27,16	Apr. 27,17
High Pass filter	Micro	HPM50111	324216	Apr. 27,16	Apr. 27,17
Filter	COM-MW	ZBSF-C836.5-25-X	KW032	Apr. 27,16	Apr. 27,17
Filter	COM-MW	ZBSF-C1747.5-75-X2	KW035	Apr. 27,16	Apr. 27,17
Filter	COM-MW	ZBSF-C1880-60-X2	KW037	Apr. 27,16	Apr. 27,17
Constant temperature and humidity box	GF	GTH-800-40-1P	MAA9906-005	Apr. 27,16	Apr. 27,17
Splitter	Agilent	11636B	0025164	Apr. 27,16	Apr. 27,17
Power Meter	Anritsu	ML2495A	1204003	Apr. 24,16	Apr. 24,17
Power Sensor	Anritsu	MA2411B	1126150	Apr. 24,16	Apr. 24,17

3. TEST SET-UP AND OPERATION MODES

3.1 Principle of Configuration Selection

Emission: The equipment under test (EUT) was configured to measure its highest possible radiation level. The test modes were adapted accordingly in reference to the Operating Instructions.

3.2 Block Diagram of Test Set-up

System Diagram of Connections between EUT and Simulators

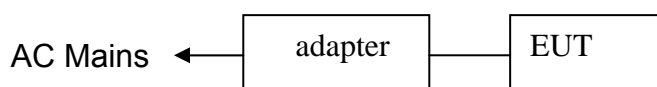

(EUT: Wireless)

3.3 Special Accessories and Auxiliary Equipment

None.

3.4 Countermeasures to Achieve EMC Compliance

None.

4. EMISSION TEST RESULTS

4.1 Conducted Emission at the Mains Terminals Test

Limit 15.207 limits

FREQUENCY OF EMISSION (MHz)	CONDUCTED LIMIT (dB μ V)	
	Quasi-peak	Average
0.15-0.5	66 to 56	56 to 46
0.5-5	56	46
5-30	60	50

Test Setup

The EUT was put on a wooden table which was 0.8 m high above the ground and connected to the AC mains through the Artificial Mains Network (AMN). Where the mains cable supplied by the manufacture was longer than 0.8 m, the excess was folded back and forth parallel to the cable at the centre so as to form a bundle no longer than 0.4 m.

The EUT was kept 0.4 m from any other earthed conducting surface. Both sides of AC line were checked to find out the maximum conducted emission levels according to the test procedure during the conducted emission test.

The frequency range from 150 kHz to 30 MHz was investigated.

The bandwidth of the test receiver was set at 9 kHz.

Pretest for all mode, The test data of the worst case condition(s) was reported on the following page.

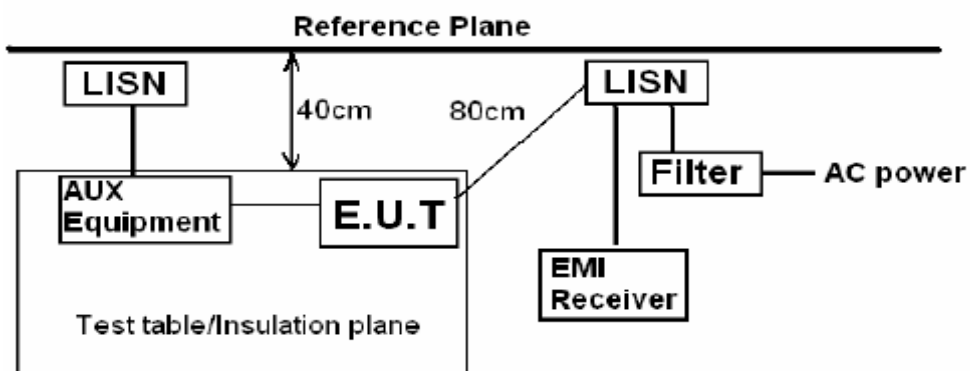

Remark:
 E.U.T: Equipment Under Test
 LISN: Line Impedance Stabilization Network
 Test table height=0.8m

EUT :	Wireless	Model Name :	ES-SUB-WIRELESS-KIT
Temperature :	26 °C	Relative Humidity :	54%
Pressure :	1010hPa	Phase :	L
Test Voltage :	DC 5.0V from Adapter AC 120V/60Hz	Test Mode :	Link Mode

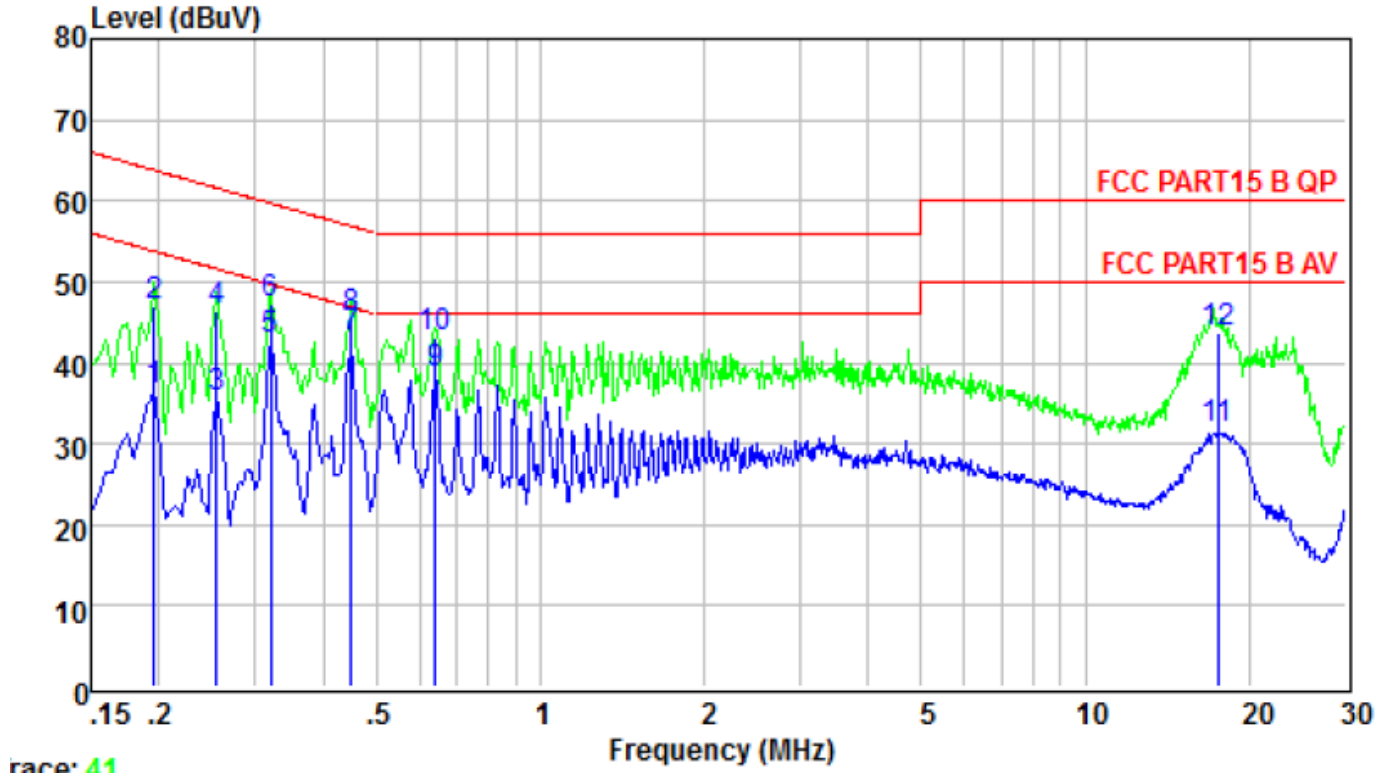

	Freq	Level	Limit	Over	Remark
	MHz	dBuV	Line	Limit	
			dBuV	dB	
1	0.195	36.62	53.80	-17.18	Average
2	0.195	47.10	63.80	-16.70	QP
3	0.255	35.77	51.60	-15.83	Average
4	0.255	46.26	61.60	-15.34	QP
5	0.320	42.68	49.71	-7.03	Average
6	0.320	47.20	59.71	-12.51	QP
7	0.449	43.00	46.89	-3.89	Average
8	0.449	45.50	56.89	-11.39	QP
9	0.641	38.78	46.00	-7.22	Average
10	0.641	43.03	56.00	-12.97	QP
11	17.475	31.82	50.00	-18.18	Average
12	17.475	43.58	60.00	-16.42	QP

EUT :	Wireless	Model Name :	ES-SUB-WIRELESS-KIT
Temperature :	26 °C	Relative Humidity :	54%
Pressure :	1010hPa	Phase :	N
Test Voltage :	DC 5.0V from Adapter AC 120V/60Hz	Test Mode :	Link Mode

Neutral

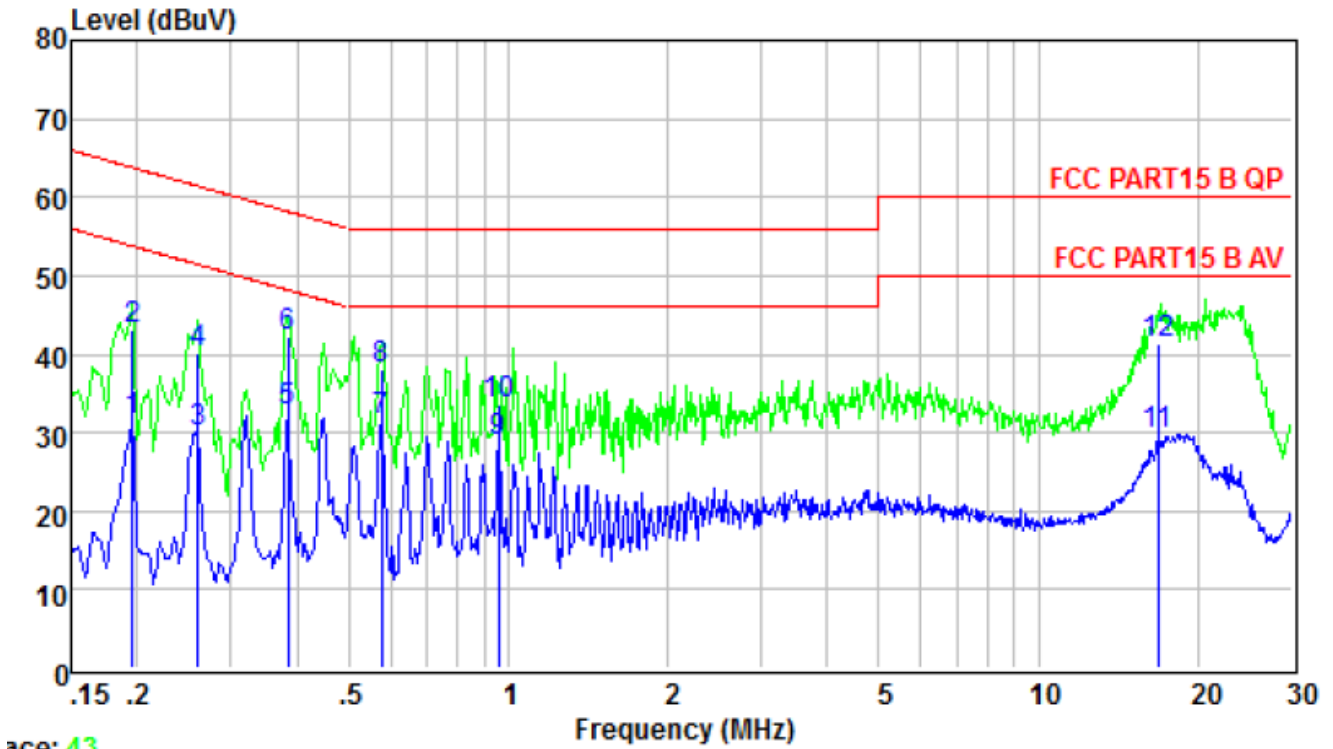

acc: 43

	Freq	Level	Limit	Over	Remark
	MHz	dBuV	dBuV	dB	
1	0.195	31.57	53.80	-22.23	Average
2	0.195	43.25	63.80	-20.55	QP
3	0.260	30.06	51.42	-21.36	Average
4	0.260	40.13	61.42	-21.29	QP
5	0.385	32.58	48.17	-15.59	Average
6	0.385	42.26	58.17	-15.91	QP
7	0.576	31.52	46.00	-14.48	Average
8	0.576	38.14	56.00	-17.86	QP
9	0.958	28.96	46.00	-17.04	Average
10	0.958	33.48	56.00	-22.52	QP
11	16.750	29.74	50.00	-20.26	Average
12	16.750	41.26	60.00	-18.74	QP

EUT :	Wireless	Model Name :	ES-SUB-WIRELESS-KIT
Temperature :	26 °C	Relative Humidity :	54%
Pressure :	1010hPa	Phase :	L
Test Voltage :	DC 5.0V from Adapter AC 240V/60Hz	Test Mode :	Link Mode

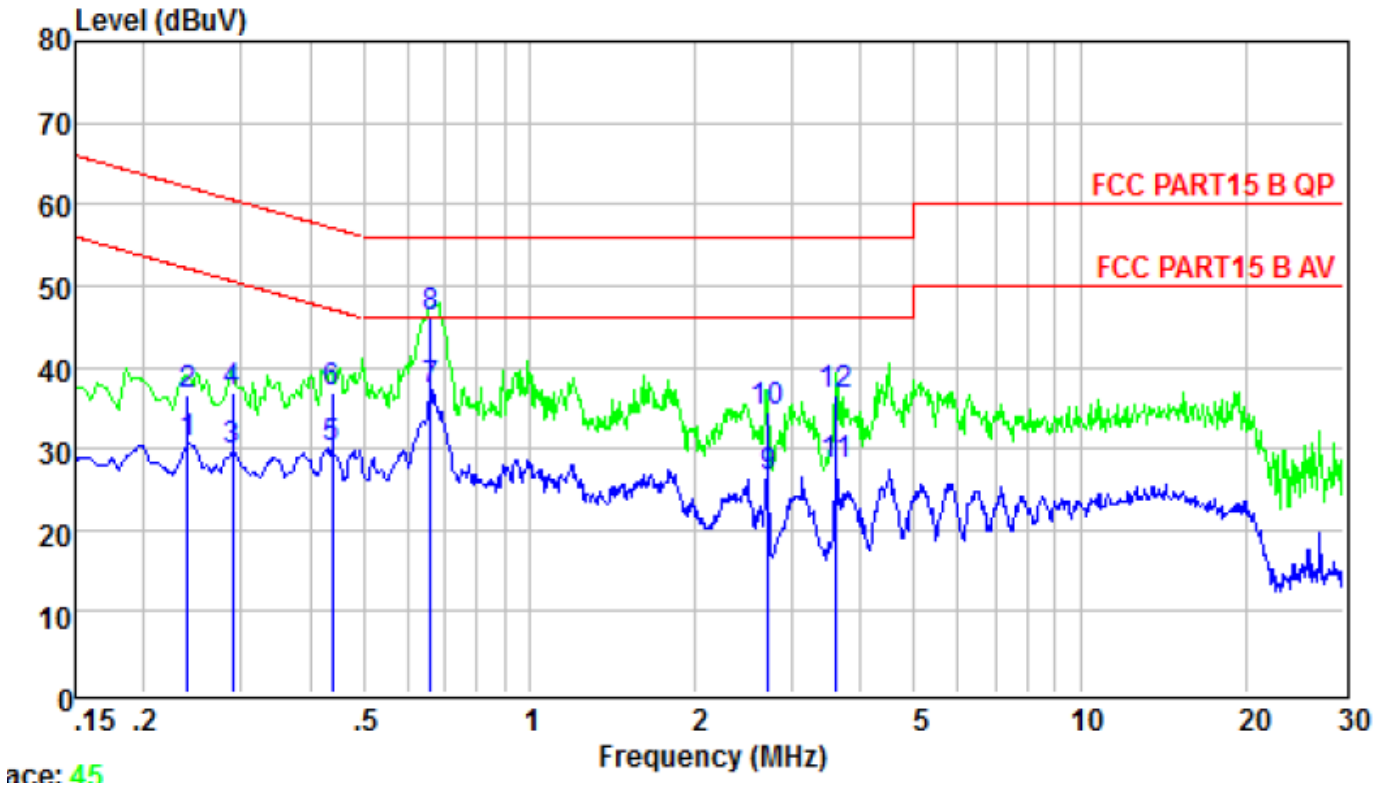

	Freq	Level	Limit	Over	Remark
	MHz	dBuV	dBuV	dB	
1	0.240	30.69	52.08	-21.39	Average
2	0.240	36.69	62.08	-25.39	QP
3	0.289	29.88	50.54	-20.66	Average
4	0.289	36.89	60.54	-23.65	QP
5	0.440	30.11	47.07	-16.96	Average
6	0.440	36.89	57.07	-20.18	QP
7	0.661	37.13	46.00	-8.87	Average
8	0.661	46.23	56.00	-9.77	QP
9	2.707	26.57	46.00	-19.43	Average
10	2.707	34.59	56.00	-21.41	QP
11	3.603	27.86	46.00	-18.14	Average
12	3.603	36.59	56.00	-19.41	QP

EUT :	Wireless	Model Name :	ES-SUB-WIRELESS-KIT
Temperature :	26 °C	Relative Humidity :	54%
Pressure :	1010hPa	Phase :	N
Test Voltage :	DC 5.0V from Adapter AC 240V/60Hz	Test Mode :	Link Mode

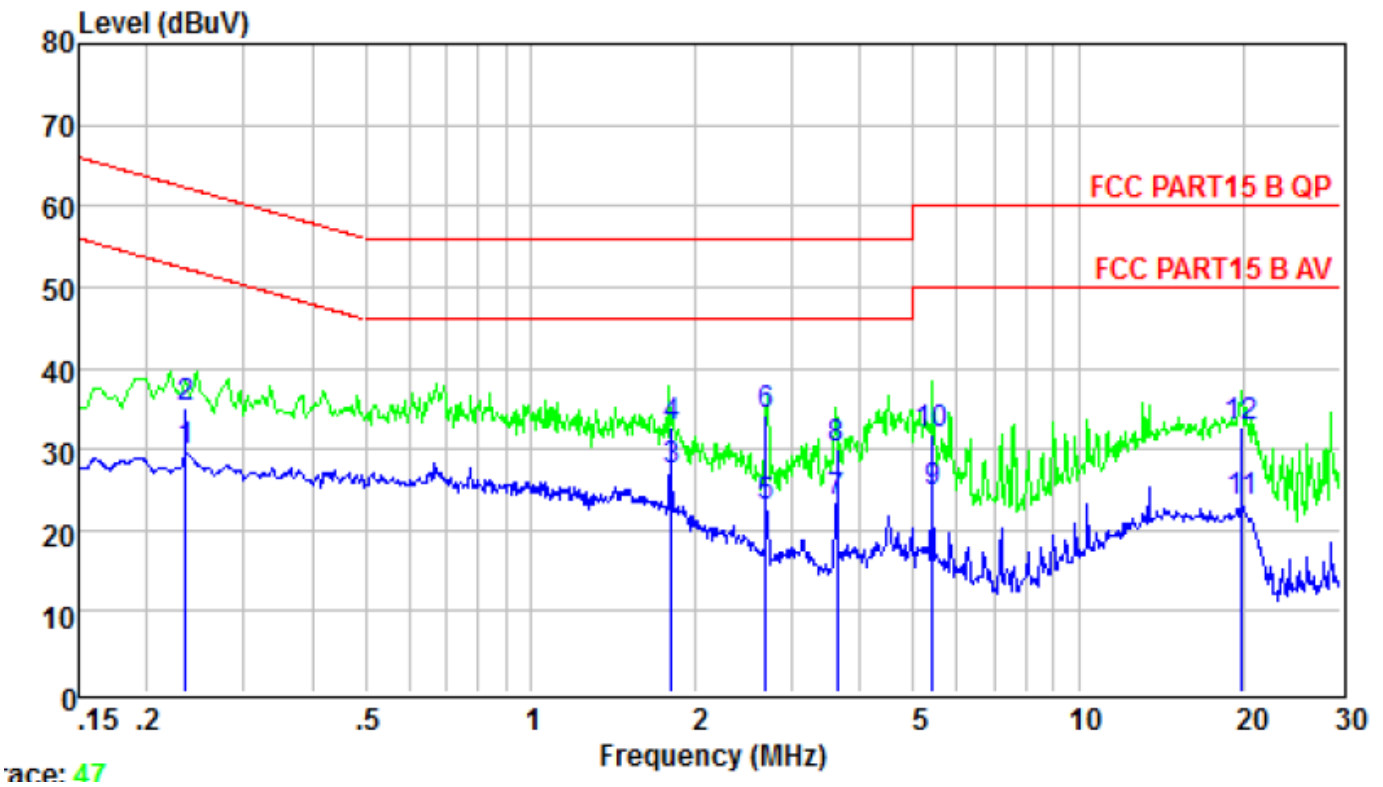

Trace: 47

	Limit	Over		
Line	Line	Limit	Remark	
	dBuV	dB		
1	52.26	-22.65	Average	
2	62.26	-27.14	QP	
3	46.00	-18.60	Average	
4	56.00	-23.37	QP	
5	46.00	-23.07	Average	
6	56.00	-21.88	QP	
7	46.00	-22.44	Average	
8	56.00	-25.88	QP	
9	50.00	-25.28	Average	
10	60.00	-28.15	QP	
11	50.00	-26.47	Average	
12	60.00	-27.37	QP	

4.2 Radiated Emission Test

Limit 15.209 limits

FREQUENCY MHz	DISTANCE Meters	FIELD STRENGTHS LIMIT	
		$\mu\text{V}/\text{m}$	$\text{dB}(\mu\text{V})/\text{m}$
30 ~ 88	3	100	40.0
88 ~ 216	3	150	43.5
216 ~ 960	3	200	46.0
960 ~ 1000	3	500	54.0
Above 1000	3	74.0 $\text{dB}(\mu\text{V})/\text{m}$ (Peak) 54.0 $\text{dB}(\mu\text{V})/\text{m}$ (Average)	

Restricted bands of operation

MHz	MHz	MHz	GHz
0.090 - 0.110	16.42 - 16.423	399.9 - 410	4.5 - 5.15
¹ 0.495 - 0.505	16.69475 - 16.69525	608 - 614	5.35 - 5.46
2.1735 - 2.1905	16.80425 - 16.80475	960 - 1240	7.25 - 7.75
4.125 - 4.128	25.5 - 25.67	1300 - 1427	8.025 - 8.5
4.17725 - 4.17775	37.5 - 38.25	1435 - 1626.5	9.0 - 9.2
4.20725 - 4.20775	73 - 74.6	1645.5 - 1646.5	9.3 - 9.5
6.215 - 6.218	74.8 - 75.2	1660 - 1710	10.6 - 12.7
6.26775 - 6.26825	108 - 121.94	1718.8 - 1722.2	13.25 - 13.4
6.31175 - 6.31225	123 - 138	2200 - 2300	14.47 - 14.5
8.291 - 8.294	149.9 - 150.05	2310 - 2390	15.35 - 16.2
8.362 - 8.366	156.52475 - 156.52525	2483.5 - 2500	17.7 - 21.4
8.37625 - 8.38675	156.7 - 156.9	2690 - 2900	22.01 - 23.12
8.41425 - 8.41475	162.0125 - 167.17	3260 - 3267	23.6 - 24.0
12.29 - 12.293	167.72 - 173.2	3332 - 3339	31.2 - 31.8
12.51975 - 12.52025	240 - 285	3345.8 - 3358	36.43 - 36.5
12.57675 - 12.57725	322 - 335.4	3600 - 4400	(²)

All the emissions appearing within 15.205 restricted frequency bands shall not exceed the limits shown in 15.209, all the other emissions shall be at least 20dB below the fundamental emissions, or comply with 15.209 limits.

Test setup

The EUT was placed on a turn table which was 0.8 m (above 1GHz, the high was 1.5m) above the ground. The turn table can rotate 360 degrees to determine the position of the maximum emission level. The EUT was set 3 m away from the receiving antenna which was mounted on an antenna tower. The measuring antenna moved up and down to find out the maximum emission level. It moved from 1 m to 4 m for both horizontal and vertical polarizations.

The EUT was tested in the Chamber Site. It was pre-scanned with a Peak detector from the spectrum, and all the final readings from the test receiver were measured with the Quasi-Peak detector.

The bandwidth of the EMI test receiver is set at 120kHz for frequency range from 30MHz to 1000 MHz.

The bandwidth of the Spectrum's VBW is set at 3MHz and RBW is set at 1MHz for peak emissions measurement above 1GHz and 1MHz RBW, 10Hz VBW for average emissions measure above 1GHz, Both PK and AV measure, PK detector is used.

The frequency range from 30MHz to 10th harmonic are checked. and no any emissions were found from 18GHz to 40 GHz, So the radiated emissions from 18GHz to 40GHz were not record.

Notes: 1. Emission Level = Antenna Factor + Cable Loss + Meter Reading-Preamp Factor.

2. Measurement Uncertainty: ± 3.2 dB at a level of confidence of 95%.

3. For emissions above 1GHz, if peak level comply with average limit, then the average level is deemed to comply with average limit.

4. For emissions below 1GHz, pretest for all mode, The test data of the worst case condition(s) was reported on the following pages.

5. For Both PK and AV value above 1GHz, PK detector is used.

Radiated Emission Test-Up Frequency Below 30MHz

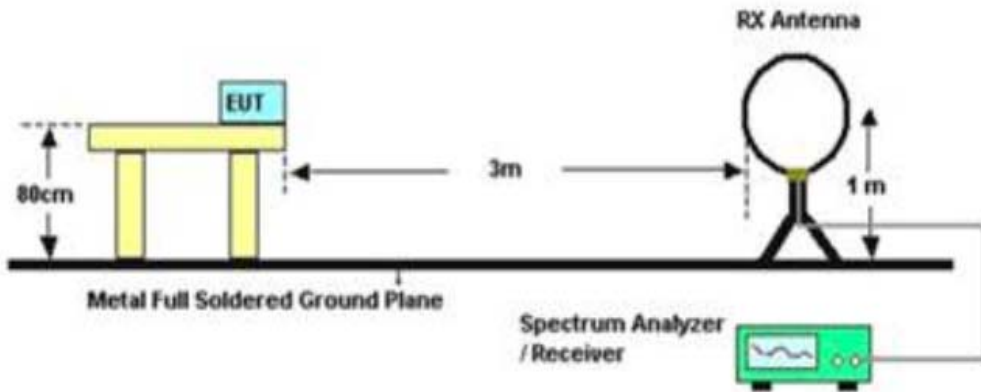

Below 1GHz

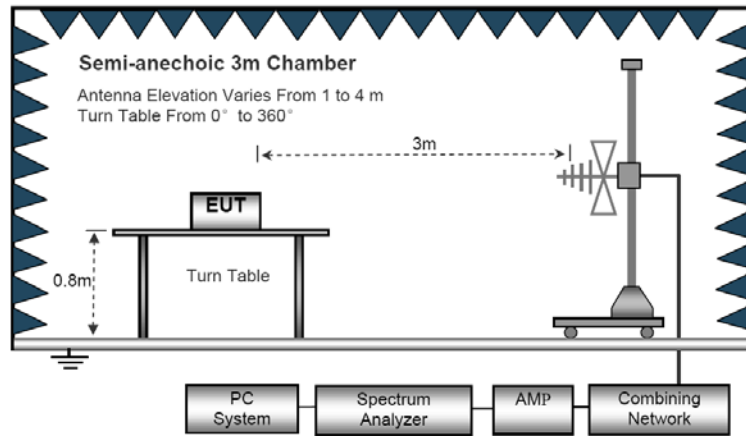

Above 1GHz

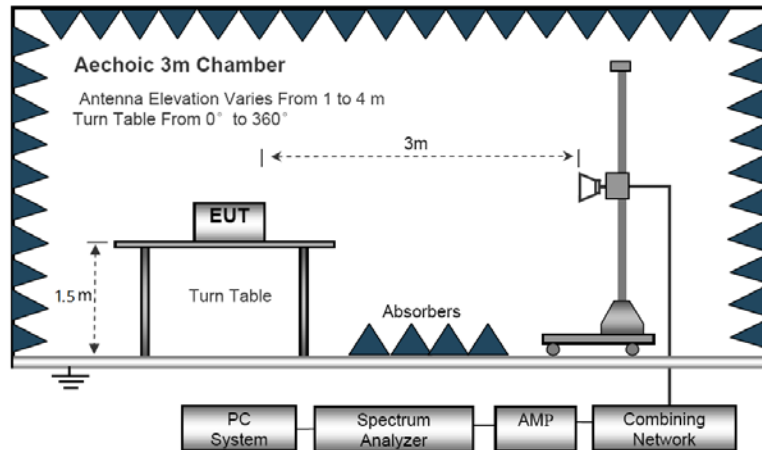

EUT :	Wireless	Model Name :	ES-SUB-WIRELESS-KIT
Temperature :	20 °C	Relative Humidity :	48%
Pressure :	1010hPa	Test Mode :	TX
Test Voltage :	DC 5.0V from Adapter AC 120V/60Hz		

Below 30MHz

Freq.	Reading	Limit	Margin	State
(MHz)	(dBuV/m)	(dBuV/m)	(dB)	P/F
--	--	--	--	P
--	--	--	--	P

Note:

The amplitude of spurious emissions which are attenuated by more than 20dB below the permissible value has no need to be reported.

Distance extrapolation factor = $40 \log (\text{specific distance}/\text{test distance})(\text{dB})$;

Limit line = specific limits(dBuv) + distance extrapolation factor.

Below 1GHz

EUT :	Wireless	Model Name :	ES-SUB-WIRELESS-KIT
Temperature :	20 °C	Relative Humidity :	48%
Pressure :	1010hPa	Test Mode :	TX
Test Voltage :	DC 5.0V from Adapter		

Horizontal

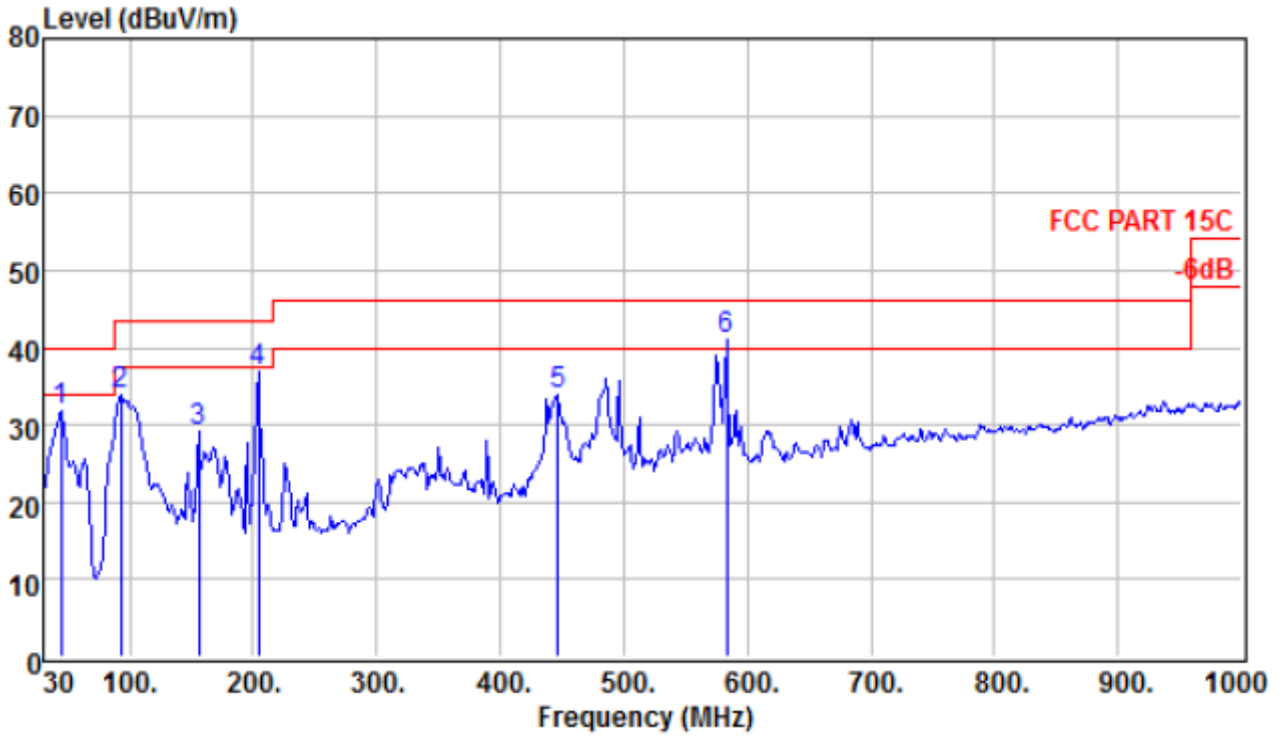

	ReadAntenna	Cable	Preamp	Limit	Over			
Freq	Level	Factor	Loss	Factor	Level	Line	Limit	Remark
MHz	dBuV	dB/m	dB	dB	dBuV/m	dBuV/m	dB	
1	44.550	51.50	11.03	0.56	31.40	31.69	40.00	-8.31 QP
2	93.050	55.13	9.25	0.94	31.35	33.97	43.50	-9.53 QP
3	156.100	50.06	9.12	1.30	31.24	29.24	43.50	-14.26 QP
4	204.600	55.30	11.22	1.46	31.09	36.89	43.50	-6.61 QP
5	447.100	44.35	17.54	2.62	30.61	33.90	46.00	-12.10 QP
6 !	582.900	48.51	20.05	3.20	30.74	41.02	46.00	-4.98 QP

Vertical

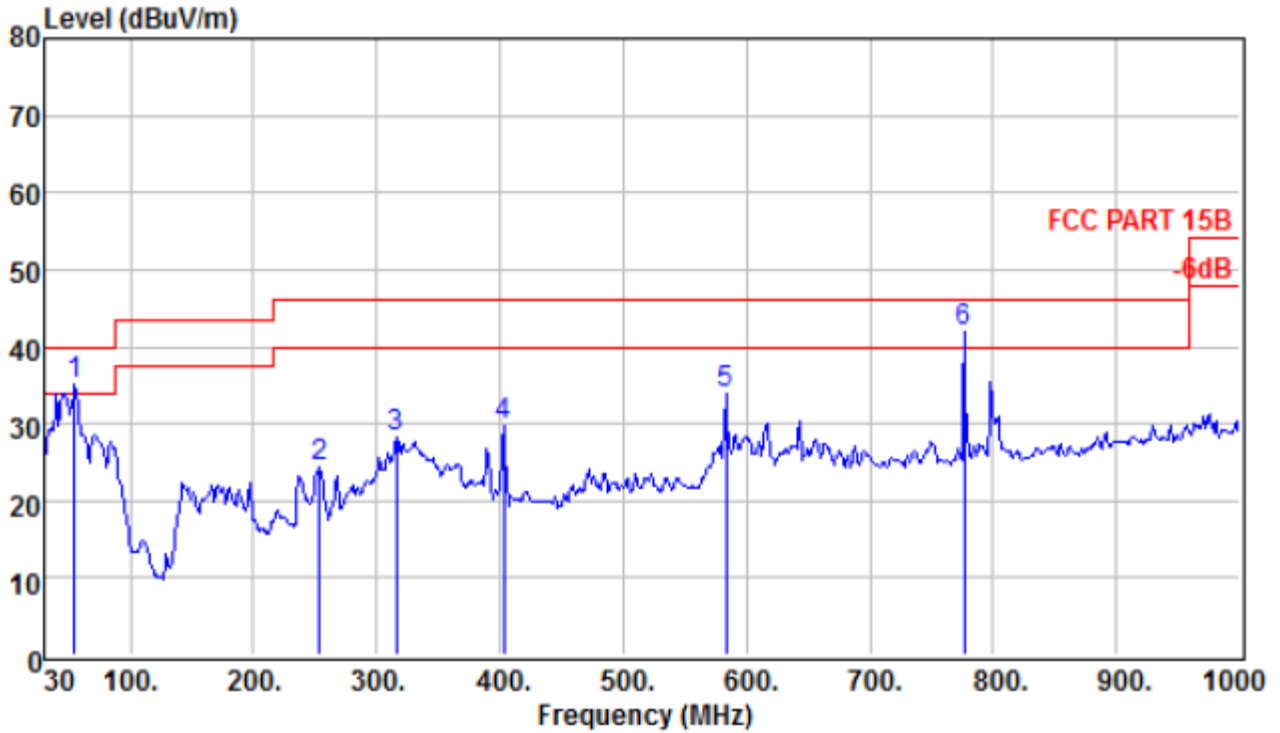

	ReadAntenna	Cable	Preamp		Limit	Over		
Freq	Level	Factor	Loss	Factor	Level	Line	Limit	Remark
MHz	dBuV	dB/m	dB	dB	dBuV/m	dBuV/m	dB	
1 !	54.250	57.47	8.16	0.75	31.37	35.01	40.00	-4.99 QP
2	253.100	40.65	12.91	1.70	30.97	24.29	46.00	-21.71 QP
3	316.150	42.95	14.25	1.94	30.87	28.27	46.00	-17.73 QP
4	403.450	41.72	16.41	2.37	30.63	29.87	46.00	-16.13 QP
5	582.900	41.36	20.05	3.20	30.74	33.87	46.00	-12.13 QP
6 !	776.900	45.59	22.72	4.21	30.62	41.90	46.00	-4.10 QP

NOTE:

Absolute Level= ReadingLevel+antenna Factor+cable loss-preamp factor,

Over Limit= Absolute Level – Limit

Above 1GHz

EUT :	Wireless	Model Name :	ES-SUB-WIRELESS-KIT
Temperature :	20 °C	Relative Humidity :	48%
Pressure :	1010hPa	Test Mode :	TX-5180
Test Voltage :	DC 5.0V from Adapter AC 120V/60Hz		

Vertical

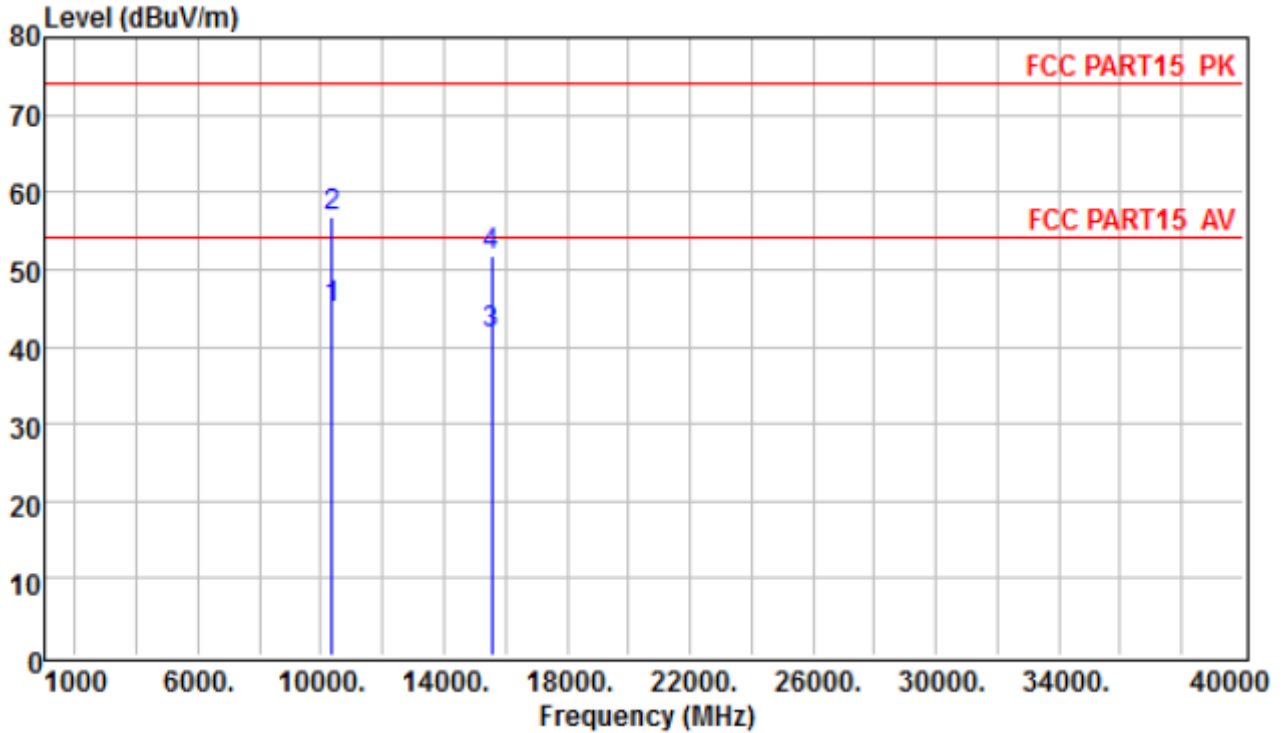

	Read	Antenna	Cable	Preamp	Limit	Over		
Freq	Level	Factor	Loss	Factor	Line	Limit	Remark	
MHz	dBuV	dB/m	dB	dB	dBuV/m	dBuV/m	dB	
1	10360.000	32.76	23.99	17.04	28.84	44.95	54.00	-9.05 Average
2	10360.000	44.54	23.99	17.04	28.84	56.73	74.00	-17.27 Peak
3	15540.000	27.54	23.53	20.34	29.63	41.78	54.00	-12.22 Average
4	15540.000	37.47	23.53	20.34	29.63	51.71	74.00	-22.29 Peak

Horizontal

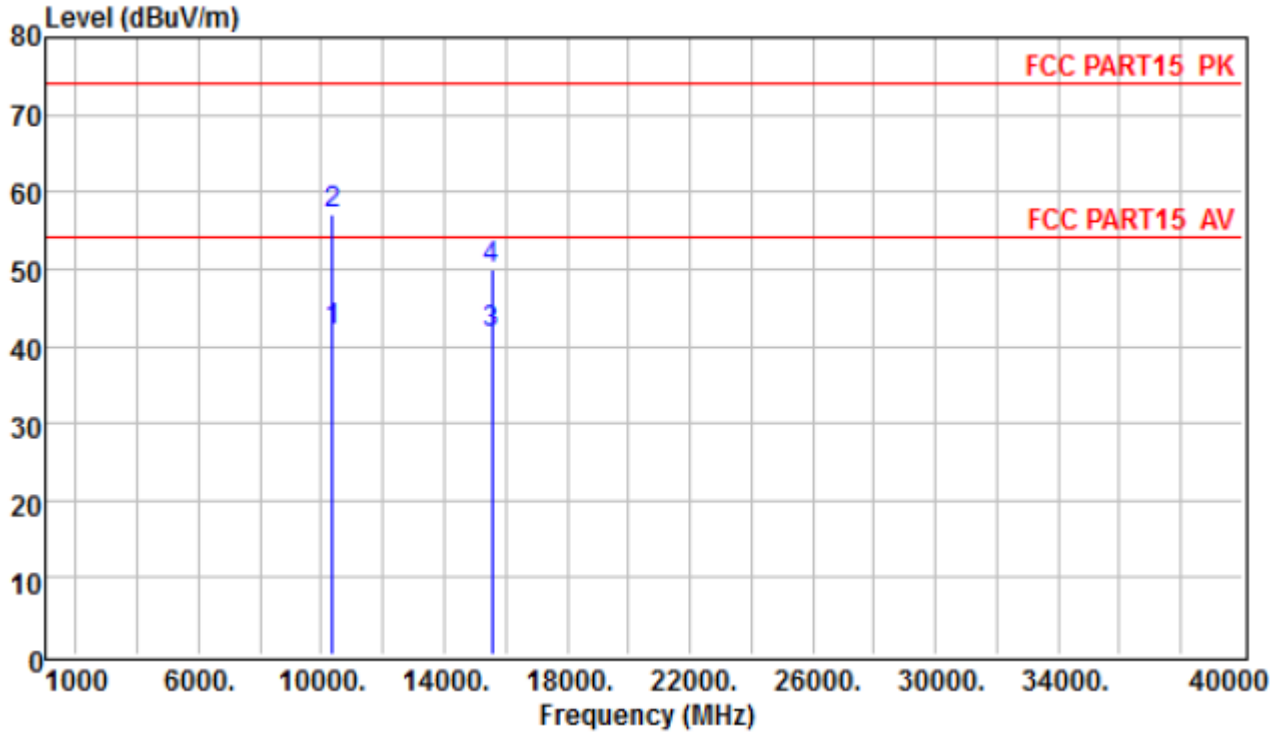

	ReadAntenna	Cable	Preamp		Limit	Over		
Freq	Level	Factor	Loss	Factor	Level	Line	Limit	Remark
MHz	dBuV	dB/m	dB	dB	dBuV/m	dBuV/m	dB	
1	10360.000	29.76	23.99	17.04	28.84	41.95	54.00	-12.05 Average
2	10360.000	44.97	23.99	17.04	28.84	57.16	74.00	-16.84 Peak
3	15540.000	27.54	23.53	20.34	29.63	41.78	54.00	-12.22 Average
4	15540.000	35.76	23.53	20.34	29.63	50.00	74.00	-24.00 Peak

EUT :	Wireless	Model Name :	ES-SUB-WIRELESS-KIT
Temperature :	20 °C	Relative Humidity :	48%
Pressure :	1010hPa	Test Mode :	TX-5210
Test Voltage :	DC 5.0V from Adapter AC 120V/60Hz		

Vertical

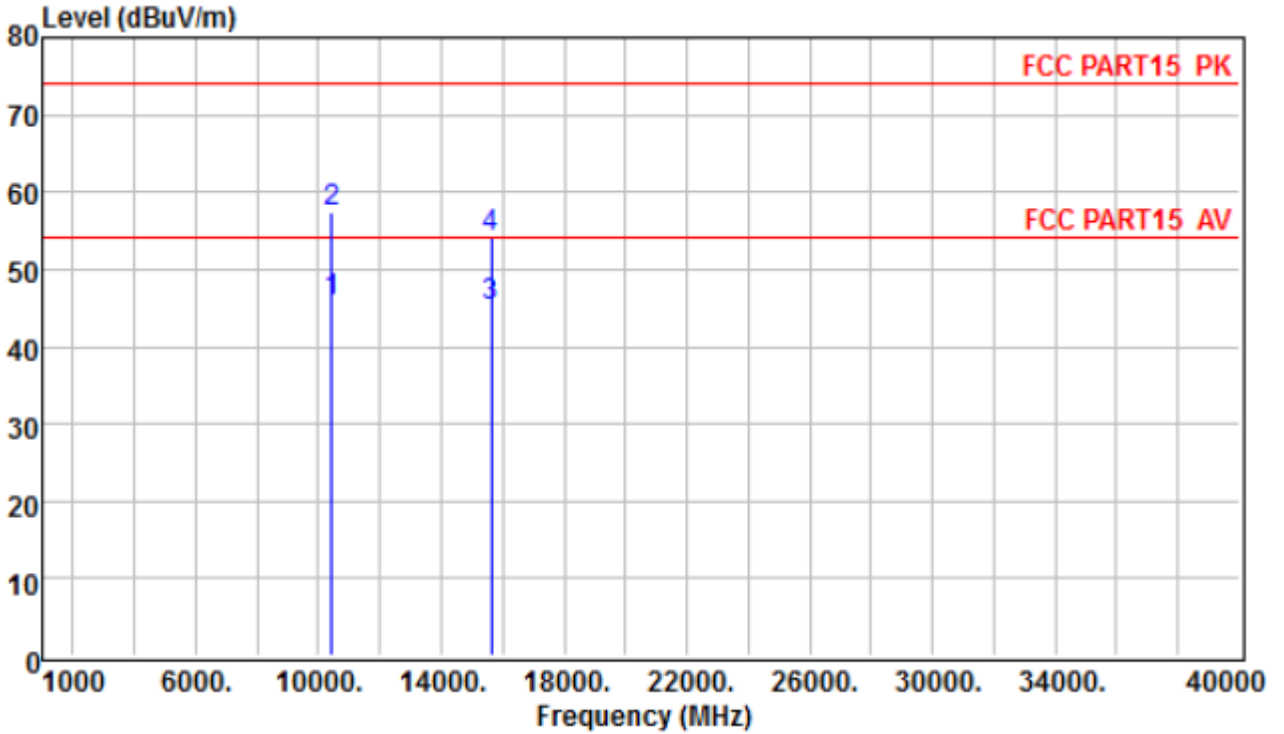

	ReadAntenna	Cable	Preamp	Limit	Over			
Freq	Level	Factor	Loss	Factor	Level	Line	Limit	Remark
MHz	dBuV	dB/m	dB	dB	dBuV/m	dBuV/m	dB	
1	10420.000	33.50	24.07	17.05	28.84	45.78	54.00	-8.22 Average
2	10420.000	45.19	24.07	17.05	28.84	57.47	74.00	-16.53 Peak
3	15630.000	30.52	23.92	20.40	29.65	45.19	54.00	-8.81 Average
4	15630.000	39.42	23.92	20.40	29.65	54.09	74.00	-19.91 Peak

Horizontal

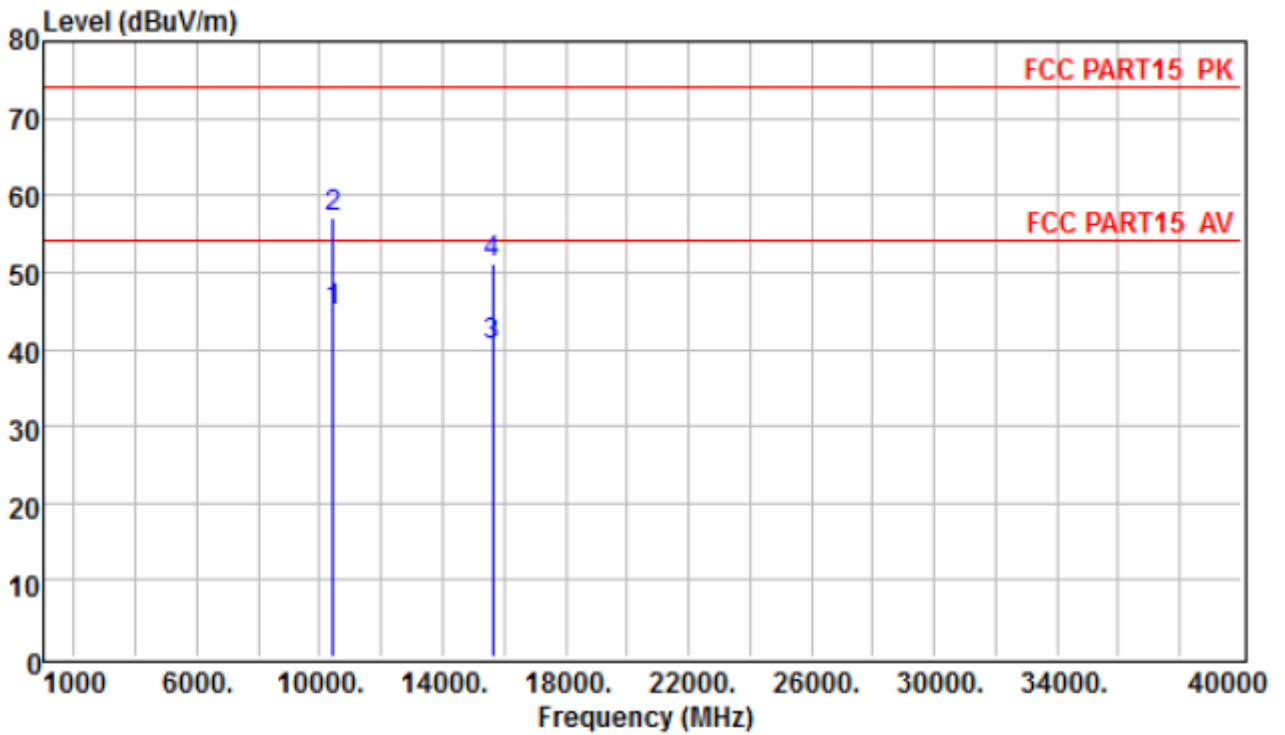

	ReadAntenna	Cable	Preamp	Limit	Over			
Freq	Level	Factor	Loss	Factor	Level	Line	Limit	Remark
MHz	dBuV	dB/m	dB	dB	dBuV/m	dBuV/m	dB	
1	10420.000	32.61	24.07	17.05	28.84	44.89	54.00	-9.11 Average
2	10420.000	44.72	24.07	17.05	28.84	57.00	74.00	-17.00 Peak
3	15630.000	25.86	23.92	20.40	29.65	40.53	54.00	-13.47 Average
4	15630.000	36.52	23.92	20.40	29.65	51.19	74.00	-22.81 Peak

EUT :	Wireless	Model Name :	ES-SUB-WIRELESS-KIT
Temperature :	20 °C	Relative Humidity :	48%
Pressure :	1010hPa	Test Mode :	TX-5240
Test Voltage :	DC 5.0V from Adapter AC 120V/60Hz		

Vertical

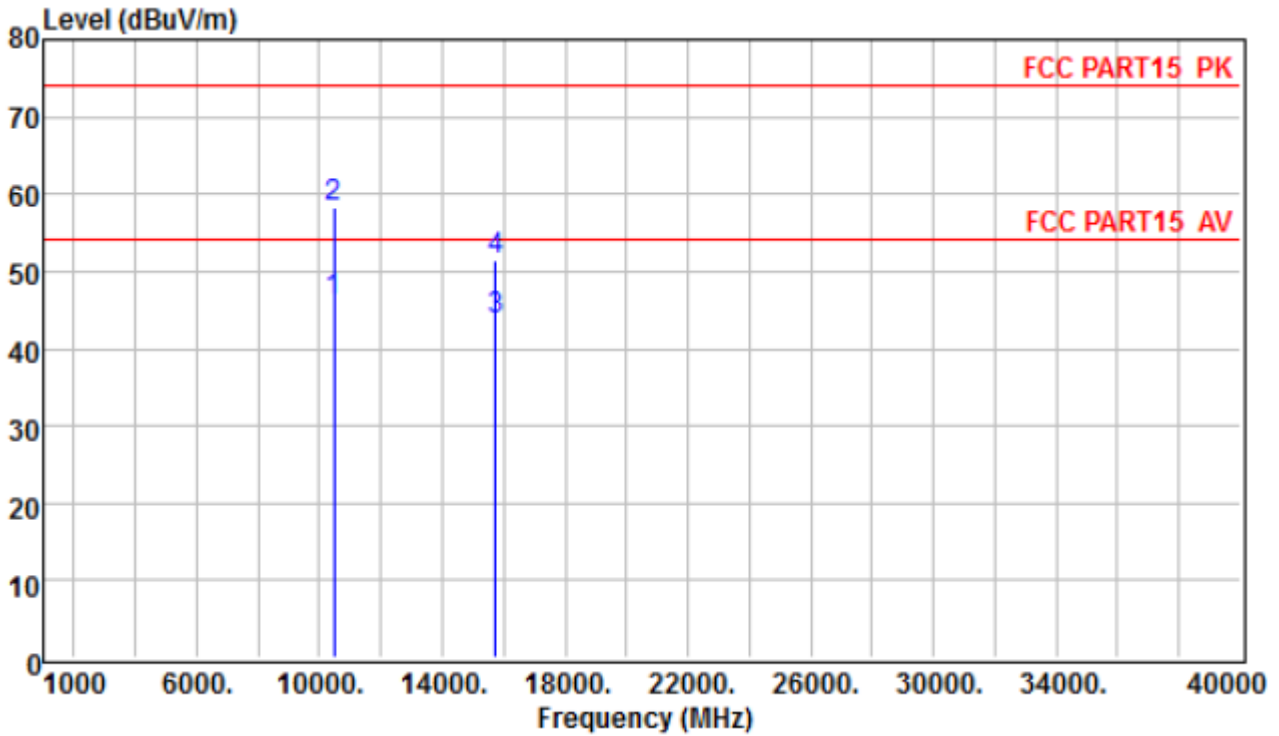

	ReadAntenna	Cable	Preamp	Limit	Over			
Freq	Level	Factor	Loss	Factor	Level	Line	Limit	Remark
MHz	dBuV	dB/m	dB	dB	dBuV/m	dBuV/m	dB	
1	10480.000	32.77	25.17	17.06	28.85	46.15	54.00	-7.85 Average
2	10480.000	44.99	25.17	17.06	28.85	58.37	74.00	-15.63 Peak
3	15720.000	28.55	24.25	20.45	29.66	43.59	54.00	-10.41 Average
4	15720.000	36.55	24.25	20.45	29.66	51.59	74.00	-22.41 Peak

Horizontal

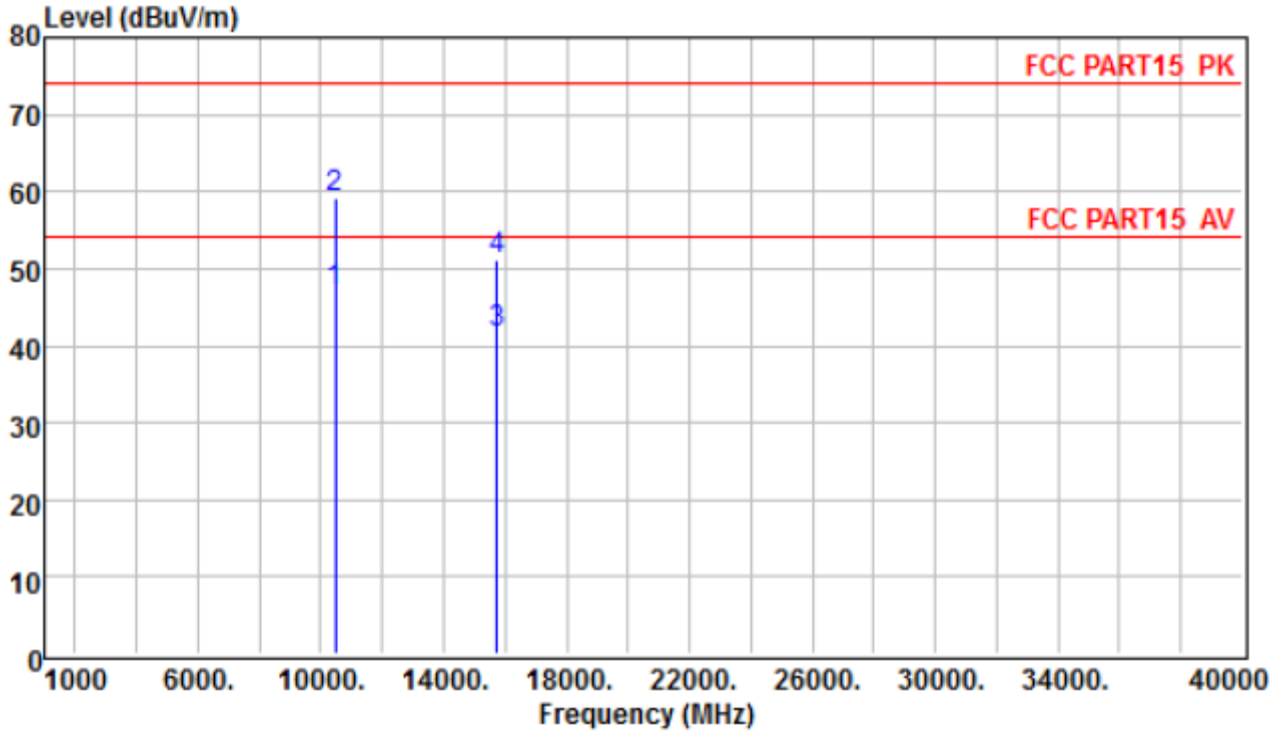

	ReadAntenna	Cable	Preamp	Limit	Over			
Freq	Level	Factor	Loss	Factor	Level	Line	Limit	Remark
MHz	dBuV	dB/m	dB	dB	dBuV/m	dBuV/m	dB	
1	10480.000	33.66	25.17	17.06	28.85	47.04	54.00	-6.96 Average
2	10480.000	45.88	25.17	17.06	28.85	59.26	74.00	-14.74 Peak
3	15720.000	26.66	24.25	20.45	29.66	41.70	54.00	-12.30 Average
4	15720.000	36.05	24.25	20.45	29.66	51.09	74.00	-22.91 Peak

EUT :	Wireless	Model Name :	ES-SUB-WIRELESS-KIT
Temperature :	20 °C	Relative Humidity :	48%
Pressure :	1010hPa	Test Mode :	TX-5736
Test Voltage :	DC 5.0V from Adapter AC 120V/60Hz		

Vertical

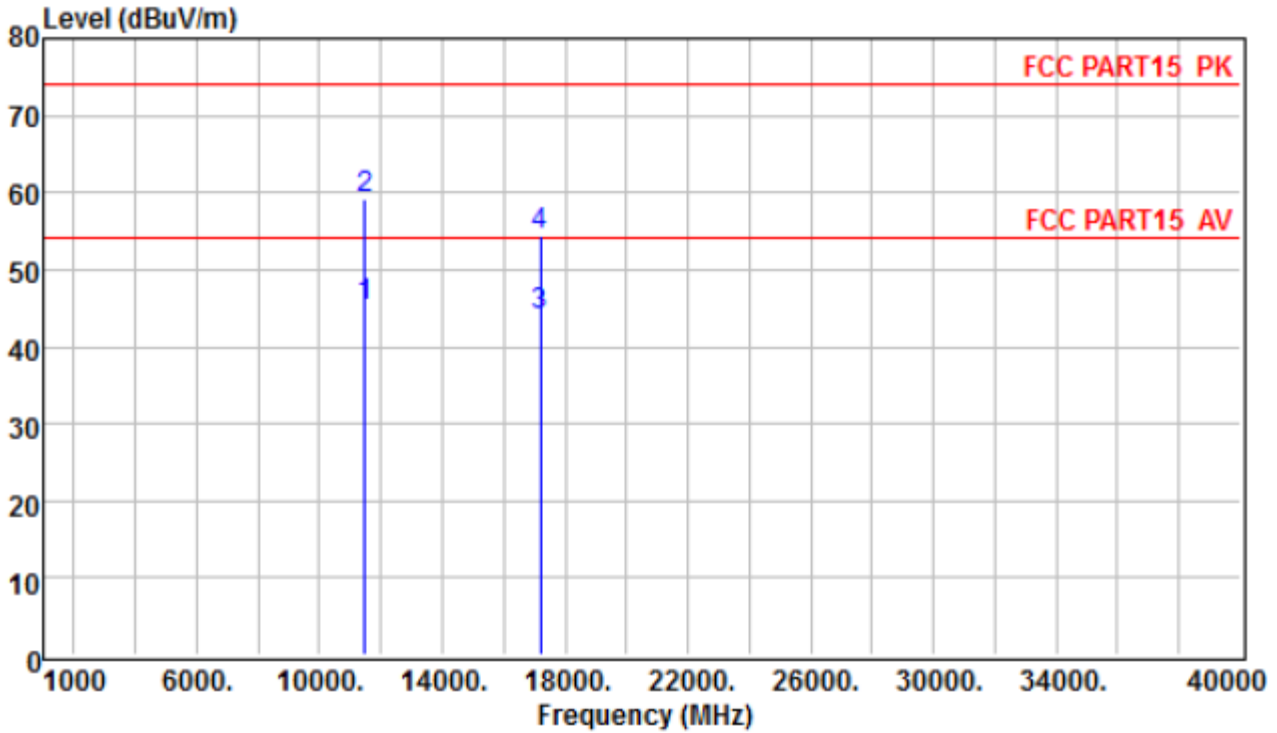

	ReadAntenna	Cable	Preamp	Limit	Over				
Freq	Level	Factor	Loss	Factor	Level	Line	Limit	Remark	
MHz	dBuV	dB/m	dB	dB	dBuV/m	dBuV/m	dB		
1	11472.000	33.09	23.87	17.26	28.95	45.27	54.00	-8.73 Average	
2	11472.000	46.89	23.87	17.26	28.95	59.07	74.00	-14.93 Peak	
3	17208.000	27.72	24.92	21.52	30.18	43.98	54.00	-10.02 Average	
4	17208.000	38.04	24.92	21.52	30.18	54.30	74.00	-19.70 Peak	

Horizontal

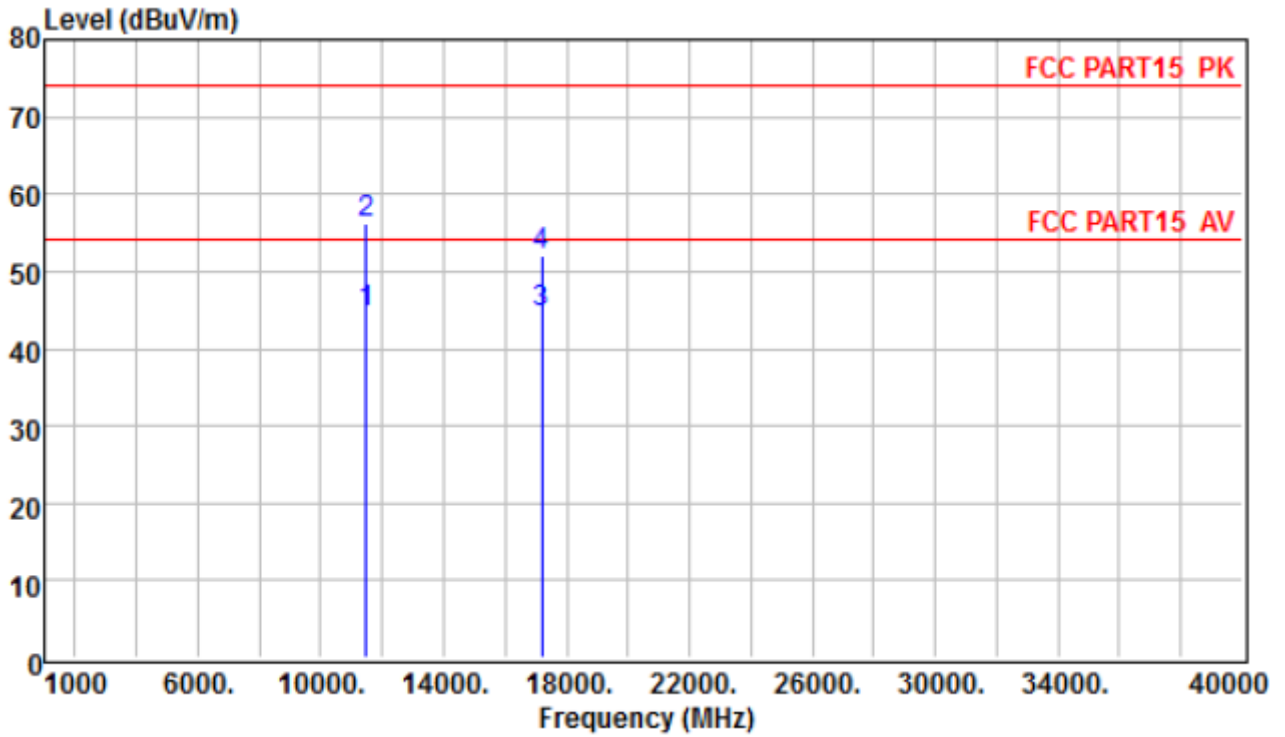

	ReadAntenna	Cable	Preamp	Limit	Over				
Freq	Level	Factor	Loss	Factor	Level	Line	Limit	Remark	
MHz	dBuV	dB/m	dB	dB	dBuV/m	dBuV/m	dB		
1	11472.000	32.45	23.87	17.26	28.95	44.63	54.00	-9.37	Average
2	11472.000	43.89	23.87	17.26	28.95	56.07	74.00	-17.93	Peak
3	17208.000	28.21	24.92	21.52	30.18	44.47	54.00	-9.53	Average
4	17208.000	35.76	24.92	21.52	30.18	52.02	74.00	-21.98	Peak

EUT :	Wireless	Model Name :	ES-SUB-WIRELESS-KIT
Temperature :	20 °C	Relative Humidity :	48%
Pressure :	1010hPa	Test Mode :	TX-5762
Test Voltage :	DC 5.0V from Adapter AC 120V/60Hz		

Vertical

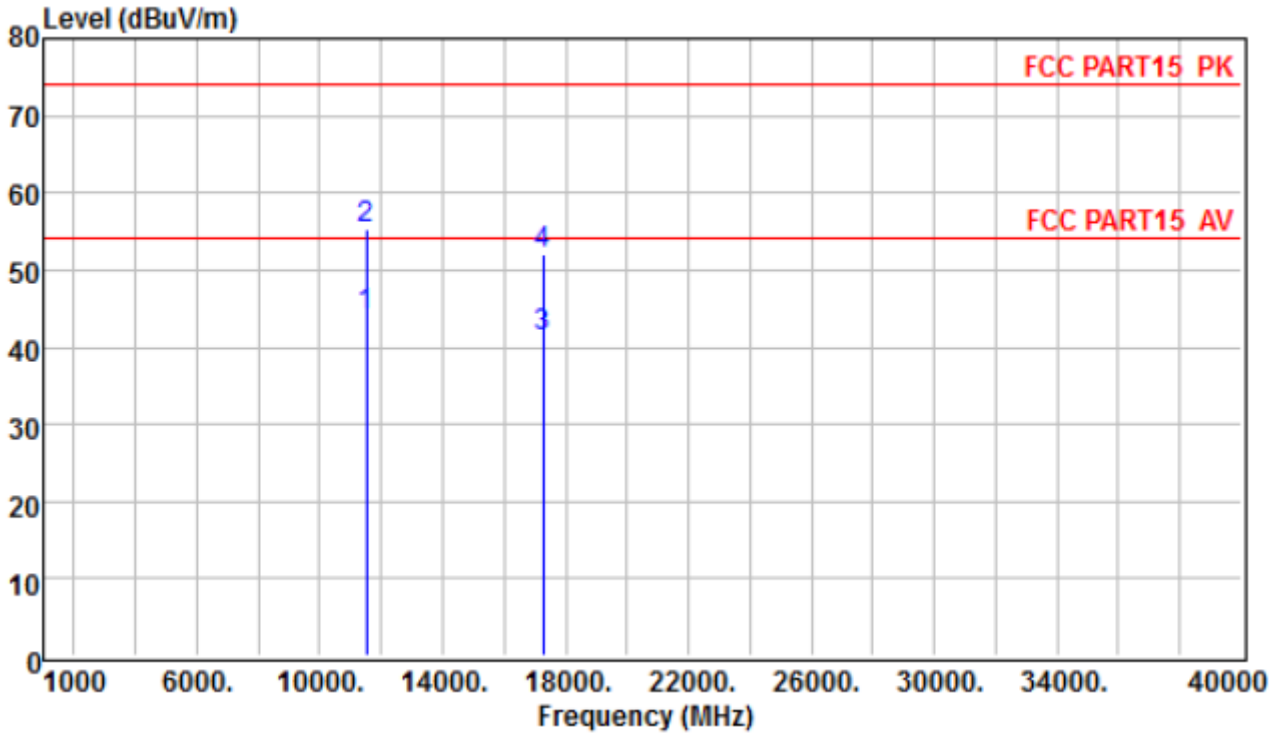

	Freq	ReadAntenna Level	Antenna Factor	Cable Loss	Preamplifier Factor	Level	Limit Line	Over Limit	Remark
	MHz	dBuV	dB/m	dB	dB	dBuV/m	dBuV/m	dB	
1	11524.000	31.76	23.88	17.27	28.95	43.96	54.00	-10.04	Average
2	11524.000	43.23	23.88	17.27	28.95	55.43	74.00	-18.57	Peak
3	17286.000	24.99	25.05	21.59	30.22	41.41	54.00	-12.59	Average
4	17286.000	35.55	25.05	21.59	30.22	51.97	74.00	-22.03	Peak

Horizontal

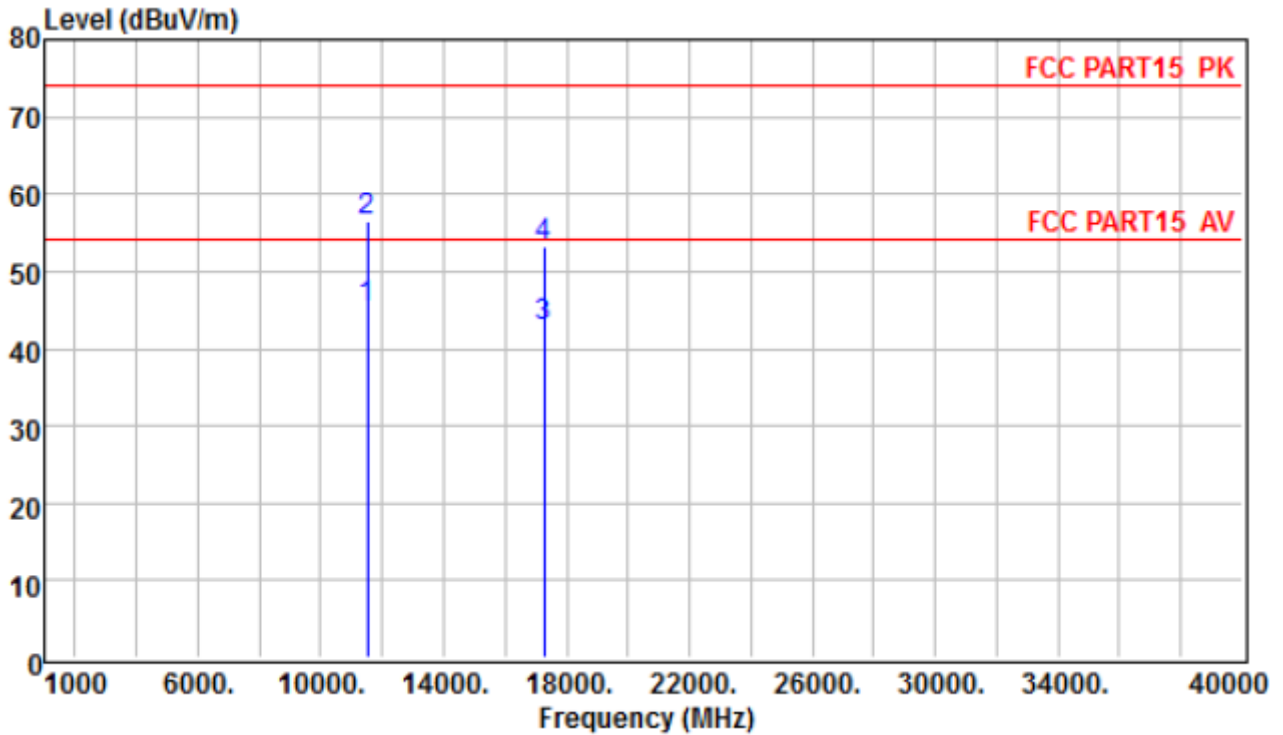

	Read	Antenna	Cable	Preamp		Limit	Over	
Freq	Level	Factor	Loss	Factor	Level	Line	Limit	Remark
MHz	dBuV	dB/m	dB	dB	dBuV/m	dBuV/m	dB	
1	11524.000	32.88	23.88	17.27	28.95	45.08	54.00	-8.92 Average
2	11524.000	44.21	23.88	17.27	28.95	56.41	74.00	-17.59 Peak
3	17286.000	26.44	25.05	21.59	30.22	42.86	54.00	-11.14 Average
4	17286.000	36.91	25.05	21.59	30.22	53.33	74.00	-20.67 Peak

EUT :	Wireless	Model Name :	ES-SUB-WIRELESS-KIT
Temperature :	20 °C	Relative Humidity :	48%
Pressure :	1010hPa	Test Mode :	TX-5814
Test Voltage :	DC 5.0V from Adapter AC 120V/60Hz		

Vertical

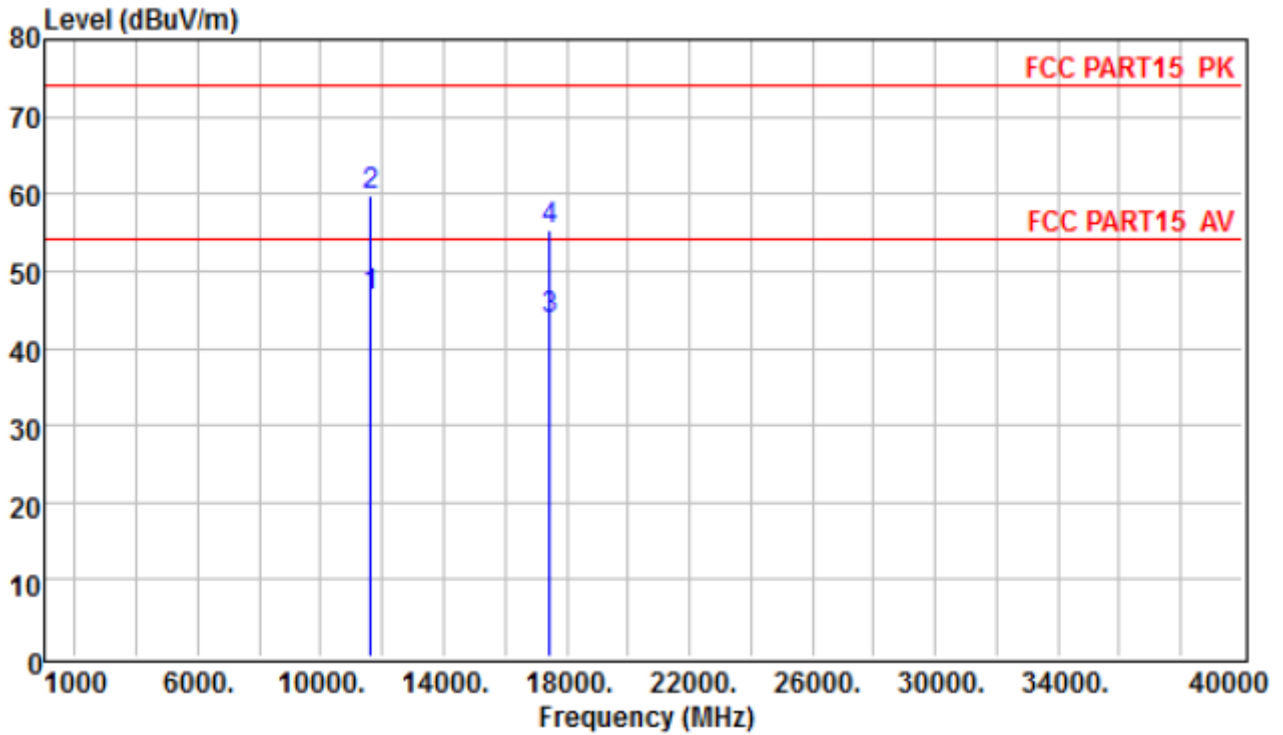

	ReadAntenna	Cable	Preamp	Limit	Over			
Freq	Level	Factor	Loss	Factor	Level	Line	Limit	Remark
MHz	dBuV	dB/m	dB	dB	dBuV/m	dBuV/m	dB	
1	11628.000	32.65	25.78	17.29	28.96	46.76	54.00	-7.24 Average
2	11628.000	45.65	25.78	17.29	28.96	59.76	74.00	-14.24 Peak
3	17442.000	25.09	27.29	21.74	30.28	43.84	54.00	-10.16 Average
4	17442.000	36.61	27.29	21.74	30.28	55.36	74.00	-18.64 Peak

Horizontal

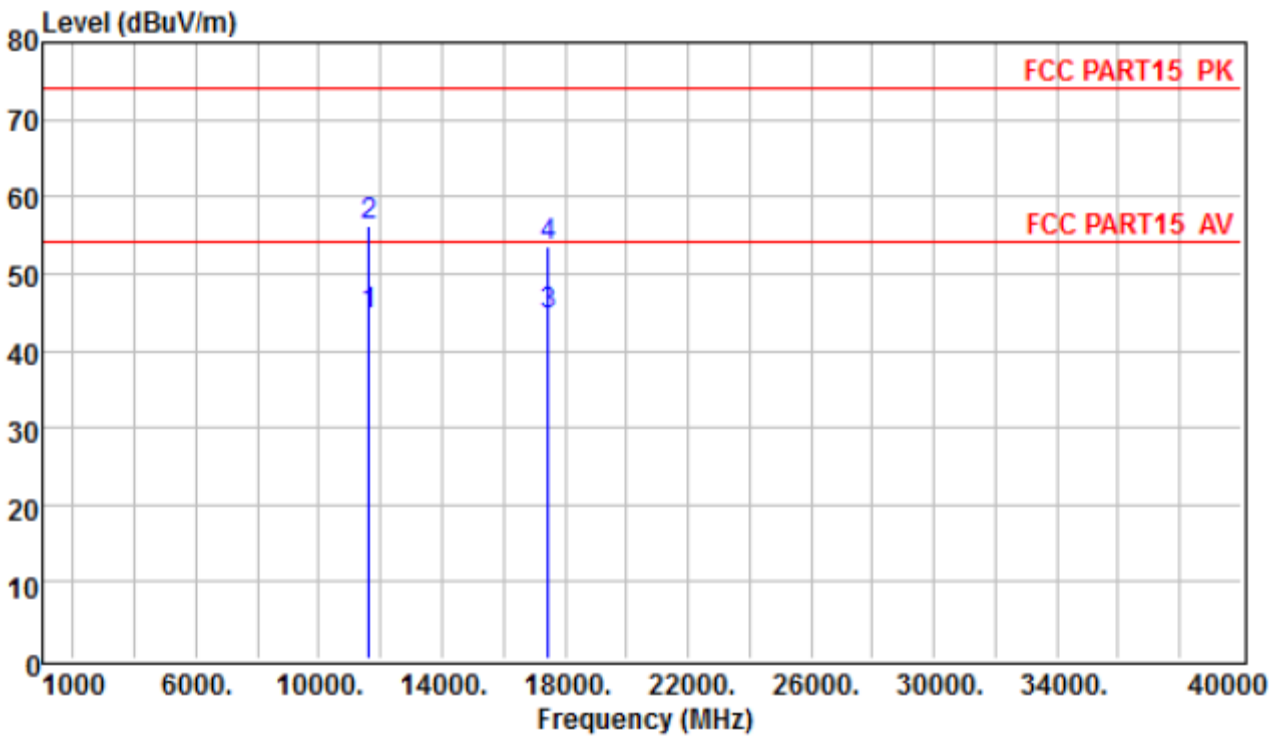

	ReadAntenna	Cable	Preamp		Limit	Over		
Freq	Level	Factor	Loss	Factor	Level	Line	Limit	Remark
MHz	dBuV	dB/m	dB	dB	dBuV/m	dBuV/m	dB	
1	11628.000	30.43	25.78	17.29	28.96	44.54	54.00	-9.46 Average
2	11628.000	42.09	25.78	17.29	28.96	56.20	74.00	-17.80 Peak
3	17442.000	25.87	27.29	21.74	30.28	44.62	54.00	-9.38 Average
4	17442.000	34.66	27.29	21.74	30.28	53.41	74.00	-20.59 Peak

Note:

Absolute Level= ReadingLevel+antenna Factor+cable loss-preamp factor,

Over Limit= Absolute Level – Limit

The amplitude of spurious emissions which are attenuated by more than 20dB below the permissible value has not to be reported.

5. BAND EDGE COMPLIANCE TEST

5.1 Limits

Band 5.15-5.25GHz:

FCC: all emissions outside of the 5.15-5.35 GHz band shall not exceed an EIRP of -27 dBm/MHz.

IC: In any 100 kHz bandwidth outside the frequency band in which the spread spectrum or digitally modulated device is operating, the RF power that is produced shall be at least 20 dB below that in the 100 kHz bandwidth within the band that contains the highest level of the desired power, based on either an RF conducted or a radiated measurement, provided that the transmitter demonstrates compliance with the peak conducted power limits. If the transmitter complies with the conducted power limits based on the use of root-mean-square averaging over a time interval, as permitted under Section 5.4(4), the attenuation required shall be 30 dB instead of 20 dB. Attenuation below the general field strength limits specified in RSS-Gen is not required.

FCC: For the band 5725-5825 MHz , All emissions shall be limited to a level of -27 dBm/MHz at 75 MHz or more above or below the band edge increasing linearly to 10 dBm/MHz at 25 MHz above or below the band edge, and from 25 MHz above or below the band edge increasing linearly to a level of 15.6 dBm/MHz at 5 MHz above or below the band edge, and from 5 MHz above or below the band edge increasing linearly to a level of 27 dBm/MHz at the band edge.

IC: For the band 5725-5825 MHz, emissions within the frequency range from the band edges to 10 MHz above or below the band edges shall not exceed -17 dBm/MHz e.i.r.p. For frequencies more than 10 MHz above or below the band edges, emissions shall not exceed -27 dBm/MHz.

5.2 Test setup

Test method: FCC KDB 789033 G)& Parts 15.407(b)(4) & 15.209(a)

Same as Clause 4.2.

5.3 Test Data

Please see data as below:

Note: we pretest horizontal and vertical, the worst was vertical and show in the report.

Frequency (MHz)	Meter Reading (dBμV)	antenna Factor (dB)	cable loss (dB)	preamp factor (dB)	Emission Level (dBμV/m)	EIRP [dBm]	Limit [dBm]	Result
5.2G								
5150	34.65	28.66	12.93	27.62	48.62	-46.58	-27.00	Pass
5350	34.13	28.73	13.09	27.62	48.33	-46.87	-27.00	Pass
5.8G								
5650	32.54	28.44	14.64	27.67	47.95	-47.25	-27.00	Pass
5700	33.76	28.52	14.95	27.67	49.56	-45.64	10.00	Pass
5720	33.56	27.59	15.05	27.67	48.53	-46.67	15.60	Pass
5725	37.87	27.63	15.16	27.67	52.99	-42.21	27.00	Pass
5736	80.68	27.63	15.16	27.67	95.80	0.60	27.00	Pass
5850	38.06	27.86	15.75	27.68	53.99	-41.21	27.00	Pass
5855	34.55	26.9	15.84	27.69	49.60	-45.60	15.60	Pass
5875	32.09	26.93	15.93	27.69	47.26	-47.94	10.00	Pass
5925	31.77	27.05	16.15	27.69	47.28	-47.92	-27.00	Pass
5814	78.99	27.78	15.56	27.68	94.65	-0.55	27.00	Pass

Remark: 1. According to KDB 789033 D02 section H) d) (iii), for measurement above 1000MHz@3m distance, the limit of EIRP is calculated as follows: $EIRP[dBm] = E[dBμV/m] - 95.2$

For conducted test:

5.2G

Band Edge, Left Side

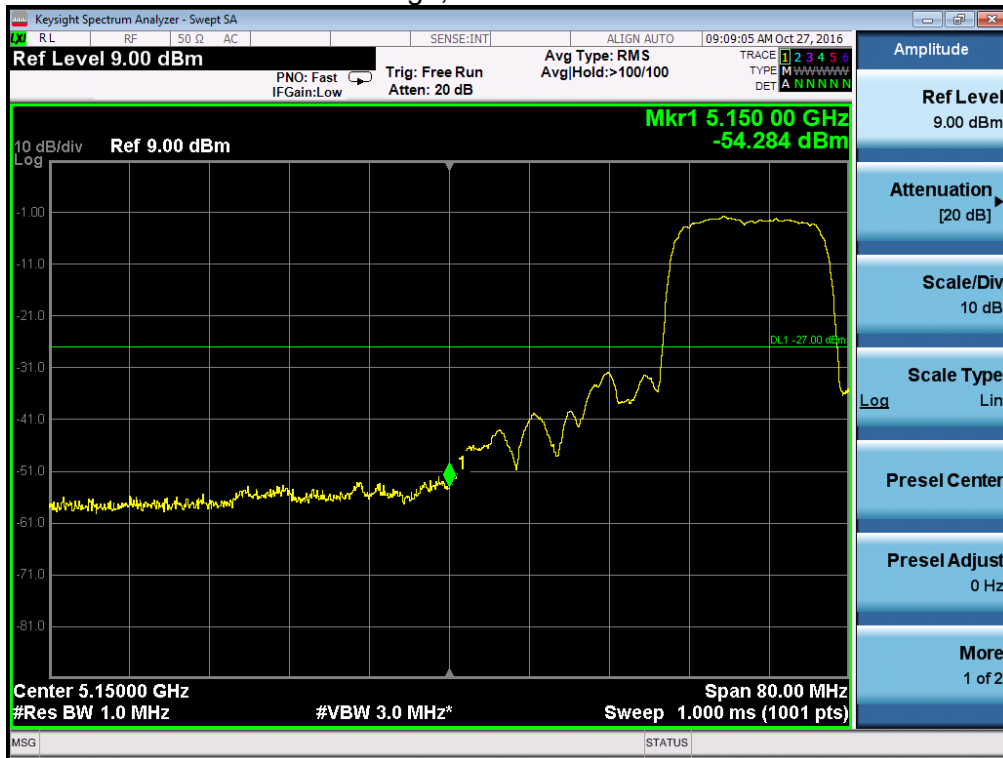

Band Edge, Right Side



Note: EIRP BAND EDGE=Reading Level+antenna gain

5.8G

Band Edge, Left Side

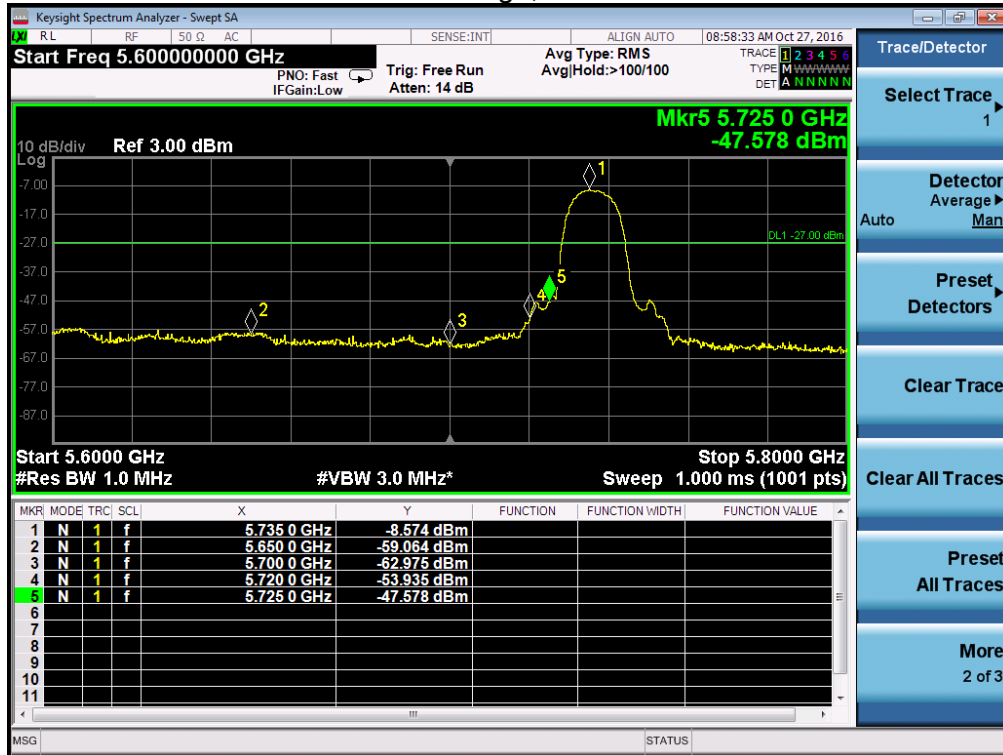

Band Edge, Right Side

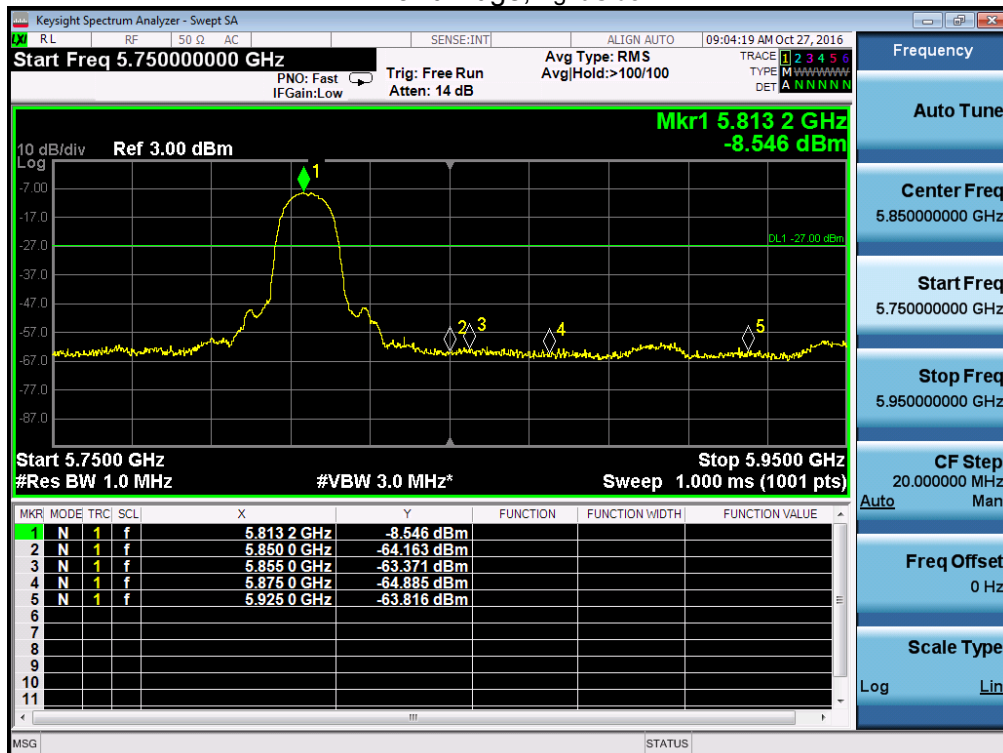

Note: EIRP BAND EDGE=Reading Level+antenna gain

6. 26DB AND 6DB BANDWIDTH TEST

6.1 Applicable Standard

The bandwidth at 26 dB down from the highest in-band spectral density is measured with a spectrum analyzer connected to the antenna terminal while the EUT is operating at its maximum power control level, as defined in KDB 789033, at the appropriate frequencies. The spectrum analyzer's bandwidth measurement function is configured to measure the 26 dB bandwidth. The 26 dB bandwidth is used to determine the conducted power limits. The minimum of 6dB Bandwidth measurement is 0.5 MHz for U-NII-3

6.2 Test Procedure

1. Emission Bandwidth (EBW)

- a) Set RBW = approximately 1% of the emission bandwidth.
- b) Set the VBW > RBW.
- c) Detector = Peak.
- d) Trace mode = max hold.
- e) Measure the maximum width of the emission that is 26 dB down from the maximum of the emission. Compare this with the RBW setting of the analyzer. Readjust RBW and repeat measurement as needed until the RBW/EBW ratio is approximately 1%.

2. Minimum Emission Bandwidth for the band 5.725-5.85 GHz

Section 15.407(e) specifies the minimum 6 dB emission bandwidth of at least 500 KHz for the band 5.715-5.85 GHz. The following procedure shall be used for measuring this bandwidth:

- a) Set RBW = 100 kHz.
- b) Set the video bandwidth (VBW) $\geq 3 \times$ RBW.
- c) Detector = Peak.
- d) Trace mode = max hold.
- e) Sweep = auto couple.
- f) Allow the trace to stabilize.
- g) Measure the maximum width of the emission that is constrained by the frequencies associated with the two outermost amplitude points (upper and lower frequencies) that are attenuated by 6 dB relative to the maximum level measured in the fundamental emission.

6.3 Test setup

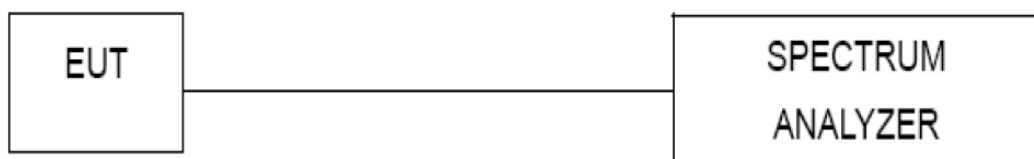

Frequency (MHz)	26dB Bandwidth (MHz) ANT A	99% Bandwidth (MHz) ANT A	26dB Bandwidth (MHz) ANT B	99% Bandwidth (MHz) ANT B
5180	16.28	15.078	15.08	15.073
5200	16.28	15.078	15.08	15.068
5240	16.29	15.088	15.09	15.078

Frequency (MHz)	6dB Bandwidth (MHz) ANT A	6dB Bandwidth (MHz) ANT B	Limit (MHz)	99% Bandwidth (MHz) ANT A	99% Bandwidth (MHz) ANT B
5736	9.842	9.841	0.5	13.835	13.837
5762	9.841	9.843	0.5	13.841	13.833
5814	9.841	9.841	0.5	13.833	13.832

5150-5250 MHz:

5180MHz-ANTA

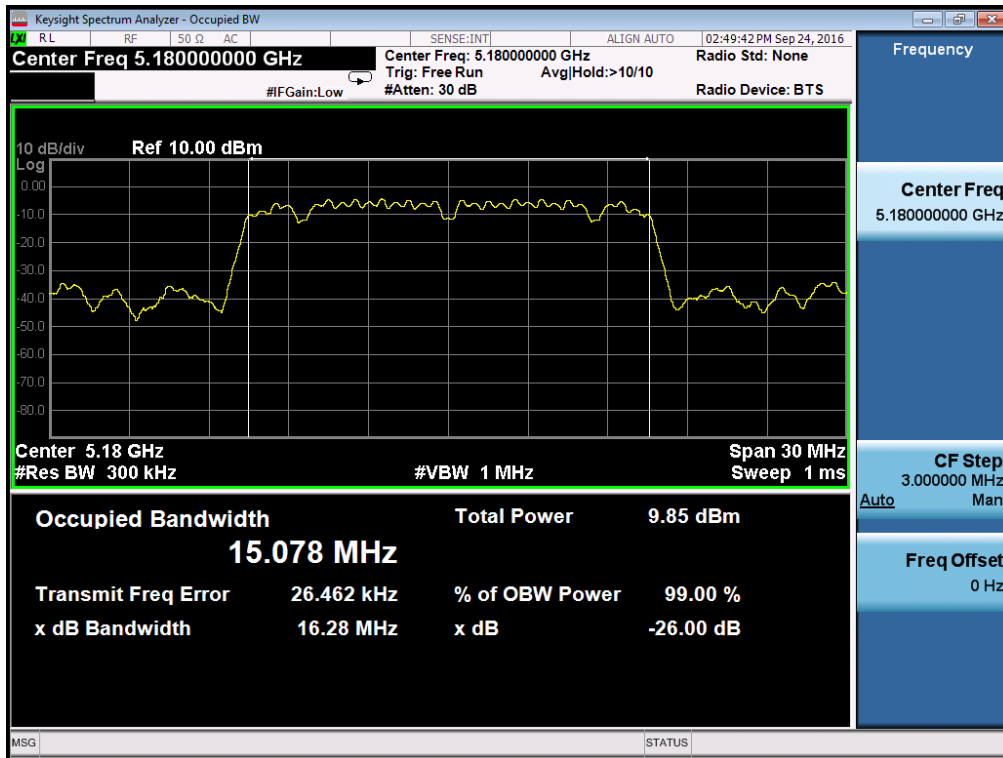

5180MHz-ANTB

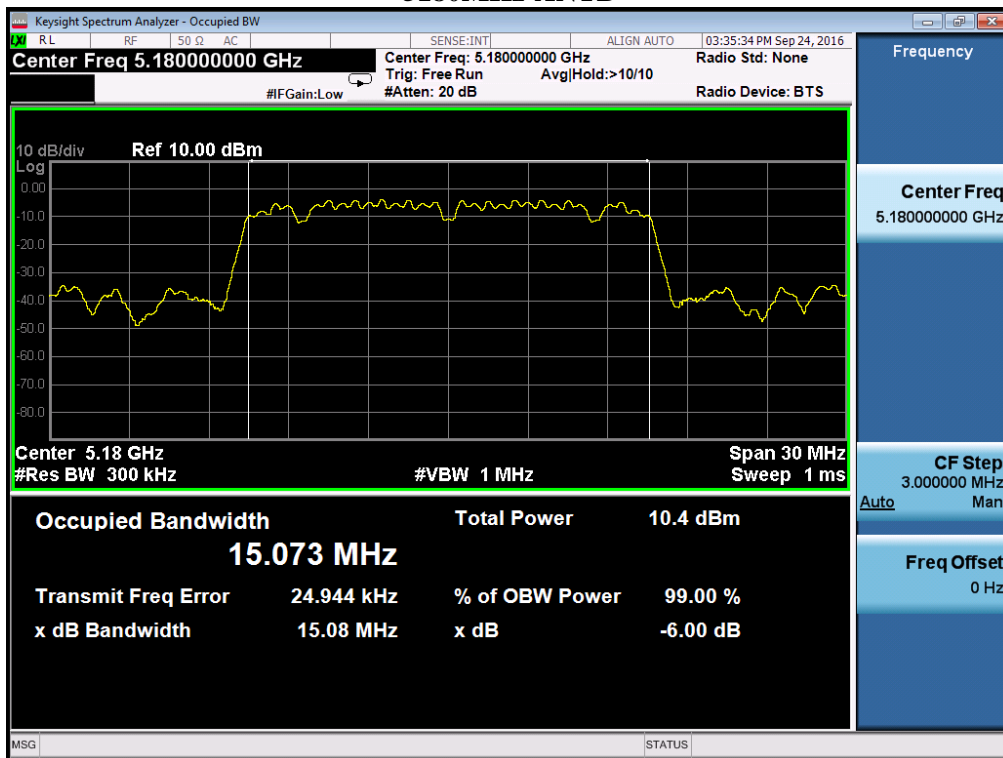

5210MHz-ANT A

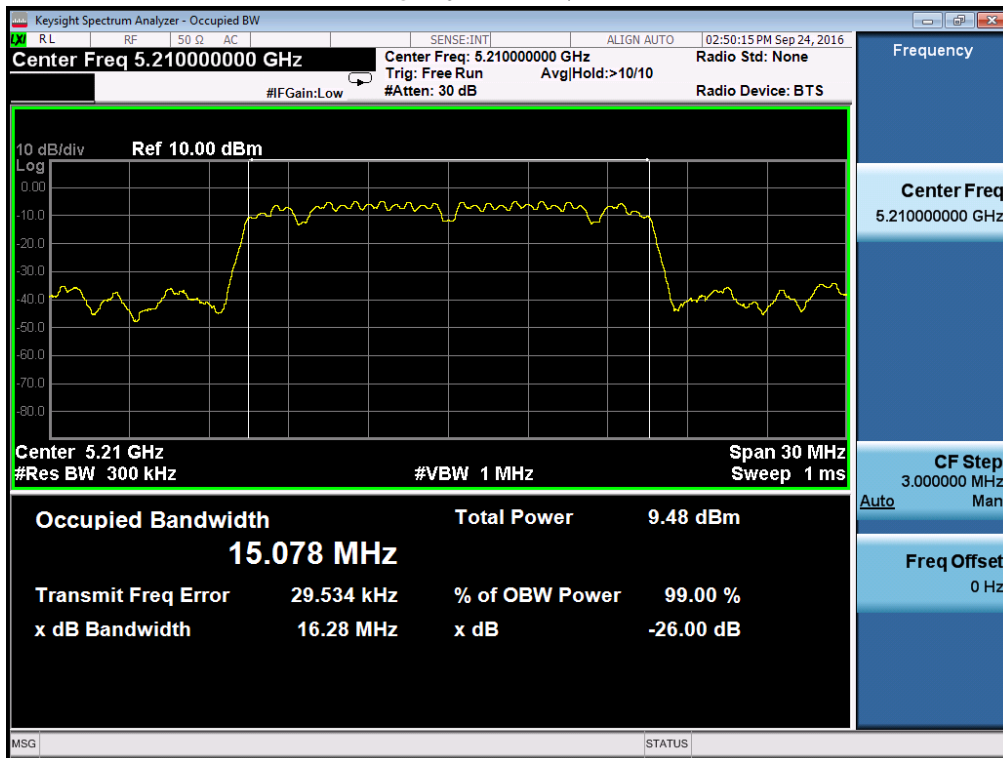

5210MHz-ANT B

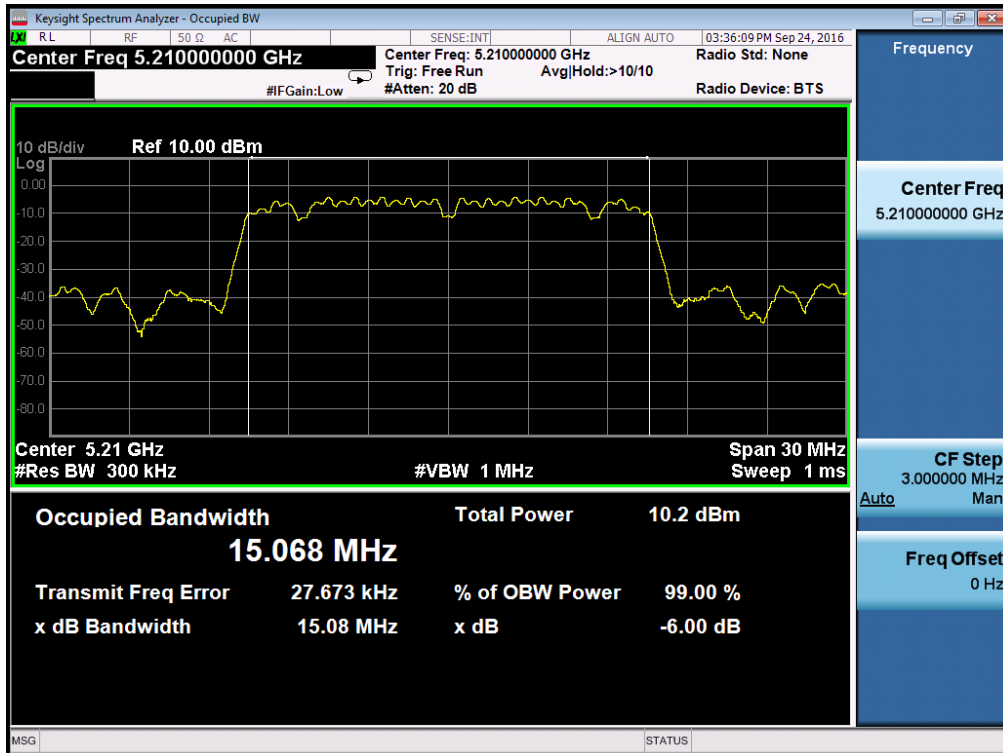

5240MHz-ANT A

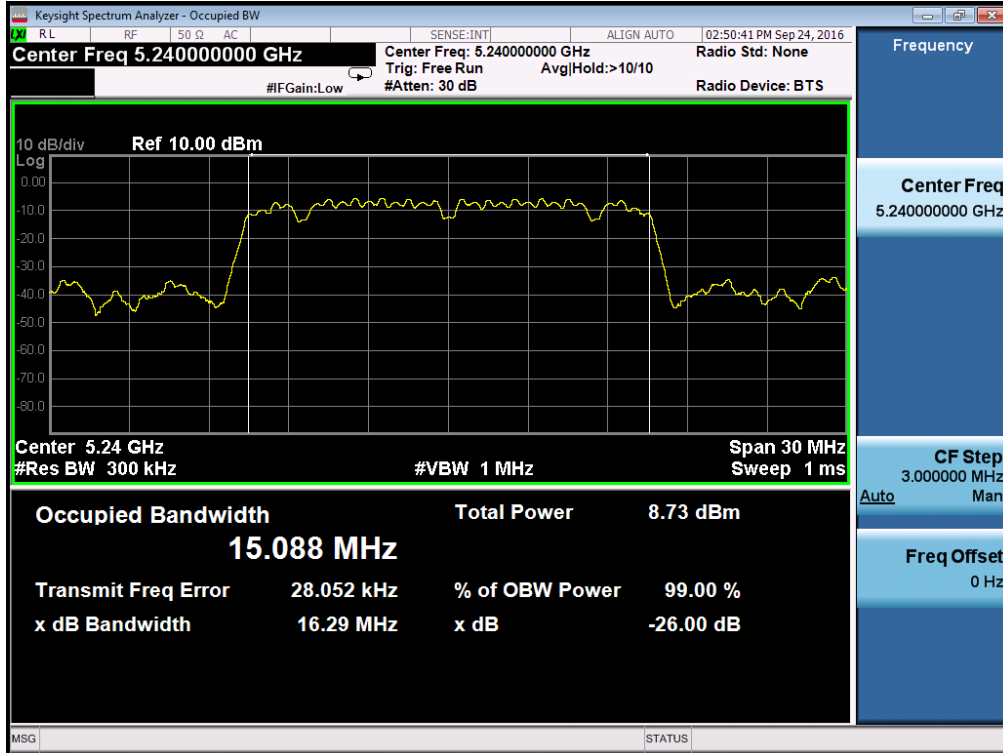

5240MHz-ANT B

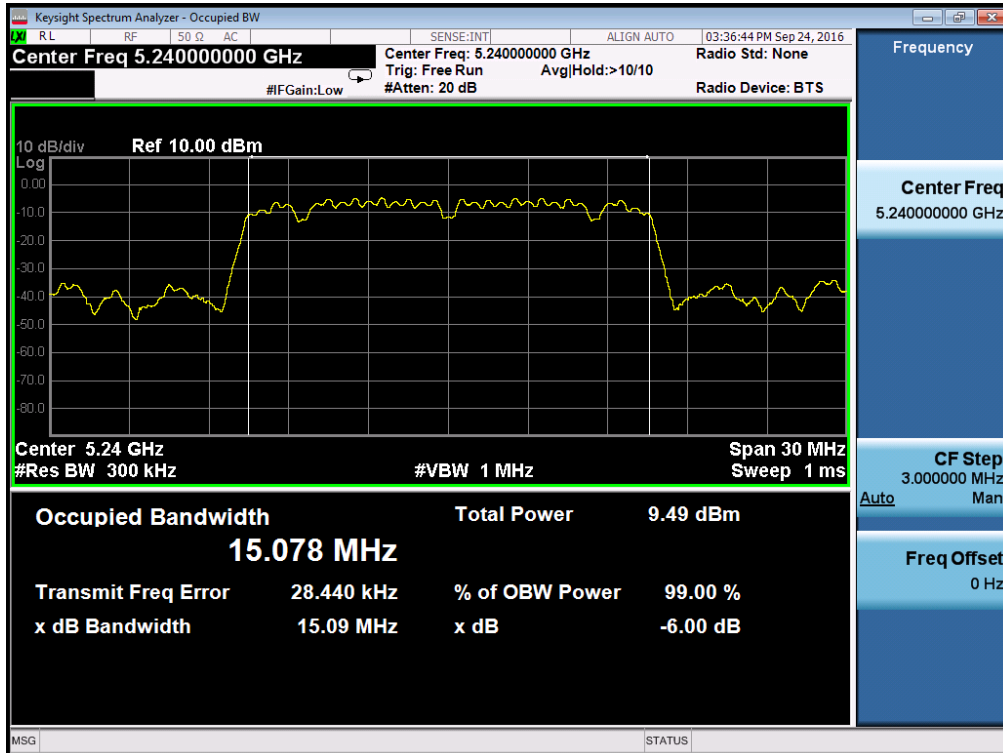

5725-5850MHz:
 -6dB Bandwidth

5736MHz-ANTA

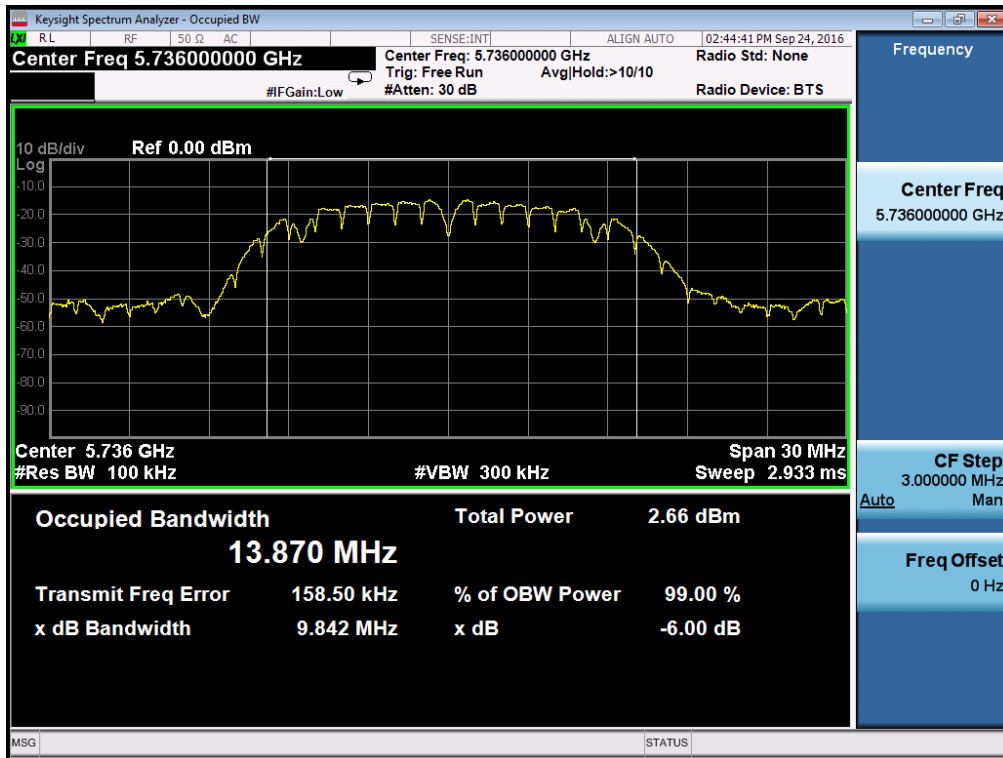

5736MHz-ANTB

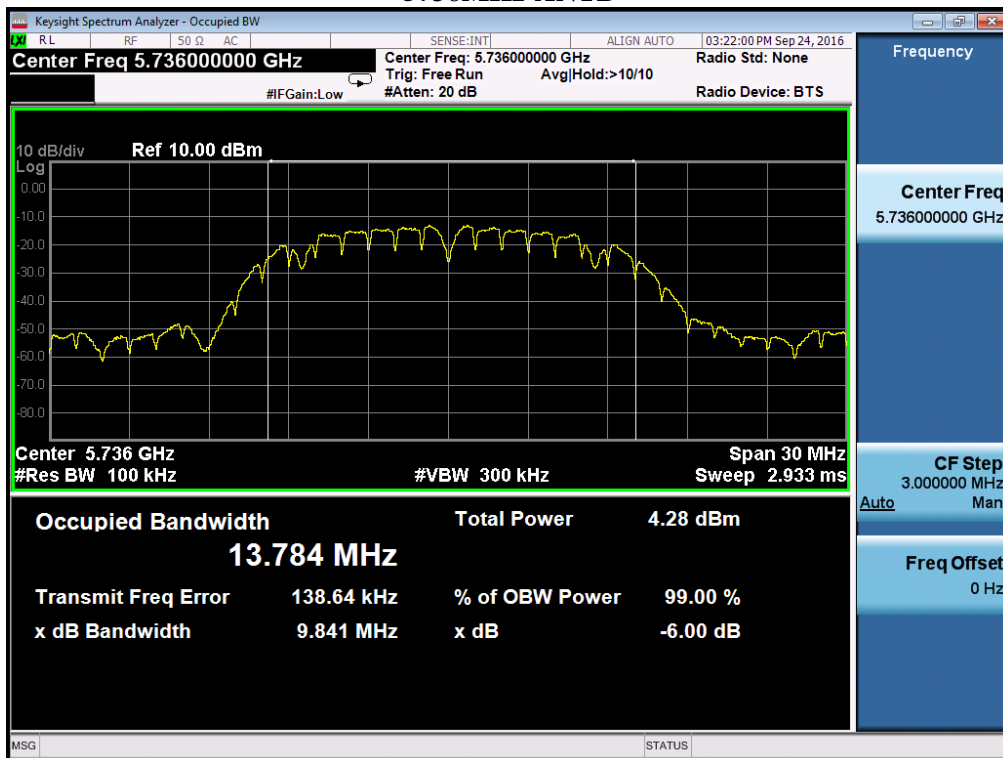

5762MHz-ANTA

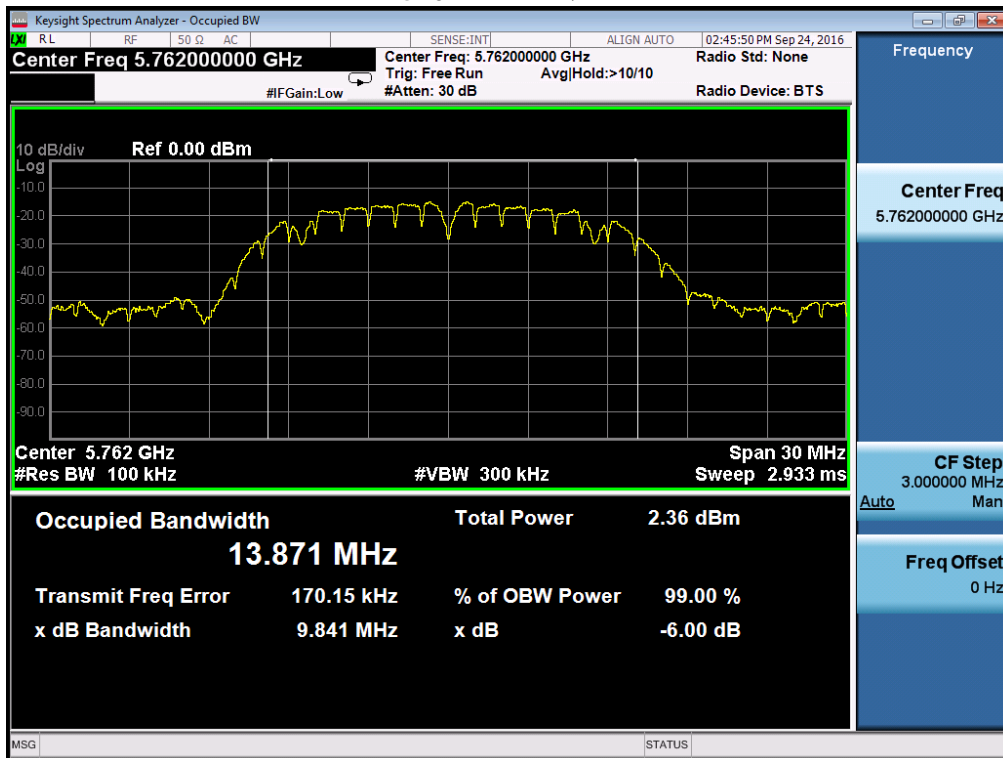

5762MHz-ANT B

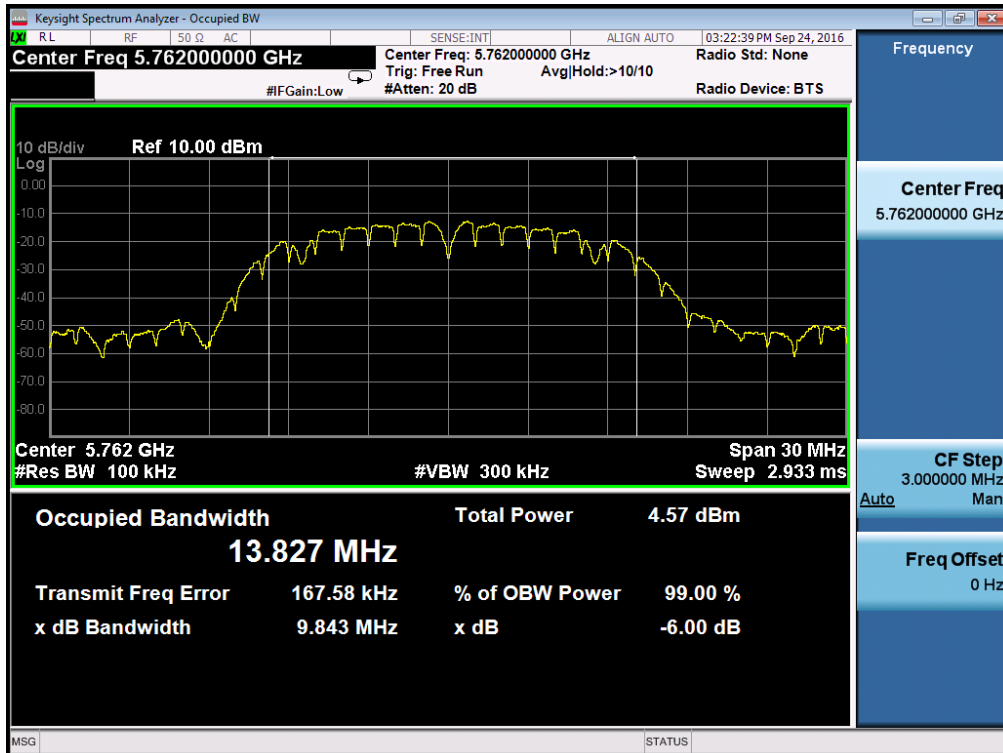

5814MHz-ANTA

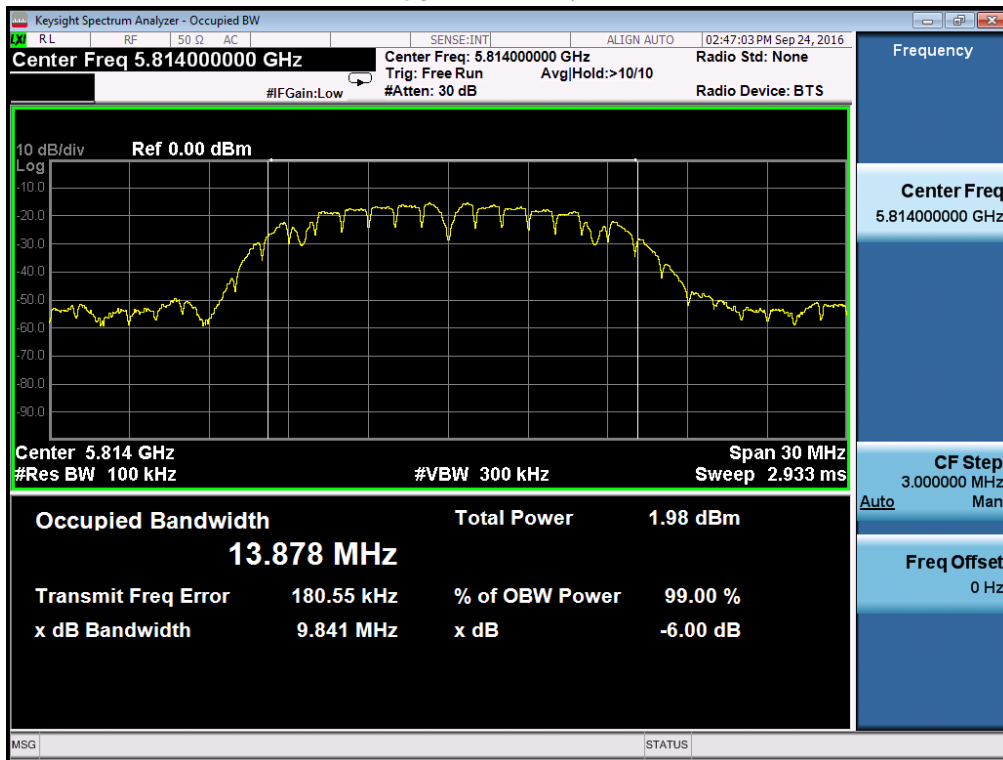

5814MHz-ANT B

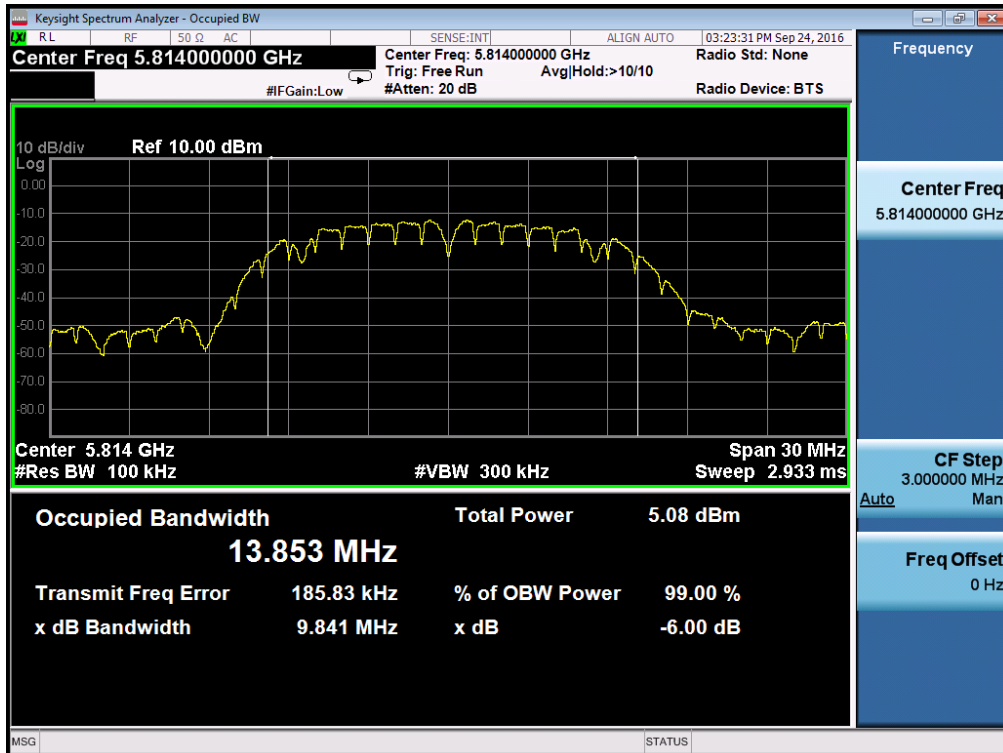

99% Bandwidth

5736MHz-ANTA

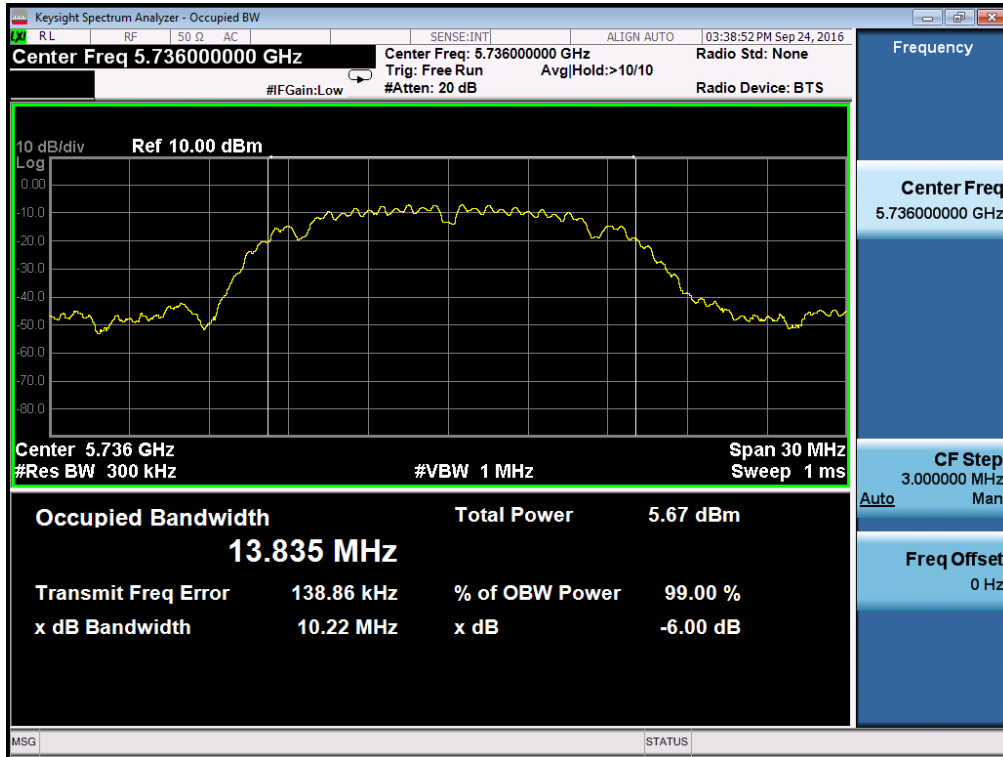

5736MHz-ANT B

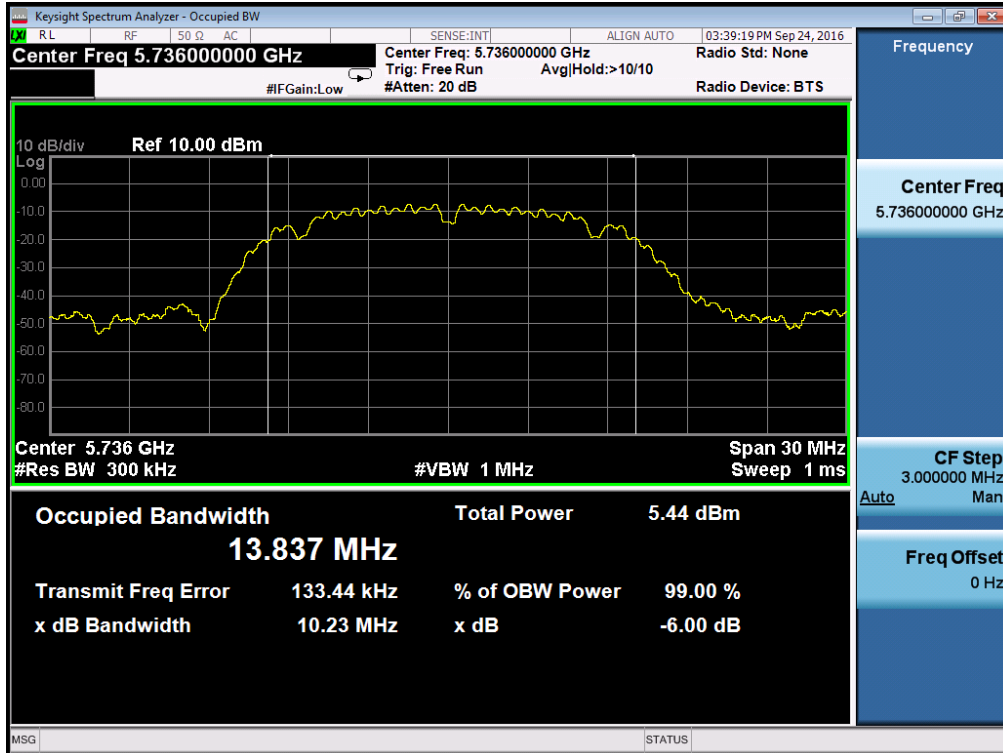

5762MHz-ANTA

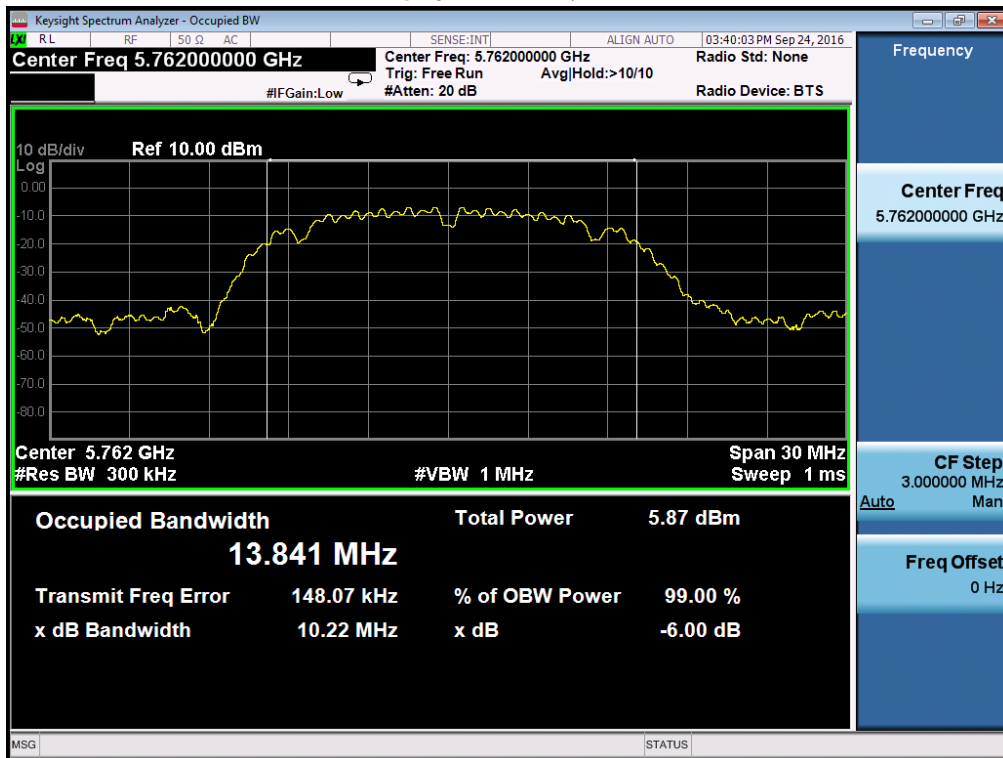

5762MHz-ANT B

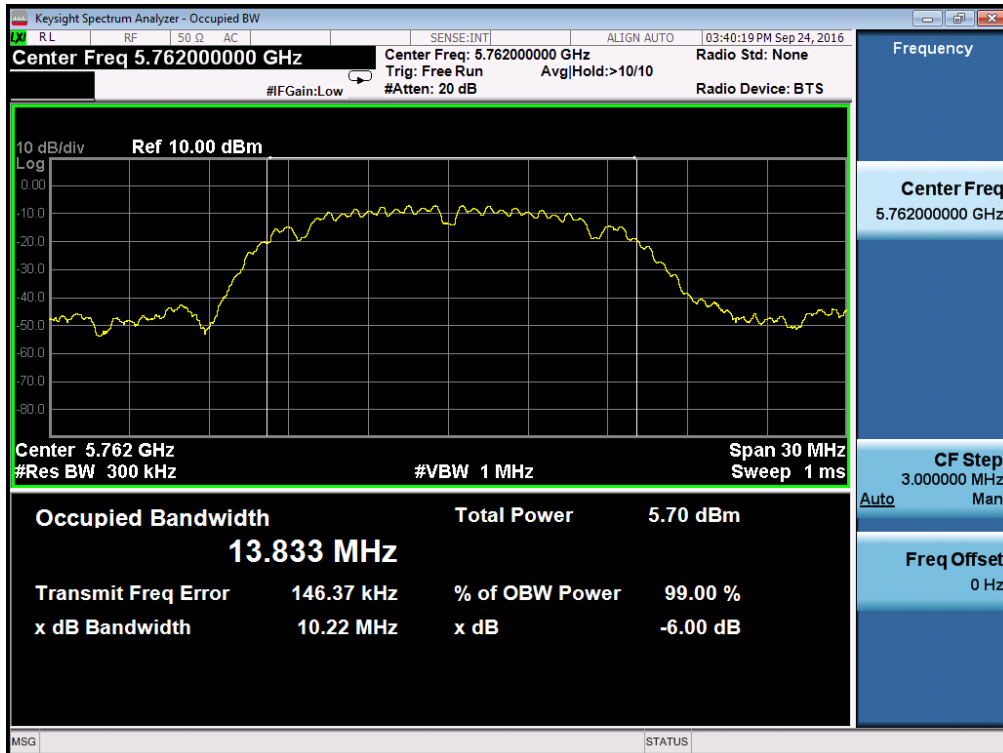

5814MHz-ANTA

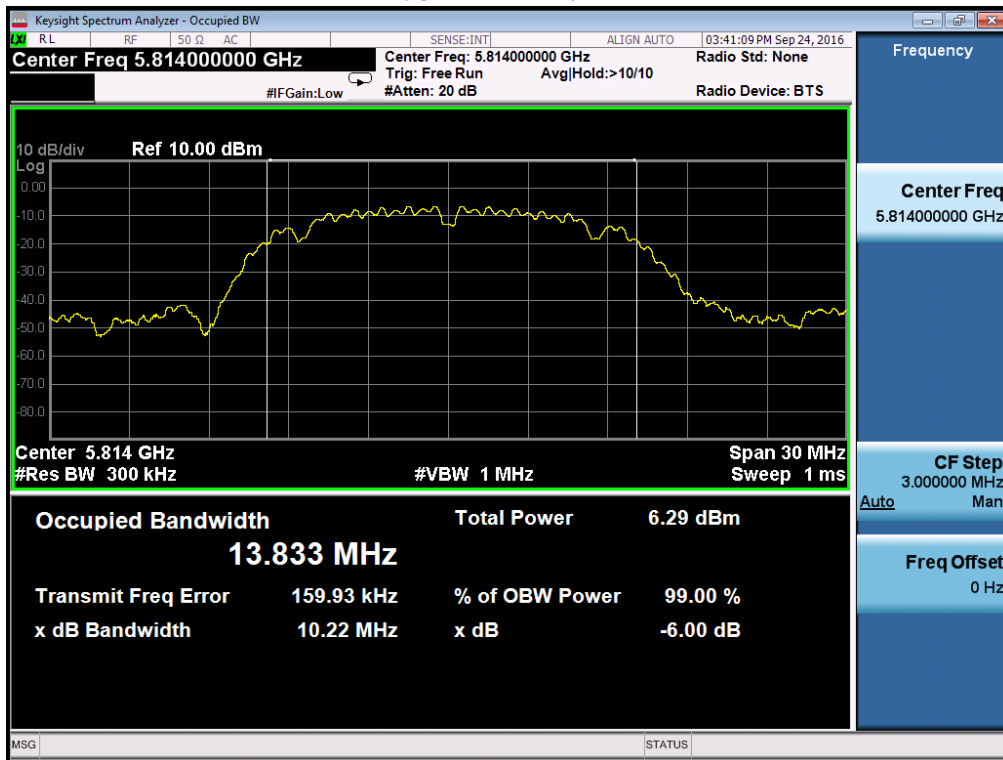

5814MHz-ANT B

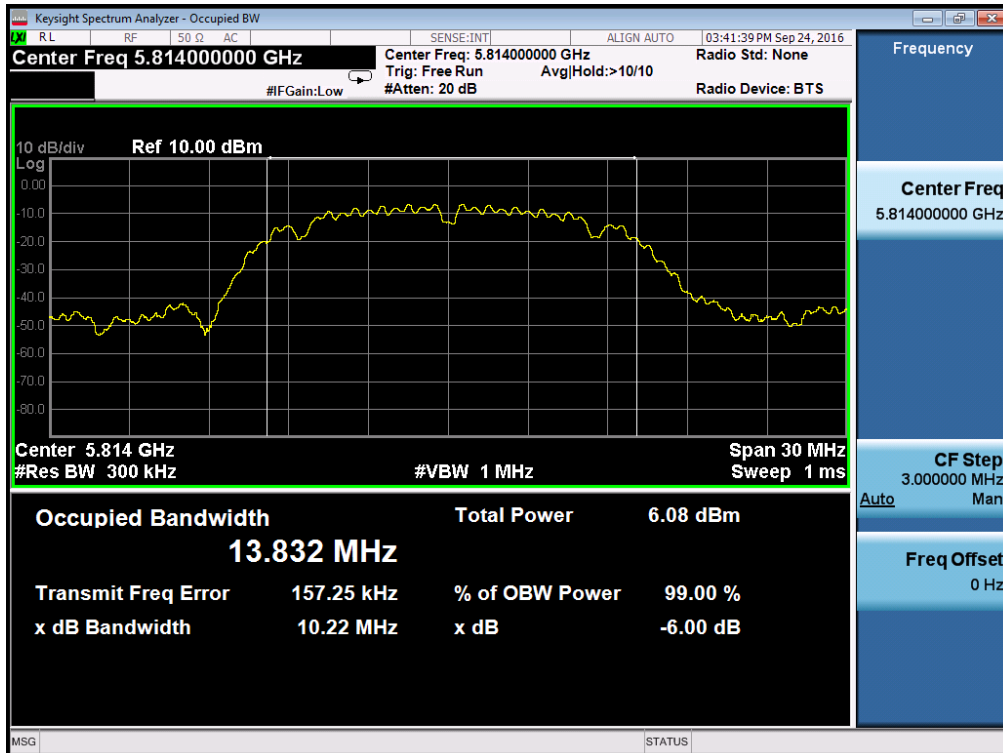

7. OUTPUT POWER TEST

7.1 Limits

Band 5.15-5.25GHz:

FCC: For mobile and portable client devices in the 5.15-5.25 GHz band, the maximum conducted output power over the frequency band of operation shall not exceed 250 mW provided the maximum antenna gain does not exceed 6 dBi.

IC: The maximum e.i.r.p. shall not exceed 200 mW or $10 + 10\log B$ dBm, whichever power is less. B is the 99% emission bandwidth in MHz.

Band 5.725-5.825GHz:

FCC: For the band 5.725-5.85 GHz, the maximum conducted output power over the frequency band of operation shall not exceed 1 W.

IC: The maximum conducted output power shall not exceed 1 W.

7.2 Test setup

1. The maximum average conducted output power can be measured using Method PM-G (Measurement using a gated RF average power meter):
2. Measurements may be performed using a wideband gated RF power meter provided that the gate parameters are adjusted such that the power is measured only when the EUT is transmitting at its maximum power control level. Since the measurement is made only during the ON time of the transmitter, no duty cycle correction factor is required.
 - a. The Transmitter output (antenna port) was connected to the power meter.
 - b. Turn on the EUT and power meter and then record the power value.
 - c. Repeat above procedures on all channels needed to be tested.



Duty cycle

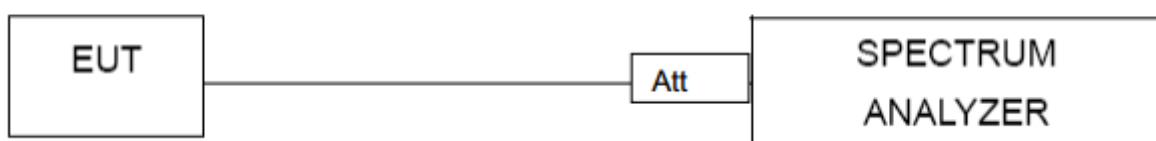

7.3 Test result

Frequency (MHz)	Average Output Power (dBm) ANT A	Average Output Power (dBm) ANT B	Total power (dBm)	IC Limit (dBm)	FCC Limit (dBm)	Result
5180	2.915	2.784	5.86	-	24	Pass
5210	3.015	2.856	5.95	-	24	Pass
5240	3.802	3.652	6.74	-	24	Pass
5736	-6.802	-7.256	-4.01	30	30	Pass
5762	-5.815	-6.462	-3.12	30	30	Pass
5814	-5.754	-6.332	-3.02	30	30	Pass

For 5.15~5.25GHz, the limit=200 mW or 10 +10logB dBm, whichever power is less

For 5.725-5.825GHz, the limit=1 W

EIRP=output power+antenna gain

Frequency (MHz)	Average Output Power (dBm)	Antenna Gain (dBi)	EIRP(dBm)	IC Limit (dBm)
5180	5.86	5.42	11.28	21.8
5210	5.95	5.42	11.37	21.8
5240	6.74	5.42	12.16	21.8

NOTE: During the test the EUT is in 100% duty cycle transmitting.

Test plot of Duty Cycle

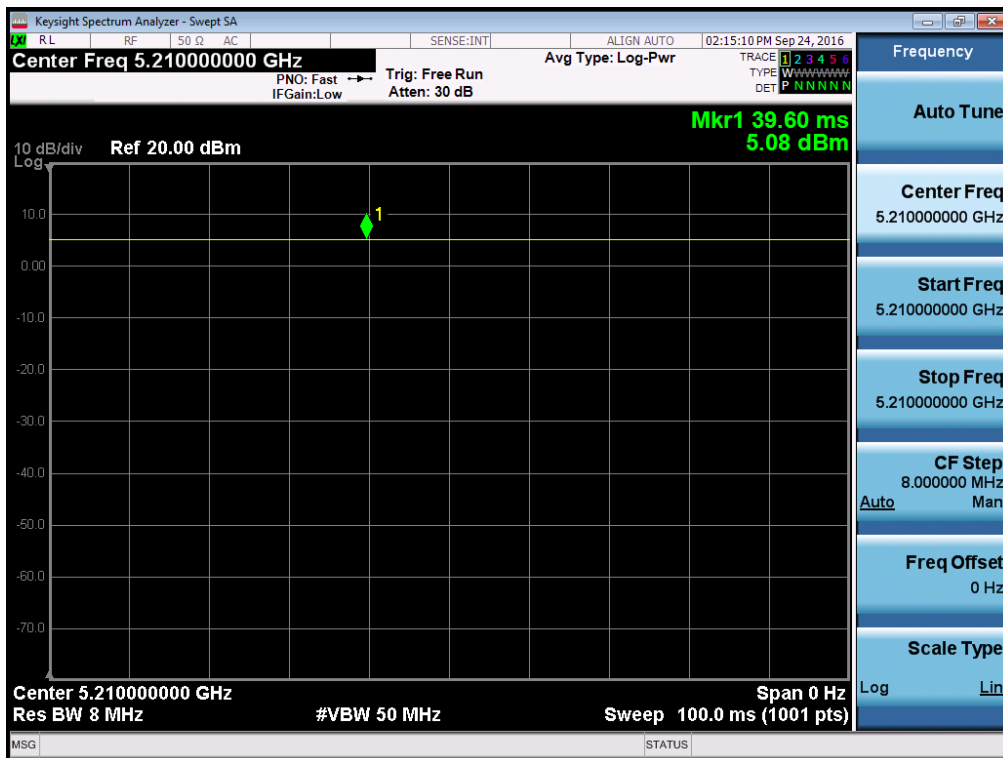

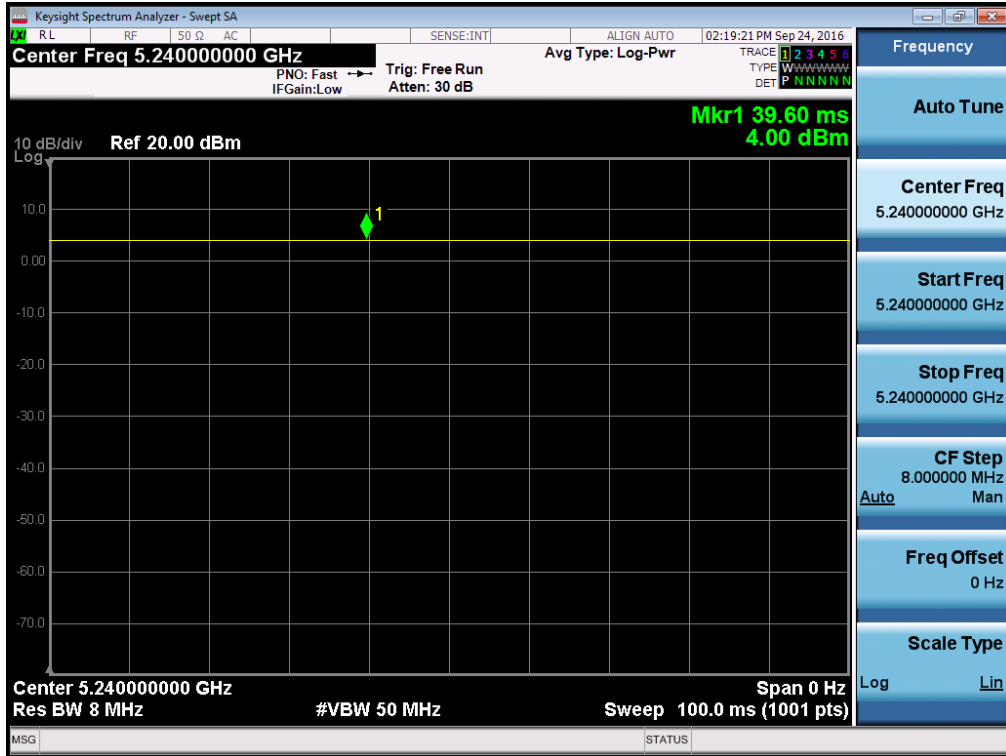

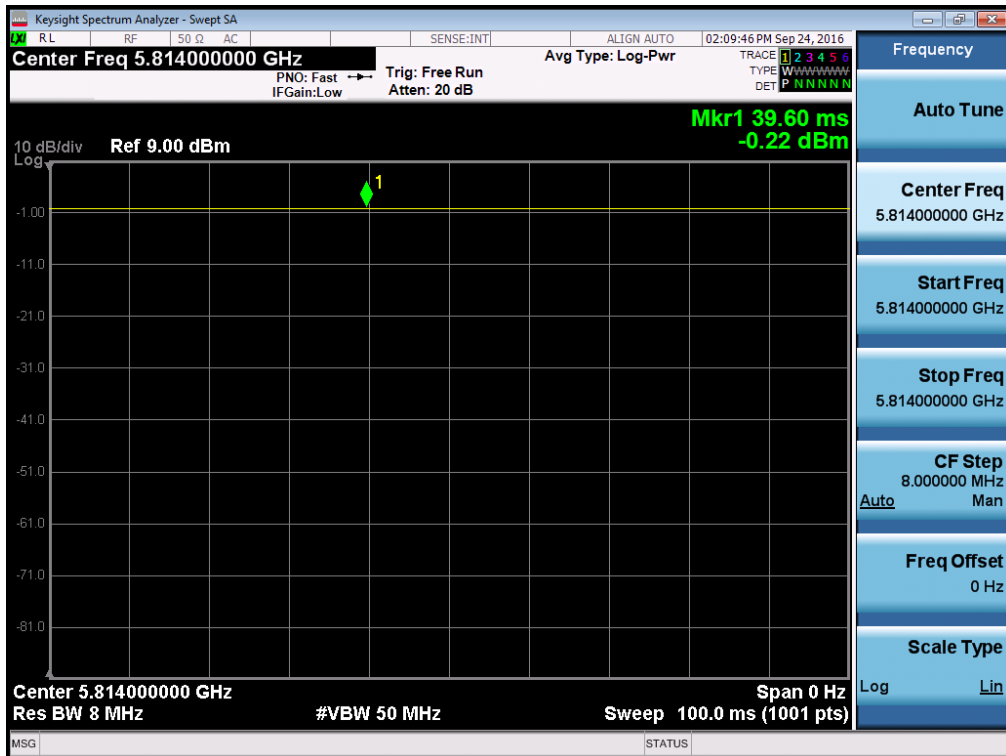

8. PEAK POWER SPECTRAL DENSITY TEST

8.1 Limits

Band 5.15-5.25GHz:

FCC: In addition, the maximum power spectral density shall not exceed 11 dBm in any 1 megahertz band.

IC: The e.i.r.p. spectral density shall not exceed 10 dBm in any 1.0 MHz band..

Band 5.725-5.825GHz:

FCC: In addition, the maximum power spectral density shall not exceed 30 dBm in any 500-kHz band.

IC: The power spectral density shall not exceed 30 dBm in any 500 kHz band. If transmitting antennas of directional gain greater than 6 dBi are used.

8.2 Test setup

Methods refer to FCC KDB 789033

- 1) Create an average power spectrum for the EUT operating mode being tested by following the instructions in section E)2) for measuring maximum conducted output power using a spectrum analyzer or EMI receiver: select the appropriate test method (SA-3, or alternatives to each) and apply it up to, but not including, the step labeled, "Compute power...".
- 2) Use the peak search function on the instrument to find the peak of the spectrum.
- 3) The result is the PPSD.
- 4) The above procedures make use of 1 MHz resolution bandwidth to satisfy the 1 MHz measurement bandwidth specified in the 15.407(a)(5). That rule section also permits use of resolution bandwidths less than 1 MHz "provided that the measured power is integrated to show the total power over the measurement bandwidth" (i.e., 1 MHz). If measurements are performed using a reduced resolution bandwidth and integrated over 1 MHz bandwidth



8.3 Test data

Test data as below

For FCC:
 5.15-5.25GHz

Frequency (MHz)	Power Density. Antenna A	Power Density. Antenna B	Total power	FCC Limit (dBm/MHz)
	(dBm/MHz)	(dBm/MHz)	(dBm/MHz)	
5180	-2.713	-2.305	0.51	11
5210	-2.694	-2.304	0.52	11
5240	-4.069	-2.514	-0.21	11

5.725-5.825GHz

Frequency (MHz)	Power Density. Antenna A	Power Density. Antenna B	Total power Density	FCC Limit (dBm/500KHz)
	(dBm/500KHz)	(dBm/500KHz)	(dBm/500KHz)	
5736	-9.053	-6.648	-4.68	30
5762	-9.332	-6.649	-4.78	30
5814	-9.628	-5.643	-4.18	30

For IC:

5.15-5.25GHz

Frequency (MHz)	Total power	Directional gain	e.i.r.p. spectral density	IC Limit (dBm/MHz)
	(dBm/MHz)	(dBi)	(dBm/MHz)	
5180	0.51	5.42	5.93	10
5210	0.52	5.42	5.94	10
5240	-0.21	5.42	5.21	10

5.725-5.825GHz

Frequency (MHz)	Power Density. Antenna A	Power Density. Antenna B	Total power Density	FCC Limit (dBm/500KHz)
	(dBm/500KHz)	(dBm/500KHz)	(dBm/500KHz)	
5736	-9.053	-6.648	-4.68	30
5762	-9.332	-6.649	-4.78	30
5814	-9.628	-5.643	-4.18	30

5150-5250 MHz:

5180MHz-ANTA

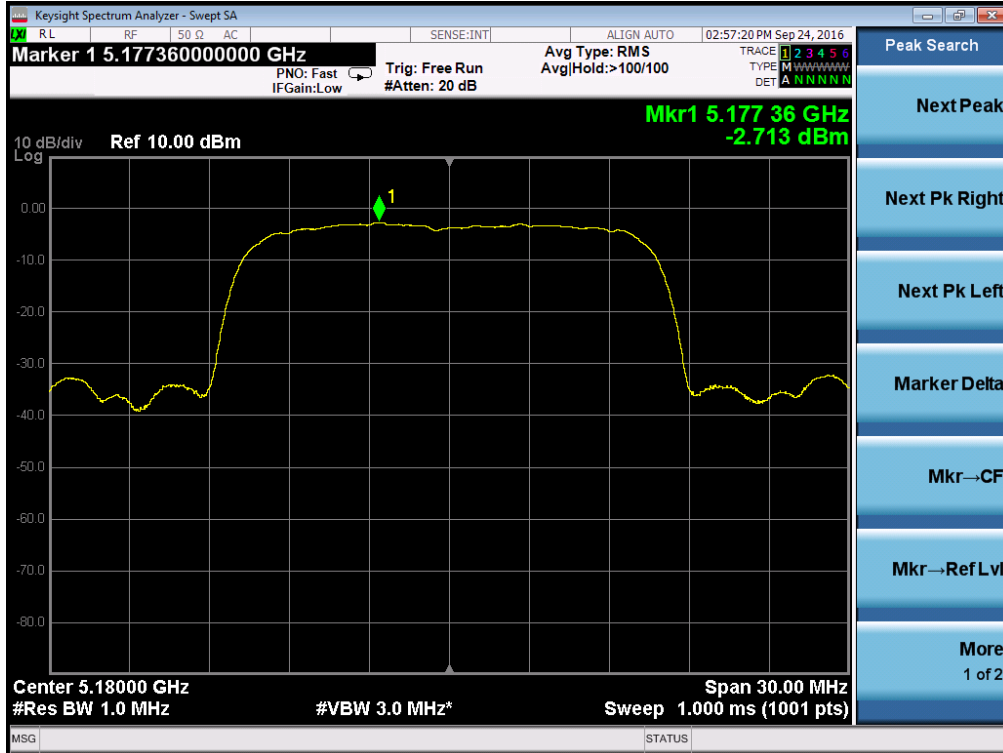

5180MHz-ANTB

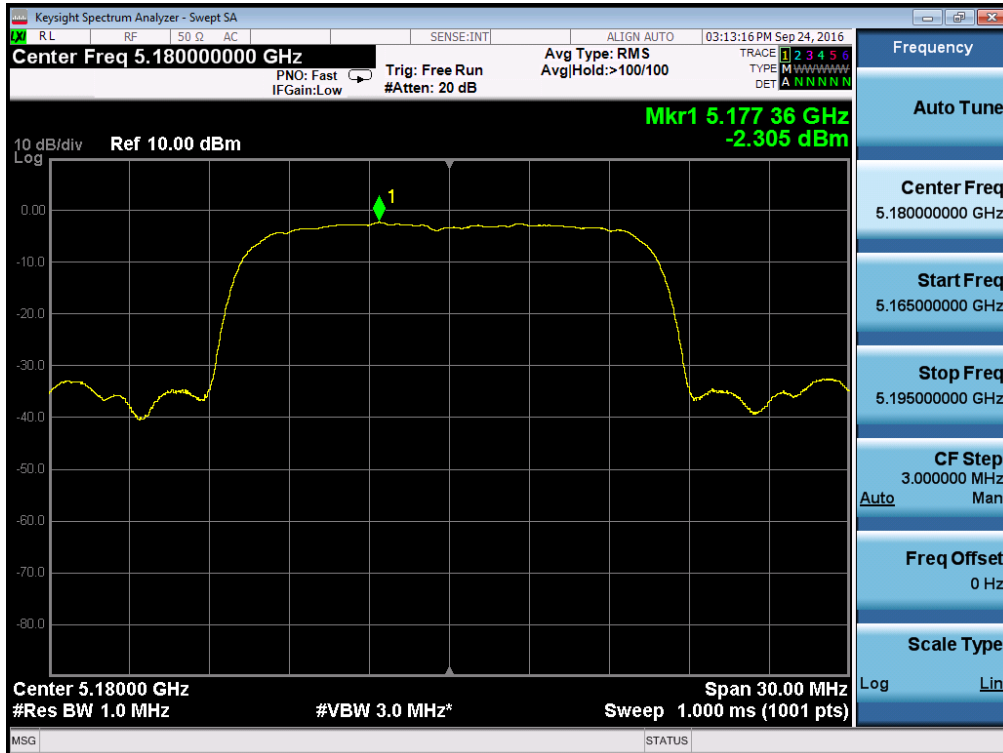

5210MHz-ANT A

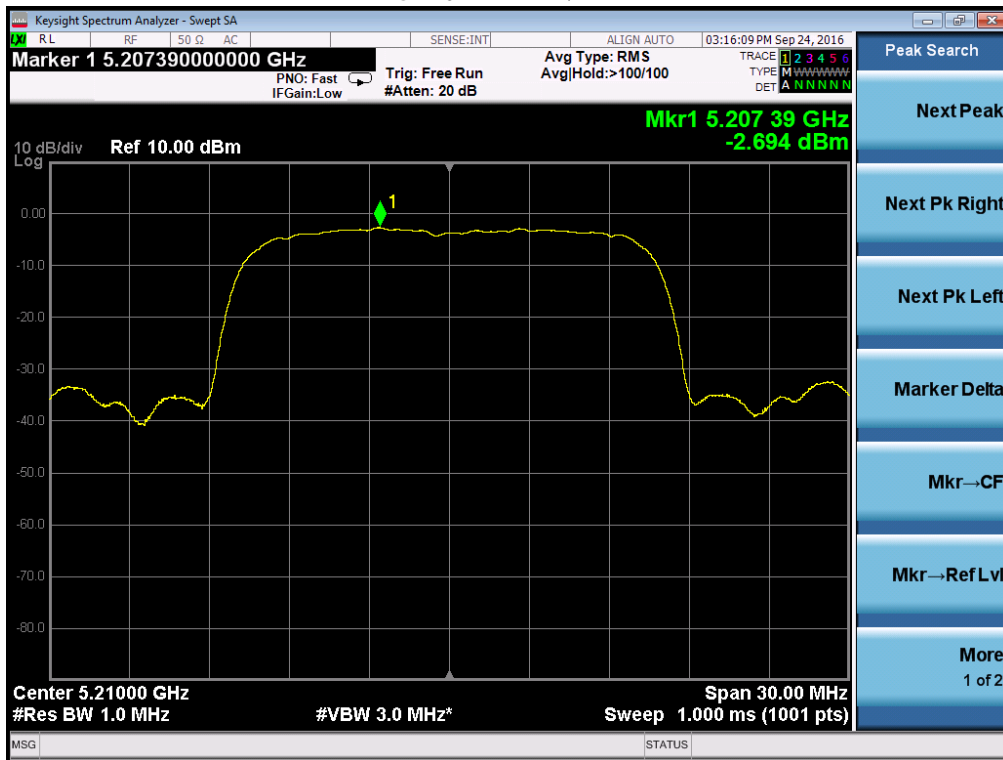

5210MHz-ANT B

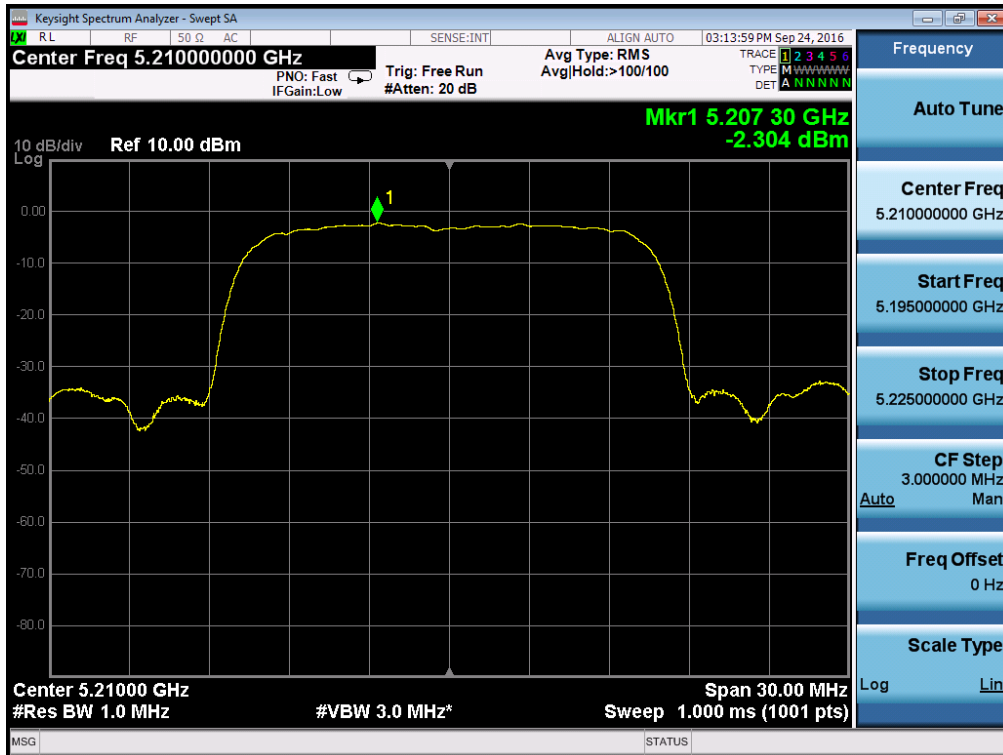

5240MHz-ANT A

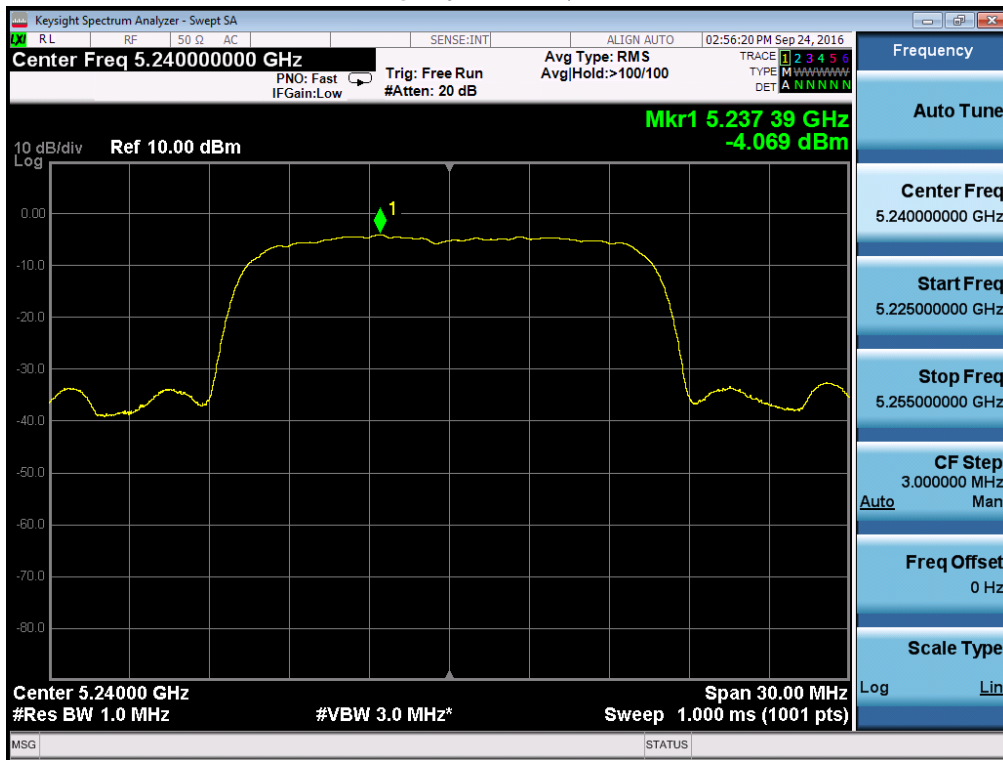

5240MHz-ANT B

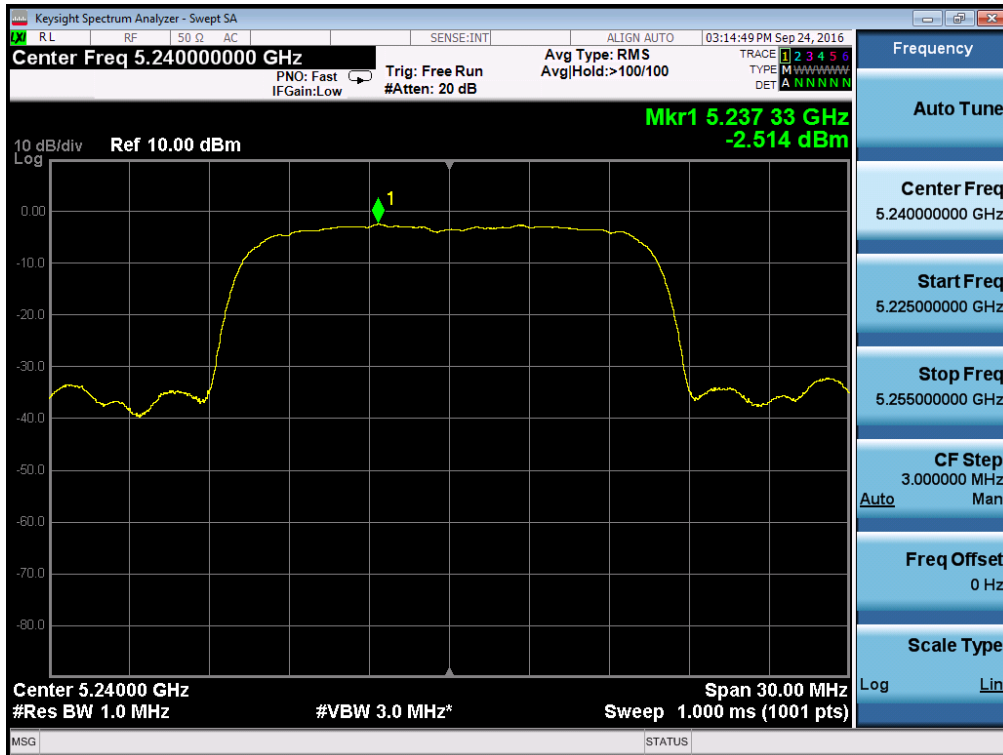

5725-5850MHz:

5736MHz-ANTA

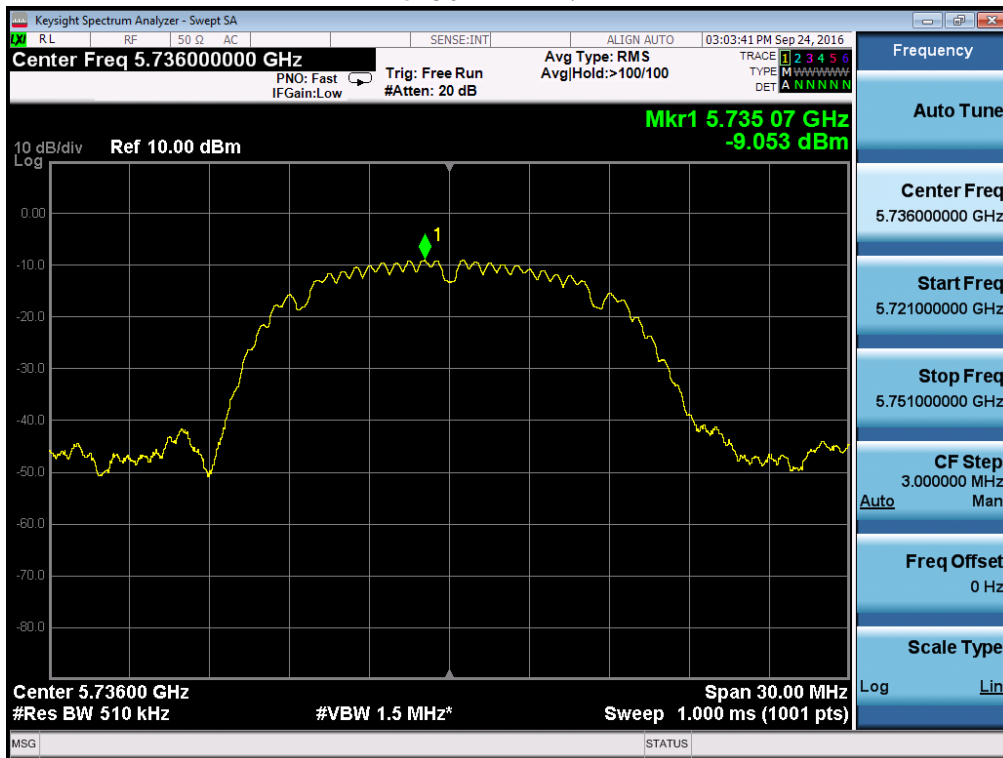

5736MHz-ANTB

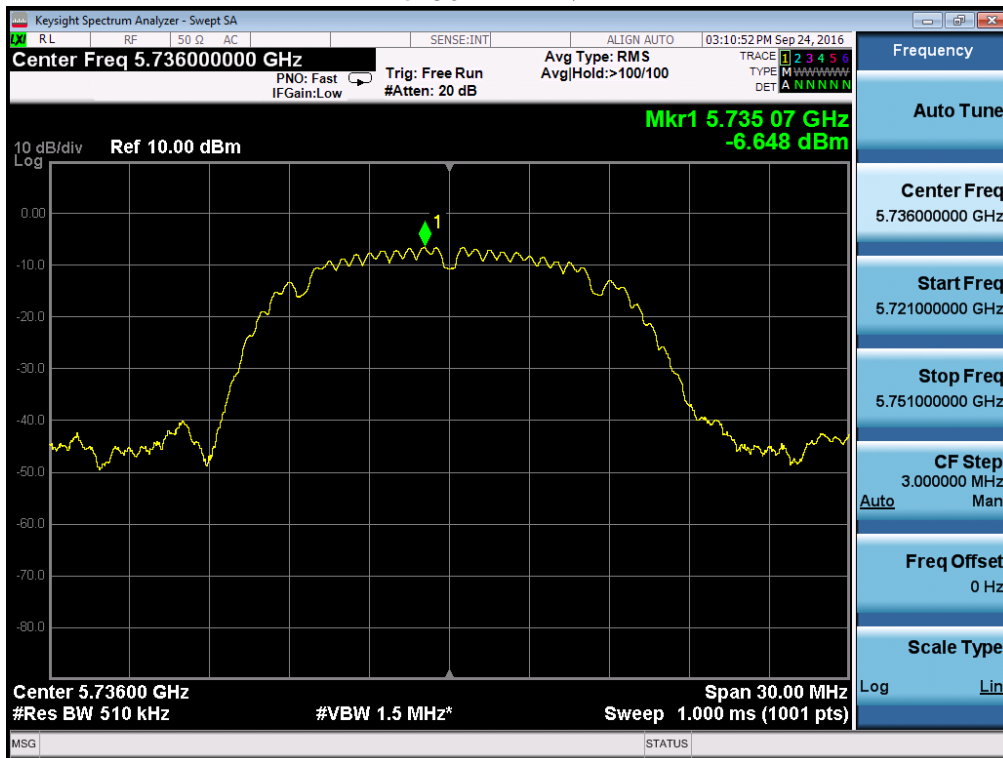

5762MHz-ANTA

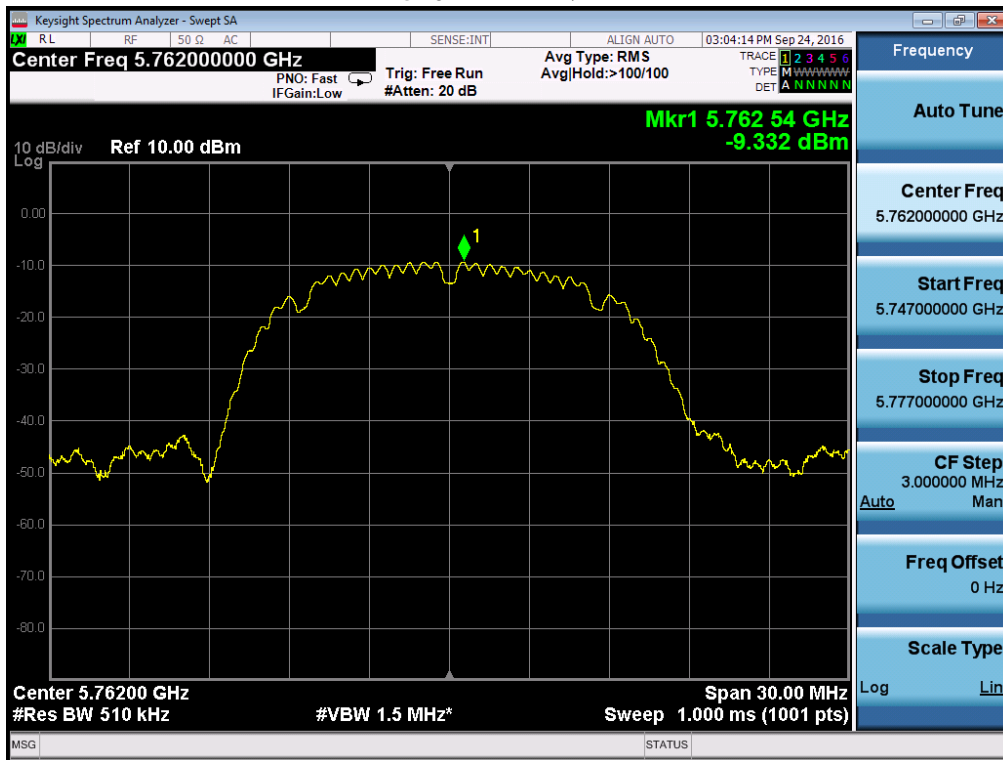

5762MHz-ANT B

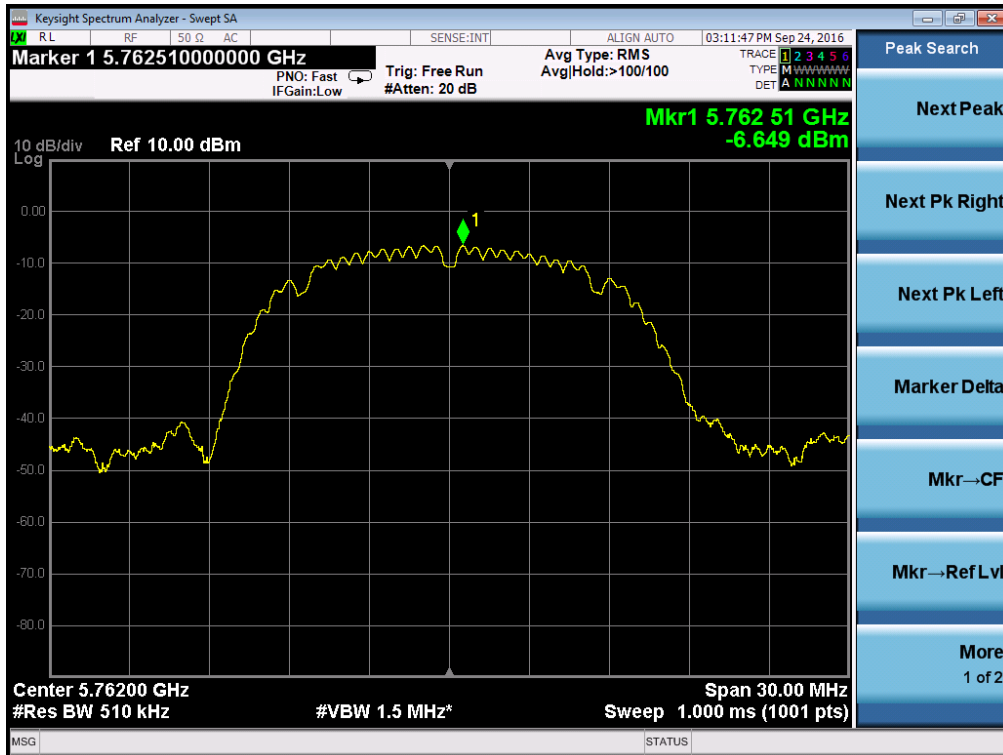

5814MHz-ANTA

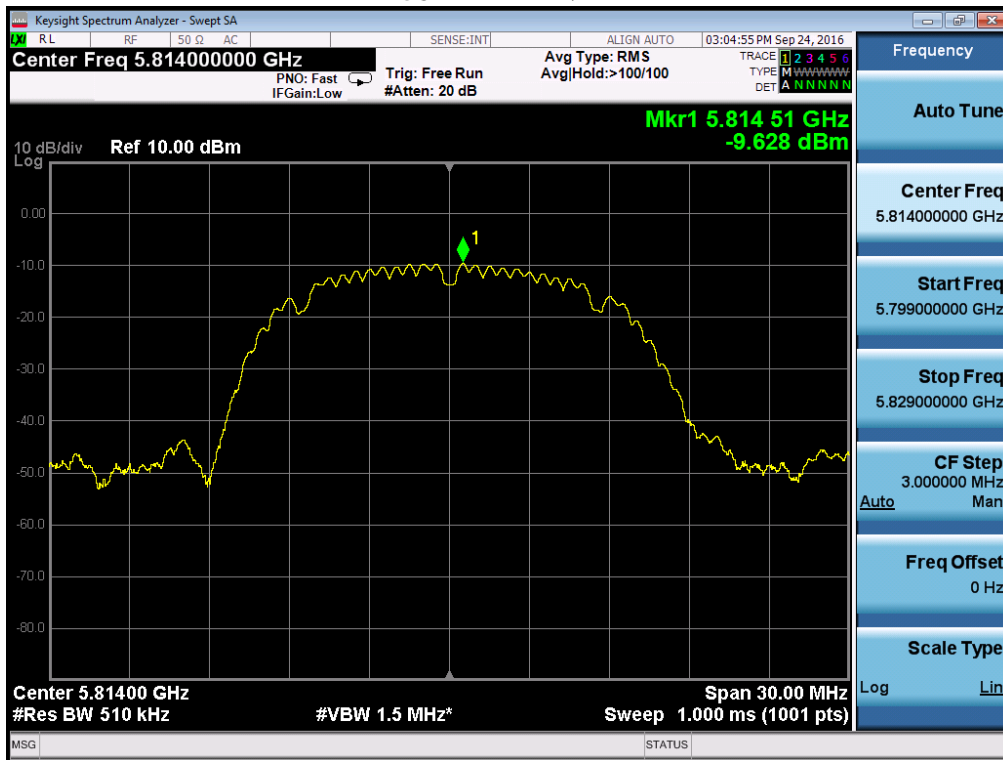

5814MHz-ANT B



9. FREQUENCY STABILITY TEST

9.1.limit

According to §15.407(g), manufacturers of U-NII devices are responsible for ensuring frequency stability such that an emission is maintained within the band of operation under all conditions of normal operation as specified in the user's manual.

9.2 Test Configuration

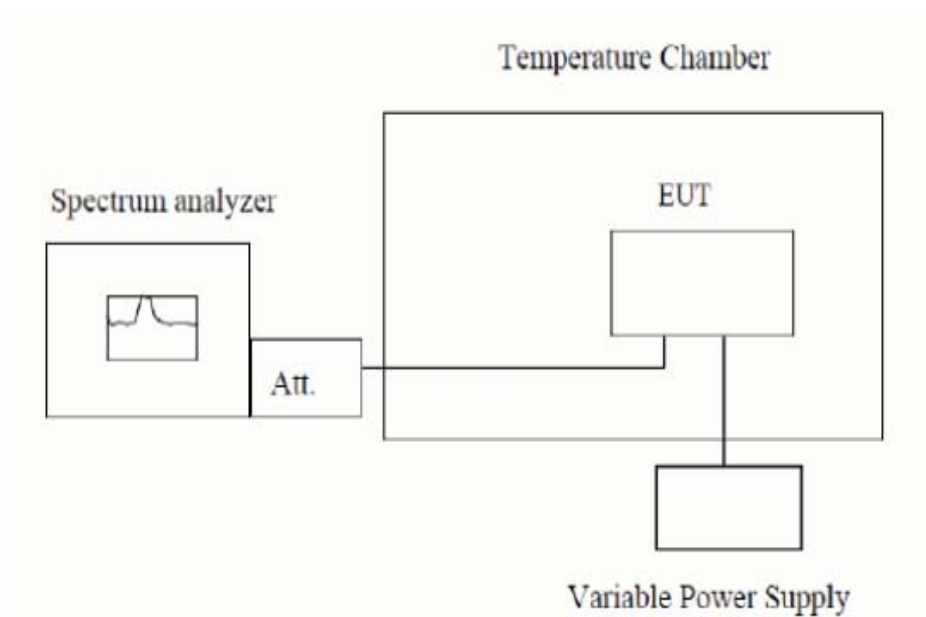

9.3 test procedure

1. The transmitter output (antenna port) was connected to the spectrum analyzer.
2. EUT have transmitted absence of modulation signal and fixed channelize.
3. Set the spectrum analyzer span to view the entire absence of modulation emissions bandwidth.
4. Set RBW = 10 kHz, VBW = 10 kHz with peak detector and maxhold settings.
5. f_c is declaring of channel frequency. Then the frequency error formula is $(f_c - f) / f_c \times 10^6$ ppm and the limit is less than ± 20 ppm (IEEE 802.11 specification).
6. The test extreme voltage is to change the primary supply voltage from 85 to 115 percent of the nominal value
7. Extreme temperature rule is $-30^\circ\text{C} \sim 50^\circ\text{C}$.

Test result

Measurement Data (the worst channel):

Frequency Stability under Temperature

Operating Frequency: 5180 MHz				
Environment Temperature (°C)	Voltage (V)	Measured Frequency (MHz)	Test Result (MHz)	Max. Deviation (ppm)
50	5	5180	5180.0135	2.606
40	5	5180	5180.0103	1.988
30	5	5180	5180.0112	2.162
20	5	5180	5180.0117	2.258
10	5	5180	5180.0105	2.027
0	5	5180	5180.0143	2.761
-10	5	5180	5180.0112	2.162
-20	5	5180	5180.0133	2.568
-30	5	5180	5180.0124	2.394

Frequency Stability under Voltage

Operating Frequency: 5180 MHz			
AC Voltage (V)	Measured Frequency (MHz)	Test Result (MHz)	Max. Deviation (ppm)
4.5	5180	5180.0132	2.548
5.0	5180	5180.0238	4.595
5.5	5180	5180.0134	2.587

10.ANTENNA REQUIREMENTS

10.1 Limits

For intentional device, according to FCC 47 CFR Section 15.203, an intentional radiator shall be designed to ensure that no antenna other than that furnished by the responsible party shall be used with the device. And according to FCC 47 CFR Section 15.247 (b), if transmitting antennas of directional gain greater than 6dBi are used, the power shall be reduced by the amount in dB that the directional gain of the antenna exceeds 6dBi.

10.2 Result

The antennas used for this product is PCB antenna and that no antenna other than that furnished by the responsible party shall be used with the device, the maximum peak gain of the transmit antenna is only 2.408dBi.

11. PHOTOGRAPHS OF TEST SET-UP

Conducted Emission



Radiated Emission Test



12. PHOTOGRAPHS OF THE EUT









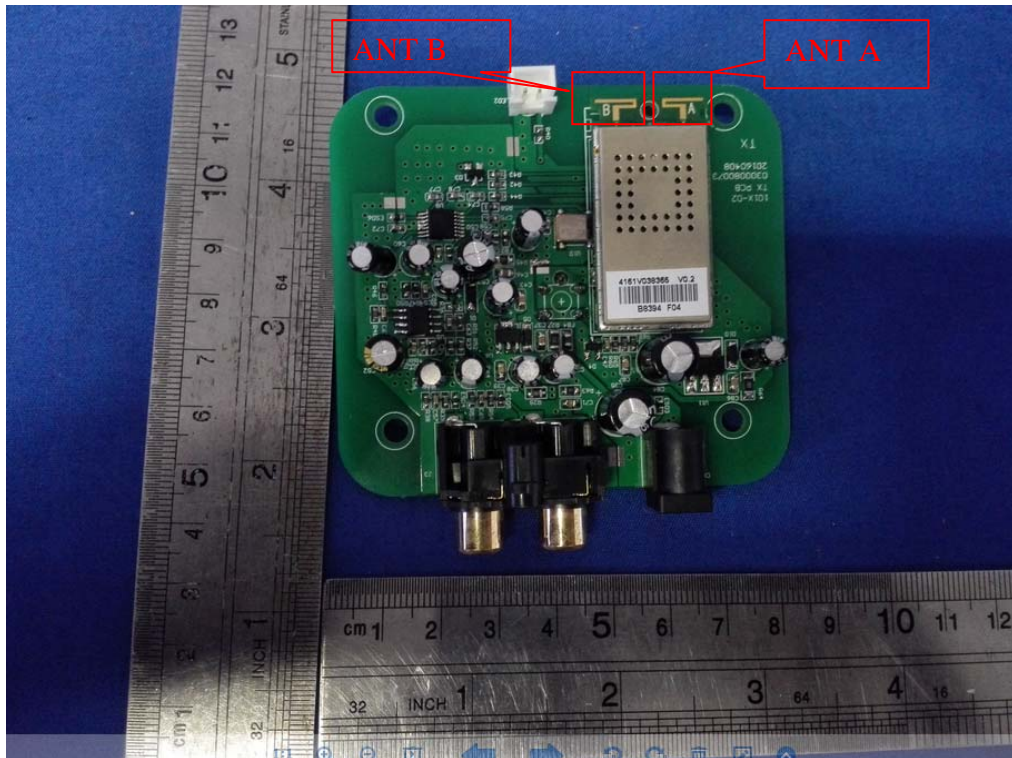
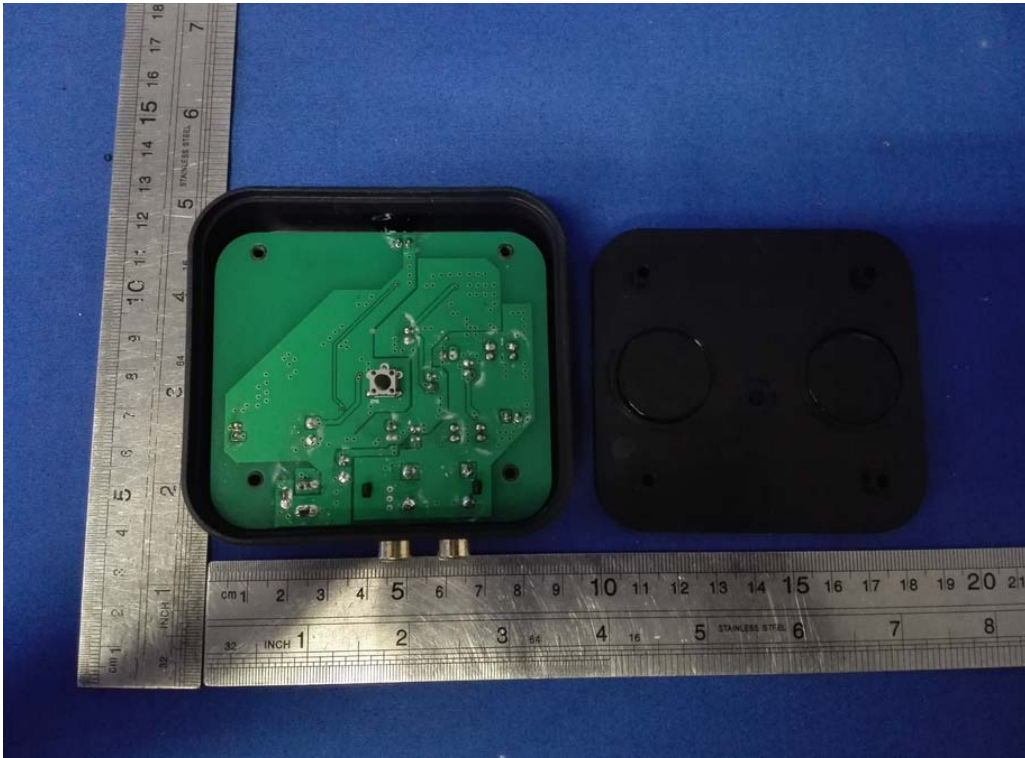

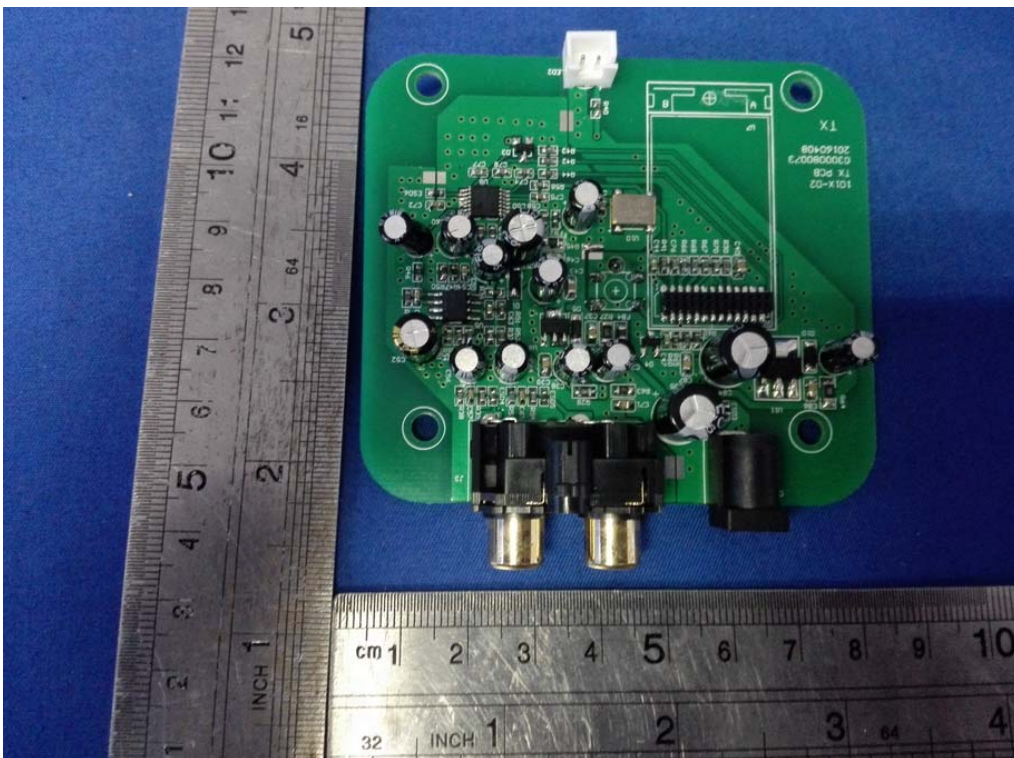
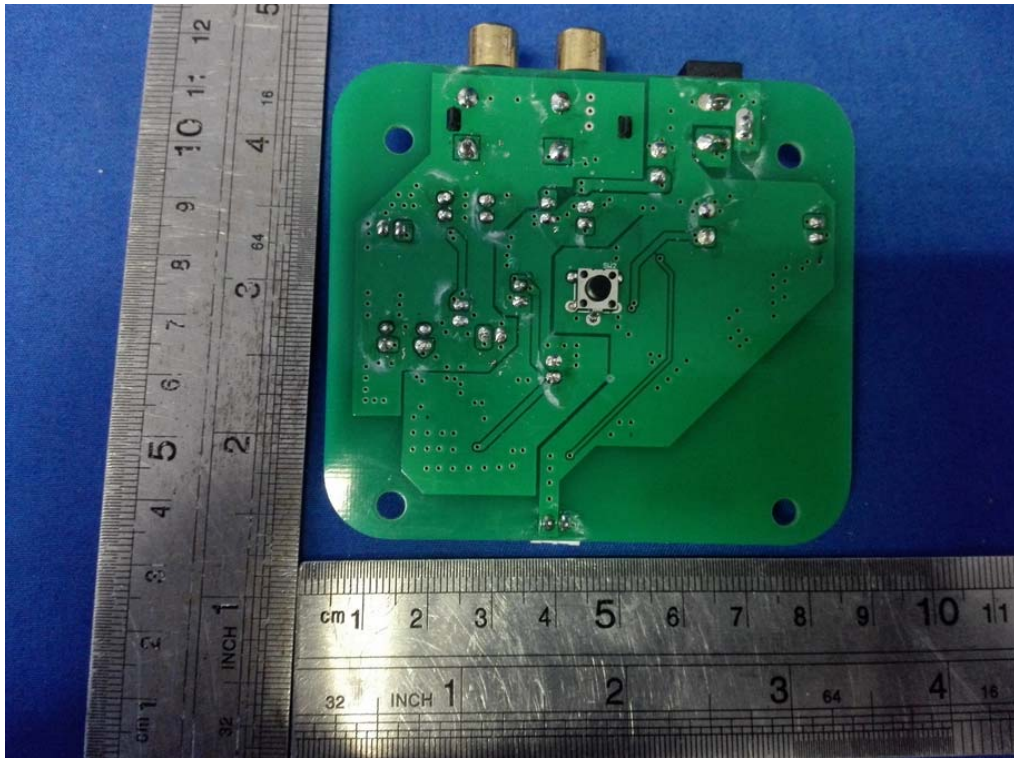

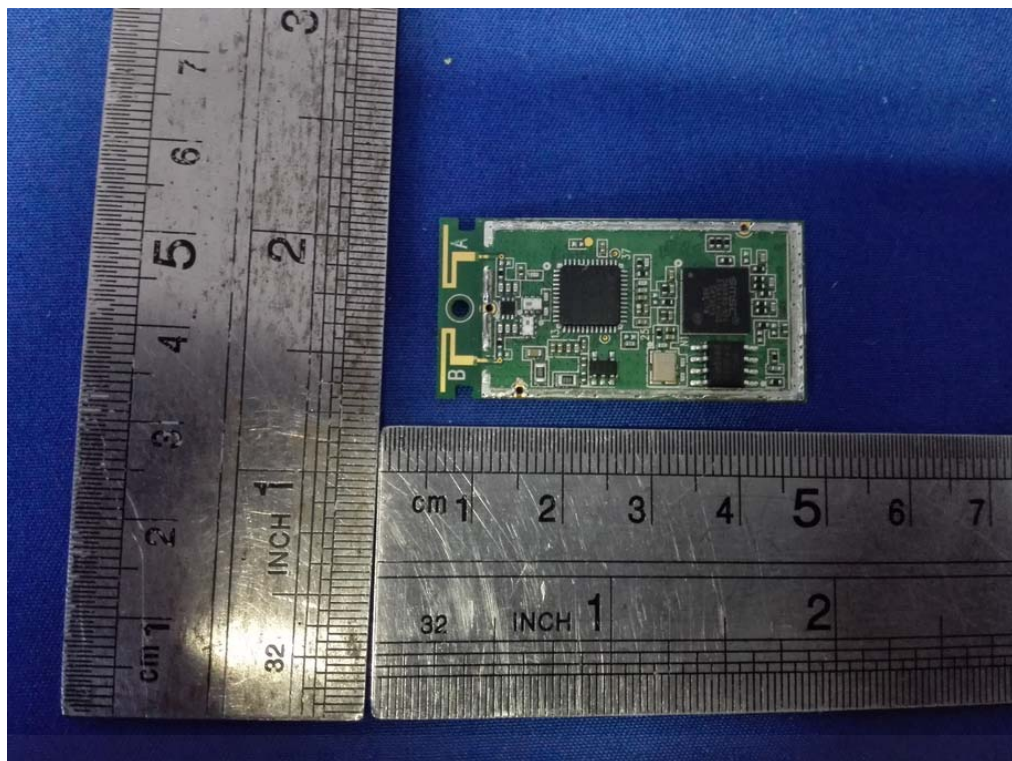
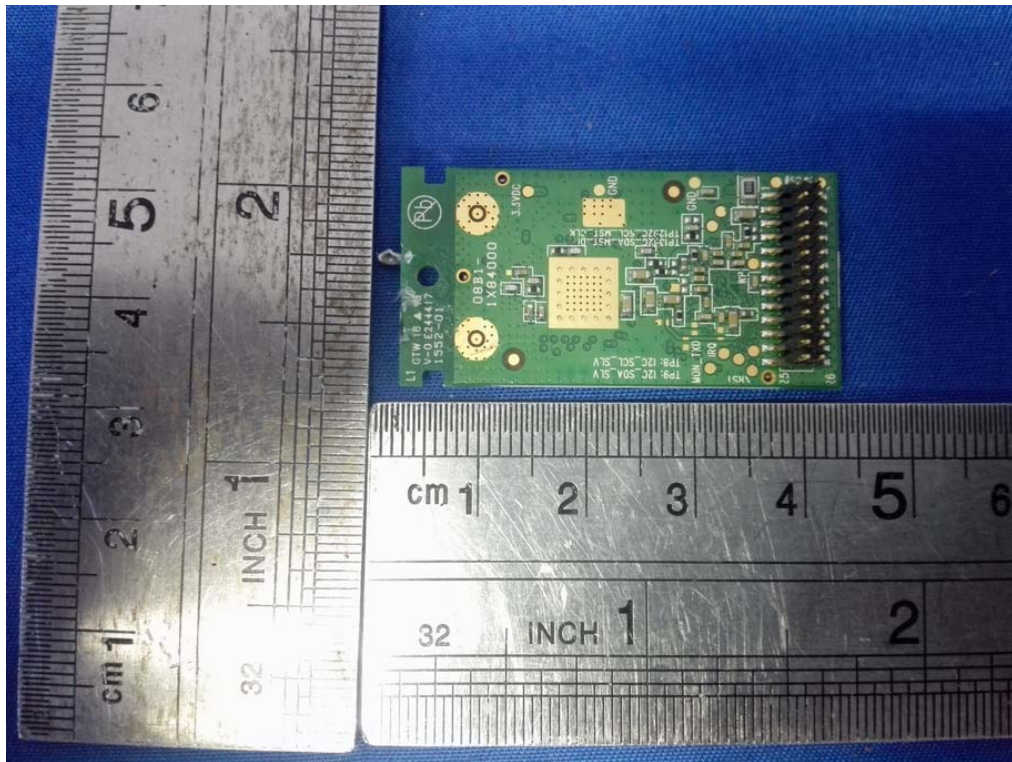



-----END-----