



Report No.: 160302035GZU-001  
Issued: 2016-3-30

**TEST REPORT**

Applicant Name & Address : Bradley Technologies Canada Inc.  
8380 River rd, Delta BC, V4G1B5 Canada

Sample Description  
Product : Smoker  
FCC ID : 2AGTD-GC730701  
Model No. : BS916  
Electrical Rating : 120V/60Hz,625W

Date Received : 02 March 2016

Date Test Conducted : 03 March 2016-10 March 2016

Test standards : 47 CFR PART 15 Subpart C: 2014 section 15.249

Test Result : Pass

Conclusion : The submitted samples complied with the above rules/standards.

Remark : None.

\*\*\*\*\*End of Page\*\*\*\*\*

**Prepared and Checked By:**

**Approved By:**

**Sky Zhu**  
**Project Engineer**  
**Intertek Guangzhou**

**Helen Ma**  
**Team Leader**  
**Intertek Guangzhou**  
**30 March 2016** *Date*

This report is for the exclusive use of Intertek's Client and is provided pursuant to the agreement between Intertek and its Client. Intertek's responsibility and liability are limited to the terms and conditions of the agreement. Intertek assumes no liability to any party, other than to the Client in accordance with the agreement, for any loss, expense or damage occasioned by the use of this report. Only the Client is authorized to permit copying or distribution of this report and then only in its entirety. Any use of the Intertek name or one of its marks for the sale or advertisement of the tested material, product or service must first be approved in writing by Intertek. The observations and test results in this report are relevant only to the sample tested. This report by itself does not imply that the material, product, or service is or has ever been under an Intertek certification program. The test report only allows to be revised within three years from its original issued date unless further standard or the requirement was noticed.

Intertek Testing Services Shenzhen Ltd. Guangzhou Branch  
Block E, No.7-2 Guang Dong Software Science Park, Caipin Road, Guangzhou Science City, GETDD Guangzhou, China  
Tel / Fax: 86-20-8213 9688/86-20-3205 7538

## CONTENT

<b>TEST REPORT</b> .....	1
<b>CONTENT</b> .....	2
1.0 Summary of Test .....	3
2.0 General Description .....	4
2.1 Product Description .....	4
2.2 Related Submittal(s) Grants .....	5
2.3 Test Methodology .....	5
2.4 Test Facility .....	5
3.0 System Test Configuration .....	6
3.1 Justification .....	6
3.2 EUT Exercising Software .....	7
3.3 Special Accessories .....	7
3.4 Measurement Uncertainty .....	7
3.5 Equipment Modification .....	7
3.6 Support Equipment List and Description .....	7
4.0 Measurement Results .....	8
4.1 Antenna Requirement: .....	8
4.2 Occupied Bandwidth: .....	9
4.7 Radiated Emission .....	13
4.8 Band Edges Requirement .....	26
4.9 Conducted Emissions at Mains Terminals .....	29
10.0 Test Equipment List .....	32



Report No.: 160302035GZU-001  
Issued: 2016-3-30

## 1.0 Summary of Test

TEST	TEST REQUIREMENT	TEST METHOD	RESULT
Antenna Requirement	FCC PART 15 C Section 15.203	FCC PART 15 C Section 15.203	PASS
Occupied Bandwidth	FCC PART 15 C section 15.215(c)	ANSI C63.10: Clause 6.9	PASS
Radiated Emission	FCC PART 15 C section 15.249 (a), (d)	ANSI C63.10: Clause 6.4, 6.5 & 6.6	PASS
Band Edges Measurement	FCC PART 15 C section 15.249 (d)	ANSI C63.10: Clause 6.10	PASS
Conducted Emissions at Mains Terminals	FCC PART 15 C section 15.207	ANSI C63.10: Clause 6.2	PASS
<b>Remark:</b> N/A: not applicable. Refer to the relative section for the details. EUT: In this whole report EUT means Equipment Under Test. Tx: In this whole report Tx (or tx) means Transmitter. Rx: In this whole report Rx (or rx) means Receiver. RF: In this whole report RF means Radio Frequency. ANSI C63.10: the detail version is ANSI C63.10:2013 in the whole report.			

## 2.0 General Description

### 2.1 Product Description

Operating Frequency	2402 MHz to 2480 MHz
Type of Modulation:	GFSK
Number of Channels	40 Channels
Channel Separation:	2 MHz
Antenna Type	Integral
Antenna gain:	2 dBi
Speciality:	Bluetooth 4.0 with BLE (Bluetooth Low Energy)
Function:	Communicate with app in phone or pad
Power Supply:	120V/60Hz 560W
Power cord:	1.1 m x 3 wires unscreened AC supply cable
EUT modulation and data packet during test:	
The EUT has been tested on the Modulation of GFSK with 1 Mbps data rate.	

EUT channels and frequencies list:

Test frequencies are the lowest channel 0: 2402 MHz, middle channel 19: 2440 MHz and the highest channel 39: 2480 MHz

Channel	Frequency (MHz)	Channel	Frequency (MHz)	Channel	Frequency (MHz)
0	2402	14	2430	28	2458
1	2404	15	2432	29	2460
2	2406	16	2434	30	2462
3	2408	17	2436	31	2464
4	2410	18	2438	32	2466
5	2412	19	2440	33	2468
6	2414	20	2442	34	2470
7	2416	21	2444	35	2472
8	2418	22	2446	36	2474
9	2420	23	2448	37	2476
10	2422	24	2450	38	2478
11	2424	25	2452	39	2480
12	2426	26	2454	/	/
13	2428	27	2456	/	/

## **2.2 Related Submittal(s) Grants**

This is an application for certification of:  
DXX - Low power communications device transmitter

Remaining portions are subject to the following procedures:

1. Receiver portion of BLE: exempt from technical requirement of this Part.

## **2.3 Test Methodology**

Both AC mains line-conducted and radiated emission measurements were performed according to the procedures in ANSI C63.10:2013. Radiated emission measurement was performed in semi-anechoic chamber and conducted emission measurement was performed in shield room. For radiated emission measurement, preliminary scans and final tests were performed in the semi-anechoic chamber to determine the worst case modes. All radiated tests were performed at an antenna to EUT distance of 3 meters, unless stated otherwise.

## **2.4 Test Facility**

All of the tests are performed at:  
Intertek Testing Services Shenzhen Ltd. Guangzhou Branch  
Block E, No.7-2 Guang Dong Software Science Park, Caipin Road, Guangzhou Science City,  
GETDD Guangzhou, China.

This test facility and site measurement data have been fully placed on file with the FCC, test firm registration number is 549654.

### 3.0 System Test Configuration

#### 3.1 Justification

For emissions testing, the equipment under test (EUT) setup to transmit continuously to simplify the measurement methodology. Care was taken to ensure proper power supply voltages during testing. During testing, AC power line was manipulated to produce worst case emissions. It was powered by AC 120V/60Hz supply.

The signal is maximized through rotation; the antenna height and polarization are varied during the search for maximum signal level. The antenna height is varied from 1 to 4 meters. Radiated emissions are taken at three meters unless the signal level is too low for measurement at that distance. If necessary, a pre-amplifier is used and/or the test is conducted at a closer distance.

All readings are extrapolated back to the equivalent three meter reading using inverse scaling with distance. The spurious emissions more than 20 dB below the permissible value are not reported.

For an intentional radiator, the spectrum shall be investigated from the lowest radio frequency signal generated in the device, without going below 9 kHz, up to at least the frequency shown in the following table:

Frequency range of radiated emission measurements

Lowest frequency generated in the device	Upper frequency range of measurement
9 kHz to below 10 GHz	10th harmonic of highest fundamental frequency or to 40 GHz, whichever is lower
At or above 10 GHz to below 30 GHz	5th harmonic of highest fundamental frequency or to 100 GHz, whichever is lower
At or above 30 GHz	5th harmonic of highest fundamental frequency or to 200 GHz, whichever is lower, unless otherwise specified

Number of fundamental frequencies to be tested in EUT transmit band

Frequency range in which device operates	Number of frequencies	Location in frequency range of operation
1 MHz or less	1	Middle
1 MHz to 10 MHz	2	1 near top and 1 near bottom
More than 10 MHz	3	1 near top, 1 near middle and 1 near bottom

### **3.2 EUT Exercising Software**

No special exercising software

### **3.3 Special Accessories**

No special accessories used.

### **3.4 Measurement Uncertainty**

When determining of the test conclusion, the Measurement Uncertainty of test has been considered.

Uncertainty and Compliance – Unless the standard specifically states that measured values are to be extended by the measurement uncertainty in determining compliance, all compliance determinations are based on the actual measured value.

### **3.5 Equipment Modification**

Any modifications installed previous to testing by Bradley Technologies Canada Inc.. will be incorporated in each production model sold / leased in the United States.

No modifications were installed by Intertek Testing Services Shenzhen Ltd. Guangzhou Branch.

### **3.6 Support Equipment List and Description**

The client make a continuous transmit sample for test. The test sample can be adjusted different frequency channel through the key on the display board.

**4.0 Measurement Results**

**4.1 Antenna Requirement:**

Standard requirement

15.203 requirement:

For intentional device. According to 15.203, an intentional radiator shall be designed to Ensure that no antenna other than that furnished by the responsible party shall be used with the device.

EUT Antenna

The antenna is an integral antenna and no consideration of replacement. The best case gain of the antenna is 2 dBi.

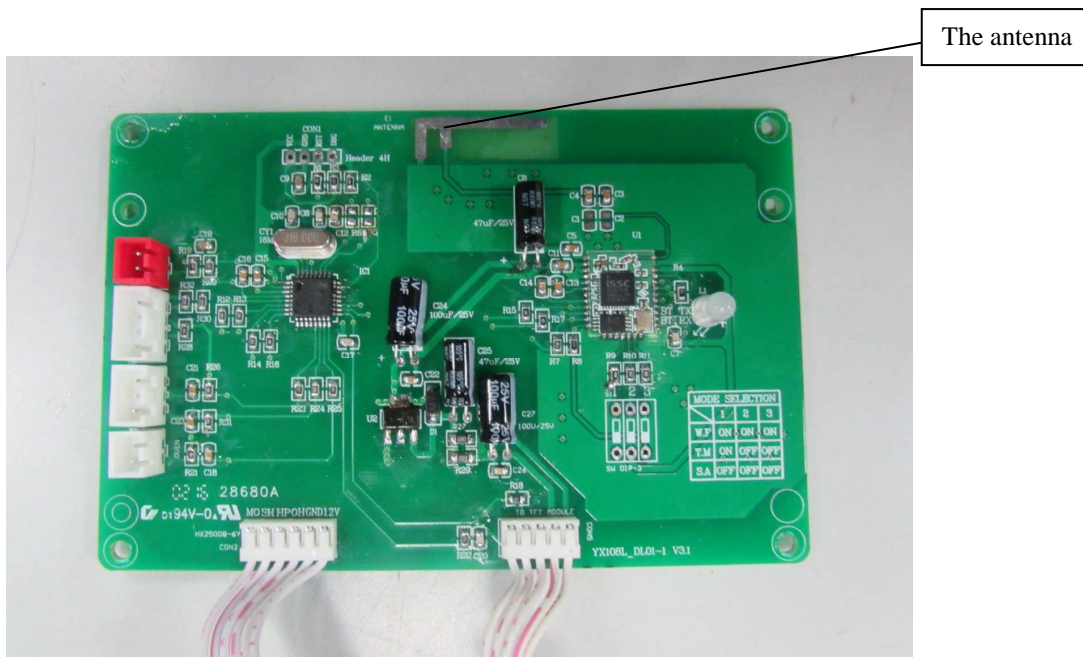



#### 4.2 Occupied Bandwidth:

- Test Requirement:** FCC PART 15 C section 15.215(c)  
(c) Intentional radiators operating under the alternative provisions to the general emission limits, as contained in §§ 15.217 through 15.257 and in subpart E of this part, must be designed to ensure that the 20 dB bandwidth of the emission, or whatever bandwidth may otherwise be specified in the specific rule section under which the equipment operates, is contained within the frequency band designated in the rule section under which the equipment is operated
- Test Method:** ANSI C63.10: Clause 6.9
- Test Status:** Pre-Scan has been conducted to determine the worst-case mode from all possible combinations between available modulations, data rates and antenna ports (if EUT with antenna diversity architecture). The highest, middle and the lowest channels were selected for the final test as listed below.
- Test Configuration:**

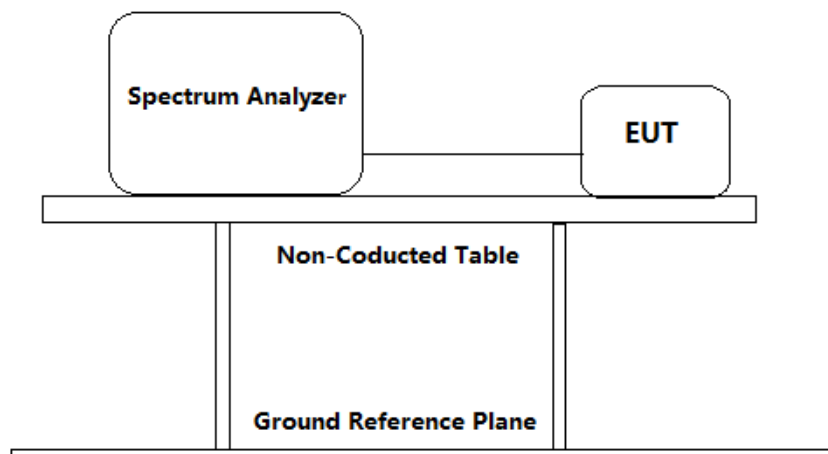

**Test Procedure:**

The transmitter was operated at its maximum carrier power measured under normal test conditions.

- The instrument center frequency was set to the nominal EUT channel center frequency. The frequency span for the spectrum analyzer was between 1.5 times and 5.0 times the OBW(20 dB Bandwidth).
- The nominal IF filter bandwidth (3 dB RBW) was set to 100kHz and VBW was approximately three times the RBW.
- Set the reference level of the instrument as required, keeping the signal from exceeding the

maximum input mixer level for linear operation. In general, the peak of the spectral envelope was more than  $[10 \log (OBW/RBW)]$  below the reference level.

- d) Step a) through step c) might require iteration to adjust within the specified range.
- e) The dynamic range of the instrument at the selected RBW was more than 10 dB below the target “-20 dB down” requirement; that is, if the requirement calls for measuring the -20 dB OBW, the instrument noise floor at the selected RBW was at least 30 dB below the reference value.
- f) Peak detection and max hold mode (until the trace stabilizes) was used.
- g) Used the 20dB bandwidth function of the instrument and reported the measured bandwidth.
- h) The occupied bandwidth was reported by providing plot(s) of the measuring instrument display; the plot axes and the scale units per division was clearly labeled. Tabular data was reported in addition to the plot(s).

**20 dB bandwidth:**

Channel No.	Frequency (MHz)	Measured 20 dB bandwidth (MHz)	Limit MHz	Result
0	2402	1.11	2400 to 2483.5	Pass
19	2440	1.09		Pass
39	2480	1.09		Pass

**20dB bandwidth:**

Result plot as follows:

**Lowest channel (2.402 GHz):**

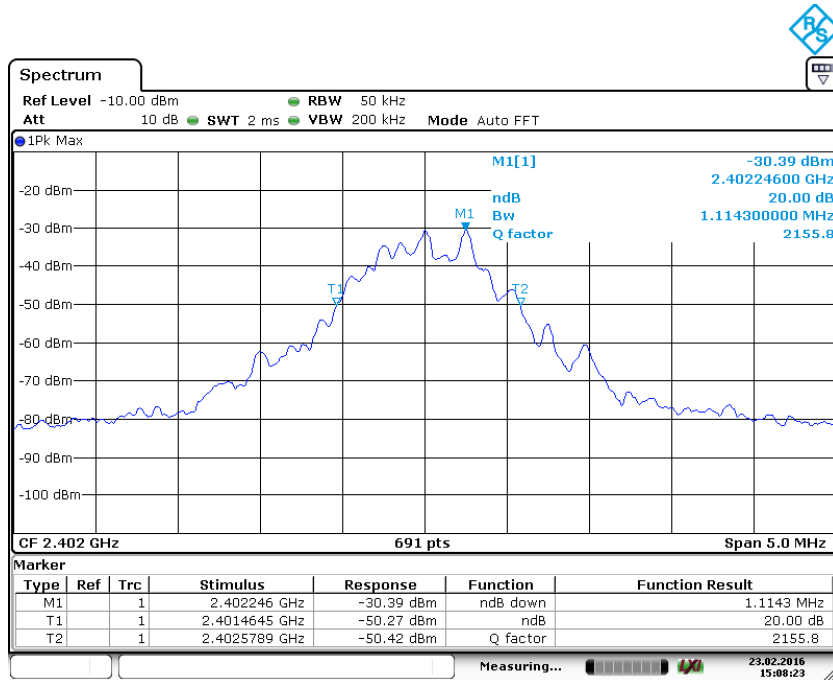

**Middle Channel (2.440 GHz):**



**Highest Channel (2.480 GHz):**



#### 4.7 Radiated Emission

Test Requirement:

FCC PART 15 C section 15.249 (a), (d)

(a) Except as provided in paragraph (b) of this section, the field strength of emissions from intentional radiators operated within these frequency bands shall comply with the following:

Fundamental Frequency (MHz)	Field Strength of Fundamental (dB $\mu$ V/m @ 3m)	Field Strength of Harmonics (dB $\mu$ V/m @ 3m)
902 to 928	94.0	54.0
2400 to 2483.5	94.0	54.0
5725 to 5875	94.0	54.0

**Note:** The limits shown in the above table are based on measurements using an average detector, except for the fundamental emission in the frequency band 902-928 MHz, which is based on measurements using a CISPR quasi-peak detector.

(d) Emissions radiated outside of the specified frequency bands, except for harmonics, shall be attenuated by at least 50 dB below the level of the fundamental or to the general radiated emission limits in § 15.209, whichever is the lesser attenuation.

Test Method:

ANSI C63.10: Clause 6.4, 6.5 and 6.6

Test Status:

Pre-Scan has been conducted to determine the worst-case mode from all possible combinations between available modulations, data rates and antenna ports (if EUT with antenna diversity architecture). The lowest, middle and the lowest channels were selected for the final test as listed below.

Test site:

Measurement Distance: 3m (Semi-Anechoic Chamber)

Limit:

The field strength of radiated emission outside of the specified frequency bands, except for harmonics at a distance of 3 meters shall not exceed the following values:

Frequency (MHz)	Field Strength (dB $\mu$ V/m @ 3m)
30-88	40.0
88-216	43.5
216-960	46.0
Above 960	54.0

Detector:

For Peak and Quasi-Peak value:  
 200 Hz for 9 kHz to 150 kHz  
 9 kHz for 150 kHz to 30 MHz

120 kHz for 30 MHz to 1GHz

RBW = 1 MHz for  $f \geq 1$  GHz

VBW  $\geq$  RBW

Sweep = auto

Detector function = peak for  $f \geq 1$  GHz, QP for  $f < 1$  GHz

Trace = max hold

According 15.35(c), when the field strength (or envelope power) is not constant or it is in pulses, and an average detector is specified to be used, the value of field strength or power shall be determined by averaging over one complete pulse train, including blanking intervals within the pulse train, as long as the pulse train does not exceed 0.1 seconds. In cases where the pulse train exceeds 0.1 second, the average value of field strength or output power shall be determined during a 0.1 second interval during which the field strength or power is at its maximum value.

All measurement for radiated emission within the restricted band were performed using a QP detector with 120kHz RBW, 300kHz VBW below 1GHz and PK detector with 1MHz RBW, 3MHz VBW above 1GHz. average detector with 1MHz RBW, 10Hz VBW above 1GHz

Section 15.205 Restricted bands of operation.

MHz	MHz	MHz	GHz
0.090 - 0.110	16.42 - 16.423	399.9 - 410	4.5 - 5.15
<sup>1</sup> 0.495 - 0.505	16.69475 -	608 - 614	5.35 - 5.46
2.1735 - 2.1905	16.69525	960 - 1240	7.25 - 7.75
4.125 - 4.128	16.80425 -	1300 - 1427	8.025 - 8.5
4.17725 - 4.17775	16.80475	1435 - 1626.5	9.0 - 9.2
4.20725 - 4.20775	25.5 - 25.67	1645.5 - 1646.5	9.3 - 9.5
6.215 - 6.218	37.5 - 38.25	1660 - 1710	10.6 - 12.7
6.26775 - 6.26825	73 - 74.6	1718.8 - 1722.2	13.25 - 13.4
6.31175 - 6.31225	74.8 - 75.2	2200 - 2300	14.47 - 14.5
8.291 - 8.294	108 - 121.94	2310 - 2390	15.35 - 16.2
8.362 - 8.366	123 - 138	2483.5 - 2500	17.7 - 21.4
8.37625 - 8.38675	149.9 - 150.05	2655 - 2900	22.01 - 23.12
8.41425 - 8.41475	156.52475 -	3260 - 3267	23.6 - 24.0
12.29 - 12.293	156.52525	3332 - 3339	31.2 - 31.8
12.51975 -	156.7 - 156.9	3345.8 - 3358	36.43 - 36.5
12.52025	162.0125 - 167.17	3600 - 4400	
12.57675 -	167.72 - 173.2		
12.57725	240 - 285		
13.36 - 13.41	322 - 335.4		

Test Configuration:

- 1) 9 kHz to 30 MHz emissions:

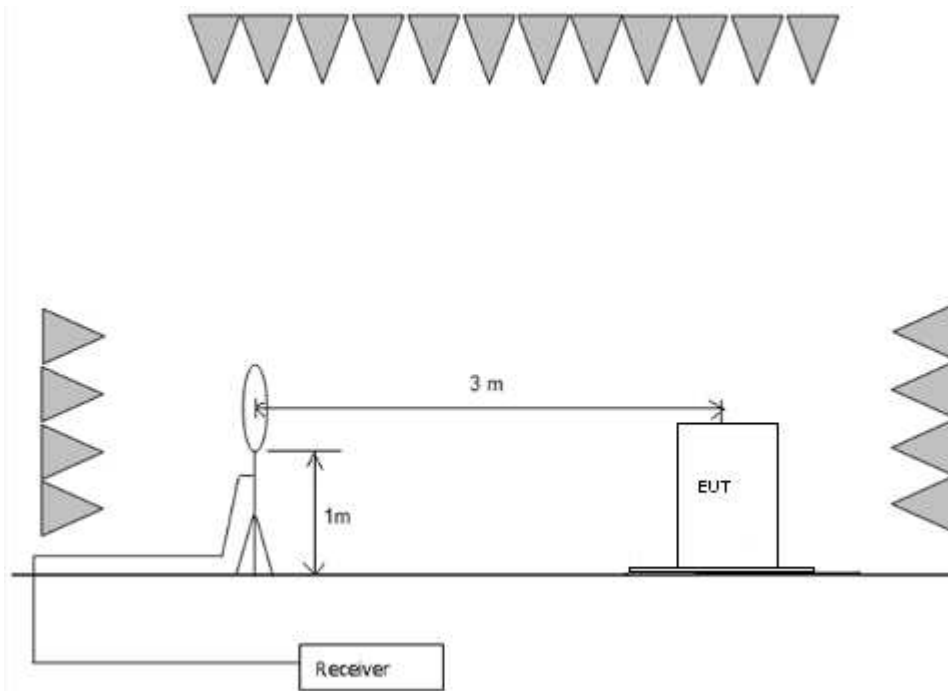

- 2) 30 MHz to 1 GHz emissions:

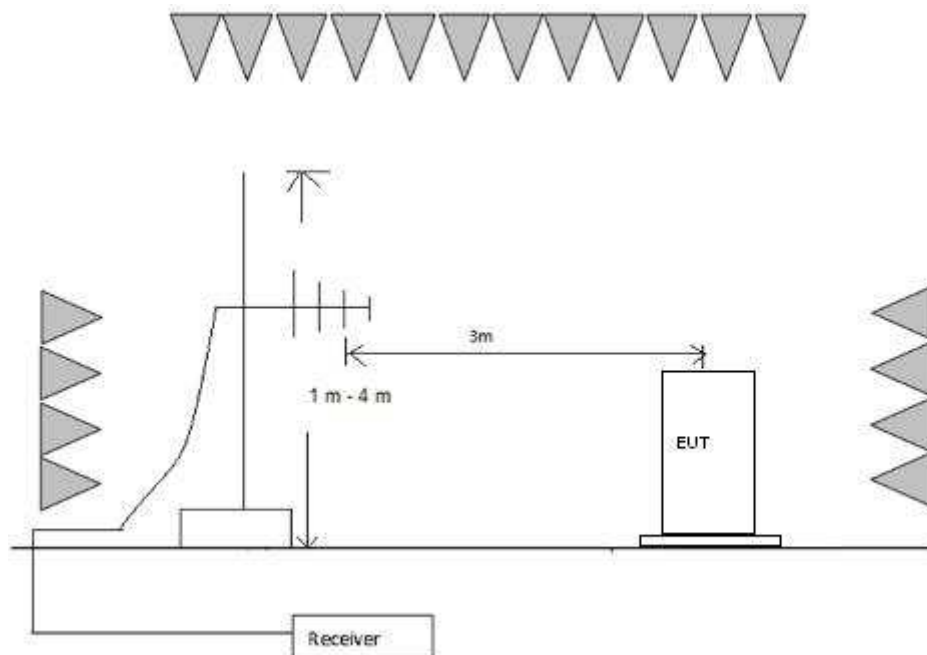



3) 1 GHz to 40 GHz emissions:

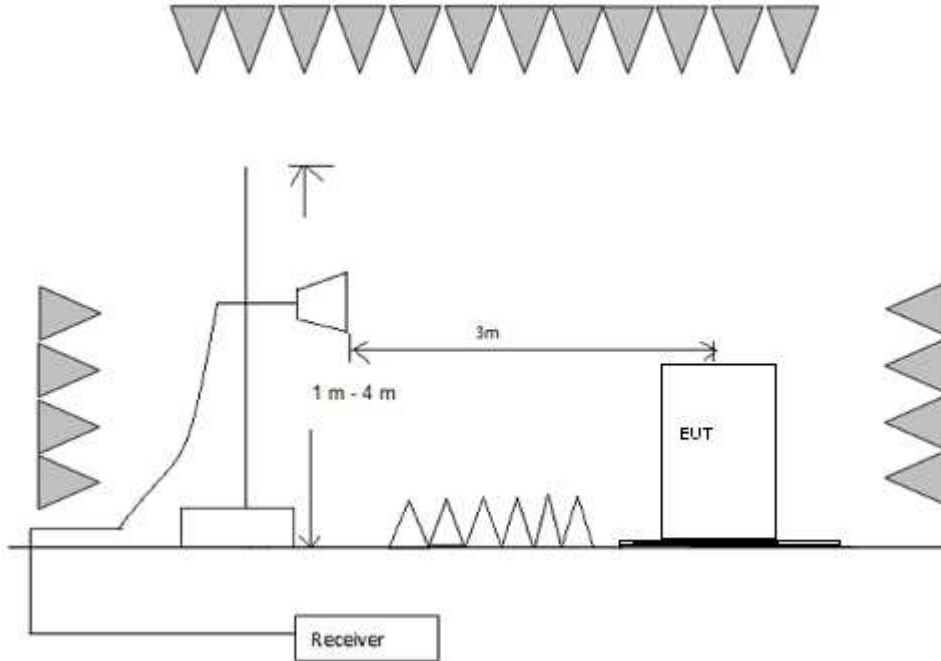

**Test Procedure:**

1) 9 kHz to 30 MHz emissions:

For testing performed with the loop antenna. The centre of the loop was positioned 1 m above the ground and positioned with its plane vertical at the special distance from the EUT. During testing the loop was rotated about its vertical axis for maximum response at each azimuth and also investigated with the loop positioned in the horizontal plane.

2) 30 MHz to 1 GHz emissions:

For testing performed with the bi-log type antenna. The measurement is performed with the EUT rotated 360°, the antenna height scanned between 1m and 4m, and the antenna rotated to repeat the measurement for both the horizontal and vertical antenna polarizations.

3) 1 GHz to 25 GHz emissions:

Test site with RF absorbing material covering the ground plane that met the site validation criterion called out in CISPR 16-1-4:2007 was used to perform radiated emission test above 1 GHz.

For testing performed with the horn antenna. The measurement is performed with the EUT rotated 360°, the antenna height scanned between 1m and 4m, and the antenna rotated to repeat the measurement for both the horizontal and vertical antenna polarizations.

4) The receiver was scanned from 9 kHz to 25 GHz. When an emission was found, the table was rotated to produce the maximum signal strength. An initial pre-scan was performed for in peak detection mode using the receiver. The EUT was measured for both the Horizontal and Vertical polarities and performed a pre-test three orthogonal planes. For intentional radiators, measurements of the variation of the input power or the radiated signal level of the fundamental frequency component of the emission, as appropriate, shall be performed with the supply voltage varied between 85% and 115% of the nominal rated supply voltage. The worst case emissions were reported.

9 kHz~30 MHz Field Strength of Unwanted Emissions. Quasi-Peak Measurement

The measurements with active loop antenna were greater than 20dB below the limit, so the test data were not recorded in the test report.

**Radiated Emissions (Below 1GHz)**

Test curve and data: Operation Frequency: 2402MHz  
 Horizontal

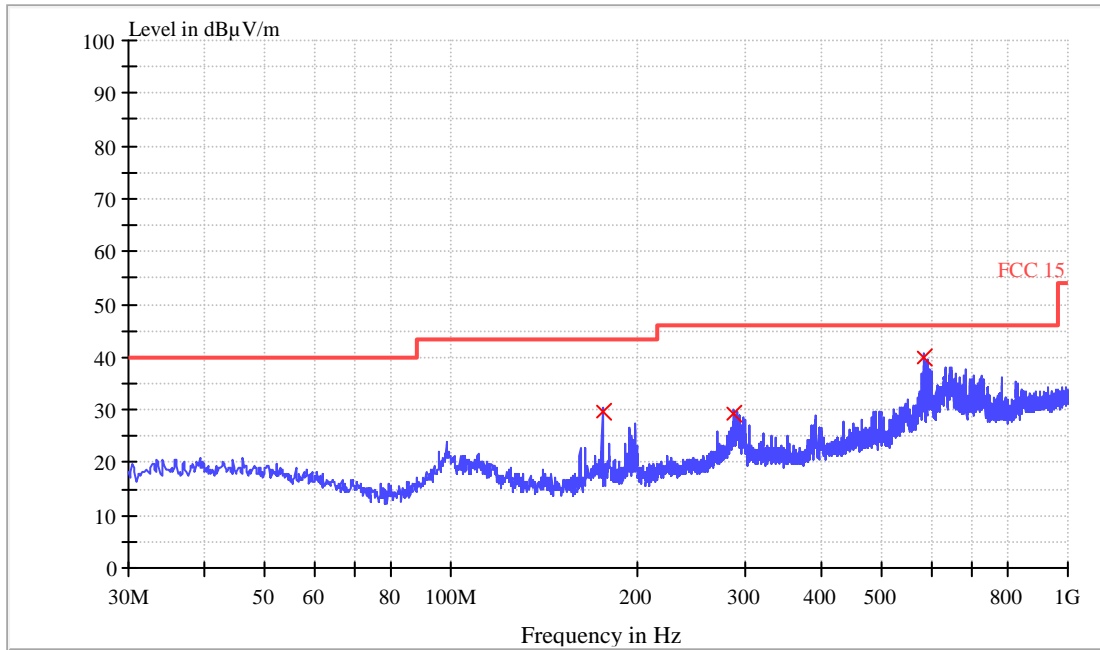

**QP**

Frequency (MHz)	Quasi Peak (dBµV/m)	Bandwidth (kHz)	Pol	Corr. (dB)	Margin - QPK (dB)	Limit - QPK (dBµV/m)
176.000000	29.8	120.000	H	8.6	13.8	43.5
287.920000	29.1	120.000	H	14.7	16.9	46.0
585.560000	40.1	120.000	H	21.1	5.9	46.0

Vertical

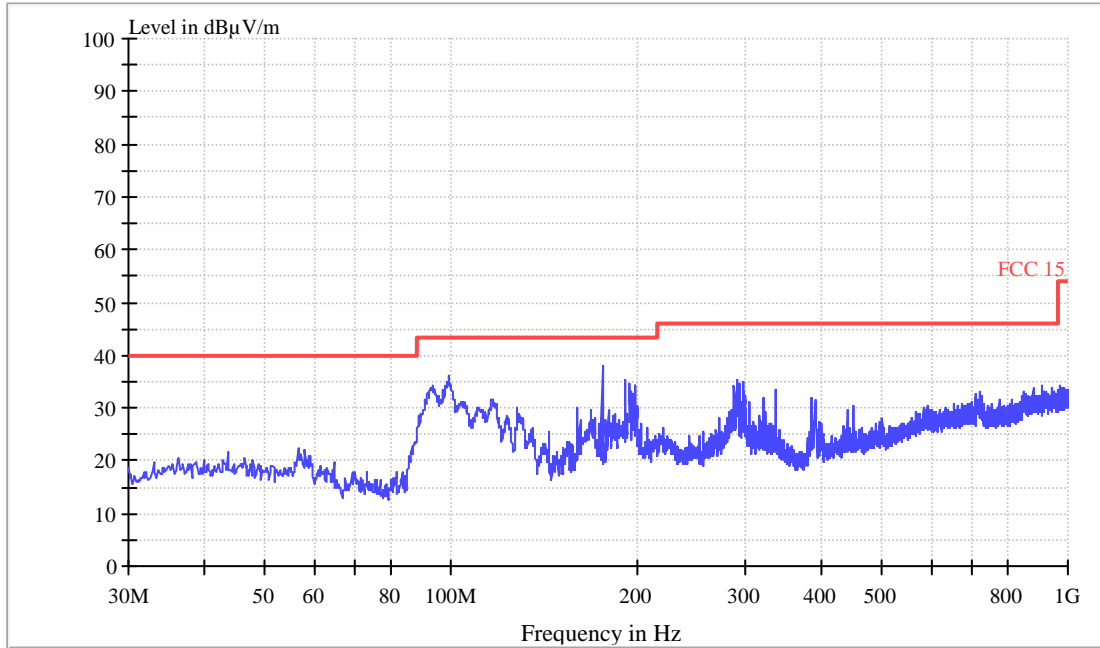

**QP**

Frequency (MHz)	Quasi Peak (dBµV/m)	Bandwidth (kHz)	Pol	Corr. (dB)	Margin - QPK (dB)	Limit - QPK (dBµV/m)
92.040000	29.9	120.000	V	10.9	13.6	43.5
175.960000	33.4	120.000	V	8.6	10.1	43.5
194.880000	31.2	120.000	V	9.5	12.3	43.5

Test curve and data: Operation Frequency: 2440MHz  
 Horizontal

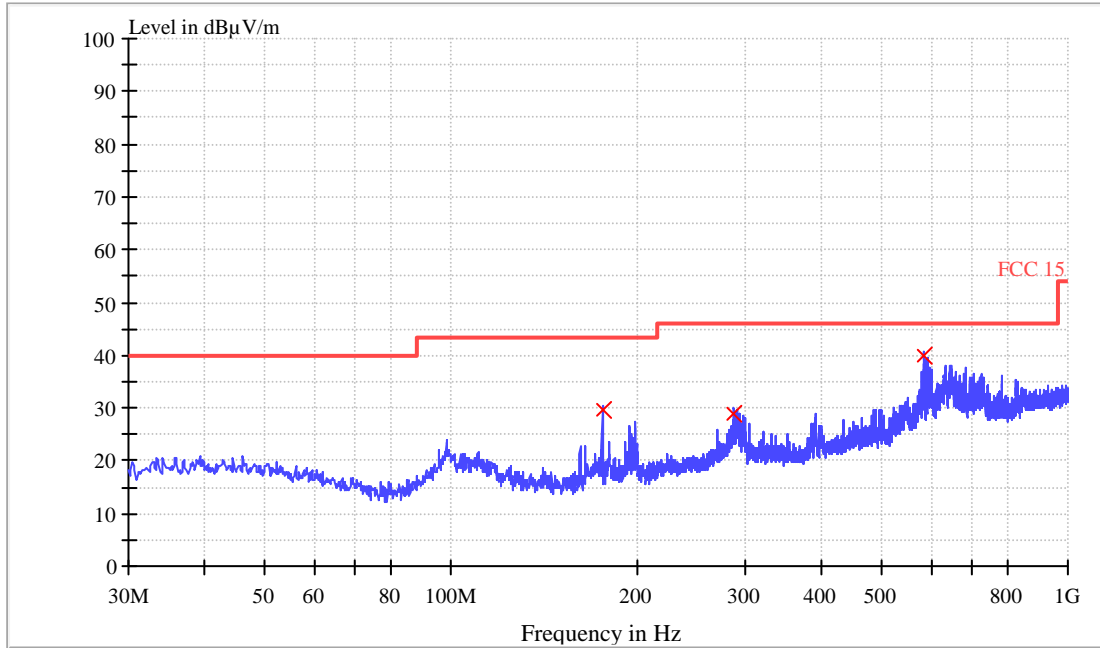

**QP**

Frequency (MHz)	Quasi Peak (dBµV/m)	Bandwidth (kHz)	Pol	Corr. (dB)	Margin - QPK (dB)	Limit - QPK (dBµV/m)
176.000000	29.6	120.000	H	8.6	14.0	43.5
287.920000	29.0	120.000	H	14.7	17.0	46.0
585.560000	40.1	120.000	H	21.1	5.9	46.0

Vertical

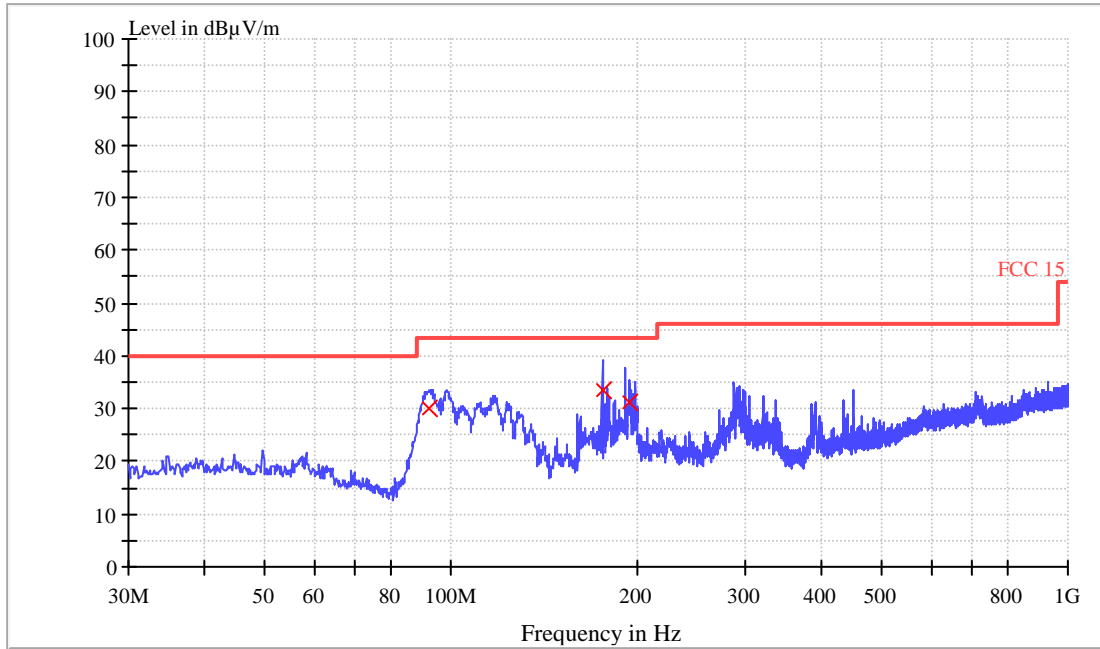

**QP**

Frequency (MHz)	Quasi Peak (dBµV/m)	Bandwidth (kHz)	Pol	Corr. (dB)	Margin - QPK (dB)	Limit - QPK (dBµV/m)
92.040000	29.9	120.000	V	10.9	13.6	43.5
175.960000	33.4	120.000	V	8.6	10.1	43.5
194.880000	31.2	120.000	V	9.5	12.3	43.5

Test curve and data: Operation Frequency: 2480MHz  
 Horizontal

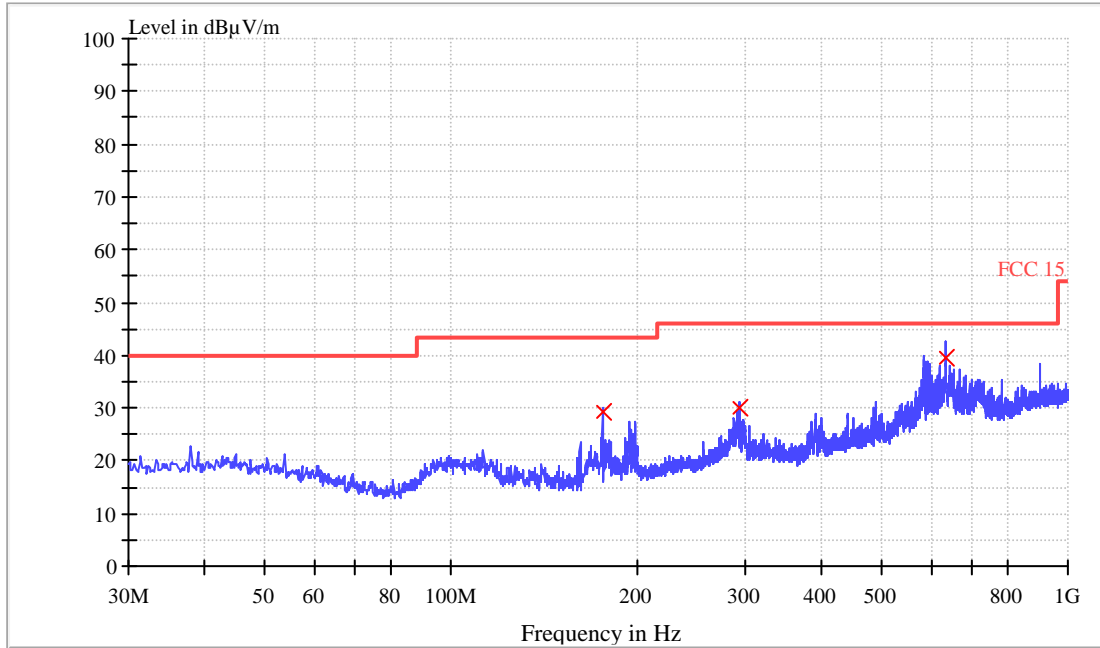

### QP

Frequency (MHz)	Quasi Peak (dBµV/m)	Bandwidth (kHz)	Pol	Corr. (dB)	Margin - QPK (dB)	Limit - QPK (dBµV/m)
175.960000	29.2	120.000	H	8.6	14.3	43.5
292.480000	30.2	120.000	H	15.0	15.8	46.0
634.800000	39.4	120.000	H	21.7	6.6	46.0

Vertical

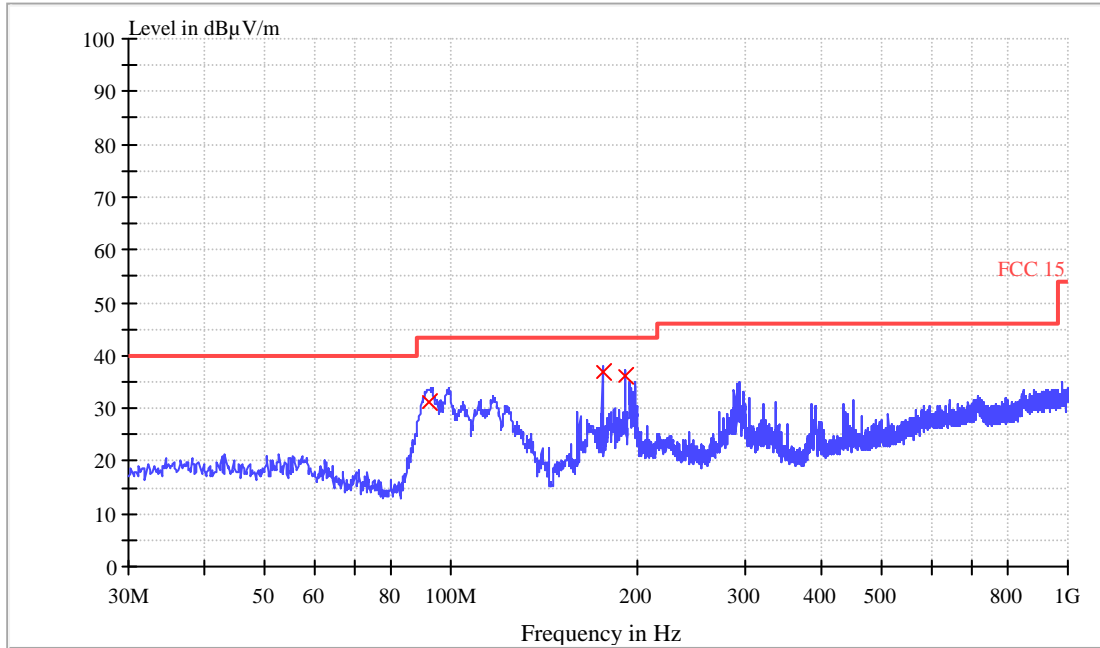

**QP**

Frequency (MHz)	Quasi Peak (dBµV/m)	Bandwidth (kHz)	Pol	Corr. (dB)	Margin - QPK (dB)	Limit - QPK (dBµV/m)
92.320000	31.1	120.000	V	11.0	12.4	43.5
175.960000	37.0	120.000	V	8.6	6.5	43.5
191.960000	36.3	120.000	V	9.3	7.2	43.5





Report No.: 160302035GZU-001  
 Issued: 2016-3-30

**Radiated Emissions (Above 1GHz)**

Operation Frequency: 2402MHz:

Polarization	Frequency (MHz)	PK Net at 3m (dBµV/m)	AV Net at 3m (dBµV/m)	Correction Factor (dB)	PK Limit at 3m (dBµV/m)	PK Margin (dB)	AV Limit at 3m (dBµV/m)	AV Margin (dB)
Horizontal	2402.500	84.8	80.2	-12.8	114.0	-29.2	94.0	-13.8
Horizontal	4804.200	51.9	--	-8.8	--	--	54.0	-2.1
Horizontal	7206.100	36.4	--	-6.2	--	--	54.0	-17.6
Horizontal	10030.700	36.3	--	-4.7	--	--	54.0	-17.7
Vertical	2402.500	88.6	80.1	-12.8	114.0	-25.4	94.0	-13.9
Vertical	4804.300	59.6	49.2	-8.8	74.0	-14.4	54.0	-4.8
Vertical	7206.100	43.1	--	-6.2	--	--	54.0	-10.9
Vertical	10030.7	32.3	--	-4.7	--	--	54.0	-21.7

Operation Frequency: 2440MHz:

Polarization	Frequency (MHz)	PK Net at 3m (dBµV/m)	AV Net at 3m (dBµV/m)	Correction Factor (dB)	PK Limit at 3m (dBµV/m)	PK Margin (dB)	AV Limit at 3m (dBµV/m)	AV Margin (dB)
Horizontal	2440.400	86.3	80.6	-12.8	114.0	-27.7	94.0	-13.4
Horizontal	4880.300	53.1	--	-8.8	--	--	54.0	-0.9
Horizontal	7320.200	36.2	--	-6.2	--	--	54.0	-17.8
Horizontal	9760.800	34.4	--	-4.7	--	--	54.0	-19.6
Vertical	2439.700	86.7	80.1	-12.8	114.0	-27.3	94.0	-13.9
Vertical	4880.250	54.2	45.6	-8.8	74.0	-19.8	54.0	-8.4
Vertical	7320.300	40.1	--	-6.2	--	--	54.0	-13.9
Vertical	9760.8	36.5	--	-4.7	--	--	54.0	-17.5

Operation Frequency: 2480MHz:

Polarization	Frequency (MHz)	PK Net at 3m (dBµV/m)	AV Net at 3m (dBµV/m)	Correction Factor (dB)	PK Limit at 3m (dBµV/m)	PK Margin (dB)	AV Limit at 3m (dBµV/m)	AV Margin (dB)
Horizontal	2480.100	84.9	80.6	-12.8	114.0	-29.1	94.0	-13.4
Horizontal	4959.900	54.3	46.0	-8.8	74.0	-19.7	54.0	-8.0
Horizontal	7440.300	37.7	--	-6.2	--	--	54.0	-16.3
Horizontal	10246.400	36.9	--	-4.7	--	--	54.0	-17.1
Vertical	2480.400	89.1	80.1	-12.8	114.0	-24.9	94.0	-13.9
Vertical	4960.400	59.4	48.1	-8.8	74.0	-14.6	54.0	-5.9
Vertical	7440.300	42.9	--	-6.2	--	--	54.0	-11.1
Vertical	10231.6	33.4	--	-4.7	--	--	54.0	-20.6

- Notes:
1. AT frequencies equal to or less than 1000MHz, quasi-peak detector was used, above 1000MHz, Peak detector and AV detector were used.
  2. All measurements were made at 3 meter.
  3. Negative value in the margin column shows emission below limit.
  4. Horn antenna is used for the emission over 1000MHz.
  5. When Peak emission level was below AV limit, the AV emission level did not be recorded.

#### 4.8 Band Edges Requirement

Test Requirement: FCC PART 15 C section 15.249 (d)

(d) Emissions radiated outside of the specified frequency bands, except for harmonics, shall be attenuated by at least 50 dB below the level of the fundamental or to the general radiated emission limits in § 15.209, whichever is the lesser attenuation.

Frequency Band: 2400 MHz to 2483.5 MHz

Test Method: ANSI C63.10: Clause 6.10

Test Status: Pre-Scan has been conducted to determine the worst-case mode from all possible combinations between available modulations, data rates and antenna ports (if EUT with antenna diversity architecture). The lowest, middle and the highest channels were selected for the final test as listed below.

Test Configuration:

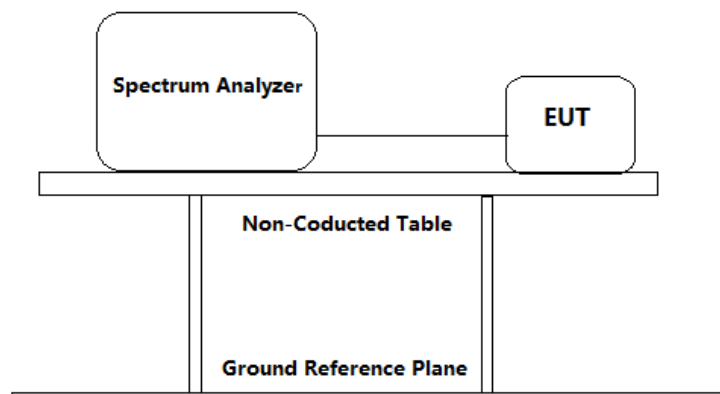

Test result with plots as follows:

Result plot as follows:

Channel 0: 2.402 GHz

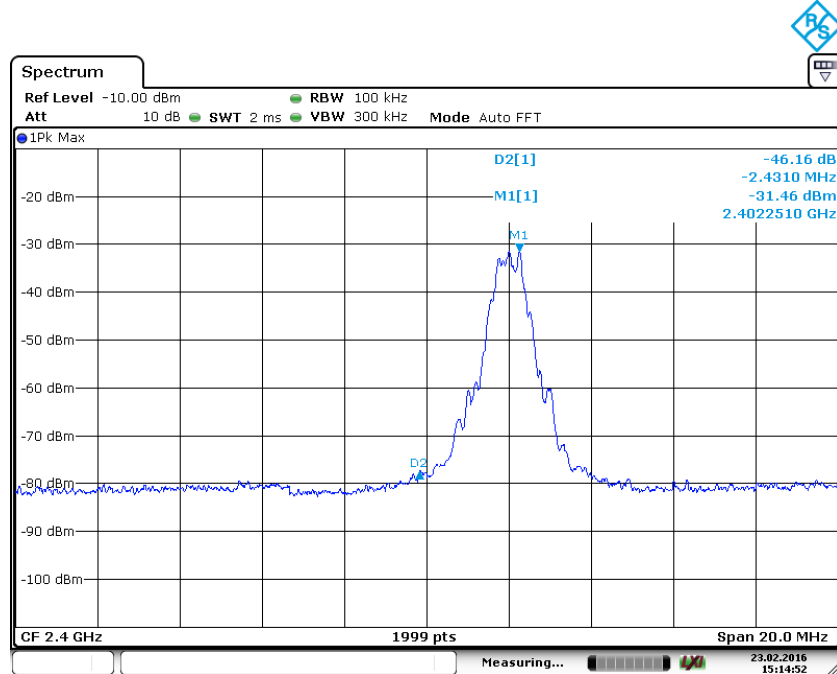

Channel 39: 2.480 GHz

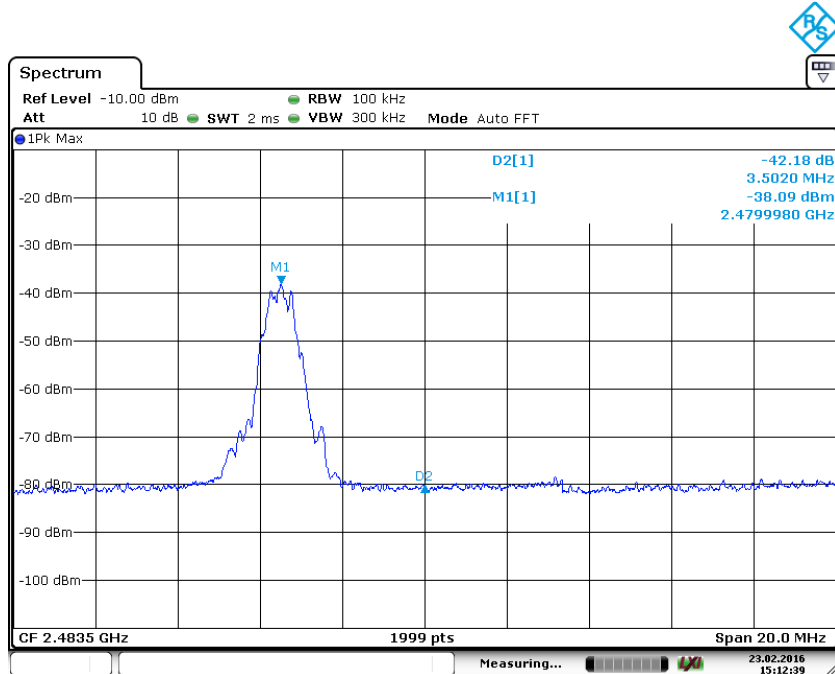

### Peak Measurement

Band-edge compliance is determined by applying marker-delta method, i.e (Band-edge Plot).

(i) Lower band-edge:

Peak Resultant field strength

=Fundamental emissions (Peak value) – delta from the band-edge plot

= 88.6dB $\mu$ v/m – 46.2dB

= 42.4dB $\mu$ v/m

(ii) Upper band-edge:

Peak Resultant field strength

=Fundamental emissions (Peak value) – delta from the band-edge plot

= 89.1dB $\mu$ v/m – 42.2dB

= 46.9dB $\mu$ v/m

The Peak resultant field strength meets the general radiated emission AV limit 54dB $\mu$ v/m, so it complies with the requirement.

**4.9 Conducted Emissions at Mains Terminals**

Test Configuration:

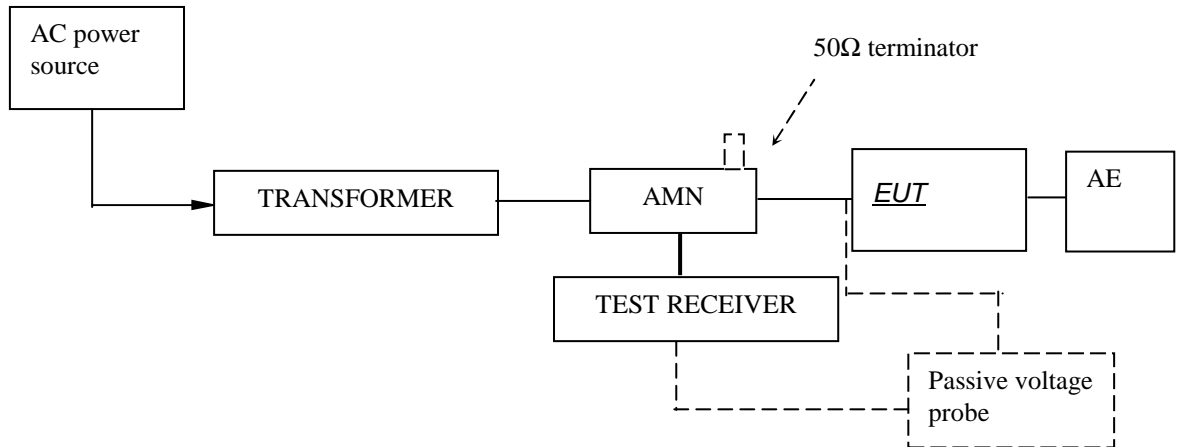

**Test Setup and Procedure**

Test was performed according to ANSI C63.10 Clause 6.2. The EUT was set to achieve the maximum emission level. The mains terminal disturbance voltage was measured with the EUT in a shielded room. The EUT was connected to AC power source through an Artificial Mains Network which provides a 50Ω linear impedance. Artificial hand is used if appropriate (for handheld apparatus). The load/control terminal disturbance voltage was measured with passive voltage probe if appropriate.

The table-top EUT was placed on a 0.8m high non-metallic table above earthed ground plane (Ground Reference Plane). And for floor standing EUT, was placed on a 10mm high non-metallic supported on GRP. The EUT keeps a distance of at least 0.8m from any other of the metallic surface. The Artificial Mains Network is situated at a distance of 0.8m from the EUT.

During the test, mains lead of EUT excess 0.8m was folded back and forth parallel to the lead so as to form a horizontal bundle with a length between 0.3m and 0.4m.

The bandwidth of test receiver was set at 9 kHz. The frequency range from 150 kHz to 30MHz was checked.

Pre-test in the three channels: 2402MHz, 2440MHz and 2480MHz and found the conducted emission on 2440MHz was the worst case, so below test data was for 2440MHz.

Test Data

At main terminal: Pass

Tested Wire: Live

Operation Mode: Operate at 2440MHz Continues transmit

EDIT PEAK LIST (Final Measurement Results)				
Trace1:	FCC15QP			
Trace2:	FCC15AV			
Trace3:	---			
TRACE	FREQUENCY	LEVEL dBµV	DELTA LIMIT dB	
1 Quasi Peak	154 kHz	54.93 L1	-10.85	
2 Average	342 kHz	32.89 L1	-16.26	
1 Quasi Peak	366 kHz	31.22 L1	-27.37	
2 Average	382 kHz	25.67 L1	-22.55	

Tested Wire: Neutral

Operation Mode: Operate at 2440MHz Continues transmit

EDIT PEAK LIST (Final Measurement Results)				
Trace1:	FCC15QP			
Trace2:	FCC15AV			
Trace3:	---			
TRACE	FREQUENCY	LEVEL dBµV	DELTA LIMIT dB	
1 Quasi Peak	154 kHz	54.83 L1	-10.94	
2 Average	362 kHz	29.65 L1	-19.02	
1 Quasi Peak	366 kHz	30.62 L1	-27.96	
2 Average	418 kHz	23.78 L1	-23.70	
2 Average	4.162 MHz	21.30 L1	-24.69	

Emission Curve  
Tested Wire: Live

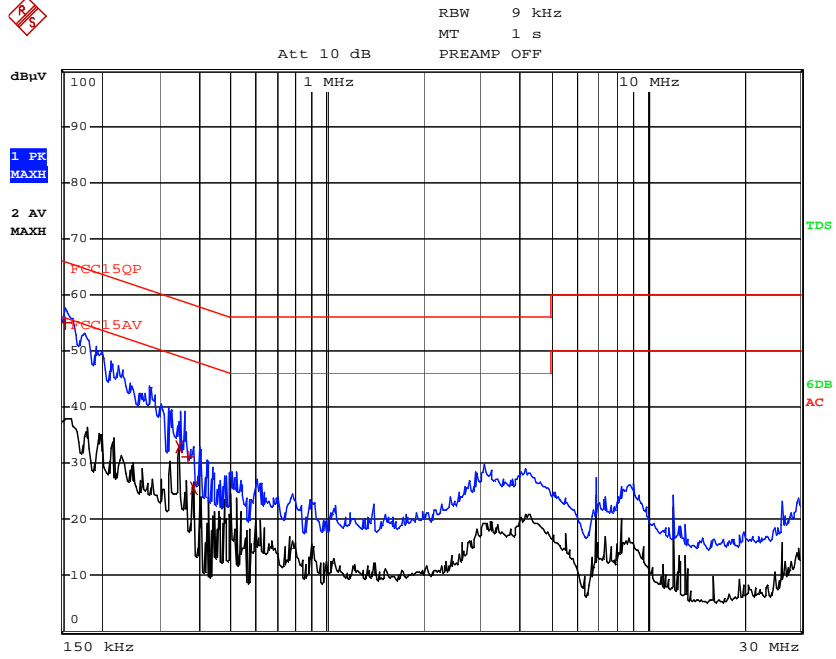

Tested Wire: Neutral

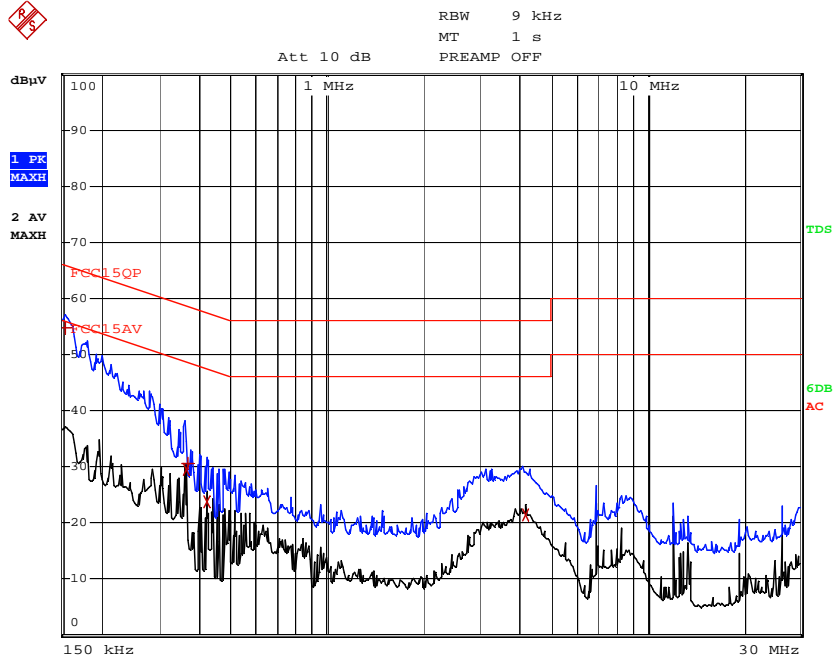



Report No.: 160302035GZU-001  
 Issued: 2016-3-30

## 10.0 Test Equipment List

### Radiated Emission

Equipment No.	Equipment	Model	Manufacturer	Cal. date (YYYY-MM-DD)	Calibration Interval
EM030-01	3m Semi-Anechoic Chamber	9×6×6 m <sup>3</sup>	ETS•LINDGREN	2015-04-02	1Y
EM030-02	Control room for 3m Semi-Anechoic Chamber	4×4×3 m <sup>3</sup>	ETS•LINDGREN		
EM031-02	EMI Test Receiver (9 kHz~7 GHz)	R&S ESR7	R&S	2015-06-03	1Y
EM031-03	Signal and Spectrum Analyzer (10 Hz~40 GHz)	R&S FSV40	R&S	2015-06-03	1Y
EM011-04	Loop antenna (9 kHz-30 MHz)	HFH2-Z2	R&S	2015-05-25	1Y
EM061-03	TRILOG Super Broadband test Antenna (30 MHz-1.5 GHz)	VULB 9161	SCHWARZBECK	2015-05-25	1Y
EM033-02	Bouble-Ridged Waveguide Horn Antenna (800 MHz-18 GHz)	R&S HF907	R&S	2015-05-25	1Y
EM033-03	High Frequency Antenna & preamplifier (18 GHz~26.5 GHz)	R&S SCU- 26	R&S	2015-05-25	1Y
EM033-04	High Frequency Antenna & preamplifier (26 GHz-40 GHz)	R&S SCU- 40	R&S	2015-05-25	1Y
EM031-02-01	Coaxial cable(9 kHz-1 GHz)	/	R&S	2015-06-03	1Y
EM033-02-02	Coaxial cable(1 GHz-18 GHz)	/	R&S	2015-06-09	
EM033-04-02	Coaxial cable (18~40) GHz	/	R&S	2015-06-09	
EM022-03	2.45 GHz Filter	BRM 50702	Micro-Tronics	2015-05-06	1Y

### Conducted emission at the mains terminals test

Equipment No.	Equipment	Model	Manufacturer	Cal.Due date (YYYY-MM-DD)	Calibration Interval
EM080-05	EMI receiver	ESCI	R&S	2015-08-04	1Y
EM006-05	LISN	ENV216	R&S	2015-09-12	1Y
EM006-06	LISN	ENV216	R&S	2015-09-12	1Y
EM006-06-01	Coaxial cable	/	R&S	2015-04-12	1Y
EM004-04	EMC shield Room	8m×3m×3m	Zhongyu	2015-08-04	1Y