



Dual Band

Digital Two-Way Radio

Dual Band

Digital Two-Way Radio

RS-569D
Instruction Manual

To the users:

Thanks for purchasing our digital two-way radio. We believe it will provide great convenience to your work and life. With novel design and stable performance, use of advanced technology and exquisite craft, you will experience professional and humanized design from our product. We believe that you will be satisfied with the quality and functions, and provide you with convenient, quick, safe and reliable digital voice communication.

This product conforms to the DMR digital protocol ETSI-TS102361-1. - 2. - 3. The AMBE++ vocoder is adopted, which has the characteristics such as straight-through dual-slot and password protection.

Please read the manual carefully before using the product, for better experience functionality and performance of this radio.

PRECAUTIONS

- Do not operate it in flammable, explosive or other transceiver-forbidden places such as petrol station, gas station, hospital, airport and so on.
- Do not expose it to direct sunlight for a long time; do not place it near any heating devices.
- Do not put it in extremely dusty, moist or splash place; do not place it on unstable surface.
- If it emits smoke or strange odours, remove the battery from the product immediately and contact us or the local dealer.
- Do not transmit without antenna installed.
- Refer service to the well-trained professional technicians only.

MENU

Unpacking and Checking Equipment	1
Supplied Accessories	1
Preparation Work	2
Charging the Battery	2
Install/Remove Battery Pack.....	2
Install Antenna	3
Install Belt Clip	4
Install External Loudspeaker/Microphone	4
Getting Acquainted	5
External View	5
Programmable Key	7
LCD Screen	8
Text Input	9
Basic Operation	11
Power ON/OFF.....	10
Volume Adjustment.....	10
Zone Selection	10
Channel Selection.....	10
PTT Transmitting.....	10
Receiving	12
Switch Between Primary And Secondary Channels	12
Switch of Dual Standby Mode	13
Switch Between Frequency Mode And Channel Mode.....	13
Menu Operation	14
Menu Operation	13
Menu Details	13
Digital Mode Menu	18
Analog Mode Menu	30

Functions and Operations	32
Emergency Alarm.....	32
DTMF Call	22
Main Technical Specifications	33
Common Troubleshooting	35

Main Function Features:

- Digital/Analog Modes
- Chinese/English Menu Display, Large Color Screen
- Multi-call Modes: Individual Call, Group Call, All Call
- Remote Kill and Active Function
- Message Function: Edit, Send and Receive
- Emergency Alarm Function: Local and Remote Alarm
- Scan Function: Carrier Scan, Time Scan, Search Scan, etc.
- Call Digital Encryption Function
- Straight-through dual-slot
- Call Recording and Playback
- U/V Dual Band Dual Standby

Unpacking and Checking Equipment

Supplied Accessories

Please carefully unpack the product and check the radio unit inside the box and accessories listed in the following table. If any items are missing or have been damaged during shipment, please contact the dealer immediately.

Accessories	Quantity
Antenna	1
AC Adaptor	1
Desktop Charger	1
Battery	1
Belt Clip	1
Instruction Manual	1

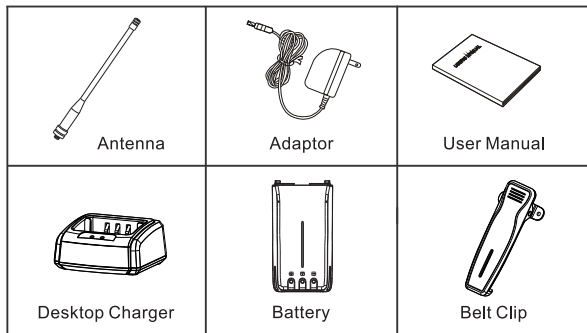

Preparation Work

Charging the Battery

1. Take out the supplied desktop charger and AC adaptor for the transceiver, well connect AC adaptor cable and desktop charger, connect adaptor to AC power, light up charger orange light for 2 seconds then out.
2. Insert battery pack or transceiver with battery pack into battery groove, make sure well connected and stable, charger red light on or flashing, start charging.
3. Green light on when full charging.

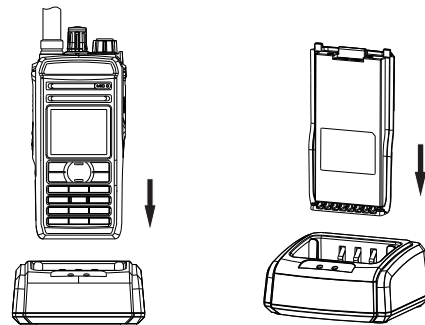

※ **Attention:** It is suggested to power off the transceiver before charging, or else battery status can't be well judged by charger.

Install/Remove Battery Pack

1. Lay battery pack in the battery groove, press battery bottom and push forward until hearing clicked sound to fix the battery pack well.
2. Press "PUSH" clip on top and lightly pull downward to remove battery pack and separate the battery pack from the transceiver.

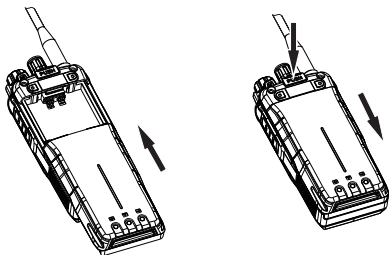

※ Notice:

1. Never short circuit battery terminal and throw battery in fire.
2. Never try to remove shell and install battery in dangerous environment, electric spark will cause explosion.

■ Install Antenna

◆ Install Antenna

Insert supplied antenna into antenna base, tighten antenna by rotating in clockwise direction until consistent with the base.

◆ Remove Antenna

Rotate in anti-clockwise direction to remove antenna.

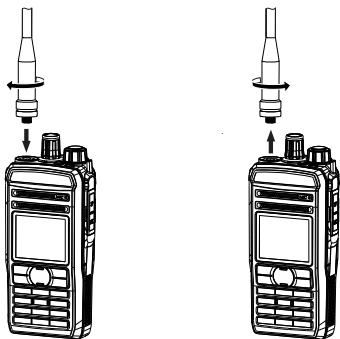

■ Install Belt Clip

To install, remove the battery pack first and aim belt clip at two screw holes on the transceiver, then screw on by screwdriver. Unscrew to remove belt clip.

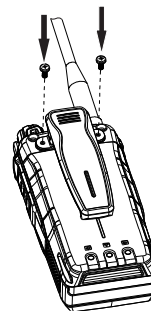

■ Install External Loudspeaker/Microphone

Open rubber plug and insert loudspeaker/microphone into jack.

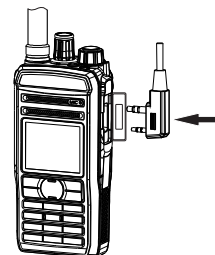

Getting Acquainted

External View

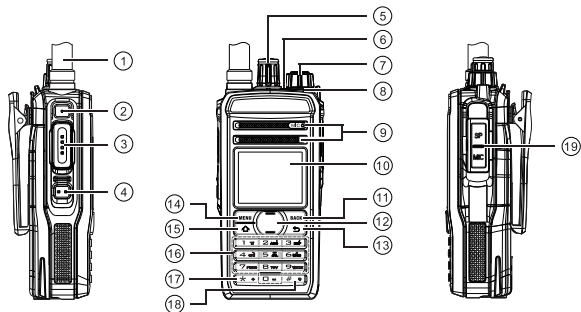

① **Antenna**

② **[PF1] Side Key**

Programmable key can be set as different functions by PC programming software, check details in chapter of "Programmable Key".

③ **[PTT] Key**

Press to transmit signal, release to switch to standby status.

④ **[PF2] Side Key**

Programmable key can be set as different functions by PC programming software, check details in chapter of "Programmable Key".

⑤ **Encoding Knob**

Rotate to select channels, the number of channels can be set, up to 16 channels for each zone, and up to 250 zones.

⑥ **[TK]Alarm Key (Top Key)**

Short press to activate alarm mode, long press to switch off alarm mode.

⑦ **Power/Volume Control Knob**

For power on/off the transceiver and adjust the volume.

⑧ **Status Indicator Light**

Red light on while transmitting, green light on while receiving.

⑨ **Loudspeaker/Microphone**

⑩ **LCD Screen**

⑪ **Back/Delete Key**

- Press this key to return to previous menu item while in menu mode.
- Press this key to delete the input number or text in message edit, ID number input mode.
- Press and hold this key to switch between channel mode and frequency mode on the main interface.

⑫ **[↔]Up/Down Key**

Up/left and down/right selection for menu items in menu mode.

⑬ **[↵]Return Key**

Press this key to return normal mode.

⑭ **[MENU]Menu Key**

Press this key to enter menu mode while in regular mode, and press this key to confirm the selection after entering the menu.

⑮ **[↑]Main Channel Switch Key**

Press this key to switch the main channel up and down in regular mode, the solid arrow points to the primary channel and the other is the secondary channel.

⑯ **[0-9]Numeric Keypad:Default: Number 0~9.**

- Represents DTMF[0~9] number in DTMF function mode.
- Select punctuation marks or letters and 0 is a space in pinyin input mode.
- Long press this key to switch to the corresponding contact if you set the numeric shortcut function.

⑰ **[*]Key**

- Press this key to clear the data in the edit box of message, number, etc.
- Indicate DTMF[*] number while pressing and holding [PTT] key to send DTMF function in main interface analog mode.
- On the main interface, long press [*] to lock the keypad, press [MENU] and then press [*] within 1 second to unlock the keypad.

18 [#]Key

- Short press this key to enter the number manual dialing interface in main interface digital mode.
- Indicate DTMF[#] number while pressing and holding [PTT] key to send DTMF function in main interface analog mode.
- Short press [#] key to pop up the DTMF dialing box in main interface analog mode, then you can manually enter the DTMF number. After input, press [PTT] key to start DTMF dialing.
- Short press [#] key to switch the input method mode in the interface of message input method.

19 Loudspeaker/Microphone Socket

For external loudspeaker/microphone.

Programmable Key

For users operating the transceiver according to own operation habit, the [PF1]/[PF2] Side Key and [TK] Alarm Key (Top Key) can be set as function shortcut keys by PC programming software.

Instructions: Short Press---- Press and release quickly

Long press ---- Press and hold for a set amount of time (0.25 seconds to 3.75 seconds) that can be programmed with PC software.











Programming software can be used to define the long press and short press functions of Top Key \ Side Key 1 \ Side Key 2. The following functions can be defined and programmed.

1. **None:** No any functions.
2. **All Tone ON/OFF:** Turn on/off all tones.
3. **Turn on Emergency Mode :** Turn on emergency mode and enable the emergency call initiated by the user.
4. **Turn off Emergency Mode:** Turn off emergency mode and end the emergency call initiated by the user.
5. **High/Low Power Selection:** Switch between high and low transmitting power levels.
6. **Monitor:** Monitor any activity on the selected channel.
7. **Nuisance Delete:** The users can temporarily delete unwanted channels from the scan list.

- 8~13. **One Touch Access 1~6:** One touch access function, can be set as digital group call \ digital individual call \ Call prompt and send quick message (this is only available after digital function is enabled on the transceiver).
14. **Repeater/Talkaround:** Switch between using the repeater communication mode and communicating directly with other transceivers.
15. **Scan On/Off:** Turn on/off scan. Hint: Scanning doesn't work in Dual-Band, Dual-Watch.
16. **Tight/Normal Squelch:** Switch between tight squelch and normal squelch.
17. **Encryption On/Off:** Turn on/ off encryption function.
18. **VOX On/Off:** Turn on/ off VOX function.
19. **Zone Select:** Select and switch different zones.
20. **Battery Indicator:** Check the remaining battery power.
21. **Lone Work On/Off:** Turn on/ off lone work function.
22. **Phone Exit:** End a phone call (in digital mode only).

LCD Screen

Icon	Description
	Signal strength indication, more scroll bar with stronger signal.
	Display when the current channel is of high power.
	Display when the current channel is of low power.
	Digital mode, non-straight dual slot.
	Digital mode, straight dual slot on and working in slot 1.
	Digital mode, straight dual slot on and working in slot 2.
	Analog mode, no CTCSS/DCS setting.
	Analog mode, setting CTCSS.
	Analog mode, setting DCS.
	Turn on Speaker for effective receiving.
	In frequency mode, it represents transmitting frequency = receiving frequency + frequency offset
	In frequency mode, it represents transmitting frequency = receiving frequency - frequency offset

Icon	Description
	Display when the talkaround function is On in the inter frequency or frequency offset mode.
	VOX function On.
	Normal scan.
	Priority Channel 1 scan.
	Priority Channel 2 scan, there are 2 priority channels at this period.
	Monitor mode.
	Work on narrow band in analog mode.
	There are unread message currently in digital mode.
	Keypad lock.
	Display the remaining battery power. When the battery power is about to run out, the icon  displays to indicate that the battery is out of power and needs to be charged. At the same time, the transceiver makes low-voltage tone regularly.
01	Display the current channel number in channel mode, range: 01~1024.
401.12500MHz	Display frequency.
信道 8	Display channel number or channel name.

Text Input

Various text input methods selectable for different functions use, such as message editing and so on.

Input Methods Switching

Enter text input interface (such as message editing), press [#] to switch input methods, corresponding input method displayed on upper right corner of the screen, Pinyin(py)、English lowercase(abc)、English uppercase(ABC)、Number(123).

Pinyin Input

Press corresponding key with letters shown according to the required Chinese characters Pinyin order, input letters or monogram will be displayed in Pinyin display area, press [] key to select monogram and [MENU] key to confirm, and then use [] key to select required Chinese characters, and press [MENU] key to confirm, the character will be displayed at the cursor in the input field.

English Input

It consists of two types of lowercase (abc) input and uppercase (ABC) input in English input. When input English, it needs to press a key several times for many letters, you can quickly select the letter you want during the cursor shadow flicker.

Number Input

Press the number key to enter the required number directly in number input mode.

Input Key Description

- **[0] Key:** Number [0] and space bar. Used as Number "0" in number input status, and used as space bar in non-number input status.
- **[1] Key:** Number [1] and symbol key. Used as Number "1" in number input status, and used as symbol key in pinyin input and English input status.
- **[2]- [9] Key:** Input number, letter, pinyin, candidates, etc., specific input content depends on the current input method.
- **[#] key:** Realize the switch among different input methods.
- **[*] key:** Delete All. Delete all the input contents.
- **[BACK] key:** Backspace key. Delete the contents in input field, or move cursor from candidate region to input field.
- **[] Up/down key:** Move the cursor to select the letter, number or symbol to be modified.
- **[MENU] key:** Confirm input content.

Basic Operation

■ Power On/Off

In the shutdown state, turn the volume knob clockwise to turn on radio. Turn the volume knob anti-clockwise until you hear the click to turn off radio.

■ Volume Adjustment

Rotate Volume Knob to adjust volume.

Rotate the volume knob clockwise to increase the volume and anti-clockwise to decrease the volume.

■ Zone Selection

Several communication channels can form a zone, it supports up to 250 zones for this transceiver, and each zone can be set with up to 16 channels.

◆ Zone Selection Operation



- Press [MENU] key to enter menus, press []Up/down key to select submenu item "Zone".
- Press [MENU] key again to enter zone selection interface and select the required zone.
- Press [MENU] key again to save setting and quit.

■ Channel Selection

Rotate channel selection knob to select channel in standby mode, the number of channels which up to 16 can be set in each zone.

■ PTT Transmitting

◆ Transmitted Power Selection

1. Enter Menu Item "Radio Set", press [] up/down key to select submenu item "TX Power".
2. Then press [MENU] key to enter the "TX Power" setting interface, press [] up/down key to select high power (icon display H) or low power (icon display L).

3. High power is generally selected if with high communication distance requirement; Select low power to save battery power consumption if communication distance is not far.

◆ Analog Channel Communication

1. Press and hold [PTT] key and speak into the microphone. The main channel is displayed in red when transmitting.
2. Release [PTT] key to return receiving status.

◆ Digital Channel Communication

Select the call object and initiate the call using the following methods:

1. Enter the menu item "Contact" and select the contact you want to call, then press and hold [PTT] key and speak into the microphone.
2. Enter the next level menu items of "Outgoing" or "Answered" in "Call Logs" menu item to select the contact you want to call, then press and hold [PTT] key and speak into the microphone.
3. Press and hold [PTT] key and speak into the microphone directly in standby mode. The outgoing number is the default contact number of the current channel, which can be set in the menu or by PC programming software.
4. Manually input the number you want to call in standby mode, then press and hold [PTT] key and speak into the microphone.

■ Receiving

When the transceiver receives the signal from the same channel, the receiving signal strength will be displayed on the LCD screen.

- Analog Channel Mode: The transceiver receives an analog signal with the CTCSS/DCS of the transmitting transceiver matches the transceiver, the transceiver turns on the speaker and outputs the voice of the transmitting transceiver.
- Digital Channel Mode: The transceiver will turn on the speaker and output the voice of the transmitting transceiver after receiving the Individual Call, Group call, All call.

■ Switch Between Primary And Secondary Channels

Press [] Primary channel switch button in the main interface to switch the main channel up and down.

There are two display areas of primary channel and secondary channel on the screen.

Menu Operation

The available menu items may vary based on whether the channel in use is digital channel or analog channel. And some menu items can be selected to appear or not through CPS programming software setting.

- Primary channel : Display font is bigger and with darker color.
- Secondary channel: Display font is smaller and with lighter color.

■ Switch of Dual Standby Mode

The dual frequency band standby mode can be selected through the menu with the menu operation process as: Menu - Set -- Radio Set - Dual Standby. And the dual standby mode options include: Off, Dual Standby, Single Wait.

- Dual Band Single Standby: Transceiver works in the main channel only, the secondary channel does not receive signals at this time.
- Dual Band Dual Standby: Receiving of Primary channel and secondary channel of the transceiver scan (standby) in turn, when scanning with effective signal received, the transceiver stays and works on current channel, if the channel is not the Primary channel, the **■▶** points at the temporary work channel, **■▶** mark disappears when timing time is up. When pressing [PTT] key without temporary mark, **▶** points at the main channel. Character "S" is displayed on the channel status bar when "Dual Band Dual Standby" is selected for the transceiver.

Note: DTMF receiving signaling system and automatic scanning do not work in dual standby mode.

■ Switch Between Frequency Mode And Channel Mode

Long press [BACK] key in the main interface to switch between frequency mode and channel mode.

- Frequency Mode: No channel number displayed, the receiving frequency can be input manually, parameters can be modified by menu item; Press [**⏮**] Up/down key to adjust the frequency as per frequency step.
- Channel Mode: Current channel number is displayed, the channel number can be input manually, parameters can be modified by menu item; Press [**⏮**] Up/down key to adjust the channel.

■ Menu Operation

1. Press [MENU] to enter the menu.
2. Press [**⏮**] up/down key to select menu items.
3. Press [MENU] key to confirm and enter the menu items.
4. Press [BACK] key to return to the previous menu item.
5. Press [**⏮**] key to exit menu operation status and directly return to standby mode.
6. Repeat steps 1~5 to operate the menu at all levels.

- Note:**
- During the menu operation, you can transmit and communicate directly after pressing and holding [PTT] key, and return to the main interface (standby mode) after releasing [PTT] key.
 - Long press [MENU] key in the main interface for quick access to the latest Level 1 menu , that is the last Level 1 menu reviewed.

■ Menu Details

Main menu items are available as shown in the figure if digital channel is used:

Level 1 Menu	Level 2 Menu	Level 3 Menu	Options/Description
Contact*1	Contact	Contact List	View Contact
			Quick Key
			Delete
			Edit Name
			Edit ID
			Call Alert
			Radio Check
			Remote Monitor
			Radio Active
			Radio Remote Kill

Level 1 Menu	Level 2 Menu	Level 3 Menu	Options/Description
Contact* ¹	New Contact	Input Number	xxxx
		Alias	Abcd
		Tone	Off, 1~10
	Manual Dial	Manual input number, maximum 16777215 (All Call Number)	
Message* ¹	InBox	Inbox	List...
		Delete All	Yes/No
	New Message	Edit Interface	Send/Save/Clear
	OutBox	OutBox	List...
		Delete All	Yes/No
	Draft	Draft	List...
		Delete All	Yes/No
	Quick Text	List...	Edit
Call Logs* ¹	Outgoing	Outgoing	List...
		Delete All	Yes/No
	Answered	Answered	List...
		Delete All	Yes/No
	Missed	Missed	List...
Delete All		Yes/No	
Set	Radio Set	CTCSS/ DCS* ²	C CTC/DCS
			R CTC/DCS
			T CTC/DCS
		Squelch	Strict/Normal
		TX Power	High
			Low
		Talkaround	On
			Off
		Band* ²	Narrow
			Wide

Level 1 Menu	Level 2 Menu	Level 3 Menu	Options/Description
Set	Radio Set	Busy Lock	Off
			Carrier
			QT/CC
		TOT	OFF
			15~495S
		Vox	OFF
			1~10
		Dual Standby	Off
			Dual Standby
			Single Standby
		Encrypt* ¹	Off
			On
		Power Save	Off
			On
		Beep	All Tone
			Call Permit
			Key Beep
			Call End Tone
		Backlight	Always On
			Always Off
			5/10 sec
		Keypad Lock	Manual
			5/10/15 sec
Indicator	Off		
	On		
Password Lock	Input Password		

Level 1 Menu	Level 2 Menu	Level 3 Menu	Options/Description	
Set	Radio Set	Mode	CH NO.	
			CH Name	
			CH Freq	
		Power-on Screen	Picture	
			Character	
		Language	English	
			Chinese	
		Radio Info	ID	12345678
			Info	Radio
	S/N			
	CPS-Version			
	H-Version			
	Soft-Version			
	DSP-Version			
	Program Date			
	Radio Configuration		Rx_Freq	Rx Freq setting
		Tx_Freq	Tx Freq setting	
		Ch_Name	Ch Name setting	
		Color Code ^{*1}	0~15	
		Slot ^{*1}	1~2	
		Group Receive List	Add and delete group call members	
		Shift Freq ^{*3}	000.000~050.000	
		Shift Direction ^{*3}	Off	
			Positive Shift Direction	
			Negative Shift Direction	
	Freq Step ^{*3}	2.5K/5.0K/6.25K/10K/12.5K/25K/30K/50K		
	Ch Type	Analog/Digital		

Level 1 Menu	Level 2 Menu	Level 3 Menu	Options/Description
Zone	Zone List	-----	Select Zone
Scan	On/Off	-----	Start or Stop scan
	Scan List	Scan List	Query Scan List
Append	Date & Time	Date/Time	View the date and time of the radio
	Recorder	Recorder: On/Off	Recorder On/Off
		01~32s	Standby time
		View	Play/Details/Delete
		Delete All	Delete All Recorders

Note: *1--For digital mode only, *2 --For analog mode only, *3 --For frequency mode only.

■ Digital Mode Menu

The digital mode menus are in use if digital channel is used, available menu items including: Contact, Message, Call Logs, Set, Zone, Scan, Append.

◆ Contact

Press [MENU] key to enter main menu then select "Contact" item, available submenu items including: Contact, New Contact, Manual Dial.

Contact	
1	Contact
2	New Contact
3	Manual Dial

1. Contact

Press [MENU] key to enter the "Individual Call, Group Call, All Call" under the menu item "Contact", press [MENU] key again to enter the submenu items including View Contact, Quick Key and Delete. And there are submenu items of Edit Name, Edit ID, Call Alert, Radio Check, Remote Monitor, Radio Active and Radio Kill for Individual Call.

Contact	
1	Individual Call
2	Group Call
3	All Call

- Individual Call: Make the call to one radio.
 - Group Call: Make the call to one group of radios.
 - All Call: Make the call to all radios.
- ※ Descriptions of submenu items.
- * **View Contact:** Check the name and ID of the selected contact.
 - * **Quick Key:** Set the current contact with quick key for easy operation, including vacancy state and 0~9. The vacancy state is selected to turn off the quick key.
 - * **Delete:** Delete the selected contact.
 - * **Set as Default:** Set the selected contact as default call of the current channel.
 - * **Call Alert:** Issue the call alert of the current selected individual call contact.
 - * **Radio Check:** Check the state of the individual call contact to confirm whether the radio is powered on or used in current channel.
 - * **Remote Monitor:** Send the “Remote Monitor” request to the target radio. The microphone and transmitter of the target radio will be activated for remote monitor. The target radio must enable the remote monitor decoding in the signaling system folder.
 - * **Radio Active:** Send the active command to the individual call contact to enable the radio working normally.
 - * **Radio Kill:** Send the kill command to the individual call contact to disable the radio working normally.

2. New Contact

To create new individual call contact, input the individual call contact number in the “input num” dialog box with maximum number as 16777214; Then press [MENU] key to enter the interface of “Alias” to input the alias with the keypad, press [#] key to switch the input modes including py/abc/ABC/123; Then press [MENU] key again to enter the “Tone” box including Off, Tone 1, Tone 2...Tone 10; Press [MENU] key to save; During the input process, press [BACK] key to delete the input content one by one while press the [END] key to end input and return to standby interface.

- Tone: There are 10 tones selectable, the local radio will issue this tone if the transmitting radio enables the call alert with its ID as the new contact, and can be selected to turn off the tone if not required.

3. Manual Dial

Input the 8 numbers in the “Manual Dial” dialog box with maximum number as 16777215 (All Call Number).

- Then press the [PTT] key to call the individual call contact with maximum number as 16777215 (All Call Number).
- During the manual input process, press [BACK] key to delete the input content one by one while press the [END] key to end input and back to standby interface.
- After completing the manual input, press [MENU] key to select the call commands including Call Alert, Radio Check, Remote Monitor, Radio Active and Radio Kill, then press [MENU] key to perform corresponding command call to the manual dial radio.

◆ Message

This menu includes functions of editing, sending, receiving, replying, forwarding, deleting messages. Press [MENU] key then select “Message”, submenus as follows:

Message	
1	InBox
2	New Message
3	OutBox
4	Draft
5	Quick Text

1. InBox

Received messages are saved here. Unread icon shows when new message is received.

- **InBox:** Press [MENU] key to enter “InBox” and select the message and press [MENU] key again to check the content. Press [MENU] key again to perform operations of Reply, Forward and Delete.

- **Delete All:** Clear all messages in Inbox.

2. New Message

Write new messages to send or save into Draft with this menu item, send contact can be selected in "Message Edit Menu"

● **New Message**

- * Input message content by pressing the numbers/letter keypads.
- * Press [MENU] key to confirm the correct input and enter text selection, press [↵] Up/Down key to select the words to be input.
- * Press [#] key to switch the input modes including py/abc/ABC/123.
- * Press [BACK] key to return and reenter.

● **Message Edit Menu**

After the completion of message editing, various operations of message can be performed with descriptions as follows:

- * **Send:** Send message to Individual Call, Group Call and All Call contacts.
- * **Save:** Save messages to Draft.
- * **Clear:** Clear the message you are editing and reenter the message content.

3. OutBox

Sent messages are saved here. When the outbox is full, the earliest message will be automatically clear if a new message has been sent. With submenus of OutBox and Delete All.

- **OutBox:** Press [MENU] key to enter "OutBox" and select the message and press [MENU] key again to check the content. Press [MENU] key again to perform operations of Resend, Forward, Edit and Delete.
- **Delete All:** Clear all messages in Outbox.

4. Draft

Draft messages are saved here. When the draft box is full, the earliest draft message will be automatically clear if with a new draft message. With submenus of Draft and Delete All.

- **Draft:** Press [MENU] key to enter "Draft" and select the message and press [MENU] key again to check the content. Press [MENU] key again to perform operations of Send, Edit and Delete.
Can be sent to Individual Call, Group Call and All Call contacts, or sent to the manual dial number.
- **Delete All:** Clear all messages in Draft.

5. Quick Text

Quick text are set by the dealer, you can select from them and read, then press [MENU] key again to perform operations of Send, Save and Delete.
Can be sent to Individual Call, Group Call and All Call contacts, or sent to the manual dial number.

◆ **Call Logs**

Press [MENU] key to enter main menu then select "Call Logs" item, And there are submenu items of Outgoing, Answered and Delete All. Outgoing and Answered calls are recorded. When the Call Logs are full, the earliest log will be automatically clear if with a new call log.
You can send remote kill and active calls to the call log if set with these two functions by the dealer.

Call Logs	
1	Outgoing
2	Answered
3	Missed

With submenus of Outgoing/Answered/Missed and Delete All in menus of Outgoing, Answered, Missed correspondingly.

- Enter "Outgoing", "Answered" or "Missed", select one call log and press [PTT] key to call the contact.
- Select "Delete All" and confirm to delete all the current call logs.
- Enter menu items of "Outgoing", "Answered" or "Missed", select one call log and press [MENU] key to perform the operations including View, Add Contact and Delete.
 - * **View:** View the details of the call log.
 - * **Add Contact:** Add the current call log to contact list with alias input. Find the contact in the contact list and press [PTT] key to call the contact quickly.
 - * **Delete:** Delete the call log.

◆ **Set**

You can set the radio in accordance with your own habits and needs to make it suitable for your use. With menu items including Radio Set, Radio Info and Radio Configuration.

Set	
1	Radio Set
2	Radio Info
3	Radio Configuration

1. Radio Set

Working parameters of this radio can be set in this menu, including Squelch, TX Power, Talkaround, Busy Lock, TOT, Vox, Dual Standby, Encrypt, Power Save, Beep, Backlight, Keypad Lock, Indicator, Password Lock, Mode, Screen, Language

● Squelch

The squelch level can be set as Normal and Strict in this menu.

* **Strict:** With lower interference from noise or extraneous signal, but not easy to receive weak signal.

* **Normal:** With higher interference from noise or extraneous signal, but easy to receive weak signal.

● TX Power

TX power for current channel can be set as high/low in this menu. TX power of each channel can be set separately.

* **High Power:** For long distance communication but with high battery power consumption. Icon **H** displays for high power in standby mode.

* **Low Power:** For short distance communication but with low battery power consumption. Icon **L** displays for low power in standby mode.

● Talkaround

Talkaround function enables when the repeater fails or exceeds its communication range but the two radios are within the communication range of each other, and the two radios change from the relay mode to the direct mode to realize the direct communication between them. The talkaround function can be turned on or off when it is configured and activated by the programming software.

* **On:** RX frequency and TX frequency are the same and switched as co-frequency communication mode when turning on the talkaround function.

* **Off:** RX frequency and TX frequency are different and switched as inter-frequency communication mode of the repeater when turning off the talkaround function.

● Busy Lock

The busy lock function will be activated to prohibit the transmission of the local radio to prevent interference with the communication of other radios when there is signal on the channel. There are 3 modes selectable, including Off, Carrier, QT/CC.

* **Off:** The radio can transmit at any time no matter whether there is signal on the channel (busy).

* **Carrier:** The radio cannot transmit as long as there is signal on the channel (busy) and will issue busy lock beep.

* **QT/CC:** The radio cannot transmit when there is signal on the channel with same QT/DQT or Color Code and will issue busy lock beep.

● TOT

It avoids users occupying channel for long time with this function. Radio will stop transmitting and issue warning beep if continuous transmitting time exceeds preset time, please release [PTT]. Please wait for certain time (set by dealer with programming software), then press and hold [PTT] to transmit again. If pre-warning is set by dealer with PC programming software, the pre-warning will issue before stop transmitting.

* **OFF:** Without TOT function.

* **15s-495s:** Transmitting time limit with 33 choices.

※ **Note:** The pre-warning will issue 10s before TOT setting and stop transmitting when time up, for example, TOT set as 60s, the pre-warning will issue when comes to 50s and stop transmitting when comes to 60s if continue to transmit.

● Vox



It enables you to release the hands and transmit without pressing the [PTT] key. You can directly control the radio transmission through voice when the Vox function is activated, the radio will automatically transmit when you start speaking and stop transmitting when you end the speaking.



* **OFF:** Without Vox function.

* **1-10:** With 10 Vox levels, select the suitable one as your needs.

● Dual Standby

Dual band standby operation can be performed when the dual standby function is activated, primary channel and secondary channel are displayed on the screen. Press [] key to switch the main channel up and down, the channel with bigger font and darker color is the main channel. It includes Dual Band Dual Standby and Dual Band Single Standby.

- * **Off:** Radio standby on current channel only.
- * **Dual Band Dual Standby:** Icon “S” is displayed on the channel status bar when “Dual Band Dual Standby” is selected for the radio, receiving of primary channel and secondary channel of the radio scan in turn, the radio stays and works on current channel when scanning with effective signal received, the  points at the temporary work channel if the channel is not the primary channel,  mark disappears when timing time is up.  points at the main channel when pressing [PTT] key without temporary mark.
- * **Dual Band Single Standby:** Radio works in the primary channel only, the secondary channel does not receive signals at this time.
- ※**Note:** Automatic scanning does not work due to that the radio is in the primary and secondary scan state for dual standby mode.
- **Encrypt**
Voice encrypt function, which can be set as on or off, is available in this radio to ensure the privacy of the communication process.
 - * **Off:** Communication voice is not encrypted.
 - * **On:** Communication voice is encrypted.
 - ※**Encrypt key setting**
 - Select “Basic” in the “Privacy Type” of “Privacy” in CPS.
 - Add the encrypt key in the “Encrypt Key List” of the “Privacy” in CPS, click the encrypt key to modify, more digits for better privacy, and multi encrypt key list can be set.
 - Select the required privacy group in the channel setting. Then program the data into radio.
- **Power Save**
The radio will automatically enter power save mode after no any TX/RX and keypad operations for a certain time when power save function is on, which can be selected as On/Off.
 - * **Off:** Without power save, with high power consumption and real-time signal receiving.
 - * **On:** With power save and low power consumption.
- **Beep**
The corresponding beep can be switched on/off based on actual needs.
 - * **All Tone:** All operation tone, can be switched On/Off. All the tones can be switched off except for emergency alarm tone.

- * **Call Permit:** Issue beep during call permit, it will issue beep to prompt the user to start speaking after pressing and holding [PTT] key, with options including Off, Digital, Analog, Both.
 - **Off:** Turn off this function.
 - **Digital:** With beep for digital channels only.
 - **Analog:** With beep for analog channels only.
 - **Both:** With beep for both analog and digital channels.
- * **Key Beep:** Issue beep during keypad operation.
- **Backlight**
Backlight can be set here.
 - * **Always On:** Backlight always on.
 - * **Always Off:** Backlight always off.
 - * **5 sec:** Backlight off after no keypad operation for 5 seconds.
 - * **10 sec:** Backlight off after no keypad operation for 10 seconds.
- **Keypad Lock**
Most of the keypads can be locked to avoid misoperation but [PTT]/[ALARM] key.
 - * **Manual:** Press and hold [*] key for more than 2 seconds for manual keypad lock. Press [MENU] key and then [*] key for keypad unlock. Icon  displays when keypad lock while  disappears when keypad unlock.
 - * **5 sec/10 sec/15 sec:** Automatic keypad lock after no any operation for a certain time, with 3 options. Taking 5 sec for example, the keypad will be automatically locked after no any operation for 5 seconds, and need to press [MENU] key and then [*] key for keypad unlock.
- **Indicator**
The TX indicator, RX indicator and power-on indicator can be set as On/Off.
 - * **Off:** All the indicators including TX indicator, RX indicator and power-on indicator are not activated.
 - * **On:** All the indicators are activated. Default set as On.
- **Password Lock**
Power-on password with maximum 6-digit number can be set in this radio, need to input the correct password to enter the set menu. Power-on password can be set by “Boot Item” in CPS, input the Power-on password with the numeric keypad. With options of On, Off and Change Power-on password.
 - * **On/Off:** Need to input the correct password and press [MENU] key to power on when the password lock function is activated.
 - * **Change Power-on password:** New 6-digit numeric password can be input, please do remember the password.

- **Mode Selection**

Main standby interface display can be set here, with channel models including Channel Number (CH NO.), Channel Name (CH Name) and Channel Frequency (CH Freq).

* **CH NO.:** Number of current channel is displayed.

* **CH Name:** Name of current channel is displayed.

* **CH Freq:** Frequency of current channel is displayed.

- **Screen (Boot Interface)**

Pictures and preset characters can be set as boot interface display, which can be set by CPS.

Picture displayed as per provided by customers, with two lines of preset characters.

- **Language**

Display and beep language can be set as English or Chinese.

2. Radio Info

Radio info including Radio ID and Device Info can be queried by this menu.

- **Radio ID**

Radio ID with maximum 8-digit numbers can be queried, input and saved here. Radio ID with maximum of 16777214 is displayed for digital mode; Radio DTMF ID with maximum of 99999999 is displayed for analog mode. Radio ID is not editable.

- **Device Info**

It includes Model Info, S/N, CPS-Version, Hardware-Version, Software-Version, DSP-Version, Program Date and Program Time.

3. Radio Configuration

Radio configuration parameters including Rx Frequency, Tx Frequency, Channel Name, Color Code, Slot, Shift Frequency, Shift Direction, Frequency Step and Channel Type can be queried and edited in this menu item.

- **Rx Frequency (Rx_Freq)**

Rx frequency setting. Press [BACK] key to delete the setting Rx frequency, press numeric keypad to input the frequency needed and press [MENU] key to save.

- **Tx Frequency (Tx_Freq)**

Tx frequency setting. Press [BACK] key to delete the set Tx frequency, press numeric keypad to input the frequency needed and press [MENU] key to save.

- **Channel Name (Ch_Name)**

Channel name setting. Press [BACK] key to delete the set channel name, press [#] key to switch the input modes including py/abc/ABC/123, press numeric keypad to input the channel name required and press [MENU] key to save.

- **Color Code**

Color code can be used to distinguish multiple digital radios with same frequency to reduce co-frequency interference. 16 color codes of 0~15 can be set for each channel.

- **Slot**

Slot 1 or 2 can be selected to communication on different slots. The radio supports dual-slot simultaneous communication on direct mode.

- **Group Rx List**

Used to add or delete group call members.

- **Shift Frequency (Shift Freq)**

It refers to the shift frequency between Rx and Tx frequencies. Input the shift frequency with numeric keypad on "Shift Frequency" interface with unit at MHz.

- **Shift Direction (Shift Dir)**

Shift direction can be selected in this menu with options including Off, Positive Shift Direction, Negative Shift Direction.

* **Off:** No shift frequency between Rx and Tx frequencies in frequency mode, Tx frequency = Rx frequency.

* **Positive Shift Direction:** Tx frequency = Rx frequency + shift frequency in frequency mode.

* **Negative Shift Direction:** Tx frequency = Rx frequency - shift frequency in frequency mode.

- **Frequency Step (Freq Step)**

Frequency step with options of 2.5K/5.0K/6.25K/10K/12.5K/25K/30K/50KHz can be selected in this menu.

* Frequency can be adjusted as per the frequency step by pressing [↻] Up/down key in frequency mode.

* It scans as per the frequency step in frequency mode.

- **Channel Type (Ch Type)**

Channel type with options of Analog and Digital can be selected in this menu. Current frequency can be switched between analog mode and digital mode in frequency mode. Channel type cannot be changed in channel mode.

◆ Zone

One zone is composed of several channels. The required zone can be selected by this menu item. Zone name is displayed on upper part of the screen when "Dual Standby" function is off.

◆ Scan

Press [MENU] key to enter main menu and select "Scan".

Then press [MENU] key again to enter the submenus as follows:

Scan	
1	On
2	Scan List

● On/Off

It enables to switch scan on with this menu item to listen to communication of other channels with the scan function.

After switching scan on, press [MENU] key to display the submenus as follows:

Scan	
1	Off
2	Scan List

Select Off to stop scanning and return to standby status.

※ Note: You can press [BACK] key or [END] key to stop scanning during the scan process.

● Scan List

Each channel can be related to one "Scan List" by CPS setting to start scanning, 16 digital or analog channels at most are included in each "Scan List". Select menu item "Scan List" to check the scan channels included in the "Scan List" used by current channel, and need to add/delete the scan channels by CPS.

◆ Append

Functions in the append are optional, please contact dealer to have these functions.

Append	
1	Date & Time
2	Recorder

1. Date & Time

Date and time of the radio can be checked and revised, enter the "Date & Time" interface, press [⏮] Up/down key to move the cursor and press numeric keys to input date and time, and press [MENU] key to save setting and quit.

2. Recorder

The communication voice can be recorded(For digital mode only).

● Record

Can be selected as on or off. Communication voice will be recorded and "Record" is displayed on screen if the function is on.

● Standby Time

It refers to timeout between two adjacent recording intervals to ensure the continuity of recording. For example, if the standby time is set as 10s, the communication with interval within 10s after the first recording is regarded as the first recording, and the one with interval over 10s is regarded as the second recording. With 32 options of 1-32s.

● View

Enter the list to perform below operations:

* **Play:** Press [MENU] key to play the recorder with recording duration displayed on the screen, press [BACK] key to stop playing.

* **Information:** Press [MENU] key to enter and press [⏮] Up/down key to search detailed information of the recording including Label, Duration, Date, Time, Own ID, Far ID and Call Type.

* **Delete:** Press [MENU] key to delete current recording.

● Delete All

Press [MENU] key to delete all recording.

■ Analog Mode Menu

The analog mode menus are in use if analog channel is used, available menu items including: Set, Zone, Scan, Append.

In which menu items of Zone, Scan, Append are same as Digital Mode, and menu items of "Set" are same as Digital Mode also except for "CTCSS/DCS" and "Band", please refer to [Digital Mode Menu] in previous chapter.

View the channel information to check the Tx frequency, Rx frequency, Tx CTCSS /DCS and Rx CTCSS/DCS.

◆ CTCSS/DCS

CTCSS/DCS setting for analog mode only with 50 groups of CTCSS and 105 groups of DCS selectable. With submenus including C CTC/DCS, R CTC/DCS, T CTC/DCS and the operations are the same.

Operation method as follows:

1. Enter the submenu to display CTCSS or DCS for current channel.
2. Press [*] key to select OFF/CTCSS/DCS, press [] Up/down key to select the required standard CTCSS/DCS.
3. Press [#] key to switch normal phase (N) and inverse phase (I) in DCS mode.
4. Or press numeric key to input off-standard CTCSS/DCS directly.
5. Press [MENU] key to save setting and "Set Succeed" is displayed on screen.

◆ Band

Wide/narrow band setting for analog model only. The frequency spacing of the radio is 25kHz if wide band is selected, the call quality is good but it occupies more frequency resources. The frequency spacing of radio is 12.5kHz if narrow band is selected, which saves frequency resources but the call quality is average.

■ Emergency Alarm

Emergency alarm is used to indicate an emergency. The emergency call can be initiated at any time or on any screen, even if there is activity on the current channel. The programmable key can be configured by CPS with short press for emergency mode on and long press for emergency mode off, and the alarm mode is selected as regular mode.

[TK] orange emergency alarm key at the top is defined as the emergency alarm key by default.

◆ Initiator

Long press the [TK] orange emergency alarm key at the top to enter emergency mode (interface display: Emergency Alarm is displayed on the first line, Alarm group call contact alias is displayed on the second line and group call number is displayed on the third line) to initiate local alarm and send alarm command, the alarm mode can be set as Emergency Alarm, Emergency Alarm w/Call and Emergency Alarm w/Voice to Follow. Short press emergency alarm key or when the maximum number of attempts to send an alarm has been reached to quit the alarm mode.

※Note: The alarm system takes effect only when the "Emergency Alarm System" of current channel is configured by CPS and the reply channel address book of the emergency alarm system is group call.

◆ Receiver

Alarm information is displayed (interface display: Alarm Received is displayed on the first line, Group Call is displayed on the second line and Initiator alias or ID is displayed on the third line) and local alarm is initiated after alarm command is received, press [PTT] key to quit.

■ DTMF Call

Initiated by PTTID: Configure DTMF PTTID Up Code and PTTID Down Code by CPS in analog mode, enable both codes in analog channel to issue PTTID Up Code when pressing and holding [PTT] key, and issue PTTID Down Code when releasing [PTT] key.

Main Technical Specifications

General Specifications	
Frequency Range	136-174MHz & 400-470MHz
Channel Capacity	1024
Zone	250
Channel Spacing	Digital: 12.5kHz
Frequency Stability	± 0.5ppm
Working Voltage	DC7.4 ± 15%
Battery Capacity	1800mAh(Li-ion Battery)
Working Temperature	-20°C ~ +60°C
Storage Temperature	-40°C ~ +85°C
Overall Dimension (W x H x D)	60mm*135mm*36mm
Weight (Battery, Belt Clip, Antenna Included)	280g
Receiver Specifications	
Digital Sensitivity	≤ -119dBm (BER ≤ 5%) ≤ -117dBm (BER ≤ 1%)
Intermodulation	≥ 50dB @ 12.5 kHz; ≥ 65dB @ 25 kHz
Adjacent Channel Selectivity	≥ 50dB @ 12.5 kHz; ≥ 60dB @ 25 kHz
Spurious Suppression	≥ 70dB
Audio Power	>1W (16Ω)
Audio Distortion	≤ 5%

Transmitter Specifications	
RF Power	5W/1W
4FSK Modulation Mode	12.5kHz Data; 7K60FXD 12.5kHz Data and Voice: 7K60FXE
Modulation Sensitivity	10 ± 3mV
Spurious Radiation	-36dBm ≤ 1GHz / -30dBm ≥ 1GHz
Adjacent Channel Power	≤ -55dB @ 12.5KHz
4FSK Modulation Accuracy	≤ -65dB @ 25KHz ≤ 5%
Audio Distortion	≤ 5%
Digital Vocoder	AMBE++

Common Troubleshooting

No.	Troubles	Troubleshooting
1	Power-on no response	<ul style="list-style-type: none"> ● Battery power exhausted, please charge or replace battery. ● Battery not installed correctly, please remove and reinstall.
2	The battery is easily exhausted after full charging.	<ul style="list-style-type: none"> ● Battery pack life is ending, please replace it.
3	Low communication voice	<ul style="list-style-type: none"> ● Distance between lips and microphone is too large, best to be 3-10cm. ● Incorrect volume setting, please rotate volume knob in clockwise to increase volume.
4	Cannot communicate	<ul style="list-style-type: none"> ● Incorrect channel parameters setting, reset parameters. ● Incorrect ID information, please select correct ID. ● Communication distance out of effective range.

FCC Caution:

Any Changes or modifications not expressly approved by the party responsible for compliance could void the user's authority to operate the equipment. This device complies with part 15 of the FCC Rules. Operation is subject to the following two conditions: (1) This device may not cause harmful interference, and (2) this device must accept any interference received, including interference that may cause undesired operation.

Note: This equipment has been tested and found to comply with the limits for a Class B digital device, pursuant to part 15 of the FCC Rules. These limits are designed to provide reasonable protection against harmful interference in a residential installation. This equipment generates, uses and can radiate radio frequency energy and, if not installed and used in accordance with the instructions, may cause harmful interference to radio communications. However, there is no guarantee that interference will not occur in a particular installation. If this equipment does cause harmful interference to radio or television reception, which can be determined by turning the equipment off and on, the user is encouraged to try to correct the interference by one or more of the following measures:

- Reorient or relocate the receiving antenna.
- Increase the separation between the equipment and receiver.
- Connect the equipment into an outlet on a circuit different from that to which the receiver is connected.
- Consult the dealer or an experienced radio/TV technician for help.

This radio is designed for and classified as "Occupational/Controlled Use Only", meaning it must be used only during the course of employment by individuals aware of the hazards, and the ways to minimize such hazards; NOT intended for use in an General population/uncontrolled environment. DO NOT operate the radio without a proper antenna attached, as this may damage the radio and may also cause you to exceed RF exposure limits. A proper antenna is the antenna supplied with this radio by the manufacturer or an antenna specifically authorized by the manufacturer for use with this radio. DO NOT transmit for more than 50% of total radio use time, more than 50% of the time can cause RF exposure compliance requirements to be exceeded. This transmitter may operate with the antenna(s) documented in this filing in Push-to-Talk and body-worn configurations. RF exposure compliance is limited to the specific belt-clip and accessory configurations as documented in this filing and the separation distance between user and the device or its antenna shall be at least 2.5 cm.