



MEASUREMENT REPORT

(FCC Class II Change & IC Class IV Change)

FCC PART 15.247 & IC RSS-247 Bluetooth V5.0 LE

FCC ID: 2AGRR-LBEE5ZZ1PJ
IC: 8110A-LBEE5ZZ1PJ
APPLICANT: Zykronix Inc. Taiwan Branch
Application Type: Certification
Product: W-LAN + Bluetooth Module
Model No.: LBEE5ZZ1PJ
FCC Classification: (DTS) Digital Transmission System
FCC & IC Rule Part(s): Part 15.247 & RSS-247 Issue 2
Test Procedure(s): ANSI C63.10-2013
Received Date: April 6, 2020
Test Date: July 28 ~ August 6, 2020

Tested By : *Peter Syu*

(Peter Syu)

Reviewed By : *Paddy Chen*

(Paddy Chen)

Approved By : *Chenz Ker*

(Chenz Ker)



Testing Laboratory
3261

The test results only relate to the tested sample.

This equipment has been shown to be capable of compliance with the applicable technical standards as indicated in the measurement report and was tested in accordance with the measurement procedures specified in ANSI C63.10-2013. Test results reported herein relate only to the item(s) tested.

The test report shall not be reproduced except in full without the written approval of MRT Technology (Taiwan) Co., Ltd.

Revision History

Report No.	Version	Description	Issue Date	Note
2004TW0501-U3	1.0	Original Report	2020-09-17	

CONTENTS

Description	Page
§2.1033 General Information	5
1. INTRODUCTION	6
1.1. Scope.....	6
1.2. MRT Test Location.....	6
2. PRODUCT INFORMATION	7
2.1. Equipment Description	7
2.2. Product Specification Subjective to this Standard.....	8
2.3. Test Mode.....	8
2.4. Operation Frequency / Channel List.....	9
2.5. Test Configuration.....	10
2.6. Test Software.....	10
2.7. EMI Suppression Device(s)/Modifications	10
2.8. Labeling Requirements	10
3. DESCRIPTION of TEST	11
3.1. Evaluation Procedure.....	11
3.2. AC Line Conducted Emissions	11
3.3. Radiated Emissions	12
4. ANTENNA REQUIREMENTS.....	13
5. TEST EQUIPMENT CALIBRATION DATE.....	14
6. MEASUREMENT UNCERTAINTY.....	15
7. TEST RESULT	16
7.1. Summary.....	16
7.2. 6dB Bandwidth Measurement	17
7.2.1. Test Limit.....	17
7.2.2. Test Procedure used	17
7.2.3. Test Setting	17
7.2.4. Test Setup	17
7.2.5. Test Result	18
7.3. Output Power Measurement.....	19
7.3.1. Test Limit.....	19
7.3.2. Test Procedure Used.....	19
7.3.3. Test Setting	19
7.3.4. Test Setup	19
7.3.5. Test Result of Output Power	20
7.4. Power Spectral Density Measurement	21
7.4.1. Test Limit.....	21
7.4.2. Test Procedure Used.....	21
7.4.3. Test Setting	21
7.4.4. Test Setup	21
7.4.5. Test Result	22

7.5.	Out-of-Band Spurious Emissions Emissions Measurement	23
7.5.1.	Test Limit	23
7.5.2.	Test Procedure Used	23
7.5.3.	Test Settiting	23
7.5.4.	Test Setup	23
7.5.5.	Test Result	24
7.6.	Radiated Spurious Emission Measurement	25
7.6.1.	Test Limit	25
7.6.2.	Test Procedure Used	25
7.6.3.	Test Setting	25
7.6.4.	Test Setup	27
7.6.5.	Test Result	29
7.7.	Radiated Restricted Band Edge Measurement	45
7.7.1.	Test Limit	45
7.7.2.	Test Procedure Used	45
7.7.3.	Test Setting	45
7.7.4.	Test Setup	47
7.7.5.	Test Result	48
7.8.	AC Conducted Emissions Measurement	57
7.8.1.	Test Limit	57
7.8.2.	Test Setup	57
7.8.3.	Test Result	58
8.	CONCLUSION	66

§2.1033 General Information

Applicant	Zykronix Inc. Taiwan Branch
Applicant Address	14F.-8, No. 3, Sec. 4, New Taipei Blvd., Xinzhuang Dist., New Taipei City, Taiwan
Manufacturer	Zykronix Inc. Taiwan Branch
Manufacturer Address	14F.-8, No. 3, Sec. 4, New Taipei Blvd., Xinzhuang Dist., New Taipei City, Taiwan
Test Site	MRT Technology (Taiwan) Co., Ltd
Test Site Address	No. 38, Fuxing Second Rd., Guishan Dist., Taoyuan City 333, Taiwan (R.O.C)
MRT FCC Registration No.	291082
FCC Rule Part(s)	Part 15.247
Model No.	Sonata, Sonata XL, Opus, Opus XL
Test Device Serial No.	#1 <input type="checkbox"/> Production <input checked="" type="checkbox"/> Pre-Production <input type="checkbox"/> Engineering

Test Facility / Accreditations

1. MRT facility is a FCC registered (Reg. No. 291082) test facility with the site description report on file and is designated by the FCC as an Accredited Test Firm.
2. MRT facility is an IC registered (MRT Reg. No. 21723) test laboratory with the site description on file at Industry Canada.
3. MRT Lab is accredited to ISO 17025 by the Taiwan Accreditation Foundation (TAF Cert. No. 3261) in EMC, Telecommunications and Radio testing for FCC (Designation Number: TW3261), Industry Taiwan, EU and TELEC Rules.

1. INTRODUCTION

1.1. Scope

Measurement and determination of electromagnetic emissions (EMC) of radio frequency devices including intentional and/or unintentional radiators for compliance with the technical rules and regulations of the Federal Communications Commission and the Industry Canada Certification and Engineering Bureau.

1.2. MRT Test Location

The map below shows the location of the MRT LABORATORY, its proximity to the Taoyuan City. These measurement tests were conducted at the MRT Technology (Taiwan) Co., Ltd. Facility located at No.38, Fuxing 2nd Rd., Guishan Dist., Taoyuan City 33377, Taiwan (R.O.C).

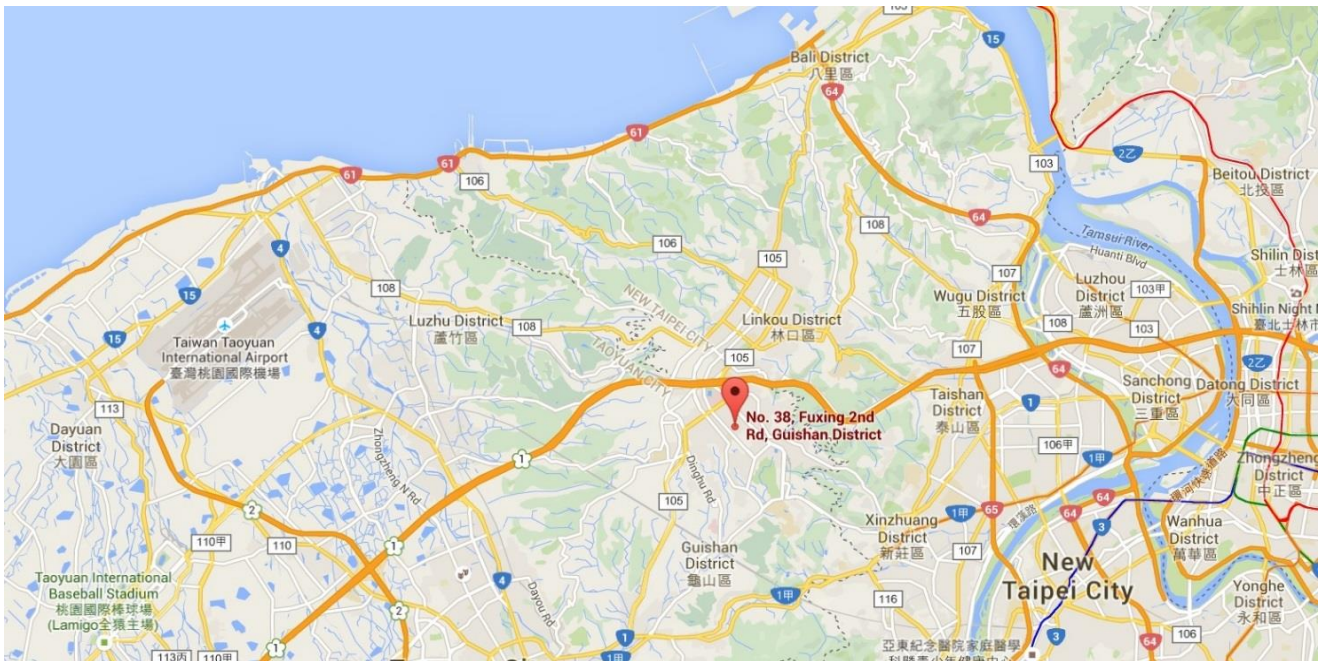

2. PRODUCT INFORMATION

2.1. Equipment Description

Product Name	W-LAN + Bluetooth Module
Model No.	LBEE5ZZ1PJ
Supports Radios Spec.	WLAN: 2.4G: 802.11b/g/n-HT20/n-VHT20/n-HT40/n-VHT40; Bluetooth Dual Mode: V5.0
Bluetooth Specification	Dual Mode; V5.0
Maximum Power	4.915dBm
Power Adapter	MFR: DELTA ELECTRONICS, INC. Model No: ADP-85NB A Input: AC 100-240V~1.5A, 50-60Hz Output: DC 24V, 3.55A Cable Out: Non-shielding, 1.5m with Core*1

Note:

1. This case is to add Host (Product Name: 8.0" Touch Screen Controller, 5.7" Touch Screen Controller, Model No.: Sonata, Sonata XL, Opus, Opus XL) and disable WIFI-5G & reduce WIFI-2.4G Power, so the FCC C2PC & IC C4PC (Radiated Spurious Emission, Conducted Output Power, AC Conducted Emissions) is executed.

FCC Original Report Grant Date: 09/11/2020, FCC ID: 2AGRR-LBEE5ZZ1PJ

IC Original Report Grant Date: 09/14/2020, IC: 8110A-LBEE5ZZ1PJ

2. Model difference: (declared by the manufacturer)

Product Name	Trade Name	Model Number	Different
8.0" Touch Screen Controller	Zykronix	Sonata XL	This model is main model.
8.0" Touch Screen Controller	Zykronix	Sonata	The difference from the main model is that the frame has no LED.
5.7" Touch Screen Controller	Zykronix	Opus XL	The difference from the main model is that the screen size.
5.7" Touch Screen Controller	Zykronix	Opus	The difference from the main model is that the screen size & has no LED.

2.2. Product Specification Subjective to this Standard

Operating Frequency	2402~2480MHz
Type of modulation	GFSK
Data Rate	1Mbps

2.3. Test Mode

Test Mode	Mode 1: Transmit - LE (GFSK)
-----------	------------------------------

Note:

Regarding to the operation frequency, the lowest, middle and highest frequency are selected to perform the test.

2.4. Operation Frequency / Channel List

Channel	Frequency	Channel	Frequency	Channel	Frequency
00	2402 MHz	01	2404 MHz	02	2406 MHz
03	2408 MHz	04	2410 MHz	05	2412 MHz
06	2414 MHz	07	2416 MHz	08	2418 MHz
09	2420 MHz	10	2422 MHz	11	2424 MHz
12	2426 MHz	13	2428 MHz	14	2430 MHz
15	2432 MHz	16	2434 MHz	17	2436 MHz
18	2438 MHz	19	2440 MHz	20	2442 MHz
21	2444 MHz	22	2446 MHz	23	2448 MHz
24	2450 MHz	25	2452 MHz	26	2454 MHz
27	2456 MHz	28	2458 MHz	29	2460 MHz
30	2462 MHz	31	2464 MHz	32	2466 MHz
33	2468 MHz	34	2470 MHz	35	2472 MHz
36	2474 MHz	37	2476 MHz	38	2478 MHz
39	2480 MHz	N/A	N/A	N/A	N/A

2.5. Test Configuration

This device was tested per the guidance of ANSI C63.10-2013. ANSI C63.10-2013 was used to reference the appropriate EUT setup for radiated spurious emissions testing and AC line conducted testing.

2.6. Test Software

The test utility software used during testing was "QRCT".

2.7. EMI Suppression Device(s)/Modifications

No EMI suppression device(s) were added and/or no modifications were made during testing.

2.8. Labeling Requirements

Per 2.1074 & 15.19; Docket 95-19

The label shall be permanently affixed at a conspicuous location on the device; instruction manual or pamphlet supplied to the user and be readily visible to the purchaser at the time of purchase. However, when the device is so small wherein placement of the label with specified statement is not practical, only the FCC ID must be displayed on the device per Section 15.19(a)(5). Please see attachment for FCC ID label and label location.

3. DESCRIPTION of TEST

3.1. Evaluation Procedure

The measurement procedures described in the American National Standard for Testing Unlicensed Wireless Devices (ANSI C63.10-2013), and the guidance provided in KDB 558074 D01v05 were used in the measurement of the **Touch Screen Controller**.

Deviation from measurement procedure.....None

3.2. AC Line Conducted Emissions

The line-conducted facility is located inside an 9'x4'x3' shielded enclosure. A 1m x 2m wooden table 80cm high is placed 40cm away from the vertical wall and 80cm away from the sidewall of the shielded room. Two 10kHz-30MHz, 50Ω/50uH Line-Impedance Stabilization Networks (LISNs) are bonded to the shielded room floor. Power to the LISNs is filtered by external high-current high-insertion loss power line filters. These filters attenuate ambient signal noise from entering the measurement lines. These filters are also bonded to the shielded enclosure.

The EUT is powered from one LISN and the support equipment is powered from the second LISN. All interconnecting cables more than 1 meter were shortened to a 1 meter length by non-inductive bundling (serpentine fashion) and draped over the back edge of the test table. All cables were at least 40cm above the horizontal reference ground-plane. Power cables for support equipment were routed down to the second LISN while ensuring that that cables were not draped over the second LISN.

Sufficient time for the EUT, support equipment, and test equipment was allowed in order for them to warm up to their normal operating condition. The RF output of the LISN was connected to the receiver and exploratory measurements were made to determine the frequencies producing the maximum emission from the EUT. The receiver was scanned from 150kHz to 30MHz. The detector function was set to peak mode for exploratory measurements while the bandwidth of the analyzer was set to 9kHz. The EUT, support equipment, and interconnecting cables were arranged and manipulated to maximize each emission. Each emission was also maximized by varying: power lines, the mode of operation or data exchange speed, or support equipment which determined the worst-case emission. Once the worst case emissions have been identified, the one EUT cable configuration/arrangement and mode of operation that produced these emissions are used for final measurements on the same test site. The analyzer is set to CISPR quasi-peak and average detectors with a 9kHz resolution bandwidth for final measurements.

An extension cord was used to connect to a single LISN which powered by EUT. The extension cord was calibrated with LISN, the impedance and insertion loss are compliance with the requirements as stated in ANSI C63.10-2013.

Line conducted emissions test results are shown in Section 7.8.

3.3. Radiated Emissions

The radiated test facilities consisted of an indoor 3 meter semi-anechoic chamber used for final measurements and exploratory measurements, when necessary. The measurement area is contained within the semi-anechoic chamber which is shielded from any ambient interference. For measurements above 1GHz absorbers are arranged on the floor between the turn table and the antenna mast in such a way so as to maximize the reduction of reflections. For measurements below 1GHz, the absorbers are removed. A MF Model 210SS turntable is used for radiated measurement. It is a continuously rotatable, remote controlled, metallic turntable and 2 meters (6.56 ft.) in diameter. The turn table is flush with the raised floor of the chamber in order to maintain its function as a ground plane. An 80cm high PVC support structure is placed on top of the turntable.

For all measurements, the spectrum was scanned through all EUT azimuths and from 1 to 4 meter receive antenna height using a broadband antenna from 30MHz up to the upper frequency shown in 15.33(b)(1) depending on the highest frequency generated or used in the device or on which the device operates or tunes. For frequencies above 1GHz, linearly polarized double ridge horn antennas were used. For frequencies below 30MHz, a calibrated loop antenna was used. When exploratory measurements were necessary, they were performed at 1 meter test distance inside the semi-anechoic chamber using broadband antennas, broadband amplifiers, and spectrum analyzers to determine the frequencies and modes producing the maximum emissions. Sufficient time for the EUT, support equipment, and test equipment was allowed in order for them to warm up to their normal operating condition. The test set-up for frequencies below 1GHz was placed on top of the 0.8 meter high, 1 x 1.5 meter table; and test set-up for frequencies 1-40GHz was placed on top of the 1.5 meter high, 1 x 1.5 meter table. The EUT, support equipment, and interconnecting cables were arranged and manipulated to maximize each emission. Appropriate precaution was taken to ensure that all emissions from the EUT were maximized and investigated. The system configuration, clock speed, mode of operation or video resolution, if applicable, turntable azimuth, and receive antenna height was noted for each frequency found.

Final measurements were made in the semi-anechoic chamber using calibrated, linearly polarized broadband and horn antennas. The test setup was configured to the setup that produced the worst case emissions. The spectrum analyzer was set to investigate all frequencies required for testing to compare the highest radiated disturbances with respect to the specified limits. The turntable containing the EUT was rotated through 360 degrees and the height of the receive antenna was varied 1 to 4 meters and stopped at the azimuth and height producing the maximum emission. Each emission was maximized by changing the orientation of the EUT through three orthogonal planes and changing the polarity of the receive antenna, which produced the worst-case emissions. According to 3dB Beam-Width of horn antenna, the horn antenna should be always directed to the EUT when rising height.

Radiated emissions test results are shown in Section 7.6 & 7.7 .

4. ANTENNA REQUIREMENTS

Excerpt from §15.203 of the FCC Rules & §RSS-GEN of the IC /Regulations:

“An intentional radiator antenna shall be designed to ensure that no antenna other than that furnished by the responsible party can be used with the device. The use of a permanently attached antenna or of an antenna that uses a unique coupling to the intentional radiator shall be considered sufficient to comply with the provisions of this section.”

- The antenna of the Touch Screen Controller, is permanently attached.
- There are no provisions for connection to an external antenna.

Conclusion:

The EUT unit complies with the requirement of §15.203 & RSS-GEN 6.8.

Antenna List

No.	Manufacturer	Part No.	Antenna Type	Peak Gain
1	ANJIE Electronics	ANDQ1J-B0025	PCB	2.15dBi

5. TEST EQUIPMENT CALIBRATION DATE

Conducted Emissions – SR2

Instrument	Manufacturer	Type No.	Asset No.	Cali. Interval	Cali. Due Date
Two-Line V-Network	R&S	ENV216	MRTTWA00020	1 year	2021/4/24
Cable	Rosnol	N1C50-RG400-B 1C50-500CM	MRTTWE00013	1 year	2021/6/21
EMI Test Receiver	R&S	ESR3	MRTTWA00009	1 year	2021/3/25

Radiated Emissions – AC1

Instrument	Manufacturer	Type No.	Asset No.	Cali. Interval	Cali. Due Date
Broadband TRILOG Antenna	SCHWARZBECK	VULB 9162	MRTTWA00001	1 year	2020/9/4
EMI Test Receiver	R&S	ESR3	MRTTWA00009	1 year	2021/3/25
Active Loop Antenna	Schwarzbeck	FMZB 1519B	MRTTWA00002	1 year	2021/4/27
Broadband Horn antenna	SCHWARZBECK	BBHA 9120D	MRTTWA00003	1 year	2021/4/24
Breitband Hornantenna	Schwarzbeck	BBHA 9170	MRTTWA00004	1 year	2021/4/24
Broadband Amplifier	Schwarzbeck	BBV 9721	MRTTWA00006	1 year	2021/4/24
Broadband Preampfier	SCHWARZBECK	BBV 9718	MRTTWA00005	1 year	2021/4/24
Cable	HUBERSUHNER	SF106	MRTTWA00010	1 year	2021/6/16
Cable	Rosnol	K1K50-UP0264- K1K50-4M	MRTTWE00012	1 year	2021/6/20

Conducted Test Equipment – SR2

Instrument	Manufacturer	Type No.	Asset No.	Cali. Interval	Cali. Due Date
EXA Signal Analyzer	KEYSIGHT	N9010A	MRTTWA00012	1 year	2020/10/2
EXA Signal Analyzer	KEYSIGHT	N9010B	MRTTWA00074	1 year	2021/7/14
USB Wideband Power Sensor	KEYSIGHT	U2021XA	MRTTWA00015	1 year	2021/3/26

Test Software

Software	Version	Function
e3	9.160520a	EMI Test Software
EMI	V3	EMI Test Software

6. MEASUREMENT UNCERTAINTY

Where relevant, the following test uncertainty levels have been estimated for tests performed on the EUT as specified in CISPR 16-4-2. This uncertainty represents an expanded uncertainty expressed at approximately the 95% confidence level using a coverage factor of $k = 2$.

Conducted Emission- Power Line
Measuring Uncertainty for a Level of Confidence of 95% ($U=2Uc(y)$): 0.15MHz~30MHz: $\pm 2.53\text{dB}$
Radiated Spurious Emission
Measuring Uncertainty for a Level of Confidence of 95% ($U=2Uc(y)$): 9kHz~30MHz: $\pm 3.92\text{dB}$ 30MHz~1GHz: $\pm 4.25\text{dB}$ 1GHz~18GHz: $\pm 4.40\text{dB}$ 18GHz~40GHz: $\pm 4.45\text{dB}$
Frequency Error
Measuring Uncertainty for a Level of Confidence of 95% ($U=2Uc(y)$): $\pm 78.4\text{Hz}$
Conducted Power
Measuring Uncertainty for a Level of Confidence of 95% ($U=2Uc(y)$): $\pm 0.84\text{dB}$
Conducted Spurious Emission
Measuring Uncertainty for a Level of Confidence of 95% ($U=2Uc(y)$): $\pm 2.65\text{ dB}$
Occupied Bandwidth
Measuring Uncertainty for a Level of Confidence of 95% ($U=2Uc(y)$): 3.3%
Temp. / Humidity
Measuring Uncertainty for a Level of Confidence of 95% ($U=2Uc(y)$): $\pm 0.82^\circ\text{C}/ \pm 3\%$
DC Voltage
Measuring Uncertainty for a Level of Confidence of 95% ($U=2Uc(y)$): $\pm 0.3\%$

7. TEST RESULT

7.1. Summary

Product Name: 8.0" Touch Screen Controller, 5.7" Touch Screen Controller

FCC Classification: (DTS) Digital Transmission System

FCC Part Section(s)	IC Standard	Test Description	Test Limit	Test Condition	Test Result	Reference
15.247(a)(2)	RSS-247 5.2 (a)	6dB Bandwidth	$\geq 500\text{kHz}$	Conducted	N/A	N/A
15.247(b)(3)	RSS-247 5.4 (d)	Output Power	$\leq 30.00\text{dBm}$		Pass	Section 7.3
15.247(e)	RSS-247 5.2 (b)	Power Spectral Density	$\leq 8.00\text{dBm}/3\text{kHz}$		N/A	N/A
15.247(d)	RSS-247 5.5	Out-of-Band Emissions	Conducted $\geq 20\text{dBc}$		N/A	N/A
15.205 15.209	RSS-247 5.5	Spurious Emission	< FCC 15.209 limits < RSS-Gen Table 4	Radiated	Pass	Section 7.6
15.205 15.209	RSS-247 5.5	Band Edge Measurement	$\leq 74\text{dBuV}/\text{m}(\text{Peak})$ $\leq 54\text{dBuV}/\text{m}(\text{Average})$		Pass	Section 7.7
15.207	RSS-Gen 8.8	AC Conducted Emissions 150kHz - 30MHz	< FCC 15.207 limits < RSS-Gen Table 3	Line Conducted	N/A	Section 7.8

Notes:

- 1) Determining compliance is based on the test results met the regulation limits or requirements declared by clients, and the test results don't take into account the value of measurement uncertainty.
- 2) All modes of operation and data rates were investigated. For radiated emission test, every axis (X, Y, Z) was also verified when applicable. The test results shown in the following sections represent the worst case emissions.
- 3) The analyzer plots shown in this section were all taken with a correction table loaded into the analyzer. The correction table was used to account for the losses of the cables and attenuators used as part of the system to connect the EUT to the analyzer at all frequencies of interest.
- 4) All antenna port conducted emissions testing was performed on a test bench with the antenna port of the EUT connected to the spectrum analyzer through calibrated cables and attenuators.

7.2. 6dB Bandwidth Measurement

7.2.1. Test Limit

The minimum 6dB bandwidth shall be at least 500 kHz.

7.2.2. Test Procedure used

ANSI C63.10-2013 - Section 11.8.2 Option 2

7.2.3. Test Setting

1. The Spectrum's automatic bandwidth measurement capability was used to perform the 6dB bandwidth measurement. The "X" dB bandwidth parameter was set to $X = 6$. The bandwidth measurement was not influenced by any intermediate power nulls in the fundamental emission.
2. Set RBW = 100 kHz
3. $VBW \geq 3 \times RBW$
4. Detector = Peak
5. Trace mode = max hold
6. Sweep = auto couple
7. Allow the trace was allowed to stabilize

7.2.4. Test Setup

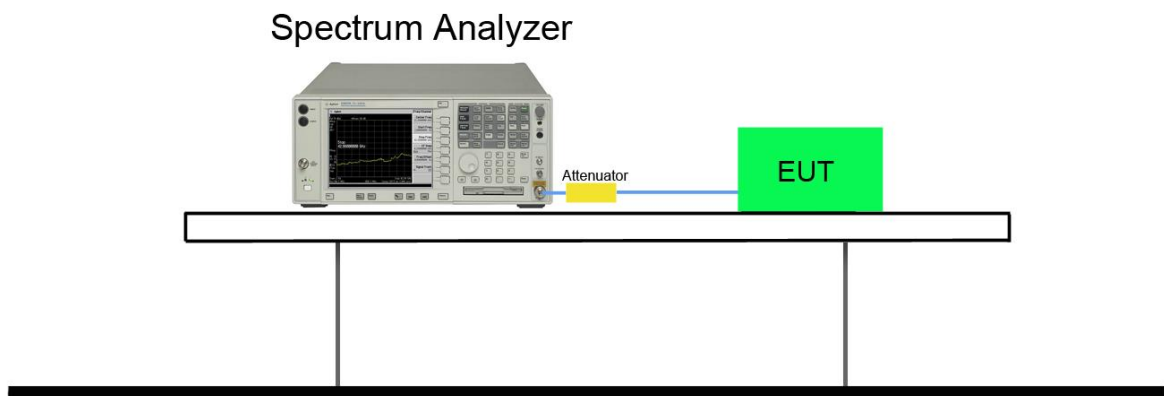

7.2.5. Test Result

Note: Reference

FCC Original Report Grant Date: 09/11/2020, FCC ID: 2AGRR-LBEE5ZZ1PJ

IC Original Report Grant Date: 09/14/2020, IC: 8110A-LBEE5ZZ1PJ

7.3. Output Power Measurement

7.3.1. Test Limit

The maximum out power shall be less 1 Watt (30dBm).

7.3.2. Test Procedure Used

ANSI C63.10-2013 - Section 11.9.1.3

7.3.3. Test Setting

Peak Power Measurement

The maximum peak conducted output power may be measured using a broadband peak RF power meter. The power meter shall have a video bandwidth that is greater than or equal to the DTS bandwidth and shall utilize a fast-responding diode detector.

Average Power Measurement

Average power measurements were performed only when the EUT was transmitting at its maximum power control level using a broadband power meter with a pulse sensor. The power meter implemented triggering and gating capabilities which were set up such that power measurements were recorded only during the ON time of the transmitter. The trace was averaged over 100 traces to obtain the final measured average power.

7.3.4. Test Setup



7.3.5. Test Result of Output Power

Test Mode	Channel No.	Frequency (MHz)	Peak Power (dBm)	EIRP (dBm)	Peak Power Limit (dBm)	EIRP Limit (dBm)
LE	00	2402	4.865	7.015	< 30	< 36
LE	19	2440	4.915	7.065	< 30	< 36
LE	39	2480	4.820	6.970	< 30	< 36

Note1: Output power = Reading value on power meter + cable loss.

Note2: Antenna Gain 2.15dBi.

7.4. Power Spectral Density Measurement

7.4.1. Test Limit

The maximum permissible power spectral density is 8dBm in any 3 kHz band.

7.4.2. Test Procedure Used

ANSI C63.10-2013 - Section 11.10.2

7.4.3. Test Setting

This procedure shall be used if maximum peak conducted output power was used to demonstrate compliance, and is optional if the maximum conducted (average) output power was used to demonstrate compliance.

- a) Set analyzer center frequency to DTS channel center frequency.
- b) Set the span to 1.5 times the DTS bandwidth.
- c) Set the RBW to: 3 kHz.
- d) Set the VBW $\geq 3^*$ RBW.
- e) Detector = peak.
- f) Sweep time = auto couple.
- g) Trace mode = max hold.
- h) Allow trace to fully stabilize.
- i) Use the peak marker function to determine the maximum amplitude level within the RBW.

7.4.4. Test Setup

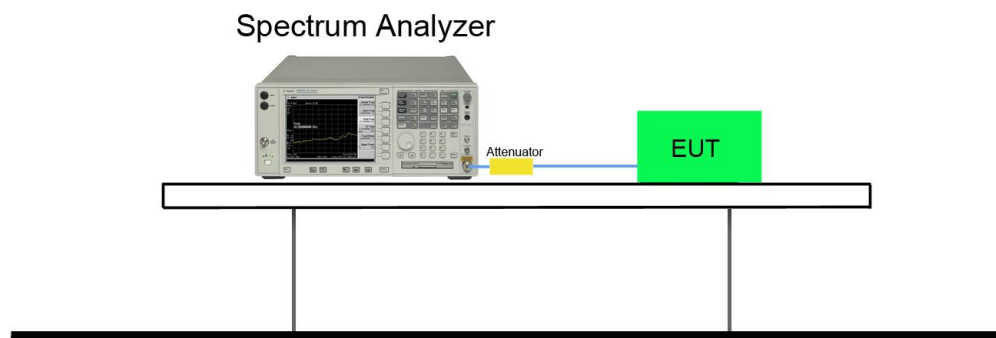

7.4.5. Test Result

Note: Reference

FCC Original Report Grant Date: 09/11/2020, FCC ID: 2AGRR-LBEE5ZZ1PJ

IC Original Report Grant Date: 09/14/2020, IC: 8110A-LBEE5ZZ1PJ

7.5. Out-of-Band Spurious Emissions Emissions Measurement

7.5.1. Test Limit

In any 100 kHz bandwidth outside the frequency band in which the spread spectrum or digitally modulated intentional radiator is operating, the radio frequency power that is produced by the intentional radiator shall be at least 20 dB below that in the 100 kHz bandwidth within the band that contains the highest level of the desired power, based on RF conducted measurement, provided the transmitter demonstrates compliance with the peak conducted power limits.

7.5.2. Test Procedure Used

ANSI C63.10-2013 - Section 11.11.2 & 11.11.3.

7.5.3. Test Settling

- (a) Set instrument center frequency to DTS channel center frequency
- (b) Set the span to ≥ 1.5 times the DTS bandwidth
- (c) Set the RBW = 100 kHz
- (d) Set the VBW $\geq 3 \times$ RBW
- (e) Detector = peak
- (f) Sweep time = auto couple
- (g) Trace mode = max hold
- (h) Allow trace to fully stabilize

7.5.4. Test Setup

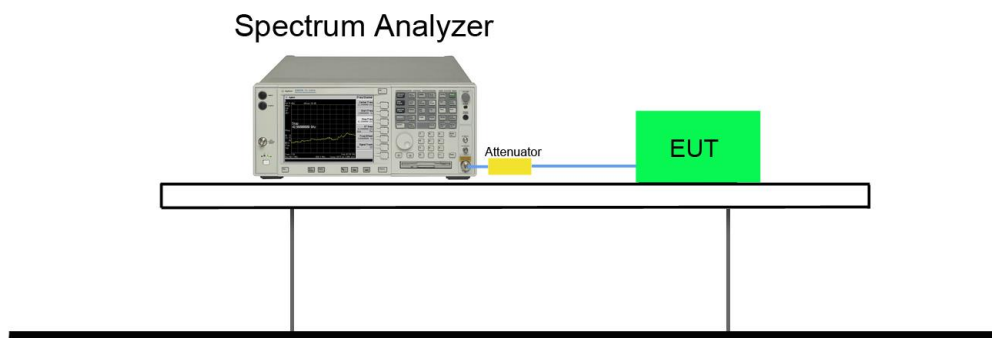

7.5.5. Test Result

Note: Reference

FCC Original Report Grant Date: 09/11/2020, FCC ID: 2AGRR-LBEE5ZZ1PJ

IC Original Report Grant Date: 09/14/2020, IC: 8110A-LBEE5ZZ1PJ

7.6. Radiated Spurious Emission Measurement

7.6.1. Test Limit

All out of band emissions appearing in a restricted band as specified in Section 15.205 of the Title 47 CFR must not exceed the limits shown in Table per Section 15.209.

FCC Part 15 Subpart C Paragraph 15.209		
Frequency [MHz]	Field Strength [V/m]	Measured Distance [Meters]
0.009 - 0.490	2400/F (kHz)	300
0.490 - 1.705	24000/F (kHz)	30
1.705 - 30	30	30
30 - 88	100	3
88 - 216	150	3
216 - 960	200	3
Above 960	500	3

7.6.2. Test Procedure Used

ANSI C63.10-2013 - Section 11.12.2

7.6.3. Test Setting

Peak Field Strength Measurements

1. Analyzer center frequency was set to the frequency of the radiated spurious emission of interest
2. RBW = as specified in Table 1
3. VBW = 3MHz
4. Detector = peak
5. Sweep time = auto couple
6. Trace mode = max hold
7. Trace was allowed to stabilize

Table 1 - RBW as a function of frequency

Frequency	RBW
9 ~ 150 kHz	200 ~ 300 Hz
0.15 ~ 30 MHz	9 ~ 10 kHz
30 ~ 1000 MHz	100 ~ 120 kHz
> 1000 MHz	1 MHz

Average Field Strength Measurements

1. Analyzer center frequency was set to the frequency of the radiated spurious emission of interest
2. RBW = 1MHz
3. VBW \geq 1/T
4. De As an alternative, the instrument may be set to linear detector mode. Ensure that video filtering is applied in linear voltage domain (rather than in a log or dB domain). Some instruments require linear display mode in order to accomplish this. Others have a setting for Average-VBW Type, which can be set to "Voltage" regardless of the display mode
5. Detector = Peak
6. Sweep time = auto
7. Trace mode = max hold
8. Allow max hold to run for at least 50 times (1/duty cycle) traces

7.6.4. Test Setup

9kHz ~ 30MHz Test Setup:

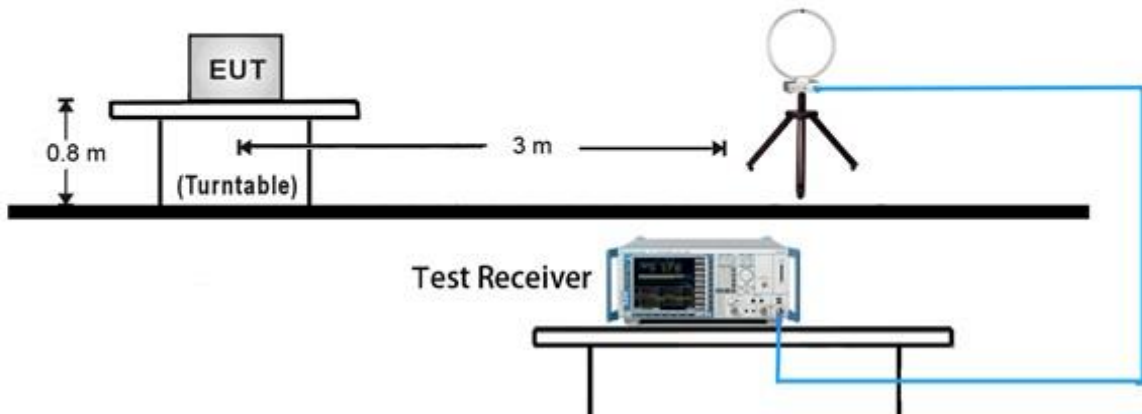

30MHz ~ 1GHz Test Setup:

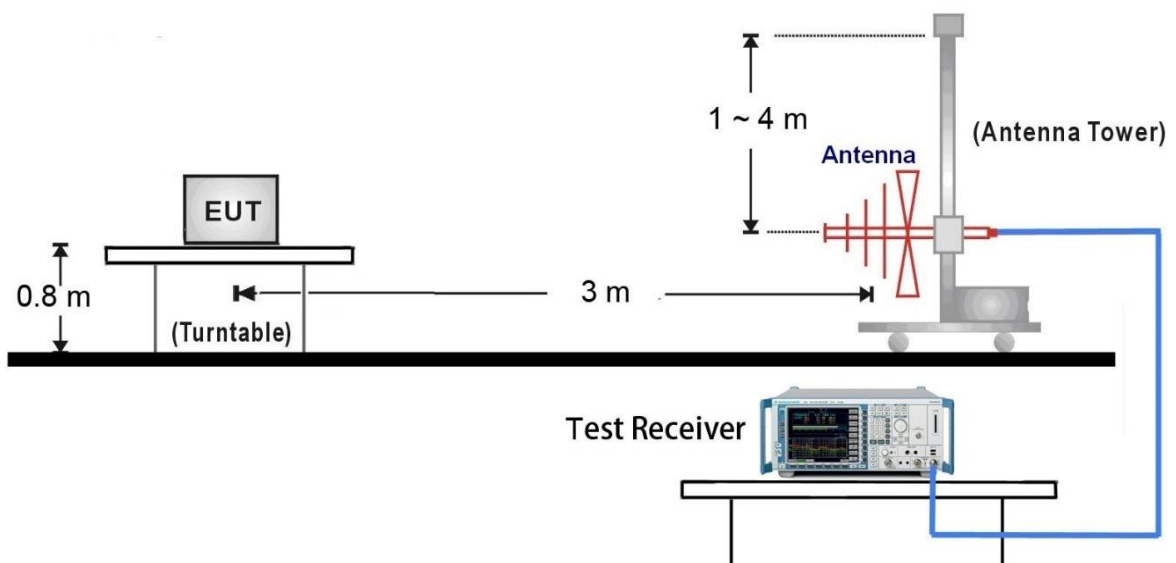

1GHz ~ 18GHz Test Setup:

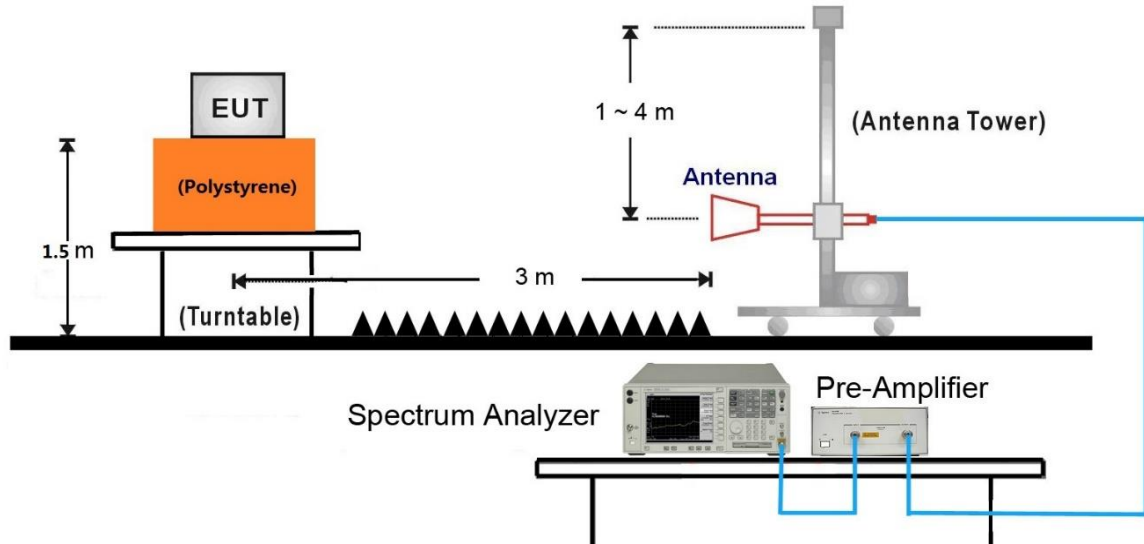

18GHz ~25GHz Test Setup:

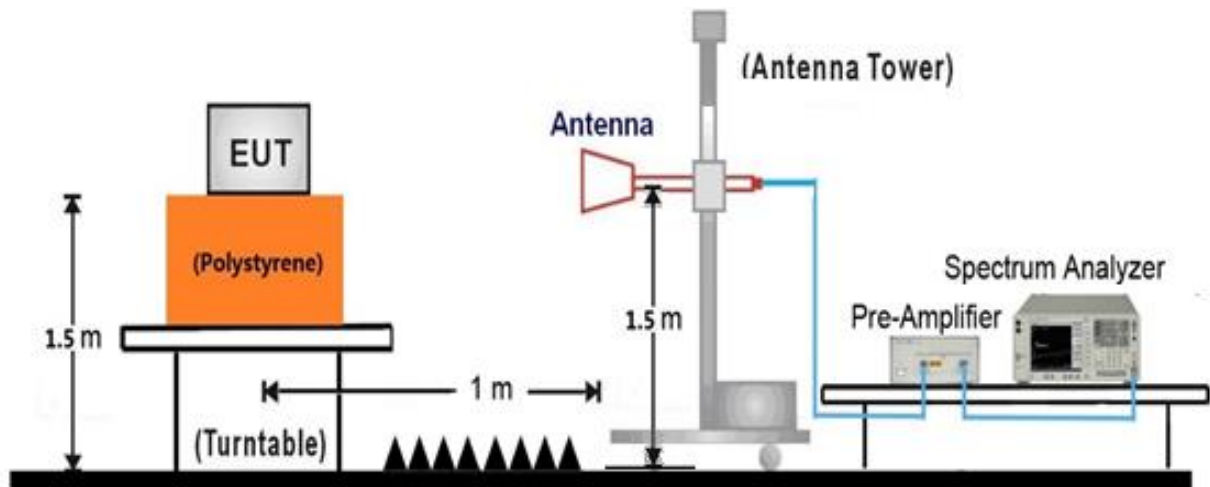

7.6.5. Test Result

EUT	Sonata XL	Date of Test	2020-08-06
Factor	VULB 9162	Temp. / Humidity	24°C /52%
Polarity	Horizontal	Site / Test Engineer	AC1 / Jay
Test Mode	BLE_TX_1Mbps_CH19	Test Voltage	AC 120V/60Hz

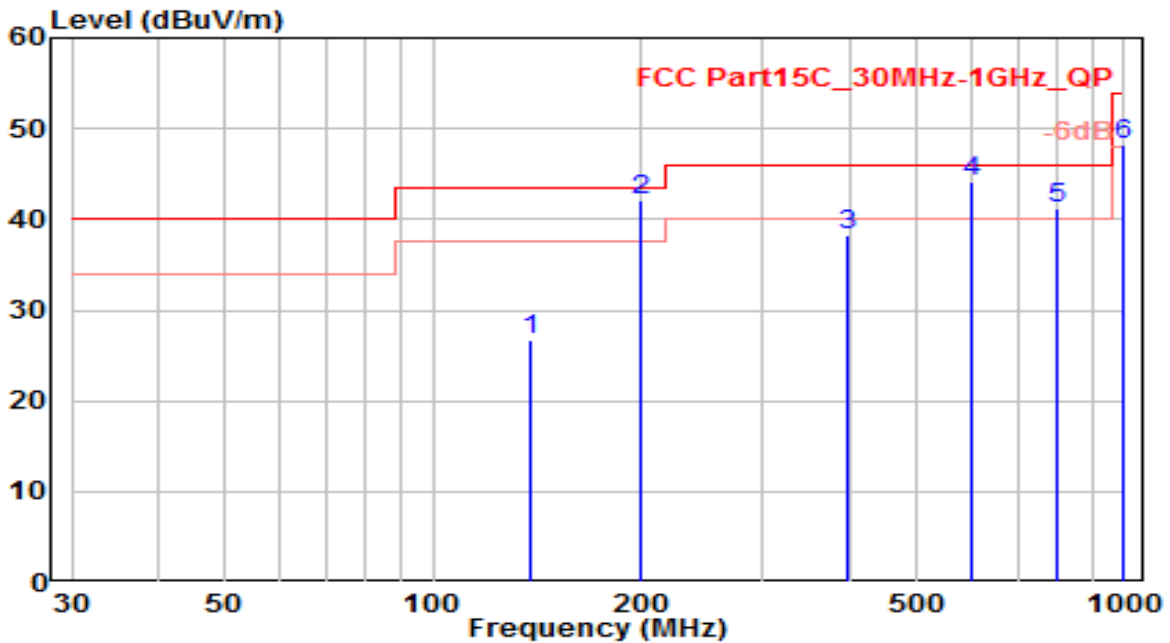

No	Frequency (MHz)	Reading (dBuV)	C.F (dB)	Measurement (dBuV/m)	Margin (dB)	Limit (dBuV/m)	Height (cm)	Angle (deg)	Remark (QP/PK/AV)
1	138.640	11.16	15.51	26.66	-16.84	43.50	100	110	QP
2	* 199.750	23.23	18.94	42.17	-1.33	43.50	100	25	QP
3	399.570	14.09	24.15	38.25	-7.75	46.00	100	225	QP
4	600.360	16.56	27.51	44.07	-1.93	46.00	100	320	QP
5	800.180	10.88	30.30	41.19	-4.81	46.00	100	235	QP
6	1000.000	15.73	32.55	48.28	-5.72	54.00	100	365	QP

Note:

- "*", means this data is the worst emission level.
- C.F (Correction Factor) = Antenna Factor (dB)+ Cable Loss (dB).
- Measurement (dBuV/m) = Reading(dBuV) + C.F (Correction Factor).
- The emission levels of other frequencies are very lower than the limit and not show in test report.

EUT	Sonata XL	Date of Test	2020-08-06
Factor	VULB 9162	Temp. / Humidity	24°C /52%
Polarity	Vertical	Site / Test Engineer	AC1 / Jay
Test Mode	BLE_TX_1Mbps_CH19	Test Voltage	AC 120V/60Hz

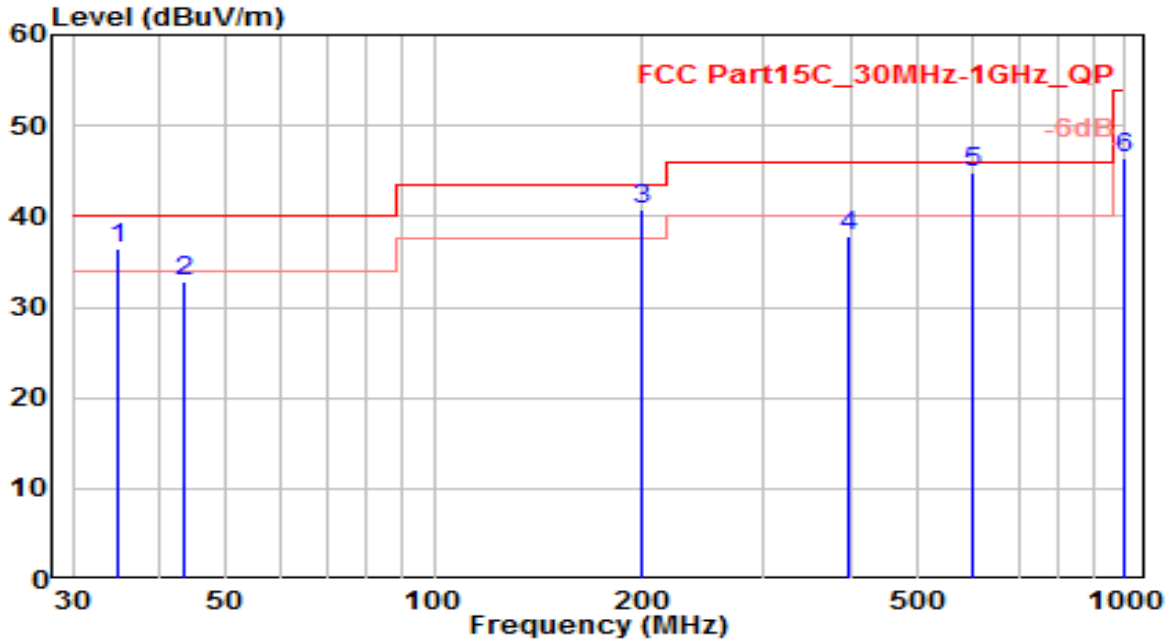

No	Frequency (MHz)	Reading (dBuV)	C.F (dB)	Measurement (dBuV/m)	Margin (dB)	Limit (dBuV/m)	Height (cm)	Angle (deg)	Remark (QP/PK/AV)
1	34.850	17.49	18.99	36.48	-3.52	40.00	100	220	QP
2	43.580	11.59	21.19	32.78	-7.22	40.00	100	320	QP
3	199.750	21.91	18.94	40.85	-2.65	43.50	100	55	QP
4	399.570	13.60	24.15	37.75	-8.25	46.00	100	220	QP
5	* 600.360	17.30	27.51	44.81	-1.19	46.00	100	45	QP
6	1000.000	13.90	32.55	46.45	-7.55	54.00	100	250	QP

Note:

- " *", means this data is the worst emission level.
- C.F (Correction Factor) = Antenna Factor (dB)+ Cable Loss (dB).
- Measurement (dBuV/m) = Reading(dBuV) + C.F (Correction Factor).
- The emission levels of other frequencies are very lower than the limit and not show in test report.

EUT	Opus XL	Date of Test	2020-08-06
Factor	VULB 9162	Temp. / Humidity	24°C /52%
Polarity	Horizontal	Site / Test Engineer	AC1 / Jay
Test Mode	BLE_TX_1Mbps_CH19	Test Voltage	AC 120V/60Hz

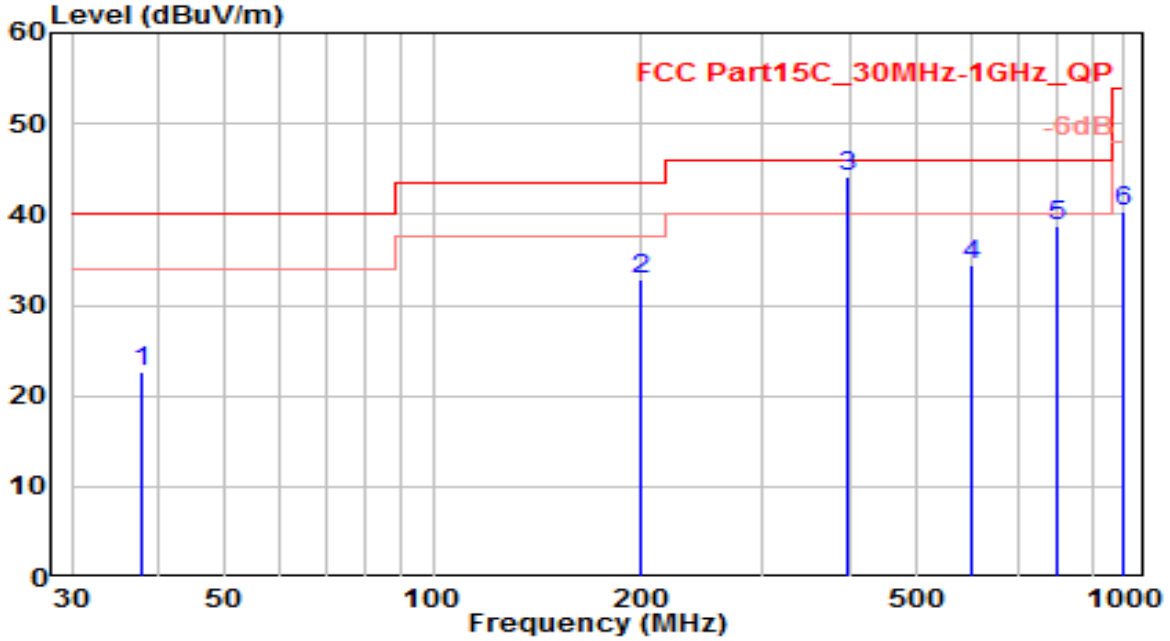

No	Frequency (MHz)	Reading (dBuV)	C.F (dB)	Measurement (dBuV/m)	Margin (dB)	Limit (dBuV/m)	Height (cm)	Angle (deg)	Remark (QP/PK/AV)
1	37.760	2.77	19.93	22.69	-17.31	40.00	100	110	QP
2	199.750	13.81	18.94	32.75	-10.75	43.50	100	120	QP
3	* 399.570	20.02	24.15	44.18	-1.82	46.00	100	125	QP
4	600.360	6.85	27.51	34.36	-11.64	46.00	100	220	QP
5	800.180	8.31	30.30	38.62	-7.38	46.00	100	365	QP
6	1000.000	7.65	32.55	40.20	-13.80	54.00	100	30	QP

Note:

- "*", means this data is the worst emission level.
- C.F (Correction Factor) = Antenna Factor (dB)+ Cable Loss (dB).
- Measurement (dBuV/m) = Reading(dBuV) + C.F (Correction Factor).
- The emission levels of other frequencies are very lower than the limit and not show in test report.

EUT	Opus XL	Date of Test	2020-08-06
Factor	VULB 9162	Temp. / Humidity	24°C /52%
Polarity	Vertical	Site / Test Engineer	AC1 / Jay
Test Mode	BLE_TX_1Mbps_CH19	Test Voltage	AC 120V/60Hz

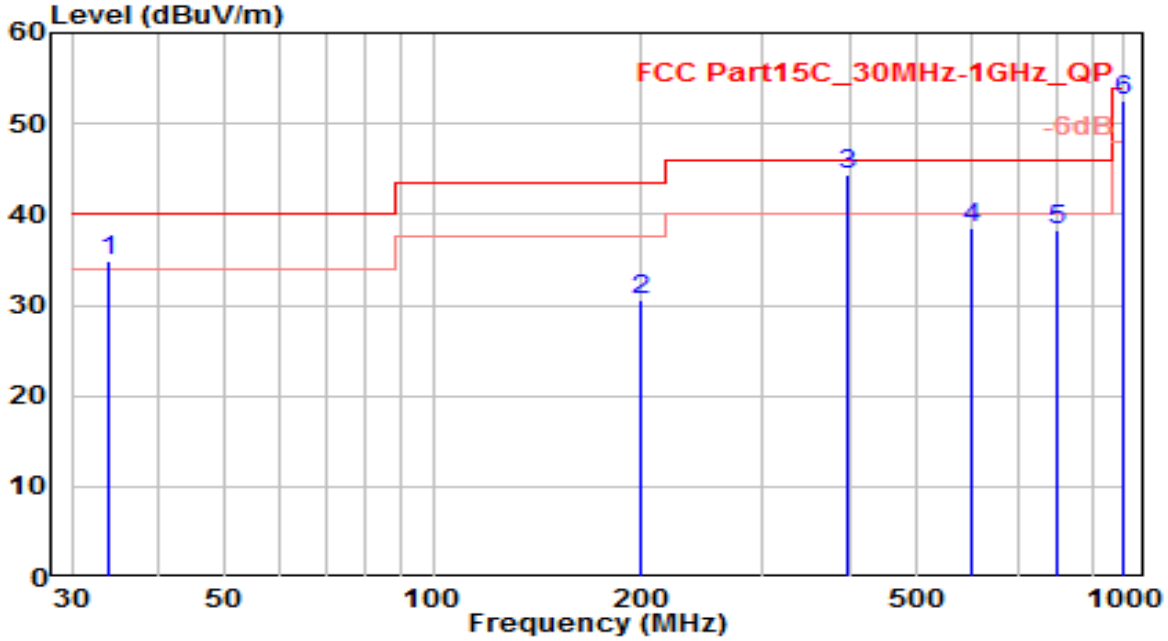

No	Frequency (MHz)	Reading (dBuV)	C.F (dB)	Measurement (dBuV/m)	Margin (dB)	Limit (dBuV/m)	Height (cm)	Angle (deg)	Remark (QP/PK/AV)
1	33.880	16.02	18.79	34.82	-5.18	40.00	100	5	QP
2	199.750	11.55	18.94	30.49	-13.01	43.50	100	30	QP
3	* 399.570	20.29	24.15	44.45	-1.55	46.00	100	65	QP
4	600.360	11.02	27.51	38.53	-7.47	46.00	100	210	QP
5	800.180	7.96	30.30	38.26	-7.74	46.00	100	220	QP
6	1000.000	19.87	32.55	52.42	-1.58	54.00	100	15	QP

Note:

- "*", means this data is the worst emission level.
- C.F (Correction Factor) = Antenna Factor (dB)+ Cable Loss (dB).
- Measurement (dBuV/m) = Reading(dBuV) + C.F (Correction Factor).
- The emission levels of other frequencies are very lower than the limit and not show in test report.

EUT	Sonata XL	Date of Test	2020-08-01
Factor	BBHA 9120D & BBHA 9170	Temp. / Humidity	26°C /55%
Polarity	Horizontal	Site / Test Engineer	AC1 / Peter
Test Mode	BLE_TX_1Mbps_CH0	Test Voltage	AC 120V/60Hz

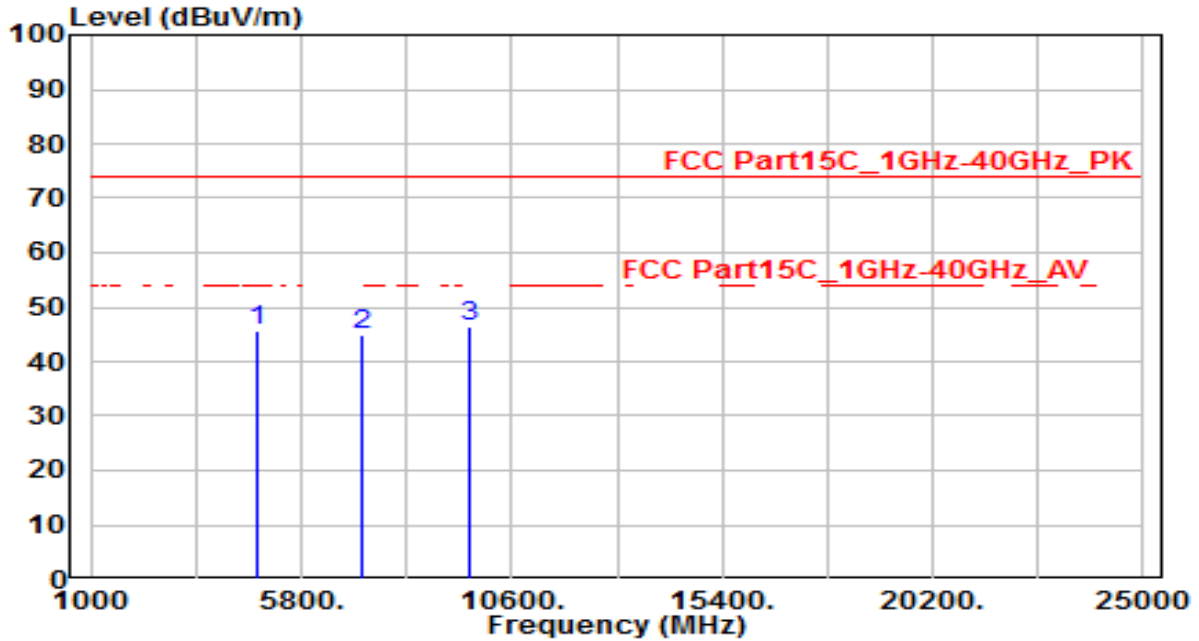

No	Frequency (MHz)	Reading (dBuV)	C.F (dB)	Measurement (dBuV/m)	Margin (dB)	Limit (dBuV/m)	Height (cm)	Angle (deg)	Remark (QP/PK/AV)
1	4804.000	42.29	3.28	45.57	-28.43	74.00	150	400	Peak
2	7206.000	34.12	10.88	45.00	-29.00	74.00	150	400	Peak
3	* 9608.000	31.87	14.62	46.49	-27.51	74.00	150	400	Peak

Note:

1. " *", means this data is the worst emission level.
2. C.F (Correction Factor) = Antenna Factor (dB)+ Cable Loss (dB) – Preamplifier(dB).
3. Measurement (dBuV/m) = Reading(dBuV) + C.F (Correction Factor).
4. The emission levels of other frequencies are very lower than the limit and not show in test report.

EUT	Sonata XL	Date of Test	2020-08-01
Factor	BBHA 9120D & BBHA 9170	Temp. / Humidity	26°C /55%
Polarity	Vertical	Site / Test Engineer	AC1 / Peter
Test Mode	BLE_TX_1Mbps_CH0	Test Voltage	AC 120V/60Hz

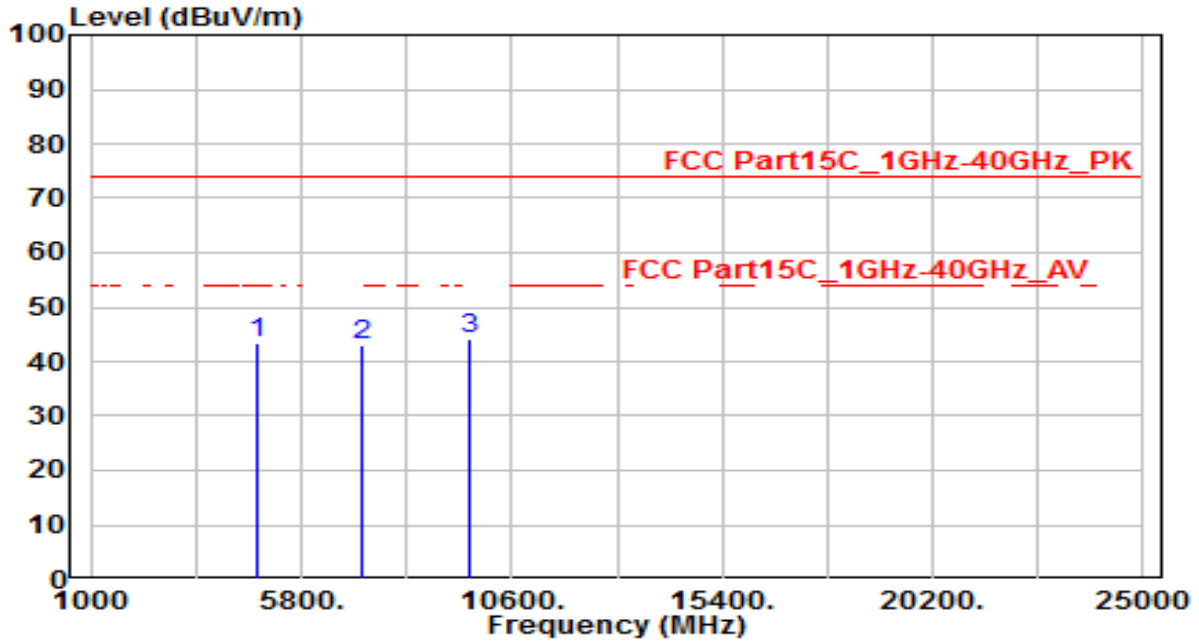

No	Frequency (MHz)	Reading (dBuV)	C.F (dB)	Measurement (dBuV/m)	Margin (dB)	Limit (dBuV/m)	Height (cm)	Angle (deg)	Remark (QP/PK/AV)
1	4804.000	40.26	3.28	43.54	-30.46	74.00	150	400	Peak
2	7206.000	32.20	10.88	43.08	-30.92	74.00	150	400	Peak
3	* 9608.000	29.62	14.62	44.24	-29.76	74.00	150	400	Peak

Note:

1. " *", means this data is the worst emission level.
2. C.F (Correction Factor) = Antenna Factor (dB)+ Cable Loss (dB) – Preamplifier(dB).
3. Measurement (dBuV/m) = Reading(dBuV) + C.F (Correction Factor).
4. The emission levels of other frequencies are very lower than the limit and not show in test report.

EUT	Sonata XL	Date of Test	2020-08-01
Factor	BBHA 9120D & BBHA 9170	Temp. / Humidity	26°C /55%
Polarity	Horizontal	Site / Test Engineer	AC1 / Peter
Test Mode	BLE_TX_1Mbps_CH19	Test Voltage	AC 120V/60Hz

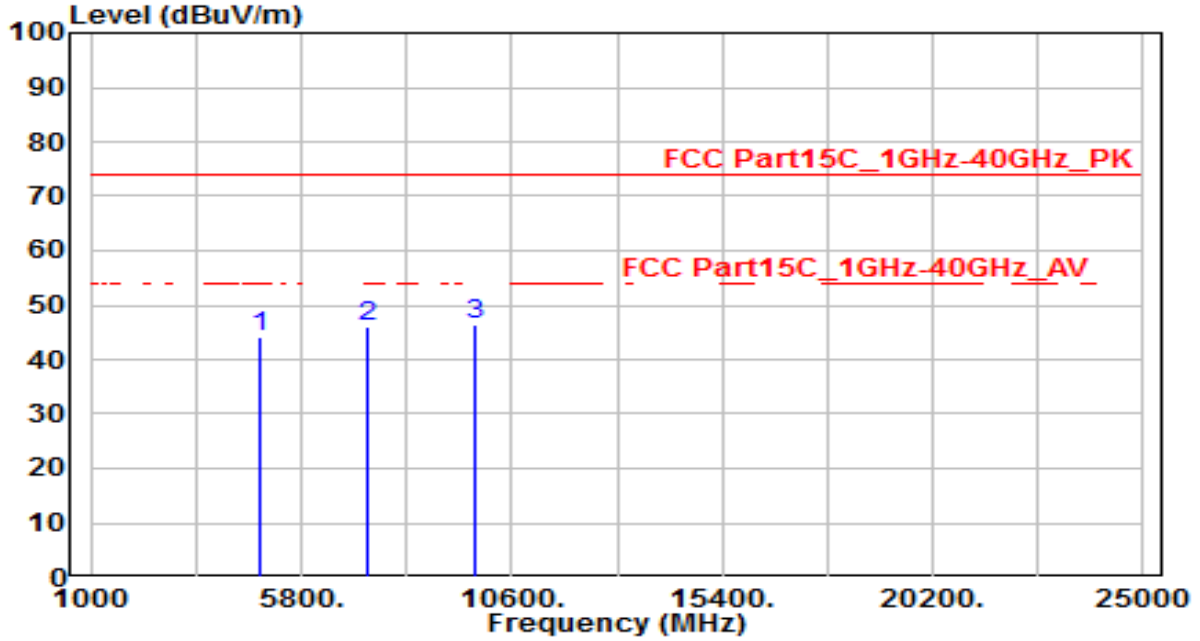

No	Frequency (MHz)	Reading (dBuV)	C.F (dB)	Measurement (dBuV/m)	Margin (dB)	Limit (dBuV/m)	Height (cm)	Angle (deg)	Remark (QP/PK/AV)
1	4880.000	40.60	3.46	44.06	-29.94	74.00	150	400	Peak
2	7320.000	34.92	11.21	46.13	-27.87	74.00	150	400	Peak
3	* 9760.000	31.41	14.91	46.32	-27.68	74.00	150	400	Peak

Note:

1. " *", means this data is the worst emission level.
2. C.F (Correction Factor) = Antenna Factor (dB)+ Cable Loss (dB) – Preamplifier(dB).
3. Measurement (dBuV/m) = Reading(dBuV) + C.F (Correction Factor).
4. The emission levels of other frequencies are very lower than the limit and not show in test report.

EUT	Sonata XL	Date of Test	2020-08-01
Factor	BBHA 9120D & BBHA 9170	Temp. / Humidity	26°C /55%
Polarity	Vertical	Site / Test Engineer	AC1 / Peter
Test Mode	BLE_TX_1Mbps_CH19	Test Voltage	AC 120V/60Hz

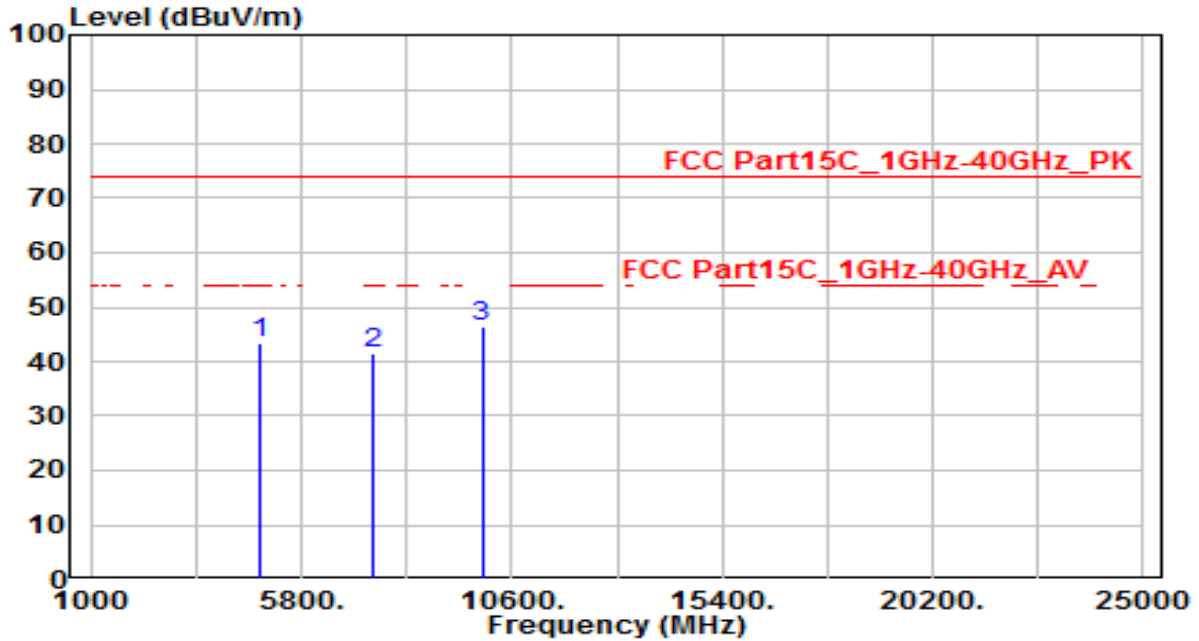

No	Frequency (MHz)	Reading (dBuV)	C.F (dB)	Measurement (dBuV/m)	Margin (dB)	Limit (dBuV/m)	Height (cm)	Angle (deg)	Remark (QP/PK/AV)
1	4880.000	39.95	3.46	43.41	-30.59	74.00	150	400	Peak
2	7440.000	29.99	11.55	41.54	-32.46	74.00	150	400	Peak
3	* 9920.000	31.25	15.21	46.46	-27.54	74.00	150	400	Peak

Note:

1. " *" , means this data is the worst emission level.
2. C.F (Correction Factor) = Antenna Factor (dB)+ Cable Loss (dB) – Preamplifier(dB).
3. Measurement (dBuV/m) = Reading(dBuV) + C.F (Correction Factor).
4. The emission levels of other frequencies are very lower than the limit and not show in test report.

EUT	Sonata XL	Date of Test	2020-08-01
Factor	BBHA 9120D & BBHA 9170	Temp. / Humidity	26°C /55%
Polarity	Horizontal	Site / Test Engineer	AC1 / Peter
Test Mode	BLE_TX_1Mbps_CH39	Test Voltage	AC 120V/60Hz

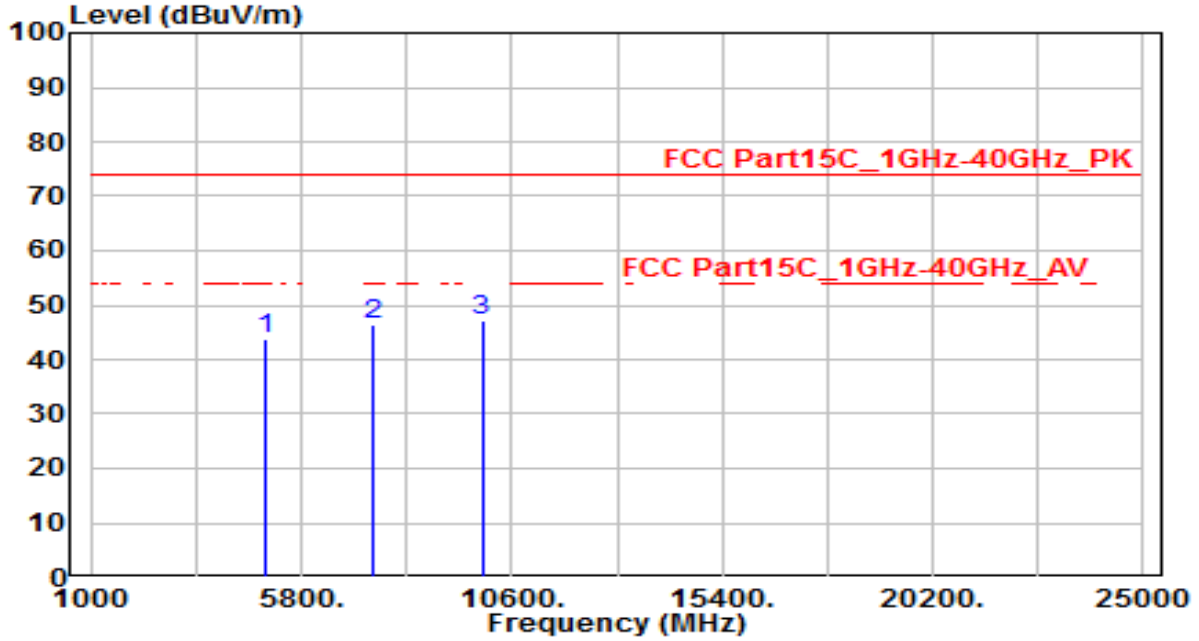

No	Frequency (MHz)	Reading (dBuV)	C.F (dB)	Measurement (dBuV/m)	Margin (dB)	Limit (dBuV/m)	Height (cm)	Angle (deg)	Remark (QP/PK/AV)
1	4960.000	40.16	3.65	43.81	-30.19	74.00	150	400	Peak
2	7440.000	34.74	11.55	46.29	-27.71	74.00	150	400	Peak
3	* 9920.000	31.82	15.21	47.03	-26.97	74.00	150	400	Peak

Note:

1. " *", means this data is the worst emission level.
2. C.F (Correction Factor) = Antenna Factor (dB)+ Cable Loss (dB) – Preamplifier(dB).
3. Measurement (dBuV/m) = Reading(dBuV) + C.F (Correction Factor).
4. The emission levels of other frequencies are very lower than the limit and not show in test report.

EUT	Sonata XL	Date of Test	2020-08-01
Factor	BBHA 9120D & BBHA 9170	Temp. / Humidity	26°C /55%
Polarity	Vertical	Site / Test Engineer	AC1 / Peter
Test Mode	BLE_TX_1Mbps_CH39	Test Voltage	AC 120V/60Hz

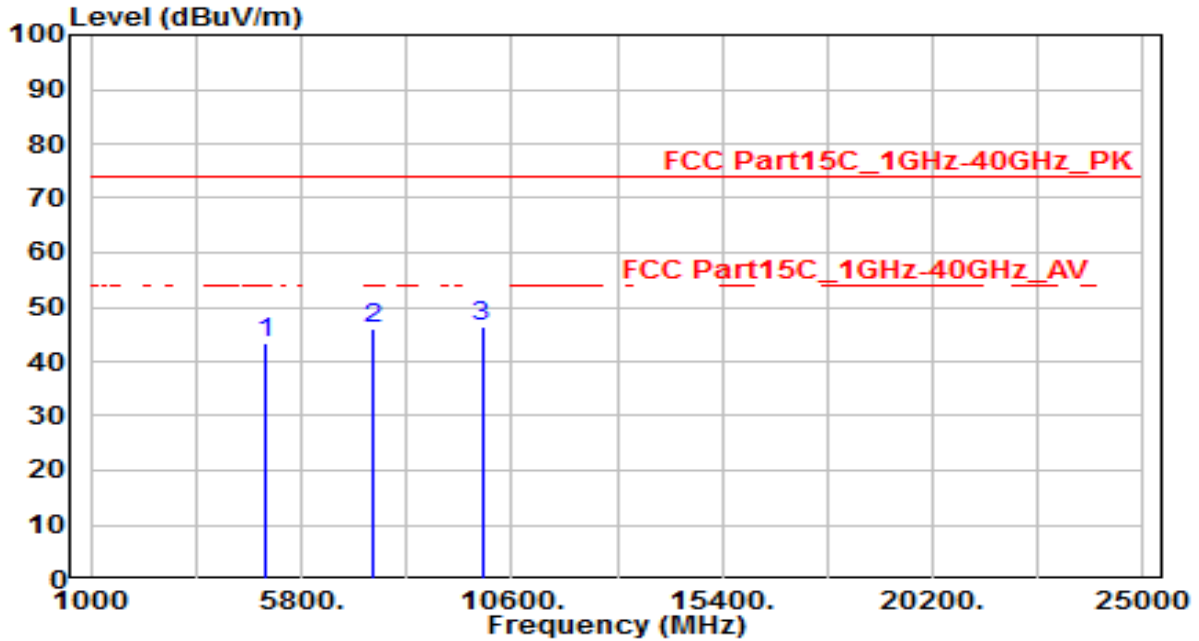

No	Frequency (MHz)	Reading (dBuV)	C.F (dB)	Measurement (dBuV/m)	Margin (dB)	Limit (dBuV/m)	Height (cm)	Angle (deg)	Remark (QP/PK/AV)
1	4960.000	39.88	3.65	43.53	-30.47	74.00	150	400	Peak
2	7440.000	34.39	11.55	45.94	-28.06	74.00	150	400	Peak
3	* 9920.000	31.32	15.21	46.53	-27.47	74.00	150	400	Peak

Note:

1. " *", means this data is the worst emission level.
2. C.F (Correction Factor) = Antenna Factor (dB)+ Cable Loss (dB) – Preamplifier(dB).
3. Measurement (dBuV/m) = Reading(dBuV) + C.F (Correction Factor).
4. The emission levels of other frequencies are very lower than the limit and not show in test report.

EUT	Opus XL	Date of Test	2020-08-01
Factor	BBHA 9120D & BBHA 9170	Temp. / Humidity	26°C /55%
Polarity	Horizontal	Site / Test Engineer	AC1 / Peter
Test Mode	BLE_TX_1Mbps_CH0	Test Voltage	AC 120V/60Hz

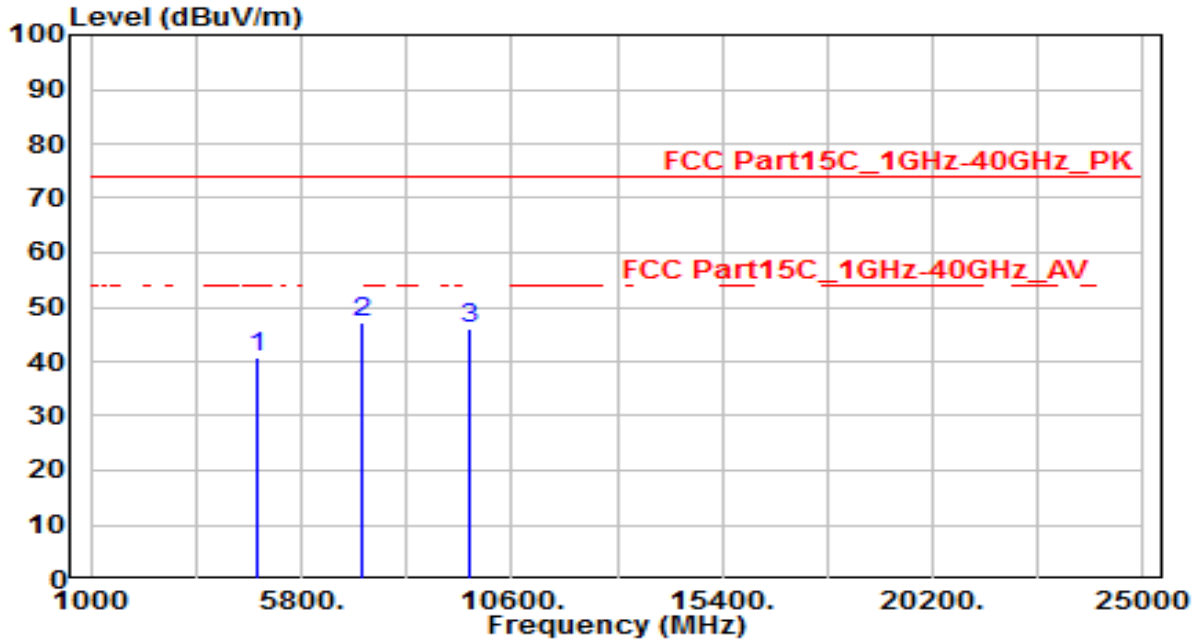

No	Frequency (MHz)	Reading (dBuV)	C.F (dB)	Measurement (dBuV/m)	Margin (dB)	Limit (dBuV/m)	Height (cm)	Angle (deg)	Remark (QP/PK/AV)
1	4804.000	37.41	3.28	40.69	-33.31	74.00	150	400	Peak
2	* 7206.000	36.17	10.88	47.05	-26.95	74.00	150	400	Peak
3	9608.000	31.51	14.62	46.13	-27.87	74.00	150	400	Peak

Note:

1. " *", means this data is the worst emission level.
2. C.F (Correction Factor) = Antenna Factor (dB)+ Cable Loss (dB) – Preamplifier(dB).
3. Measurement (dBuV/m) = Reading(dBuV) + C.F (Correction Factor).
4. The emission levels of other frequencies are very lower than the limit and not show in test report.

EUT	Opus XL	Date of Test	2020-08-01
Factor	BBHA 9120D & BBHA 9170	Temp. / Humidity	26°C /55%
Polarity	Vertical	Site / Test Engineer	AC1 / Peter
Test Mode	BLE_TX_1Mbps_CH0	Test Voltage	AC 120V/60Hz

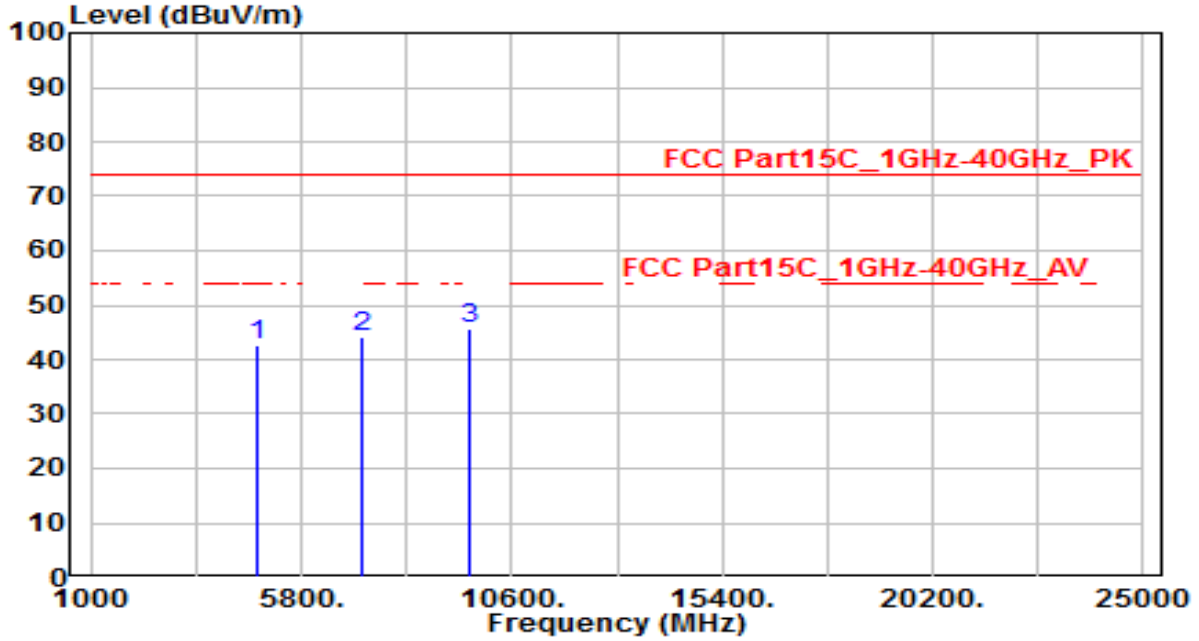

No	Frequency (MHz)	Reading (dBuV)	C.F (dB)	Measurement (dBuV/m)	Margin (dB)	Limit (dBuV/m)	Height (cm)	Angle (deg)	Remark (QP/PK/AV)
1	4804.000	39.20	3.28	42.48	-31.52	74.00	150	400	Peak
2	7206.000	33.28	10.88	44.16	-29.84	74.00	150	400	Peak
3	* 9608.000	30.87	14.62	45.49	-28.51	74.00	150	400	Peak

Note:

1. " *", means this data is the worst emission level.
2. C.F (Correction Factor) = Antenna Factor (dB)+ Cable Loss (dB) – Preamplifier(dB).
3. Measurement (dBuV/m) = Reading(dBuV) + C.F (Correction Factor).
4. The emission levels of other frequencies are very lower than the limit and not show in test report.

EUT	Opus XL	Date of Test	2020-08-01
Factor	BBHA 9120D & BBHA 9170	Temp. / Humidity	26°C /55%
Polarity	Horizontal	Site / Test Engineer	AC1 / Peter
Test Mode	BLE_TX_1Mbps_CH19	Test Voltage	AC 120V/60Hz

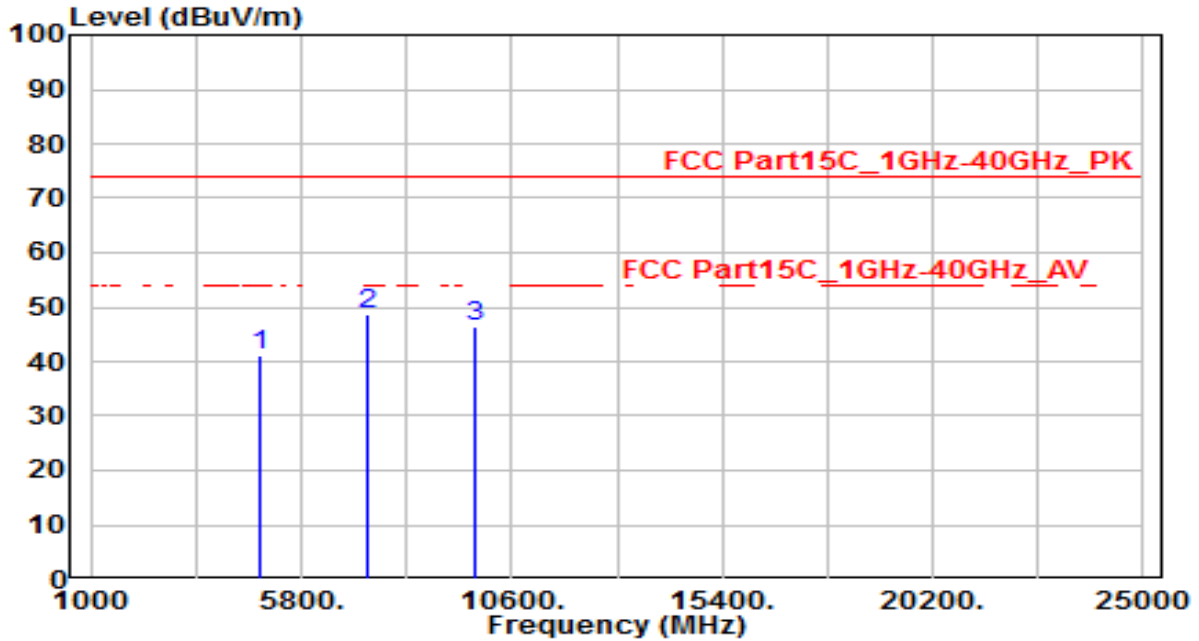

No	Frequency (MHz)	Reading (dBuV)	C.F (dB)	Measurement (dBuV/m)	Margin (dB)	Limit (dBuV/m)	Height (cm)	Angle (deg)	Remark (QP/PK/AV)
1	4880.000	37.69	3.46	41.15	-32.85	74.00	150	400	Peak
2	* 7320.000	37.43	11.21	48.64	-25.36	74.00	150	400	Peak
3	9760.000	31.45	14.91	46.36	-27.64	74.00	150	400	Peak

Note:

1. " *", means this data is the worst emission level.
2. C.F (Correction Factor) = Antenna Factor (dB)+ Cable Loss (dB) – Preamplifier(dB).
3. Measurement (dBuV/m) = Reading(dBuV) + C.F (Correction Factor).
4. The emission levels of other frequencies are very lower than the limit and not show in test report.

EUT	Opus XL	Date of Test	2020-08-01
Factor	BBHA 9120D & BBHA 9170	Temp. / Humidity	26°C /55%
Polarity	Vertical	Site / Test Engineer	AC1 / Peter
Test Mode	BLE_TX_1Mbps_CH19	Test Voltage	AC 120V/60Hz

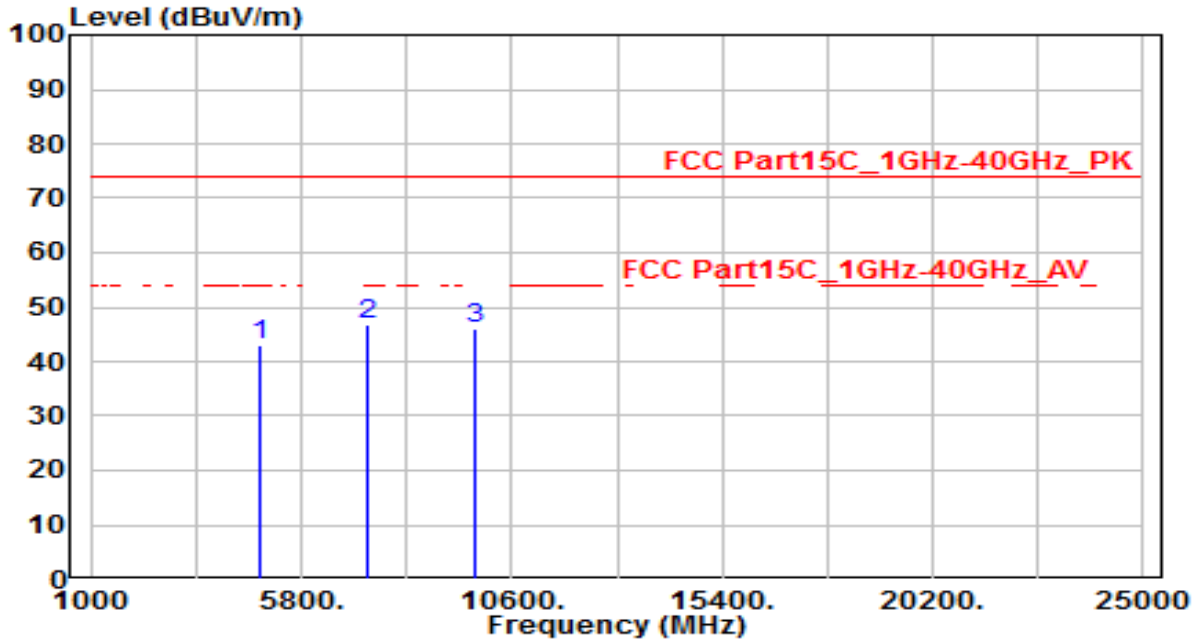

No	Frequency (MHz)	Reading (dBuV)	C.F (dB)	Measurement (dBuV/m)	Margin (dB)	Limit (dBuV/m)	Height (cm)	Angle (deg)	Remark (QP/PK/AV)
1	4880.000	39.62	3.46	43.08	-30.92	74.00	150	400	Peak
2	* 7320.000	35.66	11.21	46.87	-27.13	74.00	150	400	Peak
3	9760.000	30.98	14.91	45.89	-28.11	74.00	150	400	Peak

Note:

- "*" means this data is the worst emission level.
- C.F (Correction Factor) = Antenna Factor (dB)+ Cable Loss (dB) – Preamplifier(dB).
- Measurement (dBuV/m) = Reading(dBuV) + C.F (Correction Factor).
- The emission levels of other frequencies are very lower than the limit and not show in test report.

EUT	Opus XL	Date of Test	2020-08-01
Factor	BBHA 9120D & BBHA 9170	Temp. / Humidity	26°C /55%
Polarity	Horizontal	Site / Test Engineer	AC1 / Peter
Test Mode	BLE_TX_1Mbps_CH39	Test Voltage	AC 120V/60Hz

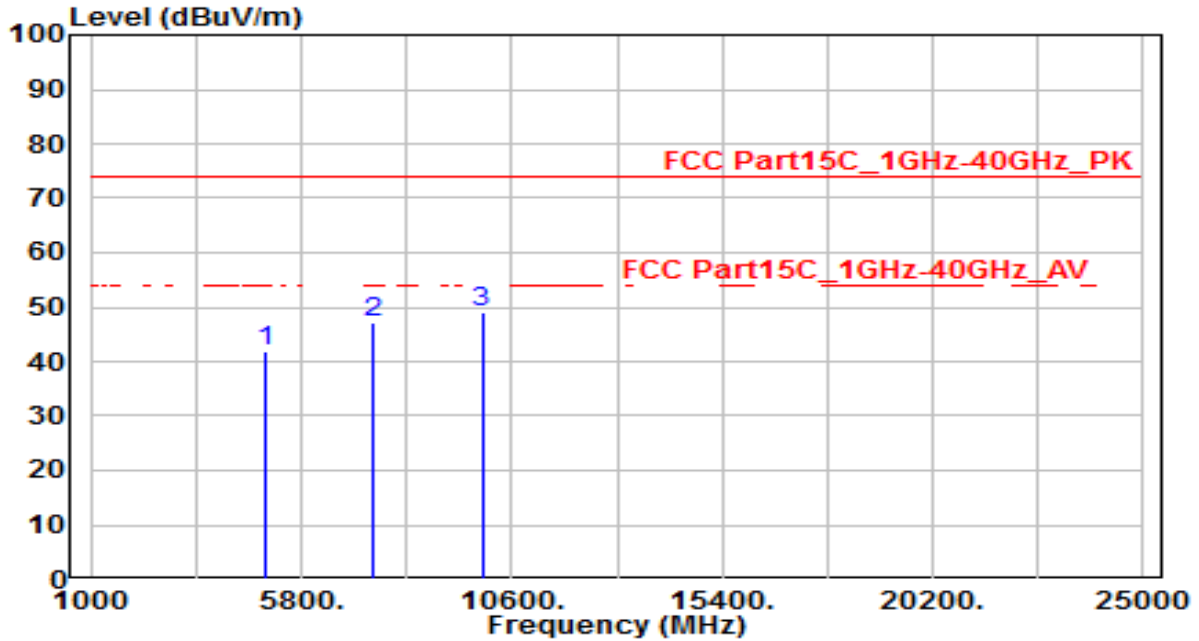

No	Frequency (MHz)	Reading (dBuV)	C.F (dB)	Measurement (dBuV/m)	Margin (dB)	Limit (dBuV/m)	Height (cm)	Angle (deg)	Remark (QP/PK/AV)
1	4960.000	38.10	3.65	41.75	-32.25	74.00	150	400	Peak
2	7440.000	35.60	11.55	47.15	-26.85	74.00	150	400	Peak
3	* 9920.000	33.74	15.21	48.95	-25.05	74.00	150	400	Peak

Note:

1. " *", means this data is the worst emission level.
2. C.F (Correction Factor) = Antenna Factor (dB)+ Cable Loss (dB) – Preamplifier(dB).
3. Measurement (dBuV/m) = Reading(dBuV) + C.F (Correction Factor).
4. The emission levels of other frequencies are very lower than the limit and not show in test report.

EUT	Opus XL	Date of Test	2020-08-01
Factor	BBHA 9120D & BBHA 9170	Temp. / Humidity	26°C /55%
Polarity	Vertical	Site / Test Engineer	AC1 / Peter
Test Mode	BLE_TX_1Mbps_CH39	Test Voltage	AC 120V/60Hz

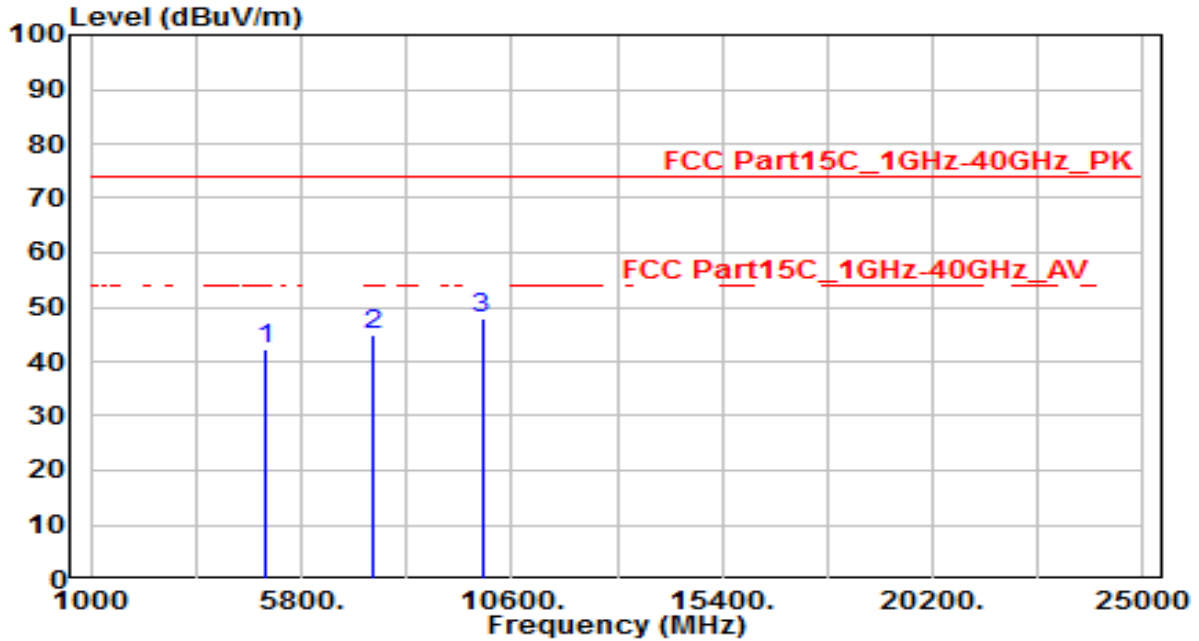

No	Frequency (MHz)	Reading (dBuV)	C.F (dB)	Measurement (dBuV/m)	Margin (dB)	Limit (dBuV/m)	Height (cm)	Angle (deg)	Remark (QP/PK/AV)
1	4960.000	38.75	3.65	42.40	-31.60	74.00	150	400	Peak
2	7440.000	33.21	11.55	44.76	-29.24	74.00	150	400	Peak
3	* 9920.000	32.85	15.21	48.06	-25.94	74.00	150	400	Peak

Note:

1. " *" , means this data is the worst emission level.
2. C.F (Correction Factor) = Antenna Factor (dB)+ Cable Loss (dB) – Preamplifier(dB).
3. Measurement (dBuV/m) = Reading(dBuV) + C.F (Correction Factor).
4. The emission levels of other frequencies are very lower than the limit and not show in test report.

7.7. Radiated Restricted Band Edge Measurement

7.7.1. Test Limit

All out of band emissions appearing in a restricted band as specified in Section 15.205 of the Title 47 CFR must not exceed the limits shown in Table per Section 15.209.

FCC Part 15 Subpart C Paragraph 15.209		
Frequency [MHz]	Field Strength [V/m]	Measured Distance [Meters]
0.009 - 0.490	2400/F (kHz)	300
0.490 - 1.705	24000/F (kHz)	30
1.705 – 30	30	30
30 – 88	100	3
88 – 216	150	3
216 – 960	200	3
Above 960	500	3

7.7.2. Test Procedure Used

ANSI C63.10-2013 - Section 11.12.1

7.7.3. Test Setting

Peak Field Strength Measurements

8. Analyzer center frequency was set to the frequency of the radiated spurious emission of interest
9. RBW = as specified in Table 1
10. VBW = 3 * RBW
11. Detector = peak
12. Sweep time = auto couple
13. Trace mode = max hold
14. Trace was allowed to stabilize

Table 1 - RBW as a function of frequency

Frequency	RBW
9 ~ 150 kHz	200 ~ 300 Hz
0.15 ~ 30 MHz	9 ~ 10 kHz
30 ~ 1000 MHz	100 ~ 120 kHz
> 1000 MHz	1 MHz

Average Field Strength Measurements

9. Analyzer center frequency was set to the frequency of the radiated spurious emission of interest
10. RBW = 1MHz
11. VBW $\geq 1/T$
12. De As an alternative, the instrument may be set to linear detector mode. Ensure that video filtering is applied in linear voltage domain (rather than in a log or dB domain). Some instruments require linear display mode in order to accomplish this. Others have a setting for Average-VBW Type, which can be set to "Voltage" regardless of the display mode
13. Detector = Peak
14. Sweep time = auto
15. Trace mode = max hold
16. Allow max hold to run for at least 50 times (1/duty cycle) traces

7.7.4. Test Setup

1GHz ~ 18GHz Test Setup:

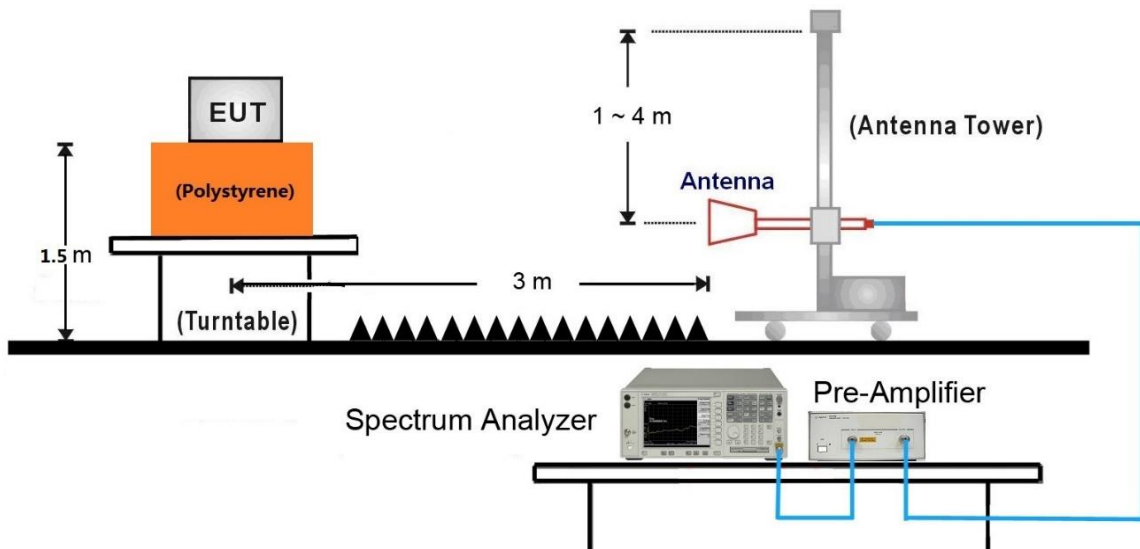

7.7.5. Test Result

EUT	Sonata XL	Date of Test	2020-08-01
Factor	BBHA 9120D	Temp. / Humidity	26°C /55%
Polarity	Horizontal	Site / Test Engineer	AC1 / Peter
Test Mode	BLE_TX_1Mbps_CH0	Test Voltage	AC 120V/60Hz

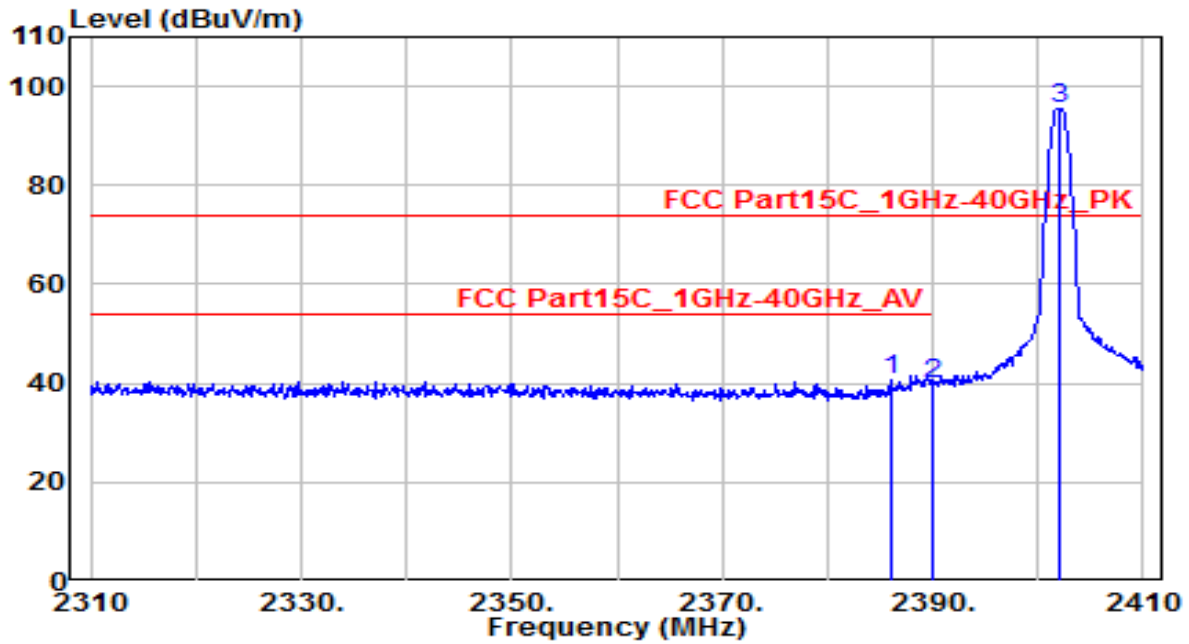

No	Frequency (MHz)	Reading (dBuV)	C.F (dB)	Measurement (dBuV/m)	Margin (dB)	Limit (dBuV/m)	Height (cm)	Angle (deg)	Remark (QP/PK/AV)
1	* 2386.000	43.41	-2.72	40.69	-33.31	74.00	190	360	Peak
2	2390.000	42.35	-2.70	39.65	-34.35	74.00	190	360	Peak
3	2402.100	98.09	-2.65	95.44	N/A	N/A	190	360	Peak

Note:

1. " *", means this data is the worst emission level.
2. C.F (Correction Factor) = Antenna Factor (dB)+ Cable Loss (dB) – Preamplifier(dB).
3. Measurement (dBuV/m) = Reading(dBuV) + C.F (Correction Factor).
4. The emission levels of other frequencies are very lower than the limit and not show in test report.

EUT	Sonata XL	Date of Test	2020-08-01
Factor	BBHA 9120D	Temp. / Humidity	26°C /55%
Polarity	Vertical	Site / Test Engineer	AC1 / Peter
Test Mode	BLE_TX_1Mbps_CH0	Test Voltage	AC 120V/60Hz

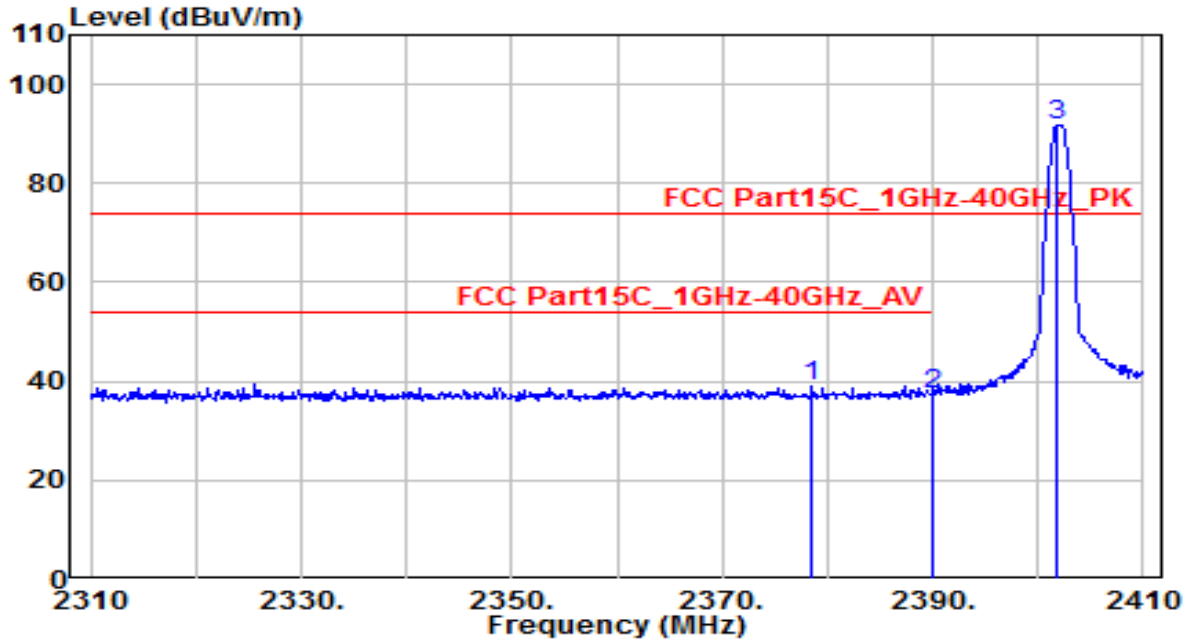

No	Frequency (MHz)	Reading (dBuV)	C.F (dB)	Measurement (dBuV/m)	Margin (dB)	Limit (dBuV/m)	Height (cm)	Angle (deg)	Remark (QP/PK/AV)
1	* 2378.500	41.65	-2.75	38.90	-35.10	74.00	155	70	Peak
2	2390.000	40.19	-2.70	37.48	-36.52	74.00	155	70	Peak
3	2401.800	94.31	-2.65	91.66	N/A	N/A	155	70	Peak

Note:

1. " *", means this data is the worst emission level.
2. C.F (Correction Factor) = Antenna Factor (dB)+ Cable Loss (dB) – Preamplifier(dB).
3. Measurement (dBuV/m) = Reading(dBuV) + C.F (Correction Factor).
4. The emission levels of other frequencies are very lower than the limit and not show in test report.

EUT	Sonata XL	Date of Test	2020-08-01
Factor	BBHA 9120D	Temp. / Humidity	26°C /55%
Polarity	Horizontal	Site / Test Engineer	AC1 / Peter
Test Mode	BLE_TX_1Mbps_CH39	Test Voltage	AC 120V/60Hz

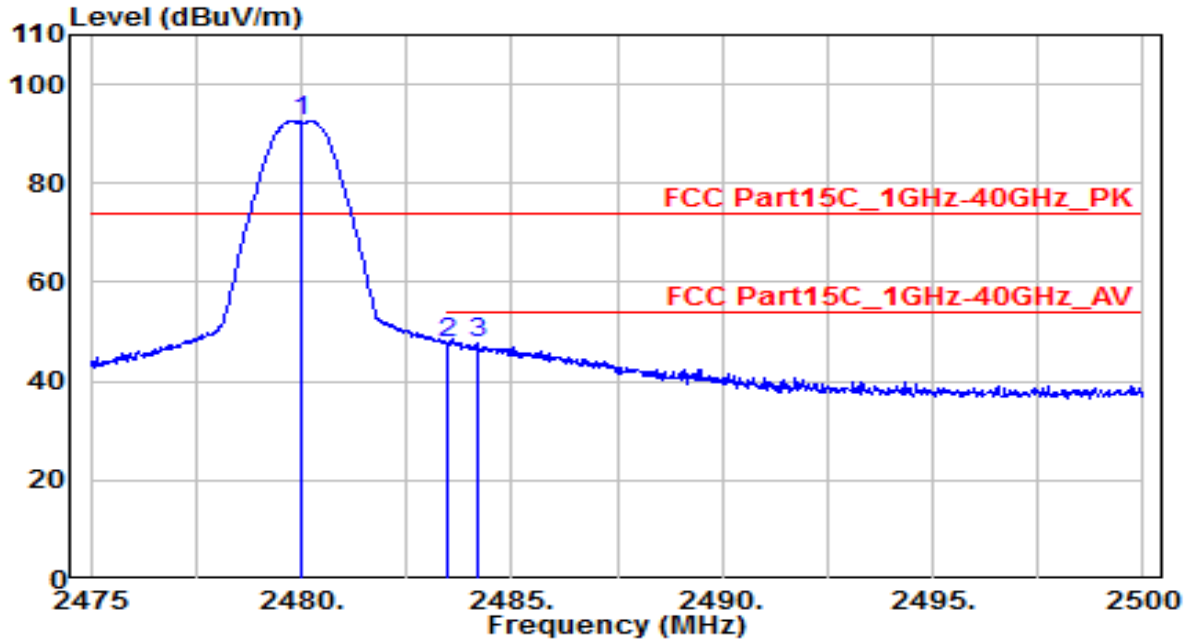

No	Frequency (MHz)	Reading (dBuV)	C.F (dB)	Measurement (dBuV/m)	Margin (dB)	Limit (dBuV/m)	Height (cm)	Angle (deg)	Remark (QP/PK/AV)
1	2480.025	94.81	-2.31	92.51	N/A	N/A	190	365	Peak
2	* 2483.500	50.15	-2.29	47.86	-26.14	74.00	190	365	Peak
3	2484.225	49.88	-2.29	47.59	-26.41	74.00	190	365	Peak

Note:

1. " *", means this data is the worst emission level.
2. C.F (Correction Factor) = Antenna Factor (dB)+ Cable Loss (dB) – Preamplifier(dB).
3. Measurement (dBuV/m) = Reading(dBuV) + C.F (Correction Factor).
4. The emission levels of other frequencies are very lower than the limit and not show in test report.

EUT	Sonata XL	Date of Test	2020-08-01
Factor	BBHA 9120D	Temp. / Humidity	26°C /55%
Polarity	Vertical	Site / Test Engineer	AC1 / Peter
Test Mode	BLE_TX_1Mbps_CH39	Test Voltage	AC 120V/60Hz

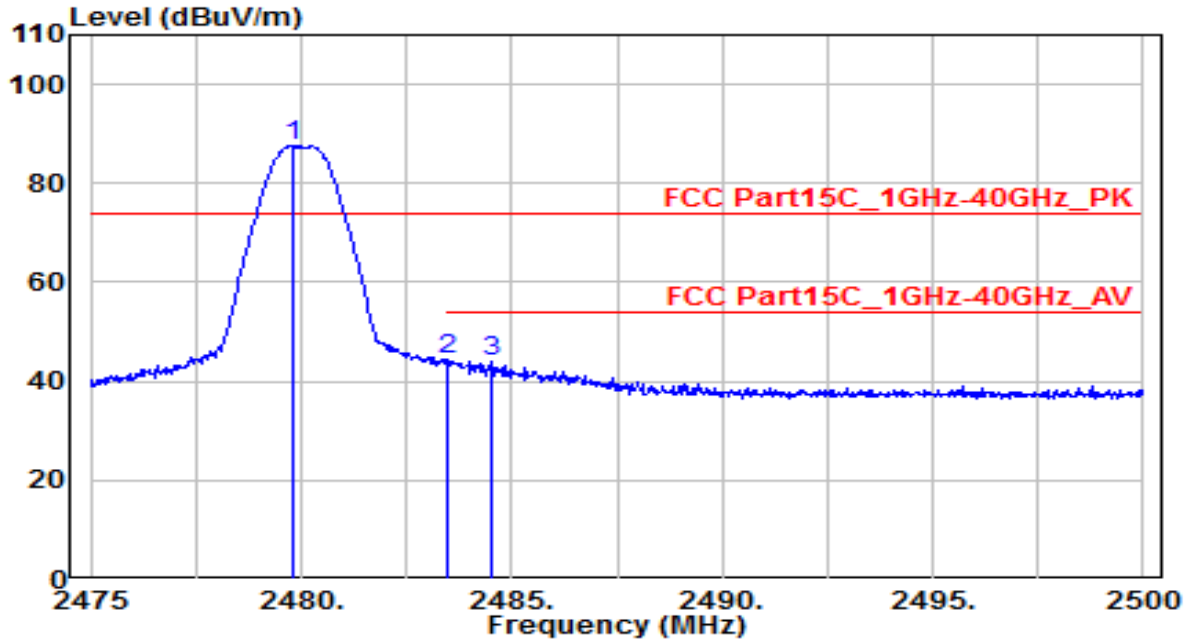

No	Frequency (MHz)	Reading (dBuV)	C.F (dB)	Measurement (dBuV/m)	Margin (dB)	Limit (dBuV/m)	Height (cm)	Angle (deg)	Remark (QP/PK/AV)
1	2479.775	89.80	-2.31	87.49	N/A	N/A	155	90	Peak
2	* 2483.500	46.64	-2.29	44.35	-29.65	74.00	155	90	Peak
3	2484.550	46.24	-2.29	43.95	-30.05	74.00	155	90	Peak

Note:

1. " *", means this data is the worst emission level.
2. C.F (Correction Factor) = Antenna Factor (dB)+ Cable Loss (dB) – Preamplifier(dB).
3. Measurement (dBuV/m) = Reading(dBuV) + C.F (Correction Factor).
4. The emission levels of other frequencies are very lower than the limit and not show in test report.

EUT	Opus XL	Date of Test	2020-08-01
Factor	BBHA 9120D	Temp. / Humidity	26°C /55%
Polarity	Horizontal	Site / Test Engineer	AC1 / Peter
Test Mode	BLE_TX_1Mbps_CH0	Test Voltage	AC 120V/60Hz

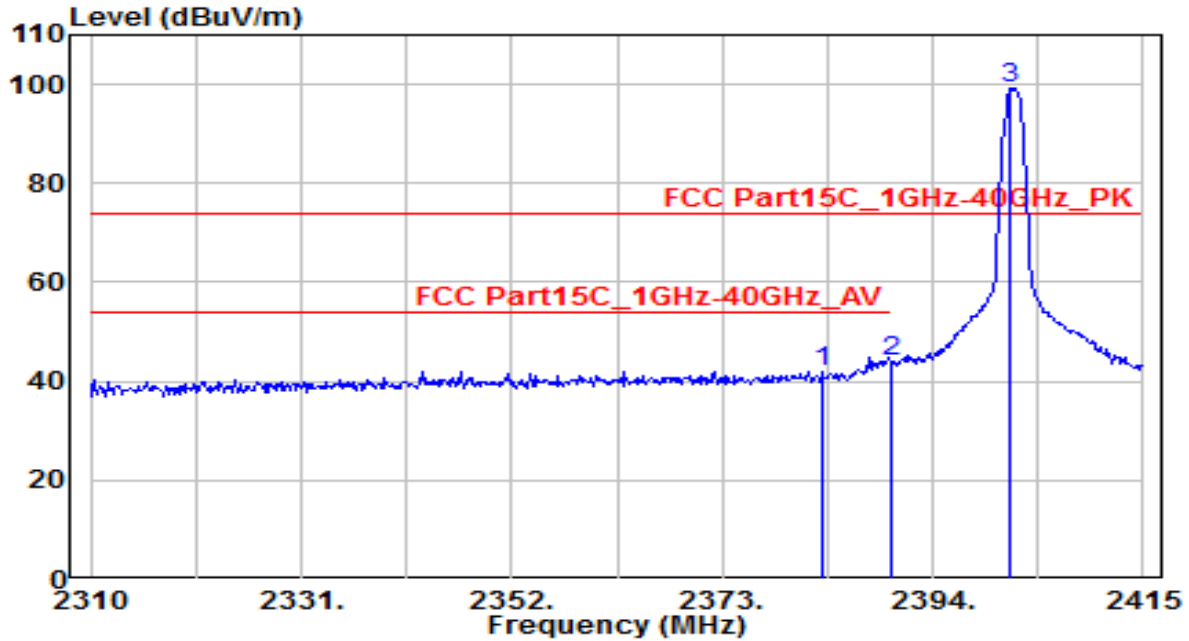

No	Frequency (MHz)	Reading (dBuV)	C.F (dB)	Measurement (dBuV/m)	Margin (dB)	Limit (dBuV/m)	Height (cm)	Angle (deg)	Remark (QP/PK/AV)
1	2382.891	44.50	-2.74	41.76	-32.24	74.00	210	175	Peak
2	* 2390.000	46.77	-2.70	44.06	-29.94	74.00	210	175	Peak
3	2401.761	101.74	-2.65	99.09	N/A	N/A	210	175	Peak

Note:

1. " *", means this data is the worst emission level.
2. C.F (Correction Factor) = Antenna Factor (dB)+ Cable Loss (dB) – Preamplifier(dB).
3. Measurement (dBuV/m) = Reading(dBuV) + C.F (Correction Factor).
4. The emission levels of other frequencies are very lower than the limit and not show in test report.

EUT	Opus XL	Date of Test	2020-08-01
Factor	BBHA 9120D	Temp. / Humidity	26°C /55%
Polarity	Vertical	Site / Test Engineer	AC1 / Peter
Test Mode	BLE_TX_1Mbps_CH0	Test Voltage	AC 120V/60Hz

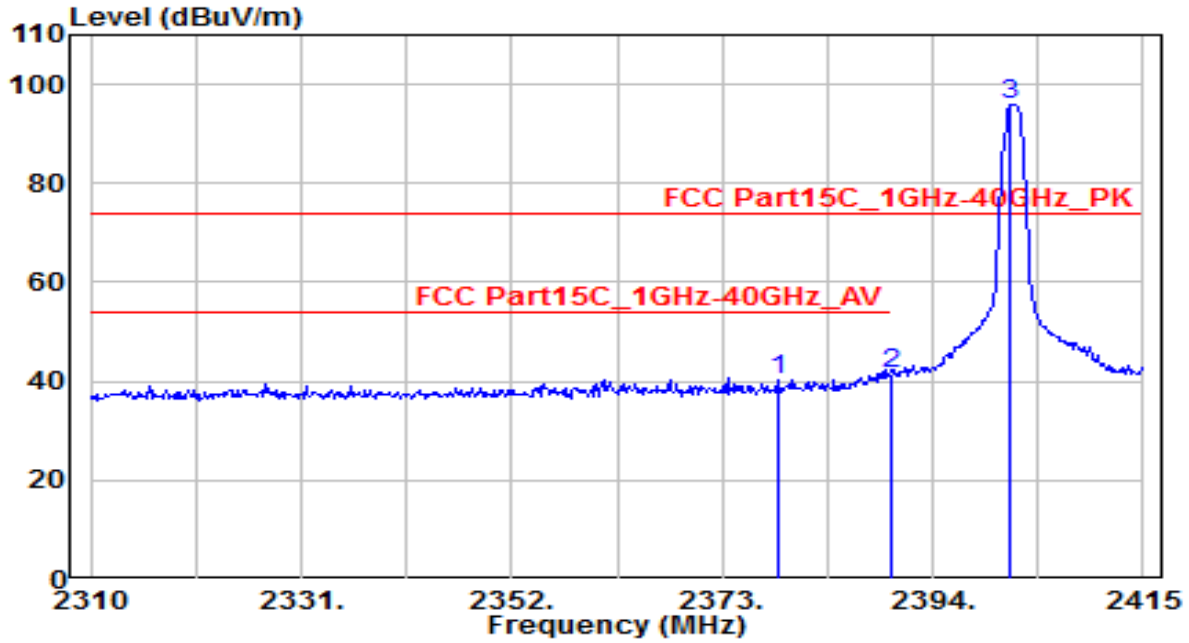

No	Frequency (MHz)	Reading (dBuV)	C.F (dB)	Measurement (dBuV/m)	Margin (dB)	Limit (dBuV/m)	Height (cm)	Angle (deg)	Remark (QP/PK/AV)
1	2378.478	43.14	-2.75	40.39	-33.61	74.00	170	285	Peak
2	* 2390.000	44.25	-2.70	41.55	-32.45	74.00	170	285	Peak
3	2401.761	98.73	-2.65	96.08	N/A	N/A	170	285	Peak

Note:

1. " *", means this data is the worst emission level.
2. C.F (Correction Factor) = Antenna Factor (dB)+ Cable Loss (dB) – Preamplifier(dB).
3. Measurement (dBuV/m) = Reading(dBuV) + C.F (Correction Factor).
4. The emission levels of other frequencies are very lower than the limit and not show in test report.

EUT	Opus XL	Date of Test	2020-08-01
Factor	BBHA 9120D	Temp. / Humidity	26°C /55%
Polarity	Horizontal	Site / Test Engineer	AC1 / Peter
Test Mode	BLE_TX_1Mbps_CH39	Test Voltage	AC 120V/60Hz

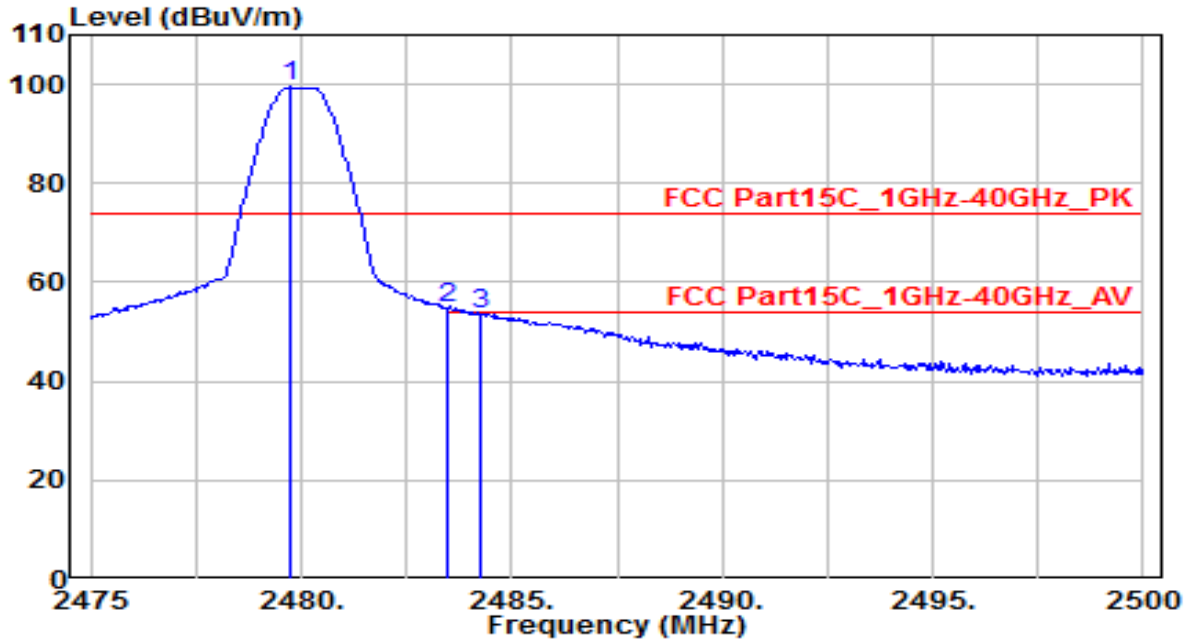

No	Frequency (MHz)	Reading (dBuV)	C.F (dB)	Measurement (dBuV/m)	Margin (dB)	Limit (dBuV/m)	Height (cm)	Angle (deg)	Remark (QP/PK/AV)
1	2479.746	101.73	-2.31	99.42	N/A	N/A	155	180	Peak
2	* 2483.500	56.91	-2.29	54.62	-19.38	74.00	155	180	Peak
3	2484.239	55.74	-2.29	53.45	-20.55	74.00	155	180	Peak

Note:

1. " *", means this data is the worst emission level.
2. C.F (Correction Factor) = Antenna Factor (dB)+ Cable Loss (dB) – Preamplifier(dB).
3. Measurement (dBuV/m) = Reading(dBuV) + C.F (Correction Factor).
4. The emission levels of other frequencies are very lower than the limit and not show in test report.

EUT	Opus XL	Date of Test	2020-08-01
Factor	BBHA 9120D	Temp. / Humidity	26°C /55%
Polarity	Horizontal	Site / Test Engineer	AC1 / Peter
Test Mode	BLE_TX_1Mbps_CH39	Test Voltage	AC 120V/60Hz

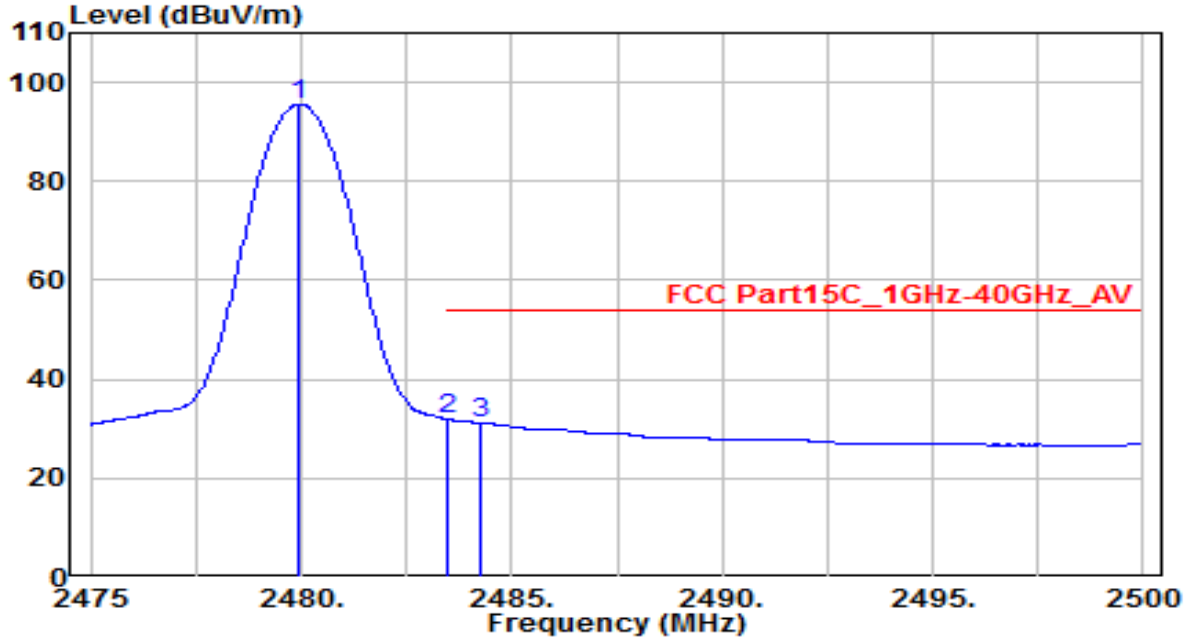

No	Frequency (MHz)	Reading (dBuV)	C.F (dB)	Measurement (dBuV/m)	Margin (dB)	Limit (dBuV/m)	Height (cm)	Angle (deg)	Remark (QP/PK/AV)
1	2479.964	97.97	-2.31	95.66	N/A	N/A	155	180	Average
2	* 2483.500	34.17	-2.29	31.87	-22.13	54.00	155	180	Average
3	2484.239	33.52	-2.29	31.23	-22.77	54.00	155	180	Average

Note:

1. " *", means this data is the worst emission level.
2. C.F (Correction Factor) = Antenna Factor (dB)+ Cable Loss (dB) – Preamplifier(dB).
3. Measurement (dBuV/m) = Reading(dBuV) + C.F (Correction Factor).
4. The emission levels of other frequencies are very lower than the limit and not show in test report.

EUT	Opus XL	Date of Test	2020-08-01
Factor	BBHA 9120D	Temp. / Humidity	26°C /55%
Polarity	Vertical	Site / Test Engineer	AC1 / Peter
Test Mode	BLE_TX_1Mbps_CH39	Test Voltage	AC 120V/60Hz

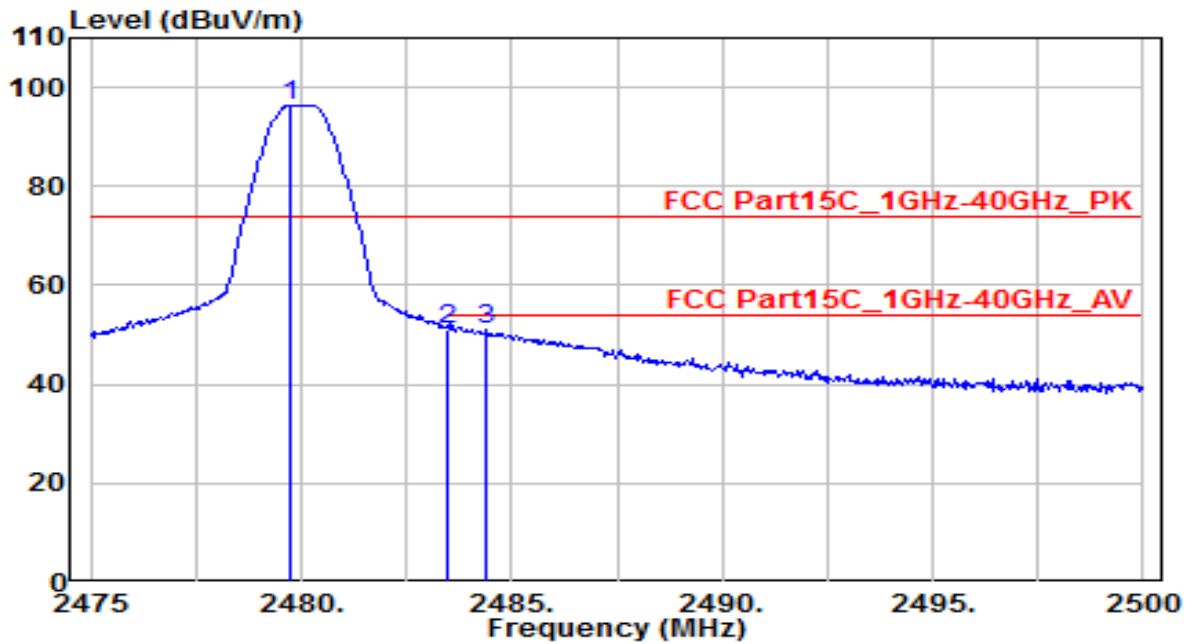

No	Frequency (MHz)	Reading (dBuV)	C.F (dB)	Measurement (dBuV/m)	Margin (dB)	Limit (dBuV/m)	Height (cm)	Angle (deg)	Remark (QP/PK/AV)
1	2479.746	98.72	-2.31	96.41	N/A	N/A	150	145	Peak
2	* 2483.500	53.49	-2.29	51.20	-22.80	74.00	150	145	Peak
3	2484.420	53.15	-2.29	50.86	-23.14	74.00	150	145	Peak

Note:

1. " *", means this data is the worst emission level.
2. C.F (Correction Factor) = Antenna Factor (dB)+ Cable Loss (dB) – Preamplifier(dB).
3. Measurement (dBuV/m) = Reading(dBuV) + C.F (Correction Factor).
4. The emission levels of other frequencies are very lower than the limit and not show in test report.

7.8. AC Conducted Emissions Measurement

7.8.1. Test Limit

FCC Part 15 Subpart C Paragraph 15.207 / RSS-Gen Limits		
Frequency (MHz)	QP (dB μ V)	Average (dB μ V)
0.15 - 0.50	66 - 56	56 - 46
0.50 - 5.0	56	46
5.0 - 30	60	50

Note 1: The lower limit shall apply at the transition frequencies.

Note 2: The limit decreases linearly with the logarithm of the frequency in the range 0.15MHz to 0.5MHz.

7.8.2. Test Setup

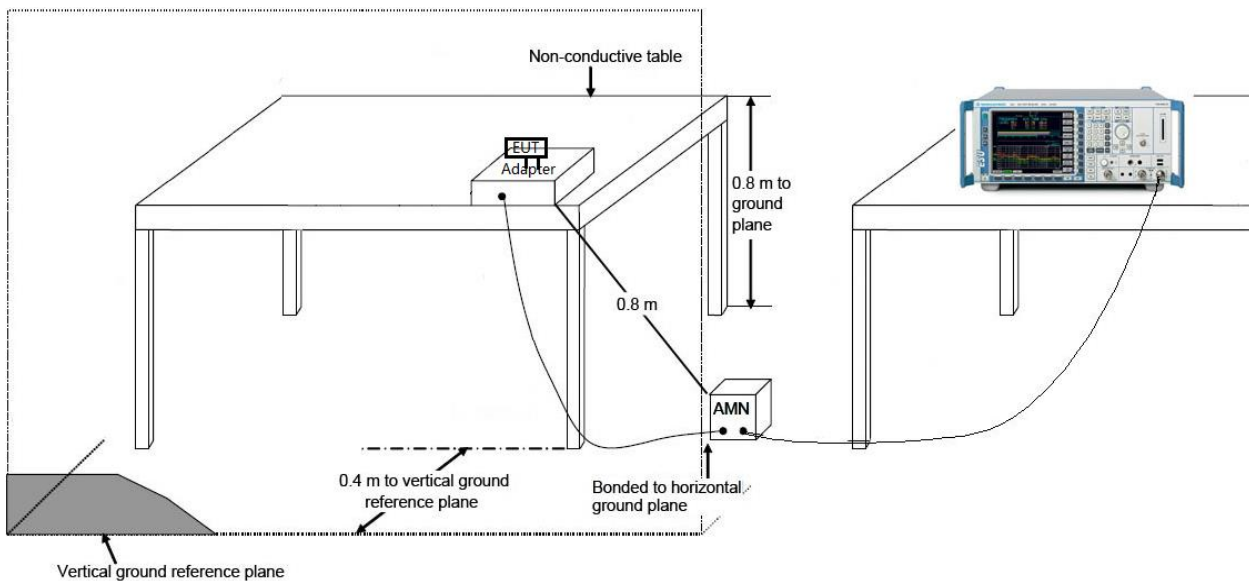

7.8.3. Test Result

EUT	Sonata XL	Date of Test	2020-07-30
Factor	CE_ENV216-L1 (Filter ON)	Temp. / Humidity	26.4°C /50%
Polarity	Line1	Site / Test Engineer	SR2 / Kaunaz
Test Mode	BLE_TX_1Mbps_CH 19	Test Voltage	AC 120V/60Hz

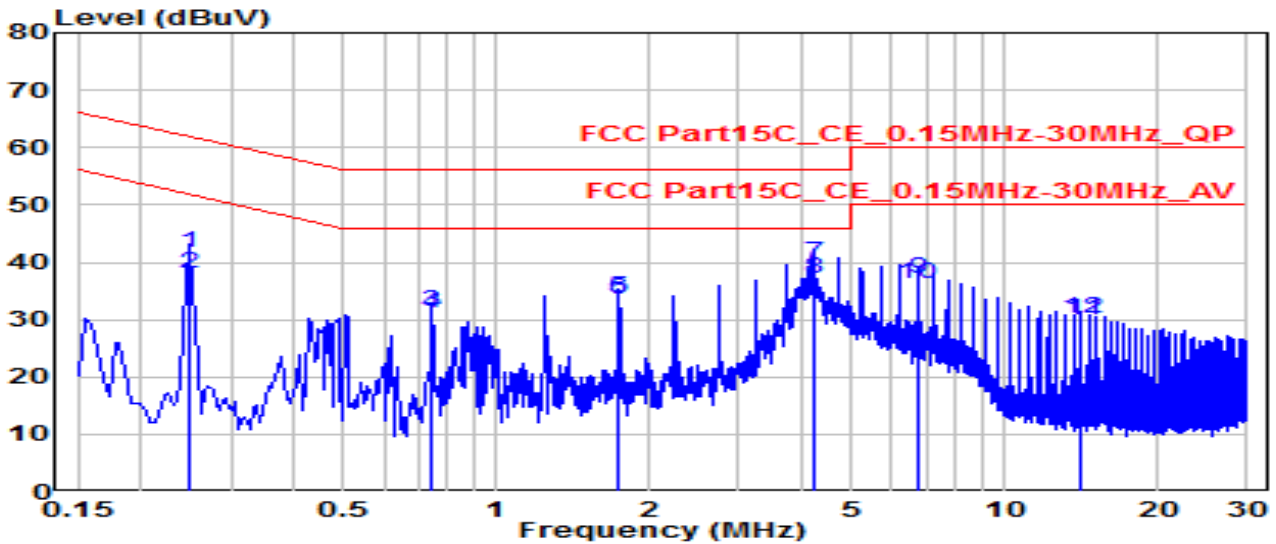

No	Frequency (MHz)	Reading (dBuV)	C.F (dB)	Measurement (dBuV/m)	Margin (dB)	Limit (dBuV/m)	Remark (QP/PK/AV)
1	0.249	32.03	9.62	41.65	-20.14	61.79	QP
2	0.249	28.28	9.62	37.89	-13.90	51.79	Average
3	0.748	21.89	9.65	31.54	-24.46	56.00	QP
4	0.748	21.56	9.65	31.20	-14.80	46.00	Average
5	1.743	24.09	9.68	33.78	-22.22	56.00	QP
6	1.743	23.86	9.68	33.54	-12.46	46.00	Average
7	* 4.231	30.13	9.72	39.86	-16.14	56.00	QP
8	* 4.231	27.45	9.72	37.17	-8.83	46.00	Average
9	6.719	27.24	9.79	37.03	-22.97	60.00	QP
10	6.719	26.41	9.79	36.20	-13.80	50.00	Average
11	14.189	20.01	9.92	29.94	-30.06	60.00	QP
12	14.189	20.19	9.92	30.11	-19.89	50.00	Average

Note:

1. " *", means this data is the worst emission level.
2. C.F (Correction Factor) = Antenna Factor (dB)+ Cable Loss (dB).
3. Measurement (dBuV/m) = Reading(dBuV) + C.F (Correction Factor).

EUT	Sonata XL	Date of Test	2020-07-30
Factor	CE_ENV216-N (Filter ON)	Temp. / Humidity	26.4°C /50%
Polarity	Neutral	Site / Test Engineer	SR2 / Kaunaz
Test Mode	BLE_TX_1Mbps_CH 19	Test Voltage	AC 120V/60Hz

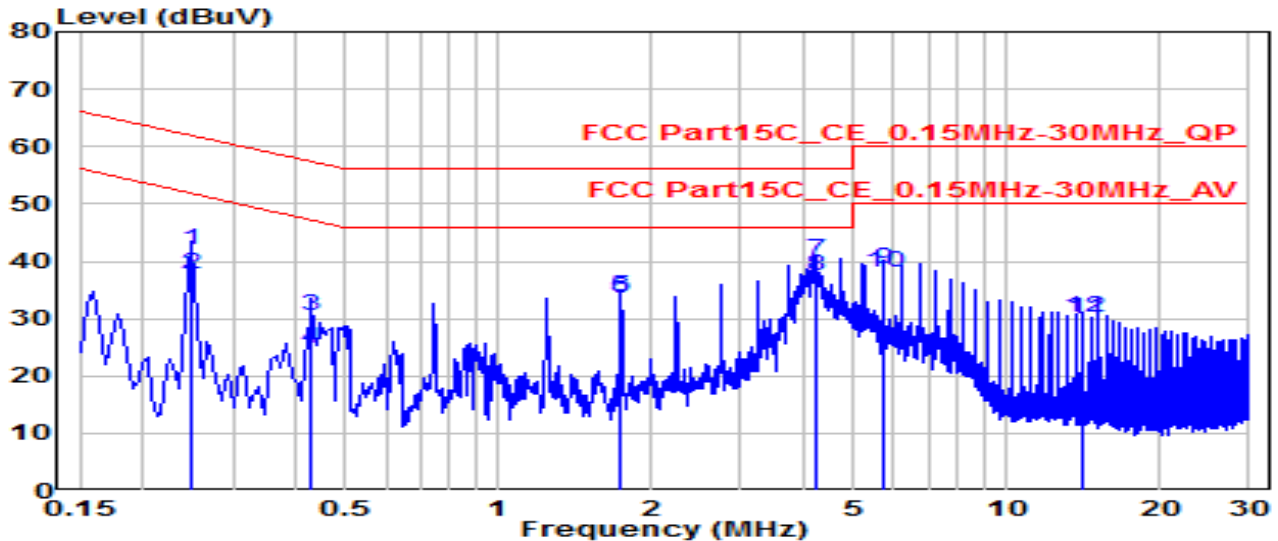

No	Frequency (MHz)	Reading (dBUV)	C.F (dB)	Measurement (dBUV/m)	Margin (dB)	Limit (dBUV/m)	Remark (QP/PK/AV)
1	0.249	32.32	9.63	41.95	-19.85	61.79	QP
2	0.249	28.22	9.63	37.85	-13.94	51.79	Average
3	0.429	20.83	9.64	30.46	-26.81	57.27	QP
4	0.429	15.11	9.64	24.74	-22.53	47.27	Average
5	1.743	24.12	9.68	33.80	-22.20	56.00	QP
6	1.743	23.89	9.68	33.57	-12.43	46.00	Average
7	* 4.231	30.49	9.73	40.22	-15.78	56.00	QP
8	* 4.231	27.55	9.73	37.29	-8.71	46.00	Average
9	5.725	28.94	9.77	38.71	-21.29	60.00	QP
10	5.725	28.31	9.77	38.08	-11.92	50.00	Average
11	14.189	20.01	9.96	29.97	-30.03	60.00	QP
12	14.189	20.18	9.96	30.14	-19.86	50.00	Average

Note:

1. " *", means this data is the worst emission level.
2. C.F (Correction Factor) = Antenna Factor (dB)+ Cable Loss (dB).
3. Measurement (dBUV/m) = Reading(dBUV) + C.F (Correction Factor).

EUT	Sonata XL	Date of Test	2020-07-30
Factor	CE_ENV216-L1 (Filter ON)	Temp. / Humidity	26.4°C /50%
Polarity	Line1	Site / Test Engineer	SR2 / Kaunaz
Test Mode	BLE_TX_1Mbps_CH 19	Test Voltage	AC 240V/60Hz

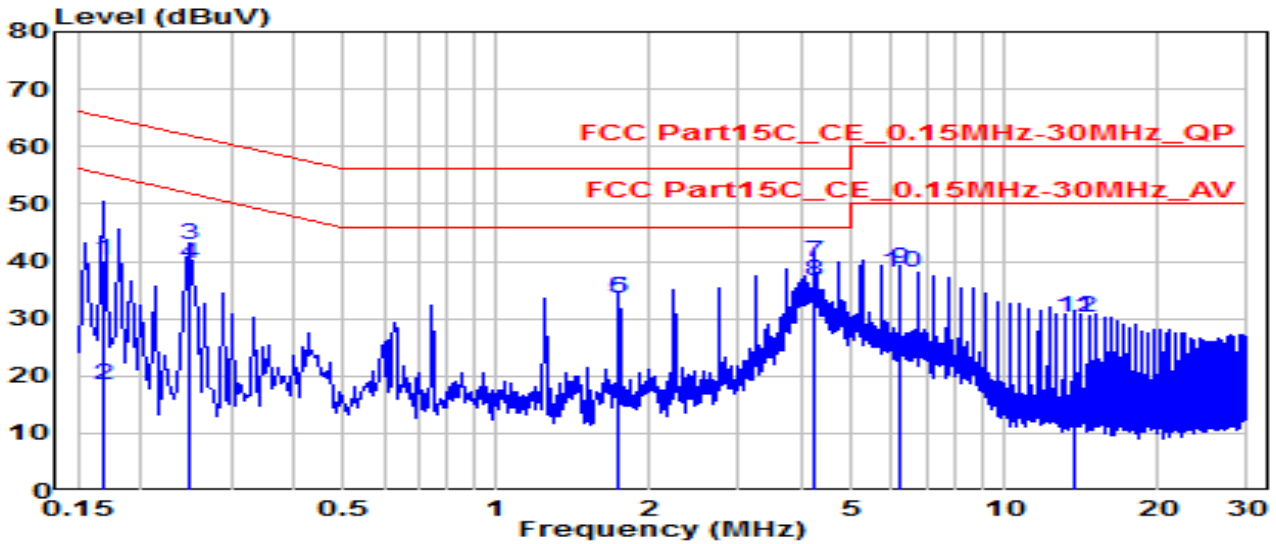

No	Frequency (MHz)	Reading (dBuV)	C.F (dB)	Measurement (dBuV/m)	Margin (dB)	Limit (dBuV/m)	Remark (QP/PK/AV)
1	0.168	30.53	9.61	40.14	-24.92	65.06	QP
2	0.168	8.71	9.61	18.32	-36.74	55.06	Average
3	0.249	33.23	9.62	42.85	-18.94	61.79	QP
4	0.249	29.98	9.62	39.59	-12.20	51.79	Average
5	1.743	23.89	9.68	33.57	-22.43	56.00	QP
6	1.743	23.83	9.68	33.51	-12.49	46.00	Average
7	* 4.231	30.26	9.72	39.98	-16.02	56.00	QP
8	* 4.231	26.80	9.72	36.53	-9.47	46.00	Average
9	6.224	28.79	9.77	38.57	-21.43	60.00	QP
10	6.224	28.31	9.77	38.08	-11.92	50.00	Average
11	13.694	20.19	9.92	30.11	-29.89	60.00	QP
12	13.694	20.27	9.92	30.19	-19.81	50.00	Average

Note:

1. " *", means this data is the worst emission level.
2. C.F (Correction Factor) = Antenna Factor (dB)+ Cable Loss (dB).
3. Measurement (dBuV/m) = Reading(dBuV) + C.F (Correction Factor).

EUT	Sonata XL	Date of Test	2020-07-30
Factor	CE_ENV216-N (Filter ON)	Temp. / Humidity	26.4°C /50%
Polarity	Neutral	Site / Test Engineer	SR2 / Kaunaz
Test Mode	BLE_TX_1Mbps_CH 19	Test Voltage	AC 240V/60Hz

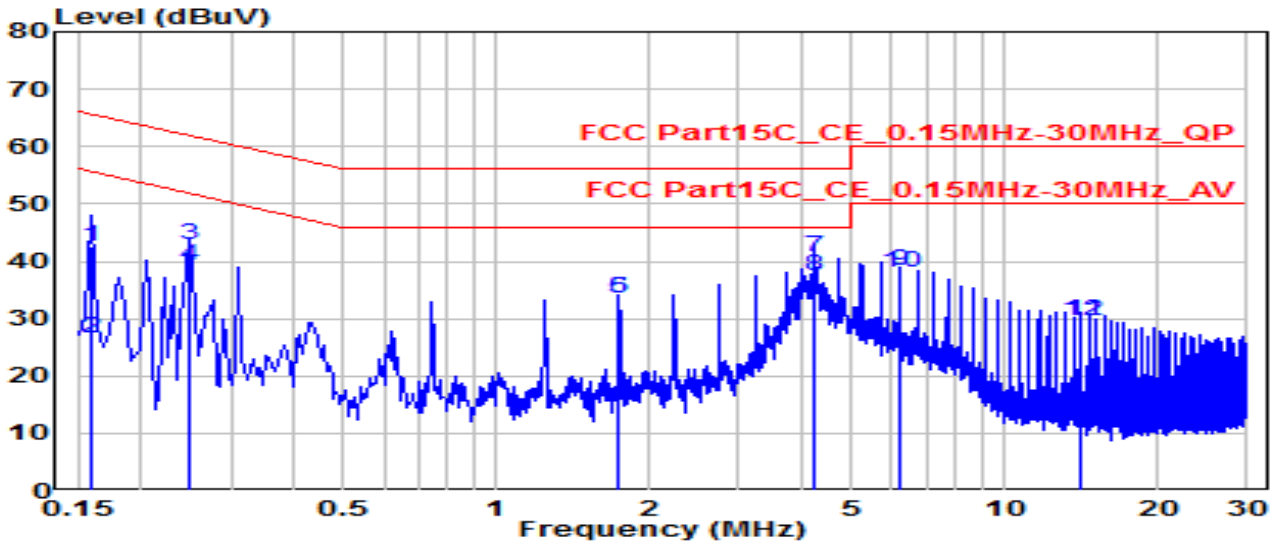

No	Frequency (MHz)	Reading (dBUV)	C.F (dB)	Measurement (dBUV/m)	Margin (dB)	Limit (dBUV/m)	Remark (QP/PK/AV)
1	0.159	32.93	9.62	42.55	-22.97	65.52	QP
2	0.159	16.92	9.62	26.54	-28.98	55.52	Average
3	0.249	33.25	9.63	42.88	-18.91	61.79	QP
4	0.249	29.68	9.63	39.30	-12.49	51.79	Average
5	1.743	23.93	9.68	33.62	-22.38	56.00	QP
6	1.743	23.89	9.68	33.57	-12.43	46.00	Average
7	* 4.231	30.97	9.73	40.71	-15.29	56.00	QP
8	* 4.231	27.58	9.73	37.31	-8.69	46.00	Average
9	6.224	28.70	9.78	38.48	-21.52	60.00	QP
10	6.224	28.21	9.78	38.00	-12.00	50.00	Average
11	14.189	19.56	9.96	29.52	-30.48	60.00	QP
12	14.189	19.62	9.96	29.58	-20.42	50.00	Average

Note:

1. " *", means this data is the worst emission level.
2. C.F (Correction Factor) = Antenna Factor (dB)+ Cable Loss (dB).
3. Measurement (dBUV/m) = Reading(dBUV) + C.F (Correction Factor).

EUT	Opus XL	Date of Test	2020-07-30
Factor	CE_ENV216-L1 (Filter ON)	Temp. / Humidity	26.4°C /50%
Polarity	Line1	Site / Test Engineer	SR2 / Kaunaz
Test Mode	BLE_TX_1Mbps_CH 19	Test Voltage	AC 120V/60Hz

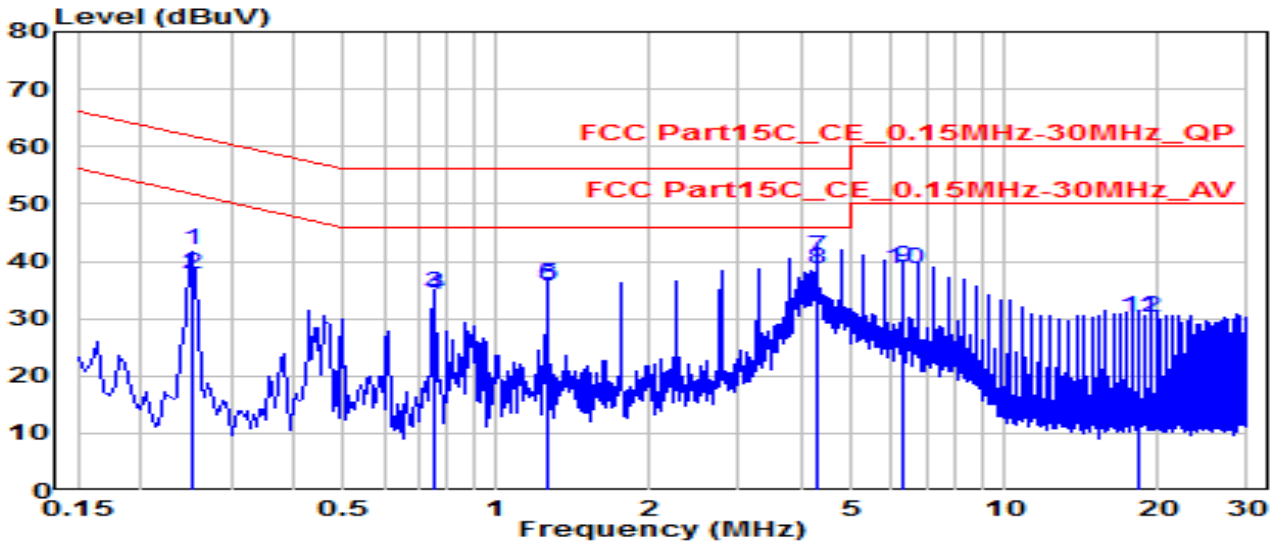

No	Frequency (MHz)	Reading (dBUV)	C.F (dB)	Measurement (dBUV/m)	Margin (dB)	Limit (dBUV/m)	Remark (QP/PK/AV)
1	0.253	32.31	9.62	41.93	-19.72	61.64	QP
2	0.253	28.13	9.62	37.75	-13.89	51.64	Average
3	0.753	24.69	9.65	34.34	-21.66	56.00	QP
4	0.753	24.49	9.65	34.14	-11.86	46.00	Average
5	1.257	26.11	9.67	35.78	-20.22	56.00	QP
6	1.257	26.00	9.67	35.67	-10.33	46.00	Average
7	* 4.272	30.91	9.73	40.64	-15.36	56.00	QP
8	* 4.272	28.89	9.73	38.61	-7.39	46.00	Average
9	6.283	29.26	9.78	39.03	-20.97	60.00	QP
10	6.283	28.94	9.78	38.72	-11.28	50.00	Average
11	18.351	20.28	9.97	30.25	-29.75	60.00	QP
12	18.351	20.36	9.97	30.33	-19.67	50.00	Average

Note:

1. " *", means this data is the worst emission level.
2. C.F (Correction Factor) = Antenna Factor (dB)+ Cable Loss (dB).
3. Measurement (dBUV/m) = Reading(dBUV) + C.F (Correction Factor).

EUT	Opus XL	Date of Test	2020-07-30
Factor	CE_ENV216-N (Filter ON)	Temp. / Humidity	26.4°C /50%
Polarity	Neutral	Site / Test Engineer	SR2 / Kaunaz
Test Mode	BLE_TX_1Mbps_CH 19	Test Voltage	AC 120V/60Hz

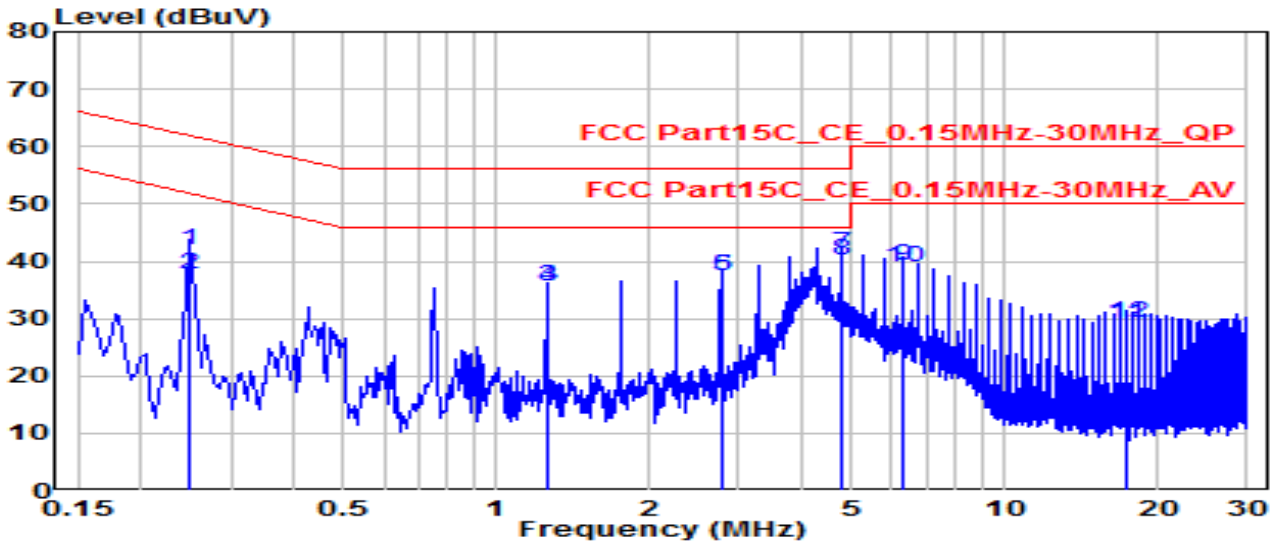

No	Frequency (MHz)	Reading (dBUV)	C.F (dB)	Measurement (dBUV/m)	Margin (dB)	Limit (dBUV/m)	Remark (QP/PK/AV)
1	0.249	32.30	9.63	41.92	-19.87	61.79	QP
2	0.249	28.01	9.63	37.64	-14.15	51.79	Average
3	1.257	26.08	9.68	35.76	-20.24	56.00	QP
4	1.257	26.00	9.68	35.67	-10.33	46.00	Average
5	2.764	27.80	9.71	37.51	-18.49	56.00	QP
6	2.764	27.58	9.71	37.29	-8.71	46.00	Average
7	* 4.776	31.58	9.75	41.33	-14.67	56.00	QP
8	* 4.776	30.26	9.75	40.01	-5.99	46.00	Average
9	6.283	29.41	9.79	39.19	-20.81	60.00	QP
10	6.283	29.09	9.79	38.88	-11.12	50.00	Average
11	17.343	19.10	10.02	29.12	-30.88	60.00	QP
12	17.343	19.28	10.02	29.30	-20.70	50.00	Average

Note:

1. " *", means this data is the worst emission level.
2. C.F (Correction Factor) = Antenna Factor (dB)+ Cable Loss (dB).
3. Measurement (dBUV/m) = Reading(dBUV) + C.F (Correction Factor).

EUT	Opus XL	Date of Test	2020-07-30
Factor	CE_ENV216-L1 (Filter ON)	Temp. / Humidity	26.4°C /50%
Polarity	Line1	Site / Test Engineer	SR2 / Kaunaz
Test Mode	BLE_TX_1Mbps_CH 19	Test Voltage	AC 240V/60Hz

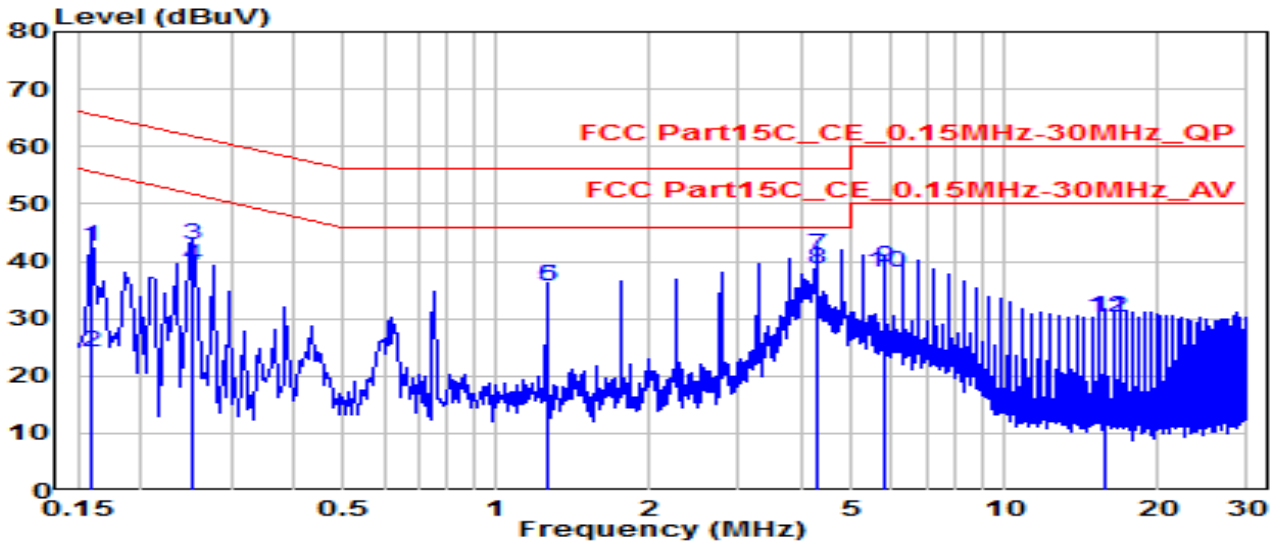

No	Frequency (MHz)	Reading (dBUV)	C.F (dB)	Measurement (dBUV/m)	Margin (dB)	Limit (dBUV/m)	Remark (QP/PK/AV)
1	0.159	32.83	9.61	42.44	-23.07	65.52	QP
2	0.159	14.60	9.61	24.21	-31.31	55.52	Average
3	0.253	33.34	9.62	42.96	-18.69	61.64	QP
4	0.253	29.50	9.62	39.12	-12.52	51.64	Average
5	1.257	25.86	9.67	35.53	-20.47	56.00	QP
6	1.257	25.87	9.67	35.54	-10.46	46.00	Average
7	* 4.272	31.22	9.73	40.94	-15.06	56.00	QP
8	* 4.272	28.95	9.73	38.68	-7.32	46.00	Average
9	5.779	29.09	9.76	38.85	-21.15	60.00	QP
10	5.779	28.31	9.76	38.08	-11.92	50.00	Average
11	15.835	20.10	9.94	30.04	-29.96	60.00	QP
12	15.835	20.20	9.94	30.14	-19.86	50.00	Average

Note:

1. " *", means this data is the worst emission level.
2. C.F (Correction Factor) = Antenna Factor (dB)+ Cable Loss (dB).
3. Measurement (dBUV/m) = Reading(dBUV) + C.F (Correction Factor).

EUT	Opus XL	Date of Test	2020-07-30
Factor	CE_ENV216-N (Filter ON)	Temp. / Humidity	26.4°C /50%
Polarity	Neutral	Site / Test Engineer	SR2 / Kaunaz
Test Mode	BLE_TX_1Mbps_CH 19	Test Voltage	AC 240V/60Hz

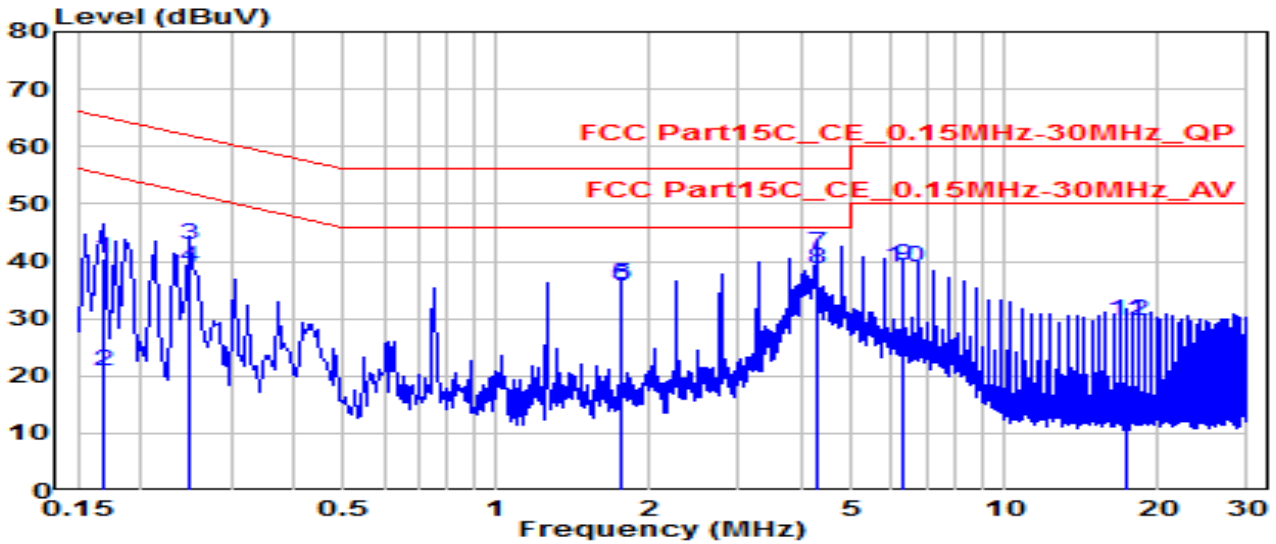

No	Frequency (MHz)	Reading (dBUV)	C.F (dB)	Measurement (dBUV/m)	Margin (dB)	Limit (dBUV/m)	Remark (QP/PK/AV)
1	0.168	30.80	9.62	40.42	-24.64	65.06	QP
2	0.168	11.19	9.62	20.81	-34.25	55.06	Average
3	0.249	33.28	9.63	42.91	-18.88	61.79	QP
4	0.249	29.34	9.63	38.96	-12.83	51.79	Average
5	1.761	26.09	9.69	35.77	-20.23	56.00	QP
6	1.761	26.05	9.69	35.74	-10.26	46.00	Average
7	* 4.272	31.48	9.74	41.21	-14.79	56.00	QP
8	* 4.272	28.98	9.74	38.72	-7.28	46.00	Average
9	6.283	29.54	9.79	39.33	-20.67	60.00	QP
10	6.283	29.12	9.79	38.91	-11.09	50.00	Average
11	17.343	19.54	10.02	29.56	-30.44	60.00	QP
12	17.343	19.53	10.02	29.55	-20.45	50.00	Average

Note:

1. " *", means this data is the worst emission level.
2. C.F (Correction Factor) = Antenna Factor (dB)+ Cable Loss (dB).
3. Measurement (dBUV/m) = Reading(dBUV) + C.F (Correction Factor).

8. CONCLUSION

The data collected relate only the item(s) tested and show that the **Touch Screen Controller** is in compliance with Part 15C & RSS-247 of the FCC & IC Rules.

————— The End —————