

## 8.0" Touch Panel Quick Installation Guide

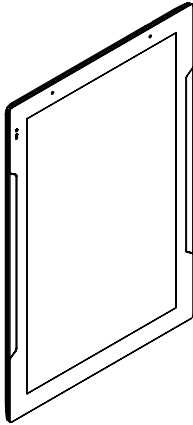

### Included in the box

- 1 ea Device
- 1 ea Mounting bracket
- 4 ea Mounting screws

### Introduction

To install the device you will also need one of the following electrical junction boxes for the supplied brackets.

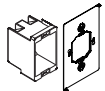

Standard NEMA  
2-gang US electrical  
junction box



Low-voltage mounting  
ring Arlington LV2

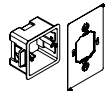

UK standard 2-gang  
electrical box

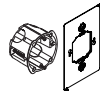

European/Italian  
16204 multibox

### Important safety instructions

Read, understand and follow ALL safety and installation instructions included in this manual. Failure to follow the included documentation may damage the product and will void the manufacturer's warranty. Follow ALL installation guidelines included with the product. Installation of the product in high humidity environments, in close proximity to heat sources and/or non-recommended locations WILL impede, interfere and/or damage the intended operation of the product. Only use attachments and accessories which have been specified for use by the manufacturer. The use of abrasive, liquid or solvent-based cleaning fluids WILL damage the product. Product Servicing may ONLY be completed by authorized or certified service centers & personnel. For a complete list of product servicing options, please follow instructions included in the product documentation and/or contact the original manufacturer for details.

This equipment has been tested and found to comply with the limits for a Class B digital device, pursuant to part 15 of the FCC Rules.

These limits are designed to provide reasonable protection against harmful interference in a residential installation. This equipment generates, uses and can radiate radio frequency energy and, if not installed and used in accordance with the instructions, may cause harmful interference to radio communications. However, there is no guarantee that interference will not occur in a particular installation. If this equipment does cause harmful interference to radio or television reception, which can be determined by turning the equipment off and on, the user is encouraged to try to correct the interference by one or more of the following measures:

- Reorient or relocate the receiving antenna.
- Increase the separation between the equipment and receiver.
- Connect the equipment into an outlet on a circuit different from that to which the receiver is connected.
- Consult the dealer or an experienced radio/TV technician for help.

### Device - Overview

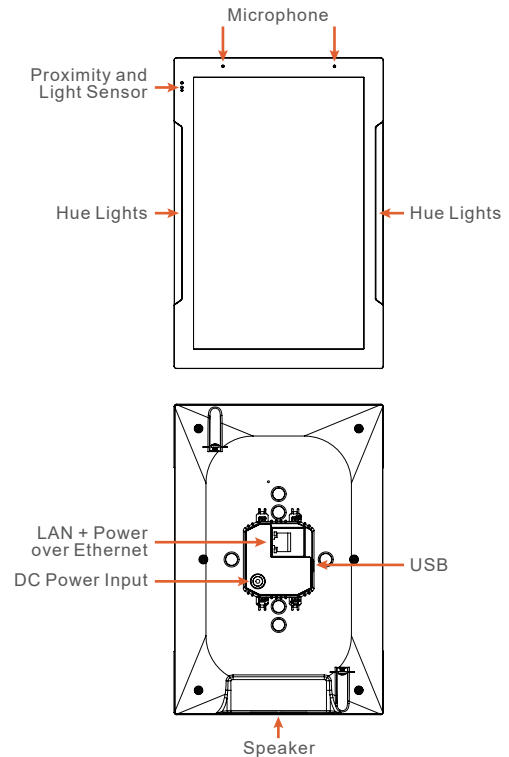

### Planning the installation

The device is designed to be wall mounted in Portrait orientation, or on tabletop with stand.

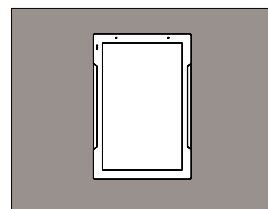

On the wall

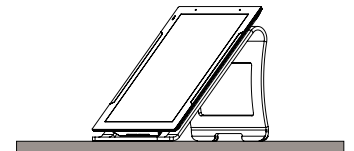

On the stand  
Part No.: 89-670-1010-00

The device requires a minimum mounting depth of 1" (2.45cm) from the wall surface to the room for cable/s. Power may be supplied by Power Over Ethernet (PoE) or by a 24V DC power supply (not included). PoE connecting must meet the IEEE 802.3af standard. Direct power connecting via a 24V DC external power supply requires a minimum current output of 1A. The device connects to the local network via a hard wired Ethernet connection. Or connecting with WiFi in the case of the units with WiFi function.

### Installing the device

#### A. Mounting height

The recommended mounting height for the device is 57" - 65" (145 cm - 165 cm) from the finished floor to the center of the unit.

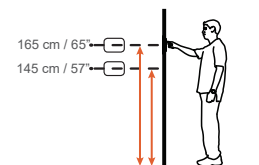

#### B. Portrait mounting

Device can be mounted and oriented in Portrait.

Portrait:  
Install the 1-gang box junction box or low-voltage bracket in its normal orientation with mounting screw holes at the top and bottom.

## C. Installing the device mounting bracket

The device package includes a stainless steel mounting bracket that MUST be used for installation. Please note the mounting bracket in the box is designed for the US standard 2-gang and supplied Arlington mounting ring supplied in the box. You can order additional stainless steel mounting brackets for UK or European electrical boxes. Verify that the bracket is level before tightening the captive screws on the device. (US mounting bracket included in the box)

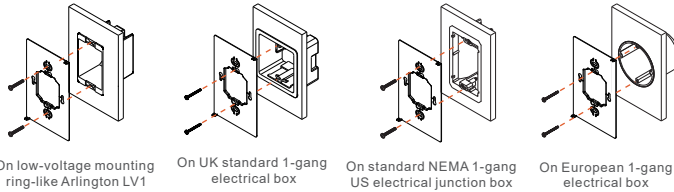

## D. Connecting the device to power

The device is designed to be powered over the Ethernet connection (PoE) or by connecting a 24Vdc power supply (not included), but not both. If both the PoE and a 24Vdc power supply are connected, the device will draw power from the 24V source.

### PoE Connection

PoE connection requires IEEE 802.3af standard. Utilize a network switch or PoE injector that meets this standard. Connect the device using a standard T568A or T568B Ethernet cable from the network switch to the LAN/PoE jack on the back of the device.

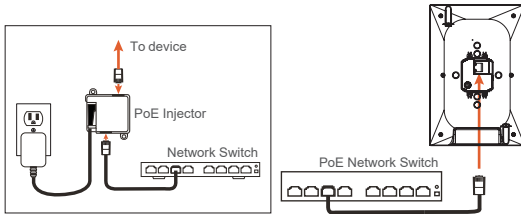

### 24Vdc Power Supply

You can provide power locally or remotely to device by utilizing a 24V DC power supply (not included). Please note that running the wire through the wall in accordance with local codes when powering locally. If powering remotely, please ensure to use wire of adequate gauge for the length of the run. Please use approved 24V DC power supply.

Verify the polarity of the barrel connector on your power supply before connecting it to the device. The center pin of the device power connector is positive and the outer ring is negative. If the wire is extended, please ensure that the routing is in compliance with local codes.

Plug the connector into the device DC jack on the back of the device.

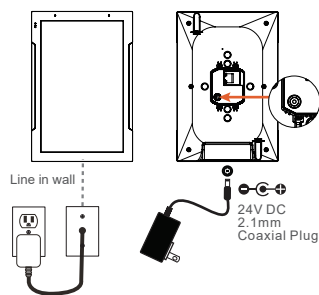

## Powering up the device

The device will automatically power on when power is applied. Wait for the unit to boot up. When it's connected to a network switch by Ethernet cable, the device will acquire a network address via DHCP and automatically connect to the system.

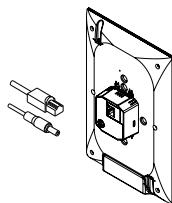

## E. Mounting the device

Loosen the captive screws of the unit first. Screws should not be moved apart from the unit. Please meet the indicated line. Align the mounting frame hooks with the mounting slots and gently pull the unit down the mounting bracket. Make sure the mounting hooks are properly engaged. To complete the installation, tighten the 2-captive screws on the bottom part of unit, to secure the device on the mounting bracket.

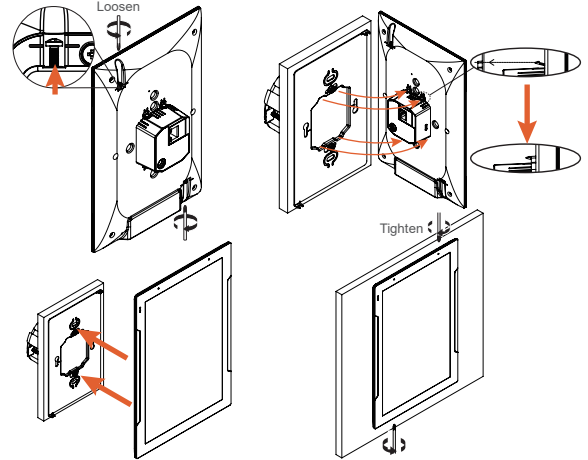

CAUTION: DO NOT PRESS DIRECTLY ON THE SCREEN when installing on to the mounting bracket. Press only on the frame edges.

## Removing the device

Using a precision Philips head screw driver to loosen the 2-captive screws on the device, then slightly pull straight up from the mounting frame to disengage the unit.

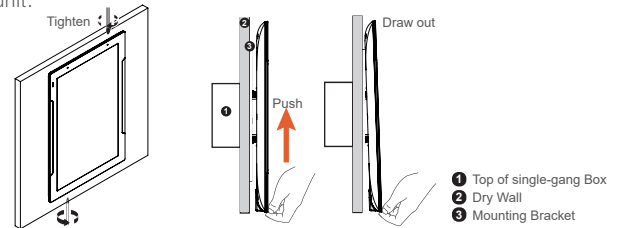

Thank you for including the device as part of the user interface strategy for your customer. The device has been designed to provide years of trouble free operation when wired and installed properly. The device is designed for installation in low humidity indoor environments and should never be installed outdoors or in high humidity areas.



### Temperature ranges/humidity

Operating	±0 °C to +45 °C
Storage/transport	-20 °C to +70 °C
Relative humidity	max. 95%(no condensation)

Any changes or modifications not expressly approved by the grantee of this device could void the user's authority to operate the equipment. This device complies with Part 15 of the FCC Rules. Operation is subject to the following two conditions: (1) this device may not cause harmful interference, and (2) this device must accept any interference received, including interference that may cause undesired operation.

### RF exposure warning

This equipment must be installed and operated in accordance with provided instructions and the antenna(s) used for this transmitter must be installed to provide a separation distance of at least 20 cm from all persons and must not be co-located or operating in conjunction with any other antenna or transmitter. End-users and installers must be provided with antenna installation instructions and transmitter operating conditions for satisfying RF exposure compliance.

### Canada, Industry Canada (IC) Notices

This device complies with Canada licence-exempt RSS standard(s). Operation is subject to the following two conditions: (1) this device may not cause interference, and (2) this device must accept any interference, including interference that may cause undesired operation of the device.

### Canada, avis d'Industrie Canada (IC)

Cet appareil est conforme avec Industrie Canada exemptes de licence RSS standard(s). Son fonctionnement est soumis aux deux conditions suivantes : (1) cet appareil ne doit pas causer d'interférence et (2) cet appareil doit accepter toute interférence, notamment les interférences qui peuvent affecter son fonctionnement.