

## FCC Test Report

**Report No.:** RFBHNI-WTW-P21010896

**FCC ID:** 2AGPT-PLR2

**Test Model:** 2AGPT-PLR2

**Received Date:** Jan. 29, 2021

**Test Date:** Feb. 24, 2021 ~ Jan. 27, 2022

**Issued Date:** Mar. 03, 2022

**Applicant:** SolarEdge Technologies Ltd.

**Address:** 1 HaMada Street, Herzeliya 4673335, Israel

**Issued By:** Bureau Veritas Consumer Products Services (H.K.) Ltd., Taoyuan Branch  
Lin Kou Laboratories

**Lab Address:** No. 47-2, 14th Ling, Chia Pau Vil., Lin Kou Dist., New Taipei City, Taiwan

**Test Location:** No.19, Hwa Ya 2nd Rd., Wen Hwa Vil., Kwei Shan Dist., Taoyuan City  
33383, Taiwan

**FCC Registration /  
Designation Number:** 788550 / TW0003



This report is for your exclusive use. Any copying or replication of this report to or for any other person or entity, or use of our name or trademark, is permitted only with our prior written permission. This report sets forth our findings solely with respect to the test samples identified herein. The results set forth in this report are not indicative or representative of the quality or characteristics of the lot from which a test sample was taken or any similar or identical product unless specifically and expressly noted. Our report includes all of the tests requested by you and the results thereof based upon the information that you provided to us. You have 60 days from date of issuance of this report to notify us of any material error or omission caused by our negligence, provided, however, that such notice shall be in writing and shall specifically address the issue you wish to raise. A failure to raise such issue within the prescribed time shall constitute your unqualified acceptance of the completeness of this report, the tests conducted and the correctness of the report contents. Unless specific mention, the uncertainty of measurement has been explicitly taken into account to declare the compliance or non-compliance to the specification.

## Table of Contents

<b>Release Control Record</b> .....	<b>4</b>
<b>1 Certificate of Conformity</b> .....	<b>5</b>
<b>2 Summary of Test Results</b> .....	<b>6</b>
2.1 Measurement Uncertainty .....	6
2.2 Modification Record .....	6
<b>3 General Information</b> .....	<b>7</b>
3.1 General Description of EUT .....	7
3.2 Description of Test Modes .....	8
3.2.1 Test Mode Applicability and Tested Channel Detail .....	9
3.3 Duty Cycle of Test Signal .....	11
3.4 Description of Support Units .....	13
3.4.1 Configuration of System under Test .....	13
3.5 General Description of Applied Standards and References .....	13
<b>4 Test Types and Results</b> .....	<b>14</b>
4.1 Radiated Emission and Bandedge Measurement .....	14
4.1.1 Limits of Radiated Emission and Bandedge Measurement .....	14
4.1.2 Test Instruments .....	15
4.1.3 Test Procedures .....	16
4.1.4 Deviation from Test Standard .....	16
4.1.5 Test Set Up .....	17
4.1.6 EUT Operating Conditions .....	18
4.1.7 Test Results .....	19
4.2 Conducted Emission Measurement .....	41
4.2.1 Limits of Conducted Emission Measurement .....	41
4.2.2 Test Instruments .....	41
4.2.3 Test Procedures .....	42
4.2.4 Deviation from Test Standard .....	42
4.2.5 Test Setup .....	42
4.2.6 EUT Operating Conditions .....	42
4.2.7 Test Results .....	43
4.3 6 dB Bandwidth Measurement .....	47
4.3.1 Limits of 6 dB Bandwidth Measurement .....	47
4.3.2 Test Setup .....	47
4.3.3 Test Instruments .....	47
4.3.4 Test Procedure .....	47
4.3.5 Deviation from Test Standard .....	47
4.3.6 EUT Operating Conditions .....	47
4.3.7 Test Results .....	48
4.4 Occupied Bandwidth Measurement .....	52
4.4.1 Test Setup .....	52
4.4.2 Test Instruments .....	52
4.4.3 Test Procedure .....	52
4.4.4 Deviation from Test Standard .....	52
4.4.5 EUT Operating Conditions .....	52
4.4.6 Test Results .....	53
4.5 Conducted Output Power Measurement .....	57
4.5.1 Limits of Conducted Output Power Measurement .....	57
4.5.2 Test Setup .....	57
4.5.3 Test Instruments .....	57
4.5.4 Test Procedures .....	57
4.5.5 Deviation from Test Standard .....	57
4.5.6 EUT Operating Conditions .....	57
4.5.7 Test Results .....	58

4.6	Power Spectral Density Measurement .....	60
4.6.1	Limits of Power Spectral Density Measurement.....	60
4.6.2	Test Setup.....	60
4.6.3	Test Instruments .....	60
4.6.4	Test Procedure .....	60
4.6.5	Deviation from Test Standard .....	60
4.6.6	EUT Operating Condition .....	60
4.6.7	Test Results .....	61
4.7	Conducted Out of Band Emission Measurement .....	65
4.7.1	Limits of Conducted Out of Band Emission Measurement.....	65
4.7.2	Test Setup.....	65
4.7.3	Test Instruments .....	65
4.7.4	Test Procedure .....	65
4.7.5	Deviation from Test Standard .....	65
4.7.6	EUT Operating Condition .....	65
4.7.7	Test Results .....	66
<b>5</b>	<b>Pictures of Test Arrangements.....</b>	<b>72</b>
	<b>Annex A- Band Edge Measurement .....</b>	<b>73</b>
	<b>Appendix – Information of the Testing Laboratories .....</b>	<b>79</b>

### Release Control Record

Issue No.	Description	Date Issued
RFBHNI-WTW-P21010896	Original Release	Mar. 03, 2022

## 1 Certificate of Conformity

**Product:** Linux communication board

**Brand:** SolarEdge

**Test Model:** 2AGPT-PLR2

**Sample Status:** Engineering Sample

**Applicant:** SolarEdge Technologies Ltd.

**Test Date:** Feb. 24, 2021 ~ Jan. 27, 2022

**Standards:** 47 CFR FCC Part 15, Subpart C (Section 15.247)  
ANSI C63.10:2013

The above equipment has been tested by **Bureau Veritas Consumer Products Services (H.K.) Ltd., Taoyuan Branch**, and found compliance with the requirement of the above standards. The test record, data evaluation & Equipment Under Test (EUT) configurations represented herein are true and accurate accounts of the measurements of the sample's RF characteristics under the conditions specified in this report.

**Prepared by :** Gina Liu, **Date:** Mar. 03, 2022  
Gina Liu / Specialist

**Approved by :** Jeremy Lin, **Date:** Mar. 03, 2022  
Jeremy Lin / Project Engineer

## 2 Summary of Test Results

47 CFR FCC Part 15, Subpart C (Section 15.247)			
FCC Clause	Test Item	Result	Remarks
15.207	AC Power Conducted Emission	Pass	Meet the requirement of limit. Minimum passing margin is -11.41 dB at 0.32458 MHz.
15.205 / 15.209 / 15.247(d)	Radiated Emissions and Band Edge Measurement	Pass	Meet the requirement of limit. Minimum passing margin is -0.6 dB at 4824.00 MHz.
15.247(d)	Antenna Port Emission	Pass	Meet the requirement of limit.
15.247(a)(2)	6 dB Bandwidth	Pass	Meet the requirement of limit.
---	Occupied Bandwidth Measurement	Pass	Reference only
15.247(b)	Conducted power	Pass	Meet the requirement of limit.
15.247(e)	Power Spectral Density	Pass	Meet the requirement of limit.
15.203	Antenna Requirement	Pass	Antenna connector is RSMA not a standard connector.

Note:

- For 2.4G band compliance with rule 15.247(d) of the band-edge items, the test plots were recorded in Annex A. Test Procedures refer to report 4.1.3.
- Determining compliance based on the results of the compliance measurement, not taking into account measurement instrumentation uncertainty.

### 2.1 Measurement Uncertainty

Where relevant, the following measurement uncertainty levels have been estimated for tests performed on the EUT as specified in CISPR 16-4-2:

Measurement	Frequency	Expanded Uncertainty (k=2) (±)
Conducted Emissions at mains ports	150 kHz ~ 30 MHz	2.79 dB
Radiated Emissions up to 1 GHz	9 kHz ~ 30 MHz	3.04 dB
	30 MHz ~ 200 MHz	2.93 dB
	200 MHz ~ 1000 MHz	2.95 dB
Radiated Emissions above 1 GHz	1 GHz ~ 18 GHz	2.26 dB
	18 GHz ~ 40 GHz	1.94 dB

### 2.2 Modification Record

There were no modifications required for compliance.

### 3 General Information

#### 3.1 General Description of EUT

<b>Product</b>	Linux communication board
<b>Brand</b>	SolarEdge
<b>Test Model</b>	2AGPT-PLR2
<b>Status of EUT</b>	Engineering Sample
<b>Power Supply Rating</b>	5.0 Vdc (adapter)
<b>Modulation Type</b>	CCK, DQPSK, DBPSK for DSSS 64QAM, 16QAM, QPSK, BPSK for OFDM
<b>Modulation Technology</b>	DSSS, OFDM
<b>Transfer Rate</b>	802.11b: 11.0 / 5.5 / 2.0 / 1.0 Mbps 802.11g: 54.0 / 48.0 / 36.0 / 24.0 / 18.0 / 12.0 / 9.0 / 6.0 Mbps 802.11n: up to MCS7
<b>Operating Frequency</b>	2412 ~ 2462 MHz
<b>Number of Channel</b>	11 for 802.11b, 802.11g, 802.11n (HT20)
<b>Output Power</b>	Chip antenna: 13.677 mW Dipole antenna: 42.756 mW
<b>Antenna Type</b>	Chip antenna with 0.5 dBi gain Dipole antenna with 5.0 dBi gain
<b>Antenna Connector</b>	Chip Antenna: none (like solder) Dipole Antenna: R-SMA
<b>Accessory Device</b>	Antenna
<b>Data Cable Supplied</b>	N/A

Note:

- The EUT incorporates a SISO function. Physically, the EUT provides one completed transmitter and one receiver.

Modulation Mode	TX Function
802.11b	1TX (SISO)
802.11g	1TX (SISO)
802.11n (HT20)	1TX (SISO)

- The EUT contains following accessory devices.

Product	Brand	Model	Description
Chip Antenna	ACX	AT3216-A2R8HAA	-
Dipole Antenna	solaredge	AS4032-1	-

- The above Antenna information is declared by manufacturer and for more detailed features description, please refer to the manufacturer's specifications, the laboratory shall not be held responsible.
- The above EUT information is declared by manufacturer and for more detailed features description, please refers to the manufacturer's specifications or user's manual.

### 3.2 Description of Test Modes

11 channels are provided for 802.11b, 802.11g and 802.11n (HT20):

Channel	Frequency (MHz)	Channel	Frequency (MHz)
1	2412	7	2442
2	2417	8	2447
3	2422	9	2452
4	2427	10	2457
5	2432	11	2462
6	2437		



### 3.2.1 Test Mode Applicability and Tested Channel Detail

EUT Configure Mode	Applicable To				Description
	RE≥1G	RE<1G	PLC	APCM	
A	√	√	√	√	Chip Antenna
B	√	√	√	√	Dipole Antenna

Where **RE≥1G**: Radiated Emission above 1 GHz      **RE<1G**: Radiated Emission below 1 GHz  
**PLC**: Power Line Conducted Emission      **APCM**: Antenna Port Conducted Measurement

**NOTE:** The EUT had been pre-tested on the positioned of each 3 axis. The worst case was found when positioned on **X-plane** for Mode A and **Z-plane** for Mode B.

**NOTE:** “-” means no effect.

#### **Radiated Emission Test (Above 1 GHz):**

- Pre-Scan has been conducted to determine the worst-case mode from all possible combinations between available modulations, data rates and antenna ports (if EUT with antenna diversity architecture).
- Following channel(s) was (were) selected for the final test as listed below.

EUT Configure Mode	Mode	Available Channel	Tested Channel	Modulation Technology	Modulation Type	Data Rate (Mbps)
A, B	802.11b	1 to 11	1, 6, 11	DSSS	DBPSK	1.0
	802.11g	1 to 11	1, 6, 11	OFDM	BPSK	6.0
	802.11n (HT20)	1 to 11	1, 6, 11	OFDM	BPSK	6.5

#### **Radiated Emission Test (Below 1 GHz):**

- Pre-Scan has been conducted to determine the worst-case mode from all possible combinations between available modulations, data rates and antenna ports (if EUT with antenna diversity architecture).
- Following channel(s) was (were) selected for the final test as listed below.

EUT Configure Mode	Mode	Available Channel	Tested Channel	Modulation Technology	Modulation Type	Data Rate (Mbps)
B	802.11b	1 to 11	1	DSSS	DBPSK	1.0
A	802.11g	1 to 11	1	OFDM	BPSK	6.0

#### **Power Line Conducted Emission Test:**

- Pre-Scan has been conducted to determine the worst-case mode from all possible combinations between available modulations, data rates and antenna ports (if EUT with antenna diversity architecture).
- Following channel(s) was (were) selected for the final test as listed below.

EUT Configure Mode	Mode	Available Channel	Tested Channel	Modulation Technology	Modulation Type	Data Rate (Mbps)
B	802.11b	1 to 11	1	DSSS	DBPSK	1.0
A	802.11g	1 to 11	1	OFDM	BPSK	6.0

### **Bandedge Measurement:**

- Pre-Scan has been conducted to determine the worst-case mode from all possible combinations between available modulations, data rates and antenna ports (if EUT with antenna diversity architecture).
- Following channel(s) was (were) selected for the final test as listed below.

EUT Configure Mode	Mode	Available Channel	Tested Channel	Modulation Technology	Modulation Type	Data Rate (Mbps)
A, B	802.11b	1 to 11	1, 11	DSSS	DBPSK	1.0
A, B	802.11g	1 to 11	1, 11	OFDM	BPSK	6.0
A, B	802.11n (HT20)	1 to 11	1, 11	OFDM	BPSK	6.5

### **Antenna Port Conducted Measurement:**

- This item includes all test value of each mode, but only includes spectrum plot of worst value of each mode.
- Pre-Scan has been conducted to determine the worst-case mode from all possible combinations between available modulations, data rates and antenna ports (if EUT with antenna diversity architecture).
- Following channel(s) was (were) selected for the final test as listed below.

EUT Configure Mode	Mode	Available Channel	Tested Channel	Modulation Technology	Modulation Type	Data Rate (Mbps)
A, B	802.11b	1 to 11	1, 6, 11	DSSS	DBPSK	1.0
A, B	802.11g	1 to 11	1, 6, 11	OFDM	BPSK	6.0
A, B	802.11n (HT20)	1 to 11	1, 6, 11	OFDM	BPSK	6.5

### **Test Condition:**

Applicable To	Environmental Conditions	Input Power	Tested by
RE $\geq$ 1G	22 deg. C, 68 % RH	120 Vac, 60 Hz	Greg Lin
RE<1G	22 deg. C, 68 % RH	120 Vac, 60 Hz	Greg Lin
PLC	25 deg. C, 75 % RH	120 Vac, 60 Hz	Greg Lin
APCM	25 deg. C, 60 % RH	120 Vac, 60 Hz	Ivan Tseng

### 3.3 Duty Cycle of Test Signal

#### Mode A

**802.11b:** Duty cycle of test signal is 100 %, duty factor is not required.

**802.11g:** Duty cycle of test signal is 100 %, duty factor is not required.

**802.11n (HT20):** Duty cycle of test signal is 100 %, duty factor is not required.

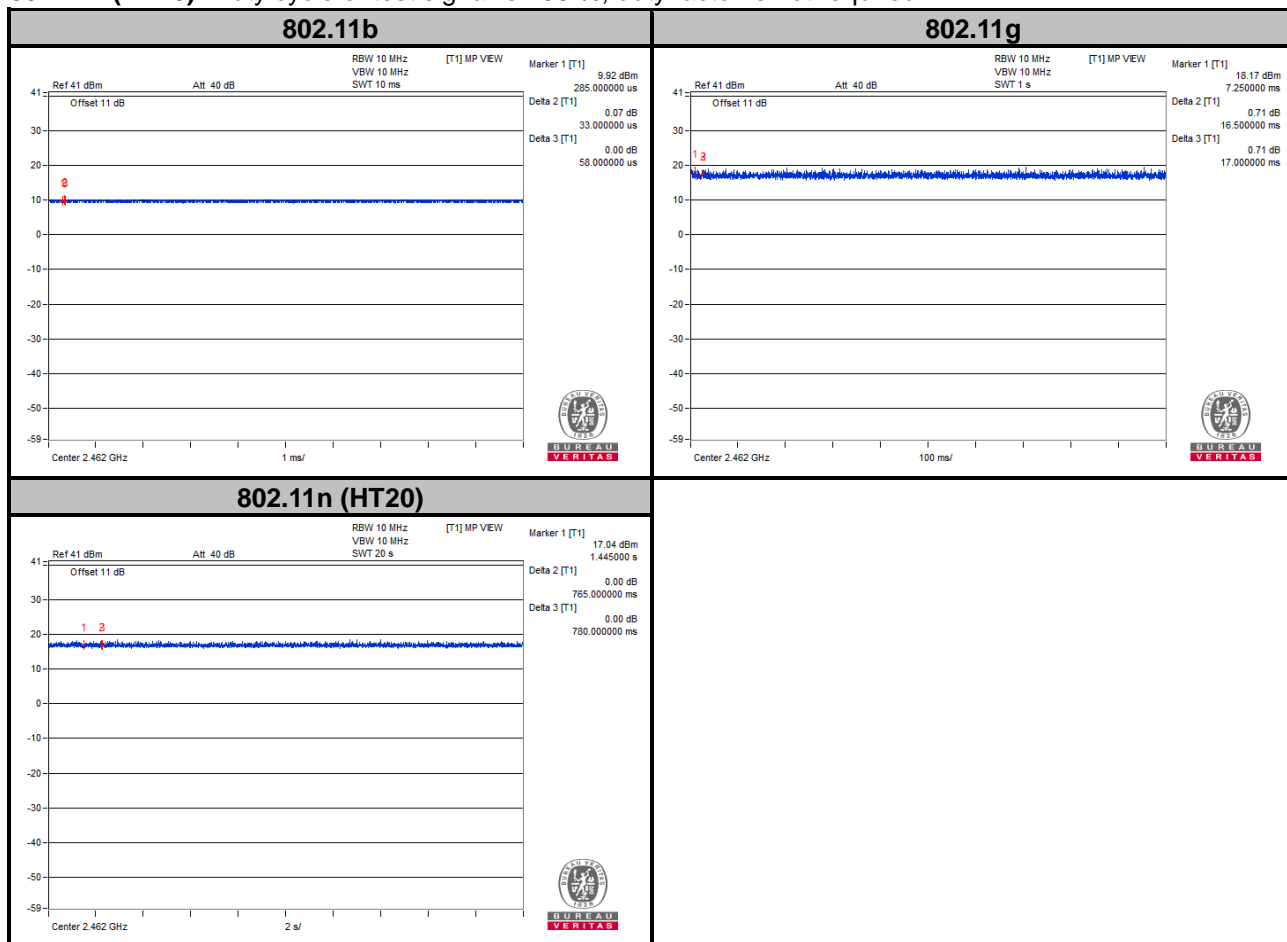

**Mode B**

**802.11b:** Duty cycle of test signal is 100 %, duty factor is not required.

**802.11g:** Duty cycle of test signal is 100 %, duty factor is not required.

**802.11n (HT20):** Duty cycle of test signal is 100 %, duty factor is not required.

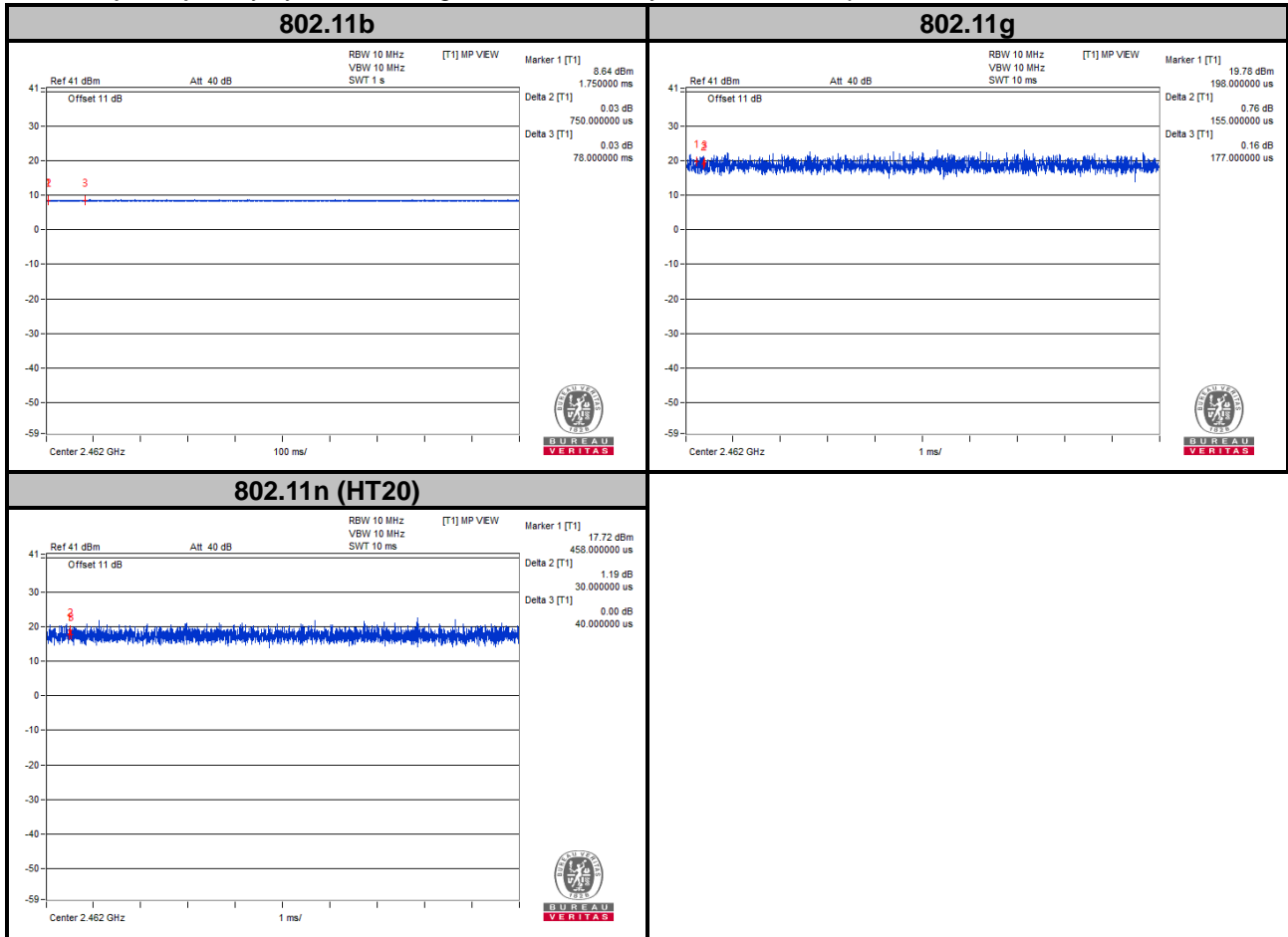

### 3.4 Description of Support Units

The EUT has been tested as an independent unit together with other necessary accessories or support units. The following support units or accessories were used to form a representative test configuration during the tests.

ID	Product	Brand	Model No.	Serial No.	FCC ID	Remarks
A.	Adapter	SWICHING POWER SUPPLY	EPU15-105	N/A	N/A	Provided by client

Note:

1. All power cords of the above support units are non-shielded (1.8m).

ID	Cable Descriptions	Qty.	Length (m)	Shielding (Yes/No)	Cores (Qty.)	Remarks
1.	DC Cable	1	2.0	N	0	Provided by client

#### 3.4.1 Configuration of System under Test

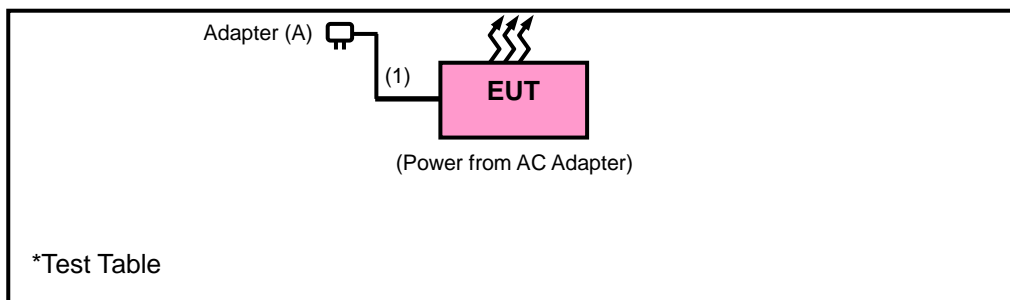

### 3.5 General Description of Applied Standards and References

The EUT is a RF Product. According to the specifications of the manufacturer, it must comply with the requirements of the following standards and references:

#### Test Standard:

##### FCC Part 15, Subpart C (15.247)

ANSI C63.10-2013

All test items have been performed and recorded as per the above standards.

#### References Test Guidance:

##### KDB 558074 D01 Meas Guidance v05r02

All test items have been performed as a reference to the above KDB test guidance.

## 4 Test Types and Results

### 4.1 Radiated Emission and Bandedge Measurement

#### 4.1.1 Limits of Radiated Emission and Bandedge Measurement

Radiated emissions which fall in the restricted bands must comply with the radiated emission limits specified as below table. Other emissions shall be at least 20 dB below the highest level of the desired power:

Frequencies (MHz)	Field Strength (microvolts/meter)	Measurement Distance (meters)
0.009 ~ 0.490	2400/F (kHz)	300
0.490 ~ 1.705	24000/F (kHz)	30
1.705 ~ 30.0	30	30
30 ~ 88	100	3
88 ~ 216	150	3
216 ~ 960	200	3
Above 960	500	3

**NOTE:**

1. The lower limit shall apply at the transition frequencies.
2. Emission level (dBuV/m) = 20 log Emission level (uV/m).
3. For frequencies above 1000 MHz, the field strength limits are based on average detector, however, the peak field strength of any emission shall not exceed the maximum permitted average limits, specified above by more than 20 dB under any condition of modulation.

#### 4.1.2 Test Instruments

Description & Manufacturer	Model No.	Serial No.	Date of Calibration	Due Date of Calibration
Test Receiver KEYSIGHT	N9038A	MY55420137	Apr. 20, 2020	Apr. 19, 2021
			Apr. 09, 2021	Apr. 08, 2022
Spectrum Analyzer ROHDE & SCHWARZ	FSP40	100039	Jun. 12, 2020	Jun. 11, 2021
			Jun. 10, 2021	Jun. 09, 2022
BILOG Antenna SCHWARZBECK	VULB9168	9168-160	Nov. 06, 2020	Nov. 05, 2021
			Nov. 05, 2021	Nov. 04, 2022
HORN Antenna SCHWARZBECK	BBHA 9120 D	9120D-1169	Nov. 22, 2020	Nov. 21, 2021
			Nov. 21, 2021	Nov. 20, 2022
HORN Antenna SCHWARZBECK	BBHA 9170	BBHA9170241	Nov. 22, 2020	Nov. 21, 2021
			Nov. 21, 2021	Nov. 20, 2022
Preamplifier Agilent (Below 1GHz)	8447D	2944A10638	Jun. 08, 2020	Jun. 07, 2021
			Jun. 05, 2021	Jun. 04, 2022
Preamplifier Agilent (Above 1GHz)	8449B	3008A02367	Feb. 17, 2021	Feb. 16, 2022
RF signal cable HUBER+SUHNER&EMCI	SUCOFLEX 104 & EMC104-SM-SM80 00	CABLE-CH9-02 (248780+171006)	Jan. 16, 2021	Jan. 15, 2022
			Jan. 15, 2022	Jan. 14, 2023
RF signal cable HUBER+SUHNER	SUCOFLEX 104	CABLE-CH9-(2507 95/4)	Jan. 16, 2021	Jan. 15, 2022
			Jan. 15, 2022	Jan. 14, 2023
RF signal cable Woken	8D-FB	Cable-CH9-01	Jun. 08, 2020	Jun. 07, 2021
			Jun. 05, 2021	Jun. 04, 2022
Software BV ADT	ADT_Radiated_ V7.6.15.9.5	NA	NA	NA
Antenna Tower EMCO	2070/2080	512.835.4684	NA	NA
Turn Table EMCO	2087-2.03	NA	NA	NA
Antenna Tower & Turn BV ADT	AT100	AT93021705	NA	NA
Turn Table BV ADT	TT100	TT93021705	NA	NA
Turn Table Controller BV ADT	SC100	SC93021705	NA	NA
Pre-amplifier (18GHz-40GHz) EMC	EMC184045B	980175	Sep. 04, 2020	Sep. 03, 2021
			Sep. 04, 2021	Sep. 03, 2022
Boresight Antenna Fixture	FBA-01	FBA-SIP01	NA	NA
USB Wideband Power Sensor KEYSIGHT	U2021XA	MY55050005/MY55 190004/MY551900 07/MY55210005	Jul. 13, 2020	Jul. 12, 2021
			Jul. 12, 2021	Jul. 11, 2022
DC source IDRC	DSP-030-025HD	500158	Jul. 10, 2020	Jul. 09, 2021
			Jul. 08, 2021	Jul. 07, 2022
Temperature chamber WIT	TH-4S-C	W981030	Jun. 04, 2020	Jun. 03, 2021
			Jun. 01, 2021	May 31, 2022

- Note: 1. The calibration interval of the above test instruments is 12 months and the calibrations are traceable to NML/ROC and NIST/USA.  
2. The test was performed in HwaYa Chamber 9.

#### 4.1.3 Test Procedures

##### **For Radiated Emission below 30 MHz**

- a. The EUT was placed on the top of a rotating table 0.8 meters above the ground at a 3 meter chamber room. The table was rotated 360 degrees to determine the position of the highest radiation.
- b. The EUT was set 3 meters away from the interference-receiving antenna, which was mounted on the top of a variable-height antenna tower.
- c. Parallel, perpendicular, and ground-parallel orientations of the antenna are set to make the measurement.
- d. For each suspected emission, the EUT was arranged to its worst case and the rotatable table was turned from 0 degrees to 360 degrees to find the maximum reading.
- e. The test-receiver system was set to Quasi-Peak Detect Function and Specified Bandwidth with Maximum Hold Mode.

##### **Note:**

1. The resolution bandwidth and video bandwidth of test receiver/spectrum analyzer is 9 kHz at frequency below 30 MHz.

##### **For Radiated Emission above 30 MHz**

- a. The EUT was placed on the top of a rotating table 0.8 meters (for 30 MHz ~ 1 GHz) / 1.5 meters (for above 1 GHz) above the ground at 3 meter chamber room for test. The table was rotated 360 degrees to determine the position of the highest radiation.
- b. The EUT was set 3 meters away from the interference-receiving antenna, which was mounted on the top of a variable-height antenna tower.
- c. The height of antenna is varied from one meter to four meters above the ground to determine the maximum value of the field strength. Both horizontal and vertical polarizations of the antenna are set to make the measurement.
- d. For each suspected emission, the EUT was arranged to its worst case and then the antenna was tuned to heights from 1 meter to 4 meters and the rotatable table was turned from 0 degrees to 360 degrees to find the maximum reading.
- e. The test-receiver system was set to quasi-peak detect function and specified bandwidth with maximum hold mode when the test frequency is below 1 GHz.
- f. The test-receiver system was set to peak and average detected function and specified bandwidth with maximum hold mode when the test frequency is above 1 GHz. If the peak reading value also meets average limit, measurement with the average detector is unnecessary.

##### **Note:**

1. The resolution bandwidth and video bandwidth of test receiver/spectrum analyzer is 120 kHz for Quasi-peak detection (QP) or Peak detection (PK) at frequency below 1 GHz.
2. The resolution bandwidth of test receiver/spectrum analyzer is 1 MHz and the video bandwidth is 3 MHz for Peak detection (PK) at frequency above 1 GHz.
3. The resolution bandwidth of test receiver/spectrum analyzer is 1 MHz and the video bandwidth is  $\geq 1/T$  (Duty cycle < 98 %) or 10 Hz (Duty cycle  $\geq 98$  %) for Average detection (AV) at frequency above 1 GHz. (11b: RBW = 1 MHz, VBW = 10 Hz ; 11g: RBW = 1 MHz, VBW = 10 Hz ; 11n (HT20): RBW = 1 MHz, VBW = 10 Hz)
4. All modes of operation were investigated and the worst-case emissions are reported.

#### 4.1.4 Deviation from Test Standard

No deviation.



#### 4.1.5 Test Set Up

##### <Radiated Emission below 30 MHz>

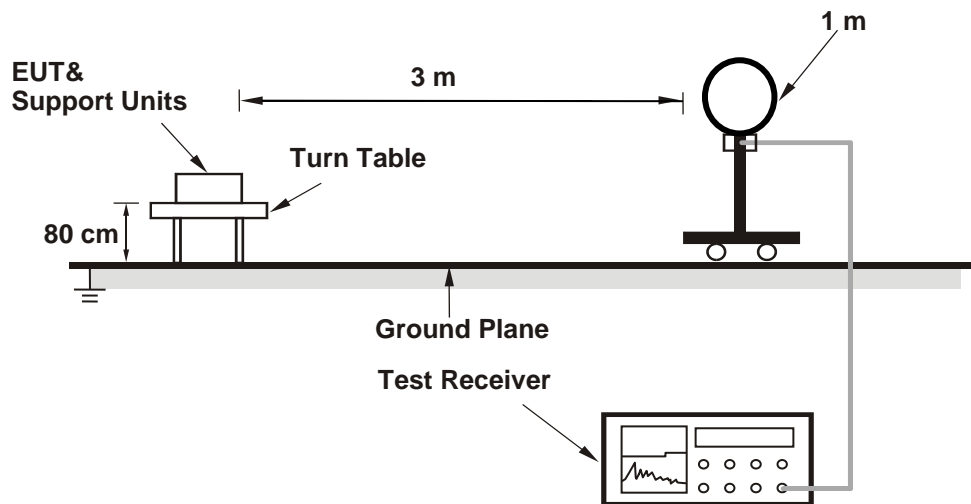

##### <Radiated Emission 30 MHz to 1 GHz>

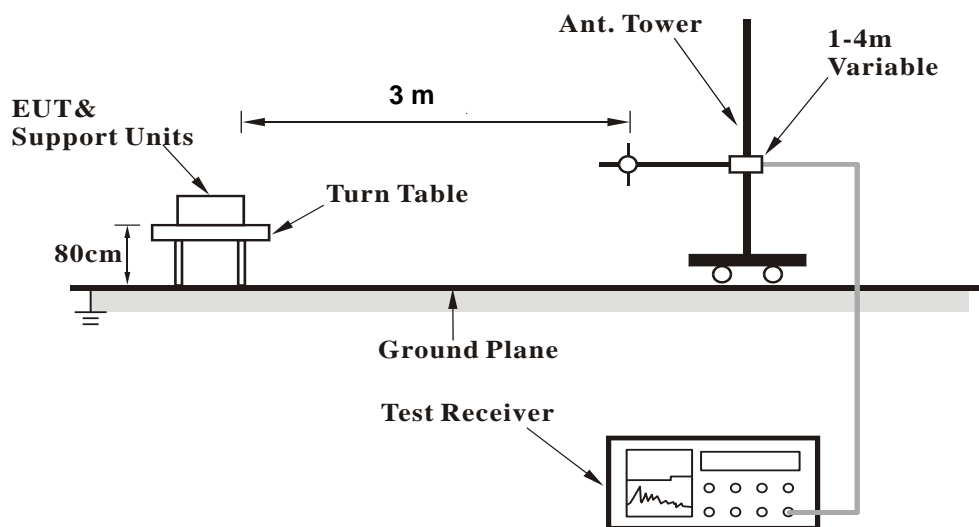

**<Radiated Emission above 1 GHz>**

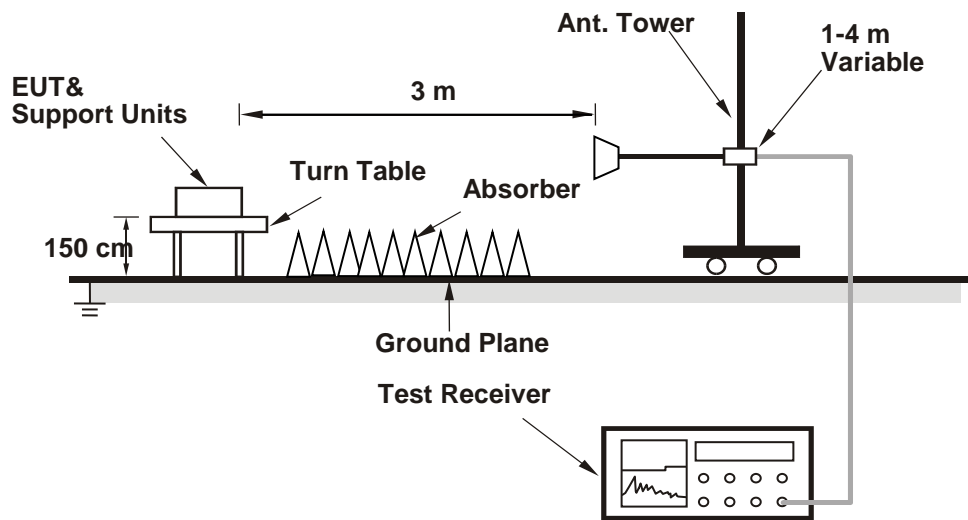

For the actual test configuration, please refer to the attached file (Test Setup Photo).

**4.1.6 EUT Operating Conditions**

- a. Placed the EUT on a testing table.
- b. Use the software to control the EUT under transmission condition continuously at specific channel frequency.

#### 4.1.7 Test Results

#### Above 1 GHz Data :

#### Mode A

<b>RF Mode</b>	TX 802.11b	<b>Channel</b>	CH 1 : 2412 MHz
<b>Frequency Range</b>	1GHz ~ 25GHz	<b>Detector Function</b>	Peak (PK) Average (AV)

Antenna Polarity & Test Distance : Horizontal at 3 m								
No	Frequency (MHz)	Emission Level (dBuV/m)	Limit (dBuV/m)	Margin (dB)	Antenna Height (m)	Table Angle (Degree)	Raw Value (dBuV)	Correction Factor (dB/m)
1	2390.00	56.5 PK	74.0	-17.5	1.47 H	175	25.3	31.2
2	2390.00	42.8 AV	54.0	-11.2	1.47 H	175	11.6	31.2
3	*2412.00	82.6 PK			1.47 H	175	51.4	31.2
4	*2412.00	79.3 AV			1.47 H	175	48.1	31.2
5	4824.00	55.7 PK	74.0	-18.3	1.02 H	108	53.6	2.1
6	4824.00	53.2 AV	54.0	-0.8	1.02 H	108	51.1	2.1
Antenna Polarity & Test Distance : Vertical at 3 m								
No	Frequency (MHz)	Emission Level (dBuV/m)	Limit (dBuV/m)	Margin (dB)	Antenna Height (m)	Table Angle (Degree)	Raw Value (dBuV)	Correction Factor (dB/m)
1	2390.00	55.8 PK	74.0	-18.2	2.38 V	279	24.6	31.2
2	2390.00	42.6 AV	54.0	-11.4	2.38 V	279	11.4	31.2
3	*2412.00	79.1 PK			2.38 V	279	47.9	31.2
4	*2412.00	75.8 AV			2.38 V	279	44.6	31.2
5	4824.00	54.9 PK	74.0	-19.1	2.96 V	43	52.8	2.1
6	4824.00	52.4 AV	54.0	-1.6	2.96 V	43	50.3	2.1

#### Remarks:

1. Emission Level(dBuV/m) = Raw Value(dBuV) + Correction Factor(dB/m)
2. Correction Factor(dB/m) = Antenna Factor(dB/m) + Cable Factor(dB) – Pre-Amplifier Factor(dB)
3. Margin value = Emission Level – Limit value
4. The other emission levels were very low against the limit.
5. " \* ": Fundamental frequency.

<b>RF Mode</b>	TX 802.11b	<b>Channel</b>	CH 6 : 2437 MHz
<b>Frequency Range</b>	1GHz ~ 25GHz	<b>Detector Function</b>	Peak (PK) Average (AV)

Antenna Polarity & Test Distance : Horizontal at 3 m								
No	Frequency (MHz)	Emission Level (dBuV/m)	Limit (dBuV/m)	Margin (dB)	Antenna Height (m)	Table Angle (Degree)	Raw Value (dBuV)	Correction Factor (dB/m)
1	*2437.00	81.3 PK			1.47 H	175	50.2	31.1
2	*2437.00	78.0 AV			1.47 H	175	46.9	31.1
3	4874.00	55.4 PK	74.0	-18.6	1.00 H	110	53.3	2.1
4	4874.00	53.1 AV	54.0	-0.9	1.00 H	110	51.0	2.1
Antenna Polarity & Test Distance : Vertical at 3 m								
No	Frequency (MHz)	Emission Level (dBuV/m)	Limit (dBuV/m)	Margin (dB)	Antenna Height (m)	Table Angle (Degree)	Raw Value (dBuV)	Correction Factor (dB/m)
1	*2437.00	77.9 PK			2.52 V	283	46.8	31.1
2	*2437.00	74.6 AV			2.52 V	283	43.5	31.1
3	4874.00	54.6 PK	74.0	-19.4	2.92 V	33	52.5	2.1
4	4874.00	52.4 AV	54.0	-1.6	2.92 V	33	50.3	2.1

**Remarks:**

1. Emission Level(dBuV/m) = Raw Value(dBuV) + Correction Factor(dB/m)
2. Correction Factor(dB/m) = Antenna Factor(dB/m) + Cable Factor(dB) – Pre-Amplifier Factor(dB)
3. Margin value = Emission Level – Limit value
4. The other emission levels were very low against the limit.
5. " \* ": Fundamental frequency.

<b>RF Mode</b>	TX 802.11b	<b>Channel</b>	CH 11 : 2462 MHz
<b>Frequency Range</b>	1GHz ~ 25GHz	<b>Detector Function</b>	Peak (PK) Average (AV)

Antenna Polarity & Test Distance : Horizontal at 3 m								
No	Frequency (MHz)	Emission Level (dBuV/m)	Limit (dBuV/m)	Margin (dB)	Antenna Height (m)	Table Angle (Degree)	Raw Value (dBuV)	Correction Factor (dB/m)
1	*2462.00	82.0 PK			1.42 H	177	50.9	31.1
2	*2462.00	78.7 AV			1.42 H	177	47.6	31.1
3	2483.50	55.7 PK	74.0	-18.3	1.42 H	177	24.6	31.1
4	2483.50	45.3 AV	54.0	-8.7	1.42 H	177	14.2	31.1
5	4924.00	55.7 PK	74.0	-18.3	1.00 H	111	53.6	2.1
6	4924.00	53.3 AV	54.0	-0.7	1.00 H	111	51.2	2.1
Antenna Polarity & Test Distance : Vertical at 3 m								
No	Frequency (MHz)	Emission Level (dBuV/m)	Limit (dBuV/m)	Margin (dB)	Antenna Height (m)	Table Angle (Degree)	Raw Value (dBuV)	Correction Factor (dB/m)
1	*2462.00	78.6 PK			2.49 V	286	47.5	31.1
2	*2462.00	75.3 AV			2.49 V	286	44.2	31.1
3	2483.50	55.4 PK	74.0	-18.6	2.49 V	286	24.3	31.1
4	2483.50	45.0 AV	54.0	-9.0	2.49 V	286	13.9	31.1
5	4924.00	54.9 PK	74.0	-19.1	3.03 V	38	52.8	2.1
6	4924.00	52.5 AV	54.0	-1.5	3.03 V	38	50.4	2.1

**Remarks:**

1. Emission Level(dBuV/m) = Raw Value(dBuV) + Correction Factor(dB/m)
2. Correction Factor(dB/m) = Antenna Factor(dB/m) + Cable Factor(dB) – Pre-Amplifier Factor(dB)
3. Margin value = Emission Level – Limit value
4. The other emission levels were very low against the limit.
5. " \* ": Fundamental frequency.

<b>RF Mode</b>	TX 802.11g	<b>Channel</b>	CH 1 : 2412 MHz
<b>Frequency Range</b>	1GHz ~ 25GHz	<b>Detector Function</b>	Peak (PK) Average (AV)

**Antenna Polarity & Test Distance : Horizontal at 3 m**

No	Frequency (MHz)	Emission Level (dBuV/m)	Limit (dBuV/m)	Margin (dB)	Antenna Height (m)	Table Angle (Degree)	Raw Value (dBuV)	Correction Factor (dB/m)
1	2390.00	66.1 PK	74.0	-7.9	1.47 H	174	34.9	31.2
2	2390.00	48.4 AV	54.0	-5.6	1.47 H	174	17.2	31.2
3	*2412.00	90.0 PK			1.47 H	174	58.8	31.2
4	*2412.00	80.0 AV			1.47 H	174	48.8	31.2
5	4824.00	68.9 PK	74.0	-5.1	1.00 H	109	66.8	2.1
<b>6</b>	<b>4824.00</b>	<b>53.4 AV</b>	<b>54.0</b>	<b>-0.6</b>	<b>1.00 H</b>	<b>109</b>	<b>51.3</b>	<b>2.1</b>

**Antenna Polarity & Test Distance : Vertical at 3 m**

No	Frequency (MHz)	Emission Level (dBuV/m)	Limit (dBuV/m)	Margin (dB)	Antenna Height (m)	Table Angle (Degree)	Raw Value (dBuV)	Correction Factor (dB/m)
1	2390.00	63.0 PK	74.0	-11.0	2.42 V	288	31.8	31.2
2	2390.00	47.3 AV	54.0	-6.7	2.42 V	288	16.1	31.2
3	*2412.00	86.7 PK			2.42 V	288	55.5	31.2
4	*2412.00	76.6 AV			2.42 V	288	45.4	31.2
5	4824.00	68.0 PK	74.0	-6.0	2.98 V	42	65.9	2.1
6	4824.00	52.5 AV	54.0	-1.5	2.98 V	42	50.4	2.1

**Remarks:**

1. Emission Level(dBuV/m) = Raw Value(dBuV) + Correction Factor(dB/m)
2. Correction Factor(dB/m) = Antenna Factor(dB/m) + Cable Factor(dB) – Pre-Amplifier Factor(dB)
3. Margin value = Emission Level – Limit value
4. The other emission levels were very low against the limit.
5. " \* ": Fundamental frequency.

<b>RF Mode</b>	TX 802.11g	<b>Channel</b>	CH 6 : 2437 MHz
<b>Frequency Range</b>	1GHz ~ 25GHz	<b>Detector Function</b>	Peak (PK) Average (AV)

Antenna Polarity & Test Distance : Horizontal at 3 m								
No	Frequency (MHz)	Emission Level (dBuV/m)	Limit (dBuV/m)	Margin (dB)	Antenna Height (m)	Table Angle (Degree)	Raw Value (dBuV)	Correction Factor (dB/m)
1	*2437.00	88.9 PK			1.45 H	176	57.8	31.1
2	*2437.00	78.4 AV			1.45 H	176	47.3	31.1
3	4874.00	68.0 PK	74.0	-6.0	1.03 H	110	65.9	2.1
4	4874.00	53.1 AV	54.0	-0.9	1.03 H	110	51.0	2.1
Antenna Polarity & Test Distance : Vertical at 3 m								
No	Frequency (MHz)	Emission Level (dBuV/m)	Limit (dBuV/m)	Margin (dB)	Antenna Height (m)	Table Angle (Degree)	Raw Value (dBuV)	Correction Factor (dB/m)
1	*2437.00	85.3 PK			2.46 V	283	54.2	31.1
2	*2437.00	74.9 AV			2.46 V	283	43.8	31.1
3	4874.00	66.9 PK	74.0	-7.1	2.96 V	38	64.8	2.1
4	4874.00	52.2 AV	54.0	-1.8	2.96 V	38	50.1	2.1

**Remarks:**

1. Emission Level(dBuV/m) = Raw Value(dBuV) + Correction Factor(dB/m)
2. Correction Factor(dB/m) = Antenna Factor(dB/m) + Cable Factor(dB) – Pre-Amplifier Factor(dB)
3. Margin value = Emission Level – Limit value
4. The other emission levels were very low against the limit.
5. " \* ": Fundamental frequency.

<b>RF Mode</b>	TX 802.11g	<b>Channel</b>	CH 11 : 2462 MHz
<b>Frequency Range</b>	1GHz ~ 25GHz	<b>Detector Function</b>	Peak (PK) Average (AV)

**Antenna Polarity & Test Distance : Horizontal at 3 m**

No	Frequency (MHz)	Emission Level (dBuV/m)	Limit (dBuV/m)	Margin (dB)	Antenna Height (m)	Table Angle (Degree)	Raw Value (dBuV)	Correction Factor (dB/m)
1	*2462.00	89.6 PK			1.42 H	176	58.5	31.1
2	*2462.00	79.3 AV			1.42 H	176	48.2	31.1
3	2483.50	66.9 PK	74.0	-7.1	1.42 H	176	35.8	31.1
4	2483.50	50.2 AV	54.0	-3.8	1.42 H	176	19.1	31.1
5	4924.00	68.4 PK	74.0	-5.6	1.04 H	111	66.3	2.1
6	4924.00	53.0 AV	54.0	-1.0	1.04 H	111	50.9	2.1

**Antenna Polarity & Test Distance : Vertical at 3 m**

No	Frequency (MHz)	Emission Level (dBuV/m)	Limit (dBuV/m)	Margin (dB)	Antenna Height (m)	Table Angle (Degree)	Raw Value (dBuV)	Correction Factor (dB/m)
1	*2462.00	86.1 PK			2.37 V	284	55.0	31.1
2	*2462.00	75.8 AV			2.37 V	284	44.7	31.1
3	2483.50	63.8 PK	74.0	-10.2	2.37 V	284	32.7	31.1
4	2483.50	49.4 AV	54.0	-4.6	2.37 V	284	18.3	31.1
5	4924.00	67.0 PK	74.0	-7.0	2.97 V	31	64.9	2.1
6	4924.00	52.2 AV	54.0	-1.8	2.97 V	31	50.1	2.1

**Remarks:**

1. Emission Level(dBuV/m) = Raw Value(dBuV) + Correction Factor(dB/m)
2. Correction Factor(dB/m) = Antenna Factor(dB/m) + Cable Factor(dB) – Pre-Amplifier Factor(dB)
3. Margin value = Emission Level – Limit value
4. The other emission levels were very low against the limit.
5. " \* ": Fundamental frequency.



<b>RF Mode</b>	TX 802.11n (HT20)	<b>Channel</b>	CH 1 : 2412 MHz
<b>Frequency Range</b>	1GHz ~ 25GHz	<b>Detector Function</b>	Peak (PK) Average (AV)

**Antenna Polarity & Test Distance : Horizontal at 3 m**

No	Frequency (MHz)	Emission Level (dBuV/m)	Limit (dBuV/m)	Margin (dB)	Antenna Height (m)	Table Angle (Degree)	Raw Value (dBuV)	Correction Factor (dB/m)
1	2390.00	64.9 PK	74.0	-9.1	1.50 H	176	33.7	31.2
2	2390.00	49.6 AV	54.0	-4.4	1.50 H	176	18.4	31.2
3	*2412.00	90.4 PK			1.50 H	176	59.2	31.2
4	*2412.00	79.0 AV			1.50 H	176	47.8	31.2
5	4824.00	65.7 PK	74.0	-8.3	1.00 H	110	63.6	2.1
6	4824.00	53.2 AV	54.0	-0.8	1.00 H	110	51.1	2.1

**Antenna Polarity & Test Distance : Vertical at 3 m**

No	Frequency (MHz)	Emission Level (dBuV/m)	Limit (dBuV/m)	Margin (dB)	Antenna Height (m)	Table Angle (Degree)	Raw Value (dBuV)	Correction Factor (dB/m)
1	2390.00	61.8 PK	74.0	-12.2	2.48 V	283	30.6	31.2
2	2390.00	46.4 AV	54.0	-7.6	2.48 V	283	15.2	31.2
3	*2412.00	85.9 PK			2.48 V	283	54.7	31.2
4	*2412.00	75.1 AV			2.48 V	283	43.9	31.2
5	4824.00	64.8 PK	74.0	-9.2	2.97 V	38	62.7	2.1
6	4824.00	52.4 AV	54.0	-1.6	2.97 V	38	50.3	2.1

**Remarks:**

1. Emission Level(dBuV/m) = Raw Value(dBuV) + Correction Factor(dB/m)
2. Correction Factor(dB/m) = Antenna Factor(dB/m) + Cable Factor(dB) – Pre-Amplifier Factor(dB)
3. Margin value = Emission Level – Limit value
4. The other emission levels were very low against the limit.
5. " \* ": Fundamental frequency.

<b>RF Mode</b>	TX 802.11n (HT20)	<b>Channel</b>	CH 6 : 2437 MHz
<b>Frequency Range</b>	1GHz ~ 25GHz	<b>Detector Function</b>	Peak (PK) Average (AV)

Antenna Polarity & Test Distance : Horizontal at 3 m								
No	Frequency (MHz)	Emission Level (dBuV/m)	Limit (dBuV/m)	Margin (dB)	Antenna Height (m)	Table Angle (Degree)	Raw Value (dBuV)	Correction Factor (dB/m)
1	*2437.00	89.1 PK			1.44 H	175	58.0	31.1
2	*2437.00	78.2 AV			1.44 H	175	47.1	31.1
3	4874.00	65.9 PK	74.0	-8.1	1.04 H	108	63.8	2.1
4	4874.00	53.0 AV	54.0	-1.0	1.04 H	108	50.9	2.1
Antenna Polarity & Test Distance : Vertical at 3 m								
No	Frequency (MHz)	Emission Level (dBuV/m)	Limit (dBuV/m)	Margin (dB)	Antenna Height (m)	Table Angle (Degree)	Raw Value (dBuV)	Correction Factor (dB/m)
1	*2437.00	85.3 PK			2.53 V	279	54.2	31.1
2	*2437.00	74.4 AV			2.53 V	279	43.3	31.1
3	4874.00	65.0 PK	74.0	-9.0	2.99 V	31	62.9	2.1
4	4874.00	52.3 AV	54.0	-1.7	2.99 V	31	50.2	2.1

**Remarks:**

1. Emission Level(dBuV/m) = Raw Value(dBuV) + Correction Factor(dB/m)
2. Correction Factor(dB/m) = Antenna Factor(dB/m) + Cable Factor(dB) – Pre-Amplifier Factor(dB)
3. Margin value = Emission Level – Limit value
4. The other emission levels were very low against the limit.
5. " \* ": Fundamental frequency.

<b>RF Mode</b>	TX 802.11n (HT20)	<b>Channel</b>	CH 11 : 2462 MHz
<b>Frequency Range</b>	1GHz ~ 25GHz	<b>Detector Function</b>	Peak (PK) Average (AV)

**Antenna Polarity & Test Distance : Horizontal at 3 m**

No	Frequency (MHz)	Emission Level (dBuV/m)	Limit (dBuV/m)	Margin (dB)	Antenna Height (m)	Table Angle (Degree)	Raw Value (dBuV)	Correction Factor (dB/m)
1	*2462.00	90.2 PK			1.41 H	175	59.1	31.1
2	*2462.00	78.9 AV			1.41 H	175	47.8	31.1
3	2483.50	66.6 PK	74.0	-7.4	1.41 H	175	35.5	31.1
4	2483.50	51.5 AV	54.0	-2.5	1.41 H	175	20.4	31.1
5	4924.00	66.4 PK	74.0	-7.6	1.02 H	107	64.3	2.1
6	4924.00	53.2 AV	54.0	-0.8	1.02 H	107	51.1	2.1

**Antenna Polarity & Test Distance : Vertical at 3 m**

No	Frequency (MHz)	Emission Level (dBuV/m)	Limit (dBuV/m)	Margin (dB)	Antenna Height (m)	Table Angle (Degree)	Raw Value (dBuV)	Correction Factor (dB/m)
1	*2462.00	86.4 PK			2.38 V	279	55.3	31.1
2	*2462.00	74.9 AV			2.38 V	279	43.8	31.1
3	2483.50	65.2 PK	74.0	-8.8	2.38 V	279	34.1	31.1
4	2483.50	50.0 AV	54.0	-4.0	2.38 V	279	18.9	31.1
5	4924.00	65.5 PK	74.0	-8.5	3.06 V	37	63.4	2.1
6	4924.00	52.3 AV	54.0	-1.7	3.06 V	37	50.2	2.1

**Remarks:**

1. Emission Level(dBuV/m) = Raw Value(dBuV) + Correction Factor(dB/m)
2. Correction Factor(dB/m) = Antenna Factor(dB/m) + Cable Factor(dB) – Pre-Amplifier Factor(dB)
3. Margin value = Emission Level – Limit value
4. The other emission levels were very low against the limit.
5. " \* ": Fundamental frequency.

**Mode B**

<b>RF Mode</b>	TX 802.11b	<b>Channel</b>	CH 1 : 2412 MHz
<b>Frequency Range</b>	1GHz ~ 25GHz	<b>Detector Function</b>	Peak (PK) Average (AV)

Antenna Polarity & Test Distance : Horizontal at 3 m								
No	Frequency (MHz)	Emission Level (dBuV/m)	Limit (dBuV/m)	Margin (dB)	Antenna Height (m)	Table Angle (Degree)	Raw Value (dBuV)	Correction Factor (dB/m)
1	2390.00	56.1 PK	74.0	-17.9	2.48 H	95	24.9	31.2
2	2390.00	42.9 AV	54.0	-11.1	2.48 H	95	11.7	31.2
3	*2412.00	78.8 PK			2.48 H	95	47.6	31.2
4	*2412.00	73.0 AV			2.48 H	95	41.8	31.2
5	4824.00	47.4 PK	74.0	-26.6	1.00 H	89	45.4	2.0
6	4824.00	45.9 AV	54.0	-8.1	1.00 H	89	43.9	2.0

Antenna Polarity & Test Distance : Vertical at 3 m								
No	Frequency (MHz)	Emission Level (dBuV/m)	Limit (dBuV/m)	Margin (dB)	Antenna Height (m)	Table Angle (Degree)	Raw Value (dBuV)	Correction Factor (dB/m)
1	2390.00	56.8 PK	74.0	-17.2	2.15 V	317	25.6	31.2
2	2390.00	43.0 AV	54.0	-11.0	2.15 V	317	11.8	31.2
3	*2412.00	86.3 PK			2.15 V	317	55.1	31.2
4	*2412.00	80.7 AV			2.15 V	317	49.5	31.2
5	4824.00	54.5 PK	74.0	-19.5	2.18 V	101	52.5	2.0
6	4824.00	53.0 AV	54.0	-1.0	2.18 V	101	51.0	2.0

**Remarks:**

1. Emission Level(dBuV/m) = Raw Value(dBuV) + Correction Factor(dB/m)
2. Correction Factor(dB/m) = Antenna Factor(dB/m) + Cable Factor(dB) – Pre-Amplifier Factor(dB)
3. Margin value = Emission Level – Limit value
4. The other emission levels were very low against the limit.
5. " \* " : Fundamental frequency.

<b>RF Mode</b>	TX 802.11b	<b>Channel</b>	CH 6 : 2437 MHz
<b>Frequency Range</b>	1GHz ~ 25GHz	<b>Detector Function</b>	Peak (PK) Average (AV)

**Antenna Polarity & Test Distance : Horizontal at 3 m**

No	Frequency (MHz)	Emission Level (dBuV/m)	Limit (dBuV/m)	Margin (dB)	Antenna Height (m)	Table Angle (Degree)	Raw Value (dBuV)	Correction Factor (dB/m)
1	*2437.00	82.3 PK			2.52 H	91	51.2	31.1
2	*2437.00	78.3 AV			2.52 H	91	47.2	31.1
3	4874.00	46.5 PK	74.0	-27.5	1.92 H	85	44.4	2.1
4	4874.00	45.0 AV	54.0	-9.0	1.92 H	85	42.9	2.1

**Antenna Polarity & Test Distance : Vertical at 3 m**

No	Frequency (MHz)	Emission Level (dBuV/m)	Limit (dBuV/m)	Margin (dB)	Antenna Height (m)	Table Angle (Degree)	Raw Value (dBuV)	Correction Factor (dB/m)
1	*2437.00	89.6 PK			2.23 V	335	58.5	31.1
2	*2437.00	85.6 AV			2.23 V	335	54.5	31.1
3	4874.00	55.0 PK	74.0	-19.0	2.14 V	103	52.9	2.1
4	4874.00	52.7 AV	54.0	-1.3	2.14 V	103	50.6	2.1

**Remarks:**

1. Emission Level(dBuV/m) = Raw Value(dBuV) + Correction Factor(dB/m)
2. Correction Factor(dB/m) = Antenna Factor(dB/m) + Cable Factor(dB) – Pre-Amplifier Factor(dB)
3. Margin value = Emission Level – Limit value
4. The other emission levels were very low against the limit.
5. " \* ": Fundamental frequency.

<b>RF Mode</b>	TX 802.11b	<b>Channel</b>	CH 11 : 2462 MHz
<b>Frequency Range</b>	1GHz ~ 25GHz	<b>Detector Function</b>	Peak (PK) Average (AV)

**Antenna Polarity & Test Distance : Horizontal at 3 m**

No	Frequency (MHz)	Emission Level (dBuV/m)	Limit (dBuV/m)	Margin (dB)	Antenna Height (m)	Table Angle (Degree)	Raw Value (dBuV)	Correction Factor (dB/m)
1	*2462.00	84.1 PK			2.53 H	95	53.0	31.1
2	*2462.00	80.3 AV			2.53 H	95	49.2	31.1
3	2483.50	55.8 PK	74.0	-18.2	2.53 H	95	24.7	31.1
4	2483.50	43.4 AV	54.0	-10.6	2.53 H	95	12.3	31.1
5	4924.00	47.0 PK	74.0	-27.0	1.87 H	82	44.8	2.2
6	4924.00	45.4 AV	54.0	-8.6	1.87 H	82	43.2	2.2

**Antenna Polarity & Test Distance : Vertical at 3 m**

No	Frequency (MHz)	Emission Level (dBuV/m)	Limit (dBuV/m)	Margin (dB)	Antenna Height (m)	Table Angle (Degree)	Raw Value (dBuV)	Correction Factor (dB/m)
1	*2462.00	91.3 PK			1.94 V	319	60.2	31.1
2	*2462.00	87.5 AV			1.94 V	319	56.4	31.1
3	2483.50	56.4 PK	74.0	-17.6	1.94 V	319	25.3	31.1
4	2483.50	45.6 AV	54.0	-8.4	1.94 V	319	14.5	31.1
5	4924.00	54.4 PK	74.0	-19.6	2.11 V	69	52.2	2.2
6	4924.00	52.9 AV	54.0	-1.1	2.11 V	69	50.7	2.2

**Remarks:**

1. Emission Level(dBuV/m) = Raw Value(dBuV) + Correction Factor(dB/m)
2. Correction Factor(dB/m) = Antenna Factor(dB/m) + Cable Factor(dB) – Pre-Amplifier Factor(dB)
3. Margin value = Emission Level – Limit value
4. The other emission levels were very low against the limit.
5. " \* ": Fundamental frequency.

<b>RF Mode</b>	TX 802.11g	<b>Channel</b>	CH 1 : 2412 MHz
<b>Frequency Range</b>	1GHz ~ 25GHz	<b>Detector Function</b>	Peak (PK) Average (AV)

**Antenna Polarity & Test Distance : Horizontal at 3 m**

No	Frequency (MHz)	Emission Level (dBuV/m)	Limit (dBuV/m)	Margin (dB)	Antenna Height (m)	Table Angle (Degree)	Raw Value (dBuV)	Correction Factor (dB/m)
1	2390.00	60.5 PK	74.0	-13.5	2.53 H	94	29.3	31.2
2	2390.00	44.3 AV	54.0	-9.7	2.53 H	94	13.1	31.2
3	*2412.00	95.3 PK			2.53 H	94	64.1	31.2
4	*2412.00	85.0 AV			2.53 H	94	53.8	31.2
5	4824.00	59.2 PK	74.0	-14.8	1.89 H	77	57.2	2.0
6	4824.00	48.7 AV	54.0	-5.3	1.89 H	77	46.7	2.0

**Antenna Polarity & Test Distance : Vertical at 3 m**

No	Frequency (MHz)	Emission Level (dBuV/m)	Limit (dBuV/m)	Margin (dB)	Antenna Height (m)	Table Angle (Degree)	Raw Value (dBuV)	Correction Factor (dB/m)
1	2390.00	64.9 PK	74.0	-9.1	2.17 V	313	33.7	31.2
2	2390.00	47.1 AV	54.0	-6.9	2.17 V	313	15.9	31.2
3	*2412.00	103.2 PK			2.17 V	313	72.0	31.2
4	*2412.00	93.0 AV			2.17 V	313	61.8	31.2
5	4824.00	62.5 PK	74.0	-11.5	2.17 V	100	60.5	2.0
6	4824.00	52.8 AV	54.0	-1.2	2.17 V	100	50.8	2.0

**Remarks:**

1. Emission Level(dBuV/m) = Raw Value(dBuV) + Correction Factor(dB/m)
2. Correction Factor(dB/m) = Antenna Factor(dB/m) + Cable Factor(dB) – Pre-Amplifier Factor(dB)
3. Margin value = Emission Level – Limit value
4. The other emission levels were very low against the limit.
5. " \* ": Fundamental frequency.

<b>RF Mode</b>	TX 802.11g	<b>Channel</b>	CH 6 : 2437 MHz
<b>Frequency Range</b>	1GHz ~ 25GHz	<b>Detector Function</b>	Peak (PK) Average (AV)

**Antenna Polarity & Test Distance : Horizontal at 3 m**

No	Frequency (MHz)	Emission Level (dBuV/m)	Limit (dBuV/m)	Margin (dB)	Antenna Height (m)	Table Angle (Degree)	Raw Value (dBuV)	Correction Factor (dB/m)
1	*2437.00	95.9 PK			2.57 H	93	64.8	31.1
2	*2437.00	85.7 AV			2.57 H	93	54.6	31.1
3	4874.00	60.9 PK	74.0	-13.1	2.04 H	76	58.8	2.1
4	4874.00	48.0 AV	54.0	-6.0	2.04 H	76	45.9	2.1

**Antenna Polarity & Test Distance : Vertical at 3 m**

No	Frequency (MHz)	Emission Level (dBuV/m)	Limit (dBuV/m)	Margin (dB)	Antenna Height (m)	Table Angle (Degree)	Raw Value (dBuV)	Correction Factor (dB/m)
1	*2437.00	104.0 PK			2.23 V	334	72.9	31.1
2	*2437.00	93.5 AV			2.23 V	334	62.4	31.1
3	4874.00	66.0 PK	74.0	-8.0	2.13 V	102	63.9	2.1
4	4874.00	52.8 AV	54.0	-1.2	2.13 V	102	50.7	2.1

**Remarks:**

1. Emission Level(dBuV/m) = Raw Value(dBuV) + Correction Factor(dB/m)
2. Correction Factor(dB/m) = Antenna Factor(dB/m) + Cable Factor(dB) – Pre-Amplifier Factor(dB)
3. Margin value = Emission Level – Limit value
4. The other emission levels were very low against the limit.
5. " \* ": Fundamental frequency.



<b>RF Mode</b>	TX 802.11g	<b>Channel</b>	CH 11 : 2462 MHz
<b>Frequency Range</b>	1GHz ~ 25GHz	<b>Detector Function</b>	Peak (PK) Average (AV)

Antenna Polarity & Test Distance : Horizontal at 3 m								
No	Frequency (MHz)	Emission Level (dBuV/m)	Limit (dBuV/m)	Margin (dB)	Antenna Height (m)	Table Angle (Degree)	Raw Value (dBuV)	Correction Factor (dB/m)
1	*2462.00	95.5 PK			2.54 H	94	64.4	31.1
2	*2462.00	85.4 AV			2.54 H	94	54.3	31.1
3	2483.50	62.7 PK	74.0	-11.3	2.54 H	94	31.6	31.1
4	2483.50	46.1 AV	54.0	-7.9	2.54 H	94	15.0	31.1
5	4924.00	58.6 PK	74.0	-15.4	1.85 H	83	56.4	2.2
6	4924.00	47.0 AV	54.0	-7.0	1.85 H	83	44.8	2.2
Antenna Polarity & Test Distance : Vertical at 3 m								
No	Frequency (MHz)	Emission Level (dBuV/m)	Limit (dBuV/m)	Margin (dB)	Antenna Height (m)	Table Angle (Degree)	Raw Value (dBuV)	Correction Factor (dB/m)
1	*2462.00	103.4 PK			1.94 V	317	72.3	31.1
2	*2462.00	93.3 AV			1.94 V	317	62.2	31.1
3	2483.50	71.4 PK	74.0	-2.6	1.94 V	317	40.3	31.1
4	2483.50	52.6 AV	54.0	-1.4	1.94 V	317	21.5	31.1
5	4924.00	65.7 PK	74.0	-8.3	2.65 V	106	63.5	2.2
6	4924.00	51.6 AV	54.0	-2.4	2.65 V	106	49.4	2.2

**Remarks:**

1. Emission Level(dBuV/m) = Raw Value(dBuV) + Correction Factor(dB/m)
2. Correction Factor(dB/m) = Antenna Factor(dB/m) + Cable Factor(dB) – Pre-Amplifier Factor(dB)
3. Margin value = Emission Level – Limit value
4. The other emission levels were very low against the limit.
5. " \* ": Fundamental frequency.

<b>RF Mode</b>	TX 802.11n (HT20)	<b>Channel</b>	CH 1 : 2412 MHz
<b>Frequency Range</b>	1GHz ~ 25GHz	<b>Detector Function</b>	Peak (PK) Average (AV)

**Antenna Polarity & Test Distance : Horizontal at 3 m**

No	Frequency (MHz)	Emission Level (dBuV/m)	Limit (dBuV/m)	Margin (dB)	Antenna Height (m)	Table Angle (Degree)	Raw Value (dBuV)	Correction Factor (dB/m)
1	2390.00	67.8 PK	74.0	-6.2	2.41 H	98	36.6	31.2
2	2390.00	47.0 AV	54.0	-7.0	2.41 H	98	15.8	31.2
3	*2412.00	97.4 PK			2.41 H	98	66.2	31.2
4	*2412.00	86.1 AV			2.41 H	98	54.9	31.2
5	4824.00	59.8 PK	74.0	-14.2	2.02 H	88	57.8	2.0
6	4824.00	48.3 AV	54.0	-5.7	2.02 H	88	46.3	2.0

**Antenna Polarity & Test Distance : Vertical at 3 m**

No	Frequency (MHz)	Emission Level (dBuV/m)	Limit (dBuV/m)	Margin (dB)	Antenna Height (m)	Table Angle (Degree)	Raw Value (dBuV)	Correction Factor (dB/m)
1	2390.00	72.5 PK	74.0	-1.5	2.10 V	315	41.3	31.2
2	2390.00	50.7 AV	54.0	-3.3	2.10 V	315	19.5	31.2
3	*2412.00	105.4 PK			2.10 V	315	74.2	31.2
4	*2412.00	94.1 AV			2.10 V	315	62.9	31.2
5	4824.00	65.6 PK	74.0	-8.4	2.19 V	103	63.6	2.0
6	4824.00	52.8 AV	54.0	-1.2	2.19 V	103	50.8	2.0

**Remarks:**

1. Emission Level(dBuV/m) = Raw Value(dBuV) + Correction Factor(dB/m)
2. Correction Factor(dB/m) = Antenna Factor(dB/m) + Cable Factor(dB) – Pre-Amplifier Factor(dB)
3. Margin value = Emission Level – Limit value
4. The other emission levels were very low against the limit.
5. " \* ": Fundamental frequency.

<b>RF Mode</b>	TX 802.11n (HT20)	<b>Channel</b>	CH 6 : 2437 MHz
<b>Frequency Range</b>	1GHz ~ 25GHz	<b>Detector Function</b>	Peak (PK) Average (AV)

Antenna Polarity & Test Distance : Horizontal at 3 m								
No	Frequency (MHz)	Emission Level (dBuV/m)	Limit (dBuV/m)	Margin (dB)	Antenna Height (m)	Table Angle (Degree)	Raw Value (dBuV)	Correction Factor (dB/m)
1	*2437.00	97.0 PK			2.53 H	101	65.9	31.1
2	*2437.00	85.9 AV			2.53 H	101	54.8	31.1
3	4874.00	61.4 PK	74.0	-12.6	1.85 H	80	59.3	2.1
4	4874.00	48.8 AV	54.0	-5.2	1.85 H	80	46.7	2.1
Antenna Polarity & Test Distance : Vertical at 3 m								
No	Frequency (MHz)	Emission Level (dBuV/m)	Limit (dBuV/m)	Margin (dB)	Antenna Height (m)	Table Angle (Degree)	Raw Value (dBuV)	Correction Factor (dB/m)
1	*2437.00	104.8 PK			2.09 V	314	73.7	31.1
2	*2437.00	93.8 AV			2.09 V	314	62.7	31.1
3	4874.00	65.2 PK	74.0	-8.8	2.14 V	105	63.1	2.1
4	4874.00	52.9 AV	54.0	-1.1	2.14 V	105	50.8	2.1

**Remarks:**

1. Emission Level(dBuV/m) = Raw Value(dBuV) + Correction Factor(dB/m)
2. Correction Factor(dB/m) = Antenna Factor(dB/m) + Cable Factor(dB) – Pre-Amplifier Factor(dB)
3. Margin value = Emission Level – Limit value
4. The other emission levels were very low against the limit.
5. " \* ": Fundamental frequency.

<b>RF Mode</b>	TX 802.11n (HT20)	<b>Channel</b>	CH 11 : 2462 MHz
<b>Frequency Range</b>	1GHz ~ 25GHz	<b>Detector Function</b>	Peak (PK) Average (AV)

Antenna Polarity & Test Distance : Horizontal at 3 m								
No	Frequency (MHz)	Emission Level (dBuV/m)	Limit (dBuV/m)	Margin (dB)	Antenna Height (m)	Table Angle (Degree)	Raw Value (dBuV)	Correction Factor (dB/m)
1	*2462.00	95.8 PK			2.43 H	92	64.7	31.1
2	*2462.00	84.7 AV			2.43 H	92	53.6	31.1
3	2483.50	62.2 PK	74.0	-11.8	2.43 H	92	31.1	31.1
4	2483.50	46.4 AV	54.0	-7.6	2.43 H	92	15.3	31.1
5	4924.00	60.9 PK	74.0	-13.1	2.06 H	84	58.7	2.2
6	4924.00	47.5 AV	54.0	-6.5	2.06 H	84	45.3	2.2
Antenna Polarity & Test Distance : Vertical at 3 m								
No	Frequency (MHz)	Emission Level (dBuV/m)	Limit (dBuV/m)	Margin (dB)	Antenna Height (m)	Table Angle (Degree)	Raw Value (dBuV)	Correction Factor (dB/m)
1	*2462.00	104.2 PK			2.15 V	329	73.1	31.1
2	*2462.00	92.5 AV			2.15 V	329	61.4	31.1
3	2483.50	72.0 PK	74.0	-2.0	2.15 V	329	40.9	31.1
4	2483.50	52.3 AV	54.0	-1.7	2.15 V	329	21.2	31.1
5	4924.00	65.5 PK	74.0	-8.5	2.22 V	105	63.3	2.2
6	4924.00	51.9 AV	54.0	-2.1	2.22 V	105	49.7	2.2

**Remarks:**

1. Emission Level(dBuV/m) = Raw Value(dBuV) + Correction Factor(dB/m)
2. Correction Factor(dB/m) = Antenna Factor(dB/m) + Cable Factor(dB) – Pre-Amplifier Factor(dB)
3. Margin value = Emission Level – Limit value
4. The other emission levels were very low against the limit.
5. " \* ": Fundamental frequency.

**30 MHz ~ 1 GHz Worst-Case Data:**

**Mode A**

**802.11g**

<b>RF Mode</b>	TX 802.11g	<b>Channel</b>	CH 1 : 2412 MHz
<b>Frequency Range</b>	30MHz ~ 1GHz	<b>Detector Function</b>	Quasi-Peak (QP)

Antenna Polarity & Test Distance : Horizontal at 3 m								
No	Frequency (MHz)	Emission Level (dBuV/m)	Limit (dBuV/m)	Margin (dB)	Antenna Height (m)	Table Angle (Degree)	Raw Value (dBuV)	Correction Factor (dB/m)
1	88.20	28.6 QP	43.5	-14.9	1.25 H	88	42.9	-14.3
2	150.28	27.5 QP	43.5	-16.0	1.00 H	108	35.9	-8.4
3	250.19	37.6 QP	46.0	-8.4	1.50 H	204	46.3	-8.7
4	431.58	31.4 QP	46.0	-14.6	1.00 H	243	35.3	-3.9
5	649.83	31.3 QP	46.0	-14.7	1.25 H	295	31.1	0.2
6	783.69	39.9 QP	46.0	-6.1	1.00 H	281	36.8	3.1

**Remarks:**

1. Emission Level(dBuV/m) = Raw Value(dBuV) + Correction Factor(dB/m)
2. Correction Factor(dB/m) = Antenna Factor(dB/m) + Cable Factor(dB) – Pre-Amplifier Factor(dB)
3. Margin value = Emission Level – Limit value
4. The other emission levels were very low against the limit of frequency range 30MHz~1000MHz.
5. The emission levels were very low against the limit of frequency range 9kHz~30MHz: the amplitude of spurious emissions attenuated more than 20 dB below the permissible value to be report.

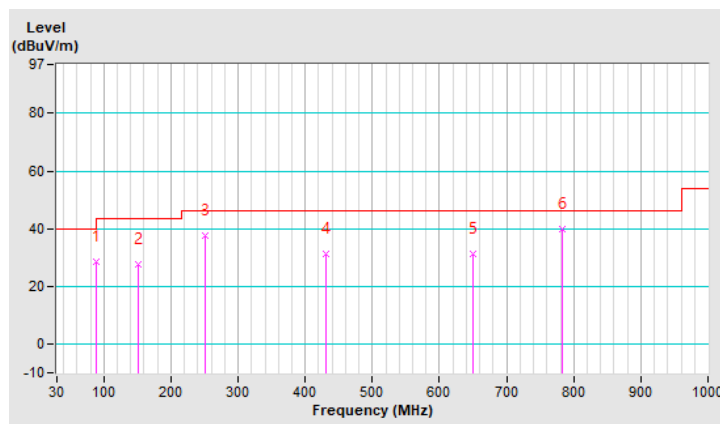

<b>RF Mode</b>	TX 802.11g	<b>Channel</b>	CH 1 : 2412 MHz
<b>Frequency Range</b>	30MHz ~ 1GHz	<b>Detector Function</b>	Quasi-Peak (QP)

**Antenna Polarity & Test Distance : Vertical at 3 m**

No	Frequency (MHz)	Emission Level (dBuV/m)	Limit (dBuV/m)	Margin (dB)	Antenna Height (m)	Table Angle (Degree)	Raw Value (dBuV)	Correction Factor (dB/m)
1	30.97	38.4 QP	40.0	-1.6	1.25 V	20	49.0	-10.6
2	49.40	37.3 QP	40.0	-2.7	1.00 V	4	46.3	-9.0
3	135.73	26.6 QP	43.5	-16.9	1.25 V	271	35.9	-9.3
4	250.19	29.8 QP	46.0	-16.2	1.00 V	160	38.5	-8.7
5	450.01	33.1 QP	46.0	-12.9	1.50 V	354	36.5	-3.4
6	800.18	38.4 QP	46.0	-7.6	1.00 V	277	35.0	3.4

**Remarks:**

1. Emission Level(dBuV/m) = Raw Value(dBuV) + Correction Factor(dB/m)
2. Correction Factor(dB/m) = Antenna Factor(dB/m) + Cable Factor(dB) – Pre-Amplifier Factor(dB)
3. Margin value = Emission Level – Limit value
4. The other emission levels were very low against the limit of frequency range 30MHz~1000MHz.
5. The emission levels were very low against the limit of frequency range 9kHz~30MHz: the amplitude of spurious emissions attenuated more than 20 dB below the permissible value to be report.

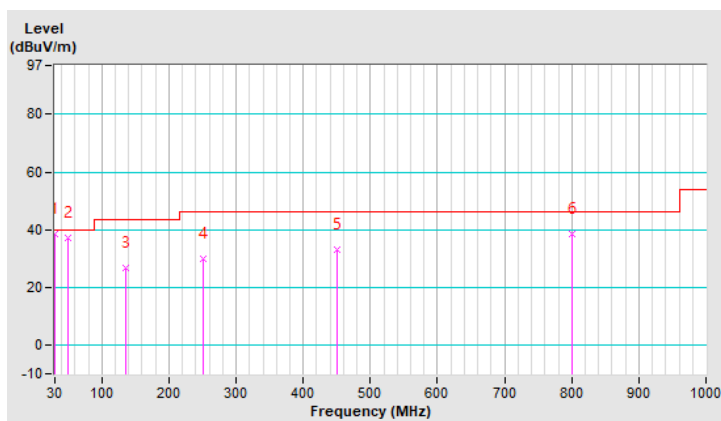

**Mode B**

<b>RF Mode</b>	TX 802.11b	<b>Channel</b>	CH 1 : 2412 MHz
<b>Frequency Range</b>	30MHz ~ 1GHz	<b>Detector Function</b>	Quasi-Peak (QP)

Antenna Polarity & Test Distance : Horizontal at 3 m								
No	Frequency (MHz)	Emission Level (dBuV/m)	Limit (dBuV/m)	Margin (dB)	Antenna Height (m)	Table Angle (Degree)	Raw Value (dBuV)	Correction Factor (dB/m)
1	33.88	39.0 QP	40.0	-1.0	1.50 H	223	49.1	-10.1
2	112.45	39.4 QP	43.5	-4.1	1.00 H	156	50.8	-11.4
3	240.49	34.4 QP	46.0	-11.6	1.00 H	58	43.5	-9.1
4	432.55	35.5 QP	46.0	-10.5	1.25 H	14	39.4	-3.9
5	549.92	33.5 QP	46.0	-12.5	1.00 H	114	35.4	-1.9
6	789.51	38.6 QP	46.0	-7.4	1.25 H	267	35.2	3.4

**Remarks:**

1. Emission Level(dBuV/m) = Raw Value(dBuV) + Correction Factor(dB/m)
2. Correction Factor(dB/m) = Antenna Factor(dB/m) + Cable Factor(dB) – Pre-Amplifier Factor(dB)
3. Margin value = Emission Level – Limit value
4. The other emission levels were very low against the limit of frequency range 30MHz~1000MHz.
5. The emission levels were very low against the limit of frequency range 9kHz~30MHz: the amplitude of spurious emissions attenuated more than 20 dB below the permissible value to be report.

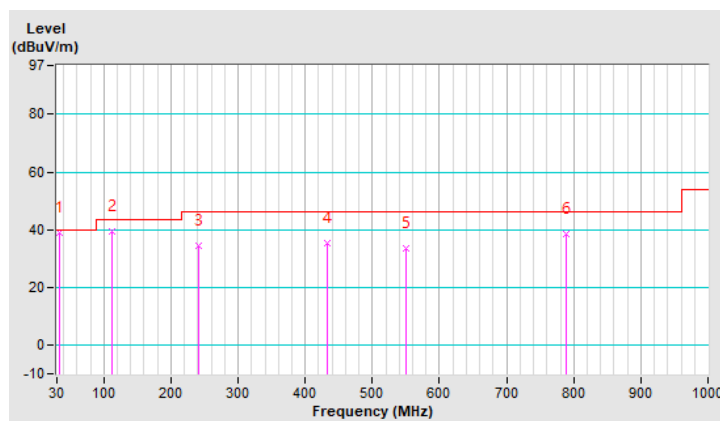

<b>RF Mode</b>	TX 802.11b	<b>Channel</b>	CH 1 : 2412 MHz
<b>Frequency Range</b>	30MHz ~ 1GHz	<b>Detector Function</b>	Quasi-Peak (QP)

**Antenna Polarity & Test Distance : Vertical at 3 m**

No	Frequency (MHz)	Emission Level (dBuV/m)	Limit (dBuV/m)	Margin (dB)	Antenna Height (m)	Table Angle (Degree)	Raw Value (dBuV)	Correction Factor (dB/m)
1	30.00	33.4 QP	40.0	-6.6	1.25 V	10	43.7	-10.3
2	65.89	36.6 QP	40.0	-3.4	1.00 V	322	46.7	-10.1
3	250.19	30.7 QP	46.0	-15.3	1.00 V	76	39.4	-8.7
4	350.10	40.3 QP	46.0	-5.7	1.50 V	133	46.1	-5.8
5	431.58	44.0 QP	46.0	-2.0	1.25 V	106	47.9	-3.9
6	800.18	38.3 QP	46.0	-7.7	1.00 V	184	34.9	3.4

**Remarks:**

1. Emission Level(dBuV/m) = Raw Value(dBuV) + Correction Factor(dB/m)
2. Correction Factor(dB/m) = Antenna Factor(dB/m) + Cable Factor(dB) – Pre-Amplifier Factor(dB)
3. Margin value = Emission Level – Limit value
4. The other emission levels were very low against the limit of frequency range 30MHz~1000MHz.
5. The emission levels were very low against the limit of frequency range 9kHz~30MHz: the amplitude of spurious emissions attenuated more than 20 dB below the permissible value to be report.

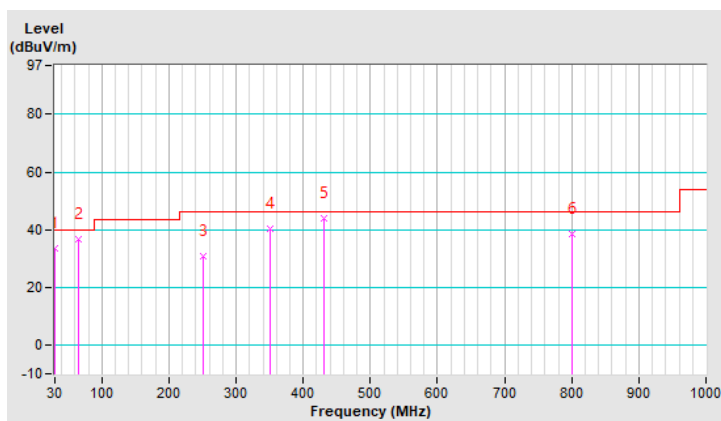



## 4.2 Conducted Emission Measurement

### 4.2.1 Limits of Conducted Emission Measurement

Frequency (MHz)	Conducted Limit (dBuV)	
	Quasi-Peak	Average
0.15 - 0.5	66 - 56	56 - 46
0.50 - 5.0	56	46
5.0 - 30.0	60	50

- Note: 1. The lower limit shall apply at the transition frequencies.  
 2. The limit decreases in line with the logarithm of the frequency in the range of 0.15 to 0.50 MHz.

### 4.2.2 Test Instruments

Description & Manufacturer	Model No.	Serial No.	Date of Calibration	Due Date of Calibration
Test Receiver ROHDE & SCHWARZ	ESCI	100613	Dec. 04, 2020	Dec. 03, 2021
RF signal cable Woken	5D-FB	Cable-cond1-01	Jan. 16, 2021	Jan. 15, 2022
LISN ROHDE & SCHWARZ (EUT)	ENV216	101826	Feb. 25, 2021	Feb. 24, 2022
LISN ROHDE & SCHWARZ (Peripheral)	ESH3-Z5	100311	Aug. 28, 2020	Aug. 27, 2021
Software ADT	BV ADT_Cond_ V7.3.7.4	NA	NA	NA

- Note: 1. The calibration interval of the above test instruments is 12 months and the calibrations are traceable to NML/ROC and NIST/USA.  
 2. The test was performed in HwaYa Shielded Room 1.  
 3. The VCCI Site Registration No. is C-12040.

#### 4.2.3 Test Procedures

- a. The EUT was placed 0.4 meters from the conducting wall of the shielded room with EUT being connected to the power mains through a line impedance stabilization network (LISN). Other support units were connected to the power mains through another LISN. The two LISNs provide 50 ohm/50 uH of coupling impedance for the measuring instrument.
- b. Both lines of the power mains connected to the EUT were checked for maximum conducted interference.
- c. The frequency range from 150 kHz to 30 MHz was searched. Emission levels under (Limit – 20 dB) was not recorded.

**Note:** The resolution bandwidth and video bandwidth of test receiver is 9 kHz for quasi-peak detection (QP) and average detection (AV) at frequency 0.15 MHz – 30 MHz.

#### 4.2.4 Deviation from Test Standard

No deviation.

#### 4.2.5 Test Setup

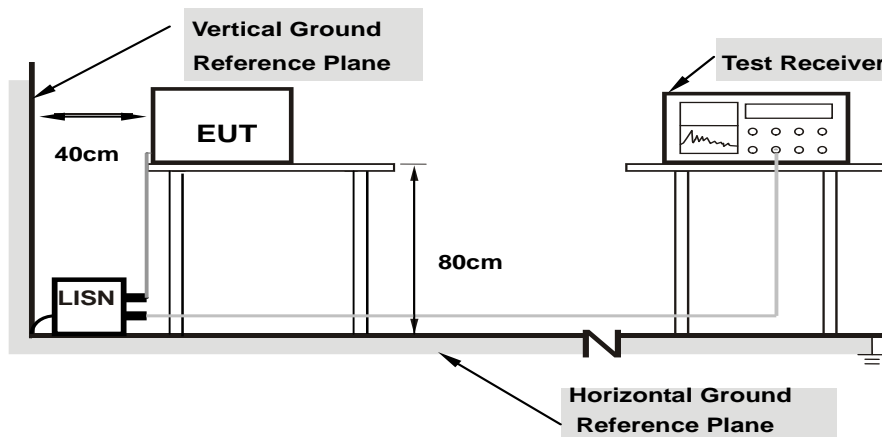

**Note:** 1.Support units were connected to second LISN.

For the actual test configuration, please refer to the attached file (Test Setup Photo).

#### 4.2.6 EUT Operating Conditions

- a. Placed the EUT on a testing table.
- b. Use the software to control the EUT under transmission condition continuously at specific channel frequency.

#### 4.2.7 Test Results

##### Mode A

<b>Frequency Range</b>	150kHz ~ 30MHz	<b>Detector Function &amp; Resolution Bandwidth</b>	Quasi-Peak (QP) / Average (AV), 9kHz
<b>Input Power</b>	120Vac, 60Hz	<b>Environmental Conditions</b>	25 °C, 75% RH
<b>Tested by</b>	Greg Lin	<b>Test Date</b>	2021/3/5

Phase Of Power : Line (L)										
No	Frequency (MHz)	Correction Factor (dB)	Reading Value (dBuV)		Emission Level (dBuV)		Limit (dBuV)		Margin (dB)	
			Q.P.	AV.	Q.P.	AV.	Q.P.	AV.	Q.P.	AV.
1	0.16535	9.65	20.46	12.45	30.11	22.10	65.19	55.19	-35.08	-33.09
2	0.29834	9.66	26.48	21.23	36.14	30.89	60.29	50.29	-24.15	-19.40
3	0.32544	9.67	33.55	28.08	43.22	37.75	59.57	49.57	-16.35	-11.82
4	1.25398	9.71	14.65	9.51	24.36	19.22	56.00	46.00	-31.64	-26.78
5	4.19000	9.74	26.40	14.85	36.14	24.59	56.00	46.00	-19.86	-21.41
6	14.83000	9.78	8.30	1.42	18.08	11.20	60.00	50.00	-41.92	-38.80

##### Remarks:

1. Q.P. and AV. are abbreviations of quasi-peak and average individually.
2. The emission levels of other frequencies were very low against the limit.
3. Margin value = Emission level – Limit value
4. Correction factor = Insertion loss + Cable loss
5. Emission Level = Correction Factor + Reading Value

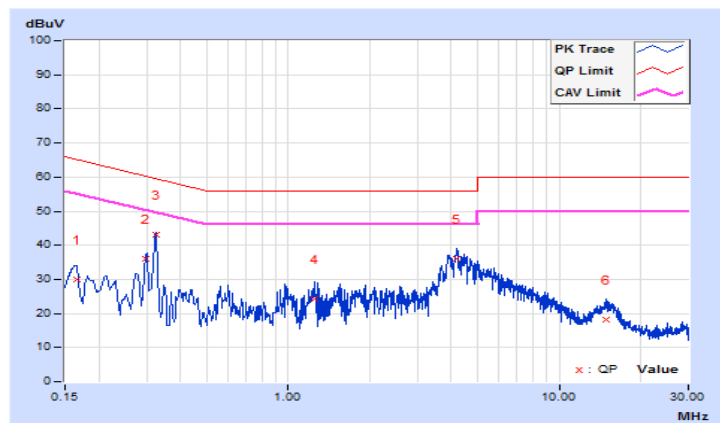

<b>Frequency Range</b>	150kHz ~ 30MHz	<b>Detector Function &amp; Resolution Bandwidth</b>	Quasi-Peak (QP) / Average (AV), 9kHz
<b>Input Power</b>	120Vac, 60Hz	<b>Environmental Conditions</b>	25 °C, 75% RH
<b>Tested by</b>	Greg Lin	<b>Test Date</b>	2021/3/5

Phase Of Power : Neutral (N)										
No	Frequency (MHz)	Correction Factor (dB)	Reading Value (dBuV)		Emission Level (dBuV)		Limit (dBuV)		Margin (dB)	
			Q.P.	AV.	Q.P.	AV.	Q.P.	AV.	Q.P.	AV.
1	0.15400	9.68	19.25	6.36	28.93	16.04	65.78	55.78	-36.85	-39.74
2	0.17000	9.68	17.63	5.38	27.31	15.06	64.96	54.96	-37.65	-39.90
3	0.26992	9.68	16.15	5.24	25.83	14.92	61.12	51.12	-35.29	-36.20
4	0.32200	9.69	21.02	19.56	30.71	29.25	59.66	49.66	-28.95	-20.41
5	4.06200	9.77	19.02	9.60	28.79	19.37	56.00	46.00	-27.21	-26.63
6	15.71000	9.87	9.77	1.92	19.64	11.79	60.00	50.00	-40.36	-38.21

**Remarks:**

1. Q.P. and AV. are abbreviations of quasi-peak and average individually.
2. The emission levels of other frequencies were very low against the limit.
3. Margin value = Emission level – Limit value
4. Correction factor = Insertion loss + Cable loss
5. Emission Level = Correction Factor + Reading Value

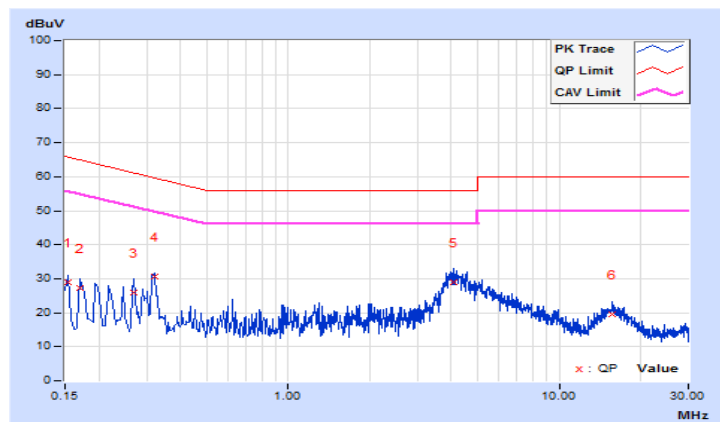

**Mode B**

<b>Frequency Range</b>	150kHz ~ 30MHz	<b>Detector Function &amp; Resolution Bandwidth</b>	Quasi-Peak (QP) / Average (AV), 9kHz
<b>Input Power</b>	120Vac, 60Hz	<b>Environmental Conditions</b>	25 °C, 75% RH
<b>Tested by</b>	Greg Lin	<b>Test Date</b>	2021/3/5

Phase Of Power : Line (L)										
No	Frequency (MHz)	Correction Factor (dB)	Reading Value (dBuV)		Emission Level (dBuV)		Limit (dBuV)		Margin (dB)	
			Q.P.	AV.	Q.P.	AV.	Q.P.	AV.	Q.P.	AV.
1	0.17000	9.65	18.10	8.70	27.75	18.35	64.96	54.96	-37.21	-36.61
2	0.30200	9.67	21.39	17.60	31.06	27.27	60.19	50.19	-29.13	-22.92
<b>3</b>	<b>0.32458</b>	<b>9.67</b>	<b>33.68</b>	<b>28.51</b>	<b>43.35</b>	<b>38.18</b>	<b>59.59</b>	<b>49.59</b>	<b>-16.24</b>	<b>-11.41</b>
4	1.27000	9.71	15.88	7.37	25.59	17.08	56.00	46.00	-30.41	-28.92
5	4.22200	9.74	26.15	14.99	35.89	24.73	56.00	46.00	-20.11	-21.27
6	15.71000	9.78	8.00	1.77	17.78	11.55	60.00	50.00	-42.22	-38.45

**Remarks:**

1. Q.P. and AV. are abbreviations of quasi-peak and average individually.
2. The emission levels of other frequencies were very low against the limit.
3. Margin value = Emission level – Limit value
4. Correction factor = Insertion loss + Cable loss
5. Emission Level = Correction Factor + Reading Value

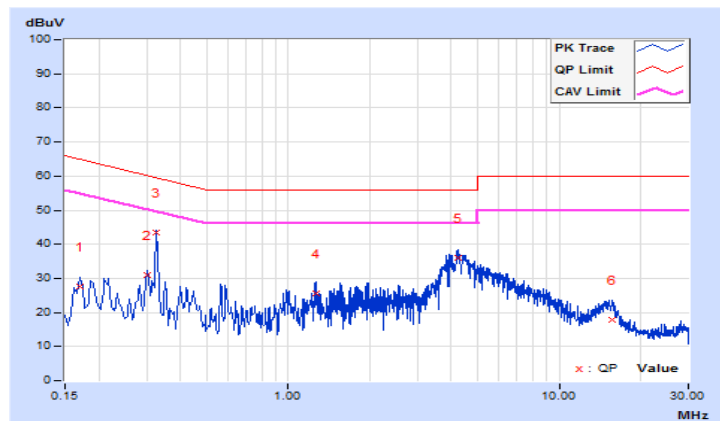

<b>Frequency Range</b>	150kHz ~ 30MHz	<b>Detector Function &amp; Resolution Bandwidth</b>	Quasi-Peak (QP) / Average (AV), 9kHz
<b>Input Power</b>	120Vac, 60Hz	<b>Environmental Conditions</b>	25 °C, 75% RH
<b>Tested by</b>	Greg Lin	<b>Test Date</b>	2021/3/5

Phase Of Power : Neutral (N)										
No	Frequency (MHz)	Correction Factor (dB)	Reading Value (dBuV)		Emission Level (dBuV)		Limit (dBuV)		Margin (dB)	
			Q.P.	AV.	Q.P.	AV.	Q.P.	AV.	Q.P.	AV.
1	0.15400	9.68	19.55	7.08	29.23	16.76	65.78	55.78	-36.55	-39.02
2	0.17400	9.68	14.43	3.93	24.11	13.61	64.77	54.77	-40.66	-41.16
3	0.27000	9.68	17.08	6.79	26.76	16.47	61.12	51.12	-34.36	-34.65
4	0.31698	9.69	27.16	14.43	36.85	24.12	59.79	49.79	-22.94	-25.67
5	4.06600	9.77	21.70	11.66	31.47	21.43	56.00	46.00	-24.53	-24.57
6	15.51400	9.86	10.23	1.45	20.09	11.31	60.00	50.00	-39.91	-38.69

**Remarks:**

1. Q.P. and AV. are abbreviations of quasi-peak and average individually.
2. The emission levels of other frequencies were very low against the limit.
3. Margin value = Emission level – Limit value
4. Correction factor = Insertion loss + Cable loss
5. Emission Level = Correction Factor + Reading Value

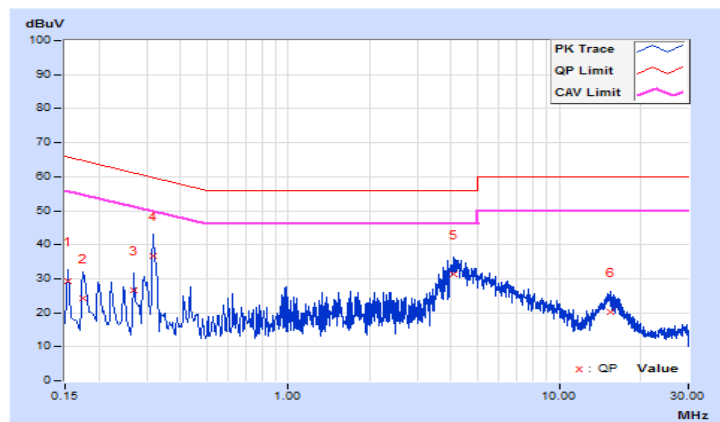

### 4.3 6 dB Bandwidth Measurement

#### 4.3.1 Limits of 6 dB Bandwidth Measurement

The minimum of 6 dB Bandwidth Measurement is 0.5 MHz.

#### 4.3.2 Test Setup

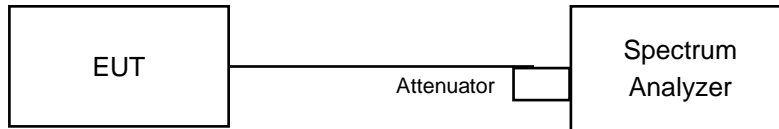

#### 4.3.3 Test Instruments

Refer to section 4.1.2 to get information of above instrument.

#### 4.3.4 Test Procedure

- Set resolution bandwidth (RBW) = 100 kHz
- Set the video bandwidth (VBW)  $\geq 3 \times$  RBW, Detector = Peak.
- Trace mode = max hold.
- Sweep = auto couple.
- Measure the maximum width of the emission that is constrained by the frequencies associated with the two amplitude points (upper and lower) that are attenuated by 6 dB relative to the maximum level measured in the fundamental emission

#### 4.3.5 Deviation from Test Standard

No deviation.

#### 4.3.6 EUT Operating Conditions

The software provided by client to enable the EUT under transmission condition continuously at lowest, middle and highest channel frequencies individually.

#### 4.3.7 Test Results

##### Mode A

##### 802.11b

Channel	Frequency (MHz)	6 dB Bandwidth (MHz)	Minimum Limit (MHz)	Pass / Fail
1	2412	12.16	0.5	Pass
6	2437	12.17	0.5	Pass
11	2462	12.16	0.5	Pass

##### 802.11g

Channel	Frequency (MHz)	6 dB Bandwidth (MHz)	Minimum Limit (MHz)	Pass / Fail
1	2412	16.56	0.5	Pass
6	2437	16.54	0.5	Pass
11	2462	16.55	0.5	Pass

##### 802.11n (HT20)

Channel	Frequency (MHz)	6 dB Bandwidth (MHz)	Minimum Limit (MHz)	Pass / Fail
1	2412	17.77	0.5	Pass
6	2437	17.75	0.5	Pass
11	2462	17.83	0.5	Pass



### Spectrum Plot of Worst Value

#### 802.11b

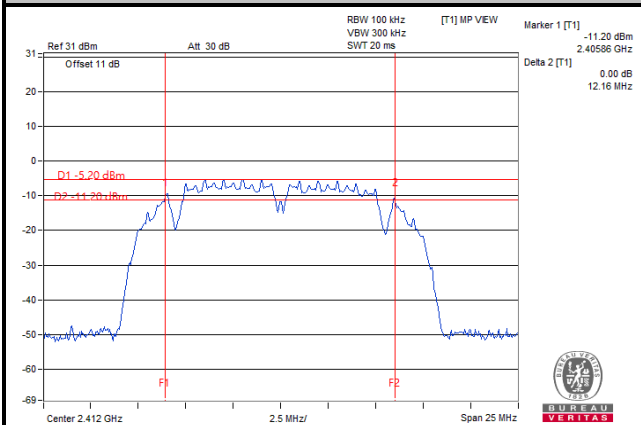

#### 802.11g

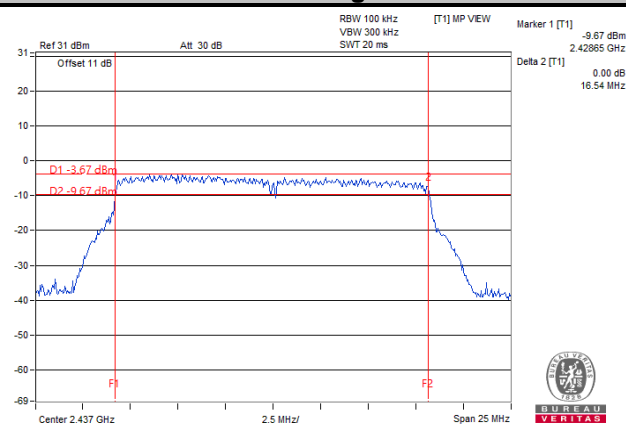

#### 802.11n (HT20)

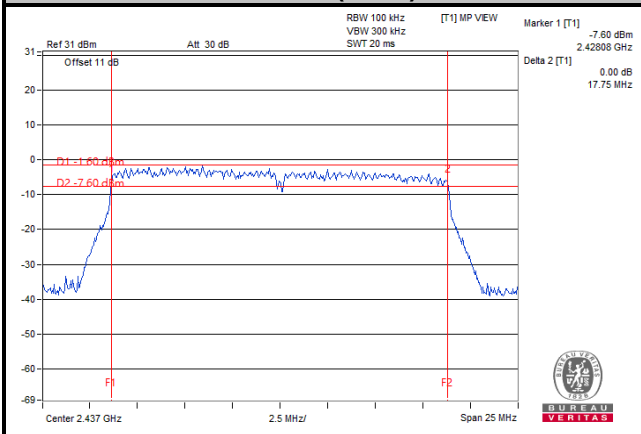

**Mode B**
**802.11b**

Channel	Frequency (MHz)	6 dB Bandwidth (MHz)	Minimum Limit (MHz)	Pass / Fail
1	2412	12.09	0.5	Pass
6	2437	12.17	0.5	Pass
11	2462	12.25	0.5	Pass

**802.11g**

Channel	Frequency (MHz)	6 dB Bandwidth (MHz)	Minimum Limit (MHz)	Pass / Fail
1	2412	16.54	0.5	Pass
6	2437	16.56	0.5	Pass
11	2462	16.53	0.5	Pass

**802.11n (HT20)**

Channel	Frequency (MHz)	6 dB Bandwidth (MHz)	Minimum Limit (MHz)	Pass / Fail
1	2412	17.80	0.5	Pass
6	2437	17.81	0.5	Pass
11	2462	17.79	0.5	Pass

### Spectrum Plot of Worst Value

#### 802.11b

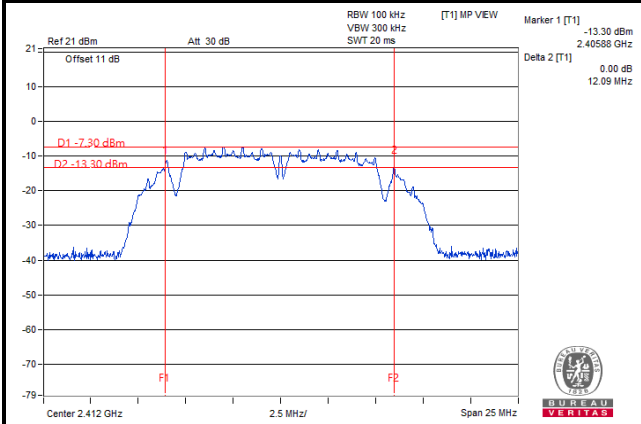

#### 802.11g

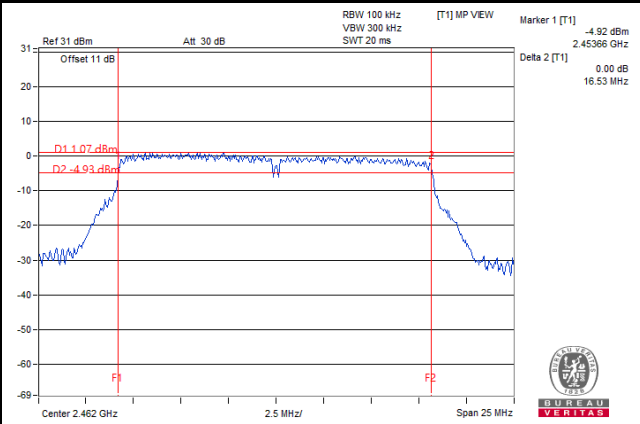

#### 802.11n (HT20)

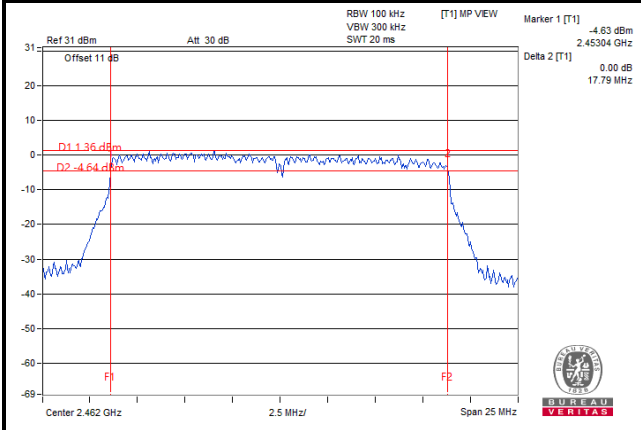

## 4.4 Occupied Bandwidth Measurement

### 4.4.1 Test Setup

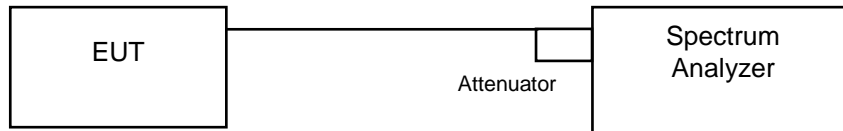

### 4.4.2 Test Instruments

Refer to section 4.1.2 to get information of above instrument.

### 4.4.3 Test Procedure

The transmitter output was connected to the spectrum analyzer through an attenuator. The bandwidth of the fundamental frequency was measured by spectrum analyzer with resolution bandwidth in the range of 1 % to 5 % of the anticipated emission bandwidth, and a video bandwidth at least 3x the resolution bandwidth and set the detector to sampling. The width of a frequency band such that, below the lower and above the upper frequency limits, the mean powers emitted are each equal to a specified percentage 0.5 % of the total mean power of a given emission.

### 4.4.4 Deviation from Test Standard

No deviation.

### 4.4.5 EUT Operating Conditions

The software provided by client to enable the EUT under transmission condition continuously at lowest, middle and highest channel frequencies individually.

#### 4.4.6 Test Results

##### Mode A

##### 802.11b

Channel	Frequency (MHz)	Occupied Bandwidth (MHz)	Pass / Fail
1	2412	13.92	Pass
6	2437	14.04	Pass
11	2462	14.04	Pass

##### 802.11g

Channel	Frequency (MHz)	Occupied Bandwidth (MHz)	Pass / Fail
1	2412	16.80	Pass
6	2437	16.92	Pass
11	2462	17.04	Pass

##### 802.11n (HT20)

Channel	Frequency (MHz)	Occupied Bandwidth (MHz)	Pass / Fail
1	2412	17.88	Pass
6	2437	17.88	Pass
11	2462	17.88	Pass

### Spectrum Plot of Worst Value

#### 802.11b

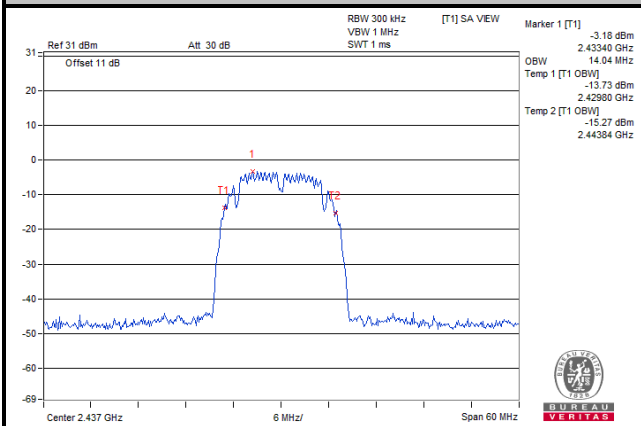

#### 802.11g

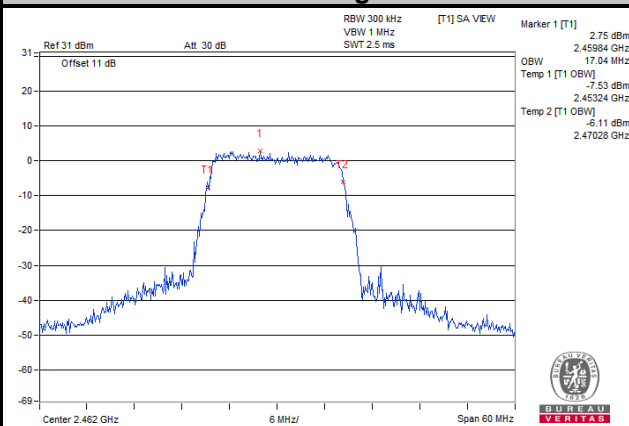

#### 802.11n (HT20)

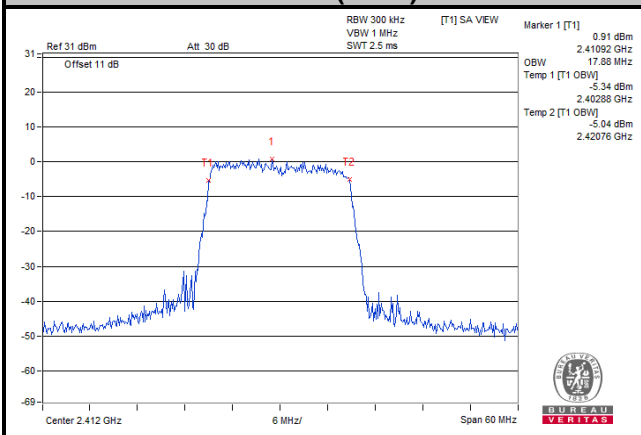

**Mode B**
**802.11b**

Channel	Frequency (MHz)	Occupied Bandwidth (MHz)	Pass / Fail
1	2412	13.92	Pass
6	2437	13.92	Pass
11	2462	13.92	Pass

**802.11g**

Channel	Frequency (MHz)	Occupied Bandwidth (MHz)	Pass / Fail
1	2412	16.92	Pass
6	2437	17.04	Pass
11	2462	17.04	Pass

**802.11n (HT20)**

Channel	Frequency (MHz)	Occupied Bandwidth (MHz)	Pass / Fail
1	2412	17.88	Pass
6	2437	17.88	Pass
11	2462	17.88	Pass

### Spectrum Plot of Worst Value

#### 802.11b

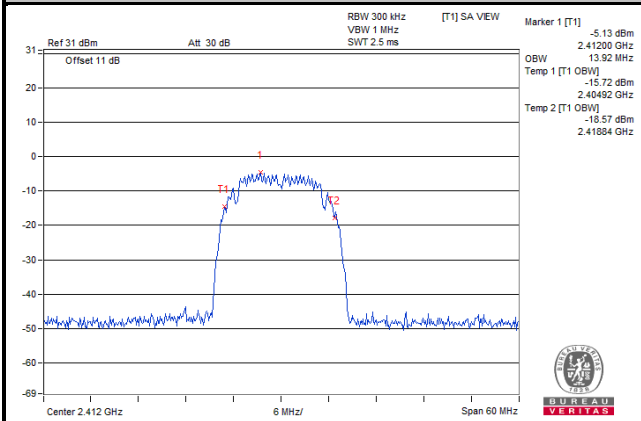

#### 802.11g

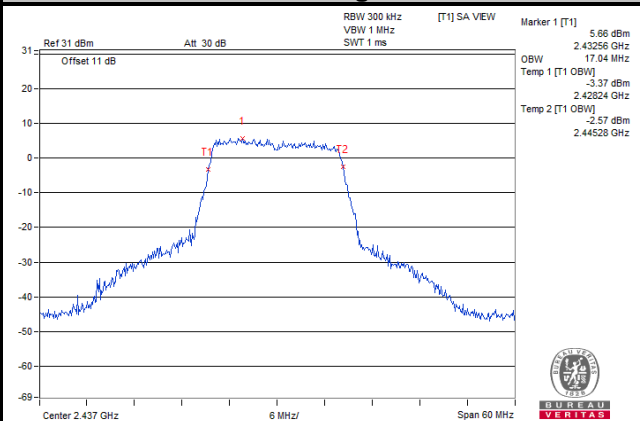

#### 802.11n (HT20)

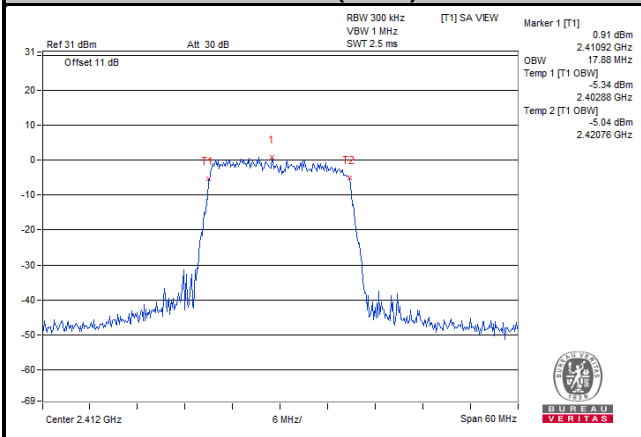



## 4.5 Conducted Output Power Measurement

### 4.5.1 Limits of Conducted Output Power Measurement

For systems using digital modulation in the 2400–2483.5 MHz bands: 1 Watt (30 dBm)

### 4.5.2 Test Setup

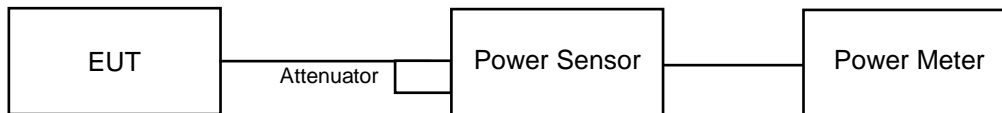

### 4.5.3 Test Instruments

Refer to section 4.1.2 to get information of above instrument.

### 4.5.4 Test Procedures

Average power sensor was used to perform output power measurement, trigger and gating function of wide band power meter is enabled to measure max output power of TX on burst. Duty factor is not added to measured value.

### 4.5.5 Deviation from Test Standard

No deviation.

### 4.5.6 EUT Operating Conditions

The software provided by client to enable the EUT under transmission condition continuously at lowest, middle and highest channel frequencies individually.

#### 4.5.7 Test Results

##### Mode A

##### 802.11b

Channel	Frequency (MHz)	Average Power (mW)	Average Power (dBm)	Limit (dBm)	Pass / Fail
1	2412	4.519	6.55	30	Pass
6	2437	4.831	6.84	30	Pass
11	2462	6.561	8.17	30	Pass

##### 802.11g

Channel	Frequency (MHz)	Average Power (mW)	Average Power (dBm)	Limit (dBm)	Pass / Fail
1	2412	9.638	9.84	30	Pass
6	2437	8.913	9.50	30	Pass
11	2462	13.677	11.36	30	Pass

##### 802.11n (HT20)

Channel	Frequency (MHz)	Average Power (mW)	Average Power (dBm)	Limit (dBm)	Pass / Fail
1	2412	9.506	9.78	30	Pass
6	2437	10.046	10.02	30	Pass
11	2462	13.274	11.23	30	Pass

**Mode B**
**802.11b**

Channel	Frequency (MHz)	Average Power (mW)	Average Power (dBm)	Limit (dBm)	Pass / Fail
1	2412	3.112	4.93	30	Pass
6	2437	3.793	5.79	30	Pass
11	2462	4.808	6.82	30	Pass

**802.11g**

Channel	Frequency (MHz)	Average Power (mW)	Average Power (dBm)	Limit (dBm)	Pass / Fail
1	2412	33.266	15.22	30	Pass
6	2437	40.832	16.11	30	Pass
11	2462	42.56	16.29	30	Pass

**802.11n (HT20)**

Channel	Frequency (MHz)	Average Power (mW)	Average Power (dBm)	Limit (dBm)	Pass / Fail
1	2412	42.756	16.31	30	Pass
6	2437	42.17	16.25	30	Pass
11	2462	33.651	15.27	30	Pass

## 4.6 Power Spectral Density Measurement

### 4.6.1 Limits of Power Spectral Density Measurement

The Maximum of Power Spectral Density Measurement is 8 dBm in any 3 kHz band during any time interval of continuous transmission.

### 4.6.2 Test Setup

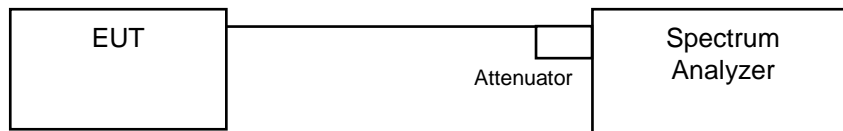

### 4.6.3 Test Instruments

Refer to section 4.1.2 to get information of above instrument.

### 4.6.4 Test Procedure

- a. Set instrument center frequency to DTS channel center frequency.
- b. Set span to at least 1.5 times the OBW.
- c. Set RBW to:  $3 \text{ kHz} \leq \text{RBW} \leq 100 \text{ kHz}$ .
- d. Set VBW  $\geq 3 \times \text{RBW}$ .
- e. Detector = power averaging (RMS) or sample detector (when RMS not available).
- f. Ensure that the number of measurement points in the sweep  $\geq 2 \times \text{span}/\text{RBW}$ .
- g. Sweep time = auto couple.
- h. Employ trace averaging (RMS) mode over a minimum of 100 traces.
- i. Use the peak marker function to determine the maximum amplitude level.

### 4.6.5 Deviation from Test Standard

No deviation.

### 4.6.6 EUT Operating Condition

The software provided by client to enable the EUT under transmission condition continuously at lowest, middle and highest channel frequencies individually.

#### 4.6.7 Test Results

##### Mode A

##### 802.11b

Channel	Frequency (MHz)	PSD (dBm/3 kHz)	Limit (dBm/3 kHz)	Pass / Fail
1	2412	-28.83	8	Pass
6	2437	-28.29	8	Pass
11	2462	-27.44	8	Pass

##### 802.11g

Channel	Frequency (MHz)	PSD (dBm/3 kHz)	Limit (dBm/3 kHz)	Pass / Fail
1	2412	-27.52	8	Pass
6	2437	-27.17	8	Pass
11	2462	-25.22	8	Pass

##### 802.11n (HT20)

Channel	Frequency (MHz)	PSD (dBm/3 kHz)	Limit (dBm/3 kHz)	Pass / Fail
1	2412	-27.44	8	Pass
6	2437	-26.13	8	Pass
11	2462	-26.15	8	Pass

### Spectrum Plot of Worst Value

#### 802.11b

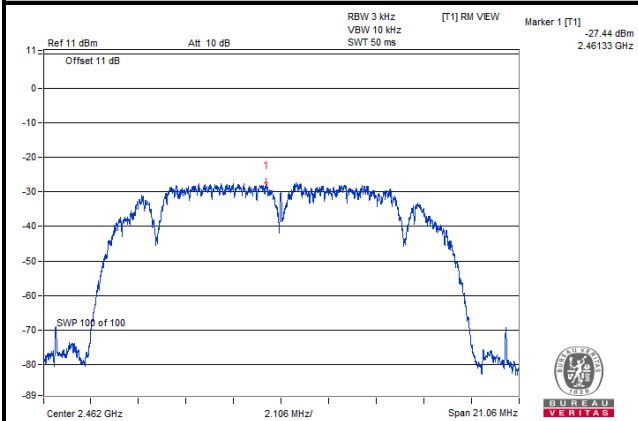

#### 802.11g

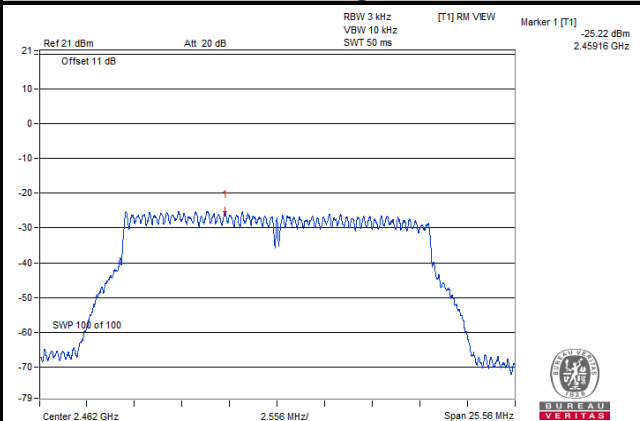

#### 802.11n (HT20)

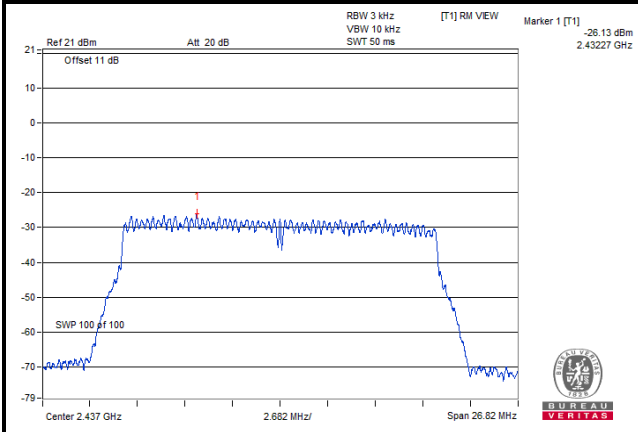

**Mode B**
**802.11b**

Channel	Frequency (MHz)	PSD (dBm/3 kHz)	Limit (dBm/3 kHz)	Pass / Fail
1	2412	-28.33	8	Pass
6	2437	-27.19	8	Pass
11	2462	-26.24	8	Pass

**802.11g**

Channel	Frequency (MHz)	PSD (dBm/3 kHz)	Limit (dBm/3 kHz)	Pass / Fail
1	2412	-22.63	8	Pass
6	2437	-21.67	8	Pass
11	2462	-21.70	8	Pass

**802.11n (HT20)**

Channel	Frequency (MHz)	PSD (dBm/3 kHz)	Limit (dBm/3 kHz)	Pass / Fail
1	2412	-22.43	8	Pass
6	2437	-22.64	8	Pass
11	2462	-23.75	8	Pass

### Spectrum Plot of Worst Value

#### 802.11b

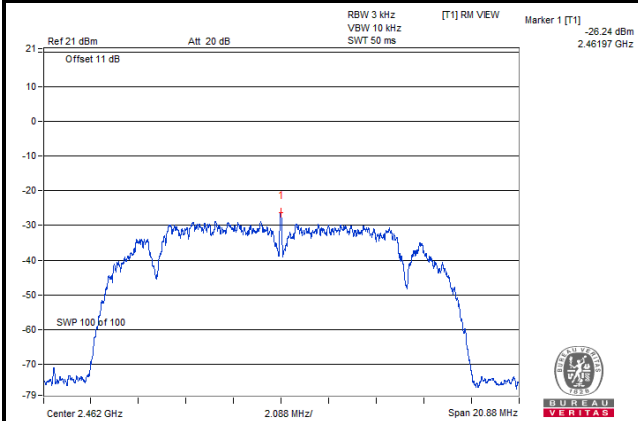

#### 802.11g

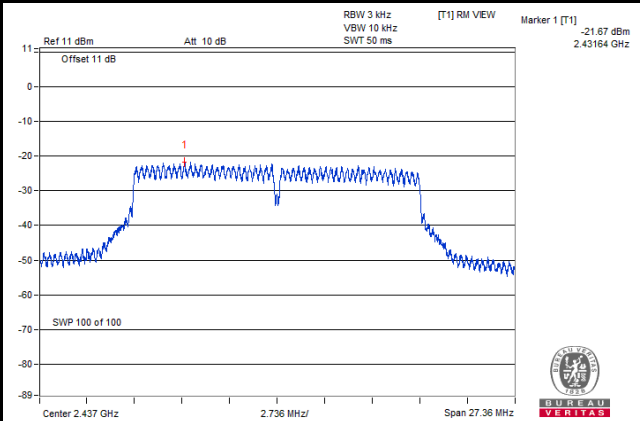

#### 802.11n (HT20)

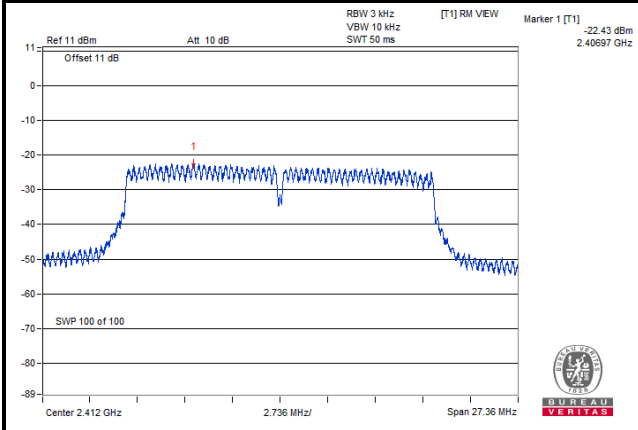



## 4.7 Conducted Out of Band Emission Measurement

### 4.7.1 Limits of Conducted Out of Band Emission Measurement

Below -30 dB of the highest emission level of operating band (in 100 kHz Resolution Bandwidth).

### 4.7.2 Test Setup

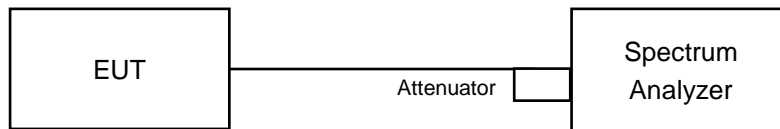

### 4.7.3 Test Instruments

Refer to section 4.1.2 to get information of above instrument.

### 4.7.4 Test Procedure

#### MEASUREMENT PROCEDURE REF

1. Set the RBW = 100 kHz.
2. Set the VBW  $\geq$  300 kHz.
3. Detector = peak.
4. Sweep time = auto couple.
5. Trace mode = max hold.
6. Allow trace to fully stabilize.
7. Use the peak marker function to determine the maximum power level in any 100 kHz band segment within the fundamental EBW.

#### MEASUREMENT PROCEDURE OOB

1. Set RBW = 100 kHz.
2. Set VBW  $\geq$  300 kHz.
3. Detector = peak.
4. Sweep = auto couple.
5. Trace Mode = max hold.
6. Allow trace to fully stabilize.
7. Use the peak marker function to determine the maximum amplitude level.

### 4.7.5 Deviation from Test Standard

No deviation.

### 4.7.6 EUT Operating Condition

The software provided by client to enable the EUT under transmission condition continuously at lowest, middle and highest channel frequencies individually.

### 4.7.7 Test Results

The spectrum plots are attached on the following images. D1 line indicates the highest level, and D2 line indicates the 30 dB offset below D1. It shows compliance with the requirement.

#### Mode A 802.11b

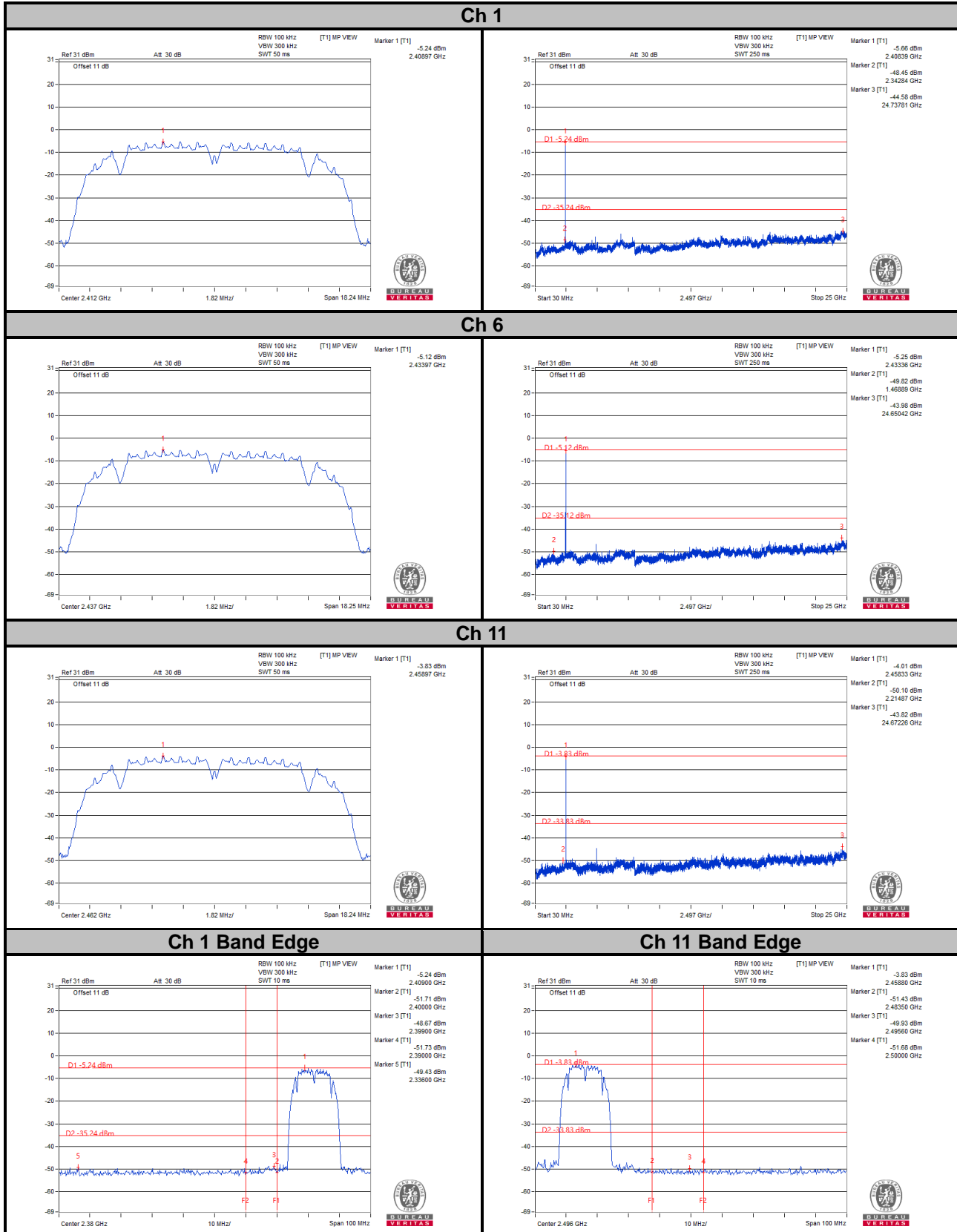

802.11g

Ch 1

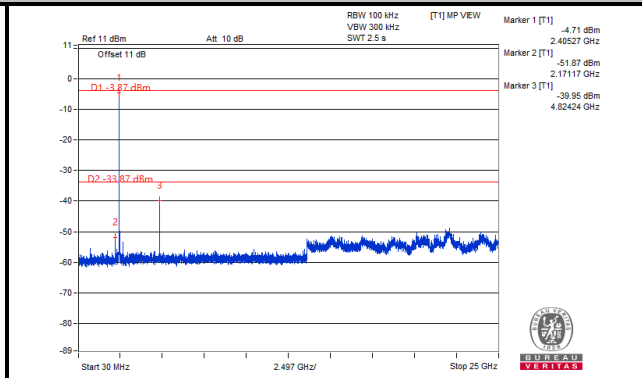
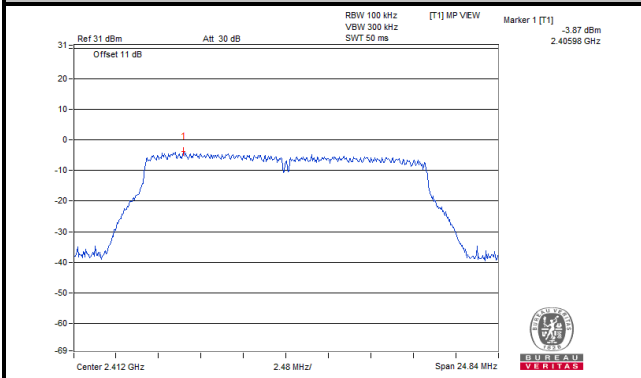

Ch 6

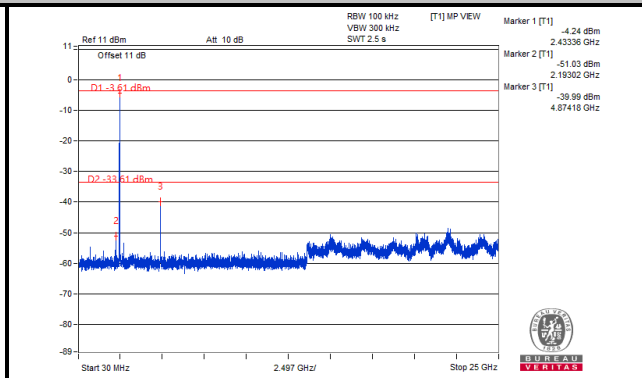
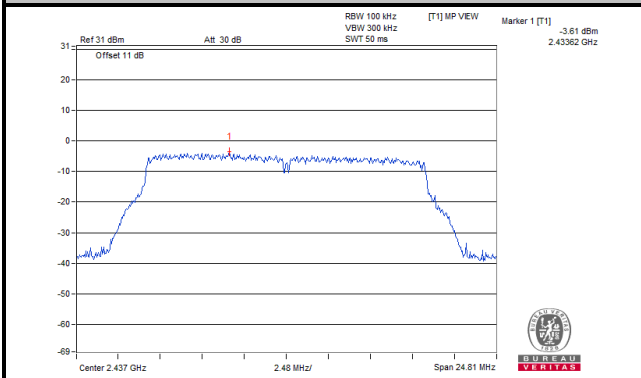

Ch 11

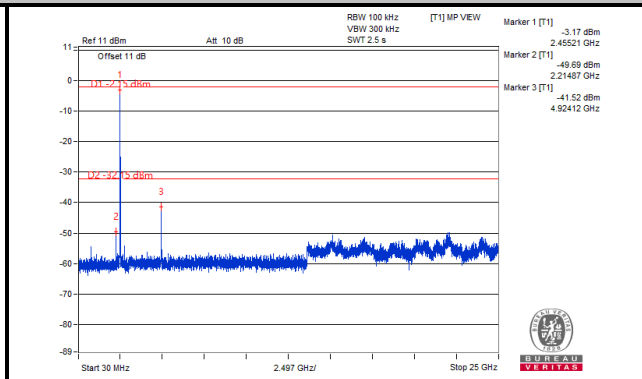
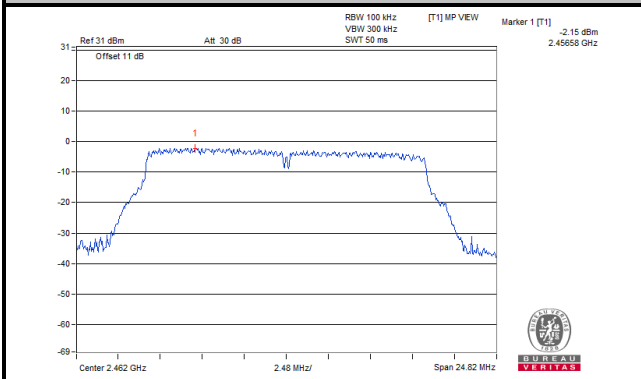

Ch 1 Band Edge

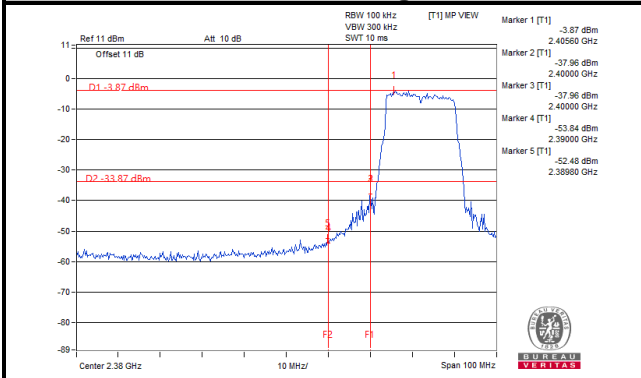

Ch 11 Band Edge

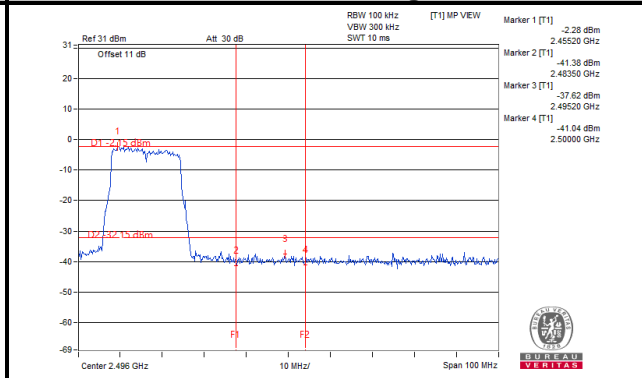

# 802.11n (HT20)

## Ch 1

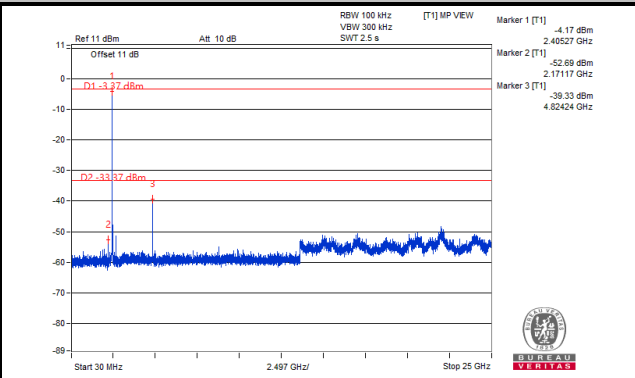
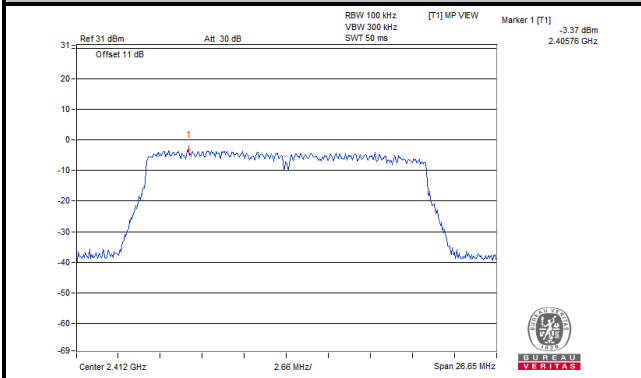

## Ch 6

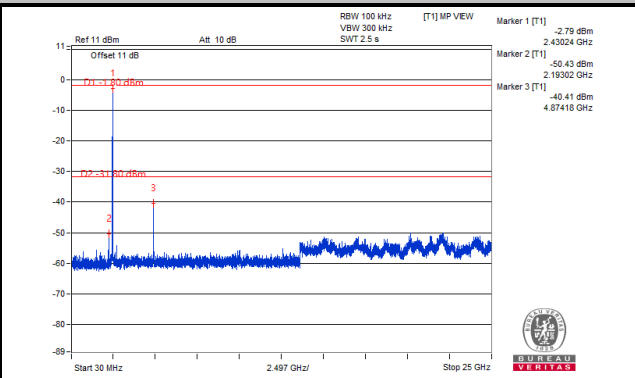
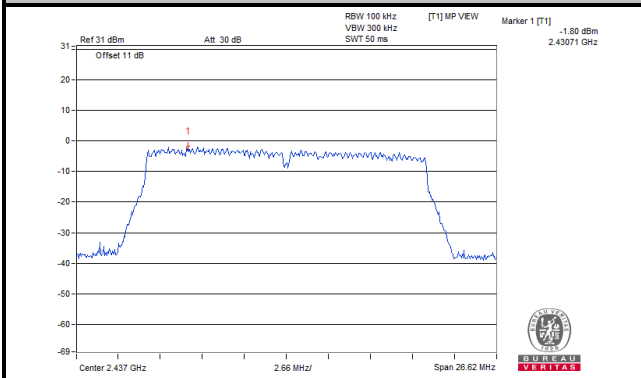

## Ch 11

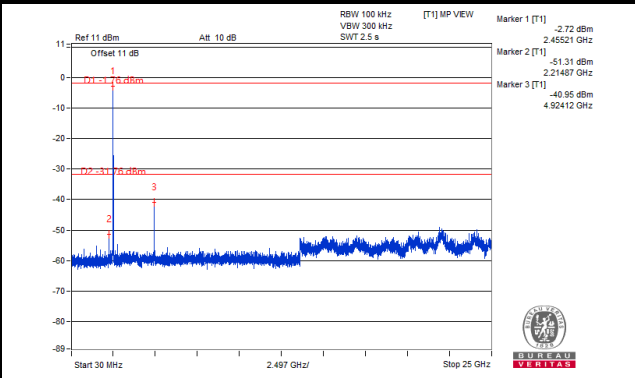
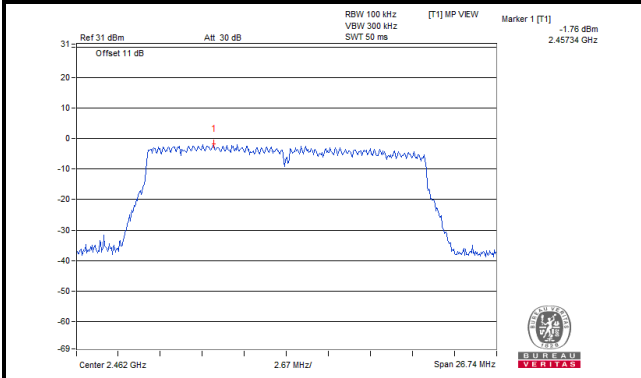

## Ch 1 Band Edge

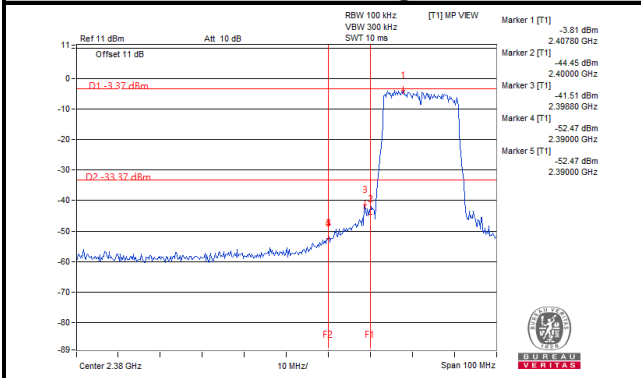

## Ch 11 Band Edge

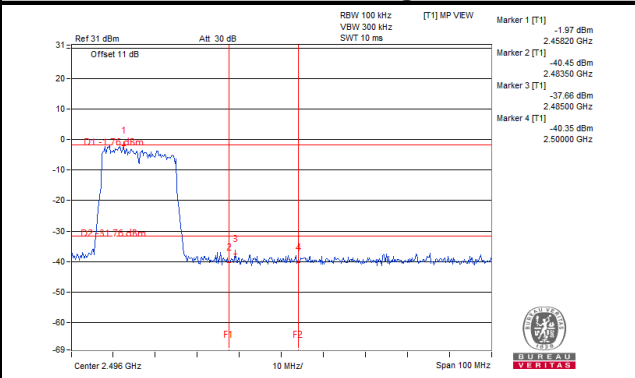

**Mode B**  
**802.11b**

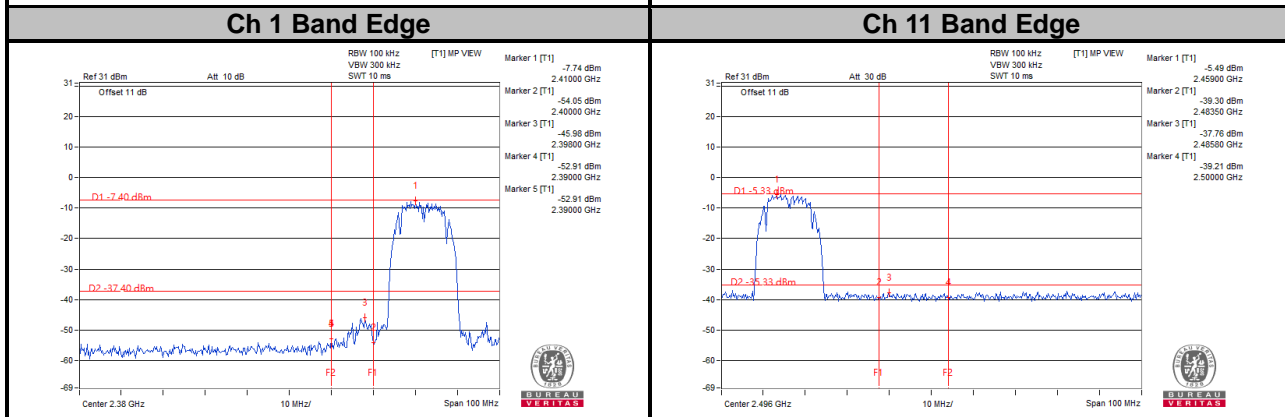
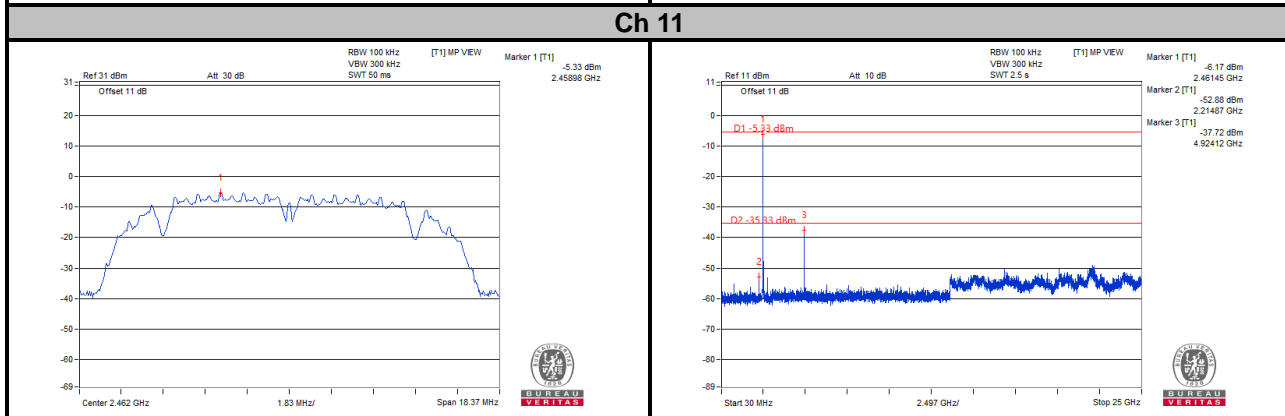
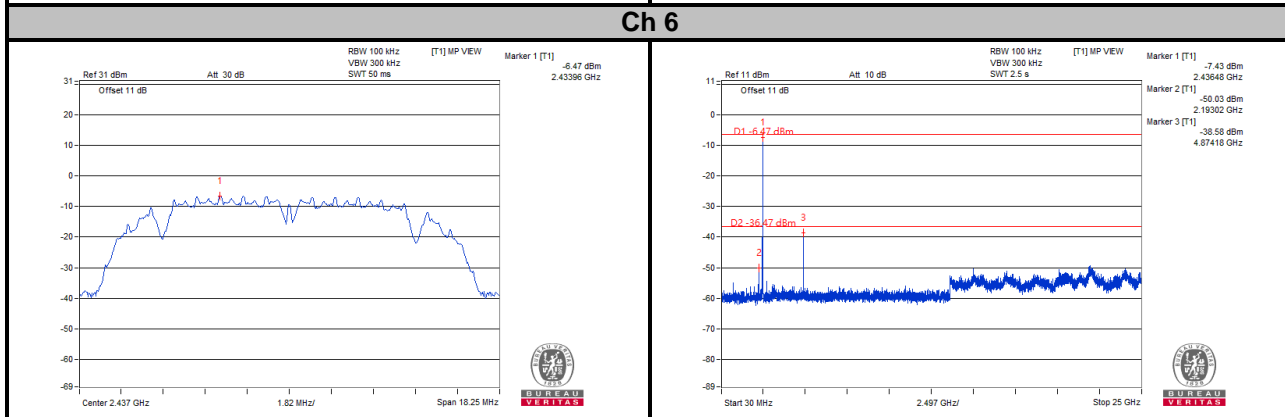
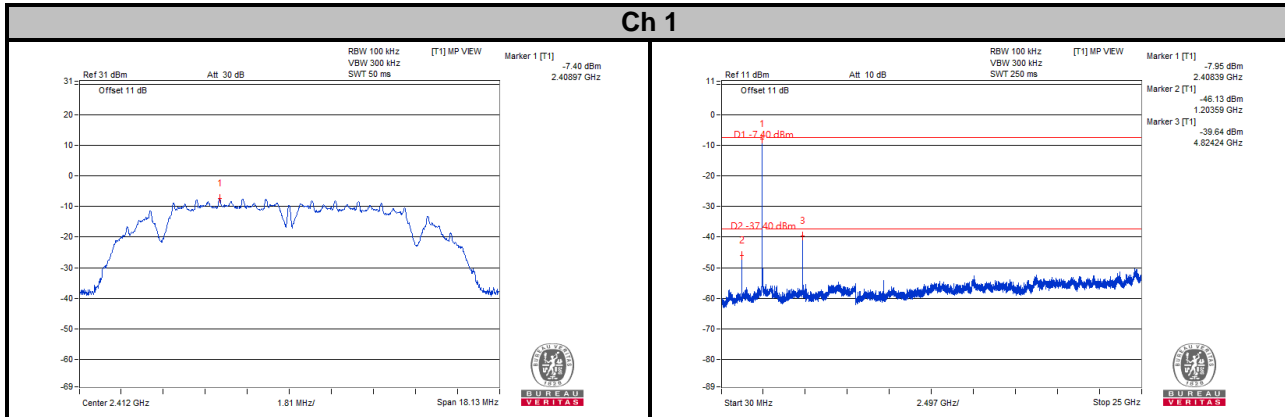

802.11g

Ch 1

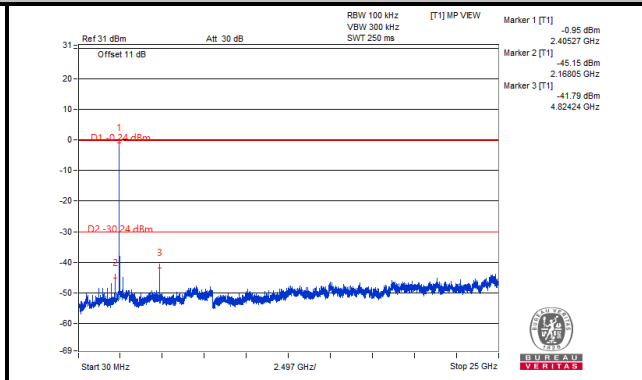
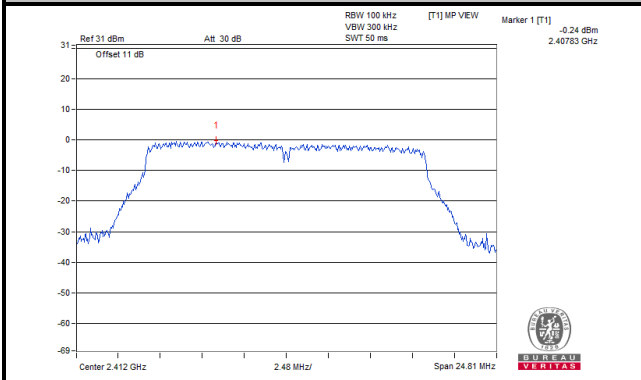

Ch 6

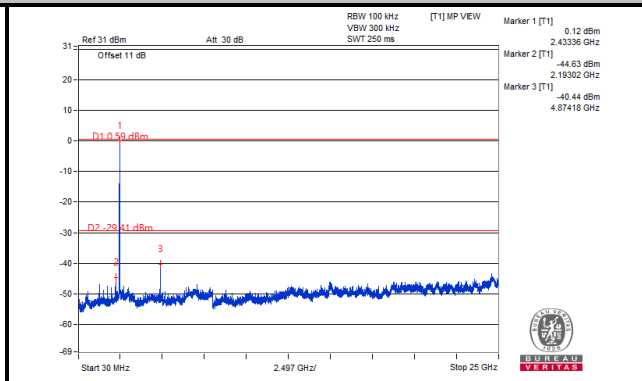
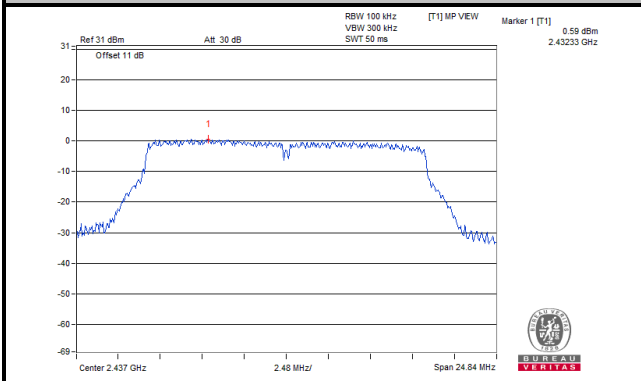

Ch 11

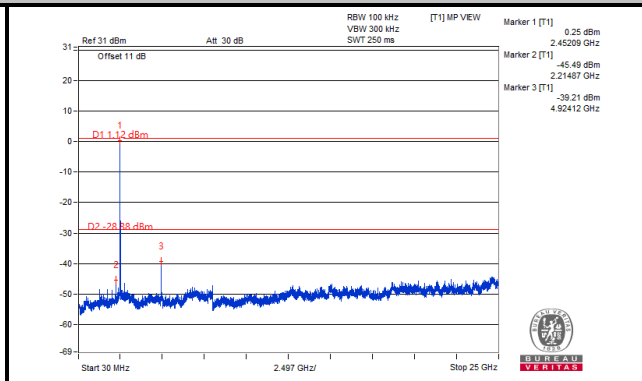
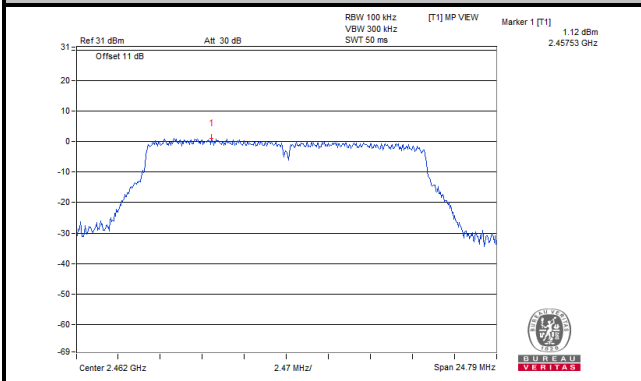

Ch 1 Band Edge

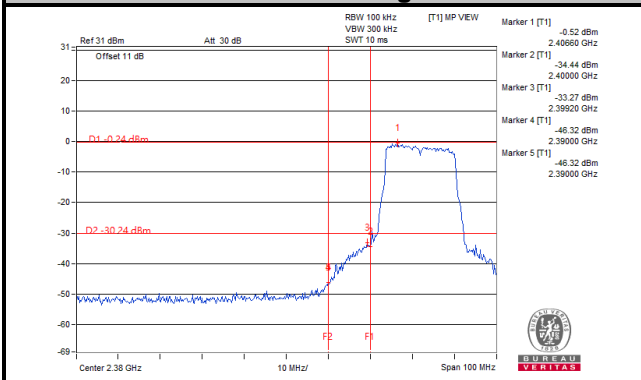

Ch 11 Band Edge

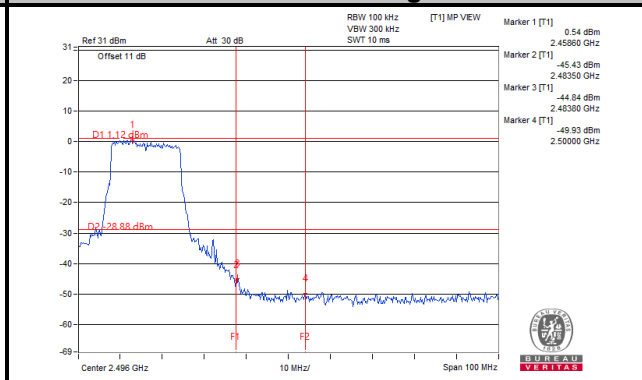

# 802.11n (HT20)

## Ch 1

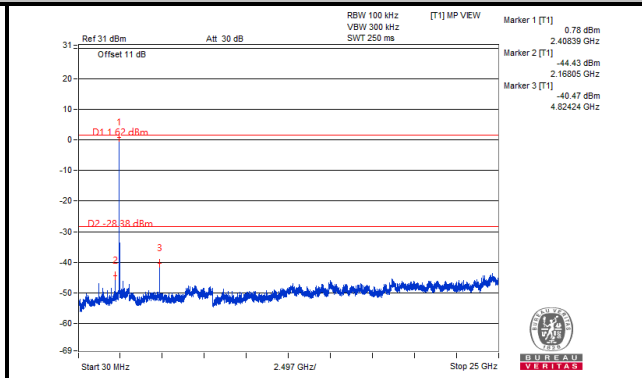
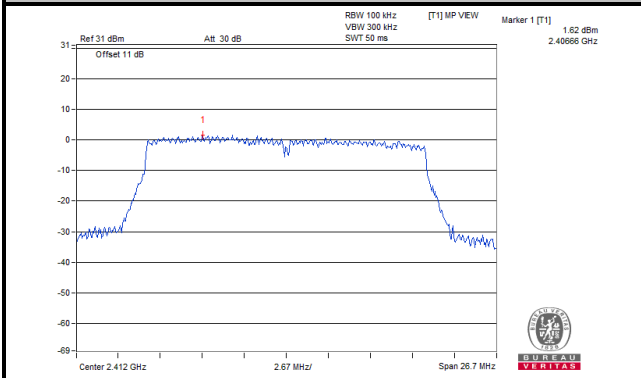

## Ch 6

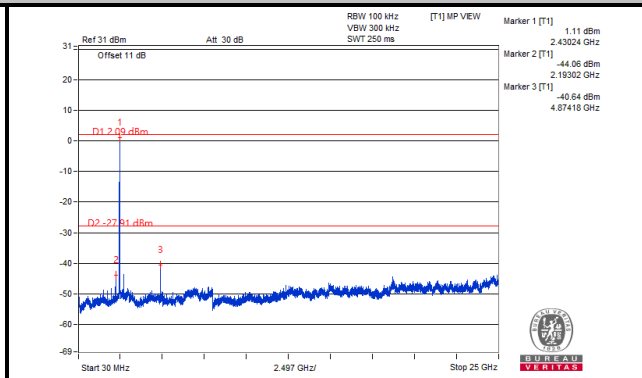
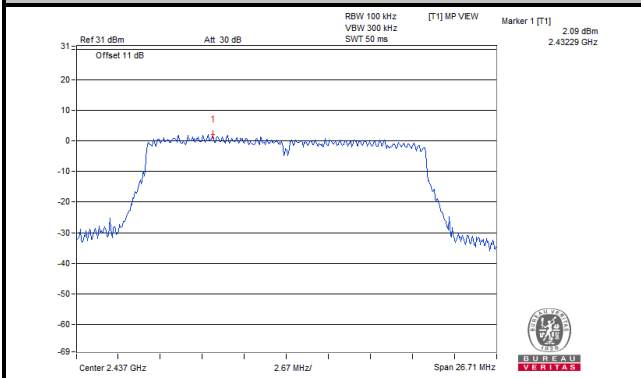

## Ch 11

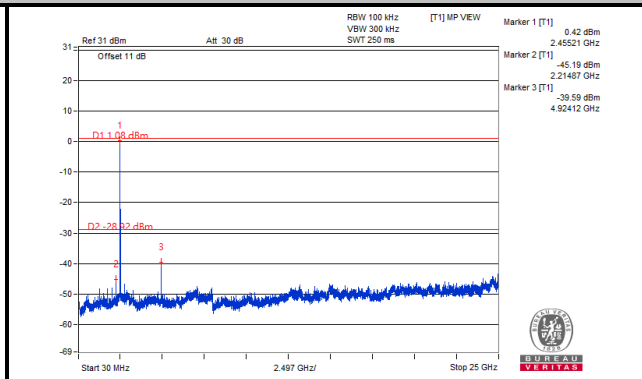
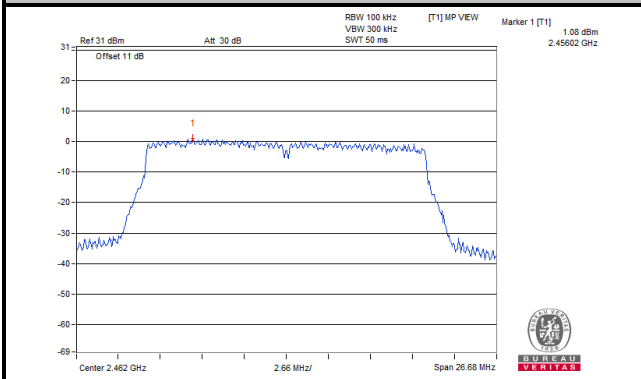

## Ch 1 Band Edge

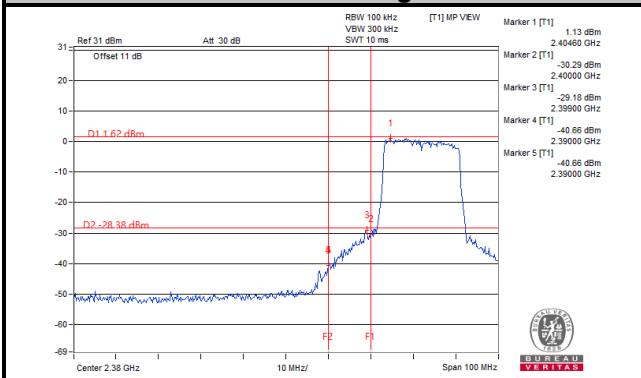

## Ch 11 Band Edge

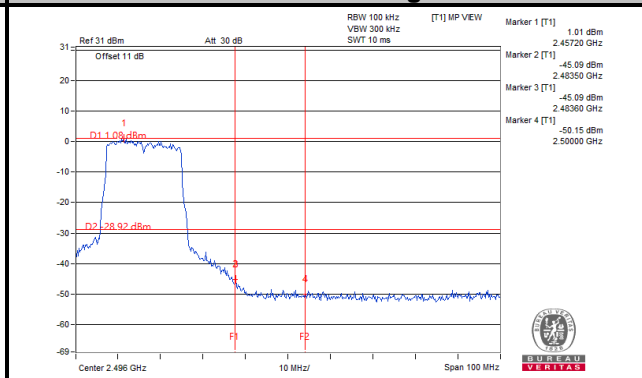

## 5 Pictures of Test Arrangements

Please refer to the attached file (Test Setup Photo).



# Annex A- Band Edge Measurement

## Mode A

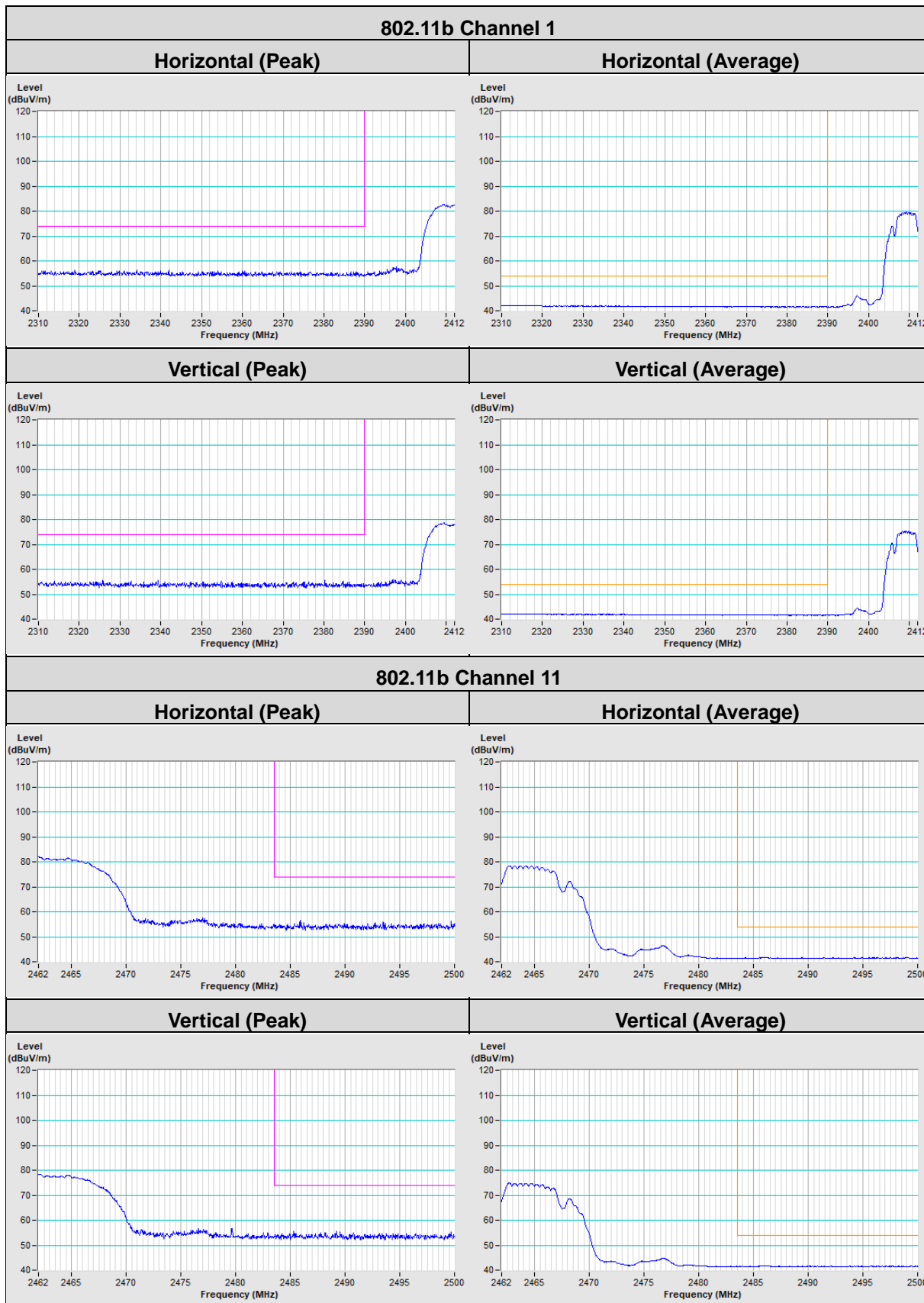





Mode B

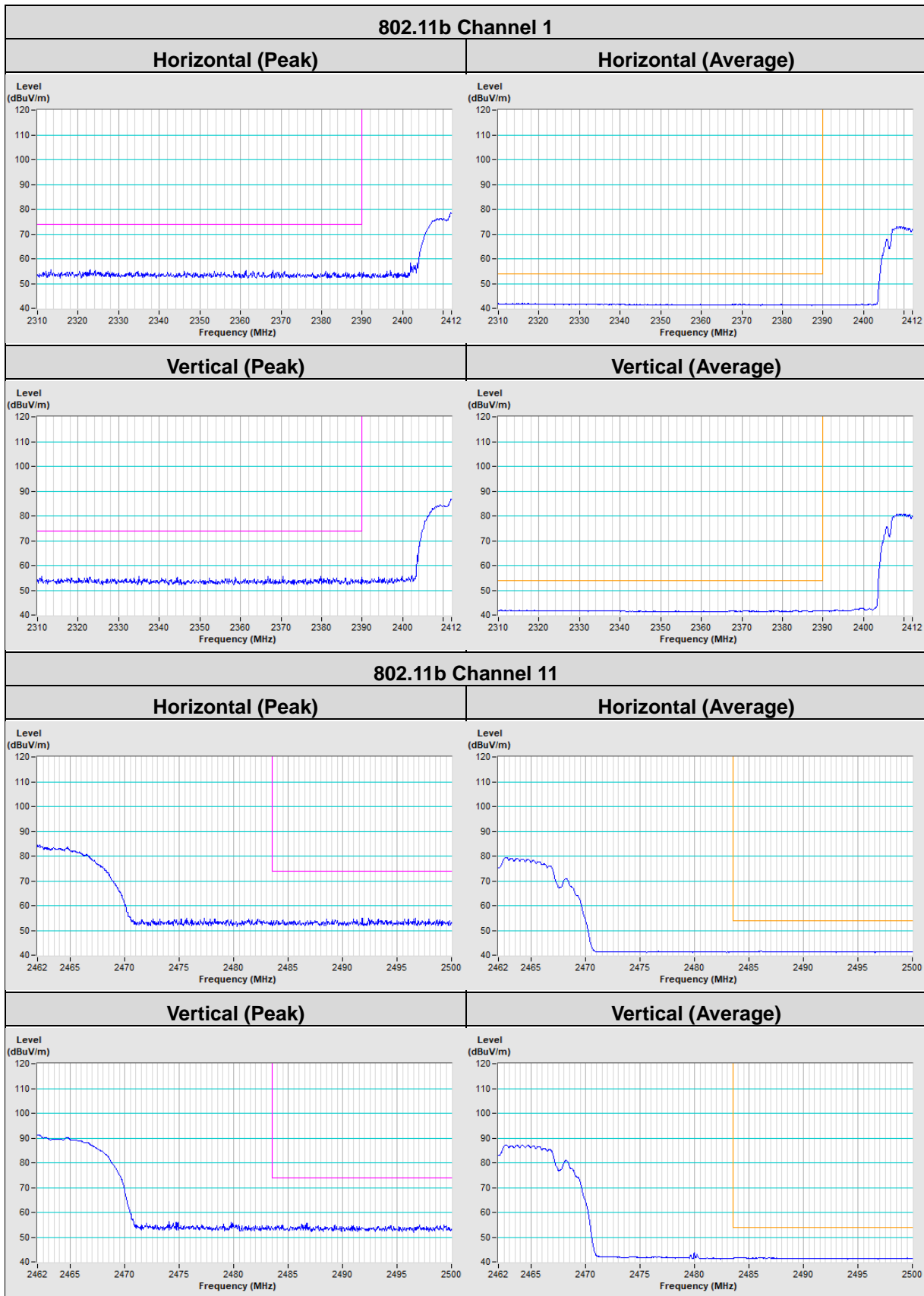

### 802.11g Channel 1

<b>Horizontal (Peak)</b>	<b>Horizontal (Average)</b>
--------------------------	-----------------------------

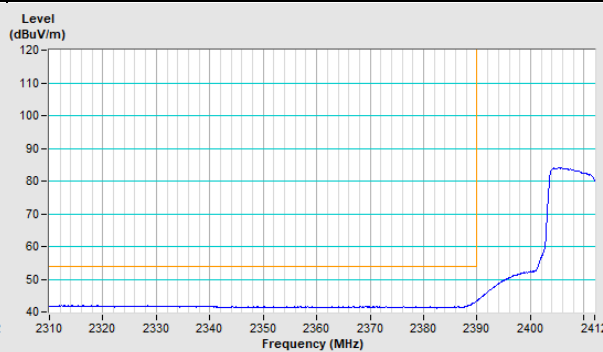
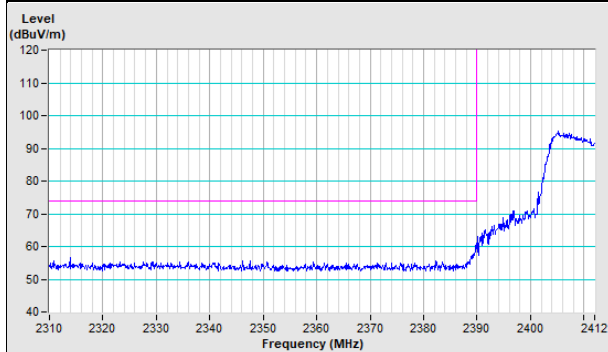

<b>Vertical (Peak)</b>	<b>Vertical (Average)</b>
------------------------	---------------------------

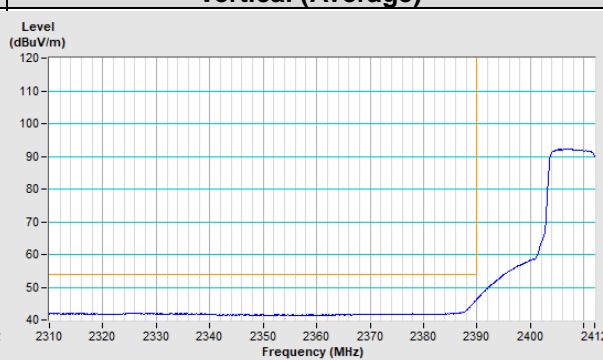
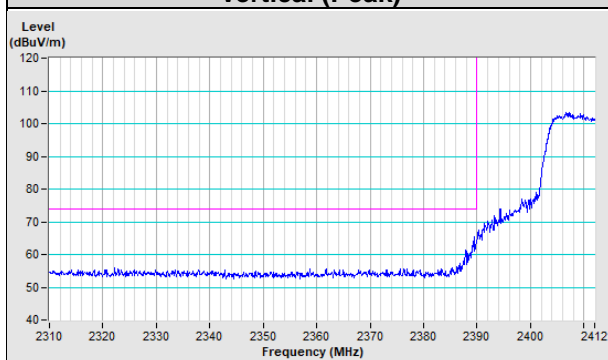

### 802.11g Channel 11

<b>Horizontal (Peak)</b>	<b>Horizontal (Average)</b>
--------------------------	-----------------------------

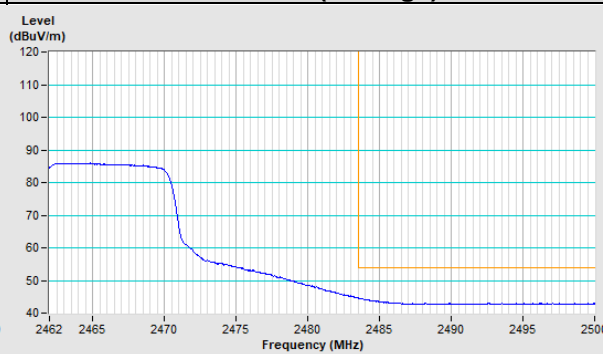
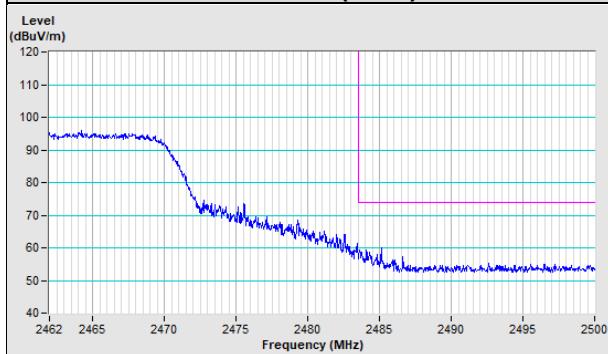

<b>Vertical (Peak)</b>	<b>Vertical (Average)</b>
------------------------	---------------------------

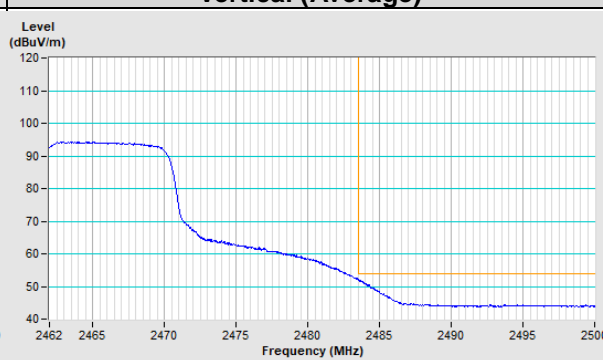
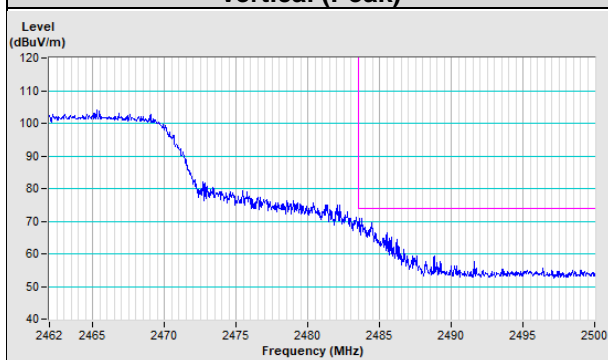



## Appendix – Information of the Testing Laboratories

We, Bureau Veritas Consumer Products Services (H.K.) Ltd., Taoyuan Branch, were founded in 1988 to provide our best service in EMC, Radio, Telecom and Safety consultation. Our laboratories are FCC recognized accredited test firms and accredited according to ISO/IEC 17025.

If you have any comments, please feel free to contact us at the following:

### **Lin Kou EMC/RF Lab**

Tel: 886-2-26052180

Fax: 886-2-26051924

### **Hsin Chu EMC/RF/Telecom Lab**

Tel: 886-3-6668565

Fax: 886-3-6668323

### **Hwa Ya EMC/RF/Safety Lab**

Tel: 886-3-3183232

Fax: 886-3-3270892

**Email:** [service.adt@tw.bureauveritas.com](mailto:service.adt@tw.bureauveritas.com)

**Web Site:** [www.bureauveritas-adt.com](http://www.bureauveritas-adt.com)

The address and road map of all our labs can be found in our web site also.

--- END ---