



FCC RADIO TEST REPORT

FCC ID : 2AG0Z-CM5X
Equipment : Media Receiver
Brand Name : facebook
Model name : LW94NS
Applicant : Facebook Technologies LLC
1 Hacker Way Menlo Park CA 94025
Standard : FCC Part 15 Subpart E §15.407

The product was received on Apr. 08, 2019 and testing was started from Apr. 08, 2019 and completed on Jun. 14, 2019. We, SPORTON INTERNATIONAL INC., EMC & Wireless Communications Laboratory, would like to declare that the tested sample has been evaluated in accordance with the test procedures and has been in compliance with the applicable technical standards.

The report must not be used by the client to claim product certification, approval, or endorsement by TAF or any agency of government.

The test results in this report apply exclusively to the tested model / sample. Without written approval of SPORTON INTERNATIONAL INC. EMC & Wireless Communications Laboratory, the test report shall not be reproduced except in full.

Approved by: Jones Tsai

SPORTON INTERNATIONAL INC. EMC & Wireless Communications Laboratory
No. 52, Huaya 1st Rd., Guishan Dist., Taoyuan City, Taiwan (R.O.C.)



Table of Contents

History of this test report.....	3
Summary of Test Result.....	4
1 General Description	5
1.1 Product Feature of Equipment Under Test.....	5
1.2 Modification of EUT	5
1.3 Testing Location	5
1.4 Applicable Standards.....	6
2 Test Configuration of Equipment Under Test	7
2.1 Carrier Frequency and Channel	7
2.2 Test Mode.....	8
2.3 Connection Diagram of Test System.....	9
2.4 Support Unit used in test configuration and system	10
2.5 EUT Operation Test Setup	10
2.6 Measurement Results Explanation Example.....	10
3 Test Result	11
3.1 6dB and 26dB and 99% Occupied Bandwidth Measurement	11
3.2 Maximum Conducted Output Power Measurement	14
3.3 Power Spectral Density Measurement	15
3.4 Unwanted Emissions Measurement.....	18
3.5 AC Conducted Emission Measurement.....	23
3.6 Automatically Discontinue Transmission	25
3.7 Antenna Requirements	26
4 List of Measuring Equipment.....	27
5 Uncertainty of Evaluation	29
Appendix A. Conducted Test Results	
Appendix B. AC Conducted Emission Test Result	
Appendix C. Radiated Spurious Emission	
Appendix D. Radiated Spurious Emission Plots	
Appendix E. Duty Cycle Plots	
Appendix F. Setup Photographs	



Summary of Test Result

Report Clause	Ref Std. Clause	Test Items	Result (PASS/FAIL)	Remark
3.1	15.403 (i)	6dB & 26dB Bandwidth	Pass	-
3.1	2.1049	99% Occupied Bandwidth	Reporting only	-
3.2	15.407 (a)	Maximum Conducted Output Power	Pass	-
3.3	15.407 (a)	Power Spectral Density	Pass	-
3.4	15.407(b)	Unwanted Emissions	Pass	Under limit 6.57 dB at 897.18 MHz
3.5	15.207	AC Conducted Emission	Pass	Under limit 11.08 dB at 0.686 MHz
3.6	15.407 (c)	Automatically Discontinue Transmission	Pass	-
3.7	15.203 & 15.407 (a)	Antenna Requirement	Pass	-

Declaration of Conformity:

The test results with all measurement uncertainty excluded are presented in accordance with the regulation limits or requirements declared by manufacturers.

Comments and Explanations:

The declared of product specification for EUT presented in the report are provided by the manufacturer, and the manufacturer takes all the responsibilities for the accuracy of product specification.

Reviewed by: Wii Chang**Report Producer: Yimin Ho**



1 General Description

1.1 Product Feature of Equipment Under Test

Bluetooth, Wi-Fi 2.4GHz 802.11b/g/n, Wi-Fi 5GHz 802.11a/n/ac

Product Specification subjective to this standard	
Antenna Type	WLAN: PIFA Antenna Bluetooth: PIFA Antenna

1.2 Modification of EUT

No modifications are made to the EUT during all test items.

1.3 Testing Location

Test Site	SPORTON INTERNATIONAL INC. EMC & Wireless Communications Laboratory	
Test Site Location	No.52, Huaya 1st Rd., Guishan Dist., Taoyuan City, Taiwan (R.O.C.) TEL: +886-3-327-3456 FAX: +886-3-328-4978	
Test Site No.	Sporton Site No.	
	TH05-HY	CO05-HY

Note: The test site complies with ANSI C63.4 2014 requirement.

Test Site	SPORTON INTERNATIONAL INC. EMC & Wireless Communications Laboratory	
Test Site Location	No. 58, Huaya 1st Rd., Guishan Dist., Taoyuan City, Taiwan (R.O.C.) TEL: +886-3-327-3456 FAX: +886-3-328-4978	
Test Site No.	Sporton Site No.	
	03CH013-HY	

Note: The test site complies with ANSI C63.4 2014 requirement.

FCC designation No.: TW1190 and TW0007



1.4 Applicable Standards

According to the specifications of the manufacturer, the EUT must comply with the requirements of the following standards:

- ♦ FCC Part 15 Subpart E
- ♦ FCC KDB 789033 D02 General UNII Test Procedures New Rules v02r01.
- ♦ FCC KDB 414788 D01 Radiated Test Site v01r01.
- ♦ FCC KDB 662911 D01 Multiple Transmitter Output v02r01.
- ♦ ANSI C63.10-2013

Remark:

1. All test items were verified and recorded according to the standards and without any deviation during the test.
2. This EUT has also been tested and complied with the requirements of FCC Part 15, Subpart B, recorded in a separate test report.



2 Test Configuration of Equipment Under Test

- a. The EUT has been associated with peripherals and configuration operated in a manner tended to maximize its emission characteristics in a typical application. Frequency range investigated: conduction emission (150 kHz to 30 MHz), radiation emission (9 kHz to the 10th harmonic of the highest fundamental frequency or to 40 GHz, whichever is lower). For radiated measurement, pre-scanned in two setup, without all accessories, with all accessories. The worst cases (without all accessories) were recorded in this report.
- b. AC power line Conducted Emission was tested under maximum output power.

2.1 Carrier Frequency and Channel

Frequency Band	Channel	Freq. (MHz)	Channel	Freq. (MHz)
5725-5850 MHz Band 4 (U-NII-3)	149	5745	157	5785
	151*	5755	159*	5795
	153	5765	161	5805
	155 [#]	5775	165	5825

Note:

- 1. The above Frequency and Channel in "*" were 802.11n HT40 and 802.11ac VHT40.
- 2. The above Frequency and Channel in "[#]" were 802.11ac VHT80.



2.2 Test Mode

Final test modes are considering the modulation and worse data rates as below table.

MIMO Mode

Modulation	Data Rate
802.11a	6 Mbps
802.11n HT20	MCS0
802.11n HT40	MCS0
802.11n HT20 (Covered by VHT20)	MCS0
802.11n HT40 (Covered by VHT40)	MCS0
802.11ac VHT80	MCS0

Test Cases	
AC Conducted Emission	Mode 1 : Bluetooth Link + WLAN (5GHz) Link + Adapter + MPEG4 + HDMI
Remark: For Radiated Test Cases, the tests were performed with Adapter.	

Ch. #	Band IV : 5725-5850 MHz			
	802.11a	802.11n HT20	802.11n HT40	802.11ac VHT80
L Low	149	149	151	-
M Middle	157	157	-	155
H High	165	165	159	-

2.3 Connection Diagram of Test System

<WLAN Tx Mode>

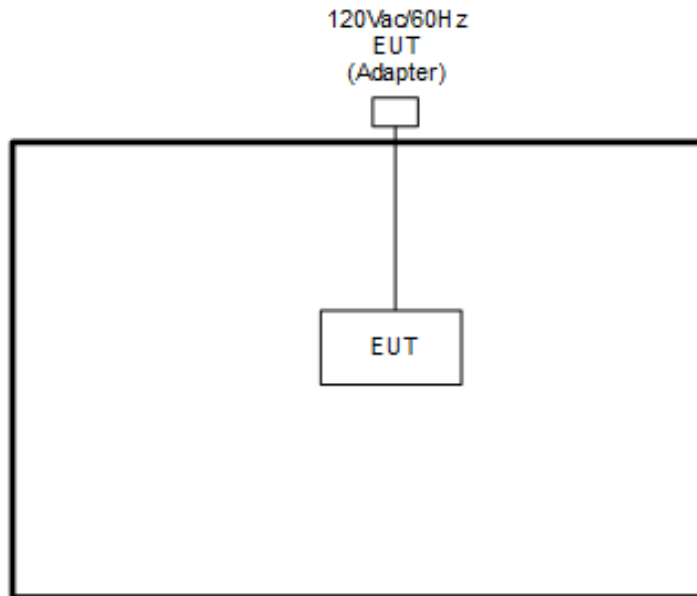

<AC Conducted Emission Mode>

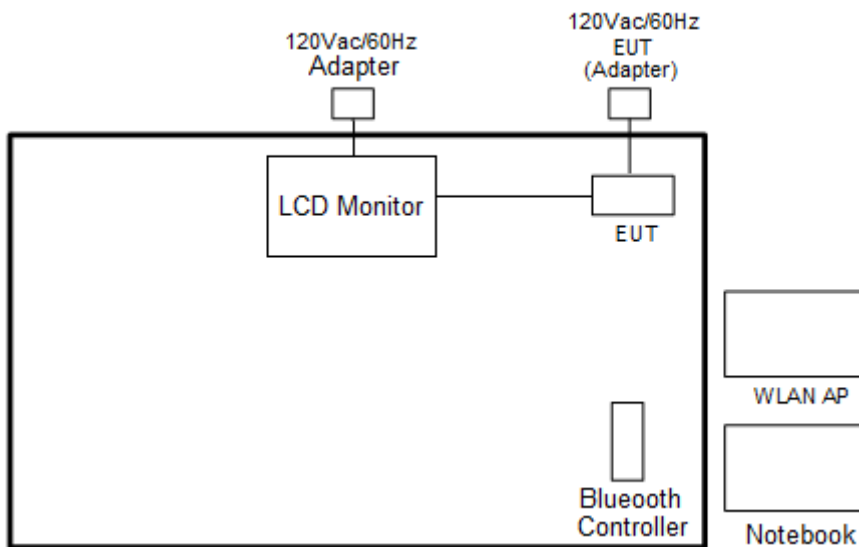



2.4 Support Unit used in test configuration and system

Item	Equipment	Trade Name	Model Name	FCC ID	Data Cable	Power Cord
1.	WLAN AP	ASUS	RT-AC66U	MSQ-RTAC66U	N/A	Unshielded,1.8m
2.	Notebook	DELL	Latitude E6320	FCC DoC	N/A	AC I/P: Unshielded, 1.2 m DC O/P: Shielded, 1.8 m
3.	LCD Monitor	DELL	P2715Qt	FCC DoC	Shielded, 1.6m	Unshielded,1.8m

2.5 EUT Operation Test Setup

The RF test items, utility “QRCT v3.0-00271” was installed in Notebook which was programmed in order to make the EUT get into the engineering modes to provide channel selection, power level, data rate and the application type and for continuous transmitting signals.

2.6 Measurement Results Explanation Example

For all conducted test items:

The offset level is set in the spectrum analyzer to compensate the RF cable loss and attenuator factor between EUT conducted output port and spectrum analyzer. With the offset compensation, the spectrum analyzer reading level is exactly the EUT RF output level.

Example :

The spectrum analyzer offset is derived from RF cable loss and attenuator factor.

Offset = RF cable loss + attenuator factor.

Following shows an offset computation example with cable loss 17.80 dB and 10.00dB attenuator.

$$\begin{aligned} \text{Offset(dB)} &= \text{RF cable loss(dB)} + \text{attenuator factor(dB)}. \\ &= 17.80 + 10.00 = 27.80(\text{dB}) \end{aligned}$$

3 Test Result

3.1 6dB and 26dB and 99% Occupied Bandwidth Measurement

3.1.1 Description of 6dB and 26dB and 99% Occupied Bandwidth

The minimum 6 dB bandwidth shall be at least 500 kHz.

26dB and 99% Occupied bandwidth are reporting only.

3.1.2 Measuring Instruments

See list of measuring equipment of this test report.

3.1.3 Test Procedures

1. The testing follows FCC KDB 789033 D02 General UNII Test Procedures New Rules v02r01. Section C) Emission bandwidth for the band 5.725-5.85GHz
2. Set RBW = 100kHz.
3. Set the VBW $\geq 3 \times$ RBW.
4. Detector = Peak.
5. Trace mode = max hold
6. Measure the maximum width of the emission that is 6 dB down from the peak of the emission.
7. Measure and record the results in the test report.

3.1.4 Test Setup

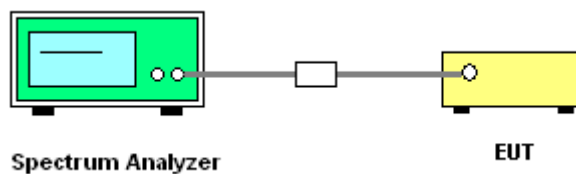

3.1.5 Test Result of 6dB and 26dB and 99% Occupied Bandwidth

Please refer to Appendix A.

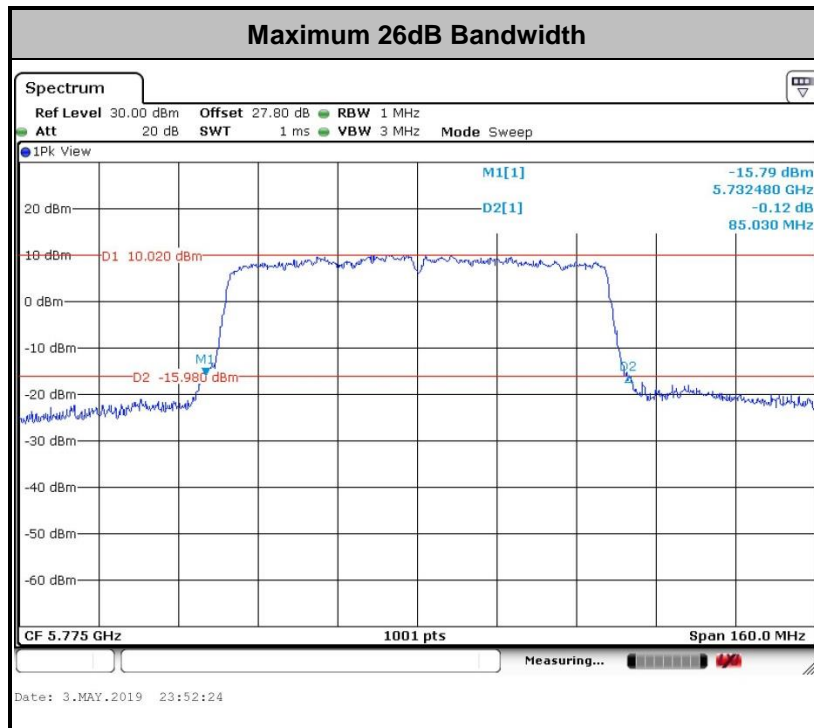
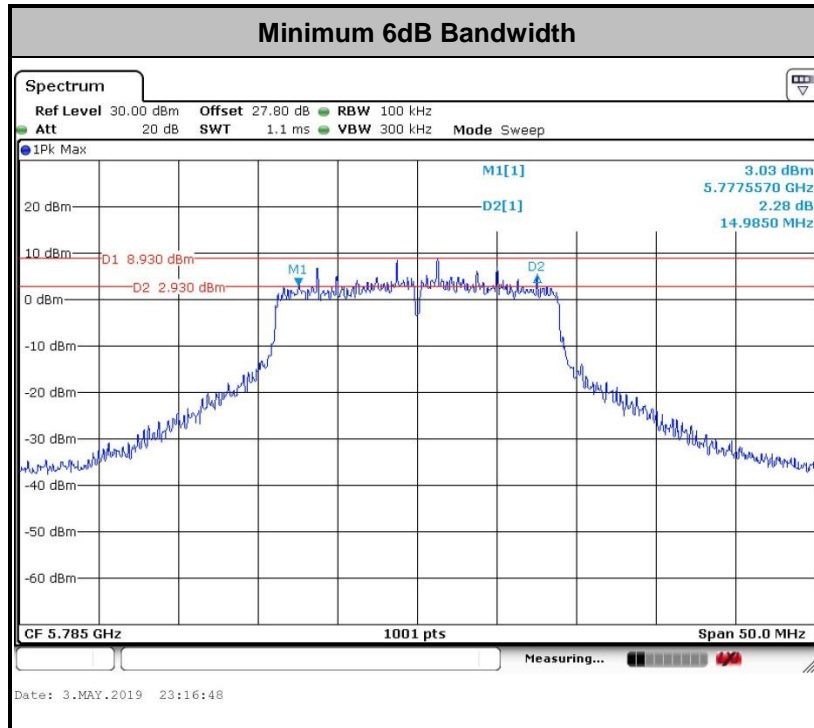

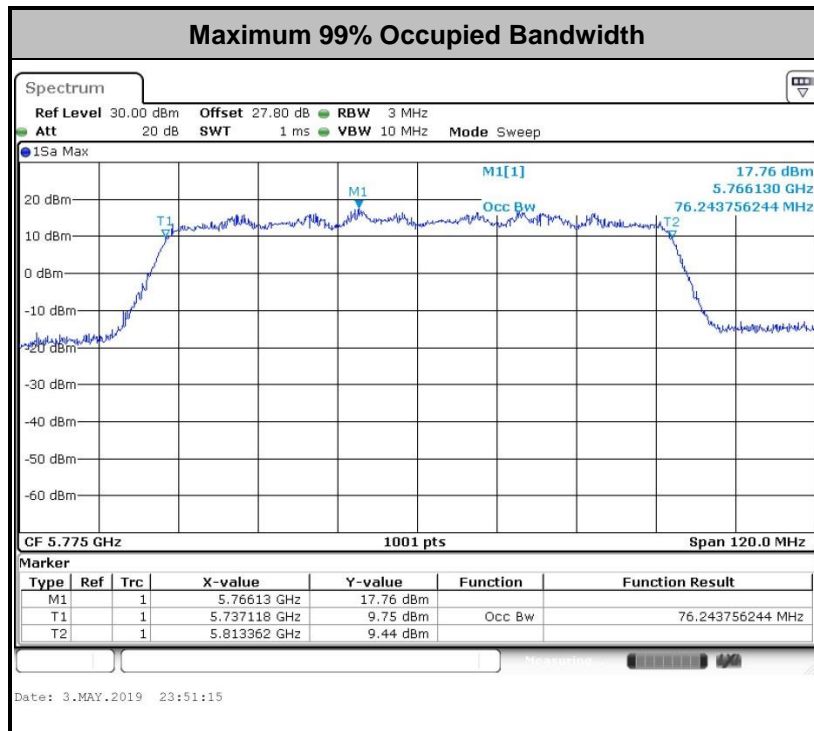

Note: The occupied channel bandwidth is maintained within the band of operation for all of the modulations.

3.2 Maximum Conducted Output Power Measurement

3.2.1 Limit of Maximum Conducted Output Power

For the band 5.725–5.85 GHz, the maximum conducted output power over the frequency band of operation shall not exceed 1 W.

If transmitting antennas of directional gain greater than 6 dBi are used, the peak output power shall be reduced by the amount in dB that the directional gain of the antenna exceeds 6 dBi.

3.2.2 Measuring Instruments

See list of measuring equipment of this test report.

3.2.3 Test Procedures

The testing follows Method PM-G of FCC KDB 789033 D02 General UNII Test Procedures New Rules v02r01.

Method PM (Measurement using an RF average power meter):

1. Measurement is performed using a wideband RF power meter.
2. The EUT is configured to transmit continuously with a consistent duty cycle at its maximum power control level.
3. Measure the average power of the transmitter, and the average power is corrected with duty factor, $10 \log(1/x)$, where x is the duty cycle.

3.2.4 Test Setup

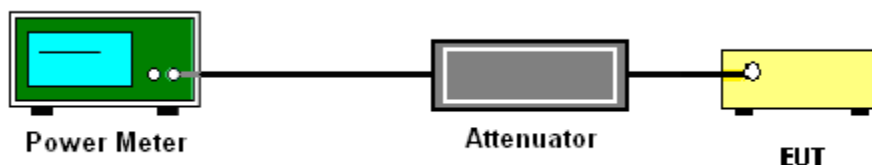

3.2.5 Test Result of Maximum Conducted Output Power

Please refer to Appendix A.



3.3 Power Spectral Density Measurement

3.3.1 Limit of Power Spectral Density

For the band 5.725–5.85 GHz, the maximum power spectral density shall not exceed 30 dBm in any 500-kHz band.

If transmitting antennas of directional gain greater than 6 dBi are used, the peak output power shall be reduced by the amount in dB that the directional gain of the antenna exceeds 6 dBi.

3.3.2 Measuring Instruments

See list of measuring equipment of this test report.

3.3.3 Test Procedures

The testing follows FCC KDB 789033 D02 General UNII Test Procedures New Rules v02r01. Section F) Maximum power spectral density.

Method SA-2

(trace averaging across on and off times of the EUT transmissions, followed by duty cycle correction).

- Measure the duty cycle.
- Set span to encompass the entire emission bandwidth (EBW) of the signal.
- Set RBW = 300 kHz.
- Set VBW \geq 1 MHz.
- Number of points in sweep \geq 2 Span / RBW.
- Sweep time = auto.
- Detector = RMS
- Trace average at least 100 traces in power averaging mode.
- Add $10 \log(500\text{kHz}/\text{RBW})$ to the test result.
- Add $10 \log(1/x)$, where x is the duty cycle, to the measured power in order to compute the average power during the actual transmission times. For example, add $10 \log(1/0.25) = 6$ dB if the duty cycle is 25 percent.

1. The RF output of EUT was connected to the spectrum analyzer by a low loss cable.
2. Each plot has already offset with cable loss, and attenuator loss. Measure the PPSD and record it.
3. For MIMO mode, calculation method follows FCC KDB 662911 D01 Multiple Transmitter Output v02r01.

Method (c): Measure and add $10 \log(N_{\text{ANT}})$ dB.

With this technique, spectrum measurements are performed at each output of the device, but rather than summing the spectra or the spectral peaks across the outputs, the quantity $10 \log(N_{\text{ANT}})$ dB is added to each spectrum value before comparing to the emission limit. The addition of $10 \log(N_{\text{ANT}})$ dB serves to apportion the emission limit among the N_{ANT} outputs so that each output is permitted to contribute no more than $1/N_{\text{ANT}}^{\text{th}}$ of the PSD limit.

3.3.4 Test Setup

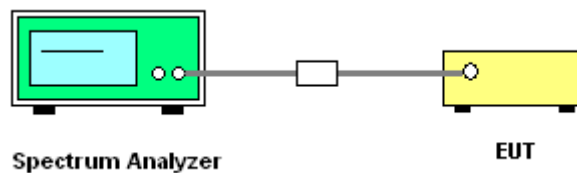



3.3.5 Test Result of Power Spectral Density

Please refer to Appendix A.

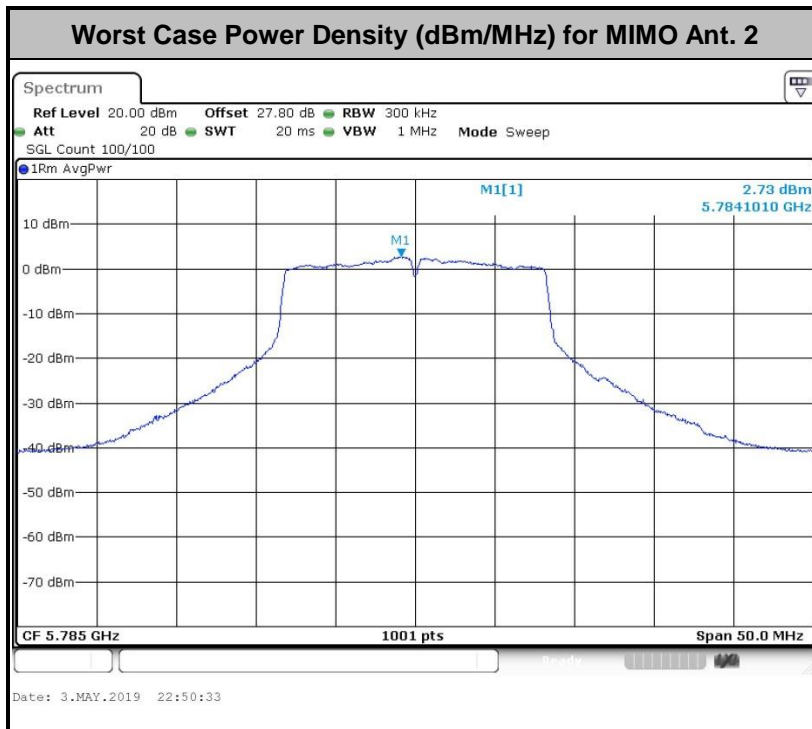
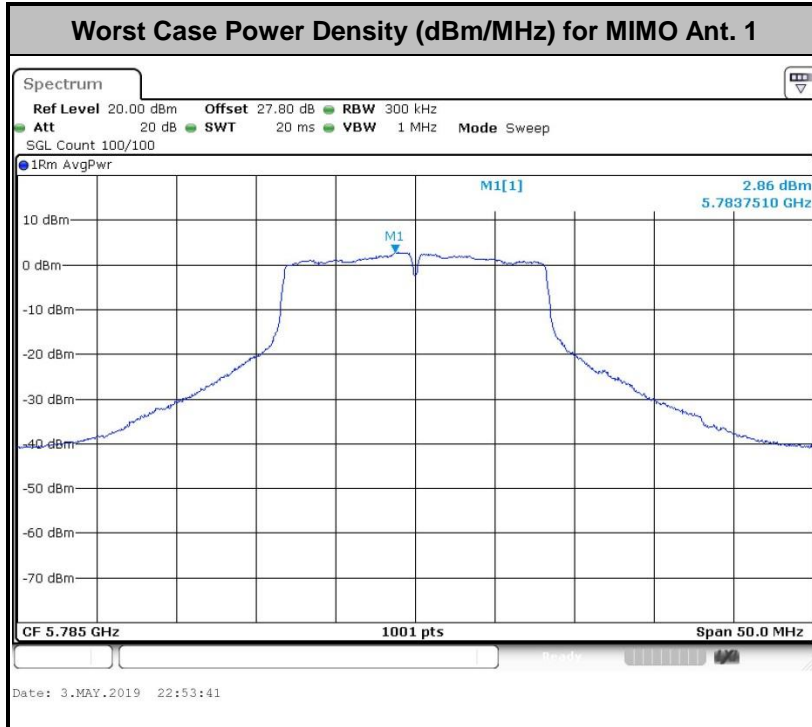



3.4 Unwanted Emissions Measurement

This section is to measure unwanted emissions through radiated measurement for band edge spurious emissions and out of band emissions measurement.

3.4.1 Limit of Unwanted Emissions

- (1) For transmitters operating in the 5.725-5.85 GHz band:
 15.407(b)(4)(i) All emissions shall be limited to a level of -27 dBm/MHz at 75 MHz or more above or below the band edge increasing linearly to 10 dBm/MHz at 25 MHz above or below the band edge, and from 25 MHz above or below the band edge increasing linearly to a level of 15.6 dBm/MHz at 5 MHz above or below the band edge, and from 5 MHz above or below the band edge increasing linearly to a level of 27 dBm/MHz at the band edge.
- (2) Unwanted spurious emissions fallen in restricted bands shall comply with the general field strength limits as below table,

Frequency (MHz)	Field Strength (microvolts/meter)	Measurement Distance (meters)
0.009 – 0.490	2400/F(kHz)	300
0.490 – 1.705	24000/F(kHz)	30
1.705 – 30.0	30	30
30 – 88	100	3
88 – 216	150	3
216 - 960	200	3
Above 960	500	3

Note: The following formula is used to convert the EIRP to field strength.

$$E = \frac{1000000\sqrt{30P}}{3} \mu\text{V/m, where P is the eirp (Watts)}$$

EIRP (dBm)	Field Strength at 3m (dBμV/m)
- 27	68.3



- (3) KDB789033 D02 v02r01 G)2)c)
 - (i) Section 15.407(b)(1) to (b)(3) specify the unwanted emission limits for the U-NII-1 and U-NII-2 bands. As specified, emissions above 1000 MHz that are outside of the restricted bands are subject to a peak emission limit of -27 dBm/MHz.³
 - (ii) Section 15.407(b)(4) specifies the unwanted emission limit for the U-NII-3 band. A band emissions mask is specified in Section 15.407(b)(4)(i). The emission limits are in terms of a Peak detector. An alternative to the band emissions mask is specified in Section 15.407(b)(4)(ii). The alternative limits are based on the highest antenna gain specified in the filing. There are also marketing and importation restrictions for the devices using the alternative limit.⁴

Note 3: An out-of-band emission that complies with both the average and peak limits of Section 15.209 is not required to satisfy the -27 dBm/MHz peak emission limit.

Note 4: Only devices with antenna gains of 10 dBi or less may be approved using the emission limits specified in Section 15.247(d) till March 2, 2018; all other devices operating in this band must use the mask specified in Section 15.407(b)(4)(i).

3.4.2 Measuring Instruments

See list of measuring equipment of this test report.

3.4.3 Test Procedures

1. The testing follows FCC KDB 789033 D02 General UNII Test Procedures New Rules v02r01. Section G) Unwanted emissions measurement.
 - (1) Procedure for Unwanted Emissions Measurements Below 1000MHz
 - RBW = 120 kHz
 - VBW = 300 kHz
 - Detector = Peak
 - Trace mode = max hold
 - (2) Procedure for Peak Unwanted Emissions Measurements Above 1000 MHz
 - RBW = 1 MHz
 - VBW ≥ 3 MHz
 - Detector = Peak
 - Sweep time = auto
 - Trace mode = max hold
 - (3) Procedures for Average Unwanted Emissions Measurements Above 1000MHz
 - RBW = 1 MHz
 - VBW = 10 Hz, when duty cycle is no less than 98 percent.
 - VBW ≥ 1/T, when duty cycle is less than 98 percent where T is the minimum transmission duration over which the transmitter is on and is transmitting at its maximum power control level for the tested mode of operation.

2. The EUT was placed on a turntable with 0.8 meter for frequency below 1GHz and 1.5 meter for frequency above 1GHz respectively above ground.
3. The EUT was set 3 meters from the interference receiving antenna which was mounted on the top of a variable height antenna tower.
4. The antenna is a broadband antenna and its height is adjusted between one meter and four meters above ground to find the maximum value of the field strength for both horizontal polarization and vertical polarization of the antenna.
5. For each suspected emission, the EUT was arranged to its worst case and then adjust the antenna tower (from 1 m to 4 m) and turntable (from 0 degree to 360 degrees) to find the maximum reading.
6. For testing below 1GHz, if the emission level of the EUT in peak mode was 3 dB lower than the limit specified, then peak values of EUT will be reported, otherwise, the emissions will be repeated one by one using the CISPR quasi-peak method and reported.
7. For testing above 1GHz, the emission level of the EUT in peak mode was 20dB lower than average limit (that means the emission level in average mode also complies with the limit in average mode), then peak values of EUT will be reported, otherwise, the emissions will be measured in average mode again and reported.

3.4.4 Test Setup

For radiated emissions below 30MHz

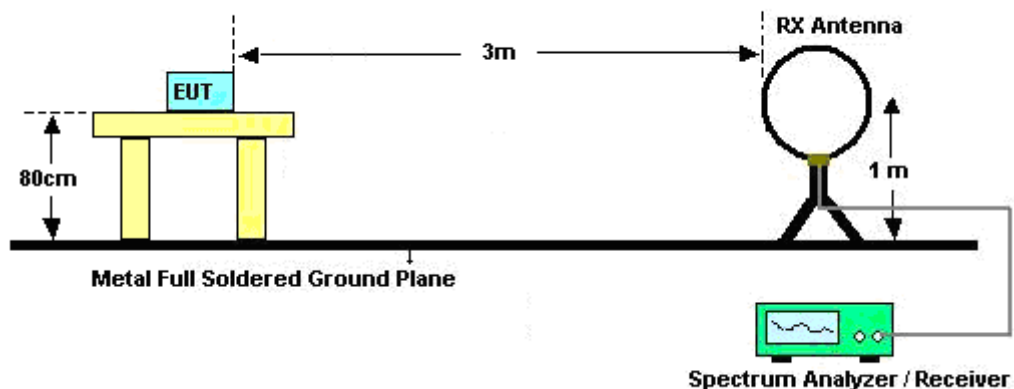

For radiated emissions from 30MHz to 1GHz

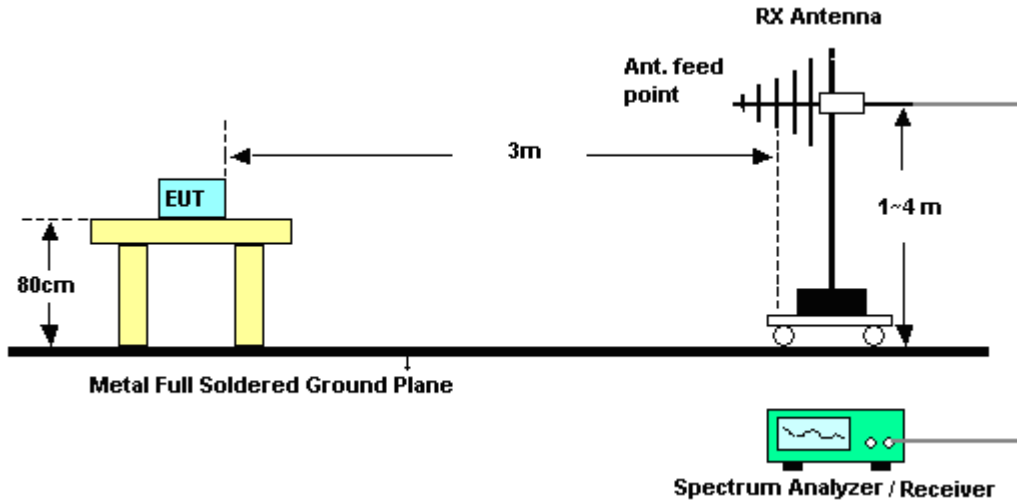

For radiated emissions above 1GHz

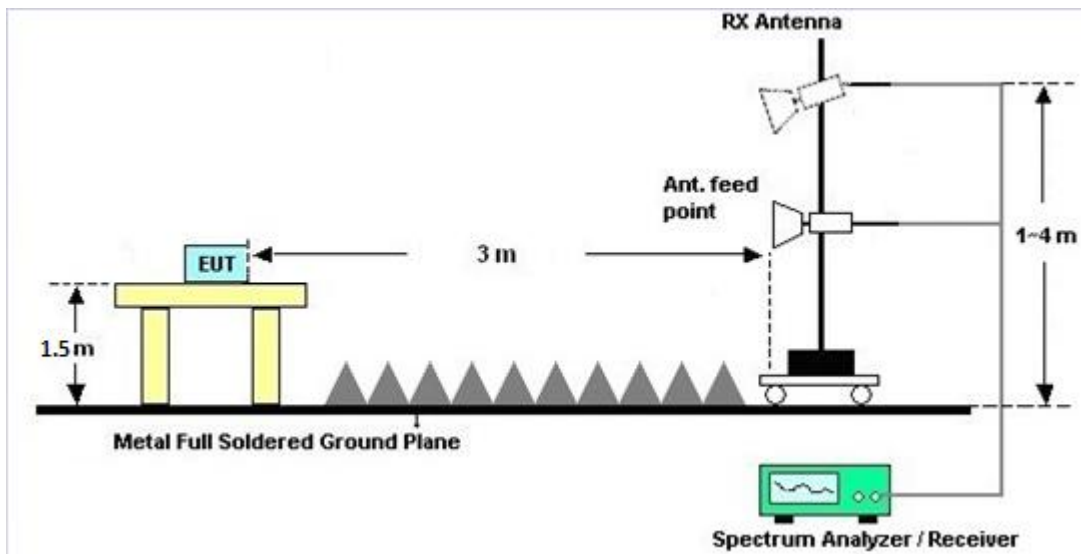



3.4.5 Test Results of Radiated Emissions (9 kHz ~ 30 MHz)

The low frequency, which started from 9 kHz to 30MHz, was pre-scanned and the result which was 20dB lower than the limit line was not reported.

There is a comparison data of both open-field test site and alternative test site - semi-Anechoic chamber according to 414788 D01 Radiated Test Site v01r01, and the result came out very similar.

3.4.6 Test Result of Radiated Band Edges

Please refer to Appendix C and D.

3.4.7 Duty Cycle

Please refer to Appendix E.

3.4.8 Test Result of Unwanted Radiated Emission (30MHz ~ 10th Harmonic)

Please refer to Appendix C and D.



3.5 AC Conducted Emission Measurement

3.5.1 Limit of AC Conducted Emission

For equipment that is designed to be connected to the public utility (AC) power line, the radio frequency voltage that is conducted back onto the AC power line on any frequency or frequencies within the band 150 kHz to 30 MHz shall not exceed the limits in the following table.

Frequency of emission (MHz)	Conducted limit (dBµV)	
	Quasi-peak	Average
0.15-0.5	66 to 56*	56 to 46*
0.5-5	56	46
5-30	60	50

*Decreases with the logarithm of the frequency.

3.5.2 Measuring Instruments

See list of measuring equipment of this test report.

3.5.3 Test Procedures

1. The EUT was placed 0.4 meter from the conducting wall of the shielding room was kept at least 80 centimeters from any other grounded conducting surface.
2. Connect EUT to the power mains through a line impedance stabilization network (LISN).
3. All the support units are connecting to the other LISN.
4. The LISN provides 50 ohm coupling impedance for the measuring instrument.
5. The FCC states that a 50 ohm, 50 microhenry LISN should be used.
6. Both sides of AC line were checked for maximum conducted interference.
7. The frequency range from 150 kHz to 30 MHz was searched.
8. Set the test-receiver system to Peak Detect Function and specified bandwidth with Maximum Hold Mode.

3.5.4 Test Setup

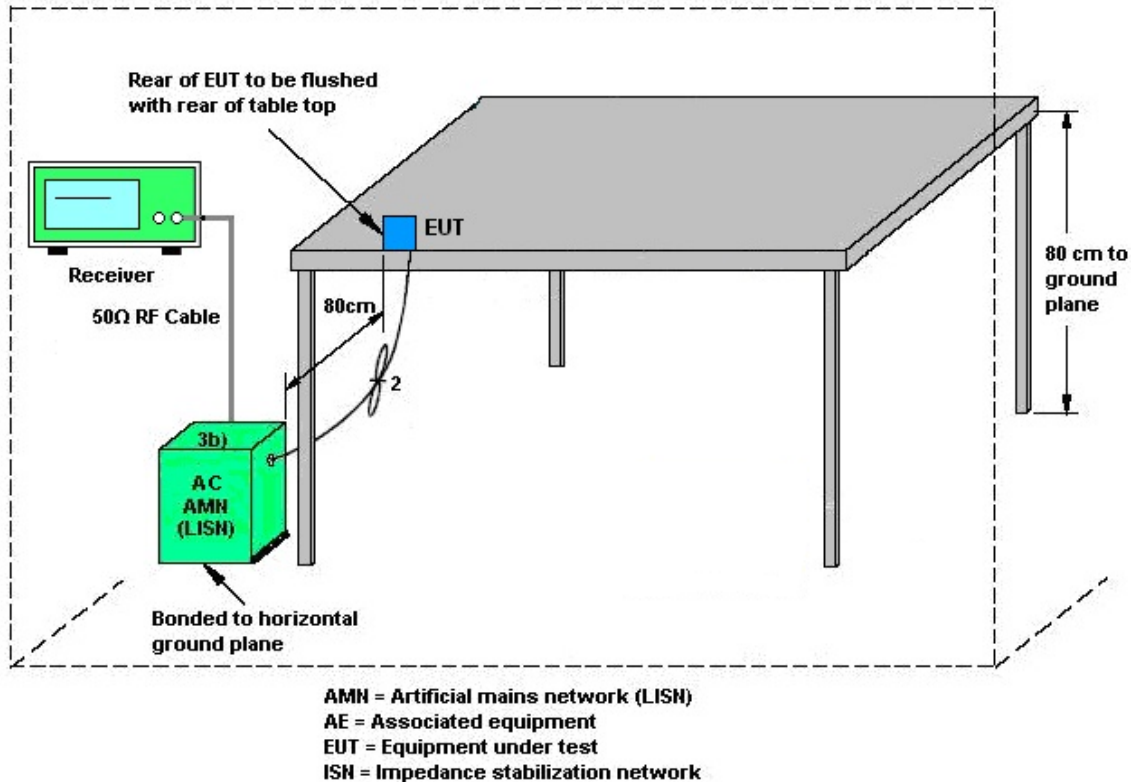

3.5.5 Test Result of AC Conducted Emission

Please refer to Appendix B.



3.6 Automatically Discontinue Transmission

3.6.1 Limit of Automatically Discontinue Transmission

The device shall automatically discontinue transmission in case of either absence of information to transmit or operational failure. These provisions are not intended to preclude the transmission of control or signaling information or the use of repetitive codes used by certain digital technologies to complete frame or burst intervals. Applicants shall include in their application for equipment authorization to describe how this requirement is met.

3.6.2 Measuring Instruments

See list of measuring equipment of this test report.

3.6.3 Test Result of Automatically Discontinue Transmission

While the EUT is not transmitting any information, the EUT can automatically discontinue transmission and become standby mode for power saving. The EUT can detect the controlling signal of ACK message transmitting from remote device and verify whether it shall resend or discontinue transmission.



3.7 Antenna Requirements

3.7.1 Standard Applicable

If transmitting antenna directional gain is greater than 6 dBi, both the peak transmit power and the peak power spectral density shall be reduced by the amount in dB that the directional gain of the antenna exceeds 6 dBi.

3.7.2 Antenna Anti-Replacement Construction

An embedded-in antenna design is used.

3.7.3 Antenna Gain

<CDD Modes >

FCC KDB 662911 D01 Multiple Transmitter Output v02r01

For CDD transmissions, directional gain is calculated as

Directional gain = GANT + Array Gain, where Array Gain is as follows.

For power spectral density (PSD) measurements on all devices,

Array Gain = 10 log(NANT/NSS=1) dB.

For power measurements on IEEE 802.11 devices,

Array Gain = 0 dB (i.e., no array gain) for NANT ≤ 4.

Directional gain may be calculated by using the formulas applicable to equal gain antennas with GANT set equal to the gain of the antenna having the highest gain;

The EUT supports CDD mode.

For power, the directional gain GANT is set equal to the antenna having the highest gain, i.e., F)2)f)i).

For PSD, the directional gain calculation is following F)2)f)ii) of KDB 662911 D01 v02r01.

The power and PSD limit should be modified if the directional gain of EUT is over 6 dBi,

The directional gain "DG" is calculated as following table.

<CDD Modes>						
			DG for Power (dBi)	DG for PSD (dBi)	Power Limit Reduction (dB)	PSD Limit Reduction (dB)
	Ant. 1 (dBi)	Ant. 2 (dBi)				
Band IV	2.50	1.75	5.14	5.14	0.00	0.00

Power Limit Reduction = DG(Power) – 6dBi, (min = 0)

PSD Limit Reduction = DG(PSD) – 6dBi, (min = 0)



4 List of Measuring Equipment

Instrument	Manufacturer	Model No.	Serial No.	Characteristics	Calibration Date	Test Date	Due Date	Remark
Loop Antenna	Rohde & Schwarz	HFH2-Z2	100488	9 kHz~30 MHz	Jan. 07, 2019	Apr. 08, 2019 ~ Apr. 11, 2019	Jan. 06, 2020	Radiation (03CH13-HY)
Horn Antenna	SCHWARZBECK	BBHA 9120 D	9120D-1241	1GHz ~ 18GHz	Jun. 29, 2018	Apr. 08, 2019 ~ Apr. 11, 2019	Jun. 28, 2019	Radiation (03CH13-HY)
Bilog Antenna	TESEQ	CBL 6111D&00800 N1D01N-06	37059&01	30MHz~1GHz	Oct. 13, 2018	Apr. 08, 2019 ~ Apr. 11, 2019	Oct. 12, 2019	Radiation (03CH13-HY)
SHF-EHF Horn Antenna	SCHWARZBECK	BBHA 9170	BBHA9170584	18GHz- 40GHz	Dec. 05, 2018	Apr. 08, 2019 ~ Apr. 11, 2019	Dec. 04, 2019	Radiation (03CH13-HY)
Preamplifier	Keysight	83017A	MY53270080	1GHz~26.5GHz	Nov. 14, 2018	Apr. 08, 2019 ~ Apr. 11, 2019	Nov. 13, 2020	Radiation (03CH13-HY)
Preamplifier	MITEQ	AMF-7D-0010 1800-30-10P	1590074	1GHz~18GHz	May 21, 2018	Apr. 08, 2019 ~ Apr. 11, 2019	May 20, 2019	Radiation (03CH13-HY)
Amplifier	Sonoma-Instrument	310 N	187282	9KHz~1GHz	Dec. 18, 2018	Apr. 08, 2019 ~ Apr. 11, 2019	Dec. 17, 2019	Radiation (03CH13-HY)
Amplifier	MITEQ	TTA1840-35-HG	1871923	18GHz~40GHz, VSWR : 2.5:1 max	Jul. 16, 2018	Apr. 08, 2019 ~ Apr. 11, 2019	Jul. 15, 2019	Radiation (03CH13-HY)
RF Cable	HUBER + SUHNER	SUCOFLEX 126E	0030/126E	30M-18G	Feb. 13, 2019	Apr. 08, 2019 ~ Apr. 11, 2019	Feb. 12, 2020	Radiation (03CH13-HY)
RF Cable	HUBER + SUHNER	SUCOFLEX 104	804793/4	30M-18G	Feb. 13, 2019	Apr. 08, 2019 ~ Apr. 11, 2019	Feb. 12, 2020	Radiation (03CH13-HY)
RF Cable	HUBER + SUHNER	SUCOFLEX 104	MY24961/4	30M-18G	Feb. 13, 2019	Apr. 08, 2019 ~ Apr. 11, 2019	Feb. 12, 2020	Radiation (03CH13-HY)
RF Cable	HUBER + SUHNER	SUCOFLEX 102	MY2859/2	30M~40GHz	Mar. 13, 2019	Apr. 08, 2019 ~ Apr. 11, 2019	Mar. 12, 2020	Radiation (03CH13-HY)
RF Cable	HUBER + SUHNER	SUCOFLEX 102	MY4274/2	30M~40GHz	Mar. 13, 2019	Apr. 08, 2019 ~ Apr. 11, 2019	Mar. 12, 2020	Radiation (03CH13-HY)
Spectrum Analyzer	Agilent	N9010A	MY55370526	10Hz~44GHz	Mar. 19, 2019	Apr. 08, 2019 ~ Apr. 11, 2019	Mar. 18, 2020	Radiation (03CH13-HY)
Antenna Mast	EMEC	AM-BS-4500-B	N/A	1m~4m	N/A	Apr. 08, 2019 ~ Apr. 11, 2019	N/A	Radiation (03CH13-HY)
Turn Table	EMEC	TT2000	N/A	0~360 Degree	N/A	Apr. 08, 2019 ~ Apr. 11, 2019	N/A	Radiation (03CH13-HY)
Software	AUDIX	E3 6.2009-8-24c	RK-001124	N/A	N/A	Apr. 08, 2019 ~ Apr. 11, 2019	N/A	Radiation (03CH13-HY)
EMI Test Receiver	Keysight	N9038A(MXE)	MY54130085	20Hz ~ 8.4GHz	Nov. 01, 2018	Apr. 08, 2019 ~ Apr. 11, 2019	Oct. 31, 2019	Radiation (03CH13-HY)
Filter	Woken	WHKX8-5272.5-6750-18000-40ST	SN5	6.75G Highpass	Mar.13, 2019	Apr. 08, 2019 ~ Apr. 11, 2019	Mar. 12, 2020	Radiation (03CH13-HY)
Filter	Wainwright	WHKX12-108 0-1200-15000-60ST	SN3	1.2G Low Pass	Jul. 05, 2018	Apr. 08, 2019 ~ Apr. 11, 2019	Jul. 04, 2019	Radiation (03CH13-HY)



Instrument	Manufacturer	Model No.	Serial No.	Characteristics	Calibration Date	Test Date	Due Date	Remark
Hygrometer	Testo	DTM-303A	TP157075	N/A	Nov. 05, 2018	May 03, 2019~ Jun. 14, 2019	Nov. 04, 2019	Conducted (TH05-HY)
Power Sensor	DARE	RPR3006W	13I00030S NO32	9kHz~6GHz	Dec. 03, 2018	May 03, 2019~ Jun. 14, 2019	Dec. 02, 2019	Conducted (TH05-HY)
Signal Analyzer	Rohde & Schwarz	FSV40	101397	10Hz~40GHz	Nov. 13, 2018	May 03, 2019~ Jun. 14, 2019	Nov. 12, 2019	Conducted (TH05-HY)
Switch Box & RF Cable	Burgeon	ETF-058	EC120838 2	N/A	Mar. 27, 2019	May 03, 2019~ Jun. 14, 2019	Mar. 26, 2020	Conducted (TH05-HY)
AC Power Source	ChainTek	APC-1000W	N/A	N/A	N/A	May 21, 2019	N/A	Conduction (CO05-HY)
EMI Test Receiver	Rohde & Schwarz	ESR3	102388	9KHz~3.6GHz	Nov. 12, 2018	May 21, 2019	Nov. 11, 2019	Conduction (CO05-HY)
Hygrometer	Testo	608-H1	34913912	N/A	Mar. 19, 2019	May 21, 2019	Mar. 18, 2020	Conduction (CO05-HY)
LISN	Rohde & Schwarz	ENV216	100080	9kHz~30MHz	Nov. 14, 2018	May 21, 2019	Nov. 13, 2019	Conduction (CO05-HY)
LISN	Rohde & Schwarz	ENV216	100081	9kHz~30MHz	Nov. 09, 2018	May 21, 2019	Nov. 08, 2019	Conduction (CO05-HY)
Software	Rohde & Schwarz	EMC32 V10.30	N/A	N/A	N/A	May 21, 2019	N/A	Conduction (CO05-HY)
LF Cable	HUBER + SUHNER	RG-214/U	LF01	N/A	Dec. 31, 2018	May 21, 2019	Dec. 30, 2019	Conduction (CO05-HY)
Pulse Limiter	Rohde & Schwarz	ESH3-Z2	100851	N/A	Dec. 31, 2018	May 21, 2019	Dec. 30, 2019	Conduction (CO05-HY)



5 Uncertainty of Evaluation

Uncertainty of Conducted Emission Measurement (150kHz ~ 30MHz)

Measuring Uncertainty for a Level of Confidence of 95% ($U = 2Uc(y)$)	2.2dB
---	-------

Uncertainty of Radiated Emission Measurement (30 MHz ~ 1000 MHz)

Measuring Uncertainty for a Level of Confidence of 95% ($U = 2Uc(y)$)	4.9dB
---	-------

Uncertainty of Radiated Emission Measurement (1000 MHz ~ 18000 MHz)

Measuring Uncertainty for a Level of Confidence of 95% ($U = 2Uc(y)$)	5.4dB
---	-------

Uncertainty of Radiated Emission Measurement (18000 MHz ~ 40000 MHz)

Measuring Uncertainty for a Level of Confidence of 95% ($U = 2Uc(y)$)	4.3dB
---	-------

Appendix A. Test Result of Conducted Test Items

Test Engineer:	Leo Li	Temperature:	21~25	°C
Test Date:	2019/5/3~2019/6/14	Relative Humidity:	51~54	%

TEST RESULTS DATA
6dB and 26dB EBW and 99% OBW

Band IV												
Mod.	Data Rate	NTX	CH.	Freq. (MHz)	99% Bandwidth (MHz)		26dB Bandwidth (MHz)		6 dB Bandwidth (MHz)		6 dB Bandwidth Min. Limit (MHz)	Pass/Fail
					Ant 1	Ant 2	Ant 1	Ant 2	Ant 1	Ant 2		
11a	6Mbps	2	149	5745	16.83	16.68	25.33	24.93	15.63	15.13	0.5	Pass
11a	6Mbps	2	157	5785	16.98	16.68	25.92	25.38	16.03	15.04	0.5	Pass
11a	6Mbps	2	165	5825	16.88	16.83	25.52	25.13	15.09	15.58	0.5	Pass
HT20	MCS0	2	149	5745	18.03	17.98	27.07	25.67	16.73	15.93	0.5	Pass
HT20	MCS0	2	157	5785	18.03	18.03	28.07	25.77	14.99	16.13	0.5	Pass
HT20	MCS0	2	165	5825	18.08	17.93	28.12	25.67	16.53	16.53	0.5	Pass
HT40	MCS0	2	151	5755	36.66	36.46	42.17	42.08	35.07	35.07	0.5	Pass
HT40	MCS0	2	159	5795	36.66	36.56	42.53	42.17	35.87	35.07	0.5	Pass
VHT80	MCS0	2	155	5775	76.24	76.12	85.03	83.76	75.12	75.12	0.5	Pass

TEST RESULTS DATA
Average Power Table

Band IV												
Mod.	Data Rate	NTX	CH.	Freq. (MHz)	Average Conducted Power (dBm)			FCC Conducted Power Limit (dBm)		DG (dBi)		Pass/Fail
					Ant 1	Ant 2	SUM	Ant 1	Ant 2	Ant 1	Ant 2	
11a	6Mbps	2	149	5745	19.20	18.90	22.06	30.00		2.50	Pass	
11a	6Mbps	2	157	5785	19.30	18.80	22.07	30.00		2.50	Pass	
11a	6Mbps	2	165	5825	19.00	18.40	21.72	30.00		2.50	Pass	
HT20	MCS0	2	149	5745	19.10	18.70	21.91	30.00		2.50	Pass	
HT20	MCS0	2	157	5785	19.10	18.60	21.87	30.00		2.50	Pass	
HT20	MCS0	2	165	5825	18.90	18.30	21.62	30.00		2.50	Pass	
HT40	MCS0	2	151	5755	19.50	19.20	22.36	30.00		2.50	Pass	
HT40	MCS0	2	159	5795	19.40	19.00	22.21	30.00		2.50	Pass	
VHT20	MCS0	2	149	5745	19.10	18.70	21.91	30.00		2.50	Pass	
VHT20	MCS0	2	157	5785	19.10	18.60	21.87	30.00		2.50	Pass	
VHT20	MCS0	2	165	5825	18.80	18.20	21.52	30.00		2.50	Pass	
VHT40	MCS0	2	151	5755	19.50	19.20	22.36	30.00		2.50	Pass	
VHT40	MCS0	2	159	5795	19.30	18.70	22.02	30.00		2.50	Pass	
VHT80	MCS0	2	155	5775	18.80	18.20	21.52	30.00		2.50	Pass	

TEST RESULTS DATA
Power Spectral Density

Band IV																
Mod.	Data Rate	NTX	CH.	Freq. (MHz)	Duty Factor (dB)		10log (500kHz /RBW) Factor (dB)		Average Power Density (dBm/500kHz)			Average PSD Limit (dBm/500kHz)		DG (dBi)		Pass /Fail
					Ant 1	Ant 2	Ant 1	Ant 2	Ant 1	Ant 2	SUM	Ant 1	Ant 2	Ant 1	Ant 2	
11a	6Mbps	2	149	5745	0.08	0.08	2.22	5.01	4.86	8.02	30.00	5.14	Pass			
11a	6Mbps	2	157	5785	0.08	0.08	2.22	5.16	5.03	8.17	30.00	5.14	Pass			
11a	6Mbps	2	165	5825	0.08	0.08	2.22	5.12	4.73	8.13	30.00	5.14	Pass			
HT20	MCS0	2	149	5745	0.09	0.09	2.22	4.60	4.77	7.78	30.00	5.14	Pass			
HT20	MCS0	2	157	5785	0.09	0.09	2.22	4.51	4.43	7.52	30.00	5.14	Pass			
HT20	MCS0	2	165	5825	0.09	0.09	2.22	4.35	4.29	7.36	30.00	5.14	Pass			
HT40	MCS0	2	151	5755	0.17	0.17	2.22	2.00	1.90	5.01	30.00	5.14	Pass			
HT40	MCS0	2	159	5795	0.17	0.17	2.22	1.90	1.62	4.91	30.00	5.14	Pass			
VHT80	MCS0	2	155	5775	0.20	0.20	2.22	-1.61	-1.78	1.40	30.00	5.14	Pass			

Note: PSD Sum = Max PSD(Ant. 1, Ant. 2) + 10 log (n)



Appendix B. AC Conducted Emission Test Results

Test Engineer :	Eric Jeng	Temperature :	22~25°C
		Relative Humidity :	52~55%
Test Voltage :	120Vac / 60Hz	Phase :	Line

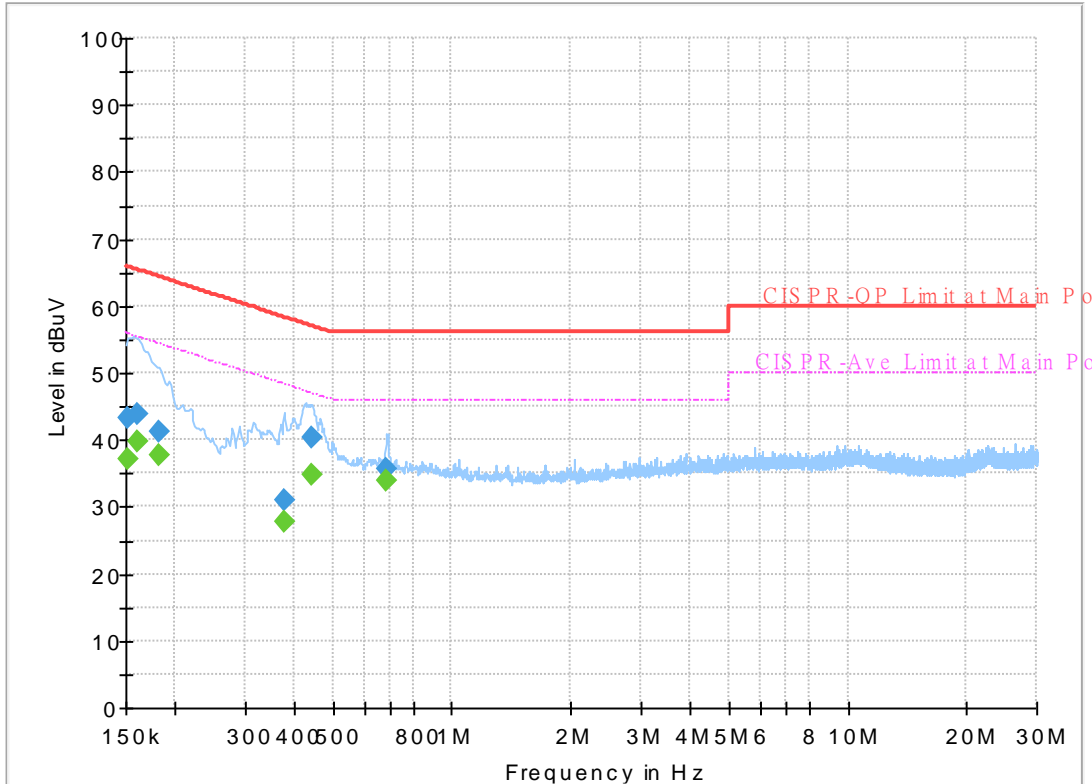

Final Result

Frequency	QuasiPeak	CAverage	Limit	Margin	Line	Filter	Corr.
0.152250	---	37.19	55.88	18.69	L1	OFF	19.5
0.152250	43.16	---	65.88	22.72	L1	OFF	19.5
0.161250	---	39.70	55.40	15.70	L1	OFF	19.5
0.161250	43.97	---	65.40	21.43	L1	OFF	19.5
0.181500	---	37.73	54.42	16.69	L1	OFF	19.5
0.181500	41.35	---	64.42	23.07	L1	OFF	19.5
0.377250	---	27.82	48.34	20.52	L1	OFF	19.5
0.377250	31.09	---	58.34	27.25	L1	OFF	19.5
0.442500	---	34.90	47.02	12.12	L1	OFF	19.5
0.442500	40.33	---	57.02	16.69	L1	OFF	19.5
0.683250	---	33.82	46.00	12.18	L1	OFF	19.6
0.683250	35.56	---	56.00	20.44	L1	OFF	19.6



Test Engineer :	Eric Jeng	Temperature :	22~25°C
		Relative Humidity :	52~55%
Test Voltage :	120Vac / 60Hz	Phase :	Neutral

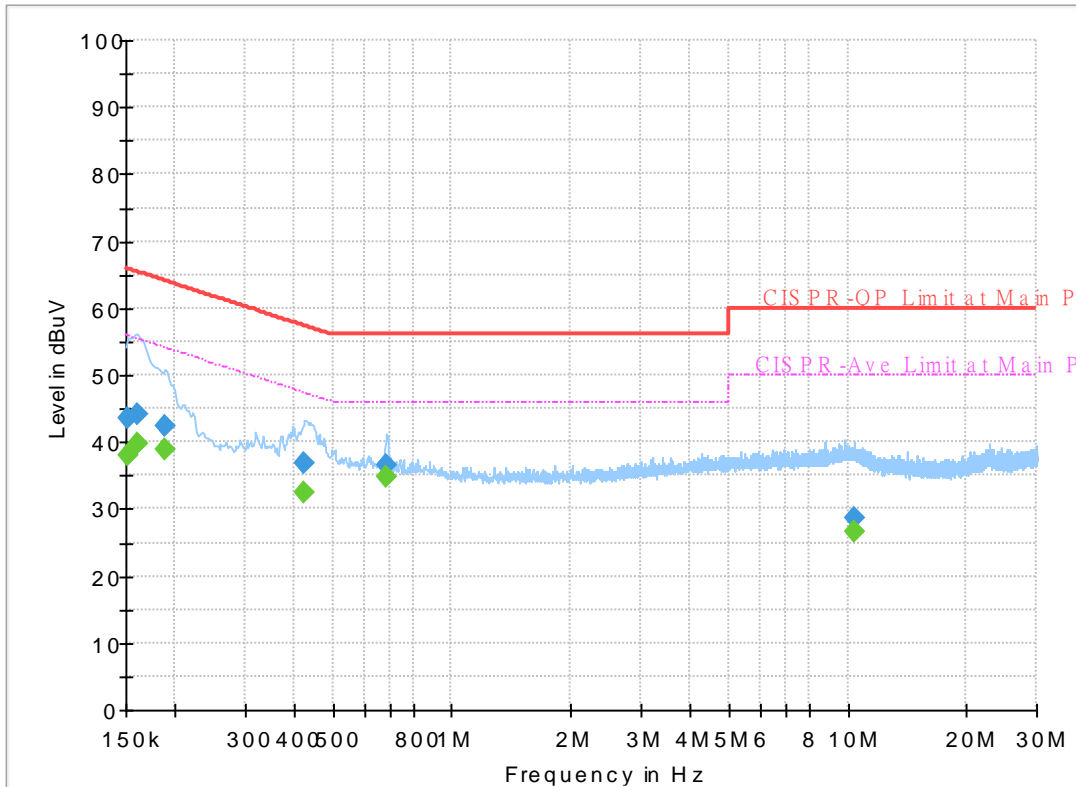

Final Result

Frequency	QuasiPeak	CAverage	Limit	Margin	Line	Filter	Corr.
0.152250	---	38.06	55.88	17.82	N	OFF	19.5
0.152250	43.47	---	65.88	22.41	N	OFF	19.5
0.161250	---	39.74	55.40	15.66	N	OFF	19.5
0.161250	44.05	---	65.40	21.35	N	OFF	19.5
0.188250	---	38.85	54.11	15.26	N	OFF	19.5
0.188250	42.31	---	64.11	21.80	N	OFF	19.5
0.424500	---	32.48	47.36	14.88	N	OFF	19.5
0.424500	36.75	---	57.36	20.61	N	OFF	19.5
0.685500	---	34.92	46.00	11.08	N	OFF	19.6
0.685500	36.59	---	56.00	19.41	N	OFF	19.6
10.367250	---	26.63	50.00	23.37	N	OFF	19.9
10.367250	28.58	---	60.00	31.42	N	OFF	19.9



Appendix C. Radiated Spurious Emission

Test Engineer :	Alex Jheng, JC Liang, Wilson Wu	Temperature :	20~24°C
		Relative Humidity :	50~55%

Band 4 - 5725~5850MHz

WIFI 802.11a (Band Edge @ 3m)

WIFI Ant.	Note	Frequency	Level	Over Limit	Limit Line	Read Level	Antenna Factor	Path Loss	Preamp Factor	Ant Pos	Table Pos	Peak Avg.	Pol.
1+2		(MHz)	(dBμV/m)	(dB)	(dBμV/m)	(dBμV)	(dB/m)	(dB)	(dB)	(cm)	(deg)	(P/A)	(H/V)
802.11a CH 149 5745MHz		5637.6	52.6	-15.6	68.2	43.72	32.09	6.34	29.55	106	47	P	H
		5699.2	56.08	-48.53	104.61	47.1	32.17	6.36	29.55	106	47	P	H
		5718.4	60.41	-49.94	110.35	51.38	32.21	6.37	29.55	106	47	P	H
		5724.6	71.3	-49.99	121.29	62.27	32.21	6.37	29.55	106	47	P	H
	*	5745	117.03	-	-	107.96	32.24	6.38	29.55	106	47	P	H
	*	5745	108.98	-	-	99.91	32.24	6.38	29.55	106	47	A	H
		5642	51.34	-16.86	68.2	42.46	32.09	6.34	29.55	293	355	P	V
		5682.8	54.07	-38.44	92.51	45.13	32.14	6.35	29.55	293	355	P	V
		5718.6	57.85	-52.56	110.41	48.82	32.21	6.37	29.55	293	355	P	V
		5724.2	72.09	-48.29	120.38	63.06	32.21	6.37	29.55	293	355	P	V
	*	5745	115.73	-	-	106.66	32.24	6.38	29.55	293	355	P	V
	*	5745	107.73	-	-	98.66	32.24	6.38	29.55	293	355	A	V



WIFI Ant. 1+2	Note	Frequency (MHz)	Level (dBµV/m)	Over Limit (dB)	Limit Line (dBµV/m)	Read Level (dBµV)	Antenna Factor (dB/m)	Path Loss (dB)	Preamp Factor (dB)	Ant Pos (cm)	Table Pos (deg)	Peak Avg. (P/A)	Pol. (H/V)
802.11a CH 157 5785MHz		5632.6	49.28	-18.92	68.2	40.41	32.09	6.33	29.55	109	47	P	H
		5690.6	51.66	-46.61	98.27	42.68	32.17	6.36	29.55	109	47	P	H
		5717.2	53.91	-56.11	110.02	44.9	32.19	6.37	29.55	109	47	P	H
		5724	54.43	-65.49	119.92	45.4	32.21	6.37	29.55	109	47	P	H
	*	5785	117.05	-	-	107.93	32.29	6.39	29.56	109	47	P	H
	*	5785	108.57	-	-	99.45	32.29	6.39	29.56	109	47	A	H
		5852	53.74	-63.9	117.64	44.48	32.38	6.44	29.56	109	47	P	H
		5866	53.19	-54.53	107.72	43.89	32.41	6.45	29.56	109	47	P	H
		5878.8	53.04	-49.34	102.38	43.71	32.43	6.46	29.56	109	47	P	H
		5932.2	50.14	-18.06	68.2	40.69	32.5	6.51	29.56	109	47	P	H
		5646.6	49.82	-18.38	68.2	40.94	32.09	6.34	29.55	289	356	P	V
		5696.8	51.05	-51.79	102.84	42.07	32.17	6.36	29.55	289	356	P	V
		5711.6	52.29	-56.16	108.45	43.29	32.19	6.36	29.55	289	356	P	V
		5724	52.61	-67.31	119.92	43.58	32.21	6.37	29.55	289	356	P	V
	*	5785	115.97	-	-	106.85	32.29	6.39	29.56	289	356	P	V
	*	5785	107.51	-	-	98.39	32.29	6.39	29.56	289	356	A	V
		5851	52.33	-67.59	119.92	43.07	32.38	6.44	29.56	289	356	P	V
		5855.4	52.76	-57.93	110.69	43.47	32.41	6.44	29.56	289	356	P	V
		5885.4	51.36	-46.12	97.48	42.02	32.43	6.47	29.56	289	356	P	V
		5933.6	50.49	-17.71	68.2	41.04	32.5	6.51	29.56	289	356	P	V



WIFI Ant. 1+2	Note	Frequency (MHz)	Level (dBµV/m)	Over Limit (dB)	Limit Line (dBµV/m)	Read Level (dBµV)	Antenna Factor (dB/m)	Path Loss (dB)	Preamp Factor (dB)	Ant Pos (cm)	Table Pos (deg)	Peak Avg. (P/A)	Pol. (H/V)
802.11a CH 165 5825MHz	*	5825	116	-	-	106.78	32.36	6.42	29.56	100	46	P	H
	*	5825	108.23	-	-	99.01	32.36	6.42	29.56	100	46	A	H
		5850.4	61.37	-59.92	121.29	52.11	32.38	6.44	29.56	100	46	P	H
		5857.2	57.87	-52.31	110.18	48.57	32.41	6.45	29.56	100	46	P	H
		5884.4	55.61	-42.61	98.22	46.27	32.43	6.47	29.56	100	46	P	H
		5933.8	52.51	-15.69	68.2	43.06	32.5	6.51	29.56	100	46	P	H
	*	5825	115.49	-	-	106.27	32.36	6.42	29.56	316	355	P	V
	*	5825	107.14	-	-	97.92	32.36	6.42	29.56	316	355	A	V
		5851	58.23	-61.69	119.92	48.97	32.38	6.44	29.56	316	355	P	V
		5855.2	57.34	-53.4	110.74	48.05	32.41	6.44	29.56	316	355	P	V
		5889	55.62	-39.19	94.81	46.25	32.46	6.47	29.56	316	355	P	V
		5938.2	51.7	-16.5	68.2	42.25	32.5	6.51	29.56	316	355	P	V
Remark	1. No other spurious found. 2. All results are PASS against Peak and Average limit line.												



Band 4 5725~5850MHz

WIFI 802.11a (Harmonic @ 3m)

WIFI Ant. 1+2	Note	Frequency (MHz)	Level (dBμV/m)	Over Limit (dB)	Limit Line (dBμV/m)	Read Level (dBμV)	Antenna Factor (dB/m)	Path Loss (dB)	Preamp Factor (dB)	Ant Pos (cm)	Table Pos (deg)	Peak Avg. (P/A)	Pol. (H/V)
802.11a CH 149 5745MHz		11490	46.86	-27.14	74	52.78	39.92	10.46	56.3	100	0	P	H
		17235	49.34	-18.86	68.2	52.12	40.84	12.95	56.57	100	0	P	H
		11490	48.06	-25.94	74	53.98	39.92	10.46	56.3	100	0	P	V
		17235	48.55	-19.65	68.2	51.33	40.84	12.95	56.57	100	0	P	V
802.11a CH 157 5785MHz		11570	46.22	-27.78	74	52.26	39.76	10.5	56.3	100	0	P	H
		17355	49.25	-18.95	68.2	51.72	41.26	13.08	56.81	100	0	P	H
		11570	47.2	-26.8	74	53.24	39.76	10.5	56.3	100	0	P	V
		17355	50.52	-17.68	68.2	52.99	41.26	13.08	56.81	100	0	P	V
802.11a CH 165 5825MHz		11650	46.93	-27.07	74	53.07	39.62	10.54	56.3	100	0	P	H
		17475	50.03	-18.17	68.2	52.19	41.68	13.21	57.05	100	0	P	H
		11650	47.97	-26.03	74	54.11	39.62	10.54	56.3	100	0	P	V
		17475	49.57	-18.63	68.2	51.73	41.68	13.21	57.05	100	0	P	V
Remark	1. No other spurious found. 2. All results are PASS against Peak and Average limit line.												



Band 4 5725~5850MHz
WIFI 802.11n HT20 (Band Edge @ 3m)

Table with 14 columns: WIFI Ant. 1+2, Note, Frequency (MHz), Level (dBµV/m), Over Limit (dB), Limit Line (dBµV/m), Read Level (dBµV), Antenna Factor (dB/m), Path Loss (dB), Preamp Factor (dB), Ant Pos (cm), Table Pos (deg), Peak Avg. (P/A), Pol. (H/V). Rows include frequencies from 5633.4 to 5745 MHz with various test parameters.



WIFI Ant. 1+2	Note	Frequency (MHz)	Level (dBµV/m)	Over Limit (dB)	Limit Line (dBµV/m)	Read Level (dBµV)	Antenna Factor (dB/m)	Path Loss (dB)	Preamp Factor (dB)	Ant Pos (cm)	Table Pos (deg)	Peak Avg. (P/A)	Pol. (H/V)
802.11n HT20 CH 157 5785MHz		5627.6	51.17	-17.03	68.2	42.32	32.07	6.33	29.55	105	20	P	H
		5694	51.25	-49.53	100.78	42.27	32.17	6.36	29.55	105	20	P	H
		5711.6	54.51	-53.94	108.45	45.51	32.19	6.36	29.55	105	20	P	H
		5722.2	53.4	-62.42	115.82	44.37	32.21	6.37	29.55	105	20	P	H
	*	5785	116.58	-	-	107.46	32.29	6.39	29.56	105	20	P	H
	*	5785	108.14	-	-	99.02	32.29	6.39	29.56	105	20	A	H
		5852.2	53.9	-63.28	117.18	44.64	32.38	6.44	29.56	105	20	P	H
		5858.4	54.47	-55.38	109.85	45.17	32.41	6.45	29.56	105	20	P	H
		5891.4	51.92	-41.11	93.03	42.55	32.46	6.47	29.56	105	20	P	H
		5929	50.96	-17.24	68.2	41.52	32.5	6.5	29.56	105	20	P	H
		5615.6	49.22	-18.98	68.2	40.37	32.07	6.33	29.55	307	351	P	V
		5693	49.79	-50.25	100.04	40.81	32.17	6.36	29.55	307	351	P	V
		5718.8	51.58	-58.88	110.46	42.55	32.21	6.37	29.55	307	351	P	V
		5721.2	51.74	-61.8	113.54	42.71	32.21	6.37	29.55	307	351	P	V
	*	5785	115.73	-	-	106.61	32.29	6.39	29.56	307	351	P	V
	*	5785	107.23	-	-	98.11	32.29	6.39	29.56	307	351	A	V
		5851.4	52.95	-66.06	119.01	43.69	32.38	6.44	29.56	307	351	P	V
		5857.4	52.01	-58.12	110.13	42.71	32.41	6.45	29.56	307	351	P	V
	5893.8	51.82	-39.43	91.25	42.44	32.46	6.48	29.56	307	351	P	V	
	5943.4	51.5	-16.7	68.2	42.02	32.53	6.51	29.56	307	351	P	V	



WIFI Ant. 1+2	Note	Frequency (MHz)	Level (dBμV/m)	Over Limit (dB)	Limit Line (dBμV/m)	Read Level (dBμV)	Antenna Factor (dB/m)	Path Loss (dB)	Preamp Factor (dB)	Ant Pos (cm)	Table Pos (deg)	Peak Avg. (P/A)	Pol. (H/V)
802.11n HT20 CH 165 5825MHz	*	5825	115.65	-	-	106.43	32.36	6.42	29.56	100	20	P	H
	*	5825	107.74	-	-	98.52	32.36	6.42	29.56	100	20	A	H
		5850.2	60.57	-61.17	121.74	51.31	32.38	6.44	29.56	100	20	P	H
		5862.6	56.91	-51.76	108.67	47.61	32.41	6.45	29.56	100	20	P	H
		5886	55.44	-41.59	97.03	46.1	32.43	6.47	29.56	100	20	P	H
		5930.6	51.27	-16.93	68.2	41.83	32.5	6.5	29.56	100	20	P	H
	*	5825	114.92	-	-	105.7	32.36	6.42	29.56	320	351	P	V
	*	5825	106.92	-	-	97.7	32.36	6.42	29.56	320	351	A	V
		5850.2	62.92	-58.82	121.74	53.66	32.38	6.44	29.56	320	351	P	V
		5855.4	56.44	-54.25	110.69	47.15	32.41	6.44	29.56	320	351	P	V
		5882.2	55.2	-44.65	99.85	45.86	32.43	6.47	29.56	320	351	P	V
		5932.4	51.77	-16.43	68.2	42.32	32.5	6.51	29.56	320	351	P	V
Remark	<ol style="list-style-type: none"> No other spurious found. All results are PASS against Peak and Average limit line. 												



**Band 4 5725~5850MHz
WIFI 802.11n HT20 (Harmonic @ 3m)**

WIFI Ant. 1+2	Note	Frequency (MHz)	Level (dBμV/m)	Over Limit (dB)	Limit Line (dBμV/m)	Read Level (dBμV)	Antenna Factor (dB/m)	Path Loss (dB)	Preamp Factor (dB)	Ant Pos (cm)	Table Pos (deg)	Peak Avg. (P/A)	Pol. (H/V)
802.11n HT20		11490	46.89	-27.11	74	52.81	39.92	10.46	56.3	100	0	P	H
		17235	48.85	-19.35	68.2	51.63	40.84	12.95	56.57	100	0	P	H
CH 149 5745MHz		11490	47.46	-26.54	74	53.38	39.92	10.46	56.3	100	0	P	V
		17235	49.51	-18.69	68.2	52.29	40.84	12.95	56.57	100	0	P	V
802.11n HT20 CH 157 5785MHz		11570	46.04	-27.96	74	52.08	39.76	10.5	56.3	100	0	P	H
		17355	49.63	-18.57	68.2	52.1	41.26	13.08	56.81	100	0	P	H
		11570	46.61	-27.39	74	52.65	39.76	10.5	56.3	100	0	P	V
		17355	49.57	-18.63	68.2	52.04	41.26	13.08	56.81	100	0	P	V
802.11n HT20 CH 165 5825MHz		11650	47.06	-26.94	74	53.2	39.62	10.54	56.3	100	0	P	H
		17475	51.9	-16.3	68.2	54.06	41.68	13.21	57.05	100	0	P	H
		11650	49.93	-24.07	74	56.07	39.62	10.54	56.3	100	0	P	V
		17475	50.65	-17.55	68.2	52.81	41.68	13.21	57.05	100	0	P	V
Remark	1. No other spurious found. 2. All results are PASS against Peak and Average limit line.												



Band 4 5725~5850MHz
WIFI 802.11n HT40 (Band Edge @ 3m)

WIFI Ant. 1+2	Note	Frequency (MHz)	Level (dBμV/m)	Over Limit (dB)	Limit Line (dBμV/m)	Read Level (dBμV)	Antenna Factor (dB/m)	Path Loss (dB)	Preamp Factor (dB)	Ant Pos (cm)	Table Pos (deg)	Peak Avg. (P/A)	Pol. (H/V)
802.11n HT40 CH 151 5755MHz		5621.6	51.22	-16.98	68.2	42.37	32.07	6.33	29.55	105	20	P	H
		5691	59.89	-38.67	98.56	50.91	32.17	6.36	29.55	105	20	P	H
		5716.6	75.88	-33.97	109.85	66.87	32.19	6.37	29.55	105	20	P	H
		5720.8	78.34	-34.28	112.62	69.31	32.21	6.37	29.55	105	20	P	H
	*	5755	114.04	-	-	104.96	32.26	6.38	29.56	105	20	P	H
	*	5755	106.53	-	-	97.45	32.26	6.38	29.56	105	20	A	H
		5850.8	53.03	-67.35	120.38	43.77	32.38	6.44	29.56	105	20	P	H
		5855.4	53.48	-57.21	110.69	44.19	32.41	6.44	29.56	105	20	P	H
		5895.4	52.12	-37.95	90.07	42.74	32.46	6.48	29.56	105	20	P	H
		5936	50.58	-17.62	68.2	41.13	32.5	6.51	29.56	105	20	P	H
		5648.6	51.01	-17.19	68.2	42.13	32.09	6.34	29.55	326	351	P	V
		5697.6	58.56	-44.87	103.43	49.58	32.17	6.36	29.55	326	351	P	V
		5719	77.06	-33.46	110.52	68.03	32.21	6.37	29.55	326	351	P	V
		5723.6	73.25	-45.76	119.01	64.22	32.21	6.37	29.55	326	351	P	V
	*	5755	112.69	-	-	103.61	32.26	6.38	29.56	326	351	P	V
	*	5755	105.53	-	-	96.45	32.26	6.38	29.56	326	351	A	V
		5851.2	52.1	-67.36	119.46	42.84	32.38	6.44	29.56	326	351	P	V
		5861.8	51.68	-57.21	108.89	42.38	32.41	6.45	29.56	326	351	P	V
		5876	51.45	-53.01	104.46	42.12	32.43	6.46	29.56	326	351	P	V
		5937.6	50.29	-17.91	68.2	40.84	32.5	6.51	29.56	326	351	P	V



WIFI Ant. 1+2	Note	Frequency (MHz)	Level (dBµV/m)	Over Limit (dB)	Limit Line (dBµV/m)	Read Level (dBµV)	Antenna Factor (dB/m)	Path Loss (dB)	Preamp Factor (dB)	Ant Pos (cm)	Table Pos (deg)	Peak Avg. (P/A)	Pol. (H/V)
802.11n HT40 CH 159 5795MHz		5642	50.1	-18.1	68.2	41.22	32.09	6.34	29.55	100	19	P	H
		5690	52.59	-45.24	97.83	43.61	32.17	6.36	29.55	100	19	P	H
		5715.4	55.56	-53.95	109.51	46.55	32.19	6.37	29.55	100	19	P	H
		5723	56.01	-61.63	117.64	46.98	32.21	6.37	29.55	100	19	P	H
	*	5795	113.15	-	-	104	32.31	6.4	29.56	100	19	P	H
	*	5795	106.23	-	-	97.08	32.31	6.4	29.56	100	19	A	H
		5853.4	59.5	-54.95	114.45	50.24	32.38	6.44	29.56	100	19	P	H
		5855.4	58.48	-52.21	110.69	49.19	32.41	6.44	29.56	100	19	P	H
		5879	55.09	-47.14	102.23	45.76	32.43	6.46	29.56	100	19	P	H
		5926.4	51.74	-16.46	68.2	42.3	32.5	6.5	29.56	100	19	P	H
		5618	50.19	-18.01	68.2	41.34	32.07	6.33	29.55	307	353	P	V
		5698.8	51.24	-53.08	104.32	42.26	32.17	6.36	29.55	307	353	P	V
		5707.4	54.37	-52.9	107.27	45.37	32.19	6.36	29.55	307	353	P	V
		5724.8	55.02	-66.72	121.74	45.99	32.21	6.37	29.55	307	353	P	V
	*	5795	112.5	-	-	103.35	32.31	6.4	29.56	307	353	P	V
	*	5795	105.32	-	-	96.17	32.31	6.4	29.56	307	353	A	V
		5850.6	59.33	-61.5	120.83	50.07	32.38	6.44	29.56	307	353	P	V
		5855.2	56.23	-54.51	110.74	46.94	32.41	6.44	29.56	307	353	P	V
	5875.6	54.74	-50.01	104.75	45.41	32.43	6.46	29.56	307	353	P	V	
	5928.2	52.41	-15.79	68.2	42.97	32.5	6.5	29.56	307	353	P	V	
Remark	1. No other spurious found. 2. All results are PASS against Peak and Average limit line.												



**Band 4 5725~5850MHz
WIFI 802.11n HT40 (Harmonic @ 3m)**

WIFI Ant. 1+2	Note	Frequency (MHz)	Level (dBμV/m)	Over Limit (dB)	Limit Line (dBμV/m)	Read Level (dBμV)	Antenna Factor (dB/m)	Path Loss (dB)	Preamp Factor (dB)	Ant Pos (cm)	Table Pos (deg)	Peak Avg. (P/A)	Pol. (H/V)
802.11n HT40 CH 151 5755MHz		5980	57.21	-10.99	68.2	47.65	32.58	6.54	29.56	105	20	P	H
		11510	46.27	-27.73	74	52.2	39.9	10.47	56.3	100	0	P	H
		17265	48.44	-19.76	68.2	51.13	40.96	12.98	56.63	100	0	P	H
		5980	56.51	-11.69	68.2	46.95	32.58	6.54	29.56	326	351	P	V
		11510	46.43	-27.57	74	52.36	39.9	10.47	56.3	100	0	P	V
		17265	48.75	-19.45	68.2	51.44	40.96	12.98	56.63	100	0	P	V
802.11n HT40 CH 159 5795MHz		6016	58.71	-9.49	68.2	49.06	32.66	6.56	29.57	100	19	P	H
		11590	45.76	-28.24	74	51.82	39.73	10.51	56.3	100	0	P	H
		17385	49.29	-18.91	68.2	51.67	41.38	13.11	56.87	100	0	P	H
		6016	58.15	-10.05	68.2	48.5	32.66	6.56	29.57	307	353	P	V
		11590	46.12	-27.88	74	52.18	39.73	10.51	56.3	100	0	P	V
		17385	49.35	-18.85	68.2	51.73	41.38	13.11	56.87	100	0	P	V
Remark	1. No other spurious found. 2. All results are PASS against Peak and Average limit line.												



Band 4 5725~5850MHz
WIFI 802.11ac VHT80 (Band Edge @ 3m)

WIFI Ant. 1+2	Note	Frequency (MHz)	Level (dBμV/m)	Over Limit (dB)	Limit Line (dBμV/m)	Read Level (dBμV)	Antenna Factor (dB/m)	Path Loss (dB)	Preamp Factor (dB)	Ant Pos (cm)	Table Pos (deg)	Peak Avg. (P/A)	Pol. (H/V)
802.11ac VHT80 CH 155 5775MHz		5649.6	60.13	-8.07	68.2	51.22	32.12	6.34	29.55	100	47	P	H
		5692	71.42	-27.88	99.3	62.44	32.17	6.36	29.55	100	47	P	H
		5719	75.77	-34.75	110.52	66.74	32.21	6.37	29.55	100	47	P	H
		5723.2	75.84	-42.26	118.1	66.81	32.21	6.37	29.55	100	47	P	H
	*	5775	111.05	-	-	101.93	32.29	6.39	29.56	100	47	P	H
	*	5775	103.83	-	-	94.71	32.29	6.39	29.56	100	47	A	H
		5852.4	74.05	-42.68	116.73	64.79	32.38	6.44	29.56	100	47	P	H
		5865.8	71.01	-36.76	107.77	61.71	32.41	6.45	29.56	100	47	P	H
		5877.8	63.39	-39.73	103.12	54.06	32.43	6.46	29.56	100	47	P	H
		5936.2	51.83	-16.37	68.2	42.38	32.5	6.51	29.56	100	47	P	H
		5646.4	56.39	-11.81	68.2	47.51	32.09	6.34	29.55	321	357	P	V
		5698.8	67.06	-37.26	104.32	58.08	32.17	6.36	29.55	321	357	P	V
		5710	70.86	-37.14	108	61.86	32.19	6.36	29.55	321	357	P	V
		5723.4	71.98	-46.57	118.55	62.95	32.21	6.37	29.55	321	357	P	V
	*	5775	110.06	-	-	100.94	32.29	6.39	29.56	321	357	P	V
	*	5775	102.35	-	-	93.23	32.29	6.39	29.56	321	357	A	V
		5850.2	75.55	-46.19	121.74	66.29	32.38	6.44	29.56	321	357	P	V
		5868.8	69.04	-37.89	106.93	59.73	32.41	6.46	29.56	321	357	P	V
		5879	59.33	-42.9	102.23	50	32.43	6.46	29.56	321	357	P	V
		5941.6	51.05	-17.15	68.2	41.57	32.53	6.51	29.56	321	357	P	V

Remark

- No other spurious found.
- All results are PASS against Peak and Average limit line.



Band 4 5725~5850MHz

WIFI 802.11ac VHT80 (Harmonic @ 3m)

WIFI Ant. 1+2	Note	Frequency (MHz)	Level (dBμV/m)	Over Limit (dB)	Limit Line (dBμV/m)	Read Level (dBμV)	Antenna Factor (dB/m)	Path Loss (dB)	Preamp Factor (dB)	Ant Pos (cm)	Table Pos (deg)	Peak Avg. (P/A)	Pol. (H/V)
802.11ac		11550	46.42	-27.58	74	52.43	39.8	10.49	56.3	100	0	P	H
VHT80		17325	49.54	-18.66	68.2	52.11	41.14	13.04	56.75	100	0	P	H
CH 155		11550	46.4	-27.6	74	52.41	39.8	10.49	56.3	100	0	P	V
5775MHz		17325	49.48	-18.72	68.2	52.05	41.14	13.04	56.75	100	0	P	V
Remark	1. No other spurious found. 2. All results are PASS against Peak and Average limit line.												



Emission below 1GHz

5GHz WIFI 802.11ac VHT80 (LF @ 3m)

WIFI	Note	Frequency	Level	Over	Limit	Read	Antenna	Path	Preamp	Ant	Table	Peak	Pol.
Ant.				Limit	Line	Level	Factor	Loss	Factor	Pos	Pos	Avg.	
1+2		(MHz)	(dBμV/m)	(dB)	(dBμV/m)	(dBμV)	(dB/m)	(dB)	(dB)	(cm)	(deg)	(P/A)	(H/V)
5GHz 802.11ac VHT80 LF		41.64	22.8	-17.2	40	36.17	18.4	0.48	32.29	-	-	P	H
		118.27	31.79	-11.71	43.5	45.76	17.29	0.87	32.2	-	-	P	H
		135.73	26.04	-17.46	43.5	39.84	17.37	0.93	32.18	-	-	P	H
		174.53	23.84	-19.66	43.5	39.49	15.36	1.04	32.16	-	-	P	H
		320.03	27	-19	46	38.23	19.43	1.4	32.15	-	-	P	H
		898.15	37.04	-8.96	46	36.85	29	2.44	31.42	100	0	P	H
		42.61	31.92	-8.08	40	45.77	17.92	0.49	32.29	-	-	P	V
		61.04	27.43	-12.57	40	47.32	11.78	0.58	32.27	-	-	P	V
		442.25	27.19	-18.81	46	34.55	23.03	1.69	32.16	-	-	P	V
		595.51	28.47	-17.53	46	33.22	25.38	2.01	32.24	-	-	P	V
		897.18	39.43	-6.57	46	39.23	29.01	2.44	31.42	100	0	P	V
	955.38	33.85	-12.15	46	31.41	30.71	2.46	30.94			P	V	
Remark	<ol style="list-style-type: none"> No other spurious found. All results are PASS against limit line. 												



Note symbol

*	Fundamental Frequency which can be ignored. However, the level of any unwanted emissions shall not exceed the level of the fundamental frequency.
!	Test result is over limit line.
P/A	Peak or Average
H/V	Horizontal or Vertical



A calculation example for radiated spurious emission is shown as below:

WIFI	Note	Frequency	Level	Over	Limit	Read	Antenna	Path	Preamp	Ant	Table	Peak	Pol.
Ant.				Limit	Line	Level	Factor	Loss	Factor	Pos	Pos	Avg.	
1+2		(MHz)	(dBμV/m)	(dB)	(dBμV/m)	(dBμV)	(dB/m)	(dB)	(dB)	(cm)	(deg)	(P/A)	(H/V)
802.11b		2390	55.45	-18.55	74	54.51	32.22	4.58	35.86	103	308	P	H
CH 01													
2412MHz		2390	43.54	-10.46	54	42.6	32.22	4.58	35.86	103	308	A	H

1. Path Loss(dB) = Cable loss(dB) + Filter loss(dB) + Attenuator loss(dB)
2. Level(dBμV/m) = Antenna Factor(dB/m) + Path Loss(dB) + Read Level(dBμV) - Preamp Factor(dB)
3. Over Limit(dB) = Level(dBμV/m) – Limit Line(dBμV/m)

For Peak Limit @ 2390MHz:

1. Level(dBμV/m)
= Antenna Factor(dB/m) + Path Loss(dB) + Read Level(dBμV) - Preamp Factor(dB)
= 32.22(dB/m) + 4.58(dB) + 54.51(dBμV) – 35.86 (dB)
= 55.45 (dBμV/m)
2. Over Limit(dB)
= Level(dBμV/m) – Limit Line(dBμV/m)
= 55.45(dBμV/m) – 74(dBμV/m)
= -18.55(dB)

For Average Limit @ 2390MHz:

1. Level(dBμV/m)
= Antenna Factor(dB/m) + Path Loss(dB) + Read Level(dBμV) - Preamp Factor(dB)
= 32.22(dB/m) + 4.58(dB) + 42.6(dBμV) – 35.86 (dB)
= 43.54 (dBμV/m)
2. Over Limit(dB) = Level(dBμV/m) – Limit Line(dBμV/m)
= 43.54(dBμV/m) – 54(dBμV/m)
= -10.46(dB)

Both peak and average measured complies with the limit line, so test result is “PASS”.



Appendix D. Radiated Spurious Emission Plots

Test Engineer :	Alex Jheng, JC Liang, Wilson Wu	Temperature :	20~24°C
		Relative Humidity :	50~55%

Band 4 - 5725~5850MHz
WIFI 802.11a (Band Edge @ 3m)

WIFI	Band 4 5725~5850MHz Band Edge @ 3m	
ANT	802.11a CH149 5745MHz	
1+2	Horizontal	Fundamental
Peak	<p>Site : 03CH13-1HY Condition : PEAK_BE(84)_16-24 3m HORN_91200_1241 HORIZONTAL Detector : RBW:1000.000KHz VBW:3000.000KHz SWT:Auto Detector : Peak Project : 932216 Mode : 34</p>	<p>Site : 03CH13-1HY Condition : PEAK(UNIT) 3m HORN_91200_1241 HORIZONTAL Detector : RBW:1000.000KHz VBW:3000.000KHz SWT:Auto Detector : Peak Project : 932216 Mode : 34</p>



WIFI	Band 4 5725~5850MHz Band Edge @ 3m	
ANT	802.11a CH149 5745MHz	
1+2	Vertical	Fundamental
Peak	<p>Site : 03CH13-HY Condition : PEAK_BE(84)_16-24 3m HORN_91200_1241 VERTICAL Detector : Peak Project : 932216 Mode : 34</p>	<p>Site : 03CH13-HY Condition : PEAK(UNII) 3m HORN_91200_1241 VERTICAL Detector : Peak Project : 932216 Mode : 34</p>



WIFI	Band 4 5725~5850MHz Band Edge @ 3m	
ANT	802.11a CH157 5785MHz	
1+2	Horizontal	Fundamental
<p>Peak</p>	<p>Site : 03CH13-HY Condition : PEAK_BE(B4)_16-24 3m HORN_91200_1241 HORIZONTAL Detector : Peak Project : 932216 Mode : 35</p>	<p>Site : 03CH13-HY Condition : PEAK(UNII) 3m HORN_91200_1241 HORIZONTAL Detector : Peak Project : 932216 Mode : 35</p>
<p>Peak</p>	<p>Site : 03CH13-HY Condition : PEAK_BE(B4)_16-24 3m HORN_91200_1241 HORIZONTAL Detector : Peak Project : 932216 Mode : 35</p>	<p>Left blank</p>



WIFI	Band 4 5725~5850MHz Band Edge @ 3m	
ANT	802.11a CH157 5785MHz	
1+2	Vertical	Fundamental
Peak	<p>Site : 03CH13-HY Condition : PEAK_BE(B4)_16-24 3m HORN_91200_1241 VERTICAL Detector : Peak Project : 932216 Mode : 35</p>	<p>Site : 03CH13-HY Condition : PEAK(UNII) 3m HORN_91200_1241 VERTICAL Detector : Peak Project : 932216 Mode : 35</p>
Peak	<p>Site : 03CH13-HY Condition : PEAK_BE(B4)_16-24 3m HORN_91200_1241 VERTICAL Detector : Peak Project : 932216 Mode : 35</p>	Left blank

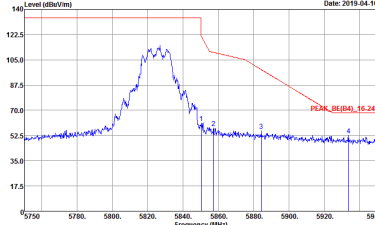
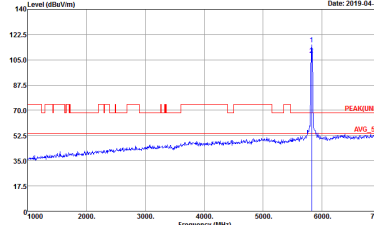

WIFI	Band 4 5725~5850MHz Band Edge @ 3m	
ANT	802.11a CH165 5825MHz	
1+2	Horizontal	Fundamental
Peak	 <p>Site : 03CH12-HY Condition : PEAK_BE(B4)_16-24 3m HORN_91200_1241 HORIZONTAL RBW:1000.000KHz VBW:3000.000KHz SWT:Auto Detector : Peak Project : 932216 Mode : 36</p>	 <p>Site : 03CH12-HY Condition : PEAK(UNII) 3m HORN_91200_1241 HORIZONTAL RBW:1000.000KHz VBW:3000.000KHz SWT:Auto Detector : Peak Project : 932216 Mode : 36</p>

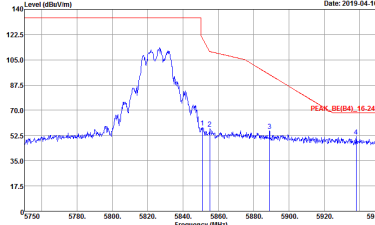
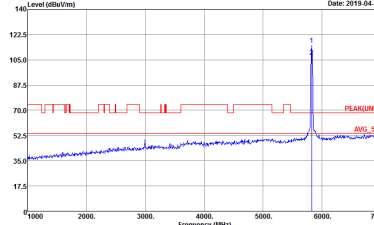

WIFI	Band 4 5725~5850MHz Band Edge @ 3m	
ANT	802.11a CH165 5825MHz	
1+2	Vertical	Fundamental
Peak	 <p>Site : 03CH13-HY Condition : PEAK_BE(B4)_16-24 3m HORN_91200_1241 VERTICAL RBW:1000.000KHz VBW:3000.000KHz SWT:Auto Detector : Peak Project : 932216 Mode : 36</p>	 <p>Site : 03CH13-HY Condition : PEAK(UNII) 3m HORN_91200_1241 VERTICAL RBW:1000.000KHz VBW:3000.000KHz SWT:Auto Detector : Peak Project : 932216 Mode : 36</p>



Band 4 5725~5850MHz
WIFI 802.11n HT20 (Band Edge @ 3m)

WIFI	Band 4 5725~5850MHz Band Edge @ 3m	
ANT	802.11n HT20 CH149 5745MHz	
1+2	Horizontal	Fundamental
Peak	<p>Date: 2019-04-10 PEAK_BE(B4)_16-24</p> <p>Site : 03CH13-HY Condition : PEAK_BE(B4)_16-24 3m HORN_01200_1241 HORIZONTAL Detector : RBW:3000.000KHz VSW:3000.000KHz SWT:Auto Project : 932216 Mode : 37</p>	<p>Date: 2019-04-10 PEAK(UMB) AVG_54</p> <p>Site : 03CH13-HY Condition : PEAK(UMB) 3m HORN_01200_1241 HORIZONTAL Detector : RBW:3000.000KHz VSW:3000.000KHz SWT:Auto Project : 932216 Mode : 37</p>

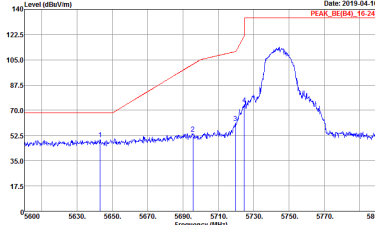
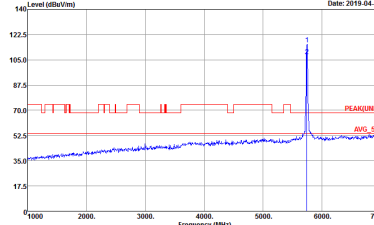

WIFI	Band 4 5725~5850MHz Band Edge @ 3m	
ANT	802.11n HT20 CH149 5745MHz	
1+2	Vertical	Fundamental
Peak	 <p>Date: 2019-04-10 PEAK: 86.045, 15.20</p> <p>Site : 03CH13-HY Condition : PEAK_8E(84)_16-24 3m HORN_91200_1241 VERTICAL RBW:1000.000KHz VBW:3000.000KHz SWT:Auto Detector : Peak Project : 932216 Mode : 37</p>	 <p>Date: 2019-04-10 PEAK: 86.045, 15.20</p> <p>Site : 03CH13-HY Condition : PEAK(UNII) 3m HORN_91200_1241 VERTICAL RBW:1000.000KHz VBW:3000.000KHz SWT:Auto Detector : Peak Project : 932216 Mode : 37</p>



WIFI	Band 4 5725~5850MHz Band Edge @ 3m	
ANT	802.11n HT20 CH157 5785MHz	
1+2	Horizontal	Fundamental
<p>Peak</p>	<p>Date: 2019-04-10 PEAK_BE(B4)_15-24</p> <p>Site : 03CH13-HY Condition : PEAK_BE(B4)_16-24 3m HORN_91200_1241 HORIZONTAL RBW:1000.000KHz VBW:3000.000KHz SWT:Auto Detector : Peak Project : 932216 Mode : 38</p>	<p>Date: 2019-04-10 PEAK(BB)</p> <p>Site : 03CH13-HY Condition : PEAK(UNII) 3m HORN_91200_1241 HORIZONTAL RBW:1000.000KHz VBW:3000.000KHz SWT:Auto Detector : Peak Project : 932216 Mode : 38</p>
<p>Peak</p>	<p>Date: 2019-04-10 PEAK_BE(B4)_16-24</p> <p>Site : 03CH13-HY Condition : PEAK_BE(B4)_16-24 3m HORN_91200_1241 HORIZONTAL RBW:1000.000KHz VBW:3000.000KHz SWT:Auto Detector : Peak Project : 932216 Mode : 38</p>	<p>Left blank</p>



WIFI	Band 4 5725~5850MHz Band Edge @ 3m	
ANT	802.11n HT20 CH157 5785MHz	
1+2	Vertical	Fundamental
Peak	<p>Site : 03CH13-HY Condition : PEAK_BE(B4)_16-24 3m HORN_91200_1241 VERTICAL Detector : Peak Project : 932216 Mode : 38</p>	<p>Site : 03CH13-HY Condition : PEAK(UNII) 3m HORN_91200_1241 VERTICAL Detector : Peak Project : 932216 Mode : 38</p>
Peak	<p>Site : 03CH13-HY Condition : PEAK_BE(B4)_16-24 3m HORN_91200_1241 VERTICAL Detector : Peak Project : 932216 Mode : 38</p>	Left blank

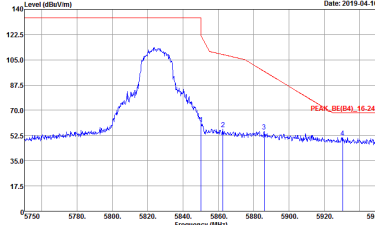
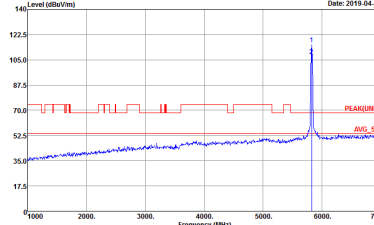

WIFI	Band 4 5725~5850MHz Band Edge @ 3m	
ANT	802.11n HT20 CH165 5825MHz	
1+2	Horizontal	Fundamental
Peak	 <p>Site : 03CH13-HY Condition : PEAK_BE(B4)_16-24 3m HORN_91200_1241 HORIZONTAL RBW:1000.000KHz VBW:3000.000KHz SWT:Auto Detector : Peak Project : 932216 Mode : 39</p>	 <p>Site : 03CH13-HY Condition : PEAK(UNII) 3m HORN_91200_1241 HORIZONTAL RBW:1000.000KHz VBW:3000.000KHz SWT:Auto Detector : Peak Project : 932216 Mode : 39</p>

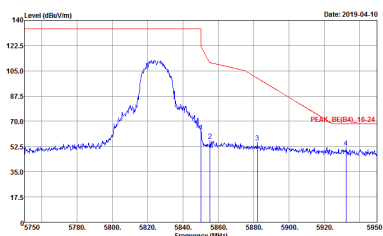
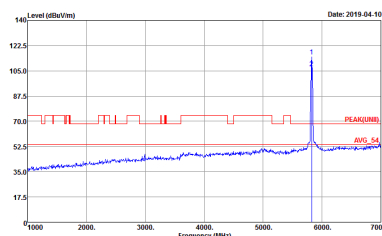

WIFI	Band 4 5725~5850MHz Band Edge @ 3m	
ANT	802.11n HT20 CH165 5825MHz	
1+2	Vertical	Fundamental
Peak	 <p> Site : 03CH12-HY Condition : PEAK_BE(B4)_16-24 3m HORN_91200_1241 VERTICAL Detector : Peak Project : 932216 Mode : 39 </p>	 <p> Site : 03CH12-HY Condition : PEAK(UNII) 3m HORN_91200_1241 VERTICAL Detector : Peak Project : 932216 Mode : 39 </p>



Band 4 5725~5850MHz
WIFI 802.11n HT40 (Band Edge @ 3m)

Table with 2 columns (WIFI, ANT) and 2 rows (1+2, Peak). The table contains spectral analysis plots for Horizontal and Fundamental signals, and a Left blank plot. Each plot includes a graph of Level (dBuV/m) vs Frequency (MHz) and associated test parameters like Site, Condition, Detector, Project, and Mode.



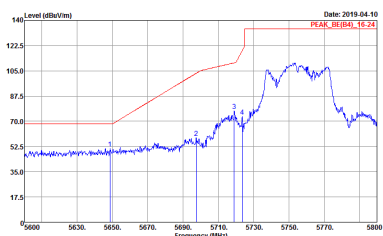
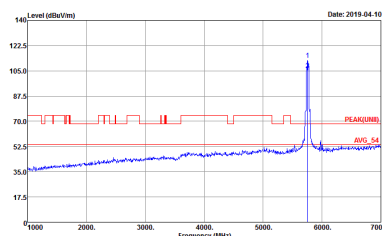
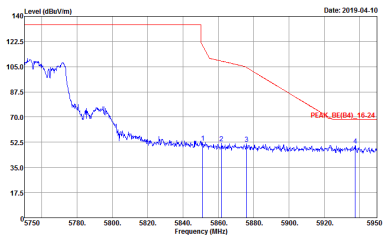

WIFI	Band 4 5725~5850MHz Band Edge @ 3m	
ANT	802.11n HT40 CH151 5755MHz	
1+2	Vertical	Fundamental
Peak	 <p>Site : 03CH13-HY Condition : PEAK_BE(B4)_16-24 3m HORN_91200_1241 VERTICAL Detector : Peak Project : 932216 Mode : 40</p>	 <p>Site : 03CH13-HY Condition : PEAK(UNII) 3m HORN_91200_1241 VERTICAL Detector : Peak Project : 932216 Mode : 40</p>
Peak	 <p>Site : 03CH13-HY Condition : PEAK_BE(B4)_16-24 3m HORN_91200_1241 VERTICAL Detector : Peak Project : 932216 Mode : 40</p>	Left blank

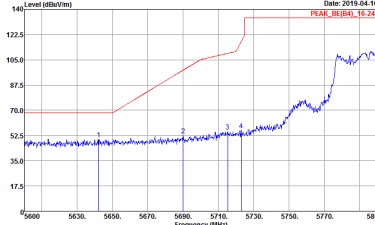
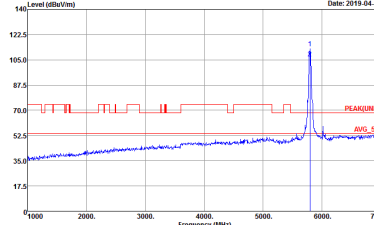
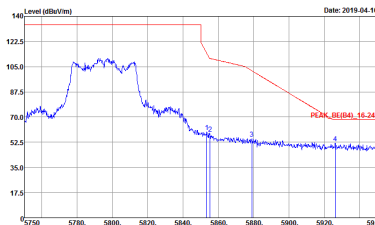

WIFI	Band 4 5725~5850MHz Band Edge @ 3m	
ANT	802.11n HT40 CH159 5795MHz	
1+2	Horizontal	Fundamental
<p>Peak</p>	 <p>Site : 03CH13-HY Condition : PEAK_BE(84)_16-24 3m HORN_91200_1241 HORIZONTAL Detector : Peak Project : 932216 Mode : 41</p>	 <p>Site : 03CH13-HY Condition : PEAK(UNII) 3m HORN_91200_1241 HORIZONTAL Detector : Peak Project : 932216 Mode : 41</p>
<p>Peak</p>	 <p>Site : 03CH13-HY Condition : PEAK_BE(84)_16-24 3m HORN_91200_1241 HORIZONTAL Detector : Peak Project : 932216 Mode : 41</p>	<p>Left blank</p>

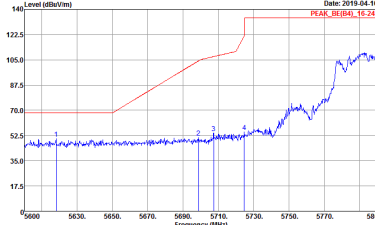
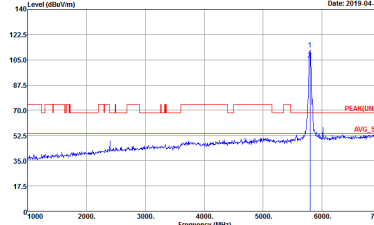

WIFI	Band 4 5725~5850MHz Band Edge @ 3m	
ANT	802.11n HT40 CH159 5795MHz	
1+2	Vertical	Fundamental
Peak	 <p>Site : 03CH13-HY Condition : PEAK_BE(B4)_16-24 3m HORN_91200_1241 VERTICAL Detector : Peak Project : 932216 Mode : 41</p>	 <p>Site : 03CH13-HY Condition : PEAK(UNII) 3m HORN_91200_1241 VERTICAL Detector : Peak Project : 932216 Mode : 41</p>
Peak	 <p>Site : 03CH13-HY Condition : PEAK_BE(B4)_16-24 3m HORN_91200_1241 VERTICAL Detector : Peak Project : 932216 Mode : 41</p>	Left blank



Band 4 5725~5850MHz
WIFI 802.11ac VHT80 (Band Edge @ 3m)

WIFI	Band 4 5725~5850MHz Band Edge @ 3m	
ANT	802.11ac VHT80 CH155 5775MHz	
1+2	Horizontal	Fundamental
Peak	<p>Site : 03CH13-HY Condition : PEAK_BE(B4)_16-24 3m HORN_91200_1241 HORIZONTAL Detector : Peak Project : 932216 Mode : 42</p>	<p>Site : 03CH13-HY Condition : PEAK(UNIT) 3m HORN_91200_1241 HORIZONTAL Detector : Peak Project : 932216 Mode : 42</p>
Peak	<p>Site : 03CH13-HY Condition : PEAK_BE(B4)_16-24 3m HORN_91200_1241 HORIZONTAL Detector : Peak Project : 932216 Mode : 42</p>	Left blank



WIFI	Band 4 5725~5850MHz Band Edge @ 3m	
ANT	802.11ac VHT80 CH155 5775MHz	
1+2	Vertical	Fundamental
<p>Peak</p>	<p>Date: 2019-04-10 PEAK_BE(04)_15-20</p> <p>Site : 03CH13-HY Condition : PEAK_BE(04)_16-24 3m HORN_91200_1241 VERTICAL RBW:1000.000KHz VBW:3000.000KHz SWT:Auto Detector : Peak Project : 932216 Mode : 42</p>	<p>Date: 2019-04-10 PEAK(04)_15-20</p> <p>Site : 03CH13-HY Condition : PEAK(UNII) 3m HORN_91200_1241 VERTICAL RBW:1000.000KHz VBW:3000.000KHz SWT:Auto Detector : Peak Project : 932216 Mode : 42</p>
<p>Peak</p>	<p>Date: 2019-04-10 PEAK_BE(04)_16-24</p> <p>Site : 03CH13-HY Condition : PEAK_BE(04)_16-24 3m HORN_91200_1241 VERTICAL RBW:1000.000KHz VBW:3000.000KHz SWT:Auto Detector : Peak Project : 932216 Mode : 42</p>	<p>Left blank</p>



Band 4 - 5725~5850MHz
WIFI 802.11a (Harmonic @ 3m)

WIFI	Band 4 5725~5850MHz Harmonic @ 3m	
ANT	802.11a CH149 5745MHz	
1+2	Horizontal	Vertical
Peak Avg.	<p>Site : 03CH13-1FY Condition : PEAK(LINE) 3m HORN_91200_1241 HORIZONTAL Detector : Peak Project : 932216 Mode : 34</p>	<p>Site : 03CH13-1FY Condition : PEAK(LINE) 3m HORN_91200_1241 VERTICAL Detector : Peak Project : 932216 Mode : 34</p>

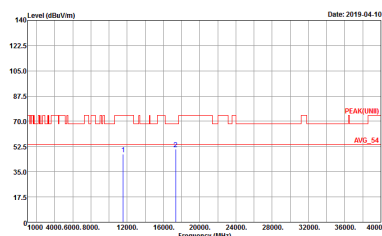

WIFI	Band 4 5725~5850MHz Harmonic @ 3m	
ANT	802.11a CH157 5785MHz	
1+2	Horizontal	Vertical
<p>Peak</p> <p>Avg.</p>	 <p>Site : 03CH12-HY Condition : PEAK(UNII) 3m HORN_91200_1241 HORIZONTAL Detector : Peak Project : 932216 Mode : 35</p>	 <p>Site : 03CH12-HY Condition : PEAK(UNII) 3m HORN_91200_1241 VERTICAL Detector : Peak Project : 932216 Mode : 35</p>



WIFI	Band 4 5725~5850MHz Harmonic @ 3m	
ANT	802.11a CH165 5825MHz	
1+2	Horizontal	Vertical
Peak Avg.	<p>Site : 03CH12-HY Condition : PEAK(UNII) 3m HORN_91200_1241 HORIZONTAL Detector : Peak Project : 932216 Mode : 30</p>	<p>Site : 03CH12-HY Condition : PEAK(UNII) 3m HORN_91200_1241 VERTICAL Detector : Peak Project : 932216 Mode : 30</p>



**Band 4 5725~5850MHz
WIFI 802.11n HT20 (Harmonic @ 3m)**

WIFI	Band 4 5725~5850MHz Harmonic @ 3m	
ANT	802.11n HT20 CH149 5745MHz	
1+2	Horizontal	Vertical
Peak Avg.	<p>Site : 03CH13-HY Condition : PEAK(UNII) 3m HORN_91200_1241 HORIZONTAL Detector : Peak Project : 932216 Mode : 37</p>	<p>Site : 03CH13-HY Condition : PEAK(UNII) 3m HORN_91200_1241 VERTICAL Detector : Peak Project : 932216 Mode : 37</p>



WIFI	Band 4 5725~5850MHz Harmonic @ 3m	
ANT	802.11n HT20 CH157 5785MHz	
1+2	Horizontal	Vertical
<p>Peak</p> <p>Avg.</p>	<p>Site : 03CH13-HY Condition : PEAK(UNII) 3m HORN_91200_1241 HORIZONTAL Detector : Peak Project : 932216 Mode : 3B</p>	<p>Site : 03CH13-HY Condition : PEAK(UNII) 3m HORN_91200_1241 VERTICAL Detector : Peak Project : 932216 Mode : 3B</p>

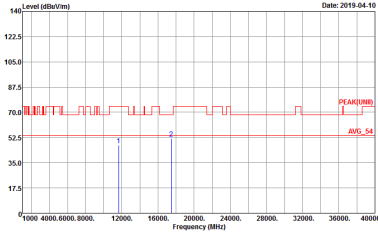
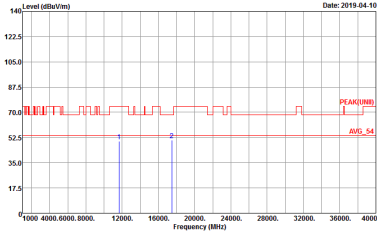

WIFI	Band 4 5725~5850MHz Harmonic @ 3m	
ANT	802.11n HT20 CH165 5825MHz	
1+2	Horizontal	Vertical
<p>Peak</p> <p>Avg.</p>	 <p>Site : 03CH13-HY Condition : PEAK(UNII) 3m HORN_91200_1241 HORIZONTAL Detector : Peak Project : 932216 Mode : 39</p>	 <p>Site : 03CH13-HY Condition : PEAK(UNII) 3m HORN_91200_1241 VERTICAL Detector : Peak Project : 932216 Mode : 39</p>



Band 4 5725~5850MHz
WIFI 802.11n HT40 (Harmonic @ 3m)

WIFI	Band 4 5725~5850MHz Harmonic @ 3m	
ANT	802.11n HT40 CH151 5755MHz	
1+2	Horizontal	Vertical
Peak Avg.	<p>Site : 03CH13-HY Condition : PEAK(UNII) 3m HORN_91200_1241 HORIZONTAL Detector : Peak Project : 932216 Mode : 40</p>	<p>Site : 03CH13-HY Condition : PEAK(UNII) 3m HORN_91200_1241 VERTICAL Detector : Peak Project : 932216 Mode : 40</p>



WIFI	Band 4 5725~5850MHz Harmonic @ 3m	
ANT	802.11n HT40 CH159 5795MHz	
1+2	Horizontal	Vertical
Peak Avg.	<p>Site : 03CH13-HY Condition : PEAK(UNII) 3m HORN_91200_1241 HORIZONTAL Detector : Peak Project : 932216 Mode : -41</p>	<p>Site : 03CH13-HY Condition : PEAK(UNII) 3m HORN_91200_1241 VERTICAL Detector : Peak Project : 932216 Mode : -41</p>



**Band 4 5725~5850MHz
WIFI 802.11ac VHT80 (Harmonic @ 3m)**

WIFI	Band 4 5725~5850MHz Harmonic @ 3m	
ANT	802.11ac VHT80 CH155 5775MHz	
1+2	Horizontal	Vertical
Peak Avg.	<p>Site : 03CH13-HY Condition : PEAK(UNII) 3m HORN_91200_1241 HORIZONTAL Detector : Peak Project : 932216 Mode : 42</p>	<p>Site : 03CH13-HY Condition : PEAK(UNII) 3m HORN_91200_1241 VERTICAL Detector : Peak Project : 932216 Mode : 42</p>

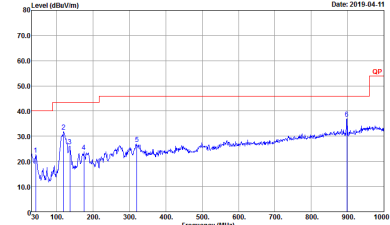
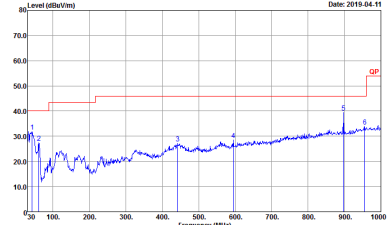

Emission below 1GHz
5GHz WIFI 802.11ac VHT80 (LF)

WIFI	5GHz 5725~5850MHz	
ANT	802.11ac VHT80 LF	
1+2	Horizontal	Vertical
QP / Peak	 <p>Site : 03CH13-HY Condition : QP_3m_BTL0G_37059401 HORIZONTAL Detector : Peak Project : 932216 Mode : -44</p>	 <p>Site : 03CH13-HY Condition : QP_3m_BTL0G_37059401 VERTICAL Detector : Peak Project : 932216 Mode : -44</p>



Appendix E. Duty Cycle Plots

Antenna	Band	Duty Cycle(%)	T(us)	1/T(kHz)	VBW Setting	Duty Factor(dB)
1+2	802.11a for Ant 1	98.10	-	-	10Hz	0.08
1+2	802.11a for Ant 2	98.10	-	-	10Hz	0.08
1+2	5GHz 802.11n HT20 for Ant 1	98.02	-	-	10Hz	0.09
1+2	5GHz 802.11n HT20 for Ant 2	98.02	-	-	10Hz	0.09
1+2	5GHz 802.11n HT40 for Ant 1	96.07	855	1.17	3kHz	0.17
1+2	5GHz 802.11n HT40 for Ant 2	96.07	855	1.17	3kHz	0.17
1+2	5GHz 802.11ac VHT20 for Ant 1	98.03	1745	0.57	10Hz	0.09
1+2	5GHz 802.11ac VHT20 for Ant 2	98.03	1745	0.57	10Hz	0.09
1+2	5GHz 802.11ac VHT40 for Ant 1	96.09	860	1.16	3kHz	0.17
1+2	5GHz 802.11ac VHT40 for Ant 2	96.09	860	1.16	3kHz	0.17
1+2	5GHz 802.11ac VHT80 for Ant 1	95.56	860	1.16	3kHz	0.20
1+2	5GHz 802.11ac VHT80 for Ant 2	95.56	860	1.16	3kHz	0.20



MIMO <Ant. 1>

802.11a

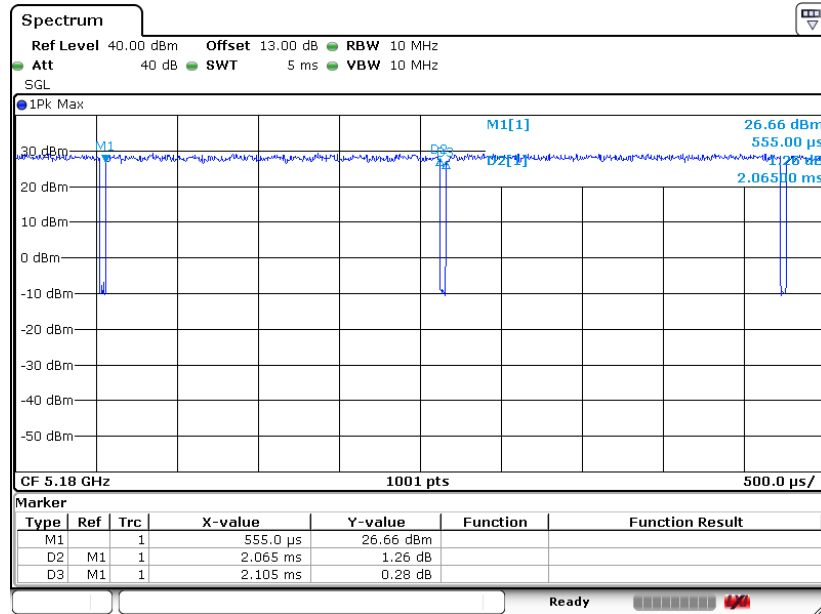

Date: 14.JUN.2019 10:09:55

802.11n HT20

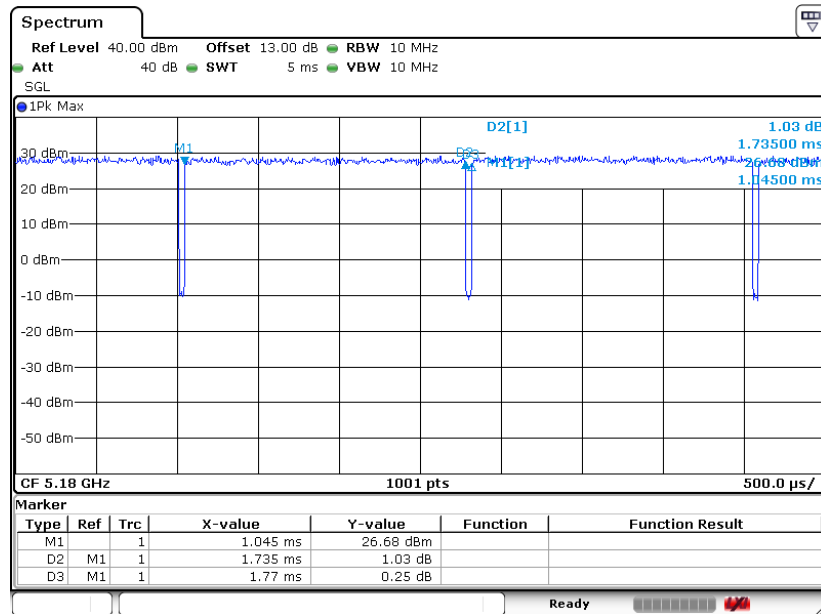

Date: 14.JUN.2019 11:22:09



802.11n HT40

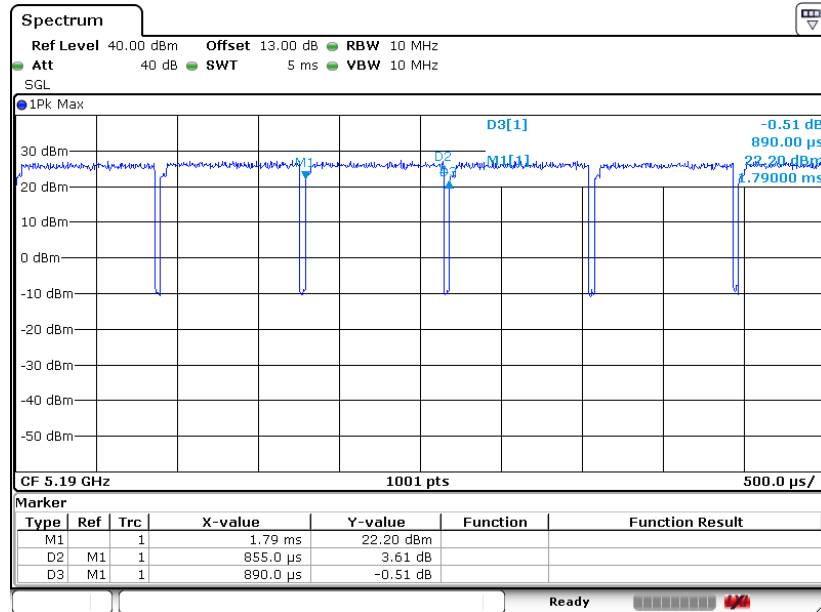

Date: 14.JUN.2019 11:09:27

802.11ac VHT20

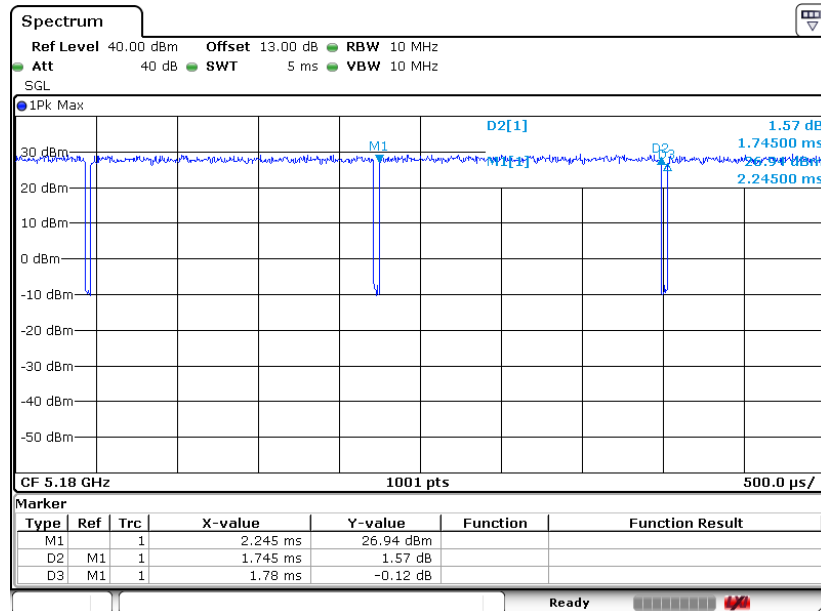

Date: 14.JUN.2019 11:19:11



802.11ac VHT40

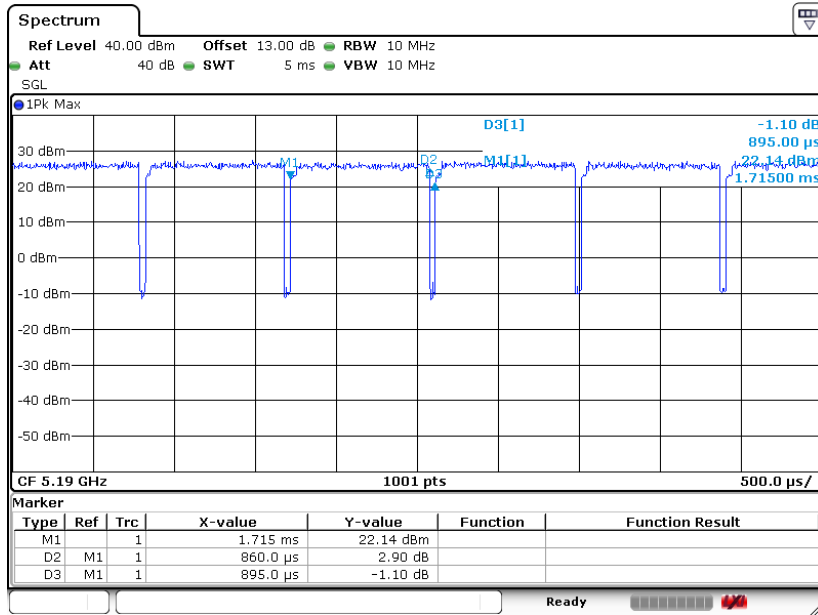

Date: 14.JUN.2019 11:26:02

802.11ac VHT80

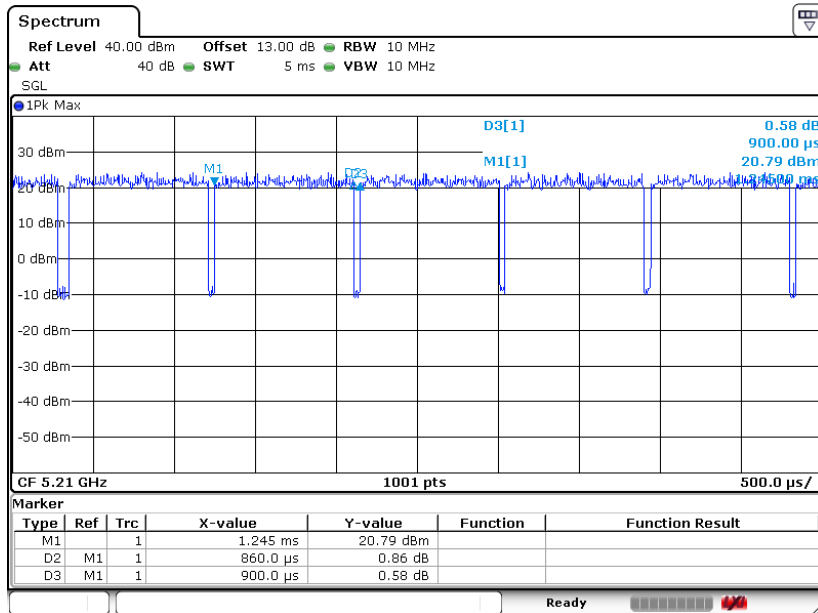

Date: 14.JUN.2019 11:32:55



MIMO <Ant. 2>

802.11a

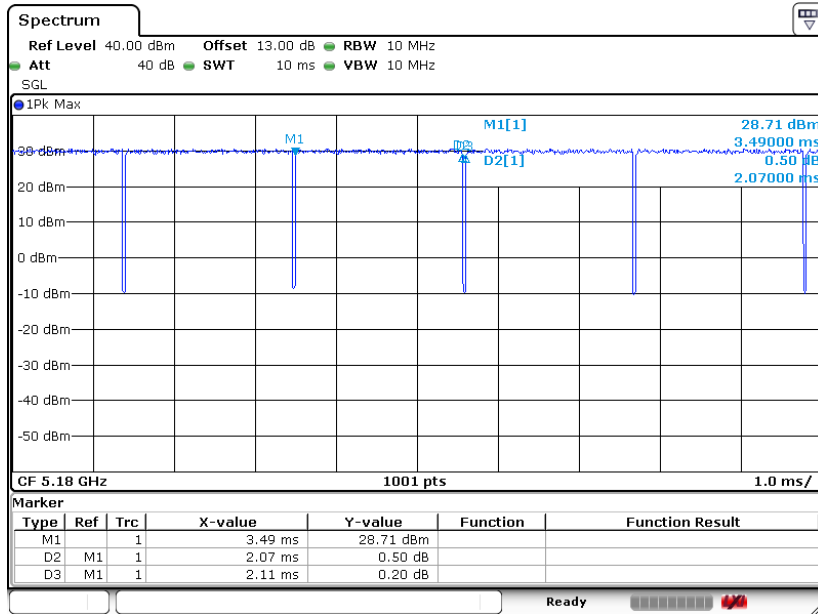

Date: 14.JUN.2019 10:58:51

802.11n HT20

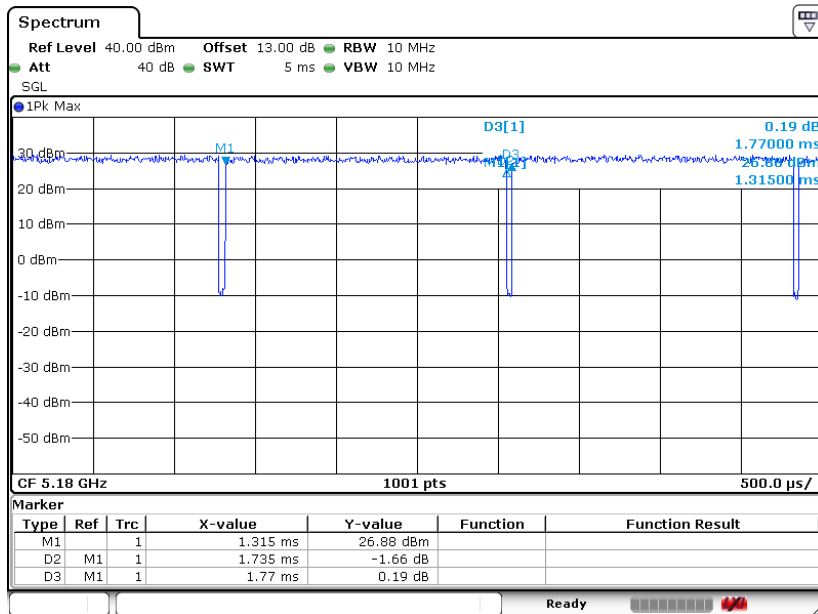

Date: 14.JUN.2019 11:23:32



802.11n HT40

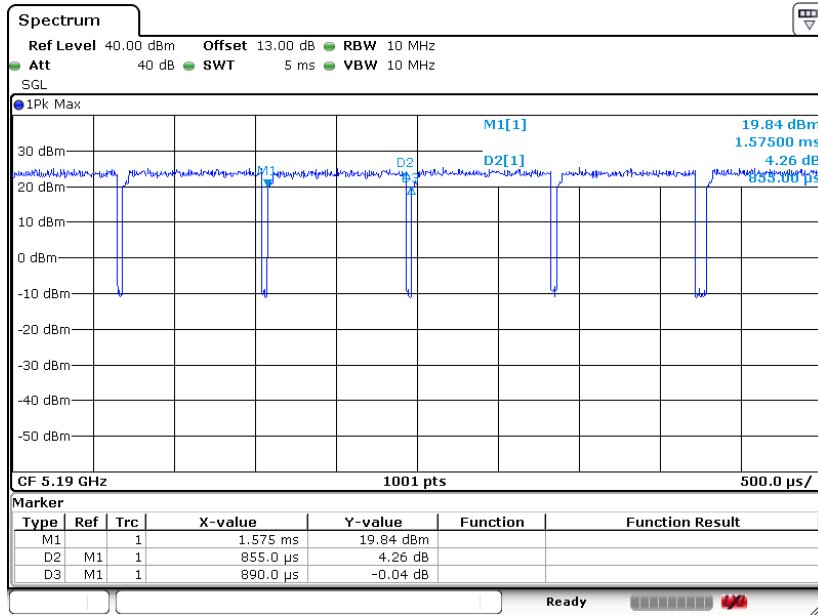

Date: 14.JUN.2019 11:14:51

802.11ac VHT20

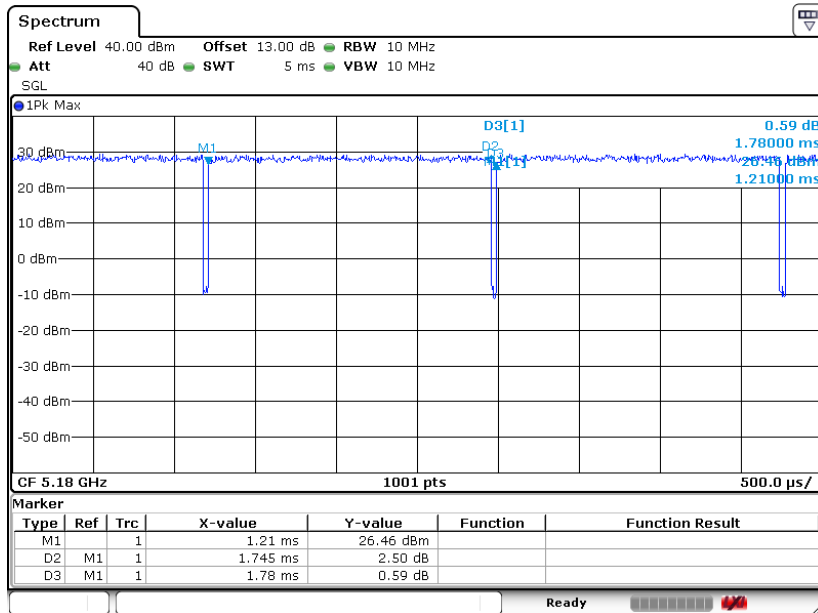

Date: 14.JUN.2019 11:20:34



802.11ac VHT40

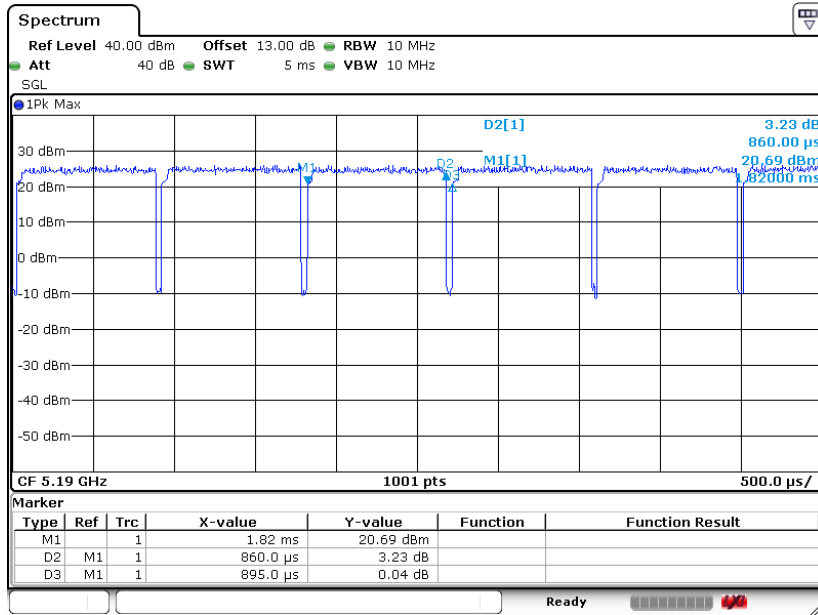

Date: 14.JUN.2019 11:27:51

802.11ac VHT80

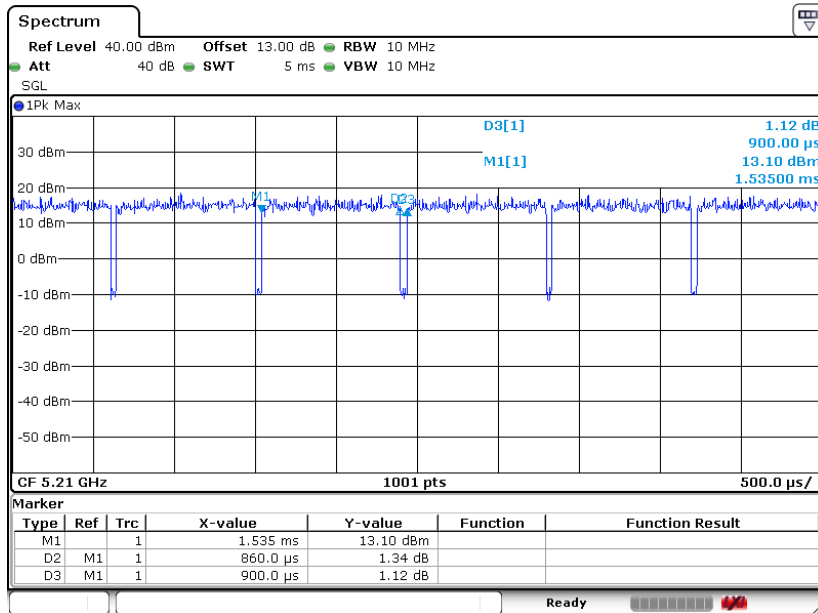

Date: 14.JUN.2019 11:34:34