



# FCC RADIO TEST REPORT

**FCC ID** : 2AGOZ-CM5X  
**Equipment** : Media Receiver  
**Brand Name** : facebook  
**Model Name** : LW94NS  
**Applicant** : Facebook Technologies LLC  
1 Hacker Way Menlo Park CA 94025  
**Standard** : FCC Part 15 Subpart E §15.407

The product was received on Apr. 08, 2019 and testing was started from Apr. 08, 2019 and completed on Jun. 14, 2019. We, SPORTON INTERNATIONAL INC., EMC & Wireless Communications Laboratory, would like to declare that the tested sample has been evaluated in accordance with the test procedures and has been in compliance with the applicable technical standards.

The report must not be used by the client to claim product certification, approval, or endorsement by TAF or any agency of government.

The test results in this report apply exclusively to the tested model / sample. Without written approval of SPORTON INTERNATIONAL INC. EMC & Wireless Communications Laboratory, the test report shall not be reproduced except in full.

Approved by: Jones Tsai

**SPORTON INTERNATIONAL INC. EMC & Wireless Communications Laboratory**  
No. 52, Huaya 1st Rd., Guishan Dist., Taoyuan City, Taiwan (R.O.C.)



## Table of Contents

History of this test report.....	3
Summary of Test Result.....	4
<b>1 General Description .....</b>	<b>5</b>
1.1 Product Feature of Equipment Under Test.....	5
1.2 Modification of EUT .....	5
1.3 Testing Location .....	5
1.4 Applicable Standards.....	6
<b>2 Test Configuration of Equipment Under Test .....</b>	<b>7</b>
2.1 Carrier Frequency and Channel .....	7
2.2 Test Mode.....	8
2.3 Connection Diagram of Test System.....	10
2.4 Support Unit used in test configuration and system .....	11
2.5 EUT Operation Test Setup .....	11
2.6 Measurement Results Explanation Example.....	11
<b>3 Test Result .....</b>	<b>12</b>
3.1 26dB & 99% Occupied Bandwidth Measurement .....	12
3.2 Maximum Conducted Output Power Measurement .....	14
3.3 Power Spectral Density Measurement .....	16
3.4 Unwanted Emissions Measurement.....	18
3.5 AC Conducted Emission Measurement.....	23
3.6 Automatically Discontinue Transmission .....	25
3.7 Antenna Requirements.....	26
<b>4 List of Measuring Equipment.....</b>	<b>27</b>
<b>5 Uncertainty of Evaluation .....</b>	<b>29</b>
<b>Appendix A. Conducted Test Results</b>	
<b>Appendix B. AC Conducted Emission Test Result</b>	
<b>Appendix C. Radiated Spurious Emission</b>	
<b>Appendix D. Radiated Spurious Emission Plots</b>	
<b>Appendix E. Duty Cycle Plots</b>	
<b>Appendix F. Setup Photographs</b>	





## Summary of Test Result

Report Clause	Ref Std. Clause	Test Items	Result (PASS/FAIL)	Remark
3.1	15.403(i)	26dB Bandwidth	Pass	-
3.1	2.1049	99% Occupied Bandwidth	Reporting only	-
3.2	15.407(a)	Maximum Conducted Output Power	Pass	-
3.3	15.407(a)	Power Spectral Density	Pass	-
3.4	15.407(b)	Unwanted Emissions	Pass	Under limit 1.28 dB at 5352.240 MHz
3.5	15.207	AC Conducted Emission	Pass	Under limit 11.08 dB at 0.686 MHz
3.6	15.407(c)	Automatically Discontinue Transmission	Pass	-
3.7	15.203 15.407(a)	Antenna Requirement	Pass	-

**Declaration of Conformity:**

The test results with all measurement uncertainty excluded are presented in accordance with the regulation limits or requirements declared by manufacturers.

**Comments and Explanations:**

The declared of product specification for EUT presented in the report are provided by the manufacturer, and the manufacturer takes all the responsibilities for the accuracy of product specification.

**Reviewed by: Wii Chang**

**Report Producer: Yimin Ho**



# 1 General Description

## 1.1 Product Feature of Equipment Under Test

Bluetooth, Wi-Fi 2.4GHz 802.11b/g/n and Wi-Fi 5GHz 802.11a/n/ac

Product Specification subjective to this standard	
Antenna Type	WLAN: PIFA Antenna Bluetooth: PIFA Antenna

## 1.2 Modification of EUT

No modifications are made to the EUT during all test items.

## 1.3 Testing Location

Test Site	SPORTON INTERNATIONAL INC. EMC & Wireless Communications Laboratory	
Test Site Location	No.52, Huaya 1st Rd., Guishan Dist., Taoyuan City, Taiwan (R.O.C.) TEL: +886-3-327-3456 FAX: +886-3-328-4978	
Test Site No.	<b>Sporton Site No.</b>	
	TH05-HY	CO05-HY

Test Site	SPORTON INTERNATIONAL INC. EMC & Wireless Communications Laboratory	
Test Site Location	No.58, Aly. 75, Ln. 564, Wenhua 3rd, Rd., Guishan Dist., Taoyuan City, Taiwan (R.O.C.) TEL: +886-3-327-0868 FAX: +886-3-327-0855	
Test Site No.	<b>Sporton Site No.</b>	
	03CH13-HY	

**Note:** The test site complies with ANSI C63.4 2014 requirement.

FCC designation No.: TW1190 and TW0007



## **1.4 Applicable Standards**

According to the specifications of the manufacturer, the EUT must comply with the requirements of the following standards:

- ♦ FCC Part 15 Subpart E
- ♦ FCC KDB 789033 D02 General UNII Test Procedures New Rules v02r01.
- ♦ FCC KDB 414788 D01 Radiated Test Site v01r01.
- ♦ FCC KDB 662911 D01 Multiple Transmitter Output v02r01.
- ♦ ANSI C63.10-2013

**Remark:**

1. All test items were verified and recorded according to the standards and without any deviation during the test.
2. This EUT has also been tested and complied with the requirements of FCC Part 15, Subpart B, recorded in a separate test report.



## 2 Test Configuration of Equipment Under Test

- a. The EUT has been associated with peripherals and configuration operated in a manner tended to maximize its emission characteristics in a typical application. Frequency range investigated: conduction emission (150 kHz to 30 MHz), radiation emission (9 kHz to the 10th harmonic of the highest fundamental frequency or to 40 GHz, whichever is lower). For radiated measurement, pre-scanned in two setup, without all accessories, with all accessories. The worst cases (without all accessories) were recorded in this report.
- b. AC power line Conducted Emission was tested under maximum output power.

### 2.1 Carrier Frequency and Channel

Frequency Band	Channel	Freq. (MHz)	Channel	Freq. (MHz)
5150-5250 MHz Band 1 (U-NII-1)	36	5180	44	5220
	38*	5190	46*	5230
	40	5200	48	5240
	42#	5210		

Frequency Band	Channel	Freq. (MHz)	Channel	Freq. (MHz)
5250-5350 MHz Band 2 (U-NII-2A)	52	5260	60	5300
	54*	5270	62*	5310
	56	5280	64	5320
	58#	5290		

Frequency Band	Channel	Freq. (MHz)	Channel	Freq. (MHz)
5470-5725 MHz Band 3 (U-NII-2C)	100	5500	112	5560
	102*	5510	116	5580
	104	5520	132	5660
	106#	5530	134*	5670
	108	5540	136	5680
	110*	5550	140	5700



Frequency Band	Channel	Freq. (MHz)	Channel	Freq. (MHz)
TDWR Channel	118*	5590	124	5620
	120	5600	126*	5630
	122#	5610	128	5640

Frequency Band	Channel	Freq. (MHz)	Channel	Freq. (MHz)
Straddle Channel	138#	5690	144	5720
	142*	5710		

Note:

1. The above Frequency and Channel in "\*" were 802.11n HT40 and 802.11ac VHT40.
2. The above Frequency and Channel in "#" were 802.11ac VHT80.

## 2.2 Test Mode

Final test modes are considering the modulation and worse data rates as below table.

### MIMO Mode

Modulation	Data Rate
802.11a	6 Mbps
802.11n HT20	MCS0
802.11n HT40	MCS0
802.11n HT20 (Covered by VHT20)	MCS0
802.11n HT40 (Covered by VHT40)	MCS0
802.11ac VHT80	MCS0

Test Cases	
AC Conducted Emission	Mode 1 : Bluetooth Link + WLAN (5GHz) Link + Adapter + MPEG4 + HDMI
Remark: For Radiated Test Cases, the tests were performed with Adapter.	





Ch. #		Band I : 5150-5250 MHz	Band II : 5250-5350 MHz	Band III : 5470-5725MHz
		802.11a	802.11a	802.11a
L	Low	36	52	100
M	Middle	44	60	116
H	High	48	64	140
Straddle		-	-	144

Ch. #		Band I : 5150-5250 MHz	Band II : 5250-5350 MHz	Band III : 5470-5725MHz
		802.11n HT20	802.11n HT20	802.11n HT20
L	Low	36	52	100
M	Middle	44	60	116
H	High	48	64	140
Straddle		-	-	144

Ch. #		Band I : 5150-5250 MHz	Band II : 5250-5350 MHz	Band III : 5470-5725MHz
		802.11n HT40	802.11n HT40	802.11n HT40
L	Low	38	54	102
M	Middle	-	-	110
H	High	46	62	134
Straddle		-	-	142

Ch. #		Band I : 5150-5250 MHz	Band II : 5250-5350 MHz	Band III : 5470-5725MHz
		802.11ac VHT80	802.11ac VHT80	802.11ac VHT80
L	Low	-	-	106
M	Middle	42	58	122
H	High	-	-	-
Straddle		-	-	138

## 2.3 Connection Diagram of Test System

<WLAN Tx Mode>

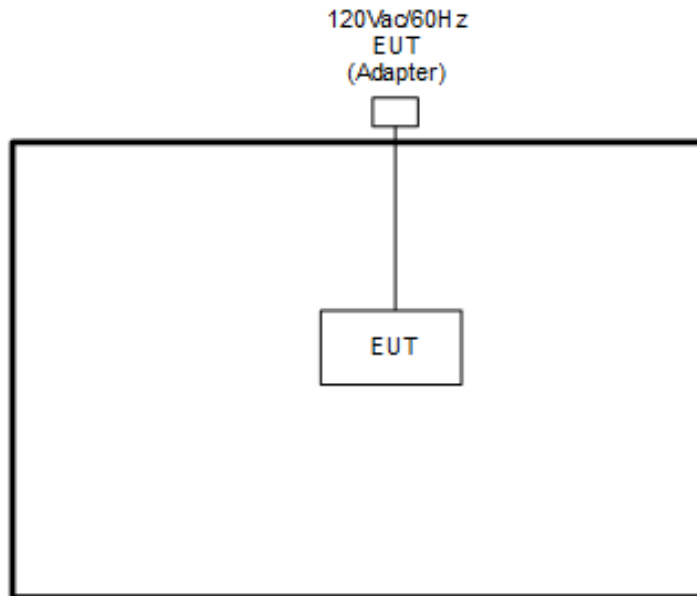

<AC Conducted Emission Mode>

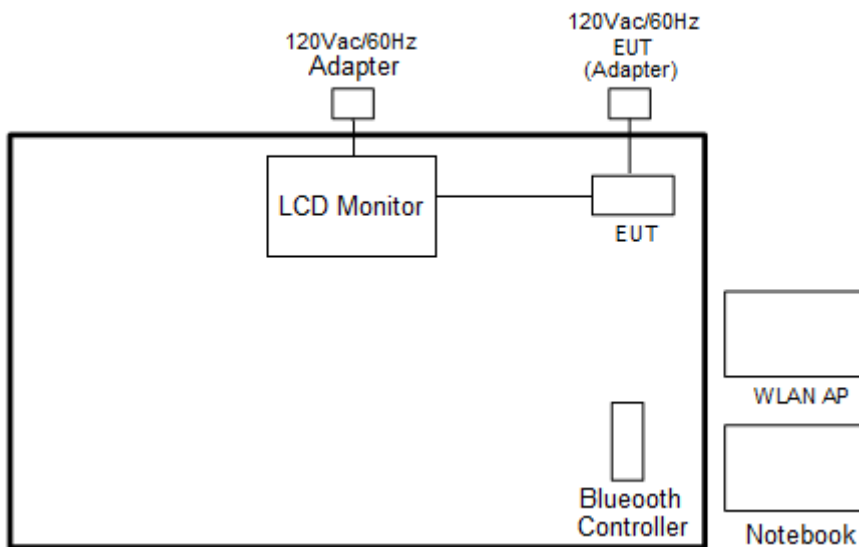



## 2.4 Support Unit used in test configuration and system

Item	Equipment	Trade Name	Model Name	FCC ID	Data Cable	Power Cord
1.	WLAN AP	ASUS	RT-AC66U	MSQ-RTAC66U	N/A	Unshielded,1.8m
2.	Notebook	DELL	Latitude E6320	FCC DoC	N/A	AC I/P: Unshielded, 1.2 m DC O/P: Shielded, 1.8 m
3.	LCD Monitor	DELL	P2715Qt	FCC DoC	Shielded, 1.6m	Unshielded,1.8m

## 2.5 EUT Operation Test Setup

The RF test items, utility “QRCT v3.0-00271” was installed in Notebook which was programmed in order to make the EUT get into the engineering modes to provide channel selection, power level, data rate and the application type and for continuous transmitting signals.

## 2.6 Measurement Results Explanation Example

For all conducted test items:

The offset level is set in the spectrum analyzer to compensate the RF cable loss and attenuator factor between EUT conducted output port and spectrum analyzer. With the offset compensation, the spectrum analyzer reading level is exactly the EUT RF output level.

Example :

The spectrum analyzer offset is derived from RF cable loss and attenuator factor.

*Offset = RF cable loss + attenuator factor.*

Following shows an offset computation example with cable loss 7.8 dB and 20dB attenuator.

$$\begin{aligned} \text{Offset(dB)} &= \text{RF cable loss(dB)} + \text{attenuator factor(dB)}. \\ &= 7.8 + 20 = 27.8 \text{ (dB)} \end{aligned}$$

### 3 Test Result

#### 3.1 26dB & 99% Occupied Bandwidth Measurement

##### 3.1.1 Description of 26dB & 99% Occupied Bandwidth

This section is for reporting purpose only.

There is no restriction limits for bandwidth.

For Straddle Channel, according to KDB 789033 D02 General UNII Test Procedures New Rules v02r01, if the power and PSD of the devices are uniform and comply with the lower limits specified for the U-NII-2 bands, a single measurement over the entire emission bandwidth can be performed to show compliance.

##### 3.1.2 Measuring Instruments

See list of measuring equipment of this test report.

##### 3.1.3 Test Procedures

1. The testing follows FCC KDB 789033 D02 General UNII Test Procedures New Rules v02r01. Section C) Emission bandwidth
2. Set RBW = approximately 1% of the emission bandwidth.
3. Set the VBW > RBW.
4. Detector = Peak.
5. Trace mode = max hold
6. Measure the maximum width of the emission that is 26 dB down from the peak of the emission. Compare this with the RBW setting of the analyzer. Readjust RBW and repeat measurement as needed until the RBW/EBW ratio is approximately 1%.
7. For 99% Bandwidth Measurement, the spectrum analyzer's resolution bandwidth (RBW) is set 1-5% of the emission bandwidth and set the Video bandwidth (VBW)  $\geq 3 * RBW$ .
8. Measure and record the results in the test report.

##### 3.1.4 Test Setup

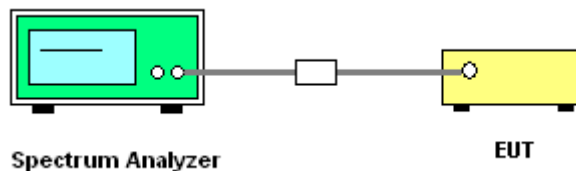

##### 3.1.5 Test Result of 26dB & 99% Occupied Bandwidth

Please refer to Appendix A.

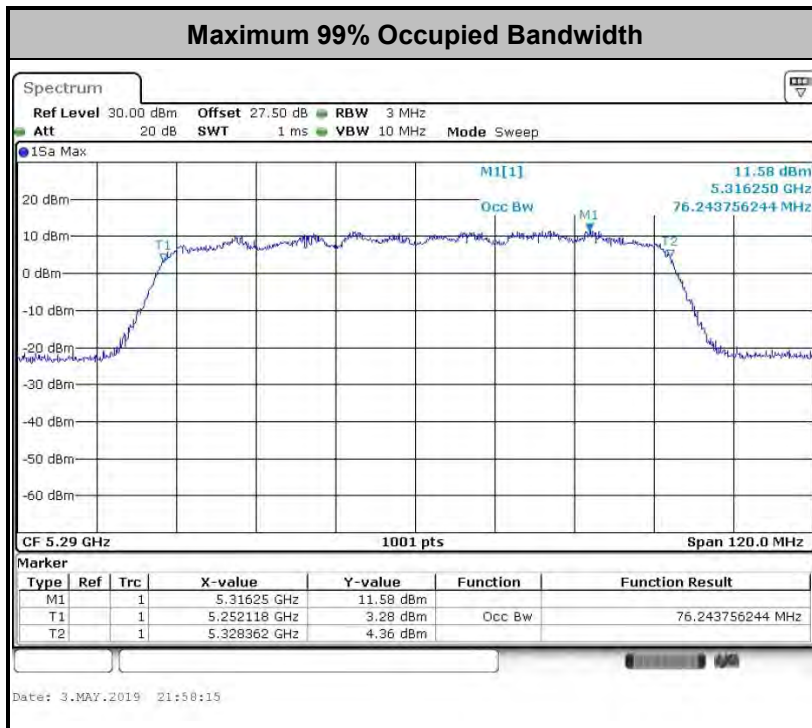
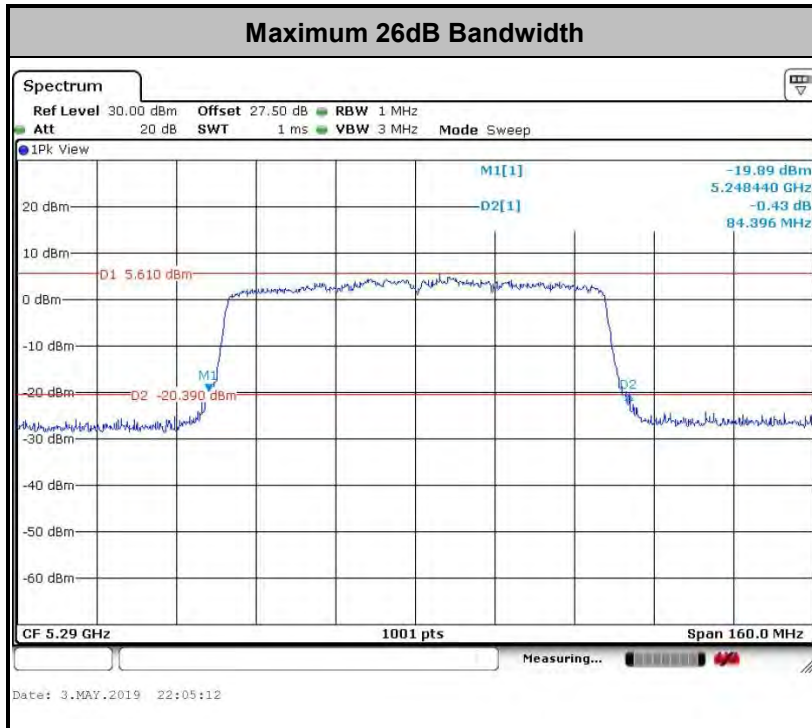

**Note:** The occupied channel bandwidth is maintained within the band of operation for all of the modulations.



## 3.2 Maximum Conducted Output Power Measurement

### 3.2.1 Limit of Maximum Conducted Output Power

<FCC 14-30 CFR 15.407>

**For the 5.15–5.25 GHz bands:**

- For mobile and portable client devices in the 5.15–5.25 GHz band, the maximum conducted output power over the frequency band of operation shall not exceed 250 mW. For an indoor access point operating in the band 5.15-5.25 GHz, the maximum conducted output power over the frequency band of operation shall not exceed 1 W.

**For the 5.25–5.725 GHz bands:**

- The maximum conducted output power over the frequency bands of operation shall not exceed the lesser of 250 mW or  $11 \text{ dBm} + 10 \log B$ , where B is the 26 dB emission bandwidth in megahertz.

For Straddle Channel, according to KDB 789033 D02 General UNII Test Procedures New Rules v02r01, if the power and PSD of the devices are uniform and comply with the lower limits specified for the U-NII-2 bands, a single measurement over the entire emission bandwidth can be performed to show compliance.

If transmitting antennas of directional gain greater than 6 dBi are used, the peak output power shall be reduced by the amount in dB that the directional gain of the antenna exceeds 6 dBi.

Note that U-NII-2 band, devices with a maximum e.i.r.p. greater than 500 mW shall implement TPC in order to have the capability to operate at least 6 dB below the maximum permitted e.i.r.p. of 1 W.

### 3.2.2 Measuring Instruments

See list of measuring equipment of this test report.

### 3.2.3 Test Procedures

The testing follows Method PM-G of FCC KDB 789033 D02 General UNII Test Procedures New Rules v02r01.

Method PM-G (Measurement using an RF average power meter):

1. Measurement is performed using a wideband RF power meter.
2. The EUT is configured to transmit at its maximum power control level.
3. Measure the average power of the transmitter
4. Since the measurement is made only during the ON time of the transmitter, no duty cycle correction factor is required.

For Straddle Channel, according to KDB 789033 D02 General UNII Test Procedures New Rules v02r01, if the power and PSD of the devices are uniform and comply with the lower limits specified for the U-NII-2 bands, a single measurement over the entire emission bandwidth can be performed to show compliance.

### 3.2.4 Test Setup

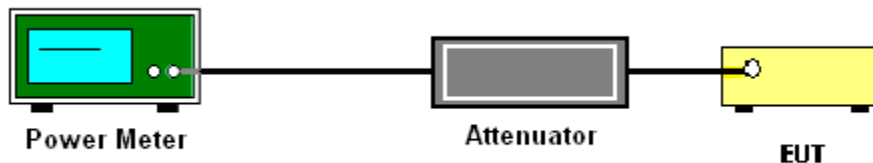

### 3.2.5 Test Result of Maximum Conducted Output Power

Please refer to Appendix A.



### 3.3 Power Spectral Density Measurement

#### 3.3.1 Limit of Power Spectral Density

##### <FCC 14-30 CFR 15.407>

##### **For the 5.15–5.25 GHz bands:**

For mobile and portable client devices in the 5.15–5.25 GHz band, the maximum power spectral density shall not exceed 11 dBm in any 1.0 MHz band. For an indoor access point operating in the band 5.15-5.25 GHz, the maximum power spectral density shall not exceed 17 dBm in any 1.0 MHz band.

##### **For the 5.25–5.725 GHz bands:**

The maximum power spectral density shall not exceed 11 dBm in any 1.0 MHz band.

For Straddle Channel, according to KDB 789033 D02 General UNII Test Procedures New Rules v02r01, if the power and PSD of the devices are uniform and comply with the lower limits specified for the U-NII-2 bands, a single measurement over the entire emission bandwidth can be performed to show compliance.

If transmitting antennas of directional gain greater than 6 dBi are used, the peak output power shall be reduced by the amount in dB that the directional gain of the antenna exceeds 6 dBi.

#### 3.3.2 Measuring Instruments

See list of measuring equipment of this test report.

#### 3.3.3 Test Procedures

The testing follows FCC KDB 789033 D02 General UNII Test Procedures New Rules v02r01. Section F) Maximum power spectral density.

##### **# Method SA-2 #**

(trace averaging across on and off times of the EUT transmissions, followed by duty cycle correction).

- Measure the duty cycle.
- Set span to encompass the entire emission bandwidth (EBW) of the signal.
- Set RBW = 1 MHz.
- Set VBW  $\geq$  3 MHz.
- Number of points in sweep  $\geq$  2 Span / RBW.
- Sweep time = auto.
- Detector = RMS
- Trace average at least 100 traces in power averaging mode.
- Add  $10 \log(1/x)$ , where  $x$  is the duty cycle, to the measured power in order to compute the average power during the actual transmission times. For example, add  $10 \log(1/0.25) = 6$  dB if the duty cycle is 25 percent.



1. The RF output of EUT was connected to the spectrum analyzer by a low loss cable.
2. Each plot has already offset with cable loss, and attenuator loss. Measure the PPSD and record it.
3. For MIMO mode, calculation method follows FCC KDB 662911 D01 Multiple Transmitter Output v02r01.

Method (a): Measure and sum the spectra across the outputs.

The total final Power Spectral Density is from a device with 2 transmitter outputs. The spectrum measurements of the individual outputs are all performed with the same span and number of points; the spectrum value in the first spectral bin of output 1 is summed with that in the first spectral bin of output 2 to obtain the value for the first frequency bin of the summed spectrum.

### 3.3.4 Test Setup

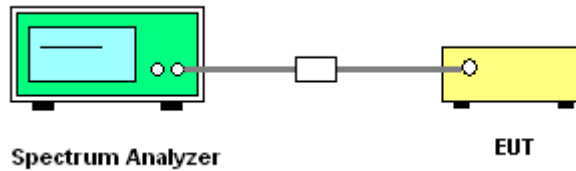

### 3.3.5 Test Result of Power Spectral Density

Please refer to Appendix A.

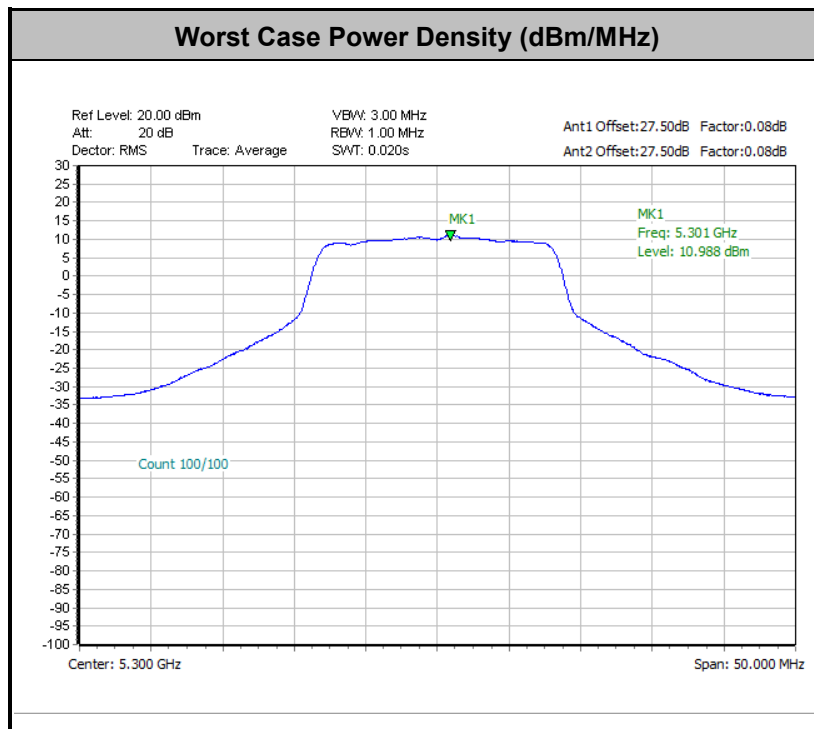

**Note:** Average Power Density (dB) = Measured value+ Duty Factor



### 3.4 Unwanted Emissions Measurement

This section is to measure unwanted emissions through radiated measurement for band edge spurious emissions and out of band emissions measurement.

#### 3.4.1 Limit of Unwanted Emissions

- (1) For transmitters operating in the 5150-5250 MHz band: all emissions outside of the 5150-5350 MHz band shall not exceed an EIRP of -27dBm/MHz.

For transmitters operating in the 5250-5350 MHz band: all emissions outside of the 5150-5350 MHz band shall not exceed an EIRP of -27 dBm/MHz. Devices operating in the 5250-5350 MHz band that generate emissions in the 5150-5250 MHz band must meet all applicable technical requirements for operation in the 5150-5250 MHz band (including indoor use) or alternatively meet an out-of-band emission EIRP limit of -27 dBm/MHz in the 5150-5250 MHz band.

For transmitters operating in the 5470-5600 MHz and 5650-5725MHz band: all emissions outside of the 5470-5600 MHz and 5650-5725MHz band shall not exceed an EIRP of -27 dBm/MHz.

- (2) Unwanted spurious emissions fallen in restricted bands shall comply with the general field strength limits as below table:

Frequency (MHz)	Field Strength (microvolts/meter)	Measurement Distance (meters)
0.009 – 0.490	2400/F(kHz)	300
0.490 – 1.705	24000/F(kHz)	30
1.705 – 30.0	30	30
30 – 88	100	3
88 – 216	150	3
216 - 960	200	3
Above 960	500	3

Note: The following formula is used to convert the EIRP to field strength.

$$E = \frac{1000000\sqrt{30P}}{3} \mu\text{V/m, where P is the eirp (Watts)}$$

EIRP (dBm)	Field Strength at 3m (dBµV/m)
- 27	68.3



(3) KDB789033 D02 v02r01 G)2)c)

- (i) Section 15.407(b)(1) to (b)(3) specify the unwanted emission limits for the U-NII-1 and U-NII-2 bands. As specified, emissions above 1000 MHz that are outside of the restricted bands are subject to a peak emission limit of -27 dBm/MHz.<sup>3</sup>
- (ii) Section 15.407(b)(4) specifies the unwanted emission limit for the U-NII-3 band. A band emissions mask is specified in Section 15.407(b)(4)(i). The emission limits are in terms of a Peak detector. An alternative to the band emissions mask is specified in Section 15.407(b)(4)(ii). The alternative limits are based on the highest antenna gain specified in the filing. There are also marketing and importation restrictions for the devices using the alternative limit.<sup>4</sup>

**Note 3:** An out-of-band emission that complies with both the average and peak limits of Section 15.209 is not required to satisfy the -27 dBm/MHz peak emission limit.

**Note 4:** Only devices with antenna gains of 10 dBi or less may be approved using the emission limits specified in Section 15.247(d) till March 2, 2018; all other devices operating in this band must use the mask specified in Section 15.407(b)(4)(i).

### 3.4.2 Measuring Instruments

See list of measuring equipment of this test report.

### 3.4.3 Test Procedures

1. The testing follows FCC KDB 789033 D02 General UNII Test Procedures New Rules v02r01. Section G) Unwanted emissions measurement.

(1) Procedure for Unwanted Emissions Measurements Below 1000MHz

- RBW = 120 kHz
- VBW = 300 kHz
- Detector = Peak
- Trace mode = max hold

(2) Procedure for Peak Unwanted Emissions Measurements Above 1000 MHz

- RBW = 1 MHz
- VBW ≥ 3 MHz
- Detector = Peak
- Sweep time = auto
- Trace mode = max hold

(3) Procedures for Average Unwanted Emissions Measurements Above 1000MHz

- RBW = 1 MHz
- VBW = 10 Hz, when duty cycle is no less than 98 percent.
- VBW ≥ 1/T, when duty cycle is less than 98 percent where T is the minimum transmission duration over which the transmitter is on and is transmitting at its maximum power control level for the tested mode of operation.

2. The EUT was placed on a turntable with 0.8 meter for frequency below 1GHz and 1.5 meter for frequency above 1GHz respectively above ground.
3. The EUT was set 3 meters from the interference receiving antenna which was mounted on the top of a variable height antenna tower.
4. The antenna is a broadband antenna and its height is adjusted between one meter and four meters above ground to find the maximum value of the field strength for both horizontal polarization and vertical polarization of the antenna.
5. For each suspected emission, the EUT was arranged to its worst case and then adjust the antenna tower (from 1 m to 4 m) and turntable (from 0 degree to 360 degrees) to find the maximum reading.
6. For testing below 1GHz, if the emission level of the EUT in peak mode was 3 dB lower than the limit specified, then peak values of EUT will be reported, otherwise, the emissions will be repeated one by one using the CISPR quasi-peak method and reported.
7. For testing above 1GHz, the emission level of the EUT in peak mode was 20dB lower than average limit (that means the emission level in average mode also complies with the limit in average mode), then peak values of EUT will be reported, otherwise, the emissions will be measured in average mode again and reported.

### 3.4.4 Test Setup

**For radiated emissions below 30MHz**

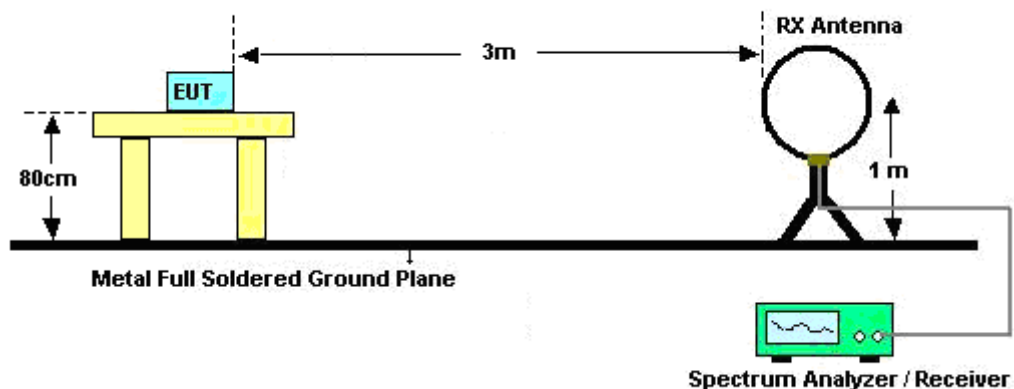

For radiated emissions from 30MHz to 1GHz

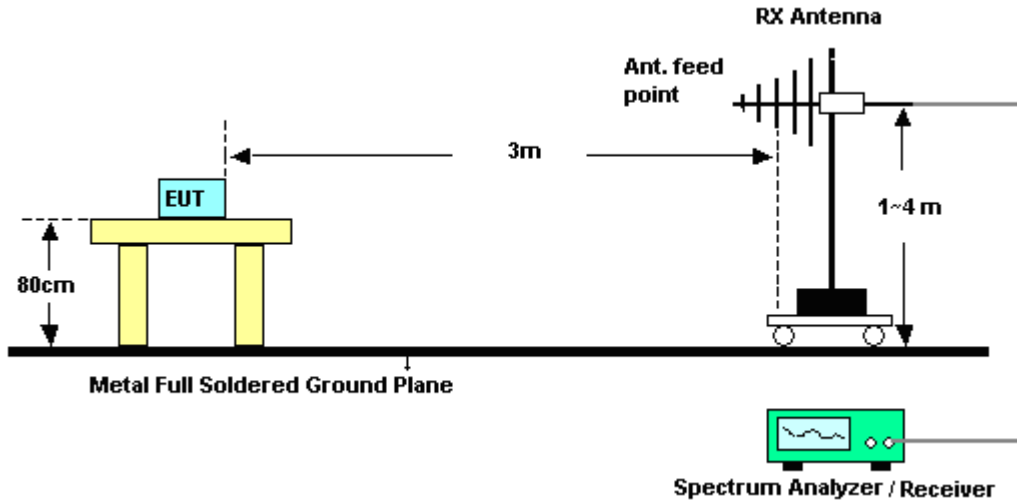

For radiated emissions above 1GHz

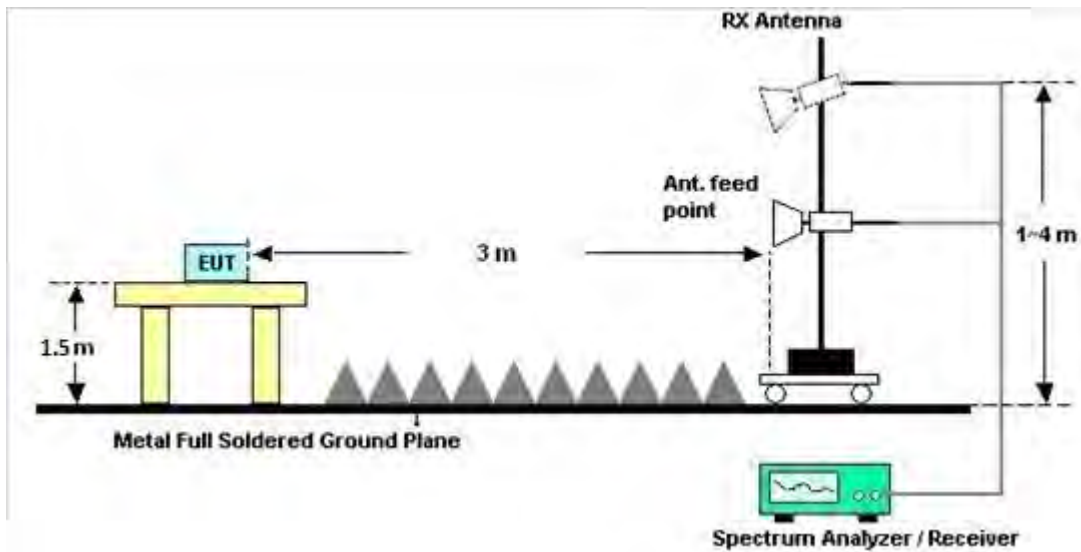



### **3.4.5 Test Results of Radiated Spurious Emissions (9 kHz ~ 30 MHz)**

The low frequency, which started from 9 kHz to 30MHz, was pre-scanned and the result which was 20dB lower than the limit line was not reported.

There is a comparison data of both open-field test site and alternative test site - semi-Anechoic chamber according to 414788 D01 Radiated Test Site v01r01, and the result came out very similar.

### **3.4.6 Test Result of Radiated Spurious at Band Edges**

Please refer to Appendix C and D.

### **3.4.7 Duty Cycle**

Please refer to Appendix E.

### **3.4.8 Test Result of Radiated Spurious Emissions (30MHz ~ 10th Harmonic)**

Please refer to Appendix C and D.



### 3.5 AC Conducted Emission Measurement

#### 3.5.1 Limit of AC Conducted Emission

For equipment that is designed to be connected to the public utility (AC) power line, the radio frequency voltage that is conducted back onto the AC power line on any frequency or frequencies within the band 150 kHz to 30 MHz shall not exceed the limits in the following table.

Frequency of emission (MHz)	Conducted limit (dBµV)	
	Quasi-peak	Average
0.15-0.5	66 to 56*	56 to 46*
0.5-5	56	46
5-30	60	50

\*Decreases with the logarithm of the frequency.

#### 3.5.2 Measuring Instruments

See list of measuring equipment of this test report.

#### 3.5.3 Test Procedures

1. The EUT was placed 0.4 meter from the conducting wall of the shielding room was kept at least 80 centimeters from any other grounded conducting surface.
2. Connect EUT to the power mains through a line impedance stabilization network (LISN).
3. All the support units are connecting to the other LISN.
4. The LISN provides 50 ohm coupling impedance for the measuring instrument.
5. The FCC states that a 50 ohm, 50 microhenry LISN should be used.
6. Both sides of AC line were checked for maximum conducted interference.
7. The frequency range from 150 kHz to 30 MHz was searched.
8. Set the test-receiver system to Peak Detect Function and specified bandwidth with Maximum Hold Mode.

### 3.5.4 Test Setup

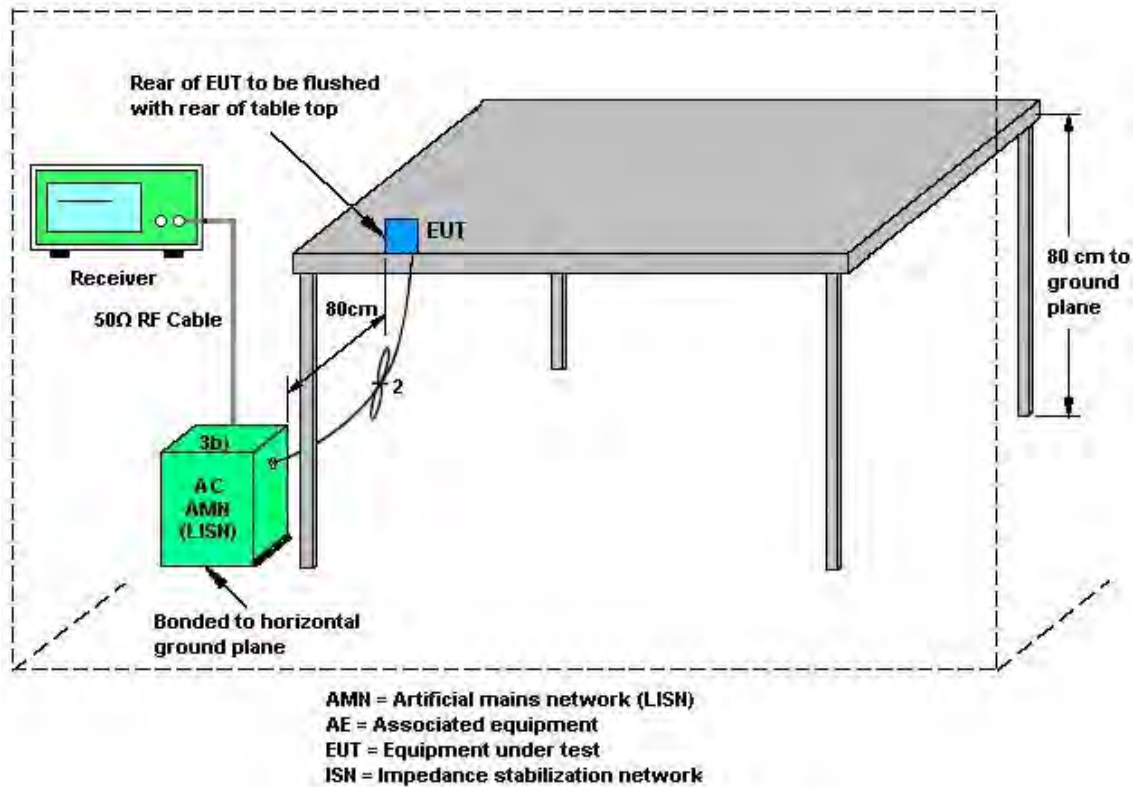

### 3.5.5 Test Result of AC Conducted Emission

Please refer to Appendix B.





## **3.6 Automatically Discontinue Transmission**

### **3.6.1 Limit of Automatically Discontinue Transmission**

The device shall automatically discontinue transmission in case of either absence of information to transmit or operational failure. These provisions are not intended to preclude the transmission of control or signaling information or the use of repetitive codes used by certain digital technologies to complete frame or burst intervals. Applicants shall include in their application for equipment authorization to describe how this requirement is met.

### **3.6.2 Measuring Instruments**

See list of measuring equipment of this test report.

### **3.6.3 Test Result of Automatically Discontinue Transmission**

While the EUT is not transmitting any information, the EUT can automatically discontinue transmission and become standby mode for power saving. The EUT can detect the controlling signal of ACK message transmitting from remote device and verify whether it shall resend or discontinue transmission.



### 3.7 Antenna Requirements

#### 3.7.1 Standard Applicable

If transmitting antenna directional gain is greater than 6 dBi, both the peak transmit power and the peak power spectral density shall be reduced by the amount in dB that the directional gain of the antenna exceeds 6 dBi.

#### 3.7.2 Antenna Anti-Replacement Construction

An embedded-in antenna design is used.

#### 3.7.3 Antenna Gain

<CDD Modes >

FCC KDB 662911 D01 Multiple Transmitter Output v02r01

For CDD transmissions, directional gain is calculated as

Directional gain = GANT + Array Gain, where Array Gain is as follows.

For power spectral density (PSD) measurements on all devices,

Array Gain = 10 log(NANT/NSS=1) dB.

For power measurements on IEEE 802.11 devices,

Array Gain = 0 dB (i.e., no array gain) for NANT ≤ 4.

Directional gain may be calculated by using the formulas applicable to equal gain antennas with GANT set equal to the gain of the antenna having the highest gain;

The EUT supports CDD mode.

For power, the directional gain GANT is set equal to the antenna having the highest gain, i.e., F)2)f)i).

For PSD, the directional gain calculation is following F)2)f)ii) of KDB 662911 D01 v02r01.

The power and PSD limit should be modified if the directional gain of EUT is over 6 dBi,

The directional gain "DG" is calculated as following table.

<CDD Modes>						
			DG for Power (dBi)	DG for PSD (dBi)	Power Limit Reduction (dB)	PSD Limit Reduction (dB)
	Ant. 1 (dBi)	Ant. 2 (dBi)				
Band I	1.38	0.81	1.38	4.11	0.00	0.00
Band II	1.81	1.18	1.81	4.51	0.00	0.00
Band III	2.40	1.73	2.40	5.08	0.00	0.00

Power limit reduction = Composite gain – 6dBi, ( min = 0 )

PSD limit reduction = Composite gain + PSD Array gain – 6dBi, ( min = 0 )



## 4 List of Measuring Equipment

Instrument	Manufacturer	Model No.	Serial No.	Characteristics	Calibration Date	Test Date	Due Date	Remark
Loop Antenna	Rohde & Schwarz	HFH2-Z2	100488	9 kHz~30 MHz	Jan. 07, 2019	Apr. 08, 2019 ~ Apr. 11, 2019	Jan. 06, 2020	Radiation (03CH13-HY)
Horn Antenna	SCHWARZBECK	BBHA 9120 D	9120D-1241	1GHz ~ 18GHz	Jun. 29, 2018	Apr. 08, 2019 ~ Apr. 11, 2019	Jun. 28, 2019	Radiation (03CH13-HY)
Bilog Antenna	TESEQ	CBL 6111D&00800 N1D01N-06	37059&01	30MHz~1GHz	Oct. 13, 2018	Apr. 08, 2019 ~ Apr. 11, 2019	Oct. 12, 2019	Radiation (03CH13-HY)
SHF-EHF Horn Antenna	SCHWARZBECK	BBHA 9170	BBHA9170584	18GHz- 40GHz	Dec. 05, 2018	Apr. 08, 2019 ~ Apr. 11, 2019	Dec. 04, 2019	Radiation (03CH13-HY)
Preamplifier	Keysight	83017A	MY53270080	1GHz~26.5GHz	Nov. 14, 2018	Apr. 08, 2019 ~ Apr. 11, 2019	Nov. 13, 2020	Radiation (03CH13-HY)
Preamplifier	MITEQ	AMF-7D-0010 1800-30-10P	1590074	1GHz~18GHz	May 21, 2018	Apr. 08, 2019 ~ Apr. 11, 2019	May 20, 2019	Radiation (03CH13-HY)
Amplifier	Sonoma-Instrument	310 N	187282	9KHz~1GHz	Dec. 18, 2018	Apr. 08, 2019 ~ Apr. 11, 2019	Dec. 17, 2019	Radiation (03CH13-HY)
Amplifier	MITEQ	TTA1840-35-HG	1871923	18GHz~40GHz, VSWR : 2.5:1 max	Jul. 16, 2018	Apr. 08, 2019 ~ Apr. 11, 2019	Jul. 15, 2019	Radiation (03CH13-HY)
RF Cable	HUBER + SUHNER	SUCOFLEX 126E	0030/126E	30M-18G	Feb. 13, 2019	Apr. 08, 2019 ~ Apr. 11, 2019	Feb. 12, 2020	Radiation (03CH13-HY)
RF Cable	HUBER + SUHNER	SUCOFLEX 104	804793/4	30M-18G	Feb. 13, 2019	Apr. 08, 2019 ~ Apr. 11, 2019	Feb. 12, 2020	Radiation (03CH13-HY)
RF Cable	HUBER + SUHNER	SUCOFLEX 104	MY24961/4	30M-18G	Feb. 13, 2019	Apr. 08, 2019 ~ Apr. 11, 2019	Feb. 12, 2020	Radiation (03CH13-HY)
RF Cable	HUBER + SUHNER	SUCOFLEX 102	MY2859/2	30M~40GHz	Mar. 13, 2019	Apr. 08, 2019 ~ Apr. 11, 2019	Mar. 12, 2020	Radiation (03CH13-HY)
RF Cable	HUBER + SUHNER	SUCOFLEX 102	MY4274/2	30M~40GHz	Mar. 13, 2019	Apr. 08, 2019 ~ Apr. 11, 2019	Mar. 12, 2020	Radiation (03CH13-HY)
Spectrum Analyzer	Agilent	N9010A	MY55370526	10Hz~44GHz	Mar. 19, 2019	Apr. 08, 2019 ~ Apr. 11, 2019	Mar. 18, 2020	Radiation (03CH13-HY)
Antenna Mast	EMEC	AM-BS-4500-B	N/A	1m~4m	N/A	Apr. 08, 2019 ~ Apr. 11, 2019	N/A	Radiation (03CH13-HY)
Turn Table	EMEC	TT2000	N/A	0~360 Degree	N/A	Apr. 08, 2019 ~ Apr. 11, 2019	N/A	Radiation (03CH13-HY)
Software	AUDIX	E3 6.2009-8-24c	RK-001124	N/A	N/A	Apr. 08, 2019 ~ Apr. 11, 2019	N/A	Radiation (03CH13-HY)
EMI Test Receiver	Keysight	N9038A(MXE)	MY54130085	20Hz ~ 8.4GHz	Nov. 01, 2018	Apr. 08, 2019 ~ Apr. 11, 2019	Oct. 31, 2019	Radiation (03CH13-HY)
Filter	Woken	WHKX8-5272. 5-6750-18000 -40ST	SN5	6.75G Highpass	Mar.13, 2019	Apr. 08, 2019 ~ Apr. 11, 2019	Mar. 12, 2020	Radiation (03CH13-HY)
Filter	Wainwright	WHKX12-108 0-1200-15000 -60ST	SN3	1.2G Low Pass	Jul. 05, 2018	Apr. 08, 2019 ~ Apr. 11, 2019	Jul. 04, 2019	Radiation (03CH13-HY)



Instrument	Manufacturer	Model No.	Serial No.	Characteristics	Calibration Date	Test Date	Due Date	Remark
Power Sensor	DARE	RPR3006W	13I00030S NO32	9kHz~6GHz	Dec. 03, 2018	May 03, 2019~ Jun. 14, 2019	Dec. 02, 2019	Conducted (TH05-HY)
Signal Analyzer	Rohde & Schwarz	FSV40	101397	10Hz~40GHz	Nov. 13, 2018	May 03, 2019~ Jun. 14, 2019	Nov. 12, 2019	Conducted (TH05-HY)
Switch Box & RF Cable	Burgeon	ETF-058	EC120838 2	N/A	Mar. 27, 2019	May 03, 2019~ Jun. 14, 2019	Mar. 26, 2020	Conducted (TH05-HY)
AC Power Source	ChainTek	APC-1000W	N/A	N/A	N/A	May 21, 2019	N/A	Conduction (CO05-HY)
EMI Test Receiver	Rohde & Schwarz	ESR3	102388	9KHz~3.6GHz	Nov. 12, 2018	May 21, 2019	Nov. 11, 2019	Conduction (CO05-HY)
LISN	Rohde & Schwarz	ENV216	100080	9kHz~30MHz	Nov. 14, 2018	May 21, 2019	Nov. 13, 2019	Conduction (CO05-HY)
LISN	Rohde & Schwarz	ENV216	100081	9kHz~30MHz	Nov. 09, 2018	May 21, 2019	Nov. 08, 2019	Conduction (CO05-HY)
Software	Rohde & Schwarz	EMC32 V10.30	N/A	N/A	N/A	May 21, 2019	N/A	Conduction (CO05-HY)
LF Cable	HUBER + SUHNER	RG-214/U	LF01	N/A	Dec. 31, 2018	May 21, 2019	Dec. 30, 2019	Conduction (CO05-HY)
Pulse Limiter	Rohde & Schwarz	ESH3-Z2	100851	N/A	Dec. 31, 2018	May 21, 2019	Dec. 30, 2019	Conduction (CO05-HY)



## 5 Uncertainty of Evaluation

### Uncertainty of Conducted Emission Measurement (150kHz ~ 30MHz)

Measuring Uncertainty for a Level of Confidence of 95% ( $U = 2Uc(y)$ )	2.2dB
---	-------

### Uncertainty of Radiated Emission Measurement (30 MHz ~ 1000 MHz)

Measuring Uncertainty for a Level of Confidence of 95% ( $U = 2Uc(y)$ )	4.9dB
---	-------

### Uncertainty of Radiated Emission Measurement (1000 MHz ~ 18000 MHz)

Measuring Uncertainty for a Level of Confidence of 95% ( $U = 2Uc(y)$ )	5.4dB
---	-------

### Uncertainty of Radiated Emission Measurement (18000 MHz ~ 40000 MHz)

Measuring Uncertainty for a Level of Confidence of 95% ( $U = 2Uc(y)$ )	4.3dB
---	-------

**Appendix A. Test Result of Conducted Test Items**

Test Engineer:	Leo Li	Temperature:	21~25	°C
Test Date:	2019/5/3~2019/6/14	Relative Humidity:	51~54	%

**TEST RESULTS DATA**  
**26dB and 99% OBW**

Band I													
Mod.	Data Rate	NTX	CH.	Freq. (MHz)	99% Bandwidth (MHz)		26 dB Bandwidth (MHz)		IC 99% Bandwidth Power Limit (dBm)		IC 99% Bandwidth EIRP Limit (dBm)		Note
					Ant 1	Ant 2	Ant 1	Ant 2	Ant 1	Ant 2	Ant 1	Ant 2	
11a	6Mbps	2	36	5180	16.78	16.73	24.68	24.78	-	-	22.24	22.24	
11a	6Mbps	2	44	5220	16.88	16.73	25.42	25.12	-	-	22.24	22.24	
11a	6Mbps	2	48	5240	16.83	16.73	25.17	25.57	-	-	22.24	22.24	
HT20	MCS0	2	36	5180	17.98	17.98	26.97	26.17	-	-	22.55	22.55	
HT20	MCS0	2	44	5220	17.98	18.03	26.32	27.37	-	-	22.55	22.55	
HT20	MCS0	2	48	5240	18.03	17.98	26.37	27.47	-	-	22.55	22.55	
HT40	MCS0	2	38	5190	36.66	36.46	41.90	42.08	-	-	23.01	23.01	
HT40	MCS0	2	46	5230	36.76	36.46	42.53	42.62	-	-	23.01	23.01	
VHT80	MCS0	2	42	5210	76.00	76.12	84.08	82.48	-	-	23.01	23.01	

**TEST RESULTS DATA**  
**Average Power Table**

FCC Band I												
Mod.	Data Rate	NTX	CH.	Freq. (MHz)	Average Conducted Power (dBm)			FCC Conducted Power Limit (dBm)		DG (dBi)		Pass/Fail
					Ant 1	Ant 2	SUM	Ant 1	Ant 2	Ant 1	Ant 2	
11a	6Mbps	2	36	5180	19.60	19.30	22.46	24.00		1.38	Pass	
11a	6Mbps	2	44	5220	19.50	19.10	22.31	24.00		1.38	Pass	
11a	6Mbps	2	48	5240	19.50	19.00	22.27	24.00		1.38	Pass	
HT20	MCS0	2	36	5180	19.60	19.10	22.37	24.00		1.38	Pass	
HT20	MCS0	2	44	5220	19.50	18.90	22.22	24.00		1.38	Pass	
HT20	MCS0	2	48	5240	19.40	18.80	22.12	24.00		1.38	Pass	
HT40	MCS0	2	38	5190	16.30	15.80	19.07	24.00		1.38	Pass	
HT40	MCS0	2	46	5230	19.90	19.30	22.62	24.00		1.38	Pass	
VHT20	MCS0	2	36	5180	19.50	19.00	22.27	24.00		1.38	Pass	
VHT20	MCS0	2	44	5220	19.40	18.80	22.12	24.00		1.38	Pass	
VHT20	MCS0	2	48	5240	19.30	18.70	22.02	24.00		1.38	Pass	
VHT40	MCS0	2	38	5190	16.20	15.70	18.97	24.00		1.38	Pass	
VHT40	MCS0	2	46	5230	19.60	19.10	22.37	24.00		1.38	Pass	
VHT80	MCS0	2	42	5210	15.70	15.10	18.42	24.00		1.38	Pass	



***TEST RESULTS DATA***  
***Power Spectral Density***

FCC Band 1														
Mod.	Data Rate	N <sub>TX</sub>	CH.	Freq. (MHz)	Duty Factor (dB)		Average Power Density (dBm/MHz)			Average PSD Limit (dBm/MHz)		DG (dBi)		Pass /Fail
					Ant 1	Ant 2	Ant 1	Ant 2	SUM	Ant 1	Ant 2	Ant 1	Ant 2	
11a	6Mbps	2	36	5180	0.08	0.08			10.87	11.00	4.11		Pass	
11a	6Mbps	2	44	5220	0.08	0.08			10.94	11.00	4.11		Pass	
11a	6Mbps	2	48	5240	0.08	0.08			10.82	11.00	4.11		Pass	
HT20	MCS0	2	36	5180	0.09	0.09			10.83	11.00	4.11		Pass	
HT20	MCS0	2	44	5220	0.09	0.09			10.95	11.00	4.11		Pass	
HT20	MCS0	2	48	5240	0.09	0.09			10.74	11.00	4.11		Pass	
HT40	MCS0	2	38	5190	0.17	0.17			4.54	11.00	4.11		Pass	
HT40	MCS0	2	46	5230	0.17	0.17			7.99	11.00	4.11		Pass	
VHT80	MCS0	2	42	5210	0.20	0.20			0.62	11.00	4.11		Pass	

**TEST RESULTS DATA**  
**26dB and 99% OBW**

Band II															
Mod.	Data Rate	NTX	CH.	Freq. (MHz)	99% Bandwidth (MHz)		26 dB Bandwidth (MHz)		IC 99% Bandwidth Power Limit (dBm)		IC 99% Bandwidth EIRP Limit (dBm)		FCC 26dB Bandwidth Power Limit (dBm)		Note
					Ant 1	Ant 2	Ant 1	Ant 2	Ant 1	Ant 2	Ant 1	Ant 2	Ant 1	Ant 2	
11a	6Mbps	2	52	5260	16.83	16.73	25.22	25.27	23.24		29.24		23.98		
11a	6Mbps	2	60	5300	16.93	16.73	25.42	25.03	23.24		29.24		23.98		
11a	6Mbps	2	64	5320	16.88	16.73	25.42	24.88	23.24		29.24		23.98		
HT20	MCS0	2	52	5260	17.98	18.08	27.12	25.82	23.55		29.55		23.98		
HT20	MCS0	2	60	5300	17.98	17.93	25.82	25.67	23.54		29.54		23.98		
HT20	MCS0	2	64	5320	18.03	17.93	26.37	25.32	23.54		29.54		23.98		
HT40	MCS0	2	54	5270	36.76	36.46	41.81	42.44	23.98		30.00		23.98		
HT40	MCS0	2	62	5310	36.66	36.46	41.63	41.90	23.98		30.00		23.98		
VHT80	MCS0	2	58	5290	76.24	76.00	83.28	84.40	23.98		30.00		23.98		

**TEST RESULTS DATA**  
**Average Power Table**

FCC Band II													
Mod.	Data Rate	NTX	CH.	Freq. (MHz)	Average Conducted Power (dBm)			FCC Conducted Power Limit (dBm)		DG (dBi)		EIRP Power Limit (dBm)	Pass/Fail
					Ant 1	Ant 2	SUM	Ant 1	Ant 2	Ant 1	Ant 2		
11a	6Mbps	2	52	5260	19.40	18.80	22.12	23.98		1.81		30	Pass
11a	6Mbps	2	60	5300	19.50	18.70	22.13	23.98		1.81		30	Pass
11a	6Mbps	2	64	5320	19.20	18.40	21.83	23.98		1.81		30	Pass
HT20	MCS0	2	52	5260	19.30	18.70	22.02	23.98		1.81		30	Pass
HT20	MCS0	2	60	5300	19.40	18.60	22.03	23.98		1.81		30	Pass
HT20	MCS0	2	64	5320	19.10	18.30	21.73	23.98		1.81		30	Pass
HT40	MCS0	2	54	5270	19.80	19.00	22.43	23.98		1.81		30	Pass
HT40	MCS0	2	62	5310	15.00	14.10	17.58	23.98		1.81		30	Pass
VHT20	MCS0	2	52	5260	19.10	18.60	21.87	23.98		1.81		30	Pass
VHT20	MCS0	2	60	5300	19.30	18.50	21.93	23.98		1.81		30	Pass
VHT20	MCS0	2	64	5320	19.00	18.20	21.63	23.98		1.81		30	Pass
VHT40	MCS0	2	54	5270	19.50	18.90	22.22	23.98		1.81		30	Pass
VHT40	MCS0	2	62	5310	14.90	14.00	17.48	23.98		1.81		30	Pass
VHT80	MCS0	2	58	5290	13.80	13.10	16.47	23.98		1.81		30	Pass

**TEST RESULTS DATA**  
**Power Spectral Density**

Band II														
Mod.	Data Rate	N <sub>TX</sub>	CH.	Freq. (MHz)	Duty Factor (dB)		Average Power Density (dBm/MHz)			Average PSD Limit (dBm/MHz)		DG (dBi)		Pass /Fail
					Ant 1	Ant 2	Ant 1	Ant 2	SUM	Ant 1	Ant 2	Ant 1	Ant 2	
11a	6Mbps	2	52	5260	0.08	0.08			10.75	11.00		4.51		Pass
11a	6Mbps	2	60	5300	0.08	0.08			10.99	11.00		4.51		Pass
11a	6Mbps	2	64	5320	0.08	0.08			10.81	11.00		4.51		Pass
HT20	MCS0	2	52	5260	0.09	0.09			10.69	11.00		4.51		Pass
HT20	MCS0	2	60	5300	0.09	0.09			10.89	11.00		4.51		Pass
HT20	MCS0	2	64	5320	0.09	0.09			10.81	11.00		4.51		Pass
HT40	MCS0	2	54	5270	0.17	0.17			7.84	11.00		4.51		Pass
HT40	MCS0	2	62	5310	0.17	0.17			3.52	11.00		4.51		Pass
VHT80	MCS0	2	58	5290	0.20	0.20			-0.99	11.00		4.51		Pass

**TEST RESULTS DATA**  
**26dB and 99% OBW**

Band III																
Mod.	Data Rate	NTX	CH.	Freq. (MHz)	99% Bandwidth In U-NII 2C (MHz)		26 dB Bandwidth In U-NII 2C (MHz)		IC 99% Bandwidth Power Limit (dBm)		IC 99% Bandwidth EIRP Limit (dBm)		FCC 26dB Bandwidth Power Limit (dBm)		6 dB Bandwidth for Straddle Channel (MHz)	
					Ant 1	Ant 2	Ant 1	Ant 2	Ant 1	Ant 2	Ant 1	Ant 2	Ant 1	Ant 2	Ant 1	Ant 2
11a	6Mbps	2	100	5500	16.88	16.68	25.03	24.63	23.22	29.22	23.98	----	----			
11a	6Mbps	2	116	5580	16.88	16.68	25.22	24.68	23.22	29.22	23.98	----	----			
11a	6Mbps	2	140	5700	16.93	16.73	25.77	24.93	23.24	29.24	23.98	----	----			
11a	6Mbps	2	144	5720	13.39	13.34	17.74	17.14	22.25	28.25	23.34	2.742	3.142			
HT20	MCS0	2	100	5500	18.03	17.93	27.47	25.47	23.54	29.54	23.98	----	----			
HT20	MCS0	2	116	5580	18.03	17.93	26.92	25.62	23.54	29.54	23.98	----	----			
HT20	MCS0	2	140	5700	18.03	17.93	27.32	25.27	23.54	29.54	23.98	----	----			
HT20	MCS0	2	144	5720	13.99	13.94	18.14	17.54	22.44	28.44	23.44	3.341	3.141			
HT40	MCS0	2	102	5510	36.66	36.56	41.90	42.08	23.98	30.00	23.98	----	----			
HT40	MCS0	2	110	5550	36.66	36.76	42.26	42.35	23.98	30.00	23.98	----	----			
HT40	MCS0	2	134	5670	36.66	36.56	42.53	42.17	23.98	30.00	23.98	----	----			
HT40	MCS0	2	142	5710	33.28	33.28	36.31	36.04	23.98	30.00	23.98	2.528	2.528			
VHT80	MCS0	2	106	5530	76.12	76.12	83.28	83.12	23.98	30.00	23.98	----	----			
VHT80	MCS0	2	122	5610	76.24	76.24	83.76	83.92	23.98	30.00	23.98	----	----			
VHT80	MCS0	2	138	5690	73.12	72.88	77.20	76.88	23.98	30.00	23.98	2.565	2.565			

**TEST RESULTS DATA**  
**Average Power Table**

FCC Band III													
Mod.	Data Rate	NTX	CH.	Freq. (MHz)	Average Conducted Power (dBm)			FCC Conducted Power Limit (dBm)		DG (dBi)		EIRP Power Limit (dBm)	Pass/Fail
					Ant 1	Ant 2	SUM	Ant 1	Ant 2	Ant 1	Ant 2		
11a	6Mbps	2	100	5500	19.20	19.10	22.16	23.98	23.98	2.40	30	Pass	
11a	6Mbps	2	116	5580	19.10	18.80	21.96	23.98	23.98	2.40	30	Pass	
11a	6Mbps	2	140	5700	19.60	19.00	22.32	23.98	23.98	2.40	30	Pass	
11a	6Mbps	2	144	5720	19.40	18.70	22.07	23.98	23.98	2.40	30	Pass	
HT20	MCS0	2	100	5500	19.50	19.10	22.31	23.98	23.98	2.40	30	Pass	
HT20	MCS0	2	116	5580	19.30	18.90	22.11	23.98	23.98	2.40	30	Pass	
HT20	MCS0	2	140	5700	19.30	18.70	22.02	23.98	23.98	2.40	30	Pass	
HT20	MCS0	2	144	5720	19.20	18.40	21.83	23.98	23.98	2.40	30	Pass	
HT40	MCS0	2	102	5510	18.80	18.70	21.76	23.98	23.98	2.40	30	Pass	
HT40	MCS0	2	110	5550	20.30	20.10	23.21	23.98	23.98	2.40	30	Pass	
HT40	MCS0	2	134	5670	19.80	19.30	22.57	23.98	23.98	2.40	30	Pass	
HT40	MCS0	2	142	5710	19.70	19.20	22.47	23.98	23.98	2.40	30	Pass	
VHT20	MCS0	2	100	5500	19.40	19.00	22.21	23.98	23.98	2.40	30	Pass	
VHT20	MCS0	2	116	5580	19.20	19.00	22.11	23.98	23.98	2.40	30	Pass	
VHT20	MCS0	2	140	5700	19.20	18.80	22.01	23.98	23.98	2.40	30	Pass	
VHT20	MCS0	2	144	5720	19.10	18.50	21.82	23.98	23.98	2.40	30	Pass	
VHT40	MCS0	2	102	5510	18.70	18.60	21.66	23.98	23.98	2.40	30	Pass	
VHT40	MCS0	2	110	5550	20.20	20.00	23.11	23.98	23.98	2.40	30	Pass	
VHT40	MCS0	2	134	5670	19.70	19.20	22.47	23.98	23.98	2.40	30	Pass	
VHT40	MCS0	2	142	5710	19.60	19.10	22.37	23.98	23.98	2.40	30	Pass	
VHT80	MCS0	2	106	5530	18.10	17.80	20.96	23.98	23.98	2.40	30	Pass	
VHT80	MCS0	2	122	5610	19.20	19.00	22.11	23.98	23.98	2.40	30	Pass	
VHT80	MCS0	2	138	5690	19.10	18.90	22.01	23.98	23.98	2.40	30	Pass	

**TEST RESULTS DATA**  
**Power Spectral Density**

Band III														
Mod.	Data Rate	NTX	CH.	Freq. (MHz)	Duty Factor (dB)		Average Power Density (dBm/MHz)			Average PSD Limit (dBm/MHz)		DG (dBi)		Pass /Fail
					Ant 1	Ant 2	Ant 1	Ant 2	SUM	Ant 1	Ant 2	Ant 1	Ant 2	
11a	6Mbps	2	100	5500	0.08	0.08			10.96	11.00	5.08		Pass	
11a	6Mbps	2	116	5580	0.08	0.08			10.69	11.00	5.08		Pass	
11a	6Mbps	2	140	5700	0.08	0.08			10.99	11.00	5.08		Pass	
11a	6Mbps	2	144	5720	0.08	0.08			10.92	11.00	5.08		Pass	
HT20	MCS0	2	100	5500	0.09	0.09			10.87	11.00	5.08		Pass	
HT20	MCS0	2	116	5580	0.09	0.09			10.64	11.00	5.08		Pass	
HT20	MCS0	2	140	5700	0.09	0.09			10.43	11.00	5.08		Pass	
HT20	MCS0	2	144	5720	0.09	0.09			10.35	11.00	5.08		Pass	
HT40	MCS0	2	102	5510	0.17	0.17			7.47	11.00	5.08		Pass	
HT40	MCS0	2	110	5550	0.17	0.17			8.59	11.00	5.08		Pass	
HT40	MCS0	2	134	5670	0.17	0.17			8.06	11.00	5.08		Pass	
HT40	MCS0	2	142	5710	0.17	0.17			7.95	11.00	5.08		Pass	
VHT80	MCS0	2	106	5530	0.20	0.20			2.99	11.00	5.08		Pass	
VHT80	MCS0	2	122	5610	0.20	0.20			4.51	11.00	5.08		Pass	
VHT80	MCS0	2	138	5690	0.20	0.20			4.54	11.00	5.08		Pass	



## Appendix B. AC Conducted Emission Test Results

Test Engineer :	Eric Jeng	Temperature :	22~25°C
		Relative Humidity :	52~55%
Test Voltage :	120Vac / 60Hz	Phase :	Line

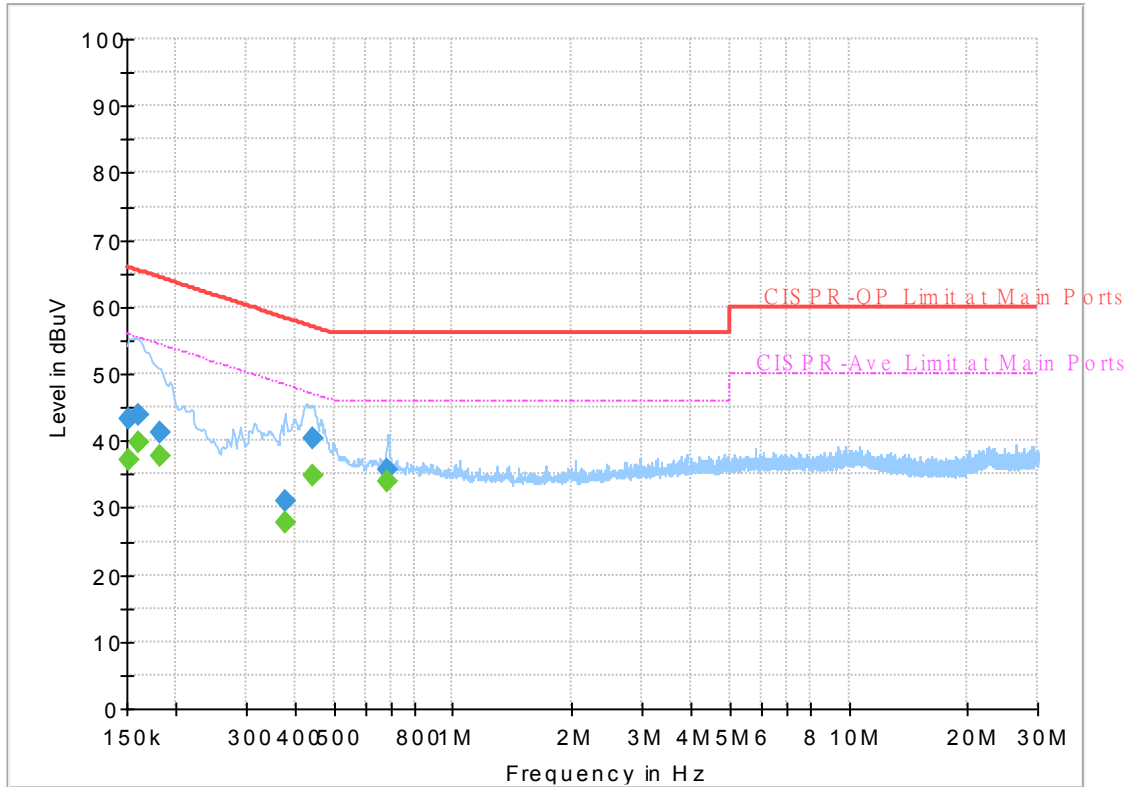

Frequency	QuasiPeak	CAverage	Limit	Margin	Line	Filter	Corr.
0.152250	---	37.19	55.88	18.69	L1	OFF	19.5
0.152250	43.16	---	65.88	22.72	L1	OFF	19.5
0.161250	---	39.70	55.40	15.70	L1	OFF	19.5
0.161250	43.97	---	65.40	21.43	L1	OFF	19.5
0.181500	---	37.73	54.42	16.69	L1	OFF	19.5
0.181500	41.35	---	64.42	23.07	L1	OFF	19.5
0.377250	---	27.82	48.34	20.52	L1	OFF	19.5
0.377250	31.09	---	58.34	27.25	L1	OFF	19.5
0.442500	---	34.90	47.02	12.12	L1	OFF	19.5
0.442500	40.33	---	57.02	16.69	L1	OFF	19.5
0.683250	---	33.82	46.00	12.18	L1	OFF	19.6
0.683250	35.56	---	56.00	20.44	L1	OFF	19.6





Test Engineer :	Eric Jeng	Temperature :	22~25°C
		Relative Humidity :	52~55%
Test Voltage :	120Vac / 60Hz	Phase :	Neutral

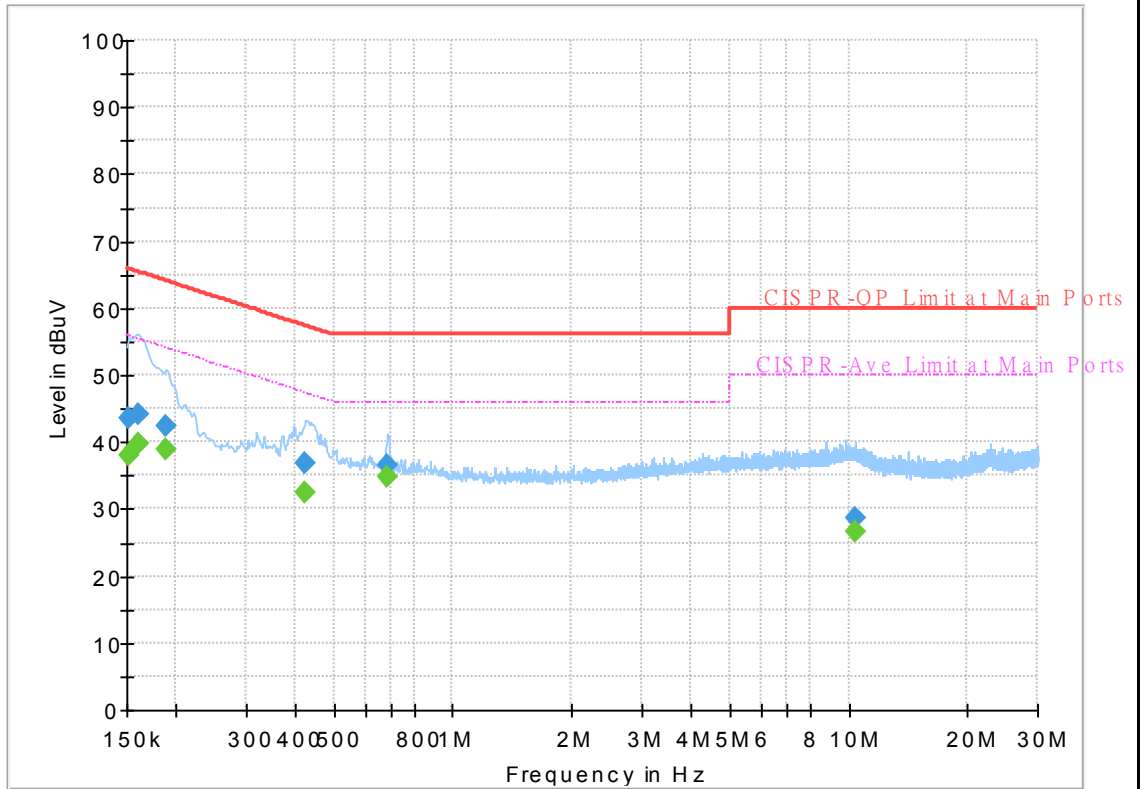

Final Result

Frequency	QuasiPeak	CAverage	Limit	Margin	Line	Filter	Corr.
0.152250	---	38.06	55.88	17.82	N	OFF	19.5
0.152250	43.47	---	65.88	22.41	N	OFF	19.5
0.161250	---	39.74	55.40	15.66	N	OFF	19.5
0.161250	44.05	---	65.40	21.35	N	OFF	19.5
0.188250	---	38.85	54.11	15.26	N	OFF	19.5
0.188250	42.31	---	64.11	21.80	N	OFF	19.5
0.424500	---	32.48	47.36	14.88	N	OFF	19.5
0.424500	36.75	---	57.36	20.61	N	OFF	19.5
0.685500	---	34.92	46.00	11.08	N	OFF	19.6
0.685500	36.59	---	56.00	19.41	N	OFF	19.6
10.367250	---	26.63	50.00	23.37	N	OFF	19.9
10.367250	28.58	---	60.00	31.42	N	OFF	19.9



### Appendix C. Radiated Spurious Emission

Test Engineer :	Alex Jheng, JC Liang, Wilson Wu	Temperature :	20~24°C
		Relative Humidity :	50~55%

**Band 1 - 5150~5250MHz**  
**WIFI 802.11a (Band Edge @ 3m)**

WIFI Ant.	Note	Frequency	Level	Over Limit	Limit Line	Read Level	Antenna Factor	Path Loss	Preamp Factor	Ant Pos	Table Pos	Peak Avg.	Pol.
1+2		( MHz )	( dBμV/m )	( dB )	( dBμV/m )	( dBμV )	( dB/m )	( dB )	( dB )	( cm )	( deg )	( P/A )	( H/V )
802.11a CH 36 5180MHz		5149.24	55.85	-18.15	74	47.57	31.69	6.08	29.49	262	305	P	H
		5149.5	47.35	-6.65	54	39.07	31.69	6.08	29.49	262	305	A	H
	*	5180	115.52	-	-	107.2	31.71	6.1	29.49	262	305	P	H
	*	5180	107.47	-	-	99.15	31.71	6.1	29.49	262	305	A	H
		5149.5	53.43	-20.57	74	45.15	31.69	6.08	29.49	302	5	P	V
		5147.68	44.58	-9.42	54	36.3	31.69	6.08	29.49	302	5	A	V
	*	5180	113.66	-	-	105.34	31.71	6.1	29.49	302	5	P	V
	*	5180	105.25	-	-	96.93	31.71	6.1	29.49	302	5	A	V
802.11a CH 44 5220MHz		5142.74	50.58	-23.42	74	42.3	31.69	6.08	29.49	261	305	P	H
		5150	42.51	-11.49	54	34.23	31.69	6.08	29.49	261	305	A	H
	*	5220	115.77	-	-	107.43	31.73	6.11	29.5	261	305	P	H
	*	5220	107.8	-	-	99.46	31.73	6.11	29.5	261	305	A	H
		5355	50.87	-23.13	74	42.46	31.81	6.12	29.52	261	305	P	H
		5452.72	42.49	-11.51	54	33.99	31.87	6.17	29.54	261	305	A	H
		5078	50.43	-23.57	74	42.21	31.65	6.04	29.47	298	6	P	V
		5150	40.32	-13.68	54	32.04	31.69	6.08	29.49	298	6	A	V
	*	5220	112.88	-	-	104.54	31.73	6.11	29.5	298	6	P	V
	*	5220	105.04	-	-	96.7	31.73	6.11	29.5	298	6	A	V
		5361.16	49.29	-24.71	74	40.88	31.82	6.12	29.53	298	6	P	V
		5452.44	39.49	-14.51	54	30.99	31.87	6.17	29.54	298	6	A	V



<b>802.11a CH 48 5240MHz</b>		5147.16	50.4	-23.6	74	42.12	31.69	6.08	29.49	265	306	P	H
		5150	41.05	-12.95	54	32.77	31.69	6.08	29.49	265	306	A	H
	*	5240	116.16	-	-	107.81	31.74	6.11	29.5	265	306	P	H
	*	5240	108.13	-	-	99.78	31.74	6.11	29.5	265	306	A	H
		5384.12	51.53	-22.47	74	43.11	31.83	6.12	29.53	265	306	P	H
		5350.24	42.66	-11.34	54	34.25	31.81	6.12	29.52	265	306	A	H
		5126.1	49.75	-24.25	74	41.48	31.68	6.07	29.48	394	12	P	V
		5149.76	39.41	-14.59	54	31.13	31.69	6.08	29.49	394	12	A	V
	*	5240	112.72	-	-	104.37	31.74	6.11	29.5	394	12	P	V
	*	5240	104.9	-	-	96.55	31.74	6.11	29.5	394	12	A	V
		5365.36	49.38	-24.62	74	40.97	31.82	6.12	29.53	394	12	P	V
		5350.52	39.45	-14.55	54	31.04	31.81	6.12	29.52	394	12	A	V
<b>Remark</b>	1. No other spurious found. 2. All results are PASS against Peak and Average limit line.												



**Band 1 5150~5250MHz**

**WIFI 802.11a (Harmonic @ 3m)**

WIFI Ant. 1+2	Note	Frequency ( MHz )	Level ( dBμV/m )	Over Limit ( dB )	Limit Line ( dBμV/m )	Read Level (dBμV)	Antenna Factor ( dB/m )	Path Loss ( dB )	Preamp Factor ( dB )	Ant Pos ( cm )	Table Pos ( deg )	Peak Avg. (P/A)	Pol. (H/V)
802.11a CH 36 5180MHz		10360	47.31	-20.89	68.2	54.6	39.76	9.91	56.96	100	0	P	H
		15540	44.59	-29.41	74	49.97	38.62	12.65	56.65	100	0	P	H
		10360	46.13	-22.07	68.2	53.42	39.76	9.91	56.96	100	0	P	V
		15540	46.08	-27.92	74	51.46	38.62	12.65	56.65	100	0	P	V
802.11a CH 44 5220MHz		10440	47.11	-21.09	68.2	54.2	39.88	9.95	56.92	100	0	P	H
		15660	44.19	-29.81	74	49.65	38.33	12.72	56.51	100	0	P	H
		10440	46.93	-21.27	68.2	54.02	39.88	9.95	56.92	100	0	P	V
		15660	44.67	-29.33	74	50.13	38.33	12.72	56.51	100	0	P	V
802.11a CH 48 5240MHz		10480	47.22	-20.98	68.2	54.19	39.97	9.97	56.91	100	0	P	H
		15720	44.63	-29.37	74	50.17	38.16	12.74	56.44	100	0	P	H
		10480	46.86	-21.34	68.2	53.83	39.97	9.97	56.91	100	0	P	V
		15720	44.6	-29.4	74	50.14	38.16	12.74	56.44	100	0	P	V
<b>Remark</b>	1. No other spurious found. 2. All results are PASS against Peak and Average limit line.												



**Band 1 5150~5250MHz  
WIFI 802.11n HT20 (Band Edge @ 3m)**

WIFI Ant. 1+2	Note	Frequency ( MHz )	Level ( dBμV/m )	Over Limit ( dB )	Limit Line ( dBμV/m )	Read Level (dBμV)	Antenna Factor ( dB/m )	Path Loss ( dB )	Preamp Factor ( dB )	Ant Pos ( cm )	Table Pos ( deg )	Peak Avg. (P/A)	Pol. (H/V)
802.11n HT20 CH 36 5180MHz		5150	56.51	-17.49	74	48.23	31.69	6.08	29.49	100	84	P	H
		5150	48.18	-5.82	54	39.9	31.69	6.08	29.49	100	84	A	H
	*	5180	115.25	-	-	106.93	31.71	6.1	29.49	100	84	P	H
	*	5180	107.33	-	-	99.01	31.71	6.1	29.49	100	84	A	H
		5148.98	53.58	-20.42	74	45.3	31.69	6.08	29.49	382	15	P	V
		5150	45.3	-8.7	54	37.02	31.69	6.08	29.49	382	15	A	V
	*	5180	114.25	-	-	105.93	31.71	6.1	29.49	382	15	P	V
	*	5180	106.13	-	-	97.81	31.71	6.1	29.49	382	15	A	V
802.11n HT20 CH 44 5220MHz		5143.78	50.43	-23.57	74	42.15	31.69	6.08	29.49	103	83	P	H
		5149.76	41.86	-12.14	54	33.58	31.69	6.08	29.49	103	83	A	H
	*	5220	115.27	-	-	106.93	31.73	6.11	29.5	103	83	P	H
	*	5220	106.88	-	-	98.54	31.73	6.11	29.5	103	83	A	H
		5362.56	50.13	-23.87	74	41.72	31.82	6.12	29.53	103	83	P	H
		5453	40.07	-13.93	54	31.57	31.87	6.17	29.54	103	83	A	H
		5081.12	49.32	-24.68	74	41.1	31.65	6.04	29.47	399	15	P	V
		5149.76	39.88	-14.12	54	31.6	31.69	6.08	29.49	399	15	A	V
	*	5220	115.17	-	-	106.83	31.73	6.11	29.5	399	15	P	V
	*	5220	106.57	-	-	98.23	31.73	6.11	29.5	399	15	A	V
		5414.92	49.2	-24.8	74	40.75	31.85	6.13	29.53	399	15	P	V
	5354.44	39.96	-14.04	54	31.55	31.81	6.12	29.52	399	15	A	V	



<b>802.11n</b>  <b>HT20</b>  <b>CH 48</b>  <b>5240MHz</b>		5147.22	50.94	-23.06	74	42.66	31.69	6.08	29.49	100	60	P	H
		5149.94	41.07	-12.93	54	32.79	31.69	6.08	29.49	100	60	A	H
	*	5240	116.36	-	-	108.01	31.74	6.11	29.5	100	60	P	H
	*	5240	107.96	-	-	99.61	31.74	6.11	29.5	100	60	A	H
		5354.4	49.9	-24.1	74	41.49	31.81	6.12	29.52	100	60	P	H
		5350.08	41.54	-12.46	54	33.13	31.81	6.12	29.52	100	60	A	H
		5045.9	50.36	-23.64	74	42.17	31.63	6.03	29.47	140	22	P	V
		5149.26	40.15	-13.85	54	31.87	31.69	6.08	29.49	140	22	A	V
	*	5240	113.42	-	-	105.07	31.74	6.11	29.5	140	22	P	V
	*	5240	105.73	-	-	97.38	31.74	6.11	29.5	140	22	A	V
		5356.56	48.56	-25.44	74	40.15	31.81	6.12	29.52	140	22	P	V
		5350.08	40.52	-13.48	54	32.11	31.81	6.12	29.52	140	22	A	V
<b>Remark</b>	1. No other spurious found. 2. All results are PASS against Peak and Average limit line.												



**Band 1 5150~5250MHz**  
**WIFI 802.11n HT20 (Harmonic @ 3m)**

WIFI Ant. 1+2	Note	Frequency ( MHz )	Level ( dBμV/m )	Over Limit ( dB )	Limit Line ( dBμV/m )	Read Level (dBμV)	Antenna Factor ( dB/m )	Path Loss ( dB )	Preamp Factor ( dB )	Ant Pos ( cm )	Table Pos ( deg )	Peak Avg. (P/A)	Pol. (H/V)
802.11n HT20 CH 36		10360	46.7	-21.5	68.2	53.99	39.76	9.91	56.96	100	0	P	H
		15540	44.3	-29.7	74	49.68	38.62	12.65	56.65	100	0	P	H
5180MHz		10360	46.33	-21.87	68.2	53.62	39.76	9.91	56.96	100	0	P	V
		15540	45	-29	74	50.38	38.62	12.65	56.65	100	0	P	V
802.11n HT20 CH 44		10440	46.29	-21.91	68.2	53.38	39.88	9.95	56.92	100	0	P	H
		15660	44.55	-29.45	74	50.01	38.33	12.72	56.51	100	0	P	H
		10440	48.8	-19.4	68.2	55.89	39.88	9.95	56.92	100	0	P	V
		15660	44.85	-29.15	74	50.31	38.33	12.72	56.51	100	0	P	V
802.11n HT20 CH 48		10480	46.54	-21.66	68.2	53.51	39.97	9.97	56.91	100	0	P	H
		15720	45.23	-28.77	74	50.77	38.16	12.74	56.44	100	0	P	H
		10480	46.98	-21.22	68.2	53.95	39.97	9.97	56.91	100	0	P	V
		15720	44.93	-29.07	74	50.47	38.16	12.74	56.44	100	0	P	V
<b>Remark</b>	1. No other spurious found. 2. All results are PASS against Peak and Average limit line.												



**Band 1 5150~5250MHz**  
**WIFI 802.11n HT40 (Band Edge @ 3m)**

WIFI Ant. 1+2	Note	Frequency ( MHz )	Level ( dBμV/m )	Over Limit ( dB )	Limit Line ( dBμV/m )	Read Level (dBμV)	Antenna Factor ( dB/m )	Path Loss ( dB )	Preamp Factor ( dB )	Ant Pos ( cm )	Table Pos ( deg )	Peak Avg. (P/A)	Pol. (H/V)
802.11n HT40 CH 38 5190MHz		5148.72	60.84	-13.16	74	52.56	31.69	6.08	29.49	100	82	P	H
		5149.76	52.7	-1.3	54	44.42	31.69	6.08	29.49	100	82	A	H
	*	5190	108.95	-	-	100.63	31.71	6.1	29.49	100	82	P	H
	*	5190	102.02	-	-	93.7	31.71	6.1	29.49	100	82	A	H
		5412.12	54.03	-19.97	74	45.58	31.85	6.13	29.53	100	82	P	H
		5412.68	47.12	-6.88	54	38.67	31.85	6.13	29.53	100	82	A	H
		5146.38	55.53	-18.47	74	47.25	31.69	6.08	29.49	283	13	P	V
		5150	49.44	-4.56	54	41.16	31.69	6.08	29.49	283	13	A	V
	*	5190	108.8	-	-	100.48	31.71	6.1	29.49	283	13	P	V
	*	5190	101.65	-	-	93.33	31.71	6.1	29.49	283	13	A	V
		5412.68	53.35	-20.65	74	44.9	31.85	6.13	29.53	283	13	P	V
		5412.4	47.03	-6.97	54	38.58	31.85	6.13	29.53	283	13	A	V
802.11n HT40 CH 46 5230MHz		5147.68	52.64	-21.36	74	44.36	31.69	6.08	29.49	107	81	P	H
		5150	45.69	-8.31	54	37.41	31.69	6.08	29.49	107	81	A	H
	*	5230	113.97	-	-	105.62	31.74	6.11	29.5	107	81	P	H
	*	5230	105.77	-	-	97.42	31.74	6.11	29.5	107	81	A	H
		5452.72	58.46	-15.54	74	49.96	31.87	6.17	29.54	107	81	P	H
		5452.44	51.09	-2.91	54	42.59	31.87	6.17	29.54	107	81	A	H
		5148.72	51.09	-22.91	74	42.81	31.69	6.08	29.49	387	13	P	V
		5150	43.38	-10.62	54	35.1	31.69	6.08	29.49	387	13	A	V
	*	5230	112.87	-	-	104.52	31.74	6.11	29.5	387	13	P	V
	*	5230	105.56	-	-	97.21	31.74	6.11	29.5	387	13	A	V
	5453.56	55.22	-18.78	74	46.72	31.87	6.17	29.54	387	13	P	V	
	5452.44	49.19	-4.81	54	40.69	31.87	6.17	29.54	387	13	A	V	
<b>Remark</b>	1. No other spurious found. 2. All results are PASS against Peak and Average limit line.												





Band 1 5150~5250MHz
WIFI 802.11n HT40 (Harmonic @ 3m)

Table with 14 columns: WIFI Ant. 1+2, Note, Frequency (MHz), Level (dBµV/m), Over Limit (dB), Limit Line (dBµV/m), Read Level (dBµV), Antenna Factor (dB/m), Path Loss (dB), Preamp Factor (dB), Ant Pos (cm), Table Pos (deg), Peak Avg. (P/A), Pol. (H/V). Rows include 802.11n HT40 CH 38 5190MHz and 802.11n HT40 CH 46 5230MHz. A Remark section at the bottom states: 1. No other spurious found. 2. All results are PASS against Peak and Average limit line.



**Band 1 5150~5250MHz**  
**WIFI 802.11ac VHT80 (Band Edge @ 3m)**

WIFI Ant. 1+2	Note	Frequency ( MHz )	Level ( dBμV/m )	Over Limit ( dB )	Limit Line ( dBμV/m )	Read Level (dBμV)	Antenna Factor ( dB/m )	Path Loss ( dB )	Preamp Factor ( dB )	Ant Pos ( cm )	Table Pos ( deg )	Peak Avg. (P/A)	Pol. (H/V)
802.11ac VHT80 CH 42 5210MHz		5148.46	57.71	-16.29	74	49.43	31.69	6.08	29.49	102	66	P	H
		5149.24	50.65	-3.35	54	42.37	31.69	6.08	29.49	102	66	A	H
	*	5210	105.69	-	-	97.35	31.73	6.11	29.5	102	66	P	H
	*	5210	98.76	-	-	90.42	31.73	6.11	29.5	102	66	A	H
		5371.24	49.04	-24.96	74	40.63	31.82	6.12	29.53	102	66	P	H
		5350.24	41.68	-12.32	54	33.27	31.81	6.12	29.52	102	66	A	H
		5138.58	53.31	-20.69	74	45.03	31.68	6.08	29.48	154	28	P	V
		5143.78	45.15	-8.85	54	36.87	31.69	6.08	29.49	154	28	A	V
	*	5210	103.37	-	-	95.03	31.73	6.11	29.5	154	28	P	V
	*	5210	95.92	-	-	87.58	31.73	6.11	29.5	154	28	A	V
	5426.12	49.53	-24.47	74	41.07	31.85	6.15	29.54	154	28	P	V	
	5354.72	41.2	-12.8	54	32.79	31.81	6.12	29.52	154	28	A	V	
<b>Remark</b>	1. No other spurious found. 2. All results are PASS against Peak and Average limit line.												



Band 1 5150~5250MHz

WIFI 802.11ac VHT80 (Harmonic @ 3m)

WIFI Ant. 1+2	Note	Frequency ( MHz )	Level ( dBμV/m )	Over Limit ( dB )	Limit Line ( dBμV/m )	Read Level (dBμV)	Antenna Factor ( dB/m )	Path Loss ( dB )	Preamp Factor ( dB )	Ant Pos ( cm )	Table Pos ( deg )	Peak Avg. (P/A)	Pol. (H/V)
802.11ac		10420	46.6	-21.6	68.2	53.74	39.85	9.94	56.93	100	0	P	H
VHT80		15630	45.81	-28.19	74	51.28	38.37	12.7	56.54	100	0	P	H
CH 42		10420	47.12	-21.08	68.2	54.26	39.85	9.94	56.93	100	0	P	V
5210MHz		15630	46.24	-27.76	74	51.71	38.37	12.7	56.54	100	0	P	V
<b>Remark</b>	1. No other spurious found. 2. All results are PASS against Peak and Average limit line.												



**Band 2 - 5250~5350MHz**  
**WIFI 802.11a (Band Edge @ 3m)**

WIFI	Note	Frequency	Level	Over	Limit	Read	Antenna	Path	Preamp	Ant	Table	Peak	Pol.
Ant.				Limit	Line	Level	Factor	Loss	Factor	Pos	Pos	Avg.	
1+2		( MHz )	( dBμV/m )	( dB )	( dBμV/m )	( dBμV )	( dB/m )	( dB )	( dB )	( cm )	( deg )	( P/A )	( H/V )
802.11a CH 52 5260MHz		5067.32	50.61	-23.39	74	42.4	31.64	6.04	29.47	257	306	P	H
		5144.84	39.92	-14.08	54	31.64	31.69	6.08	29.49	257	306	A	H
	*	5260	116.13	-	-	107.77	31.76	6.11	29.51	257	306	P	H
	*	5260	108.18	-	-	99.82	31.76	6.11	29.51	257	306	A	H
		5353.2	52.35	-21.65	74	43.94	31.81	6.12	29.52	257	306	P	H
		5350.08	43.55	-10.45	54	35.14	31.81	6.12	29.52	257	306	A	H
		5102	51.05	-22.95	74	42.81	31.66	6.06	29.48	391	2	P	V
		5149.94	39.29	-14.71	54	31.01	31.69	6.08	29.49	391	2	A	V
	*	5260	112.36	-	-	104	31.76	6.11	29.51	391	2	P	V
	*	5260	104.54	-	-	96.18	31.76	6.11	29.51	391	2	A	V
		5377.44	49.1	-24.9	74	40.69	31.82	6.12	29.53	391	2	P	V
		5350.08	39.52	-14.48	54	31.11	31.81	6.12	29.52	391	2	A	V
802.11a CH 60 5300MHz		5011.56	49.51	-24.49	74	41.35	31.61	6.01	29.46	266	307	P	H
		5145.86	39.36	-14.64	54	31.08	31.69	6.08	29.49	266	307	A	H
	*	5300	116.56	-	-	108.18	31.78	6.11	29.51	266	307	P	H
	*	5300	108.39	-	-	100.01	31.78	6.11	29.51	266	307	A	H
		5350.8	56.56	-17.44	74	48.15	31.81	6.12	29.52	266	307	P	H
		5350.32	46.99	-7.01	54	38.58	31.81	6.12	29.52	266	307	A	H
		5074.46	49.24	-24.76	74	41.02	31.65	6.04	29.47	385	11	P	V
		5057.12	39.2	-14.8	54	31	31.64	6.03	29.47	385	11	A	V
	*	5300	113.43	-	-	105.05	31.78	6.11	29.51	385	11	P	V
	*	5300	104.88	-	-	96.5	31.78	6.11	29.51	385	11	A	V
		5354.4	50.7	-23.3	74	42.29	31.81	6.12	29.52	385	11	P	V
		5350.08	42.4	-11.6	54	33.99	31.81	6.12	29.52	385	11	A	V



<b>802.11a</b> <b>CH 64</b> <b>5320MHz</b>	*	5320	116.31	-	-	107.92	31.79	6.12	29.52	264	306	P	H
	*	5320	108.42	-	-	100.03	31.79	6.12	29.52	264	306	A	H
		5352.32	57.54	-16.46	74	49.13	31.81	6.12	29.52	264	306	P	H
		5350.08	48.29	-5.71	54	39.88	31.81	6.12	29.52	264	306	A	H
	*	5320	114.36	-	-	105.97	31.79	6.12	29.52	381	10	P	V
	*	5320	106.48	-	-	98.09	31.79	6.12	29.52	381	10	A	V
		5357.92	53.62	-20.38	74	45.21	31.81	6.12	29.52	381	10	P	V
		5351.52	45.28	-8.72	54	36.87	31.81	6.12	29.52	381	10	A	V
<b>Remark</b>	1. No other spurious found. 2. All results are PASS against Peak and Average limit line.												



**Band 2 5250~5350MHz**

**WIFI 802.11a (Harmonic @ 3m)**

WIFI Ant. 1+2	Note	Frequency ( MHz )	Level ( dBμV/m )	Over Limit ( dB )	Limit Line ( dBμV/m )	Read Level (dBμV)	Antenna Factor ( dB/m )	Path Loss ( dB )	Preamp Factor ( dB )	Ant Pos ( cm )	Table Pos ( deg )	Peak Avg. (P/A)	Pol. (H/V)
802.11a CH 52 5260MHz		10520	48.06	-20.14	68.2	54.92	40.02	10	56.88	100	0	P	H
		15780	45.79	-28.21	74	51.33	38.04	12.78	56.36	100	0	P	H
		10520	47.66	-20.54	68.2	54.52	40.02	10	56.88	100	0	P	V
		15780	45.17	-28.83	74	50.71	38.04	12.78	56.36	100	0	P	V
802.11a CH 60 5300MHz		10600	46.89	-27.11	74	53.57	40.1	10.04	56.82	100	0	P	H
		15900	45.45	-28.55	74	51.08	37.75	12.84	56.22	100	0	P	H
		10600	48.64	-25.36	74	55.32	40.1	10.04	56.82	100	0	P	V
		15900	45.94	-28.06	74	51.57	37.75	12.84	56.22	100	0	P	V
802.11a CH 64 5320MHz		10640	47.73	-26.27	74	54.33	40.14	10.05	56.79	100	0	P	H
		15960	44.85	-29.15	74	50.55	37.58	12.87	56.15	100	0	P	H
		10640	48.34	-25.66	74	54.94	40.14	10.05	56.79	100	0	P	V
		15960	45.15	-28.85	74	50.85	37.58	12.87	56.15	100	0	P	V
<b>Remark</b>	1. No other spurious found. 2. All results are PASS against Peak and Average limit line.												



**Band 2 5250~5350MHz**  
**WIFI 802.11n HT20 (Band Edge @ 3m)**

WIFI Ant. 1+2	Note	Frequency ( MHz )	Level ( dBμV/m )	Over Limit ( dB )	Limit Line ( dBμV/m )	Read Level ( dBμV )	Antenna Factor ( dB/m )	Path Loss ( dB )	Preamp Factor ( dB )	Ant Pos ( cm )	Table Pos ( deg )	Peak Avg. ( P/A )	Pol. ( H/V )
802.11n HT20 CH 52 5260MHz		5120.36	50.32	-23.68	74	42.06	31.67	6.07	29.48	100	60	P	H
		5149.94	40.18	-13.82	54	31.9	31.69	6.08	29.49	100	60	A	H
	*	5260	115.24	-	-	106.88	31.76	6.11	29.51	100	60	P	H
	*	5260	107.49	-	-	99.13	31.76	6.11	29.51	100	60	A	H
		5350.08	50.75	-23.25	74	42.34	31.81	6.12	29.52	100	60	P	H
		5350.32	42.52	-11.48	54	34.11	31.81	6.12	29.52	100	60	A	H
		5015.64	50.16	-23.84	74	42	31.61	6.01	29.46	173	22	P	V
		5144.84	39.6	-14.4	54	31.32	31.69	6.08	29.49	173	22	A	V
	*	5260	114.34	-	-	105.98	31.76	6.11	29.51	173	22	P	V
	*	5260	105.8	-	-	97.44	31.76	6.11	29.51	173	22	A	V
		5360.64	50.69	-23.31	74	42.27	31.82	6.12	29.52	173	22	P	V
		5350.08	41.5	-12.5	54	33.09	31.81	6.12	29.52	173	22	A	V
802.11n HT20 CH 60 5300MHz		5038.76	51.24	-22.76	74	43.06	31.63	6.02	29.47	106	58	P	H
		5068.68	39.51	-14.49	54	31.3	31.64	6.04	29.47	106	58	A	H
	*	5300	115.52	-	-	107.14	31.78	6.11	29.51	106	58	P	H
	*	5300	107.56	-	-	99.18	31.78	6.11	29.51	106	58	A	H
		5357.52	54.43	-19.57	74	46.02	31.81	6.12	29.52	106	58	P	H
		5350.08	45.82	-8.18	54	37.41	31.81	6.12	29.52	106	58	A	H
		5060.52	49.98	-24.02	74	41.78	31.64	6.03	29.47	163	22	P	V
		5062.9	39.32	-14.68	54	31.12	31.64	6.03	29.47	163	22	A	V
	*	5300	113.64	-	-	105.26	31.78	6.11	29.51	163	22	P	V
	*	5300	105.9	-	-	97.52	31.78	6.11	29.51	163	22	A	V
	5357.76	53.27	-20.73	74	44.86	31.81	6.12	29.52	163	22	P	V	
	5350.32	44.28	-9.72	54	35.87	31.81	6.12	29.52	163	22	A	V	



<b>802.11n</b>  <b>HT20</b>  <b>CH 64</b>  <b>5320MHz</b>	*	5320	115.24	-	-	106.85	31.79	6.12	29.52	100	52	P	H
	*	5320	106.99	-	-	98.6	31.79	6.12	29.52	100	52	A	H
		5354.08	56.54	-17.46	74	48.13	31.81	6.12	29.52	100	52	P	H
		5352.48	46.58	-7.42	54	38.17	31.81	6.12	29.52	100	52	A	H
	*	5320	114.07	-	-	105.68	31.79	6.12	29.52	332	13	P	V
	*	5320	106.1	-	-	97.71	31.79	6.12	29.52	332	13	A	V
		5369.76	55.53	-18.47	74	47.12	31.82	6.12	29.53	332	13	P	V
		5350.08	45.25	-8.75	54	36.84	31.81	6.12	29.52	332	13	A	V
<b>Remark</b>	1. No other spurious found. 2. All results are PASS against Peak and Average limit line.												





**Band 2 5250~5350MHz**  
**WIFI 802.11n HT20 (Harmonic @ 3m)**

WIFI Ant. 1+2	Note	Frequency ( MHz )	Level ( dBμV/m )	Over Limit ( dB )	Limit Line ( dBμV/m )	Read Level (dBμV)	Antenna Factor ( dB/m )	Path Loss ( dB )	Preamp Factor ( dB )	Ant Pos ( cm )	Table Pos ( deg )	Peak Avg. (P/A)	Pol. (H/V)
802.11n HT20		10520	46.59	-21.61	68.2	53.45	40.02	10	56.88	100	0	P	H
		15780	44.74	-29.26	74	50.28	38.04	12.78	56.36	100	0	P	H
CH 52 5260MHz		10520	46.23	-21.97	68.2	53.09	40.02	10	56.88	100	0	P	V
		15780	44.56	-29.44	74	50.1	38.04	12.78	56.36	100	0	P	V
802.11n HT20 CH 60 5300MHz		10600	46.89	-27.11	74	53.57	40.1	10.04	56.82	100	0	P	H
		15900	44.85	-29.15	74	50.48	37.75	12.84	56.22	100	0	P	H
		10600	46.49	-27.51	74	53.17	40.1	10.04	56.82	100	0	P	V
		15900	44.85	-29.15	74	50.48	37.75	12.84	56.22	100	0	P	V
802.11n HT20 CH 64 5320MHz		10640	47.14	-26.86	74	53.74	40.14	10.05	56.79	100	0	P	H
		15960	44.03	-29.97	74	49.73	37.58	12.87	56.15	100	0	P	H
		10640	48.69	-25.31	74	55.29	40.14	10.05	56.79	100	0	P	V
		15960	44.21	-29.79	74	49.91	37.58	12.87	56.15	100	0	P	V
<b>Remark</b>	1. No other spurious found. 2. All results are PASS against Peak and Average limit line.												



**Band 2 5250~5350MHz**  
**WIFI 802.11n HT40 (Band Edge @ 3m)**

WIFI Ant. 1+2	Note	Frequency ( MHz )	Level ( dBμV/m )	Over Limit ( dB )	Limit Line ( dBμV/m )	Read Level (dBμV)	Antenna Factor ( dB/m )	Path Loss ( dB )	Preamp Factor ( dB )	Ant Pos ( cm )	Table Pos ( deg )	Peak Avg. (P/A)	Pol. (H/V)
802.11n HT40 CH 54 5270MHz		5082.96	50.16	-23.84	74	41.93	31.65	6.05	29.47	100	56	P	H
		5149.6	42.18	-11.82	54	33.9	31.69	6.08	29.49	100	56	A	H
	*	5270	112.79	-	-	104.43	31.76	6.11	29.51	100	56	P	H
	*	5270	105.94	-	-	97.58	31.76	6.11	29.51	100	56	A	H
		5364.48	55.1	-18.9	74	46.69	31.82	6.12	29.53	100	56	P	H
		5351.76	47.59	-6.41	54	39.18	31.81	6.12	29.52	100	56	A	H
		5045.22	49.51	-24.49	74	41.33	31.63	6.02	29.47	383	8	P	V
		5047.26	41.98	-12.02	54	33.79	31.63	6.03	29.47	383	8	A	V
	*	5270	112.47	-	-	104.11	31.76	6.11	29.51	383	8	P	V
	*	5270	105.08	-	-	96.72	31.76	6.11	29.51	383	8	A	V
		5351.04	53.4	-20.6	74	44.99	31.81	6.12	29.52	383	8	P	V
		5350.32	45.52	-8.48	54	37.11	31.81	6.12	29.52	383	8	A	V
802.11n HT40 CH 62 5310MHz		5049.64	49.29	-24.71	74	41.1	31.63	6.03	29.47	264	308	P	H
		5087.72	41.42	-12.58	54	33.2	31.65	6.05	29.48	264	308	A	H
	*	5310	109.2	-	-	100.81	31.79	6.12	29.52	264	308	P	H
	*	5310	102.16	-	-	93.77	31.79	6.12	29.52	264	308	A	H
		5351.28	58.81	-15.19	74	50.4	31.81	6.12	29.52	264	308	P	H
		5351.28	51.6	-2.4	54	43.19	31.81	6.12	29.52	264	308	A	H
		5114.24	48.64	-25.36	74	40.39	31.67	6.06	29.48	361	2	P	V
		5076.16	40.99	-13.01	54	32.77	31.65	6.04	29.47	361	2	A	V
	*	5310	106.12	-	-	97.73	31.79	6.12	29.52	361	2	P	V
	*	5310	98.39	-	-	90	31.79	6.12	29.52	361	2	A	V
	5352	54.67	-19.33	74	46.26	31.81	6.12	29.52	361	2	P	V	
	5350.32	46.95	-7.05	54	38.54	31.81	6.12	29.52	361	2	A	V	
<b>Remark</b>	1. No other spurious found. 2. All results are PASS against Peak and Average limit line.												



**Band 2 5250~5350MHz**  
**WIFI 802.11n HT40 (Harmonic @ 3m)**

WIFI Ant. 1+2	Note	Frequency ( MHz )	Level ( dBμV/m )	Over Limit ( dB )	Limit Line ( dBμV/m )	Read Level (dBμV)	Antenna Factor ( dB/m )	Path Loss ( dB )	Preamp Factor ( dB )	Ant Pos ( cm )	Table Pos ( deg )	Peak Avg. (P/A)	Pol. (H/V)
802.11n HT40 CH 54 5270MHz		5494	58.72	-9.48	68.2	50.17	31.89	6.21	29.55	100	56	P	H
		10540	48.44	-19.76	68.2	55.27	40.03	10.01	56.87	100	0	P	H
		15810	44.38	-29.62	74	49.95	37.96	12.8	56.33	100	0	P	H
		5494	56.03	-12.17	68.2	47.48	31.89	6.21	29.55	383	8	P	V
		10540	47.01	-21.19	68.2	53.84	40.03	10.01	56.87	100	0	P	V
		15810	46.33	-27.67	74	51.9	37.96	12.8	56.33	100	0	P	V
802.11n HT40 CH 62 5310MHz		5536	55.53	-12.67	68.2	46.87	31.95	6.26	29.55	264	308	P	H
		10620	48.07	-25.93	74	54.71	40.12	10.04	56.8	100	0	P	H
		15930	44.98	-29.02	74	50.63	37.67	12.86	56.18	100	0	P	H
		10620	47.21	-26.79	74	53.85	40.12	10.04	56.8	100	0	P	V
		15930	45.17	-28.83	74	50.82	37.67	12.86	56.18	100	0	P	V
<b>Remark</b>	<ol style="list-style-type: none"> <li>No other spurious found.</li> <li>All results are PASS against Peak and Average limit line.</li> </ol>												



**Band 2 5250~5350MHz**  
**WIFI 802.11ac VHT80 (Band Edge @ 3m)**

WIFI Ant. 1+2	Note	Frequency ( MHz )	Level ( dBμV/m )	Over Limit ( dB )	Limit Line ( dBμV/m )	Read Level (dBμV)	Antenna Factor ( dB/m )	Path Loss ( dB )	Preamp Factor ( dB )	Ant Pos ( cm )	Table Pos ( deg )	Peak Avg. (P/A)	Pol. (H/V)
802.11ac VHT80 CH 58 5290MHz		5053.38	50.58	-23.42	74	42.39	31.63	6.03	29.47	100	59	P	H
		5102	41.35	-12.65	54	33.11	31.66	6.06	29.48	100	59	A	H
	*	5290	105.16	-	-	96.79	31.77	6.11	29.51	100	59	P	H
	*	5290	97.63	-	-	89.26	31.77	6.11	29.51	100	59	A	H
		5352.48	59.47	-14.53	74	51.06	31.81	6.12	29.52	100	59	P	H
		5352.24	52.72	-1.28	54	44.31	31.81	6.12	29.52	100	59	A	H
		5008.84	49.66	-24.34	74	41.51	31.61	6	29.46	343	3	P	V
		5110.5	41.1	-12.9	54	32.85	31.67	6.06	29.48	343	3	A	V
	*	5290	104.13	-	-	95.76	31.77	6.11	29.51	343	3	P	V
	*	5290	96.3	-	-	87.93	31.77	6.11	29.51	343	3	A	V
	5353.92	58.84	-15.16	74	50.43	31.81	6.12	29.52	343	3	P	V	
	5353.44	50.69	-3.31	54	42.28	31.81	6.12	29.52	343	3	A	V	
<b>Remark</b>	1. No other spurious found. 2. All results are PASS against Peak and Average limit line.												



Band 2 5250~5350MHz  
WIFI 802.11ac VHT80 (Harmonic @ 3m)

WIFI Ant. 1+2	Note	Frequency ( MHz )	Level ( dBμV/m )	Over Limit ( dB )	Limit Line ( dBμV/m )	Read Level (dBμV)	Antenna Factor ( dB/m )	Path Loss ( dB )	Preamp Factor ( dB )	Ant Pos ( cm )	Table Pos ( deg )	Peak Avg. (P/A)	Pol. (H/V)
802.11ac		10580	46.61	-21.59	68.2	53.33	40.09	10.03	56.84	100	0	P	H
VHT80		15870	45.53	-28.47	74	51.18	37.79	12.82	56.26	100	0	P	H
CH 58		10580	48	-20.2	68.2	54.72	40.09	10.03	56.84	100	0	P	V
5290MHz		15870	45.2	-28.8	74	50.85	37.79	12.82	56.26	100	0	P	V
Remark	1. No other spurious found. 2. All results are PASS against Peak and Average limit line.												



**Band 3 - 5470~5725MHz**  
**WIFI 802.11a (Band Edge @ 3m)**

WIFI	Note	Frequency	Level	Over	Limit	Read	Antenna	Path	Preamp	Ant	Table	Peak	Pol.
Ant.				Limit	Line	Level	Factor	Loss	Factor	Pos	Pos	Avg.	
1+2		( MHz )	( dBμV/m )	( dB )	( dBμV/m )	( dBμV )	( dB/m )	( dB )	( dB )	( cm )	( deg )	( P/A )	( H/V )
802.11a CH 100 5500MHz		5456.72	55.36	-18.64	74	46.85	31.87	6.18	29.54	100	69	P	H
		5467.28	56.12	-12.08	68.2	47.59	31.88	6.19	29.54	100	69	P	H
		5457.04	46.25	-7.75	54	37.74	31.87	6.18	29.54	100	69	A	H
	*	5500	116.18	-	-	107.61	31.9	6.22	29.55	100	69	P	H
	*	5500	108.79	-	-	100.22	31.9	6.22	29.55	100	69	A	H
		5455.6	54.05	-19.95	74	45.54	31.87	6.18	29.54	379	13	P	V
		5470	56.58	-11.62	68.2	48.05	31.88	6.19	29.54	379	13	P	V
		5459.76	45.07	-8.93	54	36.56	31.87	6.18	29.54	379	13	A	V
	*	5500	115.18	-	-	106.61	31.9	6.22	29.55	379	13	P	V
	*	5500	107.79	-	-	99.22	31.9	6.22	29.55	379	13	A	V
802.11a CH 116 5580MHz		5452.72	49.23	-24.77	74	40.73	31.87	6.17	29.54	100	74	P	H
		5469.28	48.83	-19.37	68.2	40.3	31.88	6.19	29.54	100	74	P	H
		5452.72	40.13	-13.87	54	31.63	31.87	6.17	29.54	100	74	A	H
	*	5580	116.56	-	-	107.81	32	6.3	29.55	100	74	P	H
	*	5580	109.34	-	-	100.59	32	6.3	29.55	100	74	A	H
		5731.61	50.4	-17.8	68.2	41.37	32.21	6.37	29.55	100	74	P	H
		5420.56	48.47	-25.53	74	40.02	31.85	6.14	29.54	394	332	P	V
		5463.76	48.47	-19.73	68.2	39.95	31.88	6.18	29.54	394	332	P	V
		5452.72	39.6	-14.4	54	31.1	31.87	6.17	29.54	394	332	A	V
	*	5580	113.87	-	-	105.12	32	6.3	29.55	394	332	P	V
	*	5580	106.67	-	-	97.92	32	6.3	29.55	394	332	A	V
	5764.685	49.75	-18.45	68.2	40.66	32.26	6.39	29.56	394	332	P	V	



<b>802.11a</b> <b>CH 140</b> <b>5700MHz</b>	*	5700	117.18	-	-	108.2	32.17	6.36	29.55	100	72	P	H
	*	5700	109.84	-	-	100.86	32.17	6.36	29.55	100	72	A	H
		5725	60.78	-7.42	68.2	51.75	32.21	6.37	29.55	100	72	P	H
	*	5700	115.67	-	-	106.69	32.17	6.36	29.55	302	352	P	V
	*	5700	107.68	-	-	98.7	32.17	6.36	29.55	302	352	A	V
		5725.08	59.12	-9.08	68.2	50.09	32.21	6.37	29.55	302	352	P	V
<b>Remark</b>	1. No other spurious found. 2. All results are PASS against Peak and Average limit line.												



**Band 3 - 5470~5725MHz**  
**WIFI 802.11a (Harmonic @ 3m)**

WIFI Ant. 1+2	Note	Frequency ( MHz )	Level ( dBμV/m )	Over Limit ( dB )	Limit Line ( dBμV/m )	Read Level (dBμV)	Antenna Factor ( dB/m )	Path Loss ( dB )	Preamp Factor ( dB )	Ant Pos ( cm )	Table Pos ( deg )	Peak Avg. (P/A)	Pol. (H/V)
802.11a CH 100 5500MHz		11000	47.35	-26.65	74	53.13	40.5	10.22	56.5	100	0	P	H
		16500	46.24	-21.96	68.2	49.75	39.4	12.79	55.7	100	0	P	H
		11000	47.88	-26.12	74	53.66	40.5	10.22	56.5	100	0	P	V
		16500	47.26	-20.94	68.2	50.77	39.4	12.79	55.7	100	0	P	V
802.11a CH 116 5580MHz		11160	47.09	-26.91	74	52.93	40.3	10.3	56.44	100	0	P	H
		16740	47.55	-20.65	68.2	51.01	39.69	12.74	55.89	100	0	P	H
		11160	47.33	-26.67	74	53.17	40.3	10.3	56.44	100	0	P	V
		16740	47.35	-20.85	68.2	50.81	39.69	12.74	55.89	100	0	P	V
802.11a CH 140 5700MHz		11400	46.98	-27.02	74	52.88	40.02	10.42	56.34	100	0	P	H
		17100	49.24	-18.96	68.2	52.38	40.36	12.8	56.3	100	0	P	H
		11400	47.9	-26.1	74	53.8	40.02	10.42	56.34	100	0	P	V
		17100	48.78	-19.42	68.2	51.92	40.36	12.8	56.3	100	0	P	V
<b>Remark</b>	1. No other spurious found. 2. All results are PASS against Peak and Average limit line.												





**Band 3 - 5470~5725MHz  
WIFI 802.11n HT20 (Band Edge @ 3m)**

WIFI Ant. 1+2	Note	Frequency ( MHz )	Level ( dBμV/m )	Over Limit ( dB )	Limit Line ( dBμV/m )	Read Level ( dBμV )	Antenna Factor ( dB/m )	Path Loss ( dB )	Preamp Factor ( dB )	Ant Pos ( cm )	Table Pos ( deg )	Peak Avg. ( P/A )	Pol. ( H/V )
802.11n HT20 CH 100 5500MHz		5459.44	54.68	-19.32	74	46.17	31.87	6.18	29.54	100	76	P	H
		5461.36	56.38	-11.82	68.2	47.87	31.87	6.18	29.54	100	76	P	H
		5460	45.54	-8.46	54	37.03	31.87	6.18	29.54	100	76	A	H
	*	5500	115.81	-	-	107.24	31.9	6.22	29.55	100	76	P	H
	*	5500	107.92	-	-	99.35	31.9	6.22	29.55	100	76	A	H
		5459.28	54.12	-19.88	74	45.61	31.87	6.18	29.54	379	15	P	V
		5467.28	54.41	-13.79	68.2	45.88	31.88	6.19	29.54	379	15	P	V
		5460	44.29	-9.71	54	35.78	31.87	6.18	29.54	379	15	A	V
	*	5500	115.14	-	-	106.57	31.9	6.22	29.55	379	15	P	V
	*	5500	107.3	-	-	98.73	31.9	6.22	29.55	379	15	A	V
802.11n HT20 CH 116 5580MHz		5407.12	49.13	-24.87	74	40.69	31.84	6.13	29.53	100	75	P	H
		5467.6	49.2	-19	68.2	40.67	31.88	6.19	29.54	100	75	P	H
		5452.72	40.12	-13.88	54	31.62	31.87	6.17	29.54	100	75	A	H
	*	5580	116.18	-	-	107.43	32	6.3	29.55	100	75	P	H
	*	5580	108.49	-	-	99.74	32	6.3	29.55	100	75	A	H
		5760.275	50.33	-17.87	68.2	41.25	32.26	6.38	29.56	100	75	P	H
		5454.4	49.11	-24.89	74	40.61	31.87	6.17	29.54	374	335	P	V
		5461.84	48.94	-19.26	68.2	40.43	31.87	6.18	29.54	374	335	P	V
		5452.96	39.45	-14.55	54	30.95	31.87	6.17	29.54	374	335	A	V
	*	5580	114.58	-	-	105.83	32	6.3	29.55	374	335	P	V
	*	5580	106.73	-	-	97.98	32	6.3	29.55	374	335	A	V
		5764.055	48.69	-19.51	68.2	39.6	32.26	6.39	29.56	374	335	P	V



<b>802.11n</b>	*	5700	117.49	-	-	108.51	32.17	6.36	29.55	101	66	P	H
	*	5700	109.28	-	-	100.3	32.17	6.36	29.55	101	66	A	H
<b>HT20</b>		5725.08	61.63	-6.57	68.2	52.6	32.21	6.37	29.55	101	66	P	H
<b>CH 140</b>	*	5700	115.01	-	-	106.03	32.17	6.36	29.55	271	7	P	V
<b>5700MHz</b>	*	5700	106.99	-	-	98.01	32.17	6.36	29.55	271	7	A	V
		5725	62.98	-5.22	68.2	53.95	32.21	6.37	29.55	271	7	P	V
<b>Remark</b>	1. No other spurious found. 2. All results are PASS against Peak and Average limit line.												



**Band 3 - 5470~5725MHz**  
**WIFI 802.11n HT20 (Harmonic @ 3m)**

WIFI Ant. 1+2	Note	Frequency ( MHz )	Level ( dBμV/m )	Over Limit ( dB )	Limit Line ( dBμV/m )	Read Level (dBμV)	Antenna Factor ( dB/m )	Path Loss ( dB )	Preamp Factor ( dB )	Ant Pos ( cm )	Table Pos ( deg )	Peak Avg. (P/A)	Pol. (H/V)
802.11n HT20		11000	47.33	-26.67	74	53.11	40.5	10.22	56.5	100	0	P	H
		16500	46.18	-22.02	68.2	49.69	39.4	12.79	55.7	100	0	P	H
CH 100 5500MHz		11000	46.62	-27.38	74	52.4	40.5	10.22	56.5	100	0	P	V
		16500	45.91	-22.29	68.2	49.42	39.4	12.79	55.7	100	0	P	V
802.11n HT20 CH 116 5580MHz		11160	46.63	-27.37	74	52.47	40.3	10.3	56.44	100	0	P	H
		16740	48.16	-20.04	68.2	51.62	39.69	12.74	55.89	100	0	P	H
		11160	47.64	-26.36	74	53.48	40.3	10.3	56.44	100	0	P	V
		16740	48.66	-19.54	68.2	52.12	39.69	12.74	55.89	100	0	P	V
802.11n HT20 CH 140 5700MHz		11400	46.71	-27.29	74	52.61	40.02	10.42	56.34	100	0	P	H
		17100	48.53	-19.67	68.2	51.67	40.36	12.8	56.3	100	0	P	H
		11400	48.18	-25.82	74	54.08	40.02	10.42	56.34	100	0	P	V
		17100	48.66	-19.54	68.2	51.8	40.36	12.8	56.3	100	0	P	V
<b>Remark</b>	1. No other spurious found. 2. All results are PASS against Peak and Average limit line.												



**Band 3 - 5470~5725MHz**  
**WIFI 802.11n HT40 (Band Edge @ 3m)**

WIFI Ant. 1+2	Note	Frequency ( MHz )	Level ( dBμV/m )	Over Limit ( dB )	Limit Line ( dBμV/m )	Read Level ( dBμV )	Antenna Factor ( dB/m )	Path Loss ( dB )	Preamp Factor ( dB )	Ant Pos ( cm )	Table Pos ( deg )	Peak Avg. ( P/A )	Pol. ( H/V )
802.11n HT40 CH 102 5510MHz		5454.88	55.34	-18.66	74	46.84	31.87	6.17	29.54	100	50	P	H
		5466.64	64.59	-3.61	68.2	56.06	31.88	6.19	29.54	100	50	P	H
		5459.92	49.74	-4.26	54	41.23	31.87	6.18	29.54	100	50	A	H
	*	5510	112.51	-	-	103.93	31.9	6.23	29.55	100	50	P	H
	*	5510	104.21	-	-	95.63	31.9	6.23	29.55	100	50	A	H
		5733.185	58.52	-9.68	68.2	49.49	32.21	6.37	29.55	100	50	P	H
		5451.52	55.49	-18.51	74	46.99	31.87	6.17	29.54	373	15	P	V
		5469.76	61.14	-7.06	68.2	52.61	31.88	6.19	29.54	373	15	P	V
		5459.68	48.03	-5.97	54	39.52	31.87	6.18	29.54	373	15	A	V
	*	5510	112.25	-	-	103.67	31.9	6.23	29.55	373	15	P	V
	*	5510	104.55	-	-	95.97	31.9	6.23	29.55	373	15	A	V
		5734.13	54.91	-13.29	68.2	45.88	32.21	6.37	29.55	373	15	P	V
802.11n HT40 CH 110 5550MHz		5455.36	52.72	-21.28	74	44.21	31.87	6.18	29.54	100	50	P	H
		5469.52	55.28	-12.92	68.2	46.75	31.88	6.19	29.54	100	50	P	H
		5459.92	45.48	-8.52	54	36.97	31.87	6.18	29.54	100	50	A	H
	*	5550	114.51	-	-	105.82	31.97	6.27	29.55	100	50	P	H
	*	5550	107.1	-	-	98.41	31.97	6.27	29.55	100	50	A	H
		5745.47	52.06	-16.14	68.2	42.99	32.24	6.38	29.55	100	50	P	H
		5452.48	52.28	-21.72	74	43.78	31.87	6.17	29.54	389	14	P	V
		5466.88	52.23	-15.97	68.2	43.7	31.88	6.19	29.54	389	14	P	V
		5454.16	43.98	-10.02	54	35.48	31.87	6.17	29.54	389	14	A	V
	*	5550	114.68	-	-	105.99	31.97	6.27	29.55	389	14	P	V
	*	5550	105.92	-	-	97.23	31.97	6.27	29.55	389	14	A	V
		5760.59	50.01	-18.19	68.2	40.93	32.26	6.38	29.56	389	14	P	V



<b>802.11n</b>  <b>HT40</b>  <b>CH 134</b>  <b>5670MHz</b>		5448	51.33	-22.67	74	42.83	31.87	6.17	29.54	100	20	P	H
		5469	47.92	-20.28	68.2	39.39	31.88	6.19	29.54	100	20	P	H
		5446.6	45.27	-8.73	54	36.77	31.87	6.17	29.54	100	20	A	H
	*	5670	114.35	-	-	105.41	32.14	6.35	29.55	100	20	P	H
	*	5670	106.32	-	-	97.38	32.14	6.35	29.55	100	20	A	H
		5730.035	61.3	-6.9	68.2	52.27	32.21	6.37	29.55	100	20	P	H
		5416.15	48.79	-25.21	74	40.33	31.85	6.14	29.53	299	4	P	V
		5462	47.59	-20.61	68.2	39.08	31.87	6.18	29.54	299	4	P	V
		5445.9	41.39	-12.61	54	32.89	31.87	6.17	29.54	299	4	A	V
	*	5670	112.25	-	-	103.31	32.14	6.35	29.55	299	4	P	V
	*	5670	104.9	-	-	95.96	32.14	6.35	29.55	299	4	A	V
		5728.775	57.89	-10.31	68.2	48.86	32.21	6.37	29.55	299	4	P	V
<b>Remark</b>	1. No other spurious found. 2. All results are PASS against Peak and Average limit line.												



Band 3 - 5470~5725MHz
WIFI 802.11n HT40 (Harmonic @ 3m)

Table with 14 columns: WIFI Ant. 1+2, Note, Frequency (MHz), Level (dBµV/m), Over Limit (dB), Limit Line (dBµV/m), Read Level (dBµV), Antenna Factor (dB/m), Path Loss (dB), Preamp Factor (dB), Ant Pos (cm), Table Pos (deg), Peak Avg. (P/A), Pol. (H/V). Rows include data for 802.11n HT40 CH 102 (5510MHz) and CH 110 (5550MHz), and 802.11n HT40 CH 134 (5670MHz).

Remark

- 1. No other spurious found.
2. All results are PASS against Peak and Average limit line.



**Band 3 - 5470~5725MHz**  
**WIFI 802.11ac VHT80 (Band Edge @ 3m)**

WIFI Ant. 1+2	Note	Frequency ( MHz )	Level ( dBμV/m )	Over Limit ( dB )	Limit Line ( dBμV/m )	Read Level ( dBμV )	Antenna Factor ( dB/m )	Path Loss ( dB )	Preamp Factor ( dB )	Ant Pos ( cm )	Table Pos ( deg )	Peak Avg. ( P/A )	Pol. ( H/V )
802.11ac VHT80 CH 106 5530MHz		5459.92	60.07	-13.93	74	51.56	31.87	6.18	29.54	105	56	P	H
		5468.56	62.55	-5.65	68.2	54.02	31.88	6.19	29.54	105	56	P	H
		5459.68	52.11	-1.89	54	43.6	31.87	6.18	29.54	105	56	A	H
	*	5530	109.77	-	-	101.15	31.92	6.25	29.55	105	56	P	H
	*	5530	101.46	-	-	92.84	31.92	6.25	29.55	105	56	A	H
		5744.525	51.02	-17.18	68.2	41.95	32.24	6.38	29.55	105	56	P	H
		5449.84	57.03	-16.97	74	48.53	31.87	6.17	29.54	333	0	P	V
		5468.08	61.66	-6.54	68.2	53.13	31.88	6.19	29.54	333	0	P	V
		5453.68	50.08	-3.92	54	41.58	31.87	6.17	29.54	333	0	A	V
	*	5530	109.31	-	-	100.69	31.92	6.25	29.55	333	0	P	V
	*	5530	100.87	-	-	92.25	31.92	6.25	29.55	333	0	A	V
	5760.275	49.73	-18.47	68.2	40.65	32.26	6.38	29.56	333	0	P	V	
802.11ac VHT80 CH 122 5610MHz		5455.84	53.07	-20.93	74	44.56	31.87	6.18	29.54	100	54	P	H
		5461.36	53.9	-14.3	68.2	45.39	31.87	6.18	29.54	100	54	P	H
		5458.72	46.33	-7.67	54	37.82	31.87	6.18	29.54	100	54	A	H
	*	5610	112.43	-	-	103.62	32.04	6.32	29.55	100	54	P	H
	*	5610	103.36	-	-	94.55	32.04	6.32	29.55	100	54	A	H
		5740.745	55.83	-12.37	68.2	46.76	32.24	6.38	29.55	100	54	P	H
		5457.52	52.55	-21.45	74	44.04	31.87	6.18	29.54	306	2	P	V
		5468.32	51.42	-16.78	68.2	42.89	31.88	6.19	29.54	306	2	P	V
		5457.28	44.87	-9.13	54	36.36	31.87	6.18	29.54	306	2	A	V
	*	5610	110.11	-	-	101.3	32.04	6.32	29.55	306	2	P	V
	*	5610	102.62	-	-	93.81	32.04	6.32	29.55	306	2	A	V
	5740.43	54.82	-13.38	68.2	45.75	32.24	6.38	29.55	306	2	P	V	
<b>Remark</b>	1. No other spurious found. 2. All results are PASS against Peak and Average limit line.												



Band 3 5470~5725MHz

WIFI 802.11ac VHT80 (Harmonic @ 3m)

WIFI Ant. 1+2	Note	Frequency ( MHz )	Level ( dBμV/m )	Over Limit ( dB )	Limit Line ( dBμV/m )	Read Level (dBμV)	Antenna Factor ( dB/m )	Path Loss ( dB )	Preamp Factor ( dB )	Ant Pos ( cm )	Table Pos ( deg )	Peak Avg. (P/A)	Pol. (H/V)
802.11ac		11060	47.45	-26.55	74	53.26	40.42	10.25	56.48	100	0	P	H
VHT80		16590	46.88	-21.32	68.2	50.38	39.5	12.77	55.77	100	0	P	H
CH 106		11060	47.46	-26.54	74	53.27	40.42	10.25	56.48	100	0	P	V
5530MHz		16590	47.63	-20.57	68.2	51.13	39.5	12.77	55.77	100	0	P	V
802.11ac		11220	47.09	-26.91	74	52.93	40.24	10.33	56.41	100	0	P	H
VHT80		16830	46.58	-21.62	68.2	50.02	39.79	12.73	55.96	100	0	P	H
CH 122		11220	47.26	-26.74	74	53.1	40.24	10.33	56.41	100	0	P	V
5610MHz		16830	46.99	-21.21	68.2	50.43	39.79	12.73	55.96	100	0	P	V
<b>Remark</b>	1. No other spurious found. 2. All results are PASS against Peak and Average limit line.												





**Band 3 - Straddle Channel**  
**WIFI 802.11a (Band Edge @ 3m)**

WIFI	Note	Frequency	Level	Over	Limit	Read	Antenna	Path	Preamp	Ant	Table	Peak	Pol.
Ant.				Limit	Line	Level	Factor	Loss	Factor	Pos	Pos	Avg.	
1+2		( MHz )	( dBμV/m )	( dB )	( dBμV/m )	( dBμV )	( dB/m )	( dB )	( dB )	( cm )	( deg )	( P/A )	( H/V )
<b>802.11a CH 144 5720MHz</b>		5445.94	48.54	-25.46	74	40.04	31.87	6.17	29.54	100	71	P	H
		5464.66	47.6	-20.6	68.2	39.08	31.88	6.18	29.54	100	71	P	H
		5452.96	39.17	-14.83	54	30.67	31.87	6.17	29.54	100	71	A	H
	*	5720	117.38	-	-	108.35	32.21	6.37	29.55	100	71	P	H
	*	5720	109.67	-	-	100.64	32.21	6.37	29.55	100	71	A	H
		5896.5	51.66	-16.54	68.2	42.28	32.46	6.48	29.56	100	71	P	H
		5435.8	48.61	-25.39	74	40.13	31.86	6.16	29.54	316	353	P	V
		5467.39	49.13	-19.07	68.2	40.6	31.88	6.19	29.54	316	353	P	V
		5452.96	38.98	-15.02	54	30.48	31.87	6.17	29.54	316	353	A	V
	*	5720	115.84	-	-	106.81	32.21	6.37	29.55	316	353	P	V
	*	5720	107.89	-	-	98.86	32.21	6.37	29.55	316	353	A	V
		5878.5	50.78	-17.42	68.2	41.45	32.43	6.46	29.56	316	353	P	V
<b>Remark</b>	1. No other spurious found. 2. All results are PASS against Peak and Average limit line.												



**Band 3 - Straddle Channel**  
**WIFI 802.11a (Harmonic @ 3m)**

WIFI Ant. 1+2	Note	Frequency ( MHz )	Level ( dBμV/m )	Over Limit ( dB )	Limit Line ( dBμV/m )	Read Level (dBμV)	Antenna Factor ( dB/m )	Path Loss ( dB )	Preamp Factor ( dB )	Ant Pos ( cm )	Table Pos ( deg )	Peak Avg. (P/A)	Pol. (H/V)
802.11a CH 144 5720MHz		11440	47.38	-26.62	74	53.29	39.98	10.43	56.32	100	0	P	H
		17160	48.89	-19.31	68.2	51.85	40.6	12.86	56.42	100	0	P	H
		11440	46.48	-27.52	74	52.39	39.98	10.43	56.32	100	0	P	V
		17160	47.97	-20.23	68.2	50.93	40.6	12.86	56.42	100	0	P	V
<b>Remark</b>	1. No other spurious found. 2. All results are PASS against Peak and Average limit line.												



**Band 3 - Straddle Channel**  
**WIFI 802.11n HT20 (Band Edge @ 3m)**

WIFI Ant. 1+2	Note	Frequency ( MHz )	Level ( dBμV/m )	Over Limit ( dB )	Limit Line ( dBμV/m )	Read Level (dBμV)	Antenna Factor ( dB/m )	Path Loss ( dB )	Preamp Factor ( dB )	Ant Pos ( cm )	Table Pos ( deg )	Peak Avg. (P/A)	Pol. (H/V)
802.11n HT20 CH 144 5720MHz		5459.2	48.64	-25.36	74	40.13	31.87	6.18	29.54	102	64	P	H
		5470	47.35	-20.85	68.2	38.82	31.88	6.19	29.54	102	64	P	H
		5452.96	38.7	-15.3	54	30.2	31.87	6.17	29.54	102	64	A	H
	*	5720	116.86	-	-	107.83	32.21	6.37	29.55	102	64	P	H
	*	5720	109.05	-	-	100.02	32.21	6.37	29.55	102	64	A	H
		5851.5	51.98	-16.22	68.2	42.72	32.38	6.44	29.56	102	64	P	H
		5413.18	46.78	-27.22	74	38.33	31.85	6.13	29.53	108	16	P	V
		5460.76	47.83	-20.37	68.2	39.32	31.87	6.18	29.54	108	16	P	V
		5452.57	38.41	-15.59	54	29.91	31.87	6.17	29.54	108	16	P	V
	*	5720	108.41	-	-	99.38	32.21	6.37	29.55	108	16	P	V
	*	5720	100.68	-	-	91.65	32.21	6.37	29.55	108	16	A	V
		5851.5	49.14	-19.06	68.2	39.88	32.38	6.44	29.56	108	16	P	V
<b>Remark</b>	1. No other spurious found. 2. All results are PASS against Peak and Average limit line.												



Band 3 - Straddle Channel
WIFI 802.11n HT20 (Harmonic @ 3m)

Table with 14 columns: WIFI Ant. 1+2, Note, Frequency (MHz), Level (dBµV/m), Over Limit (dB), Limit Line (dBµV/m), Read Level (dBµV), Antenna Factor (dB/m), Path Loss (dB), Preamp Factor (dB), Ant Pos (cm), Table Pos (deg), Peak Avg. (P/A), Pol. (H/V). Rows include data for 802.11n HT20 CH 144 at 5720MHz and a Remark section.



**Band 3 - Straddle Channel**  
**WIFI 802.11n HT40 (Band Edge @ 3m)**

WIFI Ant. 1+2	Note	Frequency ( MHz )	Level ( dBµV/m )	Over Limit ( dB )	Limit Line ( dBµV/m )	Read Level ( dBµV )	Antenna Factor ( dB/m )	Path Loss ( dB )	Preamp Factor ( dB )	Ant Pos ( cm )	Table Pos ( deg )	Peak Avg. ( P/A )	Pol. ( H/V )
802.11n HT40 CH 142 5710MHz		5399.92	47.86	-26.14	74	39.43	31.84	6.12	29.53	100	47	P	H
		5462.32	47.89	-20.31	68.2	39.38	31.87	6.18	29.54	100	47	P	H
		5458.42	40.74	-13.26	54	32.23	31.87	6.18	29.54	100	47	A	H
	*	5710	114.39	-	-	105.39	32.19	6.36	29.55	100	47	P	H
	*	5710	107.07	-	-	98.07	32.19	6.36	29.55	100	47	A	H
		5938	52.91	-15.29	68.2	43.46	32.5	6.51	29.56	100	47	P	H
		5452.18	48.64	-25.36	74	40.14	31.87	6.17	29.54	295	5	P	V
		5461.93	47	-21.2	68.2	38.49	31.87	6.18	29.54	295	5	P	V
		5452.57	41.6	-12.4	54	33.1	31.87	6.17	29.54	295	5	A	V
	*	5710	112.83	-	-	103.83	32.19	6.36	29.55	295	5	P	V
	*	5710	105.14	-	-	96.14	32.19	6.36	29.55	295	5	A	V
		5932.75	54.07	-14.13	68.2	44.62	32.5	6.51	29.56	295	5	P	V
<b>Remark</b>	1. No other spurious found. 2. All results are PASS against Peak and Average limit line.												



**Band 3 - Straddle Channel**  
**WIFI 802.11n HT40 (Harmonic @ 3m)**

WIFI Ant. 1+2	Note	Frequency ( MHz )	Level ( dBμV/m )	Over Limit ( dB )	Limit Line ( dBμV/m )	Read Level ( dBμV )	Antenna Factor ( dB/m )	Path Loss ( dB )	Preamp Factor ( dB )	Ant Pos ( cm )	Table Pos ( deg )	Peak Avg. ( P/A )	Pol. ( H/V )
802.11n		11420	47.07	-26.93	74	52.98	40	10.42	56.33	100	0	P	H
HT40		17130	48.1	-20.1	68.2	51.14	40.48	12.84	56.36	100	0	P	H
CH 142		11420	46.82	-27.18	74	52.73	40	10.42	56.33	100	0	P	V
5710MHz		17130	48.13	-20.07	68.2	51.17	40.48	12.84	56.36	100	0	P	V
<b>Remark</b>	1. No other spurious found. 2. All results are PASS against Peak and Average limit line.												



**Band 3 - Straddle Channel**  
**WIFI 802.11ac VHT80 (Band Edge @ 3m)**

WIFI Ant. 1+2	Note	Frequency ( MHz )	Level ( dBμV/m )	Over Limit ( dB )	Limit Line ( dBμV/m )	Read Level (dBμV)	Antenna Factor ( dB/m )	Path Loss ( dB )	Preamp Factor ( dB )	Ant Pos ( cm )	Table Pos ( deg )	Peak Avg. (P/A)	Pol. (H/V)
802.11ac VHT80 CH 138 5690MHz		5438.14	48.25	-25.75	74	39.77	31.86	6.16	29.54	100	55	P	H
		5469.73	48.02	-20.18	68.2	39.49	31.88	6.19	29.54	100	55	P	H
		5449.06	40.33	-13.67	54	31.83	31.87	6.17	29.54	100	55	A	H
	*	5690	111.56	-	-	102.58	32.17	6.36	29.55	100	55	P	H
	*	5690	103.95	-	-	94.97	32.17	6.36	29.55	100	55	A	H
		5851.3	50.38	-17.82	68.2	41.12	32.38	6.44	29.56	100	55	P	H
		5395.63	48.17	-25.83	74	39.74	31.84	6.12	29.53	312	0	P	V
		5470	47.47	-20.73	68.2	38.94	31.88	6.19	29.54	312	0	P	V
		5457.25	40.18	-13.82	54	31.67	31.87	6.18	29.54	312	0	A	V
	*	5690	109.8	-	-	100.82	32.17	6.36	29.55	312	0	P	V
	*	5690	102.54	-	-	93.56	32.17	6.36	29.55	312	0	A	V
		5891.8	50.36	-17.84	68.2	40.99	32.46	6.47	29.56	312	0	P	V
<b>Remark</b>	1. No other spurious found. 2. All results are PASS against Peak and Average limit line.												



Band 3 - Straddle Channel
WIFI 802.11ac VHT80 (Harmonic @ 3m)

Table with 14 columns: WIFI Ant. 1+2, Note, Frequency (MHz), Level (dBµV/m), Over Limit (dB), Limit Line (dBµV/m), Read Level (dBµV), Antenna Factor (dB/m), Path Loss (dB), Preamp Factor (dB), Ant Pos (cm), Table Pos (deg), Peak Avg. (P/A), Pol. (H/V). Rows include 802.11ac, VHT80, CH 138, 5690MHz and a Remark section.





Emission below 1GHz  
 WIFI 802.11ac VHT80 (LF @ 3m)

WIFI	Note	Frequency	Level	Over	Limit	Read	Antenna	Path	Preamp	Ant	Table	Peak	Pol.
Ant.				Limit	Line	Level	Factor	Loss	Factor	Pos	Pos	Avg.	
1+2		( MHz )	( dBμV/m )	( dB )	( dBμV/m )	( dBμV )	( dB/m )	( dB )	( dB )	( cm )	( deg )	( P/A )	( H/V )
802.11ac VHT80 LF		42.61	23.53	-16.47	40	37.38	17.92	0.49	32.29	-	-	P	H
		118.27	31.8	-11.7	43.5	45.77	17.29	0.87	32.2	100	0	P	H
		135.73	25.2	-18.3	43.5	39	17.37	0.93	32.18	-	-	P	H
		318.09	27.08	-18.92	46	38.34	19.4	1.4	32.15	-	-	P	H
		562.53	28.61	-17.39	46	32.84	25.95	1.94	32.21	-	-	P	H
		943.74	33.11	-12.89	46	31.18	30.32	2.45	31.04	-	-	P	H
		40.67	32.78	-7.22	40	45.68	18.87	0.48	32.29	100	0	P	V
		62.01	27.38	-12.62	40	47.26	11.77	0.59	32.27	-	-	P	V
		112.45	24.14	-19.36	43.5	38.51	16.92	0.84	32.2	-	-	P	V
		121.18	24.01	-19.49	43.5	37.79	17.47	0.88	32.2	-	-	P	V
		899.12	33.2	-12.8	46	33	29	2.44	31.41	-	-	P	V
		958.29	33.53	-12.47	46	30.95	30.81	2.46	30.91	-	-	P	V
Remark	1. No other spurious found. 2. All results are PASS against limit line.												



**Note symbol**

*	<b>Fundamental Frequency</b> which can be ignored. However, the level of any unwanted emissions shall not exceed the level of the fundamental frequency.
!	Test result is <b>over limit</b> line.
P/A	<b>Peak</b> or <b>Average</b>
H/V	<b>Horizontal</b> or <b>Vertical</b>



A calculation example for radiated spurious emission is shown as below:

WIFI	Note	Frequency	Level	Over	Limit	Read	Antenna	Path	Preamp	Ant	Table	Peak	Pol.
Ant.				Limit	Line	Level	Factor	Loss	Factor	Pos	Pos	Avg.	
1+2		( MHz )	( dBμV/m )	( dB )	( dBμV/m )	( dBμV )	( dB/m )	( dB )	( dB )	( cm )	( deg )	( P/A )	( H/V )
802.11b		2390	55.45	-18.55	74	54.51	32.22	4.58	35.86	103	308	P	H
CH 01													
2412MHz		2390	43.54	-10.46	54	42.6	32.22	4.58	35.86	103	308	A	H

1. Path Loss(dB) = Cable loss(dB) + Filter loss(dB) + Attenuator loss(dB)
2. Level(dBμV/m) = Antenna Factor(dB/m) + Path Loss(dB) + Read Level(dBμV) - Preamp Factor(dB)
3. Over Limit(dB) = Level(dBμV/m) – Limit Line(dBμV/m)

**For Peak Limit @ 2390MHz:**

1. Level(dBμV/m)  
= Antenna Factor(dB/m) + Path Loss(dB) + Read Level(dBμV) - Preamp Factor(dB)  
= 32.22(dB/m) + 4.58(dB) + 54.51(dBμV) – 35.86 (dB)  
= 55.45 (dBμV/m)
2. Over Limit(dB)  
= Level(dBμV/m) – Limit Line(dBμV/m)  
= 55.45(dBμV/m) – 74(dBμV/m)  
= -18.55(dB)

**For Average Limit @ 2390MHz:**

1. Level(dBμV/m)  
= Antenna Factor(dB/m) + Path Loss(dB) + Read Level(dBμV) - Preamp Factor(dB)  
= 32.22(dB/m) + 4.58(dB) + 42.6(dBμV) – 35.86 (dB)  
= 43.54 (dBμV/m)
2. Over Limit(dB) = Level(dBμV/m) – Limit Line(dBμV/m)  
= 43.54(dBμV/m) – 54(dBμV/m)  
= -10.46(dB)

**Both peak and average measured complies with the limit line, so test result is “PASS”.**



## Appendix D. Radiated Spurious Emission Plots

Test Engineer :	Alex Jheng, JC Liang, Wilson Wu	Temperature :	20~24°C
		Relative Humidity :	50~55%

### Note symbol

-L	Low channel location
-R	High channel location



**Band 1 - 5150~5250MHz**  
**WIFI 802.11a (Band Edge @ 3m)**

WIFI	Band 1 5150~5250MHz Band Edge @ 3m	
ANT	802.11a CH36 5180MHz	
1+2	Horizontal	Fundamental
<b>Peak</b>	<p>Site : 03CH13-HV            Condition : PEAK_BE_74 3m HORN_91200_1241 HORIZONTAL            RBW:1000.000kHz VSW:3000.000kHz SWT:Auto            Detector : Peak</p>	<p>Site : 03CH13-HV            Condition : PEAK(FUN1) 3m HORN_91200_1241 HORIZONTAL            RBW:1000.000kHz VSW:3000.000kHz SWT:Auto            Detector : Peak</p>
<b>Avg.</b>	<p>Site : 03CH13-HV            Condition : AVG_BE_04 3m HORN_91200_1241 HORIZONTAL            RBW:1000.000kHz VSW:3000.000kHz SWT:Auto            Detector : Peak</p>	<p>Left blank</p>



WIFI	Band 1 5150~5250MHz Band Edge @ 3m	
ANT	802.11a CH36 5180MHz	
1+2	Vertical	Fundamental
Peak		
Avg.		Left blank



WIFI	Band 1 5150~5250MHz Band Edge @ 3m	
ANT	802.11a CH44 5220MHz - L	
1+2	Horizontal	Fundamental
<p><b>Peak</b></p>	<p>Site : 03CH13-MY            Condition : PEAK_BE_74 3m HORN_91200_1241 HORIZONTAL            RBW:1000.000KHz VSW:3000.000KHz SWT:Auto            Detector : Peak</p>	<p>Site : 03CH13-MY            Condition : PEAK(FUN1) 3m HORN_91200_1241 HORIZONTAL            RBW:1000.000KHz VSW:3000.000KHz SWT:Auto            Detector : Peak</p>
<p><b>Avg.</b></p>	<p>Site : 03CH13-MY            Condition : AVG_BE_04 3m HORN_91200_1241 HORIZONTAL            RBW:1000.000KHz VSW:3.000KHz SWT:Auto            Detector : Peak</p>	<p>Left blank</p>

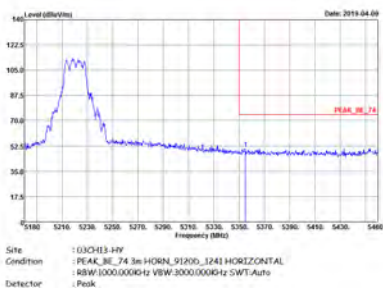
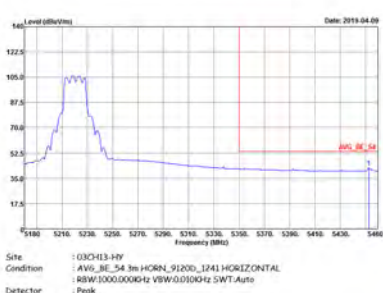

WIFI	Band 1 5150~5250MHz Band Edge @ 3m	
ANT	802.11a CH44 5220MHz - R	
1+2	Horizontal	Fundamental
Peak		Left blank
Avg.		Left blank





WIFI	Band 1 5150~5250MHz Band Edge @ 3m	
ANT	802.11a CH44 5220MHz - L	
1+2	Vertical	Fundamental
Peak	<p>Site : 03CH13-HY            Condition : PEAK_BE_74 3m HORN_91200_1241 VERTICAL            RBW:1000.000KHz VBW:3000.000KHz SWT:Auto            Detector : Peak</p>	<p>Site : 03CH13-HY            Condition : PEAK(FUN1) 3m HORN_91200_1241 VERTICAL            RBW:1000.000KHz VBW:3000.000KHz SWT:Auto            Detector : Peak</p>
Avg.	<p>Site : 03CH13-HY            Condition : AVG_BE_54 3m HORN_91200_1241 VERTICAL            RBW:1000.000KHz VBW:3000.000KHz SWT:Auto            Detector : Peak</p>	Left blank

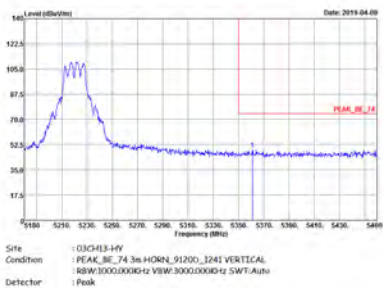
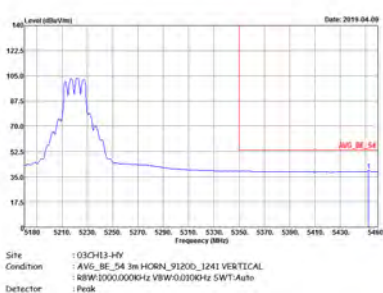

WIFI	Band 1 5150~5250MHz Band Edge @ 3m	
ANT	802.11a CH44 5220MHz - R	
1+2	Vertical	Fundamental
Peak		Left blank
Avg.		Left blank



WIFI	Band 1 5150~5250MHz Band Edge @ 3m	
ANT	802.11a CH48 5240MHz - L	
1+2	Horizontal	Fundamental
<p><b>Peak</b></p>		
<p><b>Avg.</b></p>		<p><b>Left blank</b></p>

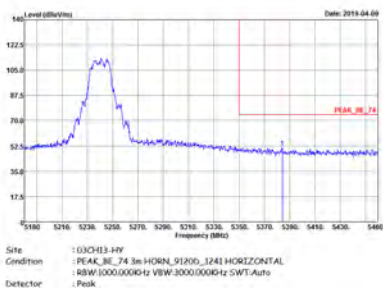
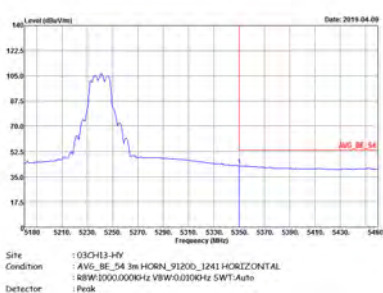

WIFI	Band 1 5150~5250MHz Band Edge @ 3m	
ANT	802.11a CH48 5240MHz - R	
1+2	Horizontal	Fundamental
Peak		Left blank
Avg.		Left blank

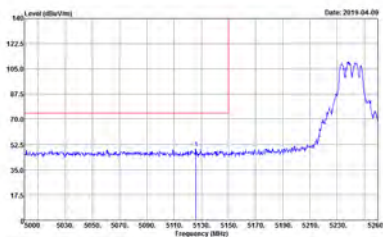
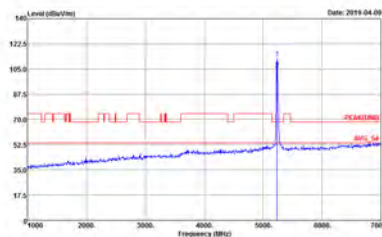
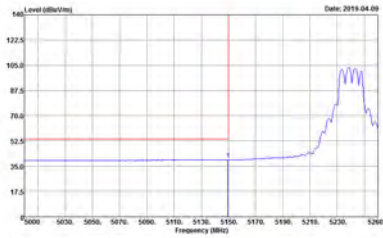

WIFI	Band 1 5150~5250MHz Band Edge @ 3m	
ANT	802.11a CH48 5240MHz - L	
1+2	Vertical	Fundamental
Peak	 <p>Site : 03CH13-HY Condition : PEAK_BE_74 3m HORN_91200_1241 VERTICAL RBW:1000.000kHz VSW:3000.000kHz SWT:Auto Detector : Peak</p>	 <p>Site : 03CH13-HY Condition : PEAK(FUN1) 3m HORN_91200_1241 VERTICAL RBW:1000.000kHz VSW:3000.000kHz SWT:Auto Detector : Peak</p>
Avg.	 <p>Site : 03CH13-HY Condition : AVIS_BE_54 3m HORN_91200_1241 VERTICAL RBW:1000.000kHz VSW:3000.000kHz SWT:Auto Detector : Peak</p>	Left blank

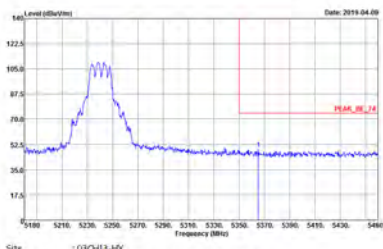
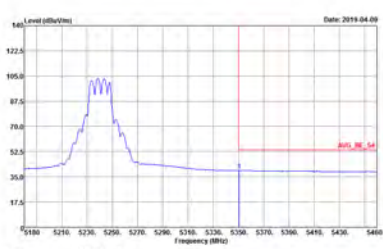

WIFI	Band 1 5150~5250MHz Band Edge @ 3m	
ANT	802.11a CH48 5240MHz - R	
1+2	Vertical	Fundamental
Peak	 <p>Site : 03CH3-HV            Condition : PEAK_BE_74 3m HORN_91200_1243 VERTICAL            RBW:000.000KHz VBW:3000.000KHz SWT:Auto            Detector : Peak</p>	Left blank
Avg.	 <p>Site : 03CH3-HV            Condition : Avg_BE_54 3m HORN_91200_1243 VERTICAL            RBW:000.000KHz VBW:3000.000KHz SWT:Auto            Detector : Peak</p>	Left blank



**Band 1 5150~5250MHz  
WIFI 802.11n HT20 (Band Edge @ 3m)**

WIFI	Band 1 5150~5250MHz Band Edge @ 3m	
ANT	802.11n HT20 CH36 5180MHz	
1+2	Horizontal	Fundamental
<b>Peak</b>	<p>Site : 03CH3-HY Condition : PEAK_BE_74 3m HORN_91200_1241 HORIZONTAL Detector : Peak</p>	<p>Site : 03CH3-HY Condition : PEAK(UNIT) 3m HORN_91200_1241 HORIZONTAL Detector : Peak</p>
<b>Avg.</b>	<p>Site : 03CH3-HY Condition : AVG_BE_54 3m HORN_91200_1241 HORIZONTAL Detector : Peak</p>	<b>Left blank</b>

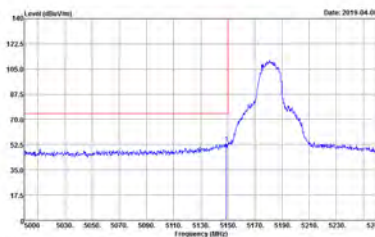
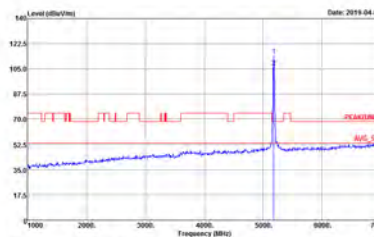
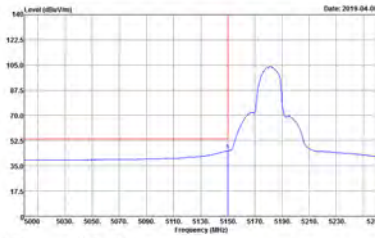

WIFI	Band 1 5150~5250MHz Band Edge @ 3m	
ANT	802.11n HT20 CH36 5180MHz	
1+2	Vertical	Fundamental
Peak	 <p>Site : 03CH13-MY Condition : PEAK_BE_74 3m HORN_91200_1241 VERTICAL RBW:1000.0000Hz VSW:3000.0000Hz SWT:Auto Detector : Peak</p>	 <p>Site : 03CH13-MY Condition : PEAK(LIN1) 3m HORN_91200_1241 VERTICAL RBW:1000.0000Hz VSW:3000.0000Hz SWT:Auto Detector : Peak</p>
Avg.	 <p>Site : 03CH13-MY Condition : AVG_BE_54 3m HORN_91200_1241 VERTICAL RBW:1000.0000Hz VSW:3000.0000Hz SWT:Auto Detector : Peak</p>	Left blank



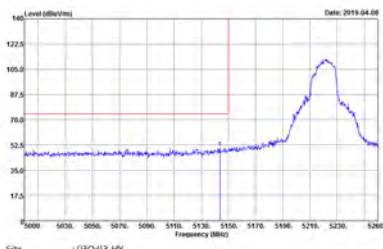
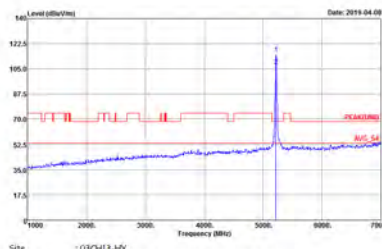
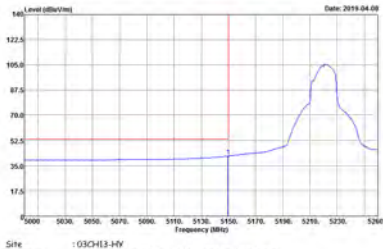

WIFI	Band 1 5150~5250MHz Band Edge @ 3m	
ANT	802.11n HT20 CH44 5220MHz - L	
1+2	Horizontal	Fundamental
Peak	 <p>Site : 03CH13-HV            Condition : PEAK_BE_74 3m HORN_91200_1241 HORIZONTAL            RBW:1000.0000Hz VSW:3000.0000Hz SWT:Auto            Detector : Peak</p>	 <p>Site : 03CH13-HV            Condition : PEAK(LIN1) 3m HORN_91200_1241 HORIZONTAL            RBW:1000.0000Hz VSW:3000.0000Hz SWT:Auto            Detector : Peak</p>
Avg.	 <p>Site : 03CH13-HV            Condition : AVG_BE_04 3m HORN_91200_1241 HORIZONTAL            RBW:1000.0000Hz VSW:3000.0000Hz SWT:Auto            Detector : Peak</p>	Left blank

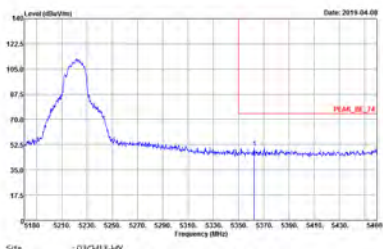
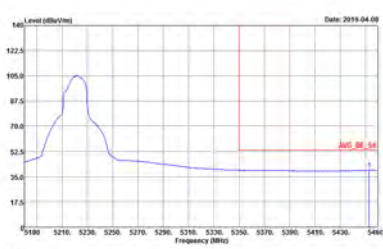

WIFI	Band 1 5150~5250MHz Band Edge @ 3m	
ANT	802.11n HT20 CH44 5220MHz - R	
1+2	Horizontal	Fundamental
<p><b>Peak</b></p>	 <p>Site : 03CH13-HV            Condition : PEAK_BE_74 3m HORN_9120D_1241 HORIZONTAL            RBW:3000.0000Hz VSW:3000.0000Hz SWT:Auto            Detector : Peak</p>	<p>Left blank</p>
<p><b>Avg.</b></p>	 <p>Site : 03CH13-HV            Condition : AVG_BE_54 3m HORN_9120D_1241 HORIZONTAL            RBW:3000.0000Hz VSW:3.0000Hz SWT:Auto            Detector : Peak</p>	<p>Left blank</p>



WIFI	Band 1 5150~5250MHz Band Edge @ 3m	
ANT	802.11n HT20 CH44 5220MHz - L	
1+2	Vertical	Fundamental
Peak	<p>Site : 03CH13-MY            Condition : PEAK_BE_74 3m HORN_91200_1241 VERTICAL            RBW:1000.0000Hz VSW:3000.0000Hz SWT:Auto            Detector : Peak</p>	<p>Site : 03CH13-MY            Condition : PEAK(FUN1) 3m HORN_91200_1241 VERTICAL            RBW:1000.0000Hz VSW:3000.0000Hz SWT:Auto            Detector : Peak</p>
Avg.	<p>Site : 03CH13-MY            Condition : AVG_BE_04 3m HORN_91200_1241 VERTICAL            RBW:1000.0000Hz VSW:3000.0000Hz SWT:Auto            Detector : Peak</p>	Left blank

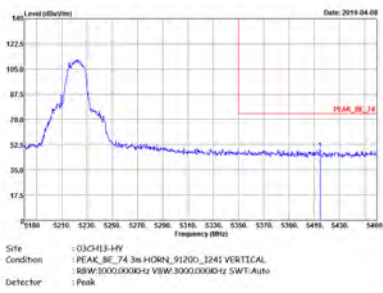
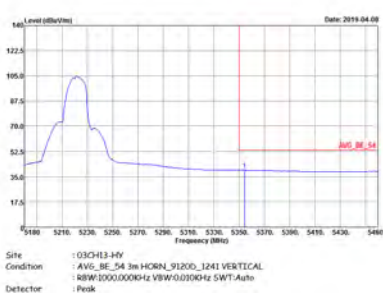

WIFI	Band 1 5150~5250MHz Band Edge @ 3m	
ANT	802.11n HT20 CH44 5220MHz - R	
1+2	Vertical	Fundamental
Peak		Left blank
Avg.		Left blank

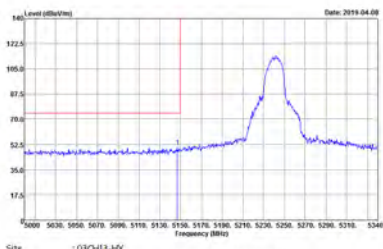
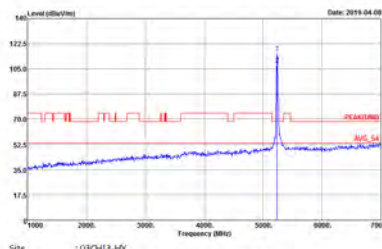
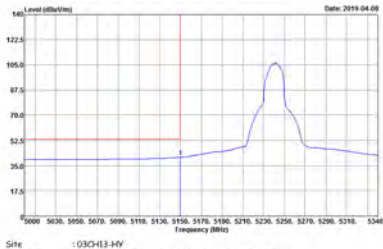

WIFI	Band 1 5150~5250MHz Band Edge @ 3m	
ANT	802.11n HT20 CH48 5240MHz - L	
1+2	Horizontal	Fundamental
<p><b>Peak</b></p>	 <p>Site : 03CH13-MY            Condition : PEAK_BE_74 3m HORN_91200_1241 HORIZONTAL            RBW:1000.0000Hz VBW:3000.0000Hz SWT:Auto            Detector : Peak</p>	 <p>Site : 03CH13-MY            Condition : PEAK(LIN1) 3m HORN_91200_1241 HORIZONTAL            RBW:1000.0000Hz VBW:3000.0000Hz SWT:Auto            Detector : Peak</p>
<p><b>Avg.</b></p>	 <p>Site : 03CH13-MY            Condition : AVG_BE_04 3m HORN_91200_1241 HORIZONTAL            RBW:1000.0000Hz VBW:3000.0000Hz SWT:Auto            Detector : Peak</p>	<p>Left blank</p>

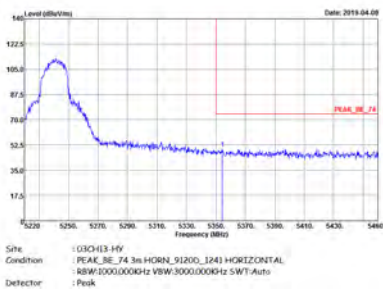
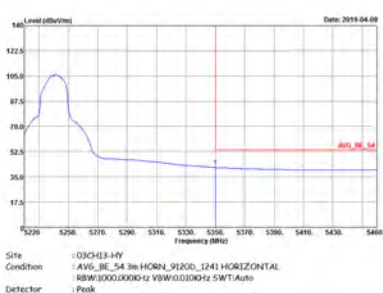

WIFI	Band 1 5150~5250MHz Band Edge @ 3m	
ANT	802.11n HT20 CH48 5240MHz - R	
1+2	Horizontal	Fundamental
Peak		Left blank
Avg.		Left blank



WIFI	Band 1 5150~5250MHz Band Edge @ 3m	
ANT	802.11n HT20 CH48 5240MHz - L	
1+2	Vertical	Fundamental
Peak	<p>Site : 03CH3-MY            Condition : PEAK_BE_74 3m HORN_91200_1241 VERTICAL            RBW:1000.0000Hz VBW:3000.0000Hz SWT:Auto            Detector : Peak</p>	<p>Site : 03CH3-MY            Condition : PEAK(FUN1) 3m HORN_91200_1241 VERTICAL            RBW:1000.0000Hz VBW:3000.0000Hz SWT:Auto            Detector : Peak</p>
Avg.	<p>Site : 03CH3-MY            Condition : AVG_BE_04 3m HORN_91200_1241 VERTICAL            RBW:1000.0000Hz VBW:3000.0000Hz SWT:Auto            Detector : Peak</p>	Left blank



WIFI	Band 1 5150~5250MHz Band Edge @ 3m	
ANT	802.11n HT20 CH48 5240MHz - R	
1+2	Vertical	Fundamental
Peak	<p>Site : 03CH3-HY Condition : PEAK_BE_74 3m HORN_91200_1241 VERTICAL RBW:1000.000kHz VBW:3000.000kHz SWT:Auto Detector : Peak</p>	Left blank
Avg.	<p>Site : 03CH3-HY Condition : AVE_BE_54 3m HORN_91200_1241 VERTICAL RBW:1000.000kHz VBW:3000.000kHz SWT:Auto Detector : Peak</p>	Left blank





**Band 1 5150~5250MHz  
WIFI 802.11n HT40 (Band Edge @ 3m)**

WIFI	Band 1 5150~5250MHz Band Edge @ 3m	
ANT	802.11n HT40 CH38 5190MHz - L	
1+2	Horizontal	Fundamental
<b>Peak</b>	<p>Site : 03CH3-HY Condition : PEAK_BE_74 3m HORN_91200_1241 HORIZONTAL RBW:3000.0000Hz VBW:3000.0000Hz SWT:Auto Detector : Peak</p>	<p>Site : 03CH3-HY Condition : PEAK(UNIT) 3m HORN_91200_1241 HORIZONTAL RBW:3000.0000Hz VBW:3000.0000Hz SWT:Auto Detector : Peak</p>
<b>Avg.</b>	<p>Site : 03CH3-HY Condition : AVG_BE_54 3m HORN_91200_1241 HORIZONTAL RBW:3000.0000Hz VBW:3.0000Hz SWT:Auto Detector : Peak</p>	<b>Left blank</b>



WIFI	Band 1 5150~5250MHz Band Edge @ 3m	
ANT	802.11n HT40 CH38 5190MHz - R	
1+2	Horizontal	Fundamental
Peak	<p>Site : 03CH13-HY Condition : PEAK_BE_74 3m HORN_91200_1241 HORIZONTAL RBW:1000.000kHz VBW:3000.000kHz SWT:Auto Detector : Peak</p>	Left blank
Avg.	<p>Site : 03CH13-HY Condition : AVG_BE_54 3m HORN_91200_1241 HORIZONTAL RBW:1000.000kHz VBW:3000.000kHz SWT:Auto Detector : Peak</p>	Left blank



WIFI	Band 1 5150~5250MHz Band Edge @ 3m	
ANT	802.11n HT40 CH38 5190MHz - L	
1+2	Vertical	Fundamental
Peak	<p>Site : 03CH13-HY Condition : PEAK_BE_74 3m HORN_91200_1241 VERTICAL RBW:1000.0000Hz VSW:3000.0000Hz SWT:Auto Detector : Peak</p>	<p>Site : 03CH13-HY Condition : PEAK(FUN1) 3m HORN_91200_1241 VERTICAL RBW:1000.0000Hz VSW:3000.0000Hz SWT:Auto Detector : Peak</p>
Avg.	<p>Site : 03CH13-HY Condition : AVG_BE_54 3m HORN_91200_1241 VERTICAL RBW:1000.0000Hz VSW:3000.0000Hz SWT:Auto Detector : Peak</p>	Left blank

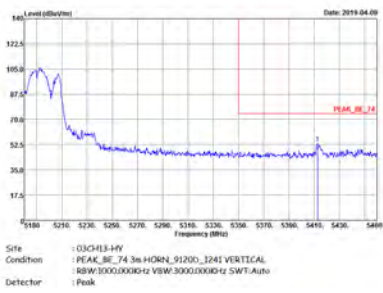
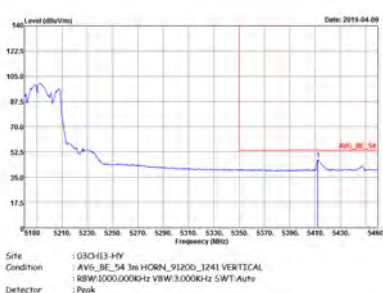

WIFI	Band 1 5150~5250MHz Band Edge @ 3m	
ANT	802.11n HT40 CH38 5190MHz - R	
1+2	Vertical	Fundamental
Peak		Left blank
Avg.		Left blank

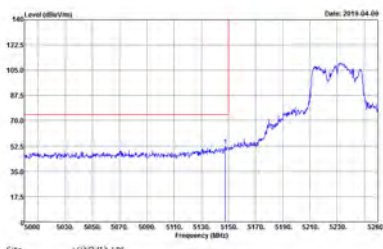
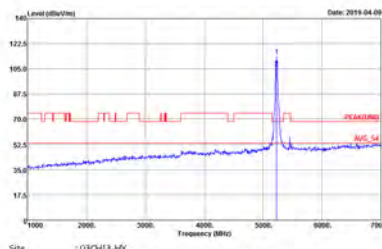
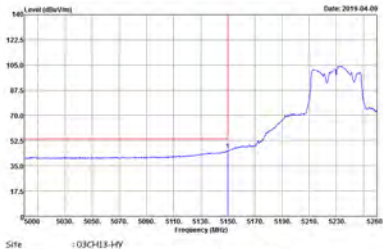

WIFI	Band 1 5150~5250MHz Band Edge @ 3m	
ANT	802.11n HT40 CH46 5230MHz - L	
1+2	Horizontal	Fundamental
Peak	 <p>Site : 03CH13-HY Condition : PEAK_BE_74 3m HORN_91200_1241 HORIZONTAL RBW:1000.0000Hz VSW:3000.0000Hz SWT:Auto Detector : Peak</p>	 <p>Site : 03CH13-HY Condition : PEAK(LIN1) 3m HORN_91200_1241 HORIZONTAL RBW:1000.0000Hz VSW:3000.0000Hz SWT:Auto Detector : Peak</p>
Avg.	 <p>Site : 03CH13-HY Condition : AVG_BE_54 3m HORN_91200_1241 HORIZONTAL RBW:1000.0000Hz VSW:3000.0000Hz SWT:Auto Detector : Peak</p>	Left blank

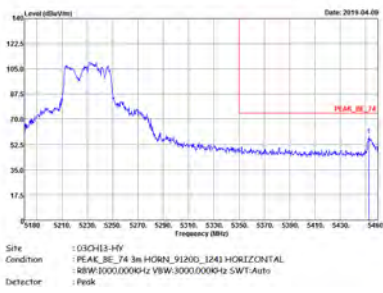
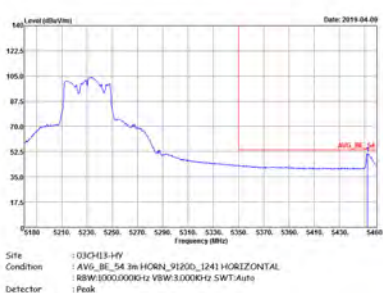

WIFI	Band 1 5150~5250MHz Band Edge @ 3m	
ANT	802.11n HT40 CH46 5230MHz - R	
1+2	Horizontal	Fundamental
Peak		Left blank
Avg.		Left blank

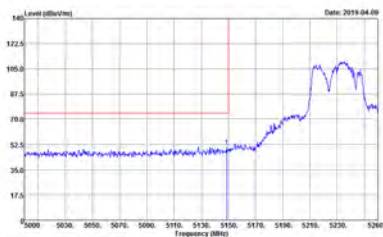
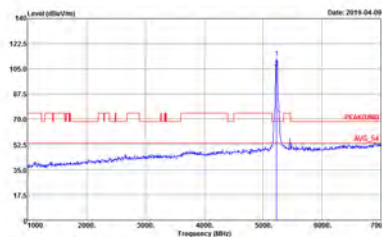
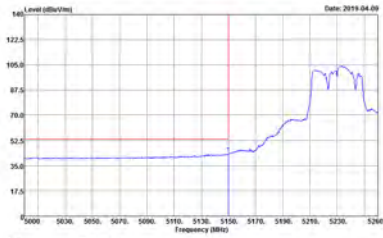

WIFI	Band 1 5150~5250MHz Band Edge @ 3m	
ANT	802.11n HT40 CH46 5230MHz - L	
1+2	Vertical	Fundamental
Peak	 <p>Site : 03CH3-4V            Condition : PEAK_BE_74 3m HORN_91200_1241 VERTICAL            RBW:1000.0000kHz VBW:3000.0000kHz SWT:Auto            Detector : Peak</p>	 <p>Site : 03CH3-4V            Condition : PEAK(FUN1) 3m HORN_91200_1241 VERTICAL            RBW:1000.0000kHz VBW:3000.0000kHz SWT:Auto            Detector : Peak</p>
Avg.	 <p>Site : 03CH3-4V            Condition : AVG_BE_04 3m HORN_91200_1241 VERTICAL            RBW:1000.0000kHz VBW:3000.0000kHz SWT:Auto            Detector : Peak</p>	Left blank

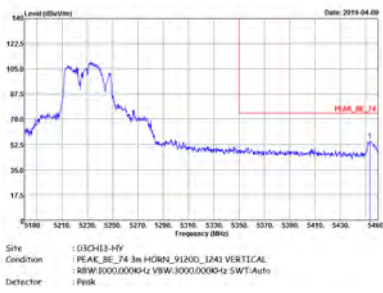
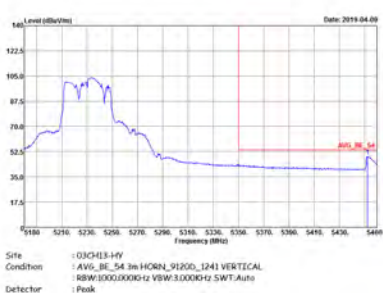

WIFI	Band 1 5150~5250MHz Band Edge @ 3m	
ANT	802.11n HT40 CH46 5230MHz - R	
1+2	Vertical	Fundamental
Peak		Left blank
Avg.		Left blank





**Band 1 5150~5250MHz**  
**WIFI 802.11ac VHT80 (Band Edge @ 3m)**

WIFI	Band 1 5150~5250MHz Band Edge @ 3m	
ANT	802.11ac VHT80 CH42 5210MHz - L	
1+2	Horizontal	Fundamental
<b>Peak</b>	<p>Site : 03CH13-HY            Condition : PEAK_BE_74 3m HORN_91200_1241 HORIZONTAL            RBW:3000.000Hz VBW:3000.000Hz SWT:Auto            Detector : Peak</p>	<p>Site : 03CH13-HY            Condition : PEAK(UNIT) 3m HORN_91200_1241 HORIZONTAL            RBW:3000.000Hz VBW:3000.000Hz SWT:Auto            Detector : Peak</p>
<b>Avg.</b>	<p>Site : 03CH13-HY            Condition : AVG_BE_54 3m HORN_91200_1241 HORIZONTAL            RBW:1000.000Hz VBW:3.000Hz SWT:Auto            Detector : Peak</p>	<p>Left blank</p>

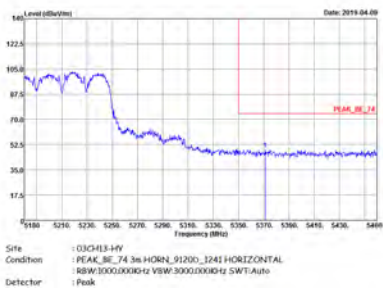
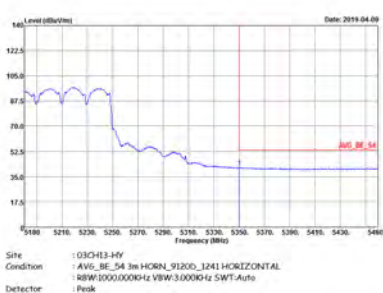

WIFI	Band 1 5150~5250MHz Band Edge @ 3m	
ANT	802.11ac VHT80 CH42 5210MHz - R	
1+2	Horizontal	Fundamental
Peak		Left blank
Avg.		Left blank

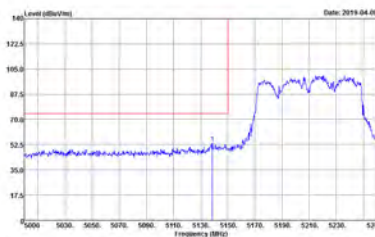
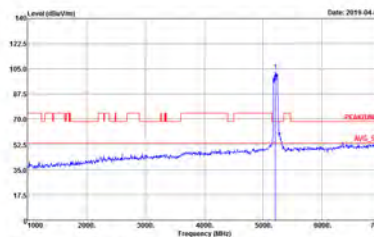
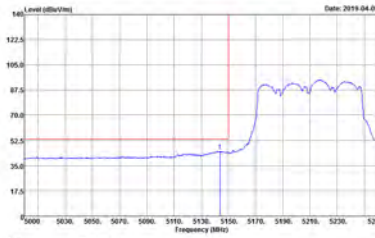

WIFI	Band 1 5150~5250MHz Band Edge @ 3m	
ANT	802.11ac VHT80 CH42 5210MHz - L	
1+2	Vertical	Fundamental
Peak	 <p>Site : 03CH13-MY            Condition : PEAK_BE_74 3m HORN_91200_1241 VERTICAL            RBW:1000.0000Hz VSW:3000.0000Hz SWT:Auto            Detector : Peak</p>	 <p>Site : 03CH13-MY            Condition : PEAK(LIN1) 3m HORN_91200_1241 VERTICAL            RBW:1000.0000Hz VSW:3000.0000Hz SWT:Auto            Detector : Peak</p>
Avg.	 <p>Site : 03CH13-MY            Condition : AVG_BE_04 3m HORN_91200_1241 VERTICAL            RBW:1000.0000Hz VSW:3.0000Hz SWT:Auto            Detector : Peak</p>	Left blank

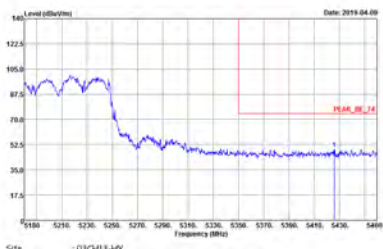
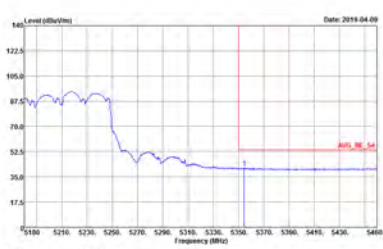

WIFI	Band 1 5150~5250MHz Band Edge @ 3m	
ANT	802.11ac VHT80 CH42 5210MHz - R	
1+2	Vertical	Fundamental
Peak	 <p>Site : 03CH3-HV            Condition : PEAK_BE_74 3m HORN_91200_1241 VERTICAL            RBW:3000.0000Hz VSW:3000.0000Hz SWF:Auto            Detector : Peak</p>	Left blank
Avg.	 <p>Site : 03CH3-HV            Condition : AVG_BE_54 3m HORN_91200_1241 VERTICAL            RBW:3000.0000Hz VSW:3000.0000Hz SWF:Auto            Detector : Peak</p>	Left blank



**Band 1 - 5150~5250MHz**  
**WIFI 802.11a (Harmonic @ 3m)**

<b>WIFI</b>	<b>Band 1 5150~5250MHz Harmonic @ 3m</b>	
<b>ANT</b>	<b>802.11a CH36 5180MHz</b>	
<b>1+2</b>	<b>Horizontal</b>	<b>Vertical</b>
<b>Peak</b> <b>Avg.</b>	<p>Site : 03CH13-HY          Condition : PEAK(UNIT) 3m HORN_91200_1241 HORIZONTAL          Detector : Peak</p>	<p>Site : 03CH13-HY          Condition : PEAK(UNIT) 3m HORN_91200_1241 VERTICAL          Detector : Peak</p>



WIFI	Band 1 5150~5250MHz Harmonic @ 3m	
ANT	802.11a CH44 5220MHz	
1+2	Horizontal	Vertical
Peak Avg.	<p>Site : 03CH13-HY Condition : PEAK(LINE1) 3m HORN_91200_1241 HORIZONTAL Detector : Peak</p>	<p>Site : 03CH13-HY Condition : PEAK(LINE1) 3m HORN_91200_1241 VERTICAL Detector : Peak</p>



WIFI	Band 1 5150~5250MHz Harmonic @ 3m	
ANT	802.11a CH48 5240MHz	
1+2	Horizontal	Vertical
Peak Avg.	<p>Site : 03CH13-HF Condition : PEAR(UNII) 3m HORN_91200_1241 HORIZONTAL Detector : Peak</p>	<p>Site : 03CH13-HF Condition : PEAR(UNII) 3m HORN_91200_1241 VERTICAL Detector : Peak</p>



**Band 1 5150~5250MHz**  
**WIFI 802.11n HT20 (Harmonic @ 3m)**

WIFI	Band 1 5150~5250MHz Harmonic @ 3m	
ANT	802.11n HT20 CH36 5180MHz	
1+2	Horizontal	Vertical
<p><b>Peak</b> <b>Avg.</b></p>	<p>Site : 03CH13-HV            Condition : PEAK(UNII) 3m HORN_91200_1241 HORIZONTAL            Detector : Peak</p>	<p>Site : 03CH13-HV            Condition : PEAK(UNII) 3m HORN_91200_1241 VERTICAL            Detector : Peak</p>



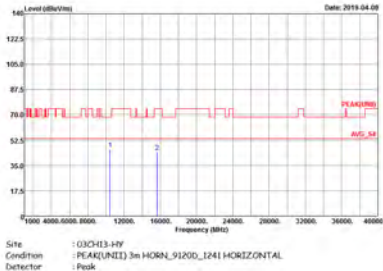
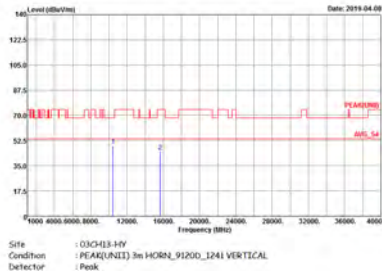

WIFI	Band 1 5150~5250MHz Harmonic @ 3m	
ANT	802.11n HT20 CH44 5220MHz	
1+2	Horizontal	Vertical
Peak Avg.	 <p>Site : 03CH13-HY Condition : PEAR(UNII) 3m HORN_91200_1241 HORIZONTAL Detector : Peak</p>	 <p>Site : 03CH13-HY Condition : PEAR(UNII) 3m HORN_91200_1241 VERTICAL Detector : Peak</p>



WIFI	Band 1 5150~5250MHz Harmonic @ 3m	
ANT	802.11n HT20 CH48 5240MHz	
1+2	Horizontal	Vertical
Peak Avg.	<p>Site : 03CH13-HF Condition : PEAR(UNII) 3m HORN_91200_1241 HORIZONTAL Detector : Peak</p>	<p>Site : 03CH13-HF Condition : PEAR(UNII) 3m HORN_91200_1241 VERTICAL Detector : Peak</p>

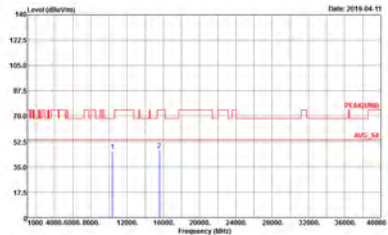
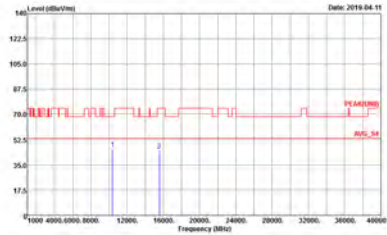

**Band 1 5150~5250MHz  
WIFI 802.11n HT40 (Harmonic @ 3m)**

WIFI	Band 1 5150~5250MHz Harmonic @ 3m	
ANT	802.11n HT40 CH38 5190MHz	
1+2	Horizontal	Vertical
<p align="center"><b>Peak Avg.</b></p>	 <p>Site : 03CH13-HY Condition : PEAK(UNII) 3m HORN_51200_1241 HORIZONTAL Detector : Peak</p>	 <p>Site : 03CH13-HY Condition : PEAK(UNII) 3m HORN_51200_1241 VERTICAL Detector : Peak</p>



WIFI	Band 1 5150~5250MHz Harmonic @ 3m	
ANT	802.11n HT40 CH46 5230MHz	
1+2	Horizontal	Vertical
Peak Avg.	<p>Site : 03CH13-HF Condition : PEAR(UNII) 3m HORN_91200_1241 HORIZONTAL Detector : Peak</p>	<p>Site : 03CH13-HF Condition : PEAR(UNII) 3m HORN_91200_1241 VERTICAL Detector : Peak</p>



**Band 1 5150~5250MHz  
WIFI 802.11ac VHT80 (Harmonic @ 3m)**

WIFI	Band 1 5150~5250MHz Harmonic @ 3m	
ANT	802.11ac VHT80 CH42 5210MHz	
1+2	Horizontal	Vertical
<p><b>Peak</b> <b>Avg.</b></p>	<p>Site : 03CH13-HY Condition : PEAK(UNII) 3m HORN_91200_1241 HORIZONTAL Detector : Peak</p>	<p>Site : 03CH13-HY Condition : PEAK(UNII) 3m HORN_91200_1241 VERTICAL Detector : Peak</p>



**Band 2 - 5250~5350MHz**  
**WIFI 802.11a (Band Edge @ 3m)**

WIFI	Band 2 5250~5350MHz Band Edge @ 3m	
ANT	802.11a CH52 5260MHz - L	
1+2	Horizontal	Fundamental
<b>Peak</b>	<p>Site : 03CH13-HY            Condition : PEAK_BE_74 3m HORN_91200_1241 HORIZONTAL            RBW:1000.0000Hz VSW:3000.0000Hz SWT:Auto            Detector : Peak</p>	<p>Site : 03CH13-HY            Condition : PEAK(FUN1) 3m HORN_91200_1241 HORIZONTAL            RBW:1000.0000Hz VSW:3000.0000Hz SWT:Auto            Detector : Peak</p>
<b>Avg.</b>	<p>Site : 03CH13-HY            Condition : AVG_BE_54 3m HORN_91200_1241 HORIZONTAL            RBW:1000.0000Hz VSW:0.0100Hz SWT:Auto            Detector : Peak</p>	<p>Left blank</p>



WIFI	Band 2 5250~5350MHz Band Edge @ 3m	
ANT	802.11a CH52 5260MHz - R	
1+2	Horizontal	Fundamental
<p><b>Peak</b></p>	<p>Site : 03CH13-HY            Condition : PEAK_BE_74 3m HORN_91200_1241 HORIZONTAL            RBW:1000.000kHz VBW:3000.000kHz SWT:Auto            Detector : Peak</p>	<p>Left blank</p>
<p><b>Avg.</b></p>	<p>Site : 03CH13-HY            Condition : AVG_BE_54 3m HORN_91200_1241 HORIZONTAL            RBW:1000.000kHz VBW:3000.000kHz SWT:Auto            Detector : Peak</p>	<p>Left blank</p>



WIFI	Band 2 5250~5350MHz Band Edge @ 3m	
ANT	802.11a CH52 5260MHz - L	
1+2	Vertical	Fundamental
Peak	<p>Site : 03CH13-HY            Condition : PEAK_BE_74 3m HORN_9120D_1241 VERTICAL            RBW:1000.0000Hz VSW:3000.0000Hz SWT:Auto            Detector : Peak</p>	<p>Site : 03CH13-HY            Condition : PEAK(FUN1) 3m HORN_9120D_1241 VERTICAL            RBW:1000.0000Hz VSW:3000.0000Hz SWT:Auto            Detector : Peak</p>
Avg.	<p>Site : 03CH13-HY            Condition : AVG_BE_54 3m HORN_9120D_1241 VERTICAL            RBW:1000.0000Hz VSW:3000.0000Hz SWT:Auto            Detector : Peak</p>	Left blank



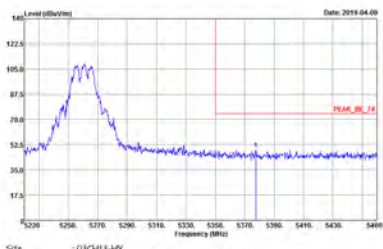
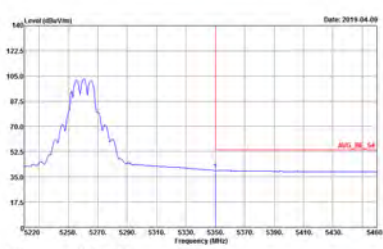

WIFI	Band 2 5250~5350MHz Band Edge @ 3m	
ANT	802.11a CH52 5260MHz - R	
1+2	Vertical	Fundamental
<p><b>Peak</b></p>	 <p>Site : 03CH3-HY            Condition : PEAK_BE_74 3m HORN_91200_1241 VERTICAL            RBW:3000.0000Hz VSW:3000.0000Hz SWF:Auto            Detector : Peak</p>	<p>Left blank</p>
<p><b>Avg.</b></p>	 <p>Site : 03CH3-HY            Condition : AVG_BE_54 3m HORN_91200_1241 VERTICAL            RBW:3000.0000Hz VSW:3000.0000Hz SWF:Auto            Detector : Peak</p>	<p>Left blank</p>

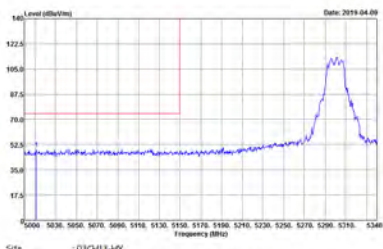
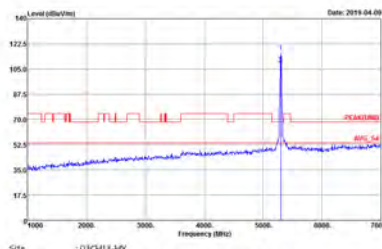
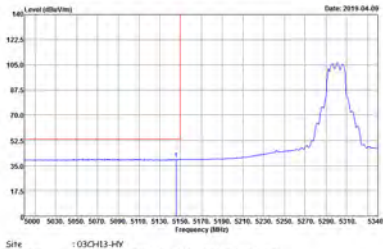

WIFI	Band 2 5250~5350MHz Band Edge @ 3m	
ANT	802.11a CH60 5300MHz - L	
1+2	Horizontal	Fundamental
Peak	 <p>Site : 03CH13-HY            Condition : PEAK_BE_74 3m HORN_91200_1241 HORIZONTAL            RBW:1000.0000Hz VSW:3000.0000Hz SWT:Auto            Detector : Peak</p>	 <p>Site : 03CH13-HY            Condition : PEAK(FUN1) 3m HORN_91200_1241 HORIZONTAL            RBW:1000.0000Hz VSW:3000.0000Hz SWT:Auto            Detector : Peak</p>
Avg.	 <p>Site : 03CH13-HY            Condition : AVG_BE_04 3m HORN_91200_1241 HORIZONTAL            RBW:1000.0000Hz VSW:31.0000Hz SWT:Auto            Detector : Peak</p>	Left blank



WIFI	Band 2 5250~5350MHz Band Edge @ 3m	
ANT	802.11a CH60 5300MHz - R	
1+2	Horizontal	Fundamental
Peak	<p>Site : Q3CH13-HY Condition : PEAK_BE_74 3m HORN_91200_1241 HORIZONTAL RBW:1000.000kHz VBW:3000.000kHz SWT:Auto Detector : Peak</p>	Left blank
Avg.	<p>Site : Q3CH13-HY Condition : AVG_BE_54 3m HORN_91200_1241 HORIZONTAL RBW:1000.000kHz VBW:3000.000kHz SWT:Auto Detector : Peak</p>	Left blank

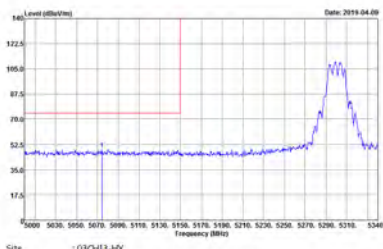
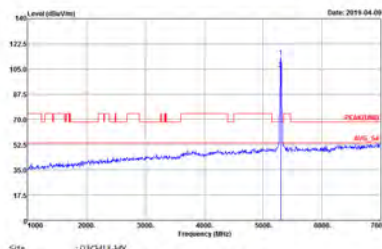
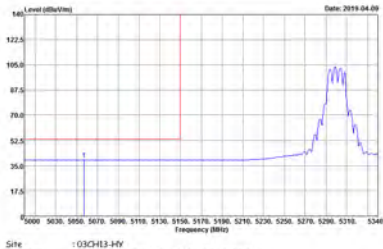

WIFI	Band 2 5250~5350MHz Band Edge @ 3m	
ANT	802.11a CH60 5300MHz - L	
1+2	Vertical	Fundamental
Peak	 <p>Site : 03CH3-HY            Condition : PEAK_BE_74 3m HORN_91200_1241 VERTICAL            RBW:1000.000kHz VBW:3000.000kHz SWT:Auto            Detector : Peak</p>	 <p>Site : 03CH3-HY            Condition : PEAK(UNI) 3m HORN_91200_1241 VERTICAL            RBW:1000.000kHz VBW:3000.000kHz SWT:Auto            Detector : Peak</p>
Avg.	 <p>Site : 03CH3-HY            Condition : AVG_BE_04 3m HORN_91200_1241 VERTICAL            RBW:1000.000kHz VBW:3000.000kHz SWT:Auto            Detector : Peak</p>	Left blank



WIFI	Band 2 5250~5350MHz Band Edge @ 3m	
ANT	802.11a CH60 5300MHz - R	
1+2	Vertical	Fundamental
<p><b>Peak</b></p>	<p>Site : 03CH13-HV            Condition : PEAK_BE_74 3m HORN_91200_1241 VERTICAL            RBW:1000.000kHz VBW:3000.000kHz SWT:Auto            Detector : Peak</p>	<p>Left blank</p>
<p><b>Avg.</b></p>	<p>Site : 03CH13-HV            Condition : AVG_BE_54 3m HORN_91200_1241 VERTICAL            RBW:1000.000kHz VBW:3000.000kHz SWT:Auto            Detector : Peak</p>	<p>Left blank</p>

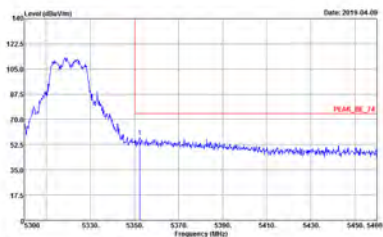
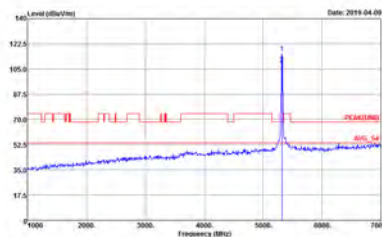
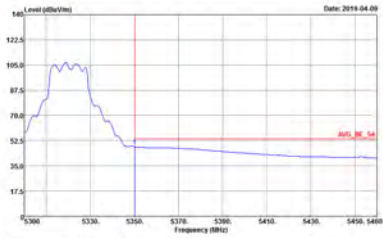

WIFI	Band 2 5250~5350MHz Band Edge @ 3m	
ANT	802.11a CH64 5320MHz	
1+2	Horizontal	Fundamental
Peak	 <p>Site : 03CH13-HY            Condition : PEAK_BE_74 3m HORN_91200_1241 HORIZONTAL            RBW:1000.0000Hz VSW:3000.0000Hz SWT:Auto            Detector : Peak</p>	 <p>Site : 03CH13-HY            Condition : PEAK(UNI) 3m HORN_91200_1241 HORIZONTAL            RBW:1000.0000Hz VSW:3000.0000Hz SWT:Auto            Detector : Peak</p>
Avg.	 <p>Site : 03CH13-HY            Condition : AVG_BE_54 3m HORN_91200_1241 HORIZONTAL            RBW:1000.0000Hz VSW:3000.0000Hz SWT:Auto            Detector : Peak</p>	Left blank



WIFI	Band 2 5250~5350MHz Band Edge @ 3m	
ANT	802.11a CH64 5320MHz	
1+2	Vertical	Fundamental
Peak	<p>Site : 03CH13-HY            Condition : PEAK_BE_74 3m HORN_9120D_1241 VERTICAL            RBW:1000.0000Hz VSW:3000.0000Hz SWT:Auto            Detector : Peak</p>	<p>Site : 03CH13-HY            Condition : PEAK(FUN1) 3m HORN_9120D_1241 VERTICAL            RBW:1000.0000Hz VSW:3000.0000Hz SWT:Auto            Detector : Peak</p>
Avg.	<p>Site : 03CH13-HY            Condition : AVG_BE_54 3m HORN_9120D_1241 VERTICAL            RBW:1000.0000Hz VSW:3000.0000Hz SWT:Auto            Detector : Peak</p>	Left blank



**Band 2 5250~5350MHz**  
**WIFI 802.11n HT20 (Band Edge @ 3m)**

WIFI	Band 2 5250~5350MHz Band Edge @ 3m	
ANT	802.11n HT20 CH52 5260MHz - L	
1+2	Horizontal	Fundamental
<b>Peak</b>	<p>Site : 03CH3-HY            Condition : PEAK_BE_74 3m HORN_91200_1241 HORIZONTAL            Detector : Peak</p>	<p>Site : 03CH3-HY            Condition : PEAK(UNEI) 3m HORN_91200_1241 HORIZONTAL            Detector : Peak</p>
<b>Avg.</b>	<p>Site : 03CH3-HY            Condition : AVG_BE_54 3m HORN_91200_1241 HORIZONTAL            Detector : Peak</p>	<b>Left blank</b>





WIFI	Band 2 5250~5350MHz Band Edge @ 3m	
ANT	802.11n HT20 CH52 5260MHz - R	
1+2	Horizontal	Fundamental
<p><b>Peak</b></p>	<p>Site : 03CH3-HY            Condition : PEAK_BE_74 3m HORN_91200_1243 HORIZONTAL            RBW:000.000kHz VBW:3000.000kHz SWT:Auto            Detector : Peak</p>	<p>Left blank</p>
<p><b>Avg.</b></p>	<p>Site : 03CH3-HY            Condition : AVG_BE_54 3m HORN_91200_1243 HORIZONTAL            RBW:000.000kHz VBW:3000.000kHz SWT:Auto            Detector : Peak</p>	<p>Left blank</p>



WIFI	Band 2 5250~5350MHz Band Edge @ 3m	
ANT	802.11n HT20 CH52 5260MHz - L	
1+2	Vertical	Fundamental
Peak	<p>Site : 03CH13-HV            Condition : PEAK_BE_74 3m HORN_91200_1241 VERTICAL            RBW:1000.0000Hz VSW:3000.0000Hz SWT:Auto            Detector : Peak</p>	<p>Site : 03CH13-HV            Condition : PEAK(LINE) 3m HORN_91200_1241 VERTICAL            RBW:1000.0000Hz VSW:3000.0000Hz SWT:Auto            Detector : Peak</p>
Avg.	<p>Site : 03CH13-HV            Condition : AVG_BE_04 3m HORN_91200_1241 VERTICAL            RBW:1000.0000Hz VSW:3000.0000Hz SWT:Auto            Detector : Peak</p>	Left blank

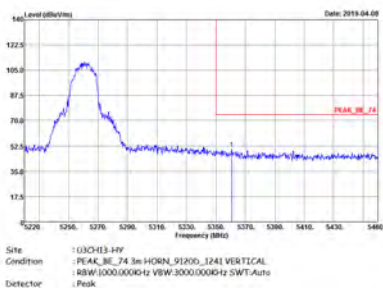
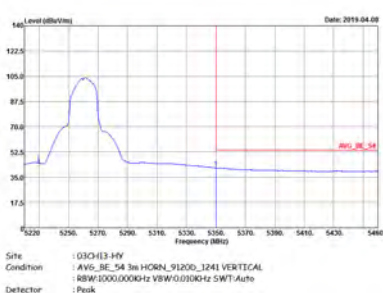

WIFI	Band 2 5250~5350MHz Band Edge @ 3m	
ANT	802.11n HT20 CH52 5260MHz - R	
1+2	Vertical	Fundamental
Peak		Left blank
Avg.		Left blank

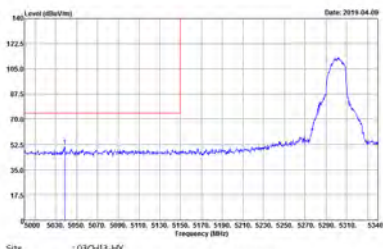
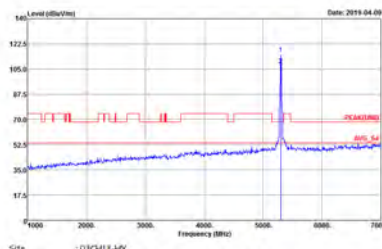
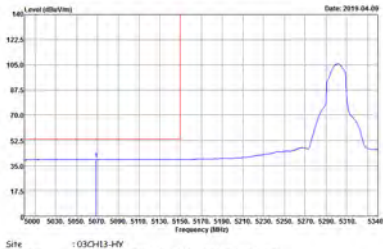

WIFI	Band 2 5250~5350MHz Band Edge @ 3m	
ANT	802.11n HT20 CH60 5300MHz - L	
1+2	Horizontal	Fundamental
<p><b>Peak</b></p>	 <p>Site : 03CH13-HV            Condition : PEAK_BE_74 3m HORN_91200_1241 HORIZONTAL            RBW:1000.000KHz VSW:3000.000KHz SWT:Auto            Detector : Peak</p>	 <p>Site : 03CH13-HV            Condition : PEAK(UNI) 3m HORN_91200_1241 HORIZONTAL            RBW:1000.000KHz VSW:3000.000KHz SWT:Auto            Detector : Peak</p>
<p><b>Avg.</b></p>	 <p>Site : 03CH13-HV            Condition : AVG_BE_04 3m HORN_91200_1241 HORIZONTAL            RBW:1000.000KHz VSW:3000.000KHz SWT:Auto            Detector : Peak</p>	<p>Left blank</p>

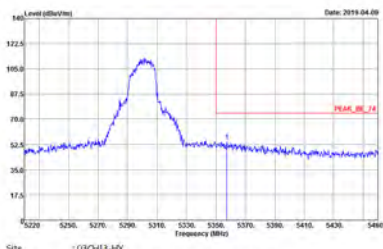
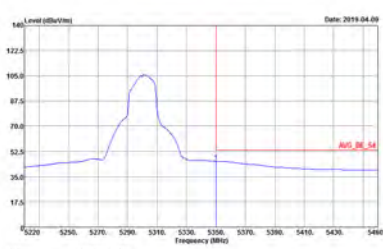

WIFI	Band 2 5250~5350MHz Band Edge @ 3m	
ANT	802.11n HT20 CH60 5300MHz - R	
1+2	Horizontal	Vertical
<p><b>Peak</b></p>	 <p>Site : 03CH3-HV            Condition : PEAK_BE_74 3m HORN_91200_1243 HORIZONTAL            RBW:0000.0000Hz VBW:3000.0000Hz SWT:Auto            Detector : Peak</p>	<p>Left blank</p>
<p><b>Avg.</b></p>	 <p>Site : 03CH3-HV            Condition : AVG_BE_54 3m HORN_91200_1241 HORIZONTAL            RBW:0000.0000Hz VBW:0.0000Hz SWT:Auto            Detector : Peak</p>	<p>Left blank</p>



WIFI	Band 2 5250~5350MHz Band Edge @ 3m	
ANT	802.11n HT20 CH60 5300MHz - L	
1+2	Vertical	Fundamental
Peak	<p>Site : 03CH3-HY            Condition : PEAK_BE_74 3m HORN_9120D_1241 VERTICAL            RBW:1000.0000Hz VSW:3000.0000Hz SWT:Auto            Detector : Peak</p>	<p>Site : 03CH3-HY            Condition : PEAK(FUN1) 3m HORN_9120D_1241 VERTICAL            RBW:1000.0000Hz VSW:3000.0000Hz SWT:Auto            Detector : Peak</p>
Avg.	<p>Site : 03CH3-HY            Condition : AVG_BE_54 3m HORN_9120D_1241 VERTICAL            RBW:1000.0000Hz VSW:3000.0000Hz SWT:Auto            Detector : Peak</p>	Left blank

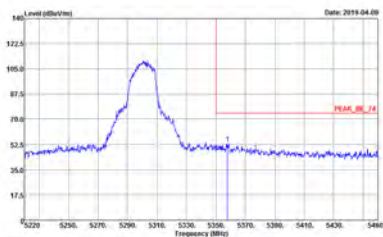
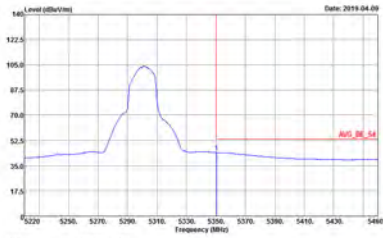

WIFI	Band 2 5250~5350MHz Band Edge @ 3m	
ANT	802.11n HT20 CH60 5300MHz - R	
1+2	Vertical	Fundamental
Peak	 <p>Site : 03CH3-HV            Condition : PEAK_BE_74 3m HORN_91200_1241 VERTICAL            RBW:000.0000Hz VBW:3000.0000Hz SWT:Auto            Detector : Peak</p>	Left blank
Avg.	 <p>Site : 03CH3-HV            Condition : AVG_BE_54 3m HORN_91200_1241 VERTICAL            RBW:000.0000Hz VBW:0.0000Hz SWT:Auto            Detector : Peak</p>	Left blank

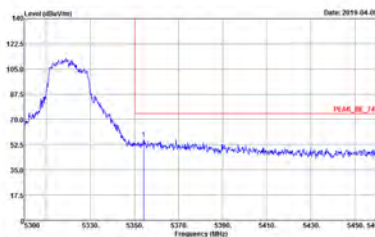
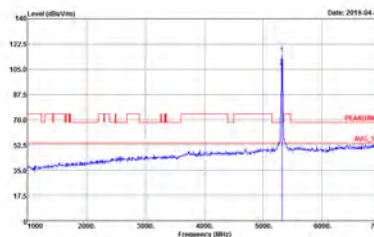
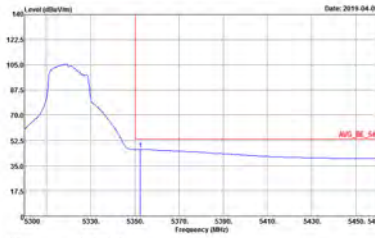

WIFI	Band 2 5250~5350MHz Band Edge @ 3m	
ANT	802.11n HT20 CH64 5320MHz	
1+2	Horizontal	Fundamental
Peak	 <p>Site : 03CH13-HY            Condition : PEAK_BE_74 3m HORN_91200_1241 HORIZONTAL            RBW:1000.000KHz VBW:3000.000KHz SWT:Auto            Detector : Peak</p>	 <p>Site : 03CH13-HY            Condition : PEAK(LINE) 3m HORN_91200_1241 HORIZONTAL            RBW:1000.000KHz VBW:3000.000KHz SWT:Auto            Detector : Peak</p>
Avg.	 <p>Site : 03CH13-HY            Condition : AVG_BE_54 3m HORN_91200_1241 HORIZONTAL            RBW:1000.000KHz VBW:3000.000KHz SWT:Auto            Detector : Peak</p>	Left blank







WIFI	Band 2 5250~5350MHz Band Edge @ 3m	
ANT	802.11n HT20 CH64 5320MHz	
1+2	Vertical	Fundamental
Peak	<p>Site : 03CH13-HV            Condition : PEAK_BE_74 3m HORN_91200_1241 VERTICAL            RBW:1000.000KHz VSW:3000.000KHz SWT:Auto            Detector : Peak</p>	<p>Site : 03CH13-HV            Condition : PEAK(FUN1) 3m HORN_91200_1241 VERTICAL            RBW:1000.000KHz VSW:3000.000KHz SWT:Auto            Detector : Peak</p>
Avg.	<p>Site : 03CH13-HV            Condition : AVG_BE_54 3m HORN_91200_1241 VERTICAL            RBW:1000.000KHz VSW:3000.000KHz SWT:Auto            Detector : Peak</p>	Left blank



**Band 2 5250~5350MHz**  
**WIFI 802.11n HT40 (Band Edge @ 3m)**

WIFI	Band 2 5250~5350MHz Band Edge @ 3m	
ANT	802.11n HT40 CH54 5270MHz - L	
1+2	Horizontal	Fundamental
<b>Peak</b>	<p>Site : 03CH13-HY            Condition : PEAK_BE_74 3m HORN_91200_1241 HORIZONTAL            RBW:1000.000kHz VBW:3000.000kHz SWT:Auto            Detector : Peak</p>	<p>Site : 03CH13-HY            Condition : PEAK(FUN)1 3m HORN_91200_1241 HORIZONTAL            RBW:1000.000kHz VBW:3000.000kHz SWT:Auto            Detector : Peak</p>
<b>Avg.</b>	<p>Site : 03CH13-HY            Condition : AVG_BE_54 3m HORN_91200_1241 HORIZONTAL            RBW:1000.000kHz VBW:3.000kHz SWT:Auto            Detector : Peak</p>	<p>Left blank</p>

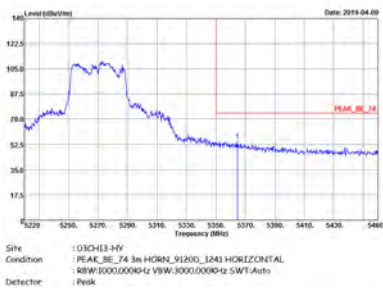

WIFI	Band 2 5250~5350MHz Band Edge @ 3m	
ANT	802.11n HT40 CH54 5270MHz - R	
1+2	Horizontal	Fundamental
Peak		Left blank
Avg.		Left blank

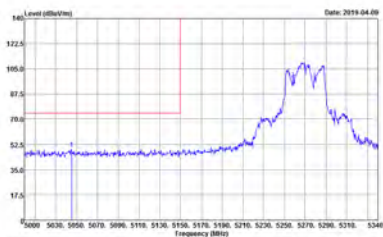
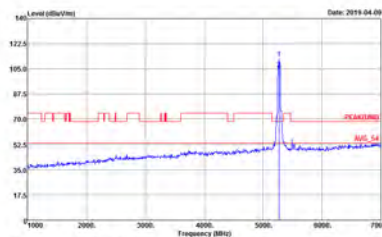
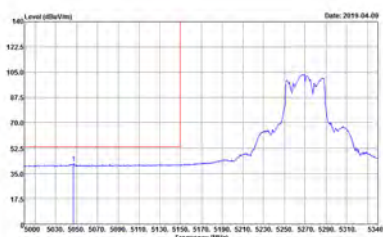

WIFI	Band 2 5250~5350MHz Band Edge @ 3m	
ANT	802.11n HT40 CH54 5270MHz - L	
1+2	Vertical	Vertical
Peak	 <p>Site : 03CH13-HY          Condition : PEAK_BE_74 3m HORN_91200_1241 VERTICAL          RBW:1000.0000Hz VSW:3000.0000Hz SWT:Auto          Detector : Peak</p>	 <p>Site : 03CH13-HY          Condition : PEAK(LIN1) 3m HORN_91200_1241 VERTICAL          RBW:1000.0000Hz VSW:3000.0000Hz SWT:Auto          Detector : Peak</p>
Avg.	 <p>Site : 03CH13-HY          Condition : AVG_BE_54 3m HORN_91200_1241 VERTICAL          RBW:1000.0000Hz VSW:3.0000Hz SWT:Auto          Detector : Peak</p>	Left blank

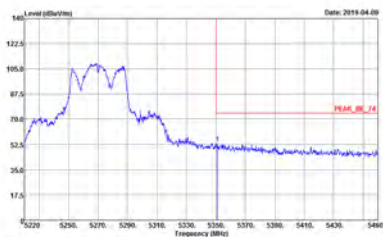
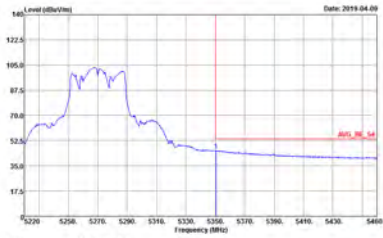

WIFI	Band 2 5250~5350MHz Band Edge @ 3m	
ANT	802.11n HT40 CH54 5270MHz - R	
1+2	Vertical	Vertical
Peak	 <p>Site : 03CH3-HY  Condition : PEAK_BE_74 3m HORN_91200_1241 VERTICAL  RBW:1000.000kHz VBW:3000.000kHz SWT:Auto  Detector : Peak</p>	Left blank
Avg.	 <p>Site : 03CH3-HY  Condition : AVG_BE_54 3m HORN_91200_1241 VERTICAL  RBW:1000.000kHz VBW:3000.000kHz SWT:Auto  Detector : Peak</p>	Left blank

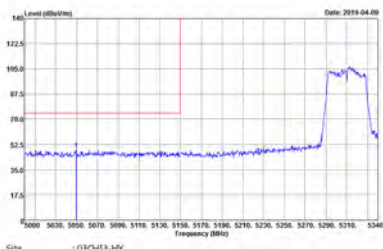
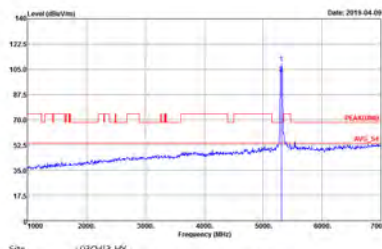
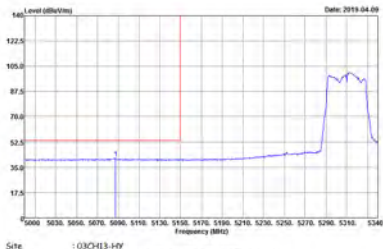

WIFI	Band 2 5250~5350MHz Band Edge @ 3m	
ANT	802.11n HT40 CH62 5310MHz - L	
1+2	Horizontal	Fundamental
<p><b>Peak</b></p>	 <p>Site : 03CH13-HY            Condition : PEAK_BE_74 3m HORN_91200_1241 HORIZONTAL            RBW:1000.000kHz VBW:3000.000kHz SWT:Auto            Detector : Peak</p>	 <p>Site : 03CH13-HY            Condition : PEAK(LINE) 3m HORN_91200_1241 HORIZONTAL            RBW:1000.000kHz VBW:3000.000kHz SWT:Auto            Detector : Peak</p>
<p><b>Avg.</b></p>	 <p>Site : 03CH13-HY            Condition : AVG_BE_54 3m HORN_91200_1241 HORIZONTAL            RBW:1000.000kHz VBW:3000.000kHz SWT:Auto            Detector : Peak</p>	<p>Left blank</p>



WIFI	Band 2 5250~5350MHz Band Edge @ 3m	
ANT	802.11n HT40 CH62 5310MHz - R	
1+2	Horizontal	Fundamental
Peak	<p>Site : 03CH3-HV Condition : PEAK_BE_74 3m HORN_9120D_1241 HORIZONTAL RBW:3000.0000Hz VSW:3000.0000Hz SWT:Auto Detector : Peak</p>	Left blank
Avg.	<p>Site : 03CH3-HV Condition : AVG_BE_54 3m HORN_9120D_1241 HORIZONTAL RBW:3000.0000Hz VSW:3000.0000Hz SWT:Auto Detector : Peak</p>	Left blank

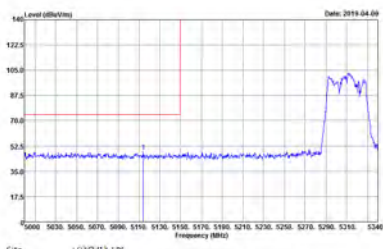
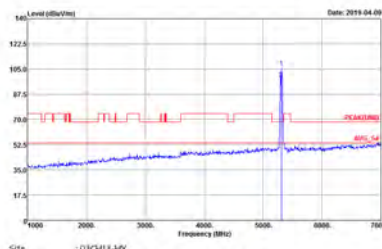
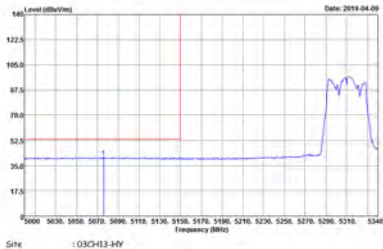

WIFI	Band 2 5250~5350MHz Band Edge @ 3m	
ANT	802.11n HT40 CH62 5310MHz - L	
1+2	Vertical	Fundamental
Peak	 <p>Site : 03CH13-HY            Condition : PEAK_BE_74 3m HORN_91200_1241 VERTICAL            RBW:1000.000KHz VSW:3000.000KHz SWT:Auto            Detector : Peak</p>	 <p>Site : 03CH13-HY            Condition : PEAK(FUN1) 3m HORN_91200_1241 VERTICAL            RBW:1000.000KHz VSW:3000.000KHz SWT:Auto            Detector : Peak</p>
Avg.	 <p>Site : 03CH13-HY            Condition : AVG_BE_04 3m HORN_91200_1241 VERTICAL            RBW:1000.000KHz VSW:3000.000KHz SWT:Auto            Detector : Peak</p>	Left blank



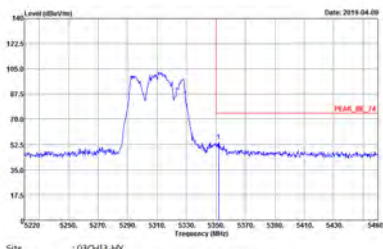
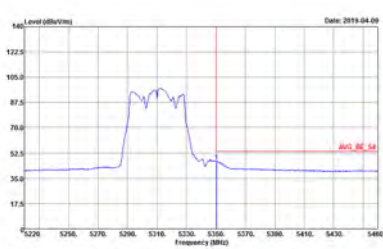

WIFI	Band 2 5250~5350MHz Band Edge @ 3m	
ANT	802.11n HT40 CH62 5310MHz - R	
1+2	Vertical	Fundamental
<p><b>Peak</b></p>	 <p>Site : 03CH13-HY            Condition : PEAK_BE_74 3m HORN_91200_1241 VERTICAL            RBW:1000.000kHz VBW:3000.000kHz SWT:Auto            Detector : Peak</p>	<p>Left blank</p>
<p><b>Avg.</b></p>	 <p>Site : 03CH13-HY            Condition : AVG_BE_54 3m HORN_91200_1241 VERTICAL            RBW:1000.000kHz VBW:3000.000kHz SWT:Auto            Detector : Peak</p>	<p>Left blank</p>



**Band 2 5250~5350MHz**  
**WIFI 802.11ac VHT80 (Band Edge @ 3m)**

WIFI	Band 2 5250~5350MHz Band Edge @ 3m	
ANT	802.11ac VHT80 CH58 5290MHz - L	
1+2	Horizontal	Fundamental
<b>Peak</b>	<p>Site : 03CH13-HY            Condition : PEAK_BE_74 3m HORN_91200_1241 HORIZONTAL            RBW:1000.000KHz VBW:3000.000KHz SWT:Auto            Detector : Peak</p>	<p>Site : 03CH13-HY            Condition : PEAK(UNIT) 3m HORN_91200_1241 HORIZONTAL            RBW:1000.000KHz VBW:3000.000KHz SWT:Auto            Detector : Peak</p>
<b>Avg.</b>	<p>Site : 03CH13-HY            Condition : AVG_BE_54 3m HORN_91200_1241 HORIZONTAL            RBW:1000.000KHz VBW:3.000KHz SWT:Auto            Detector : Peak</p>	<b>Left blank</b>



WIFI	Band 2 5250~5350MHz Band Edge @ 3m	
ANT	802.11ac VHT80 CH58 5290MHz - R	
1+2	Horizontal	Fundamental
<p><b>Peak</b></p>		<p>Left blank</p>
<p><b>Avg.</b></p>		<p>Left blank</p>

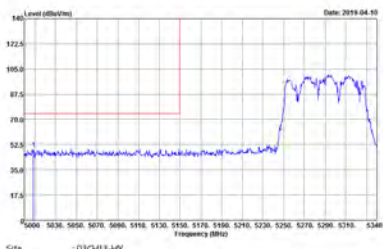
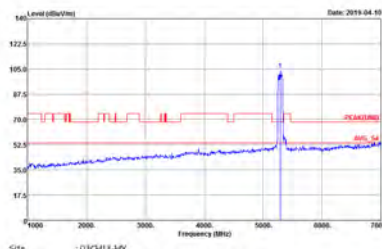
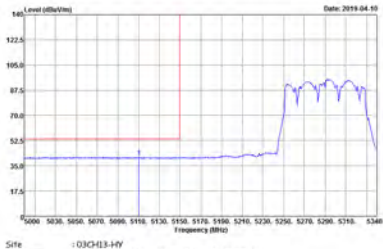

WIFI	Band 2 5250~5350MHz Band Edge @ 3m	
ANT	802.11ac VHT80 CH58 5290MHz - L	
1+2	Vertical	Fundamental
Peak	 <p>Site : 03CH13-HY            Condition : PEAK_BE_74 3m HORN_91200_1241 VERTICAL            RBW:1000.0000Hz VSW:3000.0000Hz SWT:Auto            Detector : Peak</p>	 <p>Site : 03CH13-HY            Condition : PEAK(UNI) 3m HORN_91200_1241 VERTICAL            RBW:1000.0000Hz VSW:3000.0000Hz SWT:Auto            Detector : Peak</p>
Avg.	 <p>Site : 03CH13-HY            Condition : AVG_BE_54 3m HORN_91200_1241 VERTICAL            RBW:1000.0000Hz VSW:3000.0000Hz SWT:Auto            Detector : Peak</p>	Left blank



WIFI	Band 2 5250~5350MHz Band Edge @ 3m	
ANT	802.11ac VHT80 CH58 5290MHz - R	
1+2	Vertical	Fundamental
Peak	<p>Site : 03CH3-HV Condition : PEAK_BE_74 3m HORN_9120D_1241 VERTICAL RBW:3000.000Hz VBW:3000.000Hz SWT:Auto Detector : Peak</p>	Left blank
Avg.	<p>Site : 03CH3-HV Condition : AVG_BE_54 3m HORN_9120D_1241 VERTICAL RBW:3000.000Hz VBW:3000.000Hz SWT:Auto Detector : Peak</p>	Left blank



**Band 2 - 5250~5350MHz**  
**WIFI 802.11a (Harmonic @ 3m)**

<b>WIFI</b>	<b>Band 2 5250~5350MHz Harmonic @ 3m</b>	
<b>ANT</b>	<b>802.11a CH52 5260MHz</b>	
<b>1+2</b>	<b>Horizontal</b>	<b>Vertical</b>
<b>Peak Avg.</b>	<p>Site : 03CH13-HV          Condition : PEAK(UNII) 3m HORN_91200_1241 HORIZONTAL          Detector : Peak</p>	<p>Site : 03CH13-HV          Condition : PEAK(UNII) 3m HORN_91200_1241 VERTICAL          Detector : Peak</p>

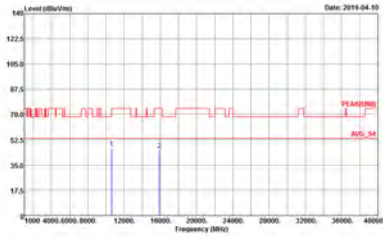
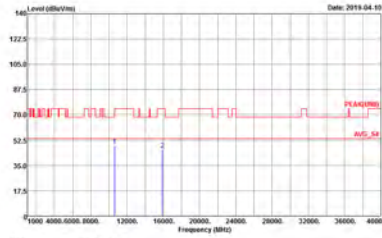

WIFI	Band 2 5250~5350MHz Harmonic @ 3m	
ANT	802.11a CH60 5300MHz	
1+2	Horizontal	Vertical
Peak Avg.	 <p>Site : 03CH13-HY Condition : PEAR[UNII] 3m HORN_91200_1241 HORIZONTAL Detector : Peak</p>	 <p>Site : 03CH13-HY Condition : PEAR[UNII] 3m HORN_91200_1241 VERTICAL Detector : Peak</p>

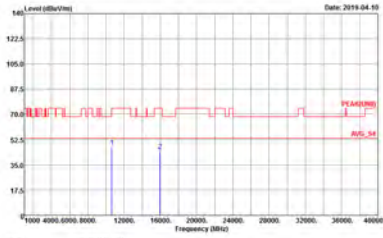
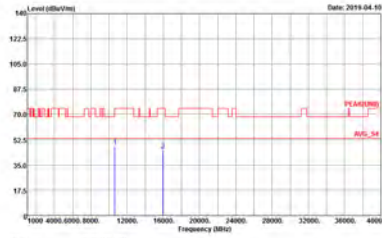

WIFI	Band 2 5250~5350MHz Harmonic @ 3m	
ANT	802.11a CH64 5320MHz	
1+2	Horizontal	Vertical
Peak Avg.	 <p>Site : 03CH13-HY Condition : PEAK(LINE1) 3m HORN_91200_1241 HORIZONTAL Detector : Peak</p>	 <p>Site : 03CH13-HY Condition : PEAK(LINE1) 3m HORN_91200_1241 VERTICAL Detector : Peak</p>





Band 2 5250~5350MHz  
WIFI 802.11n HT20 (Harmonic @ 3m)

WIFI	Band 2 5250~5350MHz Harmonic @ 3m	
ANT	802.11n HT20 CH52 5260MHz	
1+2	Horizontal	Vertical
Peak Avg.	<p>Site : 03CH13-HY Condition : PEAK(UNII) 3m HORN_91200_1241 HORIZONTAL Detector : Peak</p>	<p>Site : 03CH13-HY Condition : PEAK(UNII) 3m HORN_91200_1241 VERTICAL Detector : Peak</p>



WIFI	Band 2 5250~5350MHz Harmonic @ 3m	
ANT	802.11n HT20 CH60 5300MHz	
1+2	Horizontal	Vertical
Peak Avg.	<p>Site : 03CH13-HY Condition : PEAK(LINE) 3m HORN_91200_1241 HORIZONTAL Detector : Peak</p>	<p>Site : 03CH13-HY Condition : PEAK(LINE) 3m HORN_91200_1241 VERTICAL Detector : Peak</p>



WIFI	Band 2 5250~5350MHz Harmonic @ 3m	
ANT	802.11n HT20 CH64 5320MHz	
1+2	Horizontal	Vertical
Peak Avg.	<p>Site : 03CH13-HY Condition : PEAR[UNII] 3m HORN_91200_1241 HORIZONTAL Detector : Peak</p>	<p>Site : 03CH13-HY Condition : PEAR[UNII] 3m HORN_91200_1241 VERTICAL Detector : Peak</p>



Band 2 5250~5350MHz  
WIFI 802.11n HT40 (Harmonic @ 3m)

WIFI	Band 2 5250~5350MHz Harmonic @ 3m	
ANT	802.11n HT40 CH54 5270MHz	
1+2	Horizontal	Vertical
Peak Avg.	<p>Site : 03CH13-HY Condition : PEAK(UNII) 3m HORN_91200_1241 HORIZONTAL Detector : Peak</p>	<p>Site : 03CH13-HY Condition : PEAK(UNII) 3m HORN_91200_1241 VERTICAL Detector : Peak</p>



WIFI	Band 2 5250~5350MHz Harmonic @ 3m	
ANT	802.11n HT40 CH62 5310MHz	
1+2	Horizontal	Vertical
Peak Avg.	<p>Site : 03CH13-HY Condition : PEAK(LINE) 3m HORN_91200_1241 HORIZONTAL Detector : Peak</p>	<p>Site : 03CH13-HY Condition : PEAK(LINE) 3m HORN_91200_1241 VERTICAL Detector : Peak</p>



**Band 2 5250~5350MHz**  
**WIFI 802.11ac VHT80 (Harmonic @ 3m)**

WIFI	Band 2 5250~5350MHz Harmonic @ 3m	
ANT	802.11ac VHT80 CH58 5290MHz	
1+2	Horizontal	Vertical
Peak Avg.	<p>Site : 03CH13-HV Condition : PEAK(UNIT) 3m HORN_91200_1241 HORIZONTAL Detector : Peak</p>	<p>Site : 03CH13-HV Condition : PEAK(UNIT) 3m HORN_91200_1241 VERTICAL Detector : Peak</p>



**Band 3 - 5470~5725MHz**  
**WIFI 802.11a (Band Edge @ 3m)**

WIFI	Band 3 5470~5725MHz Band Edge @ 3m	
ANT	802.11a CH100 5500MHz	
1+2	Horizontal	Fundamental
Peak	<p>Site : 03CH13-HY            Condition : PEAK_RE(LINE1), B3 3m HORN, 91200_1241 HORIZONTAL            RBW:1000.0000Hz VBW:3000.0000Hz SWT:Auto            Detector : Peak</p>	<p>Site : 03CH13-HY            Condition : PEAK(LINE1) 3m HORN, 91200_1241 HORIZONTAL            RBW:1000.0000Hz VBW:3000.0000Hz SWT:Auto            Detector : Peak</p>
Avg.	<p>Site : 03CH13-HY            Condition : AVG_RE(LINE1), B3 3m HORN, 91200_1241 HORIZONTAL            RBW:1000.0000Hz VBW:3000.0000Hz SWT:Auto            Detector : Peak</p>	Left blank



WIFI	Band 3 5470~5725MHz Band Edge @ 3m	
ANT	802.11a CH100 5500MHz	
1+2	Vertical	Fundamental
<p><b>Peak</b></p>	<p>Site : 03CH13-MY            Condition : PEAK_BE(UNII)_B3 3m HORN_91200_1241 VERTICAL            RBW:1000.0000kHz VBW:3000.0000kHz SWT:Auto            Detector : Peak</p>	<p>Site : 03CH13-MY            Condition : PEAK(UNII) 3m HORN_91200_1241 VERTICAL            RBW:1000.0000kHz VBW:3000.0000kHz SWT:Auto            Detector : Peak</p>
<p><b>Avg.</b></p>	<p>Site : 03CH13-MY            Condition : AVG_BE(UNII)_B3 3m HORN_91200_1241 VERTICAL            RBW:1000.0000kHz VBW:3000.0000kHz SWT:Auto            Detector : Peak</p>	<p><b>Left blank</b></p>



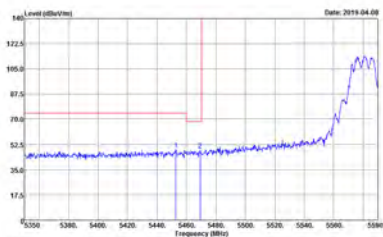
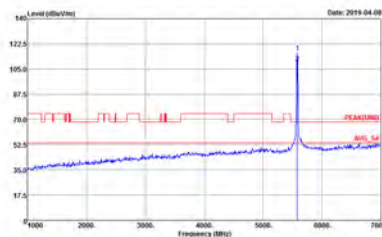
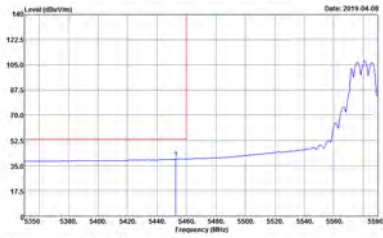

WIFI	Band 3 5470~5725MHz Band Edge @ 3m	
ANT	802.11a CH116 5580MHz - L	
1+2	Horizontal	Fundamental
<p><b>Peak</b></p>	 <p>Site : 03CH13-MY            Condition : PEAK_BE(UNIT)_B3 3m HORN_91200_1241 HORIZONTAL            RBW:1000.0000Hz VBW:3000.0000Hz SWT:Auto            Detector : Peak</p>	 <p>Site : 03CH13-MY            Condition : PEAK(UNIT) 3m HORN_91200_1241 HORIZONTAL            RBW:1000.0000Hz VBW:3000.0000Hz SWT:Auto            Detector : Peak</p>
<p><b>Avg.</b></p>	 <p>Site : 03CH13-MY            Condition : AVG_BE(UNIT)_B3 3m HORN_91200_1241 HORIZONTAL            RBW:1000.0000Hz VBW:3000.0000Hz SWT:Auto            Detector : Peak</p>	<p><b>Left blank</b></p>

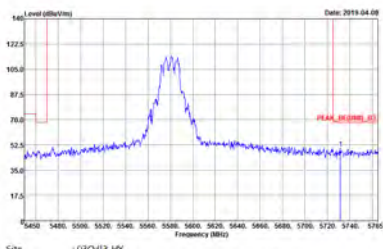

WIFI	Band 3 5470~5725MHz Band Edge @ 3m	
ANT	802.11a CH116 5580MHz - R	
1+2	Horizontal	Fundamental
Peak	 <p>Site : DISCH13-HY Condition : PEAK_BE([UNIT]),_B3 3m HCRN_51200_1241 HORIZONTAL RBW:1000.000kHz VBW:3000.000kHz SWT:Auto Detector : Peak</p>	Left blank

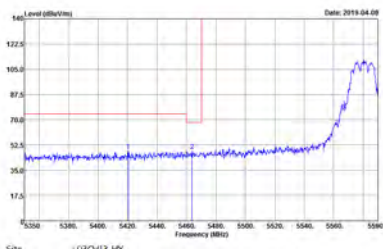
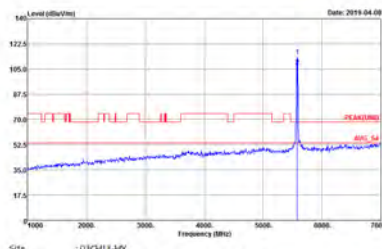
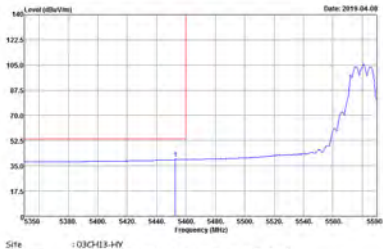

WIFI	Band 3 5470~5725MHz Band Edge @ 3m	
ANT	802.11a CH116 5580MHz - L	
1+2	Vertical	Fundamental
<p><b>Peak</b></p>	 <p>Site : 03CH13-HY            Condition : PEAK_BE(UNII)_B3 3m HORN_91200_1241 VERTICAL            RBW:1000.0000Hz VSW:3000.0000Hz SWT:Auto            Detector : Peak</p>	 <p>Site : 03CH13-HY            Condition : PEAK(UNII)_B3 3m HORN_91200_1241 VERTICAL            RBW:1000.0000Hz VSW:3000.0000Hz SWT:Auto            Detector : Peak</p>
<p><b>Avg.</b></p>	 <p>Site : 03CH13-HY            Condition : AVG_BE(UNII)_B3 3m HORN_91200_1241 VERTICAL            RBW:1000.0000Hz VSW:3000.0000Hz SWT:Auto            Detector : Peak</p>	<p><b>Left blank</b></p>

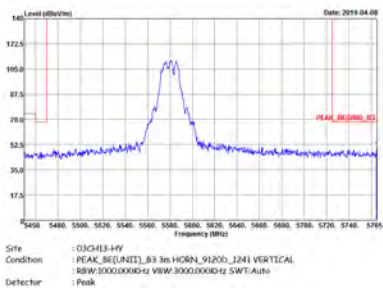

WIFI	Band 3 5470~5725MHz Band Edge @ 3m	
ANT	802.11a CH116 5580MHz - R	
1+2	Vertical	Fundamental
Peak		Left blank



WIFI	Band 3 5470~5725MHz Band Edge @ 3m	
ANT	802.11a CH140 5700MHz	
1+2	Horizontal	Fundamental
Peak	<p>Site : 03CHL3-MY Condition : PEAK_BE([UNIT],_B3 3m HORN_91200_124) HORIZONTAL RBW:1000.0000Hz VSW:3000.0000Hz SWT:Auto Detector : Peak</p>	<p>Site : 03CHL3-MY Condition : PEAK([UNIT]) 3m HORN_91200_124) HORIZONTAL RBW:1000.0000Hz VSW:3000.0000Hz SWT:Auto Detector : Peak</p>



WIFI	Band 3 5470~5725MHz Band Edge @ 3m	
ANT	802.11a CH140 5700MHz	
1+2	Vertical	Fundamental
Peak	<p>Site : 03CH13-MY Condition : PEAK_B3(UNII)_B3 3m HORN_91200_1241 VERTICAL RBW:1000.0000Hz VSW:3000.0000Hz SWT:Auto Detector : Peak</p>	<p>Site : 03CH13-MY Condition : PEAK(UNII) 3m HORN_91200_1241 VERTICAL RBW:1000.0000Hz VSW:3000.0000Hz SWT:Auto Detector : Peak</p>



**Band 3 5470~5725MHz  
WIFI 802.11n HT20 (Band Edge @ 3m)**

WIFI	Band 3 5470~5725MHz Band Edge @ 3m	
ANT	802.11n HT20 CH100 5500MHz	
1+2	Horizontal	Fundamental
<b>Peak</b>	<p>Site : 03CH13-HV Condition : PEAK_BE(UNIT)_B3 3m HORN_91200_1241 HORIZONTAL Detector : Peak</p>	<p>Site : 03CH13-HV Condition : PEAK(UNIT) 3m HORN_91200_1241 HORIZONTAL Detector : Peak</p>
<b>Avg.</b>	<p>Site : 03CH13-HV Condition : AVG_BE(UNIT)_B3 3m HORN_91200_1241 HORIZONTAL Detector : Peak</p>	<b>Left blank</b>

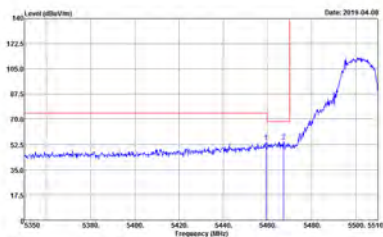
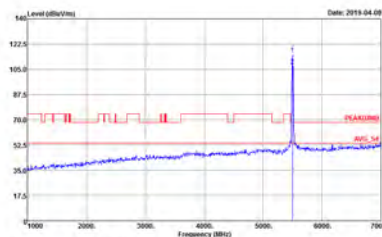
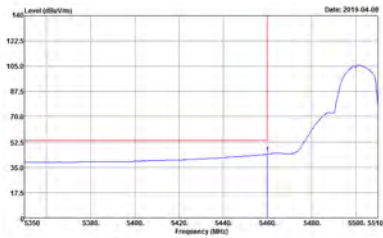

WIFI	Band 3 5470~5725MHz Band Edge @ 3m	
ANT	802.11n HT20 CH100 5500MHz	
1+2	Vertical	Fundamental
<p><b>Peak</b></p>	 <p>Site : 03CH13-HY            Condition : PEAK_BE(UNIT)_B3 3m HORN_51200_1241 VERTICAL            RBW:1000.000kHz VBW:3000.000kHz SWT:Auto            Detector : Peak</p>	 <p>Site : 03CH13-HY            Condition : PEAK(UNIT)_B3 3m HORN_51200_1241 VERTICAL            RBW:1000.000kHz VBW:3000.000kHz SWT:Auto            Detector : Peak</p>
<p><b>Avg.</b></p>	 <p>Site : 03CH13-HY            Condition : AVG_BE(UNIT)_B3 3m HORN_51200_1241 VERTICAL            RBW:1000.000kHz VBW:3000.000kHz SWT:Auto            Detector : Peak</p>	<p><b>Left blank</b></p>



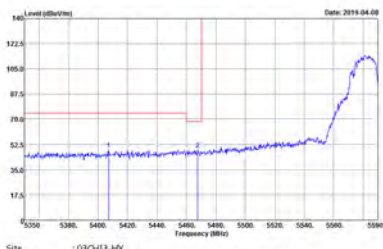
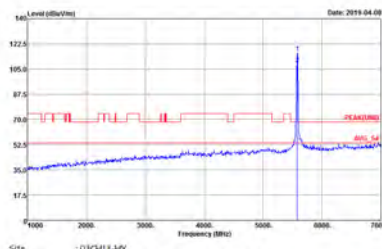
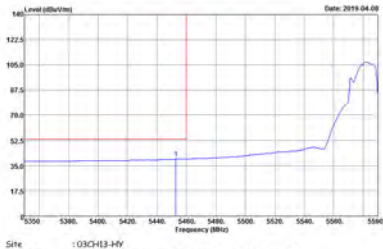

WIFI	Band 3 5470~5725MHz Band Edge @ 3m	
ANT	802.11n HT20 CH116 5580MHz - L	
1+2	Horizontal	Fundamental
<p><b>Peak</b></p>	 <p>Site : 03CH13-HY            Condition : PEAK_BE(UNIT)_B3 3m HORN_91200_1241 HORIZONTAL            RBW:1000.000kHz VSW:3000.000kHz SWT:Auto            Detector : Peak</p>	 <p>Site : 03CH13-HY            Condition : PEAK(UNIT)_3m HORN_91200_1241 HORIZONTAL            RBW:1000.000kHz VSW:3000.000kHz SWT:Auto            Detector : Peak</p>
<p><b>Avg.</b></p>	 <p>Site : 03CH13-HY            Condition : AVG_BE(UNIT)_B3 3m HORN_91200_1241 HORIZONTAL            RBW:1000.000kHz VSW:3000.000kHz SWT:Auto            Detector : Peak</p>	<p>Left blank</p>

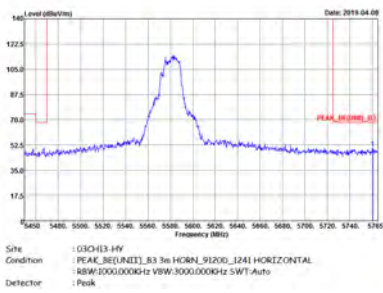

WIFI	Band 3 5470~5725MHz Band Edge @ 3m	
ANT	802.11n HT20 CH116 5580MHz - R	
1+2	Horizontal	Fundamental
Peak	 <p>Site : DISCH13-HY Condition : PEAK_BE[UNIT],_B3 3m HCRN_51200_1241 HORIZONTAL RBW:1000.000kHz VSW:3000.000kHz SWT:Auto Detector : Peak</p>	Left blank



WIFI	Band 3 5470~5725MHz Band Edge @ 3m	
ANT	802.11n HT20 CH116 5580MHz - L	
1+2	Vertical	Fundamental
<p><b>Peak</b></p>	<p>Site : 03CH13-MY            Condition : PEAK_BE[UNII], 83 3m HORN_91200_1241 VERTICAL            RBW:1000.0000kHz VSW:3000.0000kHz SWT:Auto            Detector : Peak</p>	<p>Site : 03CH13-MY            Condition : PEAK[UNII] 3m HORN_91200_1241 VERTICAL            RBW:1000.0000kHz VSW:3000.0000kHz SWT:Auto            Detector : Peak</p>
<p><b>Avg.</b></p>	<p>Site : 03CH13-MY            Condition : AVG_BE[UNII], 83 3m HORN_91200_1241 VERTICAL            RBW:1000.0000kHz VSW:3000.0000kHz SWT:Auto            Detector : Peak</p>	<p><b>Left blank</b></p>



WIFI	Band 3 5470~5725MHz Band Edge @ 3m	
ANT	802.11n HT20 CH116 5580MHz - R	
1+2	Vertical	Fundamental
Peak	<p>Site : 03CH16-HY Condition : PEAK_BE([UNIT]_B3 3m HORN_91200_124) VERTICAL RBW:3000.0000Hz VBW:3000.0000Hz SWF:Auto Detector : Peak</p>	Left blank



WIFI	Band 3 5470~5725MHz Band Edge @ 3m	
ANT	802.11n HT20 CH140 5700MHz	
1+2	Horizontal	Fundamental
<p><b>Peak</b></p>		



WIFI	Band 3 5470~5725MHz Band Edge @ 3m	
ANT	802.11n HT20 CH140 5700MHz	
1+2	Vertical	Fundamental
<p>Peak.</p>	<p>Site : 03CH12-MY            Condition : PEAK_BE([UNIT], B3 3m HORN_91200_1241) VERTICAL            RBW:1000.0000Hz VSW:3000.0000Hz SWT:Auto            Detector : Peak</p>	<p>Site : 03CH12-MY            Condition : PEAK([UNIT]) 3m HORN_91200_1241) VERTICAL            RBW:1000.0000Hz VSW:3000.0000Hz SWT:Auto            Detector : Peak</p>



**Band 3 5470~5725MHz  
WIFI 802.11n HT40 (Band Edge @ 3m)**

WIFI	Band 3 5470~5725MHz Band Edge @ 3m	
ANT	802.11n HT40 CH102 5510MHz - L	
1+2	Horizontal	Fundamental
Peak	<p>Site : 03CH13-HV Condition : PEAK_BE[UNIT1]_B3 3m HORN_91200_1241 HORIZONTAL RBW:3000.000kHz VBW:3000.000kHz SWT:Auto Detector : Peak</p>	<p>Site : 03CH13-HV Condition : PEAK[UNIT1] 3m HORN_91200_1241 HORIZONTAL RBW:3000.000kHz VBW:3000.000kHz SWT:Auto Detector : Peak</p>
Avg.	<p>Site : 03CH13-HV Condition : AVG_BE[UNIT1]_B3 3m HORN_91200_1241 HORIZONTAL RBW:3000.000kHz VBW:3.000kHz SWT:Auto Detector : Peak</p>	Left blank

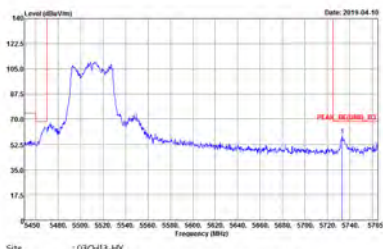

WIFI	Band 3 5470~5725MHz Band Edge @ 3m	
ANT	802.11n HT40 CH102 5510MHz - R	
1+2	Horizontal	Fundamental
Peak	 <p>Site : 03CH12-HV Condition : PEAK_BE(UNIT)_B3 3m HORN_51200_1241 HORIZONTAL RBW:1000.000kHz VBW:3000.000kHz SWT:Auto Detector : Peak</p>	Left blank



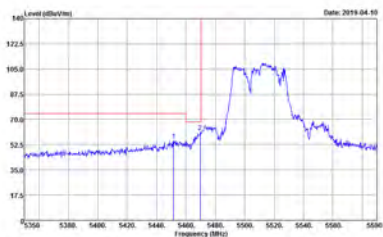
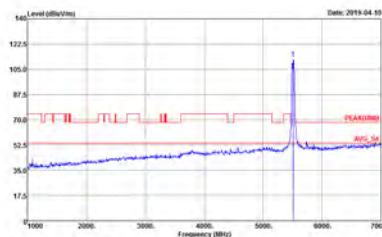
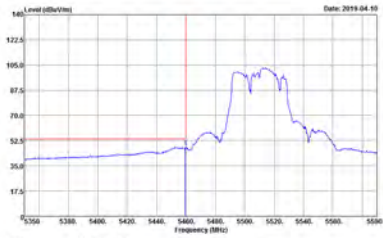

WIFI	Band 3 5470~5725MHz Band Edge @ 3m	
ANT	802.11n HT40 CH102 5510MHz - L	
1+2	Vertical	Fundamental
<p><b>Peak</b></p>	 <p>Site : 03CH13-HY            Condition : PEAK_BE(UNIT)_B3 3m HORN_91200_1241 VERTICAL            RBW:1000.0000Hz VBW:3000.0000Hz SWT:Auto            Detector : Peak</p>	 <p>Site : 03CH13-HY            Condition : PEAK(UNIT)_3m HORN_91200_1241 VERTICAL            RBW:1000.0000Hz VBW:3000.0000Hz SWT:Auto            Detector : Peak</p>
<p><b>Avg.</b></p>	 <p>Site : 03CH13-HY            Condition : AVG_BE(UNIT)_B3 3m HORN_91200_1241 VERTICAL            RBW:1000.0000Hz VBW:3000.0000Hz SWT:Auto            Detector : Peak</p>	<p>Left blank</p>



WIFI	Band 3 5470~5725MHz Band Edge @ 3m	
ANT	802.11n HT40 CH102 5510MHz - R	
1+2	Vertical	Fundamental
Peak	<p>Site : 03CH13-HY Condition : PEAK_BE([UNIT],_B3 3m HORN_91200_124) VERTICAL RBW:1000.0000Hz VBW:3000.0000Hz SWF:Auto Detector : Peak</p>	Left blank

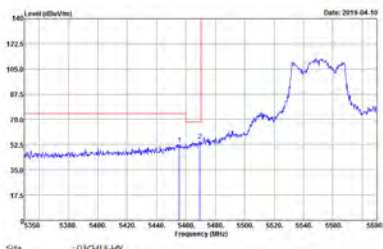
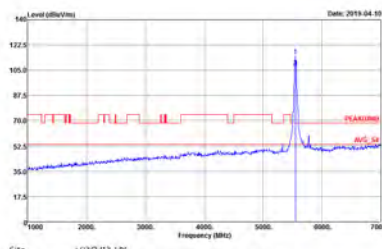
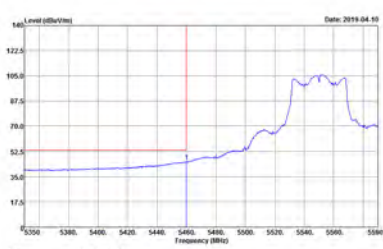

WIFI	Band 3 5470~5725MHz Band Edge @ 3m	
ANT	802.11n HT40 CH110 5550MHz - L	
1+2	Horizontal	Fundamental
<p><b>Peak</b></p>	 <p>Site : 03CH13-HY            Condition : PEAK_BE[UNII]_B3 3m HORN_91200_1241 HORIZONTAL            RBW:1000.0000Hz VSW:3000.0000Hz SWT:Auto            Detector : Peak</p>	 <p>Site : 03CH13-HY            Condition : PEAK[UNII] 3m HORN_91200_1241 HORIZONTAL            RBW:1000.0000Hz VSW:3000.0000Hz SWT:Auto            Detector : Peak</p>
<p><b>Avg.</b></p>	 <p>Site : 03CH13-HY            Condition : Avg_BE[UNII]_B3 3m HORN_91200_1241 HORIZONTAL            RBW:1000.0000Hz VSW:3000.0000Hz SWT:Auto            Detector : Peak</p>	<p>Left blank</p>

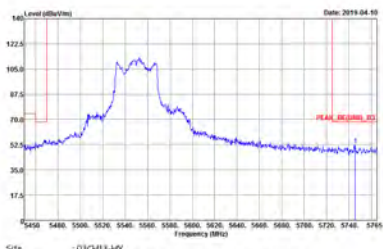

WIFI	Band 3 5470~5725MHz Band Edge @ 3m	
ANT	802.11n HT40 CH110 5550MHz - R	
1+2	Horizontal	Fundamental
Peak	 <p>Site : 03CH13-HY Condition : PEAK_BE([UNIT],_B3 3m HORN_91200_124) HORIZONTAL RBW:3000.0000Hz VBW:3000.0000Hz SWT:Auto Detector : Peak</p>	Left blank



WIFI	Band 3 5470~5725MHz Band Edge @ 3m	
ANT	802.11n HT40 CH110 5550MHz - L	
1+2	Vertical	Fundamental
<p><b>Peak</b></p>		
<p><b>Avg.</b></p>		<p>Left blank</p>

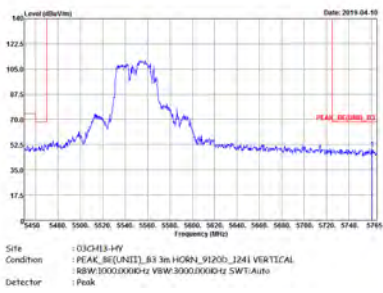

WIFI	Band 3 5470~5725MHz Band Edge @ 3m	
ANT	802.11n HT40 CH110 5550MHz - R	
1+2	Vertical	Fundamental
Peak	 <p>Site : 03CH13-HY Condition : PEAK_BE([UNIT], 63 3m HORN_91200_124) VERTICAL RBW:3000.0000Hz VBW:3000.0000Hz SWF:Auto Detector : Peak</p>	Left blank

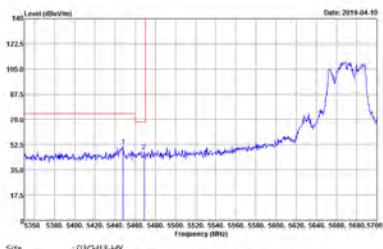
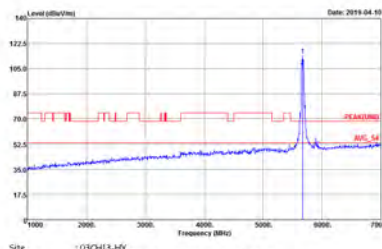
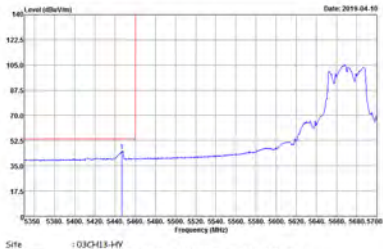

WIFI	Band 3 5470~5725MHz Band Edge @ 3m	
ANT	802.11n HT40 CH134 5670MHz - L	
1+2	Horizontal	Fundamental
<p><b>Peak</b></p>	 <p>Site : 03CH13-HY            Condition : PEAK_BE[UNII]_B3 3m HORN_91200_1241 HORIZONTAL            RBW:1000.0000Hz VBW:3000.0000Hz SWT:Auto            Detector : Peak</p>	 <p>Site : 03CH13-HY            Condition : PEAK[UNII] 3m HORN_91200_1241 HORIZONTAL            RBW:1000.0000Hz VBW:3000.0000Hz SWT:Auto            Detector : Peak</p>
<p><b>Avg.</b></p>	 <p>Site : 03CH13-HY            Condition : AVG_BE[UNII]_B3 3m HORN_91200_1241 HORIZONTAL            RBW:1000.0000Hz VBW:3000.0000Hz SWT:Auto            Detector : Peak</p>	<p>Left blank</p>

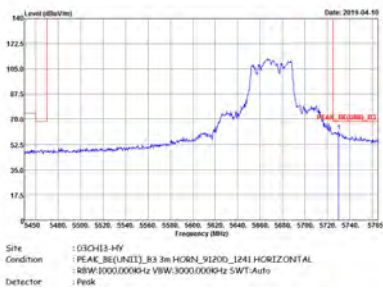

WIFI	Band 3 5470~5725MHz Band Edge @ 3m	
ANT	802.11n HT40 CH134 5670MHz - R	
1+2	Horizontal	Fundamental
Peak		Left blank



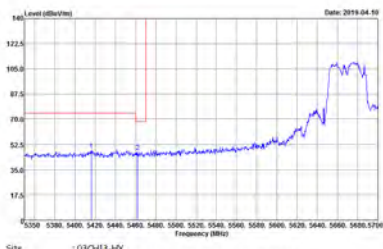
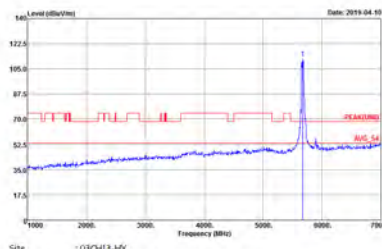
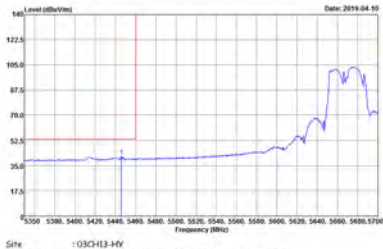

WIFI	Band 3 5470~5725MHz Band Edge @ 3m	
ANT	802.11n HT40 CH134 5670MHz - L	
1+2	Vertical	Fundamental
<p><b>Peak</b></p>	 <p>Site : 03CH13-MY            Condition : PEAK_BE(UNIT)_B3 3m HORN_91200_1241 VERTICAL            RBW:1000.0000kHz VBW:3000.0000kHz SWT:Auto            Detector : Peak</p>	 <p>Site : 03CH13-MY            Condition : PEAK(UNIT) 3m HORN_91200_1241 VERTICAL            RBW:1000.0000kHz VBW:3000.0000kHz SWT:Auto            Detector : Peak</p>
<p><b>Avg.</b></p>	 <p>Site : 03CH13-MY            Condition : AVG_BE(UNIT)_B3 3m HORN_91200_1241 VERTICAL            RBW:1000.0000kHz VBW:3000.0000kHz SWT:Auto            Detector : Peak</p>	<p>Left blank</p>

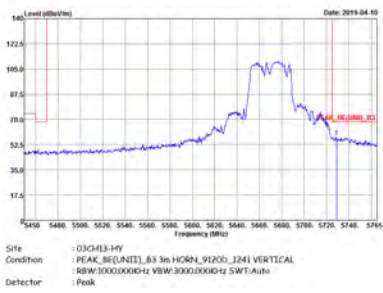

WIFI	Band 3 5470~5725MHz Band Edge @ 3m	
ANT	802.11n HT40 CH134 5670MHz - R	
1+2	Vertical	Fundamental
Peak	 <p>Site : 03CH134-VY Condition : PEAK_BE([UNIT],_B3 3m HORN_91200_124) VERTICAL RBW:3000.0000Hz VBW:3000.0000Hz SWF:Auto Detector : Peak</p>	Left blank



**Band 3 5470~5725MHz**  
**WIFI 802.11ac VHT80 (Band Edge @ 3m)**

WIFI	Band 3 5470~5725MHz Band Edge @ 3m	
ANT	802.11ac VHT80 CH106 5530MHz - L	
1+2	Horizontal	Fundamental
Peak	<p>Site : 03CH13-HY            Condition : PEAK_BE[UNIT]_B3 3m HORN_91200_1241 HORIZONTAL            Detector : Peak</p>	<p>Site : 03CH13-HY            Condition : PEAK[UNIT] 3m HORN_91200_1241 HORIZONTAL            Detector : Peak</p>
Avg.	<p>Site : 03CH13-HY            Condition : AVG_BE[UNIT]_B3 3m HORN_91200_1241 HORIZONTAL            Detector : Peak</p>	Left blank

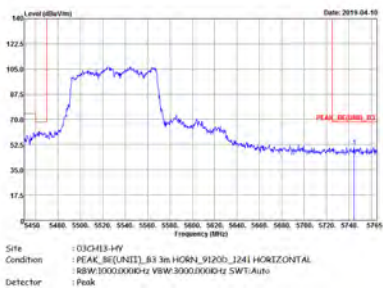

WIFI	Band 3 5470~5725MHz Band Edge @ 3m	
ANT	802.11ac VHT80 CH106 5530MHz - R	
1+2	Horizontal	Fundamental
Peak		Left blank

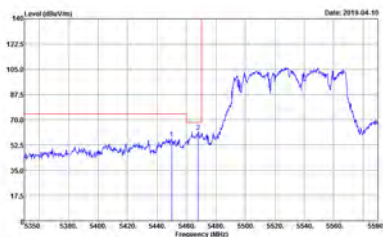
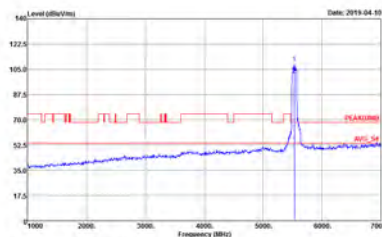
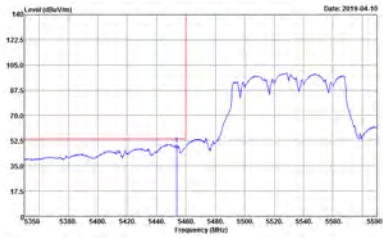

WIFI	Band 3 5470~5725MHz Band Edge @ 3m	
ANT	802.11ac VHT80 CH106 5530MHz - L	
1+2	Vertical	Fundamental
Peak	 <p>Site : 03CH13-HY            Condition : PEAK_BE(LINE1)_B3 3m HORN_91200_1241 VERTICAL            RBW:1000.0000Hz VBW:3000.0000Hz SWT:Auto            Detector : Peak</p>	 <p>Site : 03CH13-HY            Condition : PEAK(LINE1)_3m HORN_91200_1241 VERTICAL            RBW:1000.0000Hz VBW:3000.0000Hz SWT:Auto            Detector : Peak</p>
Avg.	 <p>Site : 03CH13-HY            Condition : AVG_BE(LINE1)_B3 3m HORN_91200_1241 VERTICAL            RBW:1000.0000Hz VBW:3000.0000Hz SWT:Auto            Detector : Peak</p>	Left blank



WIFI	Band 3 5470~5725MHz Band Edge @ 3m	
ANT	802.11ac VHT80 CH106 5530MHz - R	
1+2	Vertical	Fundamental
Peak	<p>Site : 03CH13-HY Condition : PEAK_BE([UNIT],_B3 3m HORN_91200_124) VERTICAL RBW:3000.0000Hz VBW:3000.0000Hz SWF:Auto Detector : Peak</p>	Left blank

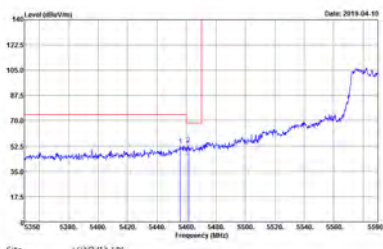
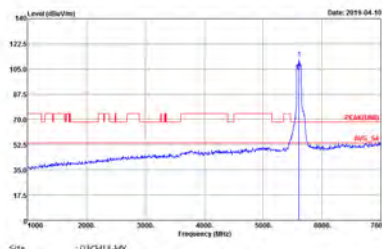
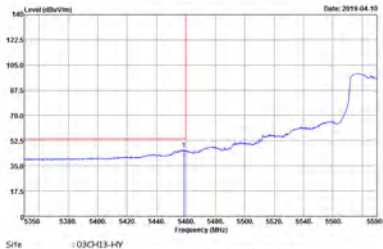

WIFI	Band 3 5470~5725MHz Band Edge @ 3m	
ANT	802.11ac VHT80 CH122 5610MHz - L	
1+2	Horizontal	Fundamental
<p><b>Peak</b></p>	 <p>Site : 03CH13-HY            Condition : PEAK_BE(LINE), 83 3m HORN, 91200_1241 HORIZONTAL            RBW:1000.000KHz VSW:3000.000KHz SWT:Auto            Detector : Peak</p>	 <p>Site : 03CH13-HY            Condition : PEAK(LINE) 3m HORN, 91200_1241 HORIZONTAL            RBW:1000.000KHz VSW:3000.000KHz SWT:Auto            Detector : Peak</p>
<p><b>Avg.</b></p>	 <p>Site : 03CH13-HY            Condition : AVG_BE(LINE), 83 3m HORN, 91200_1241 HORIZONTAL            RBW:1000.000KHz VSW:3000.000KHz SWT:Auto            Detector : Peak</p>	<p>Left blank</p>

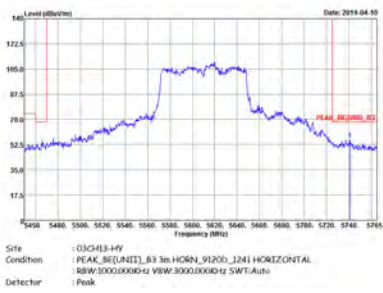

WIFI	Band 3 5470~5725MHz Band Edge @ 3m	
ANT	802.11ac VHT80 CH122 5610MHz - R	
1+2	Horizontal	Fundamental
Peak	 <p>Site : 03CH13-HY Condition : PEAK_BE([UNIT], 63 3m HORN_91200_124) HORIZONTAL RBW:3000.0000Hz VBW:3000.0000Hz SWF:Auto Detector : Peak</p>	Left blank



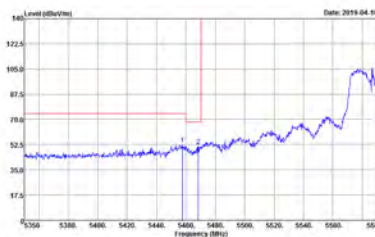
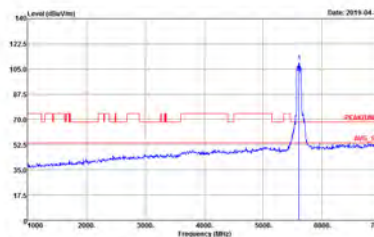
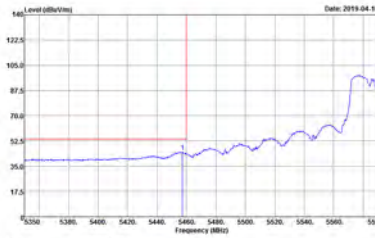

WIFI	Band 3 5470~5725MHz Band Edge @ 3m	
ANT	802.11ac VHT80 CH122 5610MHz - L	
1+2	Vertical	Fundamental
Peak	 <p>Site : 03CH13-HY            Condition : PEAK_BE[UNIT],_B3 3m HORN_91200_1241 VERTICAL            RBW:1000.0000kHz VSW:3000.0000Hz SWT:Auto            Detector : Peak</p>	 <p>Site : 03CH13-HY            Condition : PEAK[UNIT] 3m HORN_91200_1241 VERTICAL            RBW:1000.0000kHz VSW:3000.0000Hz SWT:Auto            Detector : Peak</p>
Avg.	 <p>Site : 03CH13-HY            Condition : AVG_BE[UNIT],_B3 3m HORN_91200_1241 VERTICAL            RBW:1000.0000kHz VSW:3000.0000Hz SWT:Auto            Detector : Peak</p>	Left blank

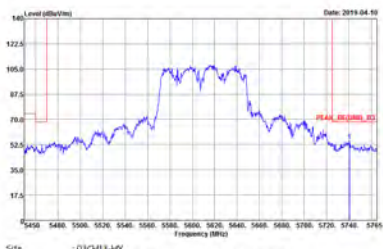

WIFI	Band 3 5470~5725MHz Band Edge @ 3m	
ANT	802.11ac VHT80 CH122 5610MHz - R	
1+2	Vertical	Fundamental
Peak	 <p>Site : 03CH13-HY          Condition : PEAK_BE([UNIT],_B3 3m HORN_91200_124) VERTICAL          RBW:1000.0000Hz VBW:3000.0000Hz SWF:Auto          Detector : Peak</p>	Left blank



Band 3 - 5470~5725MHz
WIFI 802.11a (Harmonic @ 3m)

Table with 3 columns: WIFI, ANT, 1+2. It contains two spectral plots: Horizontal and Vertical. Each plot shows Level (dBm/5MHz) vs Frequency (MHz) with a peak at 5500MHz. Includes site information: 03CH13-HF, PEAK(UNIT) 3m HORN\_91200\_1241.



WIFI	Band 3 5470~5725MHz Harmonic @ 3m	
ANT	802.11a CH116 5580MHz	
1+2	Horizontal	Vertical
Peak Avg.	<p>Site : 03CH13-HY Condition : PEAR(LINII) 3m HORN_91200_1241 HORIZONTAL Detector : Peak</p>	<p>Site : 03CH13-HY Condition : PEAR(LINII) 3m HORN_91200_1241 VERTICAL Detector : Peak</p>



WIFI	Band 3 5470~5725MHz Harmonic @ 3m	
ANT	802.11a CH140 5700MHz	
1+2	Horizontal	Vertical
Peak Avg.	<p>Site : 03CH13-HY Condition : PEAK(LINE1) 3m HORN_91200_1241 HORIZONTAL Detector : Peak</p>	<p>Site : 03CH13-HY Condition : PEAK(LINE1) 3m HORN_91200_1241 VERTICAL Detector : Peak</p>



**Band 3 5470~5725MHz  
WIFI 802.11n HT20 (Harmonic @ 3m)**

WIFI	Band 3 5470~5725MHz Harmonic @ 3m	
ANT	802.11n HT20 CH100 5500MHz	
1+2	Horizontal	Vertical
<p><b>Peak</b> <b>Avg.</b></p>	<p>Site : 03CH13-HV Condition : PEAK(UNIT) 3m HORN_91200_1241 HORIZONTAL Detector : Peak</p>	<p>Site : 03CH13-HV Condition : PEAK(UNIT) 3m HORN_91200_1241 VERTICAL Detector : Peak</p>



WIFI	Band 3 5470~5725MHz Harmonic @ 3m	
ANT	802.11n HT20 CH116 5580MHz	
1+2	Horizontal	Vertical
Peak Avg.	<p>Site : 03CH13-HY Condition : PEAK(LINE) 3m HORN_91200_1241 HORIZONTAL Detector : Peak</p>	<p>Site : 03CH13-HY Condition : PEAK(LINE) 3m HORN_91200_1241 VERTICAL Detector : Peak</p>



WIFI	Band 3 5470~5725MHz Harmonic @ 3m	
ANT	802.11n HT20 CH140 5700MHz	
1+2	Horizontal	Vertical
Peak Avg.	<p>Site : 03CH13-HY Condition : PEAK(LINE) 3m HORN_91200_1241 HORIZONTAL Detector : Peak</p>	<p>Site : 03CH13-HY Condition : PEAK(LINE) 3m HORN_91200_1241 VERTICAL Detector : Peak</p>





**Band 3 5470~5725MHz  
WIFI 802.11n HT40 (Harmonic @ 3m)**

WIFI	Band 3 5470~5725MHz Harmonic @ 3m	
ANT	802.11n HT40 CH102 5510MHz	
1+2	Horizontal	Vertical
<p><b>Peak</b> <b>Avg.</b></p>	<p>Site : 03CH13-HY Condition : PEAK(UNII) 3m HORN_91200_1241 HORIZONTAL Detector : Peak</p>	<p>Site : 03CH13-HY Condition : PEAK(UNII) 3m HORN_91200_1241 VERTICAL Detector : Peak</p>



WIFI	Band 3 5470~5725MHz Harmonic @ 3m	
ANT	802.11n HT40 CH110 5550MHz	
1+2	Horizontal	Vertical
Peak Avg.	<div style="display: flex; justify-content: space-around;"> <div data-bbox="383 660 837 929"> <p>Site : 03CH13-HY Condition : PEAR(UNIT) 3m HORN_91200_1241 HORIZONTAL Detector : Peak</p> </div> <div data-bbox="845 660 1308 929"> <p>Site : 03CH13-HY Condition : PEAR(UNIT) 3m HORN_91200_1241 VERTICAL Detector : Peak</p> </div> </div>	



WIFI	Band 3 5470~5725MHz Harmonic @ 3m	
ANT	802.11n HT40 CH134 5670MHz	
1+2	Horizontal	Vertical
Peak Avg.	<p>Site : 03CH13-HY Condition : PEAK(LINE) 3m HORN_91200_1241 HORIZONTAL Detector : Peak</p>	<p>Site : 03CH13-HY Condition : PEAK(LINE) 3m HORN_91200_1241 VERTICAL Detector : Peak</p>



**Band 3 5470~5725MHz**  
**WIFI 802.11ac VHT80 (Harmonic @ 3m)**

WIFI	Band 3 5470~5725MHz Harmonic @ 3m	
ANT	802.11ac VHT80 CH106 5530MHz	
1+2	Horizontal	Vertical
Peak Avg.	<p>Site : 03CH13-HV Condition : PEAK(UNIT) 3m HORN_91200_1241 HORIZONTAL Detector : Peak</p>	<p>Site : 03CH13-HV Condition : PEAK(UNIT) 3m HORN_91200_1241 VERTICAL Detector : Peak</p>



WIFI	Band 3 5470~5725MHz Harmonic @ 3m	
ANT	802.11ac VHT80 CH122 5610MHz	
1+2	Horizontal	Vertical
Peak Avg.	<p>Site : 03CH13-HY Condition : PEAR[UNII] 3m HORN_91200_1241 HORIZONTAL Detector : Peak</p>	<p>Site : 03CH13-HY Condition : PEAR[UNII] 3m HORN_91200_1241 VERTICAL Detector : Peak</p>



**Band 3 - Straddle Channel**  
**WIFI 802.11a (Band Edge @ 3m)**

WIFI	Band 3 5470~5725MHz Band Edge @ 3m	
ANT	802.11a CH144 5720MHz - L	
1+2	Horizontal	Fundamental
Peak	<p>Site : 03CH13-4#Y            Condition : STRADDOLES U-NET-142A 3m HORN_91200_1241 HORIZONTAL            RBW:1000.0000Hz VSW:3000.0000Hz SWT:Auto            Detector : Peak</p>	<p>Site : 03CH13-4#Y            Condition : PEAK(LINE) 3m HORN_91200_1241 HORIZONTAL            RBW:1000.0000Hz VSW:3000.0000Hz SWT:Auto            Detector : Peak</p>
Avg.	<p>Site : 03CH13-4#Y            Condition : U-NET-142A AVERAGE 3m HORN_91200_1241 HORIZONTAL            RBW:1000.0000Hz VSW:3000.0000Hz SWT:Auto            Detector : Peak</p>	Left blank



WIFI	Band 3 5470~5725MHz Band Edge @ 3m	
ANT	802.11a CH144 5720MHz - R	
1+2	Horizontal	Fundamental
Peak	<p>Site : 03CH13 HV Condition : STRAD0113 U-NET-142A 3m HORN_91200_1241 HORIZONTAL RBW:1000.000kHz VBW:3000.000kHz SWF:Auto Detector : Peak</p>	Left blank



WIFI	Band 3 5470~5725MHz Band Edge @ 3m	
ANT	802.11a CH144 5720MHz - L	
1+2	Vertical	Fundamental
Peak	<p>Site : 03CH13-HY            Condition : STRADGLES U-NET-1A2A 3m HORN_91200_1241 VERTICAL            RBW:1000.0000Hz VBW:3000.0000Hz SWT:Auto            Detector : Peak</p>	<p>Site : 03CH13-HY            Condition : PEAK(UNII) 3m HORN_91200_1241 VERTICAL            RBW:1000.0000Hz VBW:3000.0000Hz SWT:Auto            Detector : Peak</p>
Avg.	<p>Site : 03CH13-HY            Condition : U-NET-1A2A AVERAGE 3m HORN_91200_1241 VERTICAL            RBW:1000.0000Hz VBW:0.0000Hz SWT:Auto            Detector : Peak</p>	Left blank



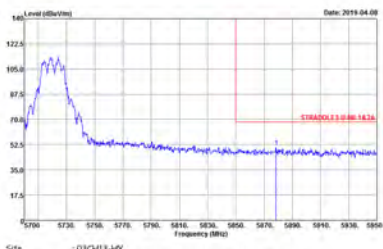

WIFI	Band 3 5470~5725MHz Band Edge @ 3m	
ANT	802.11a CH144 5720MHz - R	
1+2	Vertical	Fundamental
Peak	 <p>Site : 03CHLES-HY Condition : STRADDLES U-NET-142A 3m HORN_91K0D_1241 VERTICAL RBW:3000.0000 Hz VBW:3000.0000 Hz SWT:Auto Detector : Peak</p>	Left blank



**Band 3 – Straddle Channel  
WIFI 802.11n HT20 (Band Edge @ 3m)**

WIFI	Band 3 5470~5725MHz Band Edge @ 3m	
ANT	802.11n HT20 CH144 5720MHz - L	
1+2	Horizontal	Fundamental
Peak	<p>Site : 03CH3-HV Condition : STRADDLES U-NII-1&amp;2A 3m HORN_9120D_1241 HORIZONTAL Detector : Peak</p>	<p>Site : 03CH3-HV Condition : PEAK(UNIT) 3m HORN_9120D_1241 HORIZONTAL Detector : Peak</p>
Avg.	<p>Site : 03CH3-HV Condition : U-NII-1&amp;2A AVERAGE 3m HORN_9120D_1241 HORIZONTAL Detector : Peak</p>	Left blank

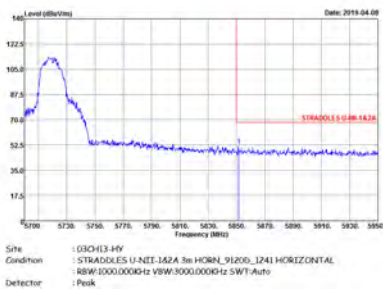

WIFI	Band 3 5470~5725MHz Band Edge @ 3m	
ANT	802.11n HT20 CH144 5720MHz - R	
1+2	Horizontal	Fundamental
Peak		Left blank



WIFI	Band 3 5470~5725MHz Band Edge @ 3m	
ANT	802.11n HT20 CH144 5720MHz - L	
1+2	Vertical	Fundamental
Peak	<p>Site : 03CH3-HY            Condition : STRADDLES U-NIT-142A 3m HORN_91200_1241 VERTICAL            RBW:1000.0000-Hz VSW:3000.0000-Hz SWT:Auto            Detector : Peak</p>	<p>Site : 03CH3-HY            Condition : PEAK(UNIT) 3m HORN_91200_1241 VERTICAL            RBW:1000.0000-Hz VSW:3000.0000-Hz SWT:Auto            Detector : Peak</p>
Avg.	<p>Site : 03CH3-HY            Condition : U-NIT-142A AVERAGE 3m HORN_91200_1241 VERTICAL            RBW:1000.0000-Hz VSW:3000.0000-Hz SWT:Auto            Detector : Peak</p>	Left blank

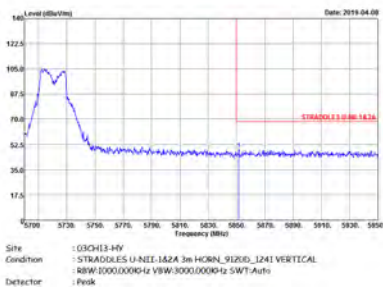

WIFI	Band 3 5470~5725MHz Band Edge @ 3m	
ANT	802.11n HT20 CH144 5720MHz - R	
1+2	Vertical	Fundamental
Peak	 <p>Site : 03CH13 HV Condition : STRADULES U-NEL-1424 3m HORN_91200_1241 VERTICAL RBW:1000.0000Hz VBW:3000.0000Hz SWF:Auto Detector : Peak</p>	Left blank



**Band 3 – Straddle Channel  
WIFI 802.11n HT40 (Band Edge @ 3m)**

WIFI	Band 3 5470~5725MHz Band Edge @ 3m	
ANT	802.11n HT40 CH142 5710MHz - L	
1+2	Horizontal	Fundamental
Peak	<p>Site : 03CH3-14Y Condition : STRADDLES U-NII-1&amp;2A 3m HORN_91200_1241 HORIZONTAL RBW:1000.000kHz VSW:3000.000Hz SWT:Auto Detector : Peak</p>	<p>Site : 03CH3-14Y Condition : PEAK(U-NII) 3m HORN_91200_1241 HORIZONTAL RBW:1000.000kHz VSW:3000.000Hz SWT:Auto Detector : Peak</p>
Avg.	<p>Site : 03CH3-14Y Condition : U-NII-1&amp;2A AVERAGE 3m HORN_91200_1241 HORIZONTAL RBW:1000.000kHz VSW:3.000kHz SWT:Auto Detector : Peak</p>	Left blank



WIFI	Band 3 5470~5725MHz Band Edge @ 3m	
ANT	802.11n HT40 CH142 5710MHz - R	
1+2	Horizontal	Fundamental
Peak	<p>Site : 03CHLS-HY Condition : STRADLES U-NIT-142A 3m HORN_91200_1241 HORIZONTAL RBW:3000.0000 Hz VSW:3000.0000 Hz SWT:Auto Detector : Peak</p>	Left blank



WIFI	Band 3 5470~5725MHz Band Edge @ 3m	
ANT	802.11n HT40 CH142 5710MHz - L	
1+2	Vertical	Fundamental
Peak	<p>Site : 03CH13-HY            Condition : STRADULES U-NII-1A2A 3m HORN_91200_1241 VERTICAL            RBW:1000.0000Hz VBW:3000.0000Hz SWT:Auto            Detector : Peak</p>	<p>Site : 03CH13-HY            Condition : PEAK(LINE) 3m HORN_91200_1241 VERTICAL            RBW:1000.0000Hz VBW:3000.0000Hz SWT:Auto            Detector : Peak</p>
Avg.	<p>Site : 03CH13-HY            Condition : U-NII-1A2A AVERAGE 3m HORN_91200_1241 VERTICAL            RBW:1000.0000Hz VBW:3000.0000Hz SWT:Auto            Detector : Peak</p>	Left blank



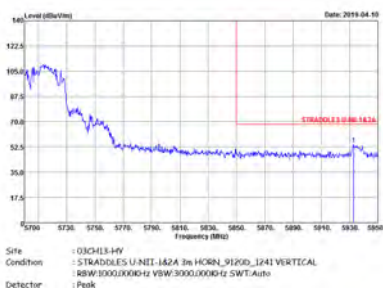

WIFI	Band 3 5470~5725MHz Band Edge @ 3m	
ANT	802.11n HT40 CH142 5710MHz - R	
1+2	Vertical	Fundamental
Peak	 <p>Site : 03CH142-44V Condition : STRADBOLES U-NIT-142A 3m HORN_91200_1241 VERTICAL RBW:1000.0000Hz VSW:3000.0000Hz SWT:Auto Detector : Peak</p>	Left blank



**Band 3 – Straddle Channel  
WIFI 802.11ac VHT80 (Band Edge @ 3m)**

WIFI	Band 3 5470~5725MHz Band Edge @ 3m	
ANT	802.11ac VHT80 CH138 5690MHz - L	
1+2	Horizontal	Fundamental
Peak	<p>Site : 03CH3-HV Condition : STRADDLES U-NET-1A2A 3m HORN_91200_1241 HORIZONTAL RBW:1000.000Hz VBW:3000.000Hz SWT:Auto Detector : Peak</p>	<p>Site : 03CH3-HV Condition : (PEAKUNIT) 3m HORN_91200_1241 HORIZONTAL RBW:1000.000Hz VBW:3000.000Hz SWT:Auto Detector : Peak</p>
Avg.	<p>Site : 03CH3-HV Condition : U-NET-1A2A AVERAGE 3m HORN_91200_1241 HORIZONTAL RBW:1000.000Hz VBW:3.000Hz SWT:Auto Detector : Peak</p>	Left blank



WIFI	Band 3 5470~5725MHz Band Edge @ 3m	
ANT	802.11ac VHT80 CH138 5690MHz - R	
1+2	Horizontal	Fundamental
Peak	<p>Site : D3CH3-4FF Condition : STRADDLES U-NET-142A 3m HORN_91200_1241 HORIZONTAL RBW:1000.000kHz VBW:3000.000kHz SWF:Auto Detector : Peak</p>	Left blank



WIFI	Band 3 5470~5725MHz Band Edge @ 3m	
ANT	802.11ac VHT80 CH138 5690MHz - L	
1+2	Vertical	Fundamental
<p><b>Peak</b></p>	<p>Site : 03CH13-HY            Condition : STRADGLES U-NIT-1A2A 3m HORN_91200_1241 VERTICAL            RBW:1000.0000kHz VBW:3000.0000kHz SWT:Auto            Detector : Peak</p>	<p>Site : 03CH13-HY            Condition : PEAK(LINE) 3m HORN_91200_1241 VERTICAL            RBW:1000.0000kHz VBW:3000.0000kHz SWT:Auto            Detector : Peak</p>
<p><b>Avg.</b></p>	<p>Site : 03CH13-HY            Condition : U-NIT-1A2A AVERAGE 3m HORN_91200_1241 VERTICAL            RBW:1000.0000kHz VBW:3.0000kHz SWT:Auto            Detector : Peak</p>	<p><b>Left blank</b></p>

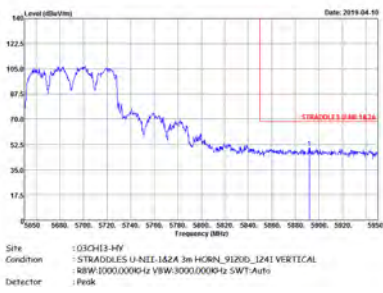

WIFI	Band 3 5470~5725MHz Band Edge @ 3m	
ANT	802.11ac VHT80 CH138 5690MHz - R	
1+2	Vertical	Fundamental
Peak	 <p>Site : 03CH13-MY Condition : STRADULES U-NEL-1624 3m HORN_91200_1241 VERTICAL RBW: 0000.0000Hz VBW: 3000.0000Hz SWF: Auto Detector : Peak</p>	Left blank

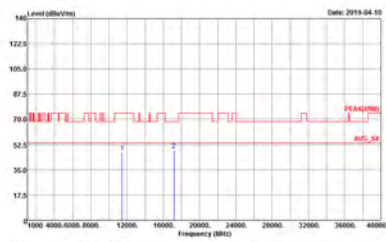
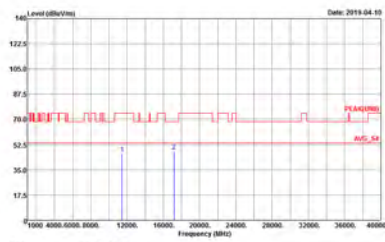

**Band 3 - Straddle Channel**  
**WIFI 802.11a (Harmonic @ 3m)**

WIFI	Band 3 Straddle Channel Harmonic @ 3m	
ANT	802.11a CH144 5720MHz	
1+2	Horizontal	Vertical
<b>Peak</b> <b>Avg.</b>	 <p>Site : 03CH13-HF Condition : PEAK(UNIT) 3m HORN_91200_1241 HORIZONTAL Detector : Peak</p>	 <p>Site : 03CH13-HF Condition : PEAK(UNIT) 3m HORN_91200_1241 VERTICAL Detector : Peak</p>



Band 3 – Straddle Channel
WIFI 802.11n HT20 (Harmonic @ 3m)

Table with 3 columns: WIFI, ANT, 1+2. It contains two spectral plots: Horizontal and Vertical. Each plot shows Level (dBu/m) vs Frequency (MHz) with a peak at approximately 12.41 MHz. The plots include site information: 03CH13-HV, PEAK(UNII) 3m HORN\_91200\_1241 HORIZONTAL and PEAK(UNII) 3m HORN\_91200\_1241 VERTICAL.



**Band 3 – Straddle Channel**  
**WIFI 802.11n HT40 (Harmonic @ 3m)**

WIFI	Band 3 Straddle Channel Harmonic @ 3m	
ANT	802.11n HT40 CH142 5710MHz	
1+2	Horizontal	Vertical
Peak Avg.	<p>Site : 03CH13-HV Condition : PEAK(UNII) 3m HORN_91200_1241 HORIZONTAL Detector : Peak</p>	<p>Site : 03CH13-HV Condition : PEAK(UNII) 3m HORN_91200_1241 VERTICAL Detector : Peak</p>





**Band 3 – Straddle Channel  
WIFI 802.11ac VHT80 (Harmonic @ 3m)**

WIFI	Band 3 Straddle Channel Harmonic @ 3m	
ANT	802.11ac VHT80 CH138 5690MHz	
1+2	Horizontal	Vertical
<p><b>Peak</b></p> <p><b>Avg.</b></p>	<p>Site : 03CH13-HV Condition : PEAK(UNII) 3m HORN_91200_1241 HORIZONTAL Detector : Peak</p>	<p>Site : 03CH13-HV Condition : PEAK(UNII) 3m HORN_91200_1241 VERTICAL Detector : Peak</p>



Emission below 1GHz  
5GHz WIFI 802.11ac VHT80 (LF)

WIFI	5GHz WIFI	
ANT	802.11ac VHT80 LF	
1+2	Horizontal	Vertical
QP / Peak		



### Appendix E. Duty Cycle Plots

Antenna	Band	Duty Cycle(%)	T(us)	1/T(kHz)	VBW Setting	Duty Factor(dB)
1+2	802.11a for Ant 1	98.10	-	-	10Hz	0.08
1+2	802.11a for Ant 2	98.10	-	-	10Hz	0.08
1+2	5GHz 802.11n HT20 for Ant 1	98.02	-	-	10Hz	0.09
1+2	5GHz 802.11n HT20 for Ant 2	98.02	-	-	10Hz	0.09
1+2	5GHz 802.11n HT40 for Ant 1	96.07	855	1.17	3kHz	0.17
1+2	5GHz 802.11n HT40 for Ant 2	96.07	855	1.17	3kHz	0.17
1+2	5GHz 802.11ac VHT20 for Ant 1	98.03	1745	0.57	10Hz	0.09
1+2	5GHz 802.11ac VHT20 for Ant 2	98.03	1745	0.57	10Hz	0.09
1+2	5GHz 802.11ac VHT40 for Ant 1	96.09	860	1.16	3kHz	0.17
1+2	5GHz 802.11ac VHT40 for Ant 2	96.09	860	1.16	3kHz	0.17
1+2	5GHz 802.11ac VHT80 for Ant 1	95.56	860	1.16	3kHz	0.20
1+2	5GHz 802.11ac VHT80 for Ant 2	95.56	860	1.16	3kHz	0.20



MIMO <Ant. 1>

802.11a

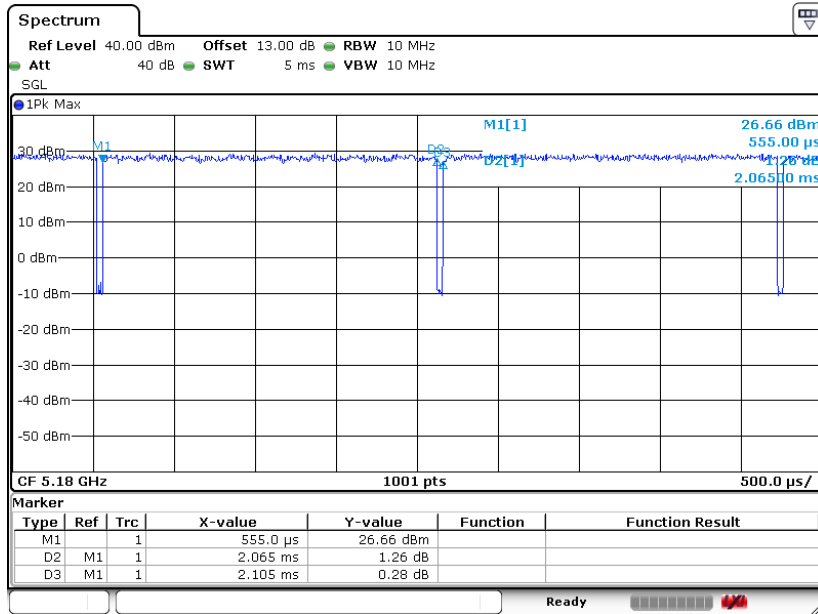

Date: 14.JUN.2019 10:09:55

802.11n HT20

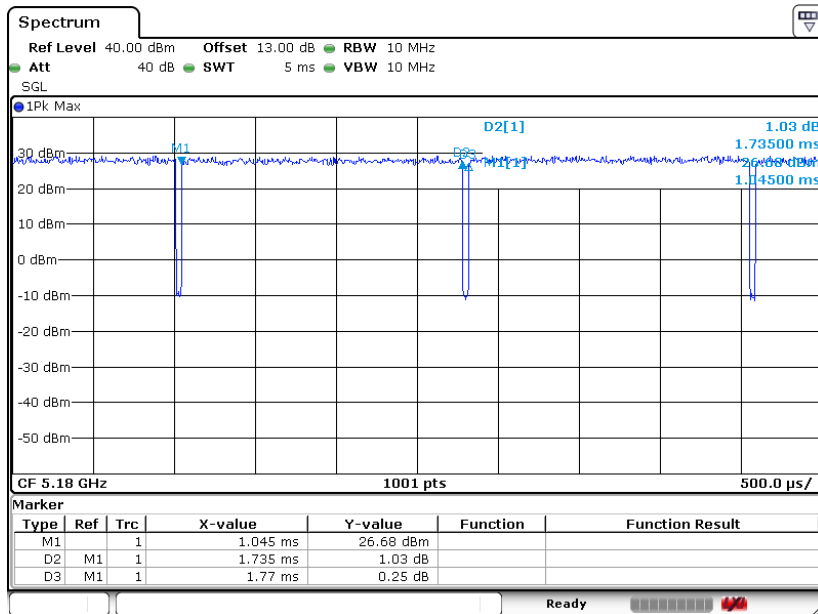

Date: 14.JUN.2019 11:22:09



802.11n HT40

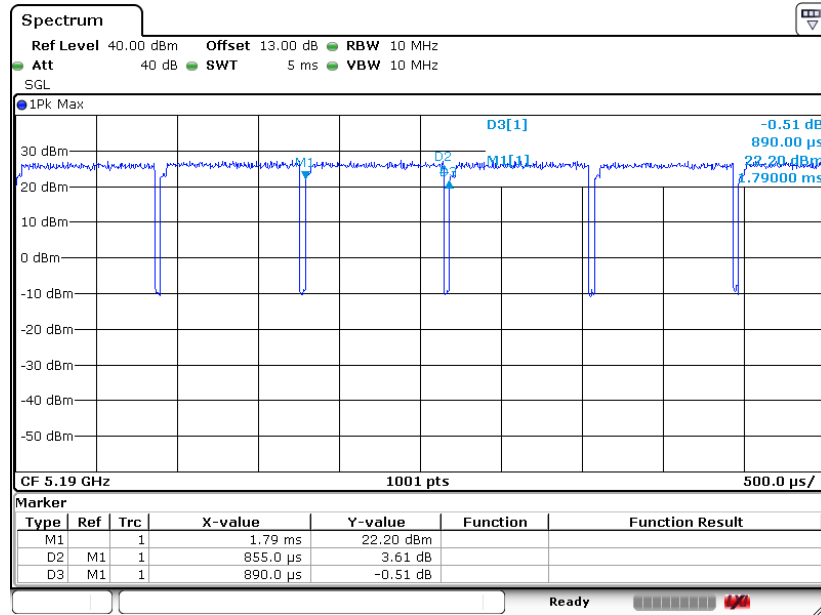

Date: 14.JUN.2019 11:09:27

802.11ac VHT20

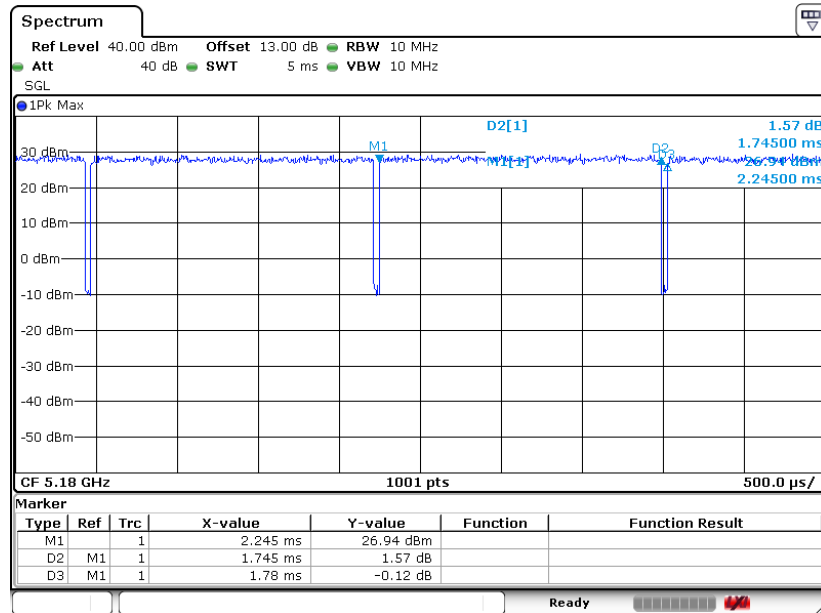

Date: 14.JUN.2019 11:19:11



802.11ac VHT40

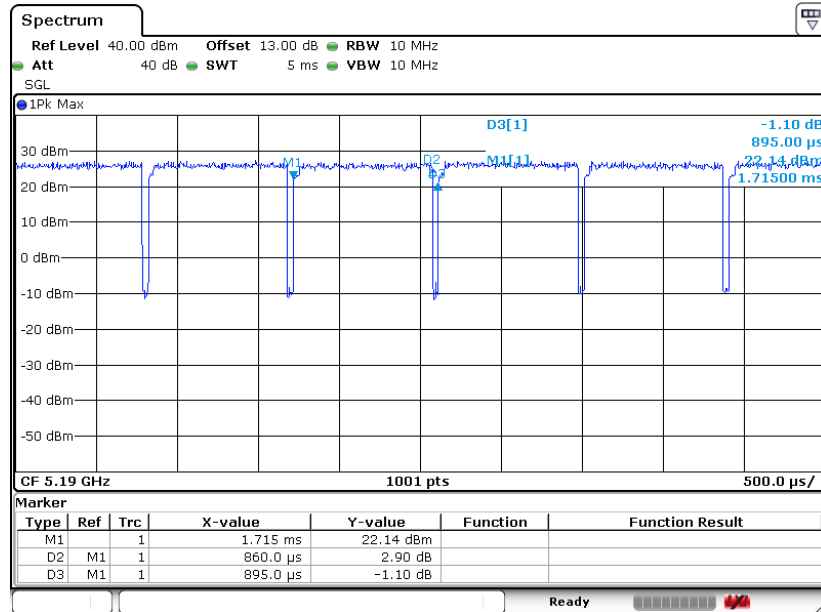

Date: 14.JUN.2019 11:26:02

802.11ac VHT80

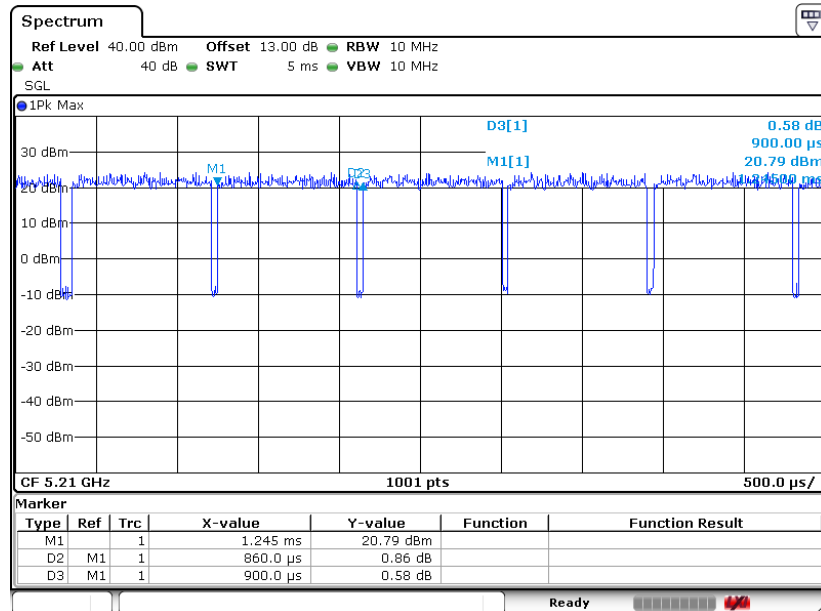

Date: 14.JUN.2019 11:32:55



MIMO <Ant. 2>

802.11a

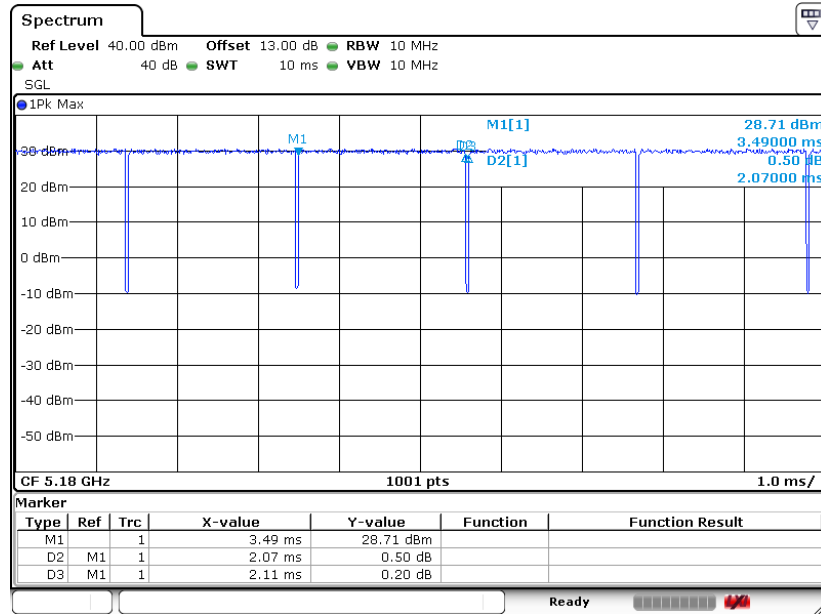

Date: 14.JUN.2019 10:58:51

802.11n HT20

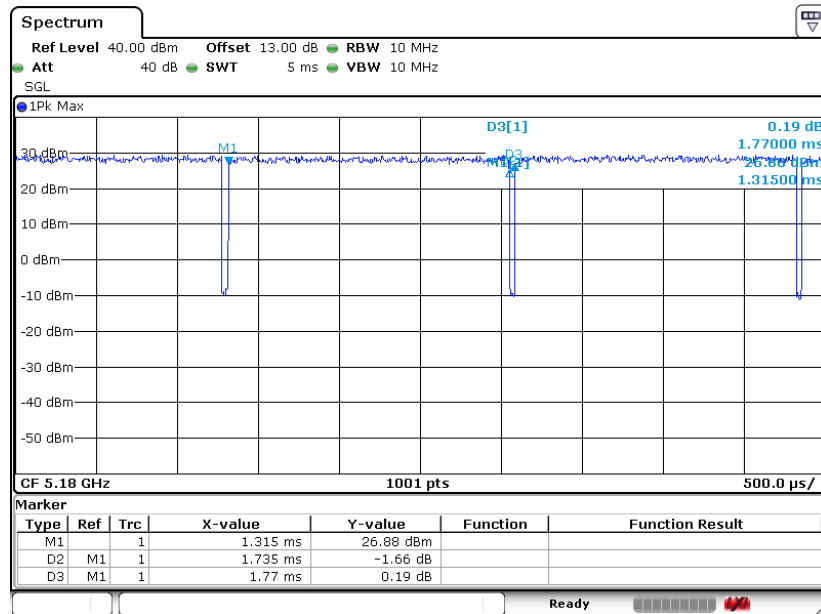

Date: 14.JUN.2019 11:23:32



802.11n HT40

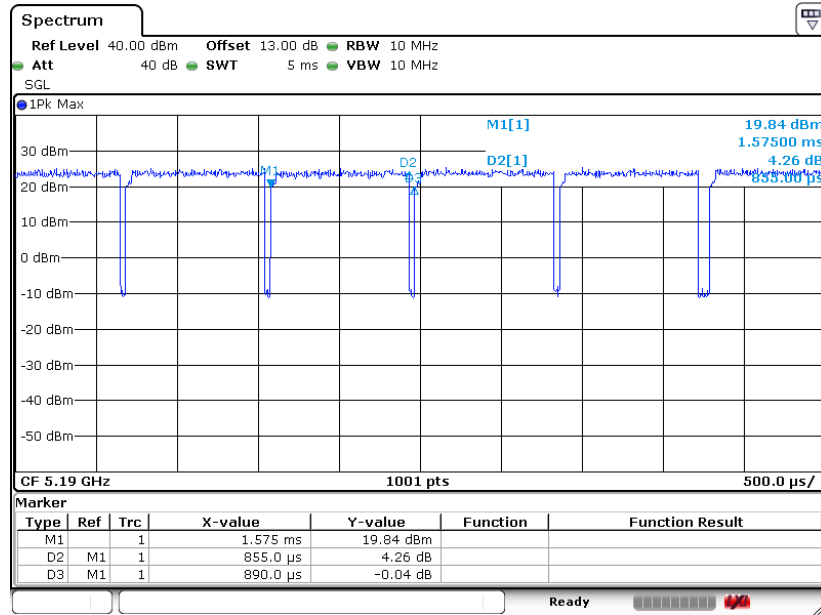

Date: 14.JUN.2019 11:14:51

802.11ac VHT20

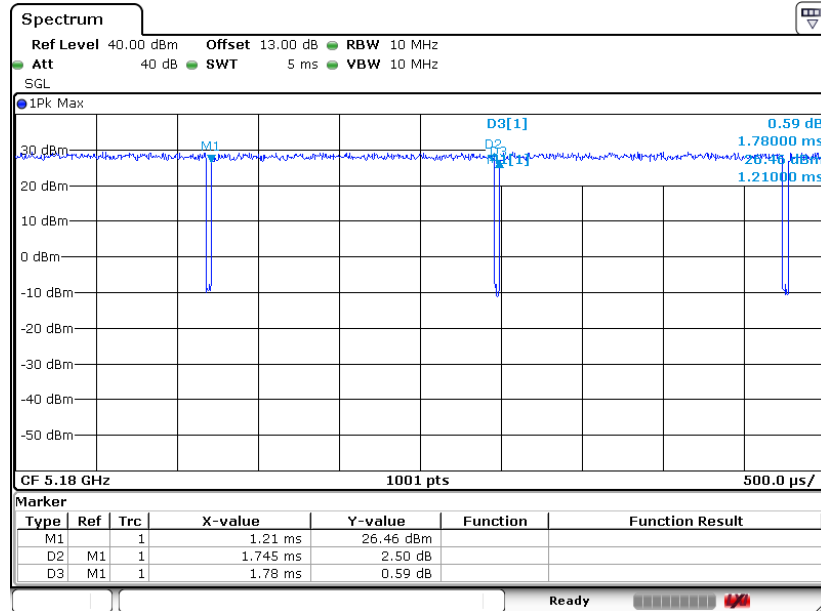

Date: 14.JUN.2019 11:20:34





802.11ac VHT40

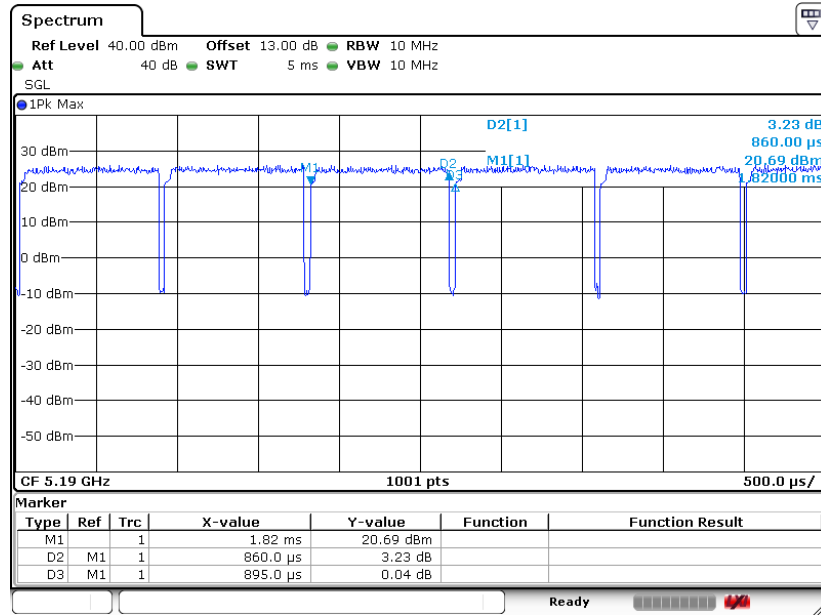

Date: 14.JUN.2019 11:27:51

802.11ac VHT80

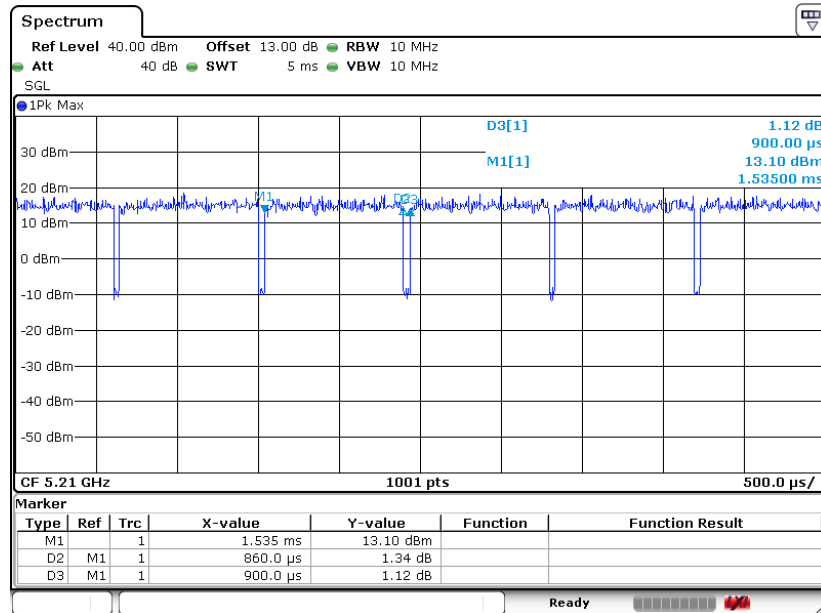

Date: 14.JUN.2019 11:34:34