



FCC RADIO TEST REPORT

FCC ID : 2AGOZ-CM5X
Equipment : Media Receiver
Brand Name : facebook
Model Name : LW94NS
Applicant : Facebook Technologies LLC
1 Hacker Way Menlo Park CA 94025
Standard : FCC Part 15 Subpart C §15.247

The product was received on Apr. 08, 2019 and testing was started from Apr. 08, 2019 and completed on Jul. 19, 2019. We, SPORTON INTERNATIONAL INC., EMC & Wireless Communications Laboratory, would like to declare that the tested sample has been evaluated in accordance with the test procedures and has been in compliance with the applicable technical standards.

The report must not be used by the client to claim product certification, approval, or endorsement by TAF or any agency of government.

The test results in this report apply exclusively to the tested model / sample. Without written approval of SPORTON INTERNATIONAL INC. EMC & Wireless Communications Laboratory, the test report shall not be reproduced except in full.

Approved by: Jones Tsai

SPORTON INTERNATIONAL INC. EMC & Wireless Communications Laboratory
No. 52, Huaya 1st Rd., Guishan Dist., Taoyuan City, Taiwan (R.O.C.)



Table of Contents

History of this test report.....	3
Summary of Test Result.....	4
1 General Description	5
1.1 Product Feature of Equipment Under Test.....	5
1.2 Modification of EUT	5
1.3 Testing Location	5
1.4 Applicable Standards.....	6
2 Test Configuration of Equipment Under Test	7
2.1 Carrier Frequency and Channel	7
2.2 Test Mode.....	7
2.3 Connection Diagram of Test System.....	8
2.4 Support Unit used in test configuration and system	9
2.5 EUT Operation Test Setup	9
2.6 Measurement Results Explanation Example.....	9
3 Test Result	10
3.1 6dB and 99% Bandwidth Measurement	10
3.2 Output Power Measurement.....	12
3.3 Power Spectral Density Measurement	13
3.4 Conducted Band Edges and Spurious Emission Measurement	15
3.5 Radiated Band Edges and Spurious Emission Measurement	36
3.6 AC Conducted Emission Measurement.....	40
3.7 Antenna Requirements	42
4 List of Measuring Equipment.....	43
5 Uncertainty of Evaluation	45
Appendix A. Conducted Test Results	
Appendix B. AC Conducted Emission Test Result	
Appendix C. Radiated Spurious Emission	
Appendix D. Radiated Spurious Emission Plots	
Appendix E. Duty Cycle Plots	
Appendix F. Setup Photographs	



Summary of Test Result

Report Clause	Ref Std. Clause	Test Items	Result (PASS/FAIL)	Remark
3.1	15.247(a)(2)	6dB Bandwidth	Pass	-
3.1	2.1049	99% Occupied Bandwidth	Reporting only	-
3.2	15.247(b)	Power Output Measurement	Pass	-
3.3	15.247(e)	Power Spectral Density	Pass	-
3.4	15.247(d)	Conducted Band Edges	Pass	-
		Conducted Spurious Emission	Pass	-
3.5	15.247(d)	Radiated Band Edges and Radiated Spurious Emission	Pass	Under limit 1.16 dB at 2390.000 MHz
3.6	15.207	AC Conducted Emission	Pass	Under limit 11.23 dB at 0.683 MHz
3.7	15.203 & 15.247(b)	Antenna Requirement	Pass	-

Declaration of Conformity:

The test results with all measurement uncertainty excluded are presented in accordance with the regulation limits or requirements declared by manufacturers.

Comments and Explanations:

The declared of product specification for EUT presented in the report are provided by the manufacturer, and the manufacturer takes all the responsibilities for the accuracy of product specification.

Reviewed by: Wii Chang**Report Producer: Yimin Ho**



1 General Description

1.1 Product Feature of Equipment Under Test

Bluetooth, Wi-Fi 2.4GHz 802.11b/g/n, Wi-Fi 5GHz 802.11a/n/ac.

Product Specification subjective to this standard	
Antenna Type	WLAN: PIFA Antenna Bluetooth: PIFA Antenna

1.2 Modification of EUT

No modifications are made to the EUT during all test items.

1.3 Testing Location

Test Site	SPORTON INTERNATIONAL INC. EMC & Wireless Communications Laboratory	
Test Site Location	No.52, Huaya 1st Rd., Guishan Dist., Taoyuan City, Taiwan (R.O.C.) TEL: +886-3-327-3456 FAX: +886-3-328-4978	
Test Site No.	Sporton Site No.	
	TH05-HY	CO05-HY

Note: The test site complies with ANSI C63.4 2014 requirement.

Test Site	SPORTON INTERNATIONAL INC. EMC & Wireless Communications Laboratory	
Test Site Location	No.58, Aly. 75, Ln. 564, Wenhua 3rd, Rd., Guishan Dist., Taoyuan City, Taiwan (R.O.C.) TEL: +886-3-327-0868 FAX: +886-3-327-0855	
Test Site No.	Sporton Site No.	
	03CH11-HY	

Note: The test site complies with ANSI C63.4 2014 requirement.

FCC designation No.: TW1190 and TW0007



1.4 Applicable Standards

According to the specifications of the manufacturer, the EUT must comply with the requirements of the following standards:

- ♦ FCC Part 15 Subpart C §15.247
- ♦ FCC KDB Publication No. 558074 D01 DTS Meas. Guidance v05r02
- ♦ FCC KDB 414788 D01 Radiated Test Site v01r01.
- ♦ FCC KDB 662911 D01 Multiple Transmitter Output v02r01.
- ♦ ANSI C63.10-2013

Remark:

1. All test items were verified and recorded according to the standards and without any deviation during the test.
2. This EUT has also been tested and complied with the requirements of FCC Part 15, Subpart B, recorded in a separate test report.



2 Test Configuration of Equipment Under Test

- a. The EUT has been associated with peripherals and configuration operated in a manner tended to maximize its emission characteristics in a typical application. Frequency range investigated: conduction emission (150 kHz to 30 MHz), radiation emission (9 kHz to the 10th harmonic of the highest fundamental frequency or to 40 GHz, whichever is lower). For radiated measurement, pre-scanned in two setup, without all accessories, with all accessories. The worst cases (without all accessories) were recorded in this report.
- b. AC power line Conducted Emission was tested under maximum output power.

2.1 Carrier Frequency and Channel

Frequency Band	Channel	Freq. (MHz)	Channel	Freq. (MHz)
2400-2483.5 MHz	1	2412	7	2442
	2	2417	8	2447
	3	2422	9	2452
	4	2427	10	2457
	5	2432	11	2462
	6	2437		

2.2 Test Mode

Final test modes are considering the modulation and worse data rates as below table.

MIMO Antenna

Modulation	Data Rate
802.11b	1 Mbps
802.11g	6 Mbps
802.11n HT20	MCS0

Test Cases	
AC Conducted Emission	Mode 1 :Bluetooth Link + WLAN (2.4GHz) Link + Adapter + MPEG4 + HDMI
Remark: For Radiated Test Cases, the tests were performed with Adapter.	

2.3 Connection Diagram of Test System

<WLAN Tx Mode>

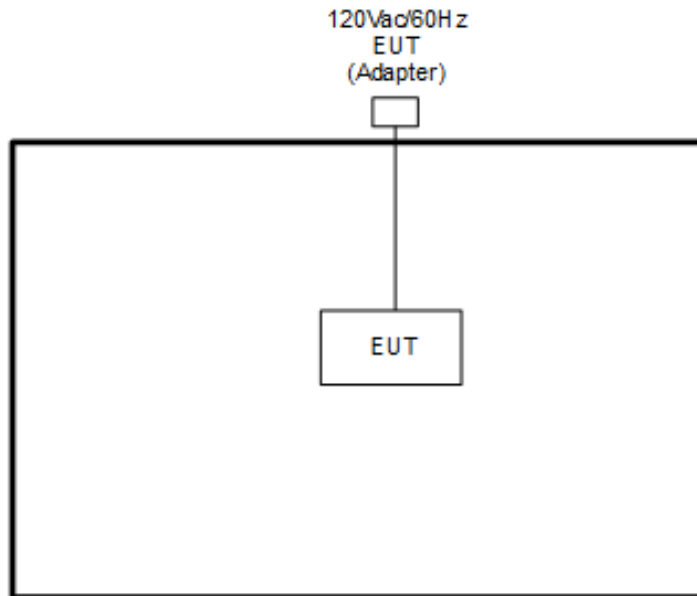

<AC Conducted Emission Mode>

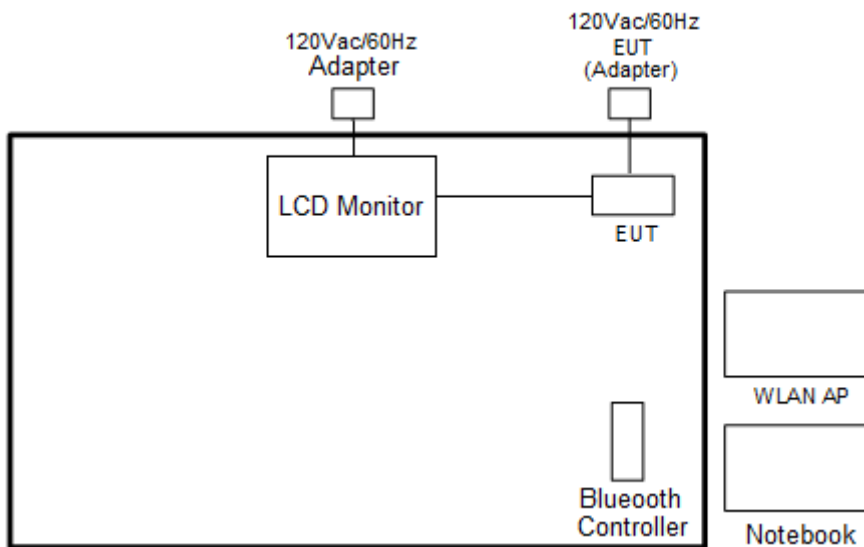



2.4 Support Unit used in test configuration and system

Item	Equipment	Trade Name	Model Name	FCC ID	Data Cable	Power Cord
1.	WLAN AP	ASUS	RT-AC66U	MSQ-RTAC66U	N/A	Unshielded,1.8m
2.	Notebook	DELL	Latitude E6320	FCC DoC	N/A	AC I/P: Unshielded, 1.2 m DC O/P: Shielded, 1.8 m
3.	LCD Monitor	DELL	P2715Qt	FCC DoC	Shielded, 1.6m	Unshielded,1.8m

2.5 EUT Operation Test Setup

The RF test items, utility “QRCT v3.0-00271” was installed in Notebook which was programmed in order to make the EUT get into the engineering modes to provide channel selection, power level, data rate and the application type and for continuous transmitting signals.

2.6 Measurement Results Explanation Example

For all conducted test items:

The offset level is set in the spectrum analyzer to compensate the RF cable loss and attenuator factor between EUT conducted output port and spectrum analyzer. With the offset compensation, the spectrum analyzer reading level is exactly the EUT RF output level.

Example:

The spectrum analyzer offset is derived from RF cable loss and attenuator factor.

Offset = RF cable loss + attenuator factor.

Following shows an offset computation example with cable loss 4.8 dB and 20dB attenuator.

Offset(dB) = RF cable loss(dB) + attenuator factor(dB).

= 4.8 + 20 = 24.80 (dB)

3 Test Result

3.1 6dB and 99% Bandwidth Measurement

3.1.1 Limit of 6dB and 99% Bandwidth

The minimum 6 dB bandwidth shall be at least 500 kHz.

3.1.2 Measuring Instruments

See list of measuring equipment of this test report.

3.1.3 Test Procedures

1. The testing follows the ANSI C63.10 Section 6.9.3 (OBW) and 11.8.1 (6dB BW).
2. The RF output of EUT was connected to the spectrum analyzer by RF cable and attenuator. The path loss was compensated to the results for each measurement.
3. Set to the maximum power setting and enable the EUT transmit continuously.
4. Make the measurement with the spectrum analyzer's resolution bandwidth (RBW) = 100 kHz. Set the Video bandwidth (VBW) = 300 kHz. In order to make an accurate measurement. The 6 dB bandwidth must be greater than 500 kHz.
5. For 99% Bandwidth Measurement, the spectrum analyzer's resolution bandwidth (RBW) is set 1-5% of the emission bandwidth and set the Video bandwidth (VBW) $\geq 3 * RBW$.
6. Measure and record the results in the test report.

3.1.4 Test Setup





3.1.5 Test Result of 6dB and 99% Occupied Bandwidth

Please refer to Appendix A.

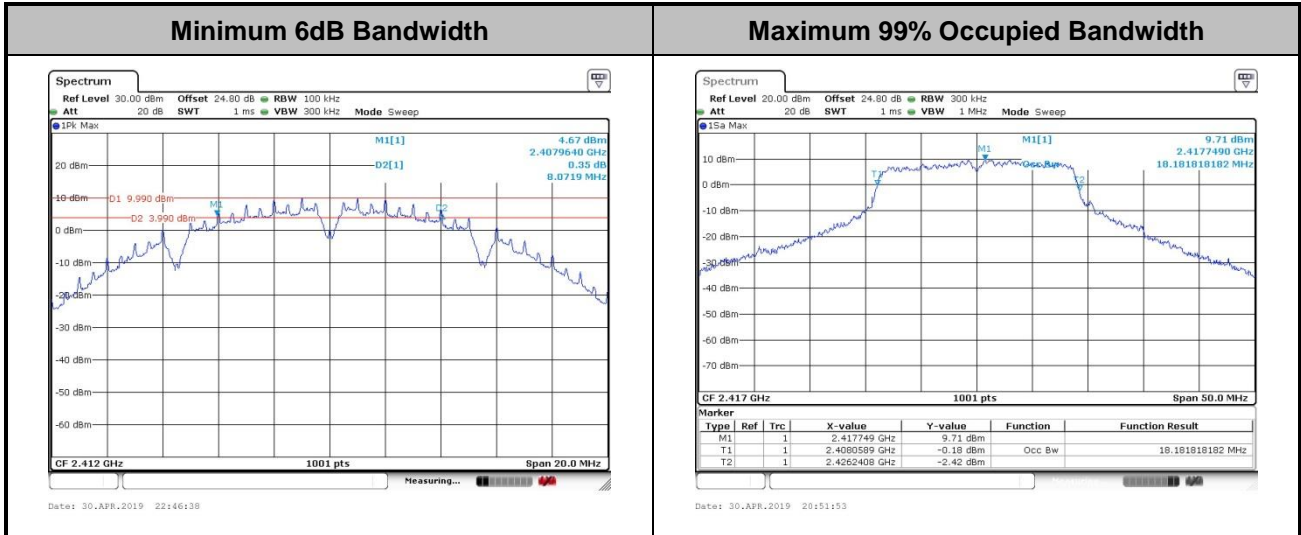

Note: The occupied channel bandwidth is maintained within the band of operation for all of the modulations.

3.2 Output Power Measurement

3.2.1 Limit of Output Power

For systems using digital modulation in the 2400-2483.5MHz, the limit for peak output power is 30dBm. If transmitting antenna with directional gain greater than 6dBi is used, the peak output power from the intentional radiator shall be reduced below the above stated value by the amount in dB that the directional gain of the antenna exceeds 6 dBi. In case of point-to-point operation, the limit has to be reduced by 1dB for every 3dB that the directional gain of the antenna exceeds 6dBi.

3.2.2 Measuring Instruments

See list of measuring equipment of this test report.

3.2.3 Test Procedures

1. For Peak Power, the testing follows ANSI C63.10 Section 11.9.1.3 PKPM1
2. For Average Power, the testing follows ANSI C63.10 Section 11.9.2.3.2 Method AVGPM-G
3. The RF output of EUT was connected to the power meter by RF cable and attenuator. The path loss was compensated to the results for each measurement.
4. Set to the maximum power setting and enable the EUT transmit continuously.
5. Measure the conducted output power and record the results in the test report.
6. For MIMO mode, calculation method follows FCC KDB 662911 D01 Multiple Transmitter Output v02r01.

3.2.4 Test Setup

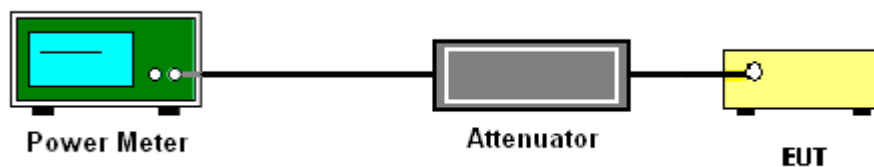

3.2.5 Test Result of Average Output Power

Please refer to Appendix A.



3.3 Power Spectral Density Measurement

3.3.1 Limit of Power Spectral Density

The peak power spectral density shall not be greater than 8dBm in any 3kHz band at any time interval of continuous transmission.

3.3.2 Measuring Instruments

See list of measuring equipment of this test report.

3.3.3 Test Procedures

1. The testing follows the ANSI C63.10 Section 11.10.2 Method PKPSD.
2. The RF output of EUT was connected to the spectrum analyzer by RF cable and attenuator. The path loss was compensated to the results for each measurement.
3. Set to the maximum power setting and enable the EUT transmit continuously.
4. Make the measurement with the spectrum analyzer's resolution bandwidth (RBW) = 3 kHz. Video bandwidth VBW = 10 kHz In order to make an accurate measurement, set the span to 1.5 times DTS Channel Bandwidth. (6dB BW)
5. Detector = peak, Sweep time = auto couple, Trace mode = max hold, Allow trace to fully stabilize. Use the peak marker function to determine the maximum power level.
6. Measure and record the results in the test report.
7. For MIMO mode, calculation method follows FCC KDB 662911 D01 Multiple Transmitter Output v02r01.

If measurements performed using method (2) plus $10 \log(N)$ exceeds the emission limit, the test should choose method (1) before declaring that the device fails the emission limit.

Method (1): Measure and sum the spectra across the outputs.

The total final Power Spectral Density is from a device with 2 transmitter outputs. The spectrum measurements of the individual outputs are all performed with the same span and number of points, the spectrum value in the first spectral bin of output 1 is summed with that in the first spectral bin of output 2 to obtain the value for the first frequency bin of the summed spectrum.

Method (2): Measure and add $10 \log(N)$ dB, where N is the number of outputs. (N=2)

3.3.4 Test Setup

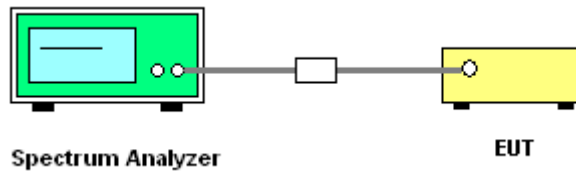

3.3.5 Test Result of Power Spectral Density

Please refer to Appendix A.

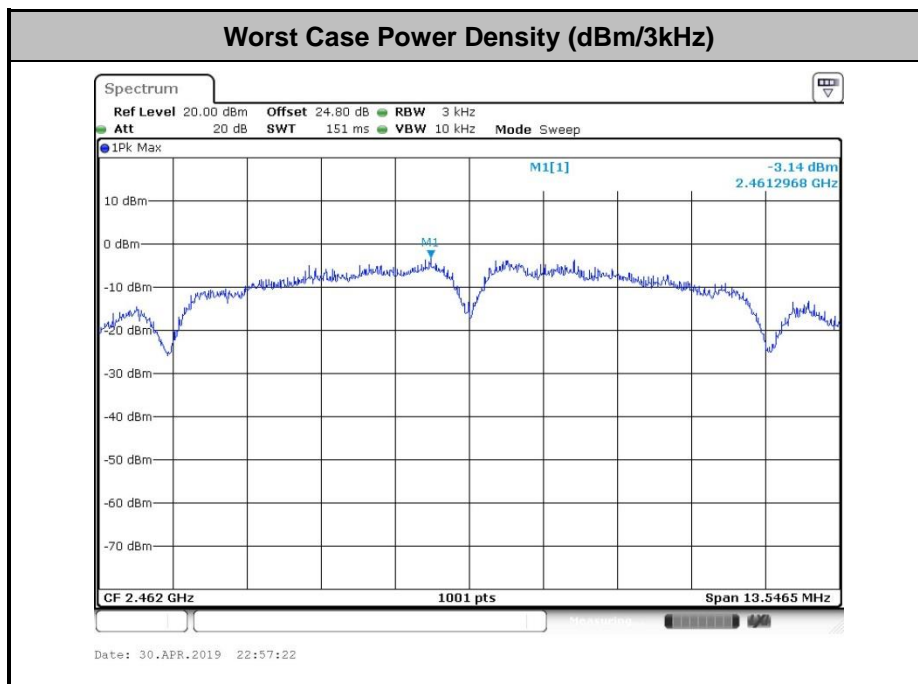

3.4 Conducted Band Edges and Spurious Emission Measurement

3.4.1 Limit of Conducted Band Edges and Spurious Emission Measurement

In any 100 kHz bandwidth outside of the authorized frequency band, the emissions which fall in the non-restricted bands shall be attenuated at least 20 dB / 30dB relative to the maximum PSD level in 100 kHz by RF conducted measurement.

3.4.2 Measuring Instruments

See list of measuring equipment of this test report.

3.4.3 Test Procedures

1. The testing follows the ANSI C63.10 Section 11.11.3 Emission level measurement.
2. The RF output of EUT was connected to the spectrum analyzer by RF cable and attenuator. The path loss was compensated to the results for each measurement.
3. Set to the maximum power setting and enable the EUT transmit continuously.
4. Set RBW = 100 kHz, VBW=300 kHz, Peak Detector. Unwanted Emissions measured in any 100 kHz bandwidth outside of the authorized frequency band shall be attenuated by at least 20 dB relative to the maximum in-band peak PSD level in 100 kHz when maximum peak conducted output power procedure is used. If the transmitter complies with the conducted power limits based on the use of RMS averaging over a time interval, the attenuation required under this paragraph shall be 30 dB instead of 20 dB per 15.247(d).
5. Measure and record the results in the test report.
6. The RF fundamental frequency should be excluded against the limit line in the operating frequency band.

3.4.4 Test Setup

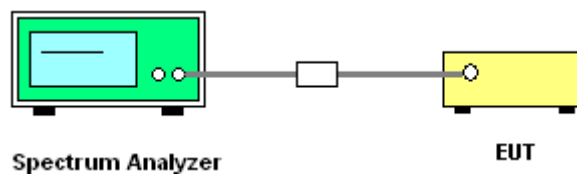



3.4.5 Test Result of Conducted Band Edges and Spurious Emission

Test Engineer : Leo Li	Temperature :	21~25°C
	Relative Humidity :	51~54%

Number of TX = 2, Ant. 1 (Measured)

Test Mode :	802.11b	Test Channel :	01
-------------	---------	----------------	----

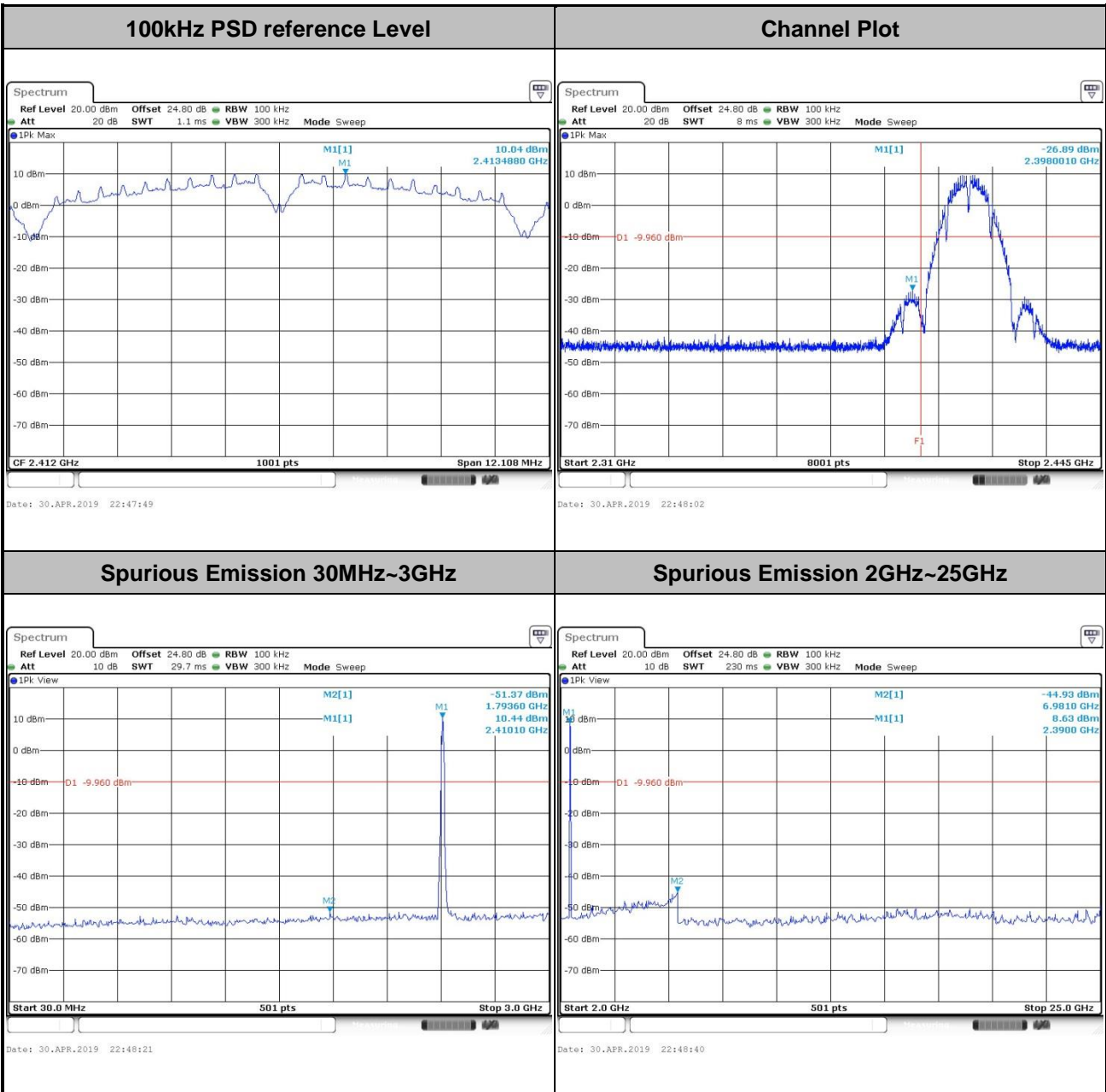



Test Mode :	802.11b	Test Channel :	06
-------------	---------	----------------	----

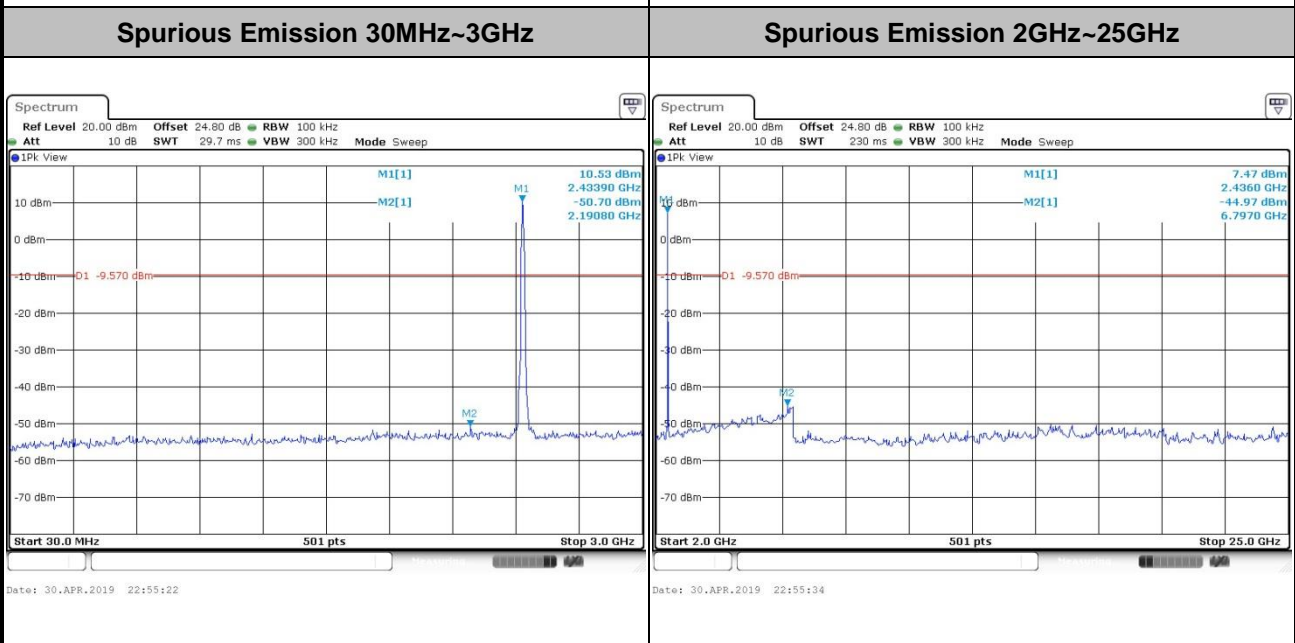
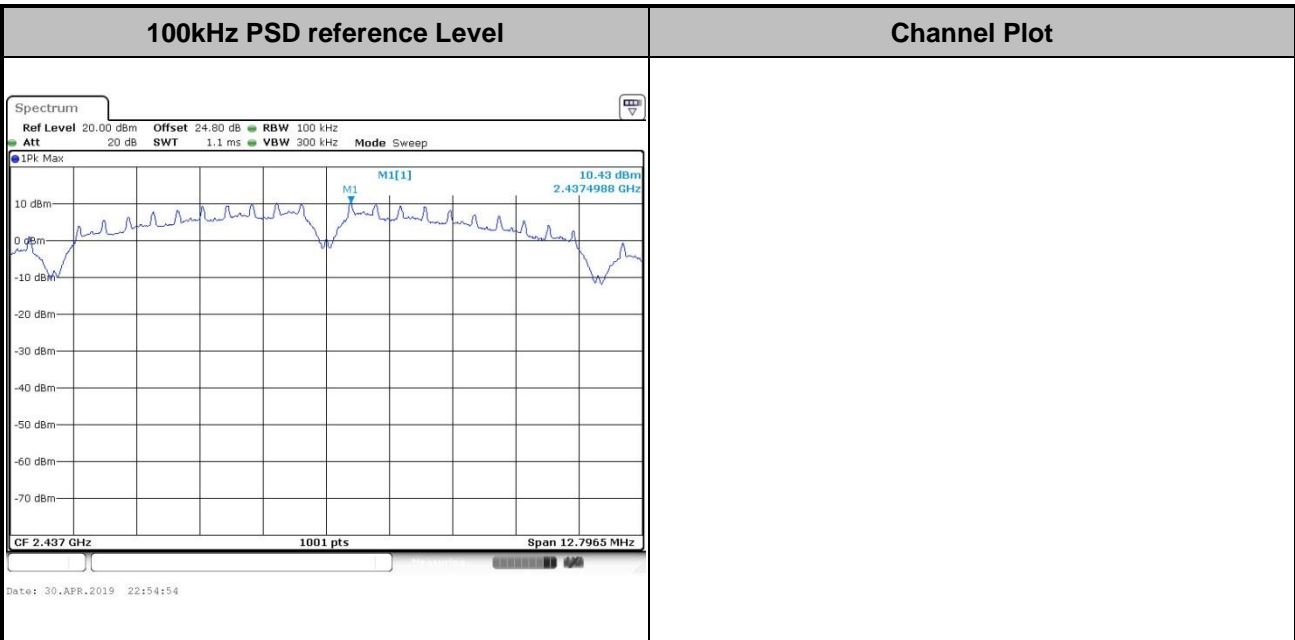



Test Mode :	802.11b	Test Channel :	11
-------------	---------	----------------	----

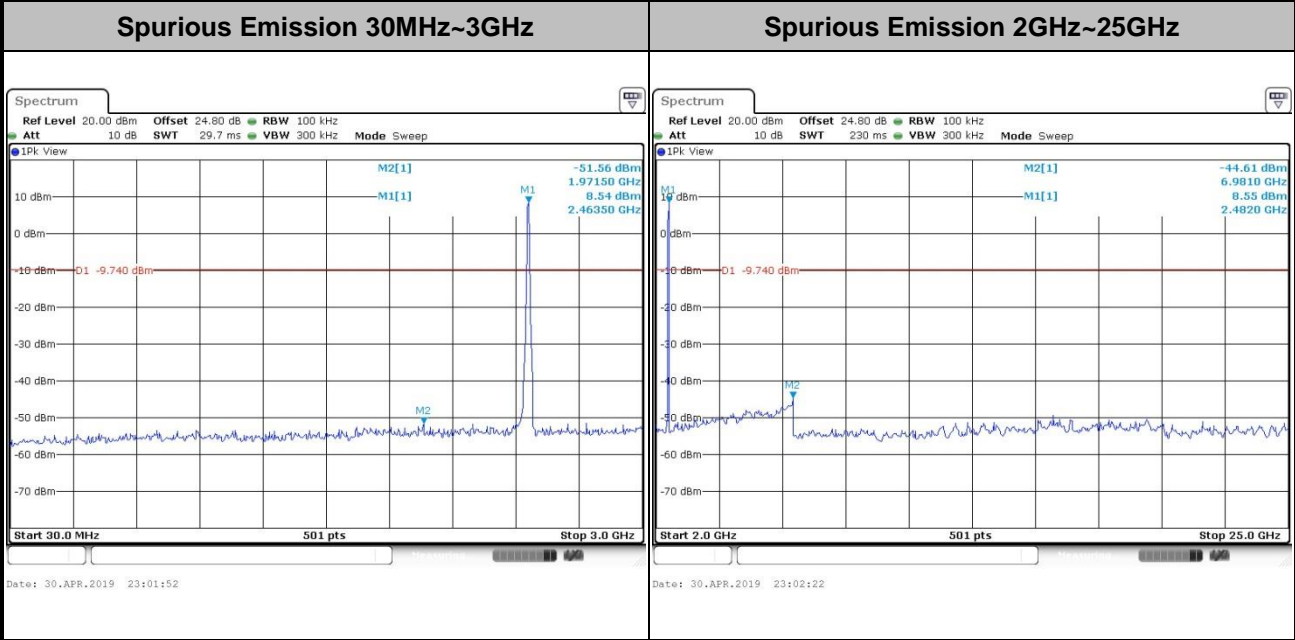
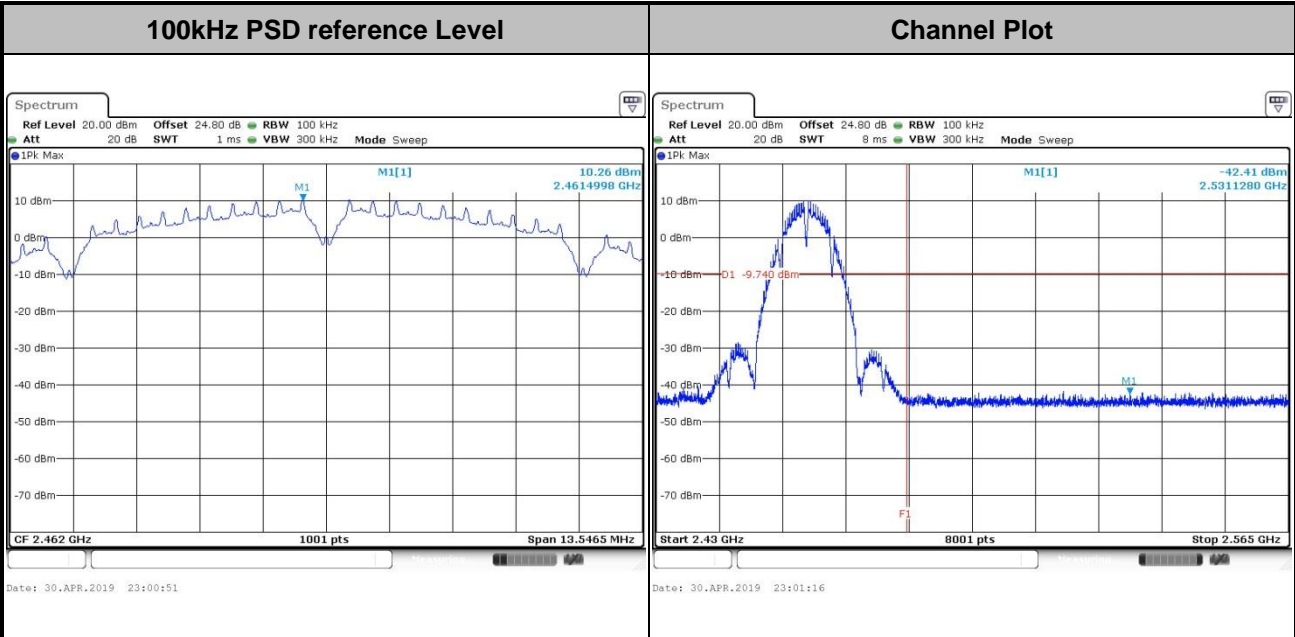



Test Mode :	802.11g	Test Channel :	01
-------------	---------	----------------	----

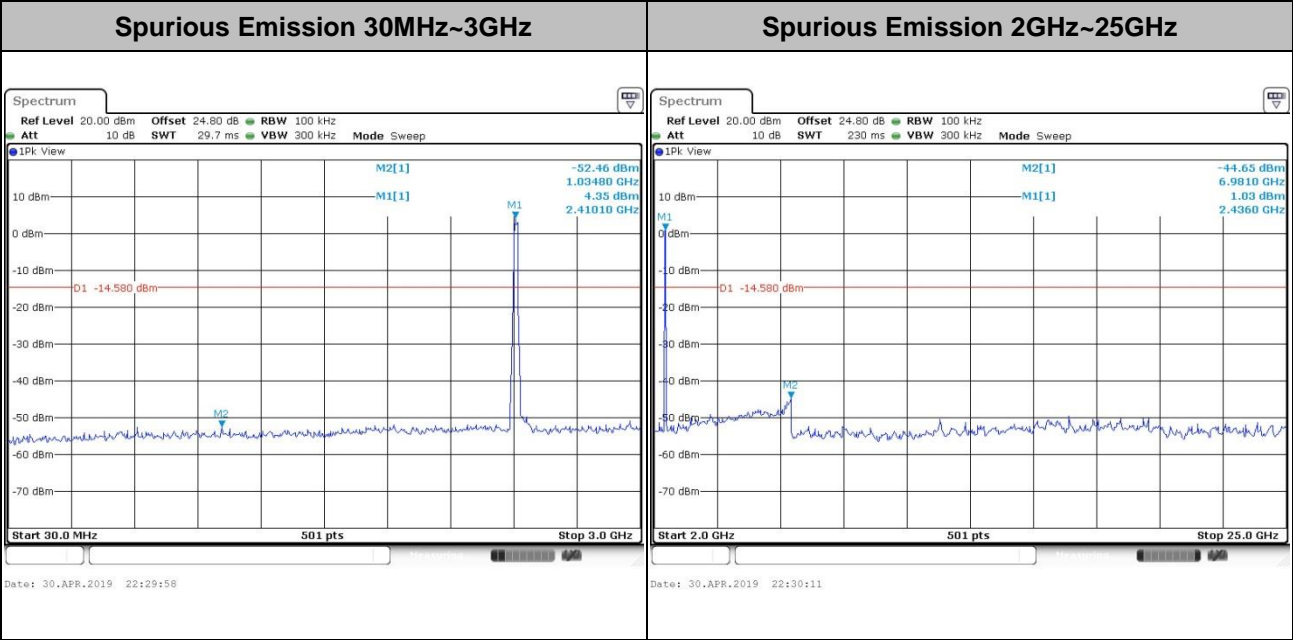
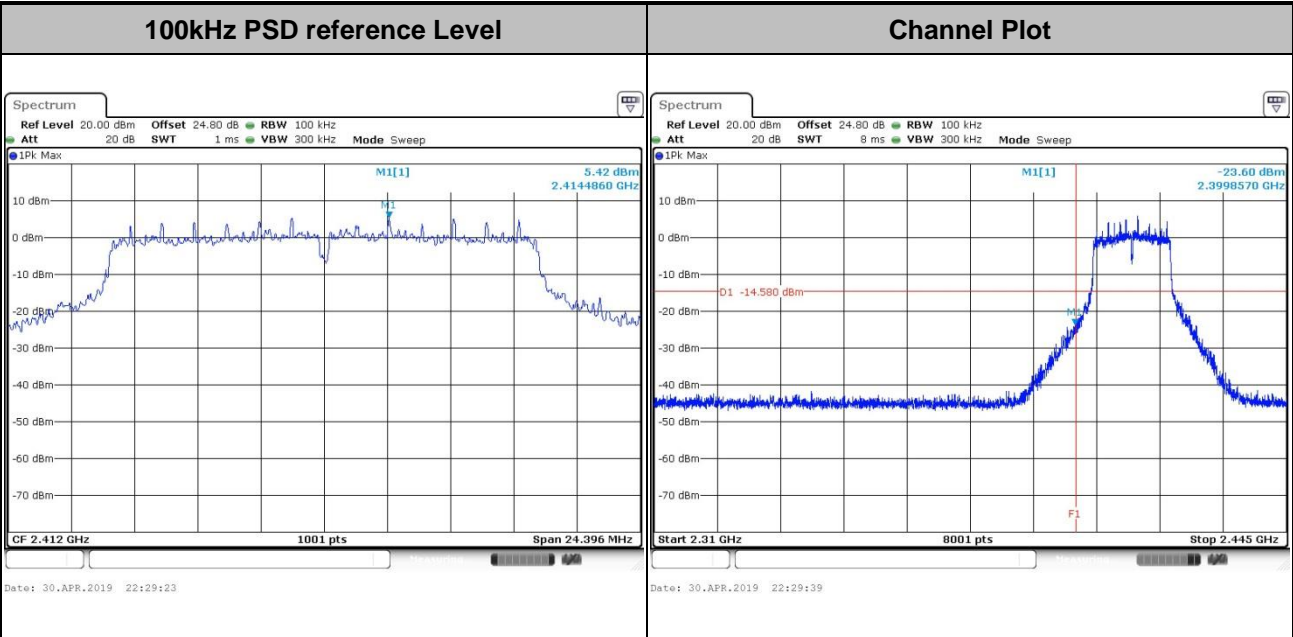



Test Mode :	802.11g	Test Channel :	06
-------------	---------	----------------	----

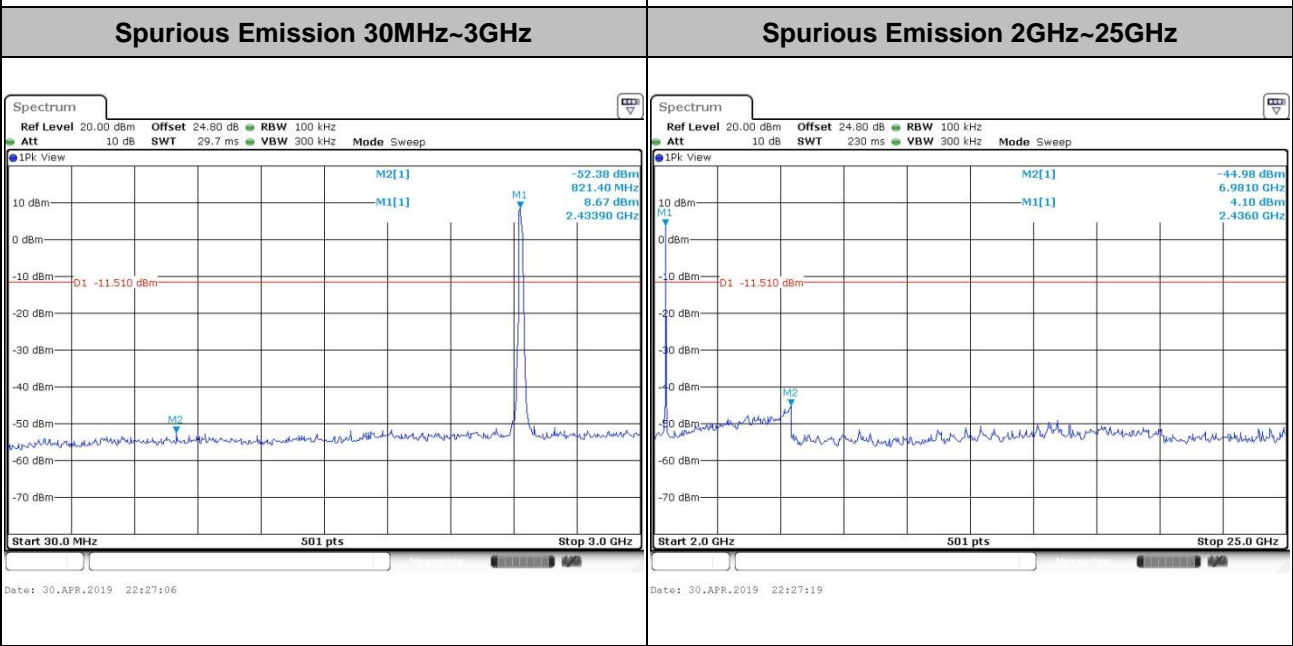
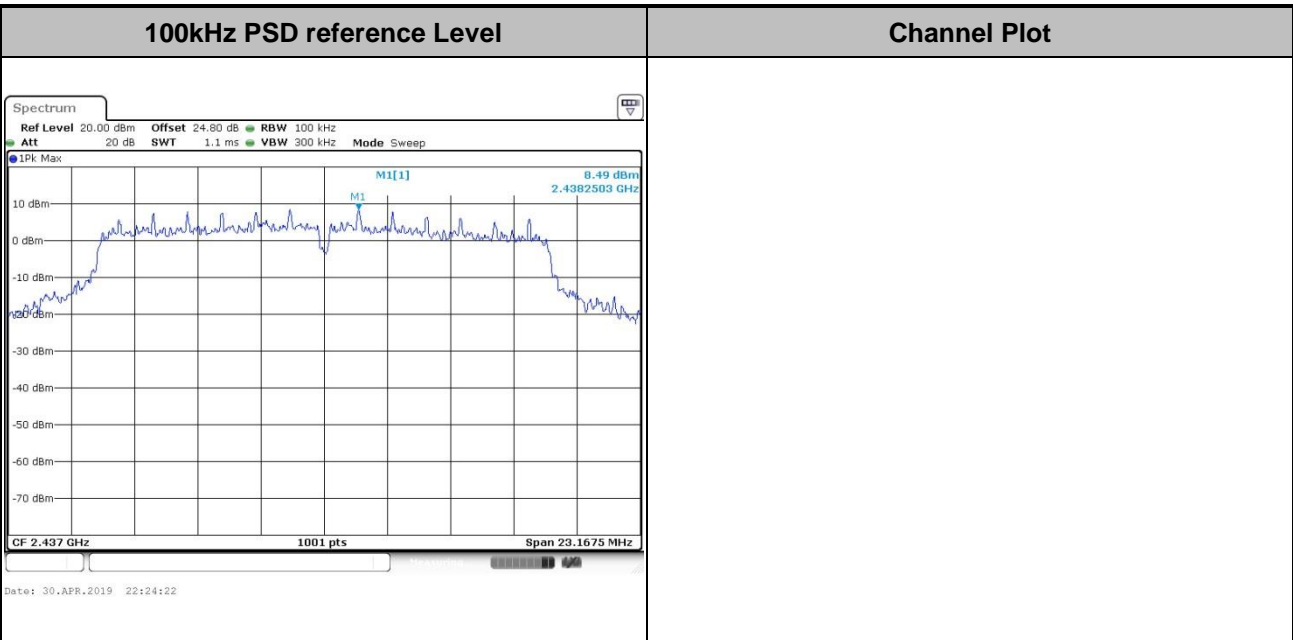



Test Mode :	802.11g	Test Channel :	11
-------------	---------	----------------	----

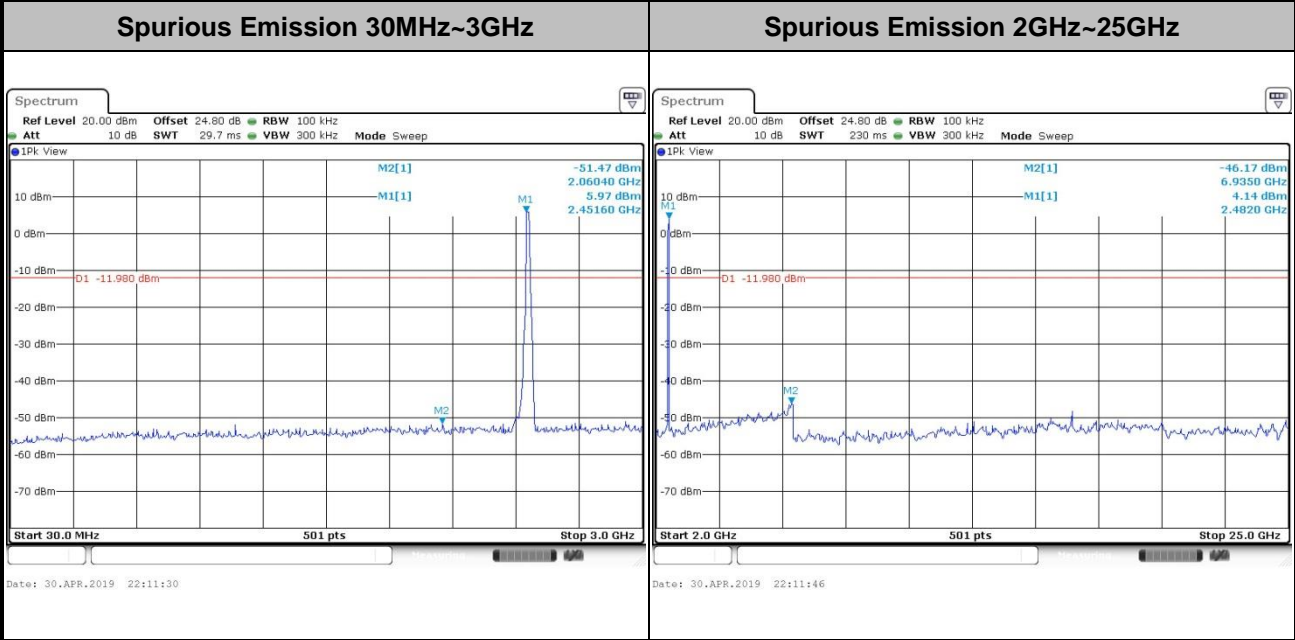
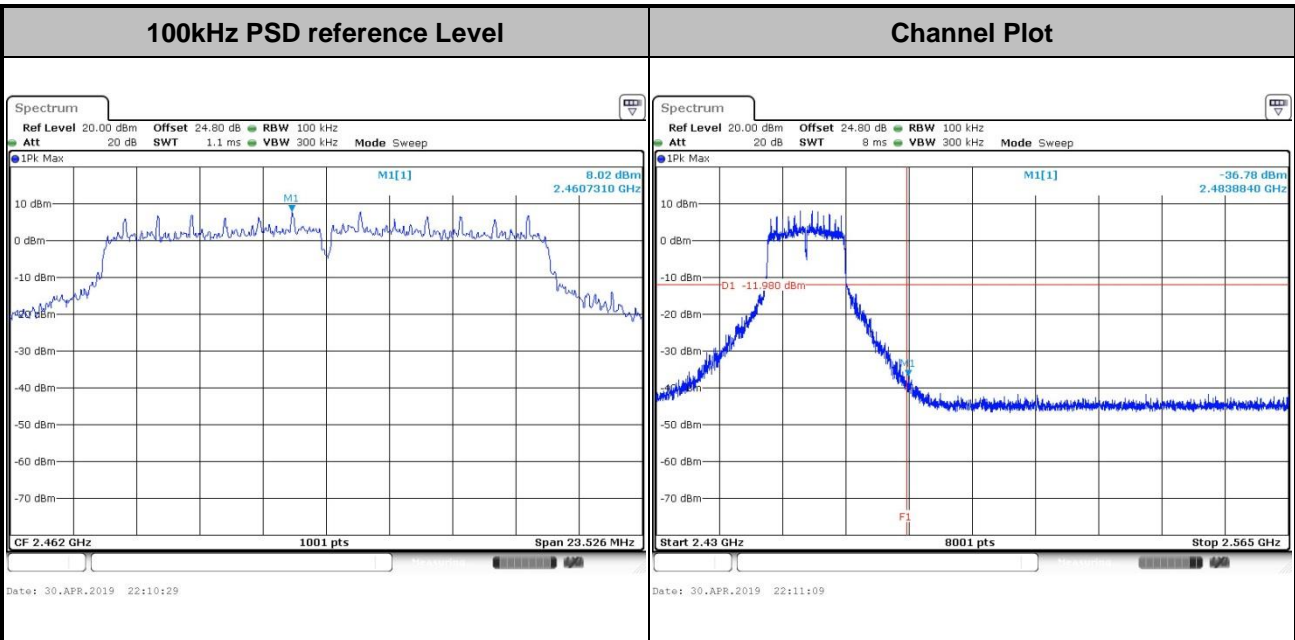



Test Mode : 802.11n HT20 Test Channel : 01

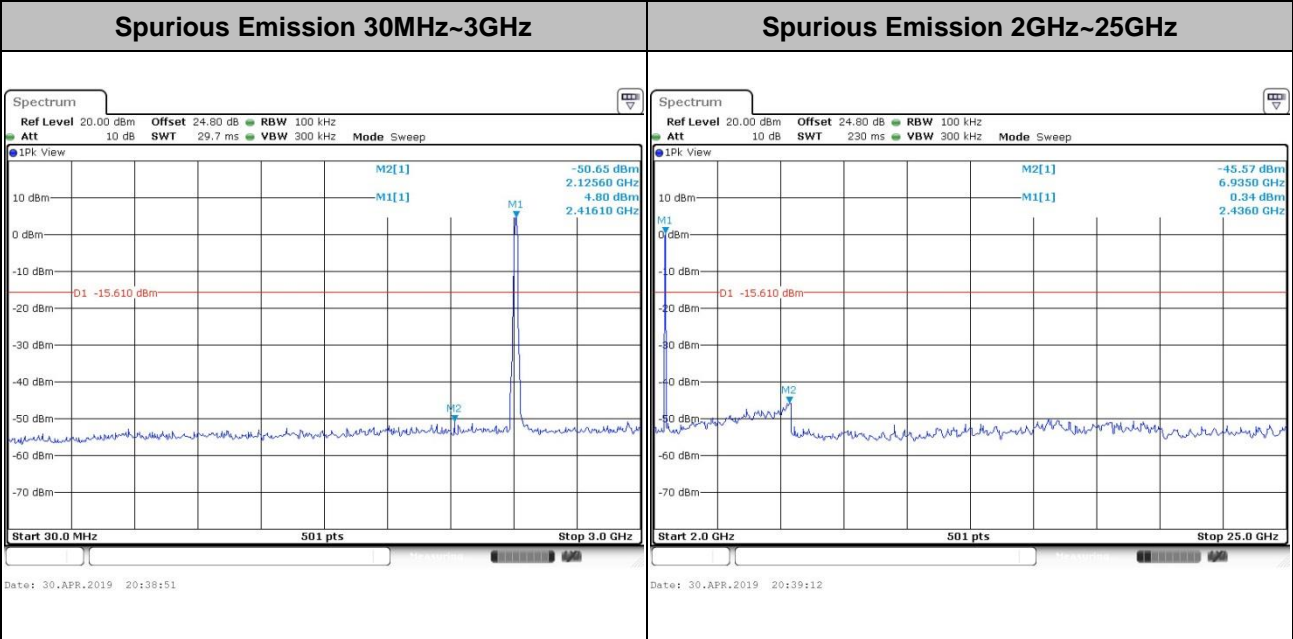
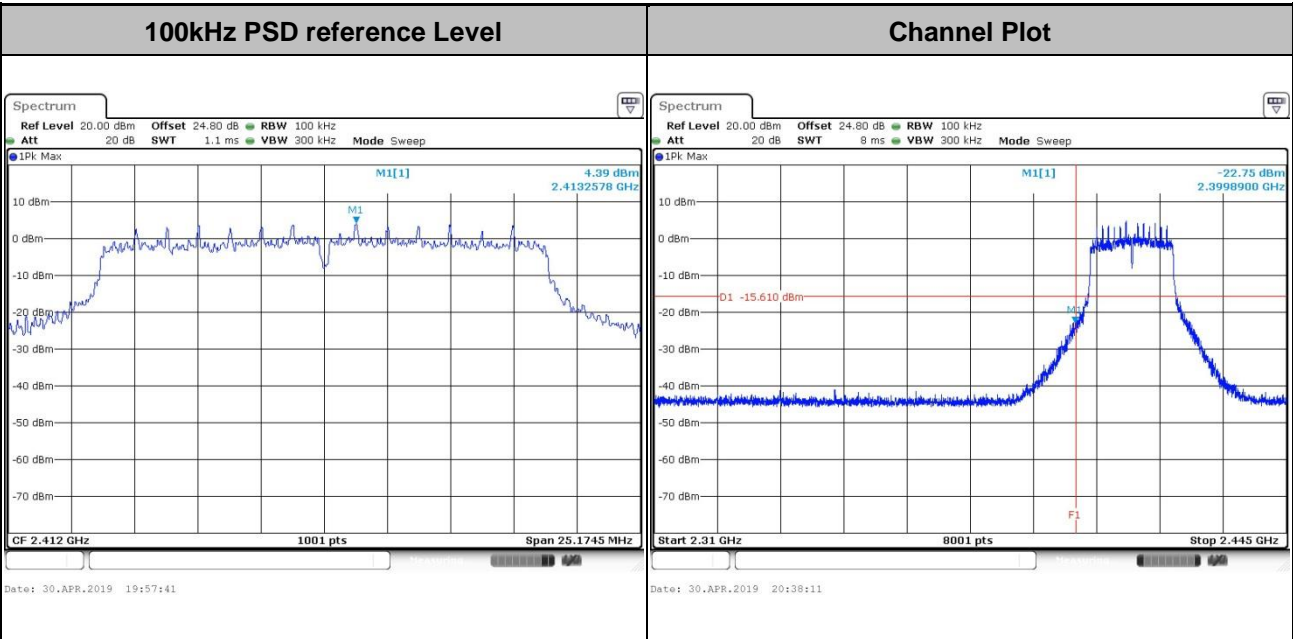



Test Mode : 802.11n HT20 Test Channel : 02

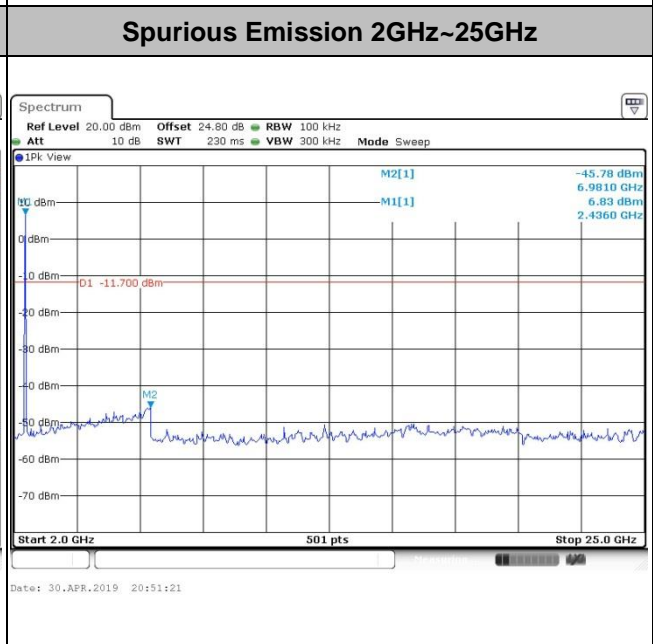
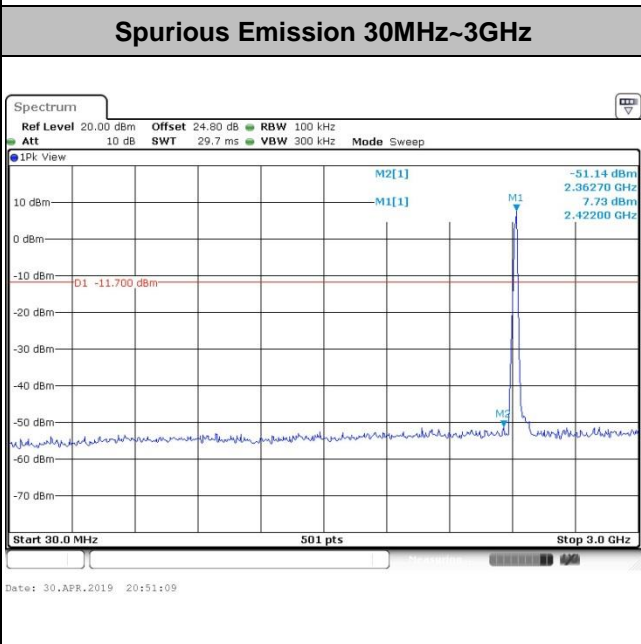
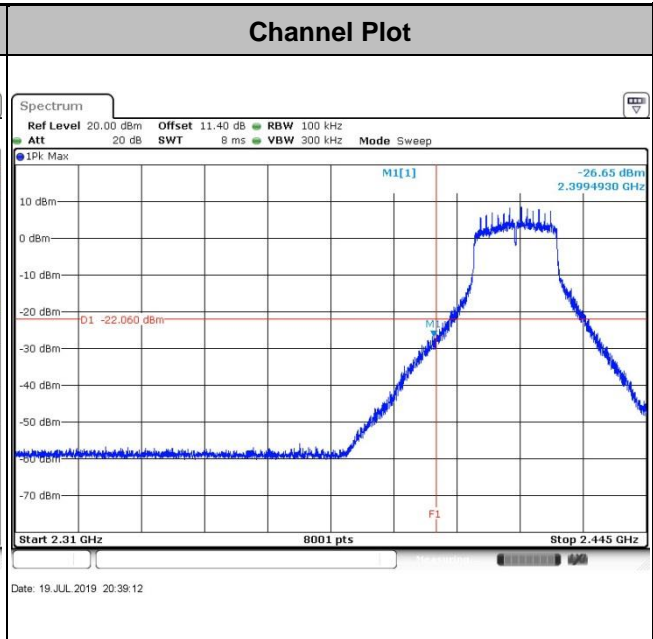
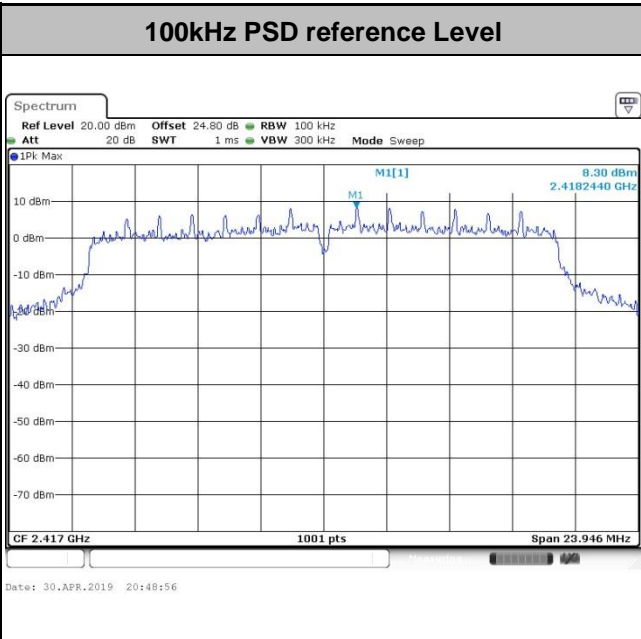



Test Mode :	802.11n HT20	Test Channel :	06
-------------	--------------	----------------	----

100kHz PSD reference Level	Channel Plot
----------------------------	--------------

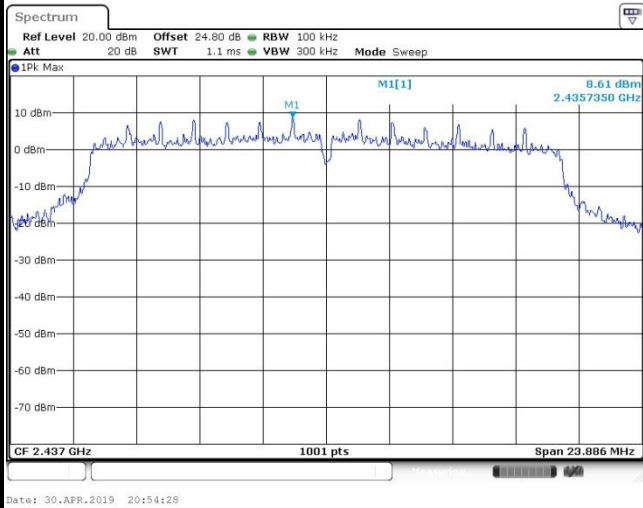

Spurious Emission 30MHz~3GHz	Spurious Emission 2GHz~25GHz
------------------------------	------------------------------

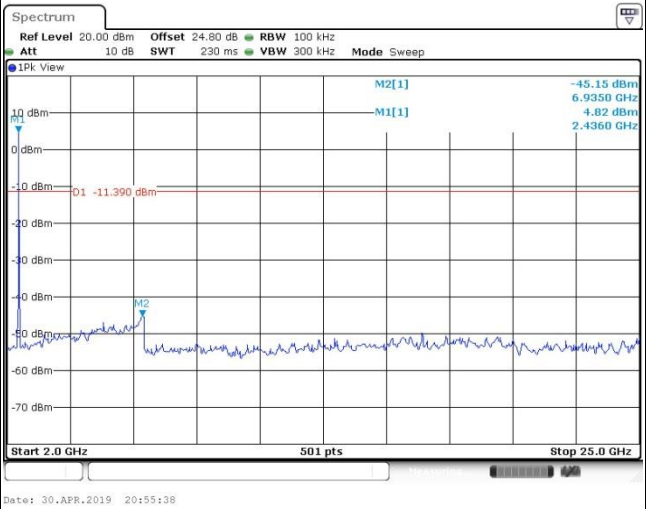
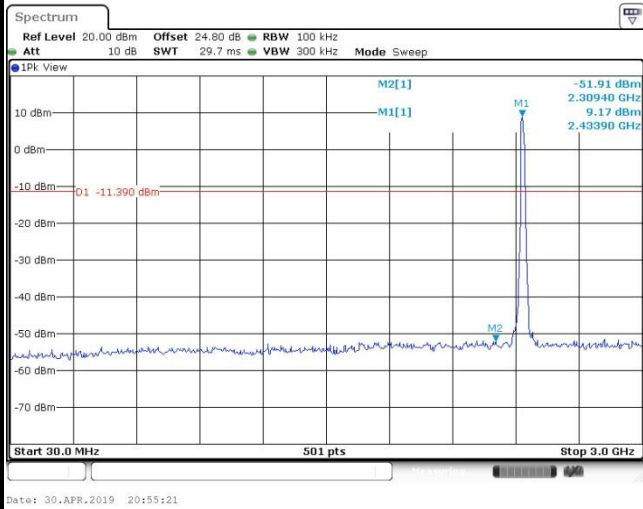



Test Mode : 802.11n HT20 Test Channel : 11

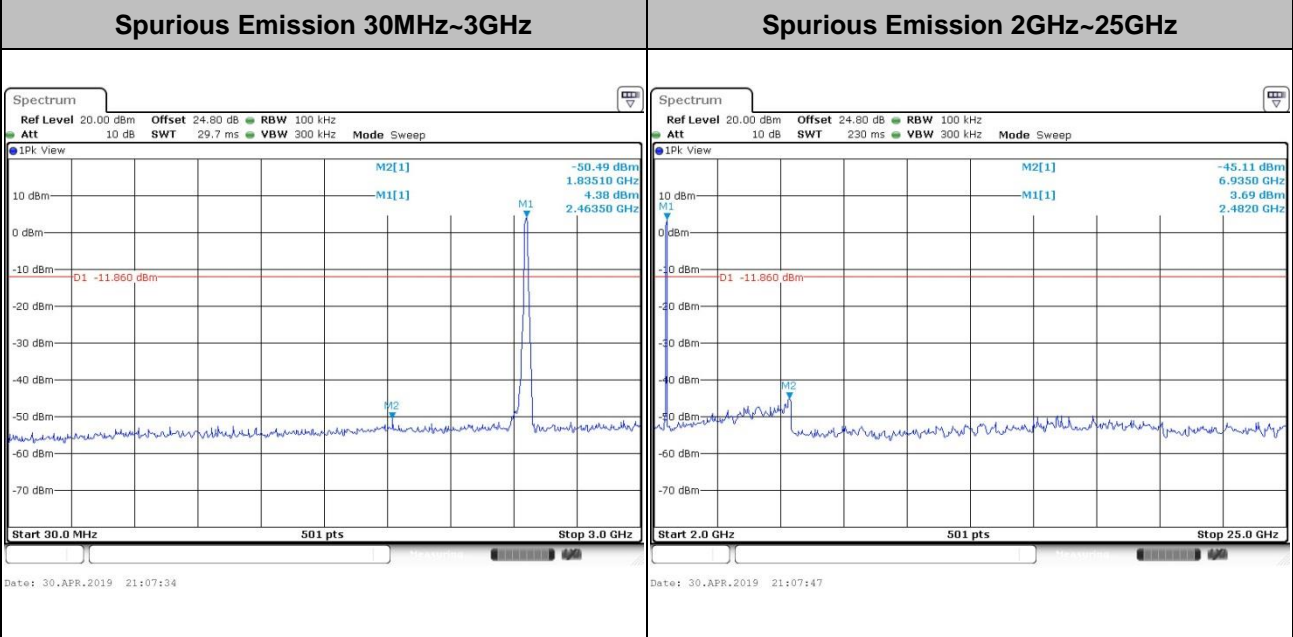
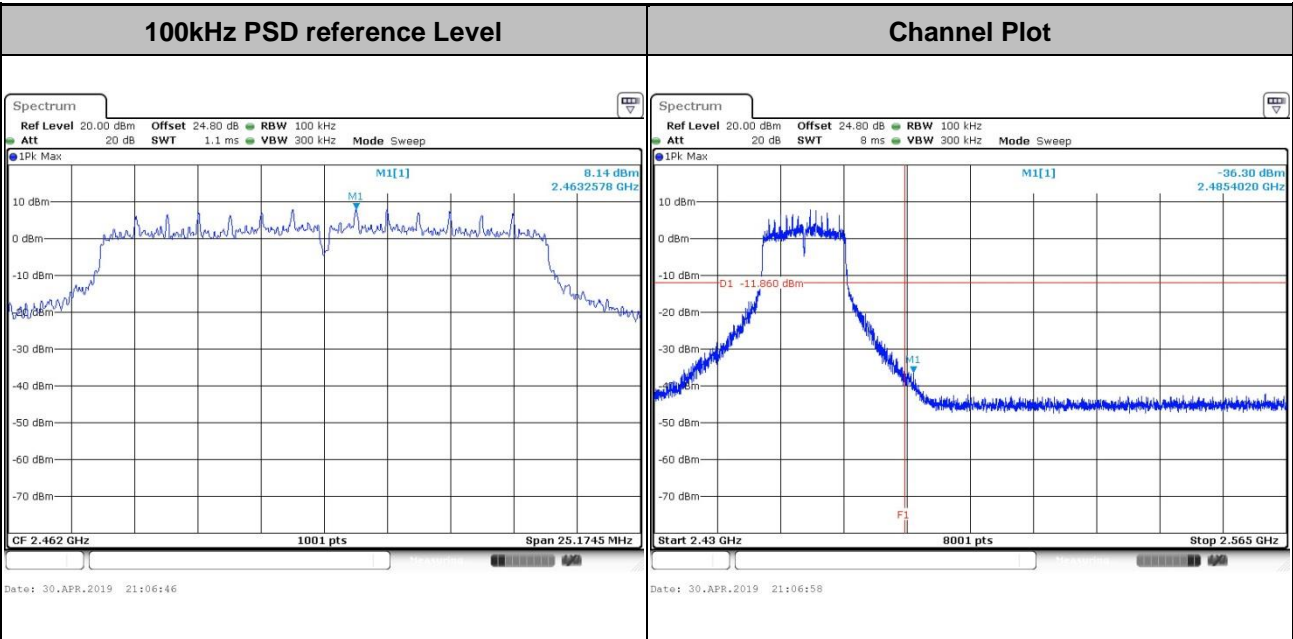



Number of TX = 2, Ant. 2 (Measured)

Test Mode :	802.11b	Test Channel :	01
-------------	---------	----------------	----

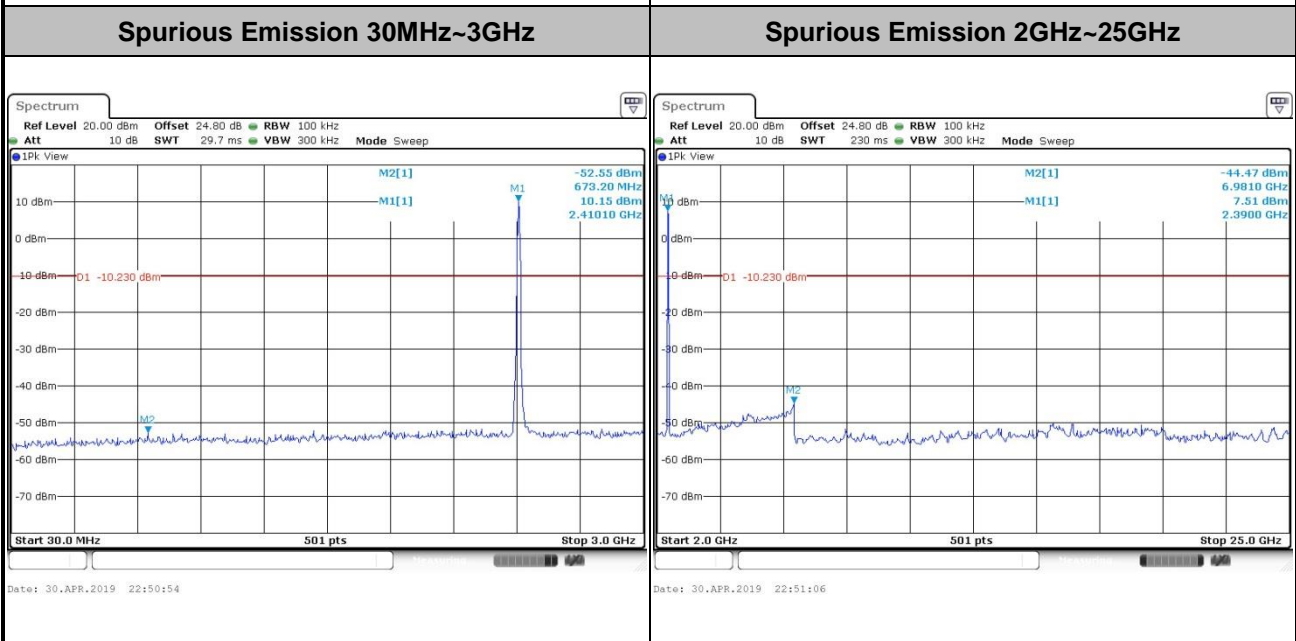
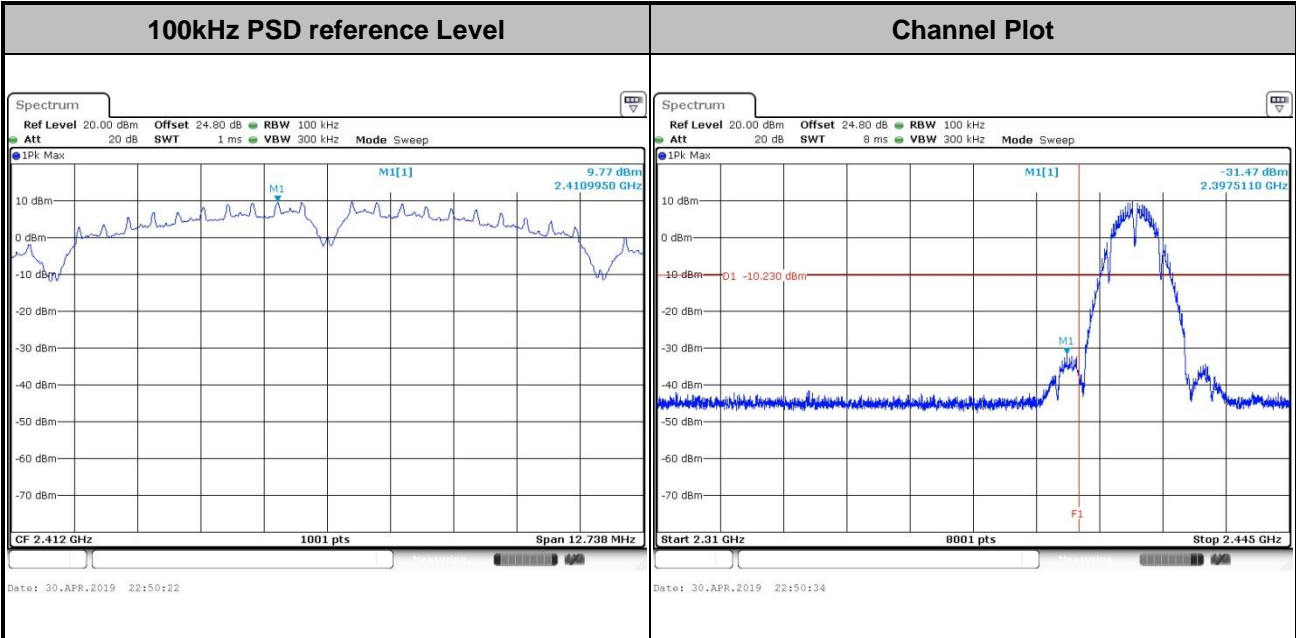



Test Mode :	802.11b	Test Channel :	06
-------------	---------	----------------	----

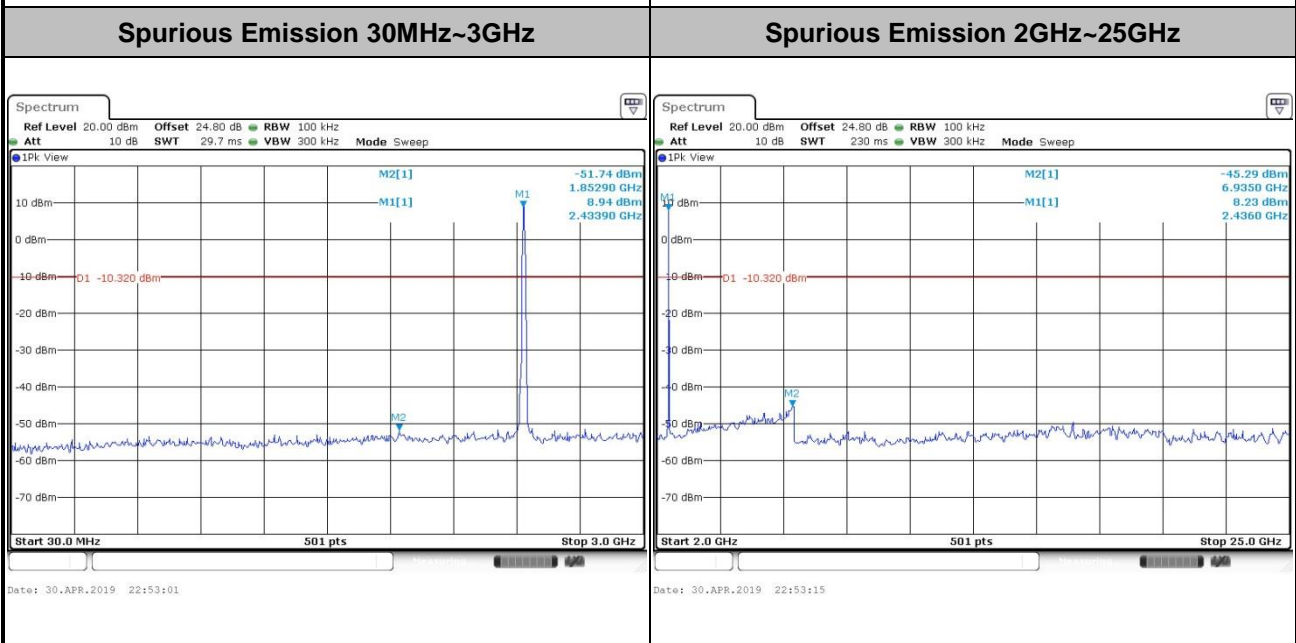
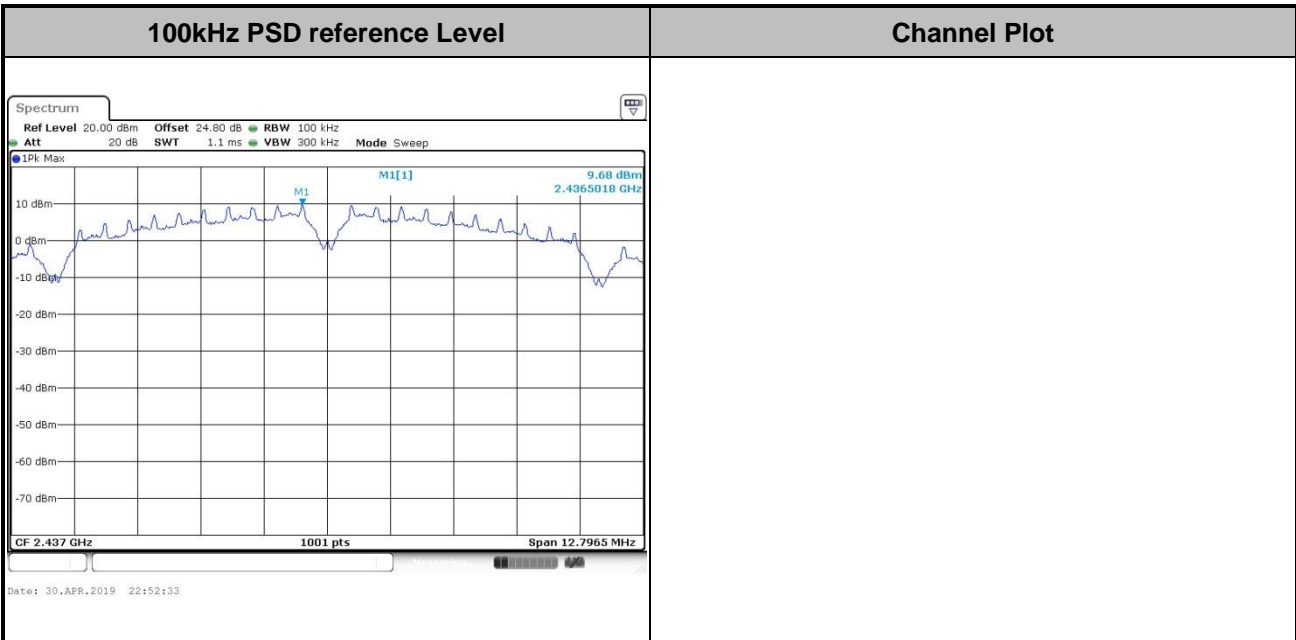



Test Mode :	802.11b	Test Channel :	11
-------------	---------	----------------	----

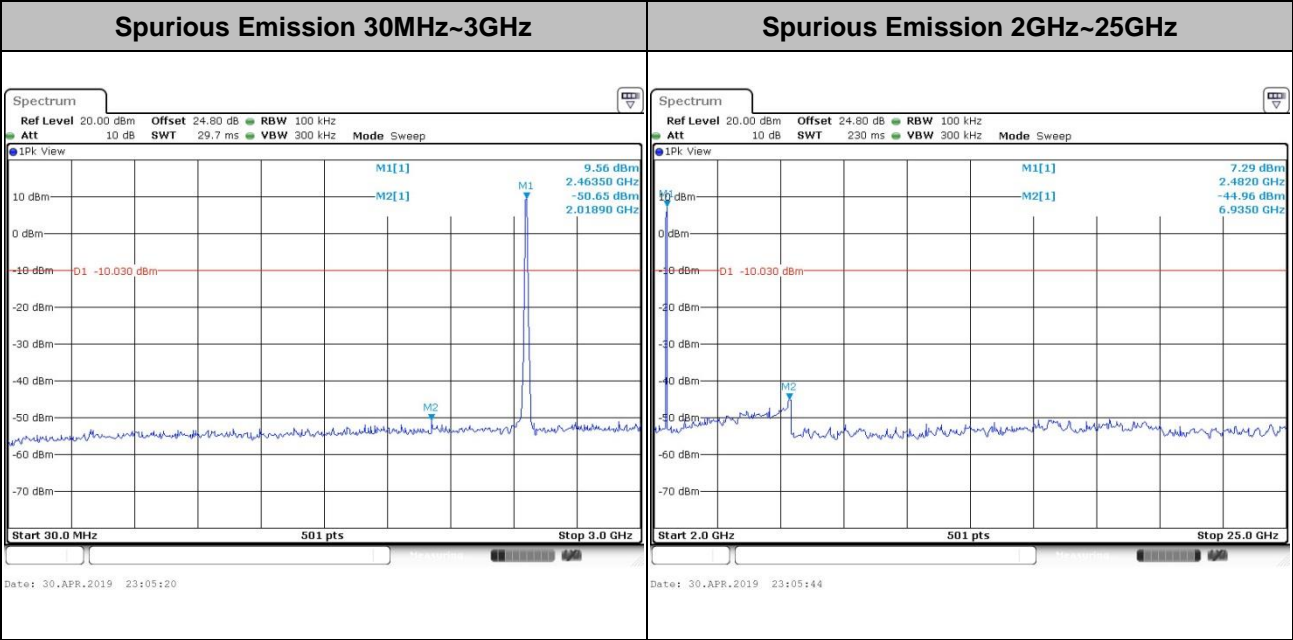
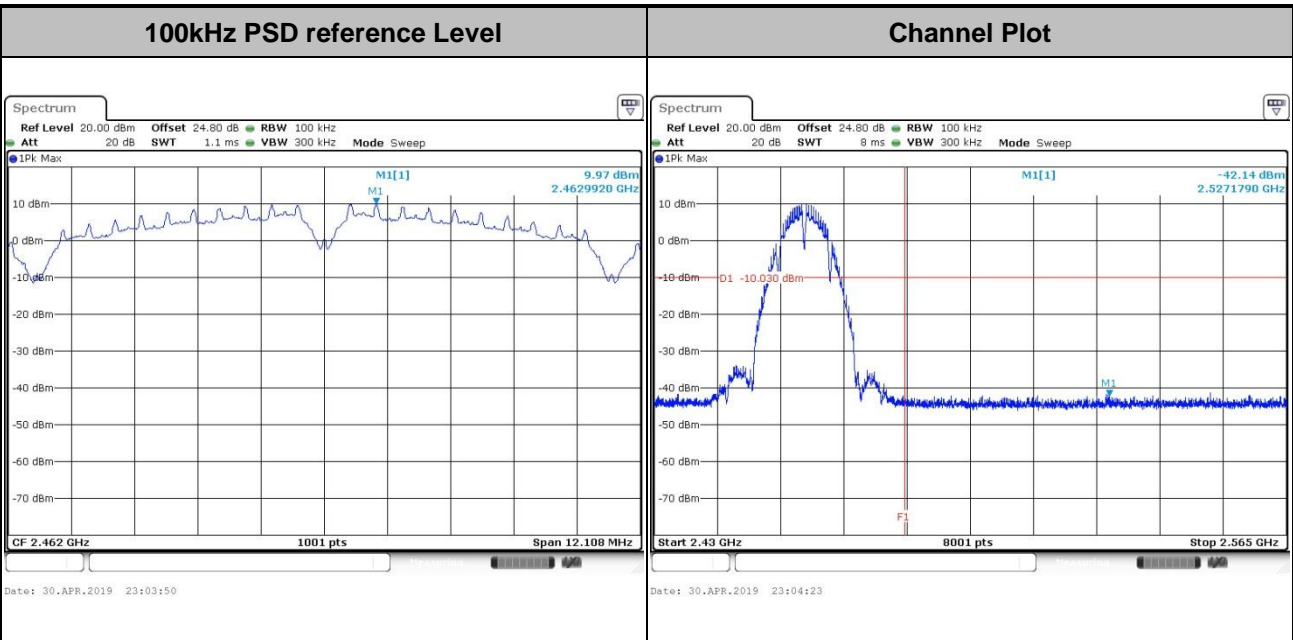



Test Mode :	802.11g	Test Channel :	01
-------------	---------	----------------	----

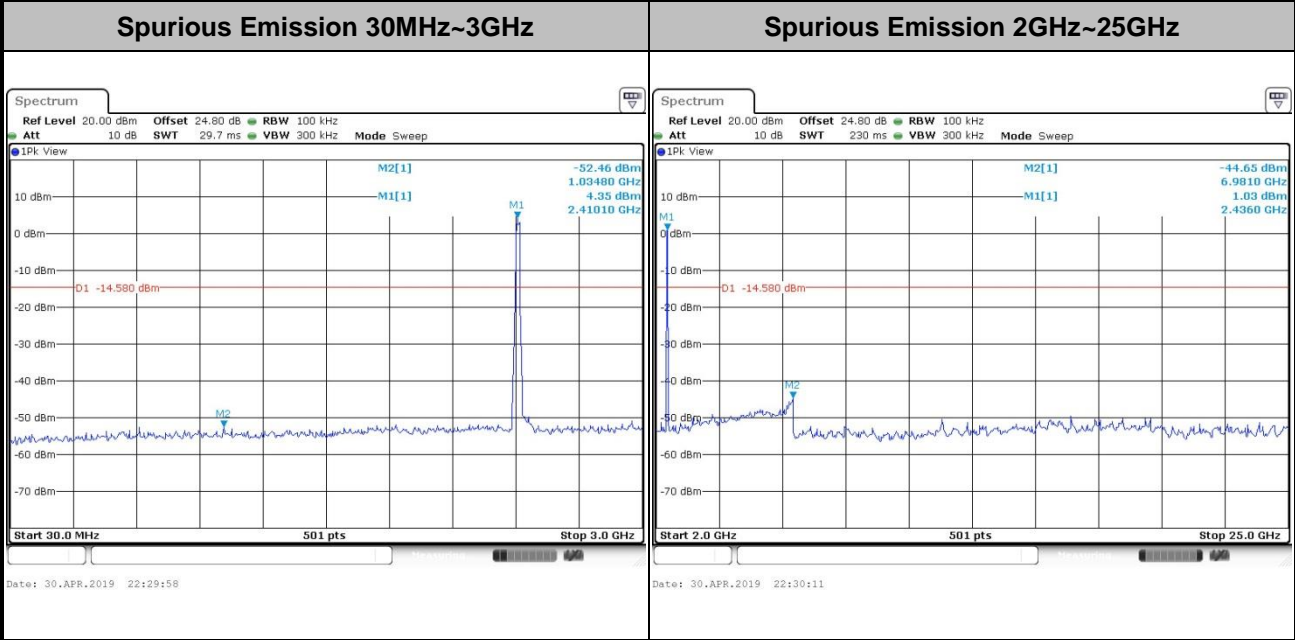
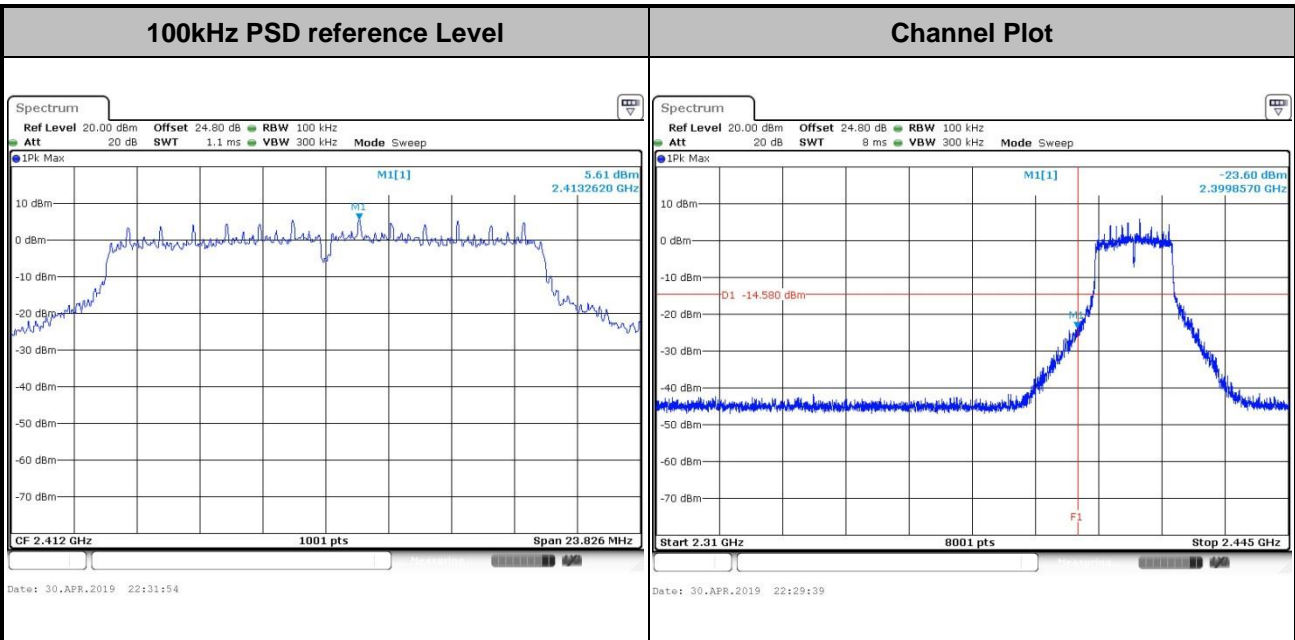



Test Mode :	802.11g	Test Channel :	06
-------------	---------	----------------	----

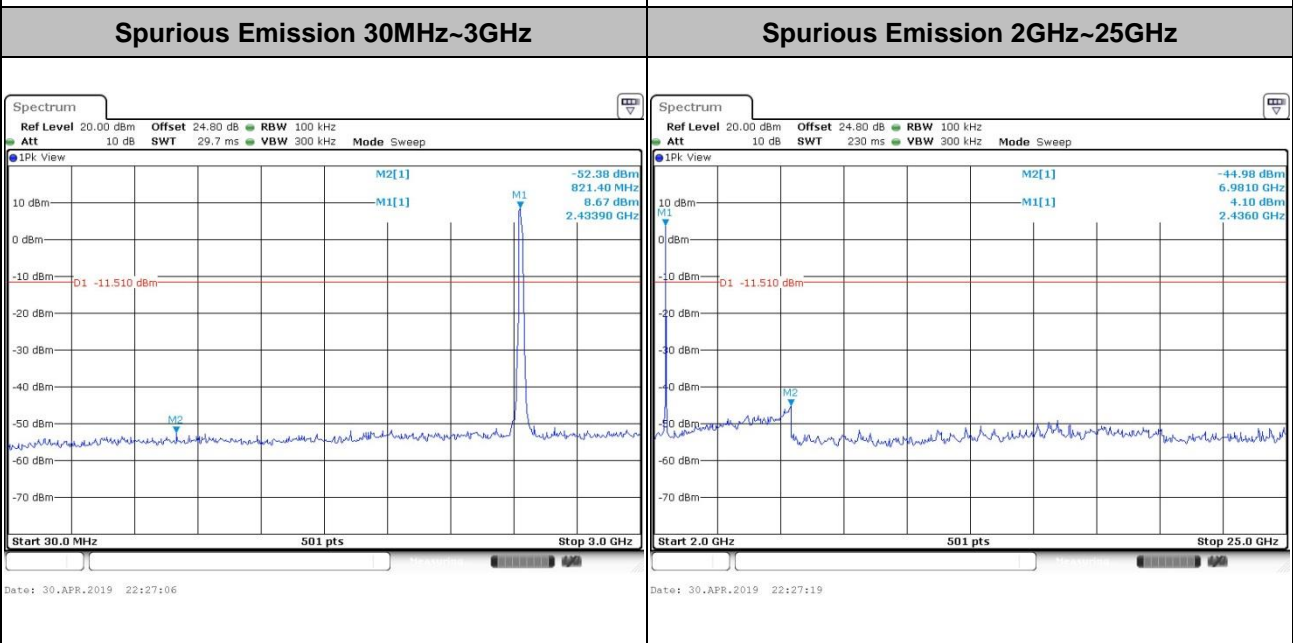
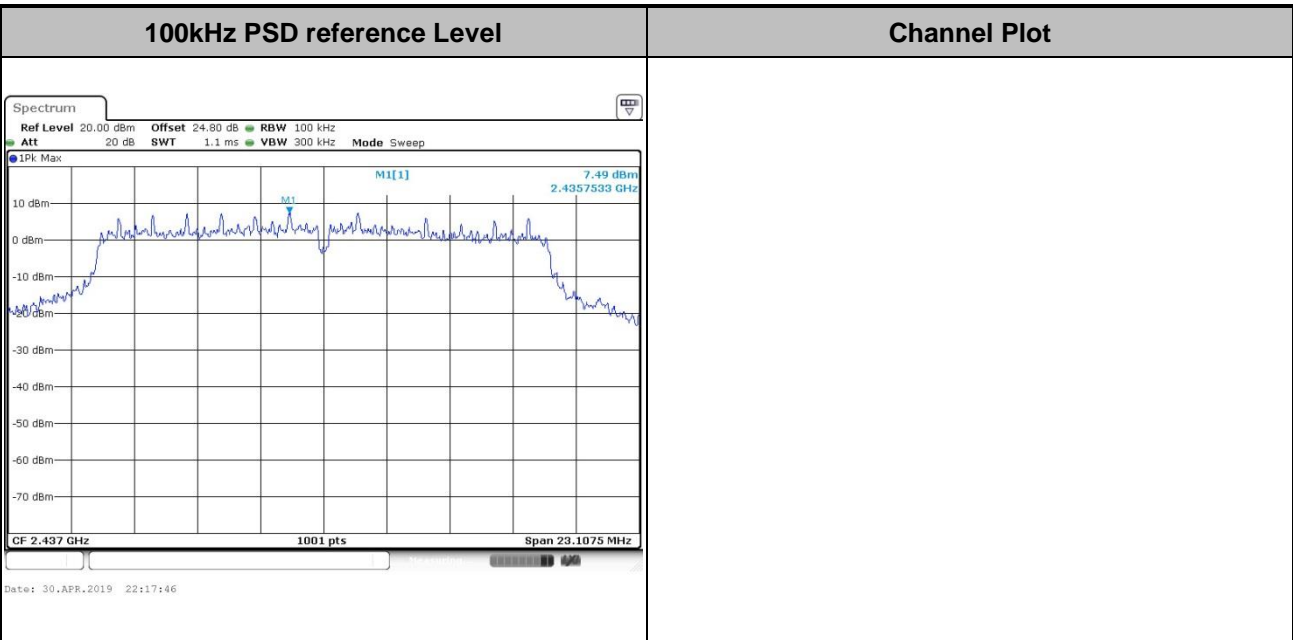



Test Mode :	802.11g	Test Channel :	11
-------------	---------	----------------	----

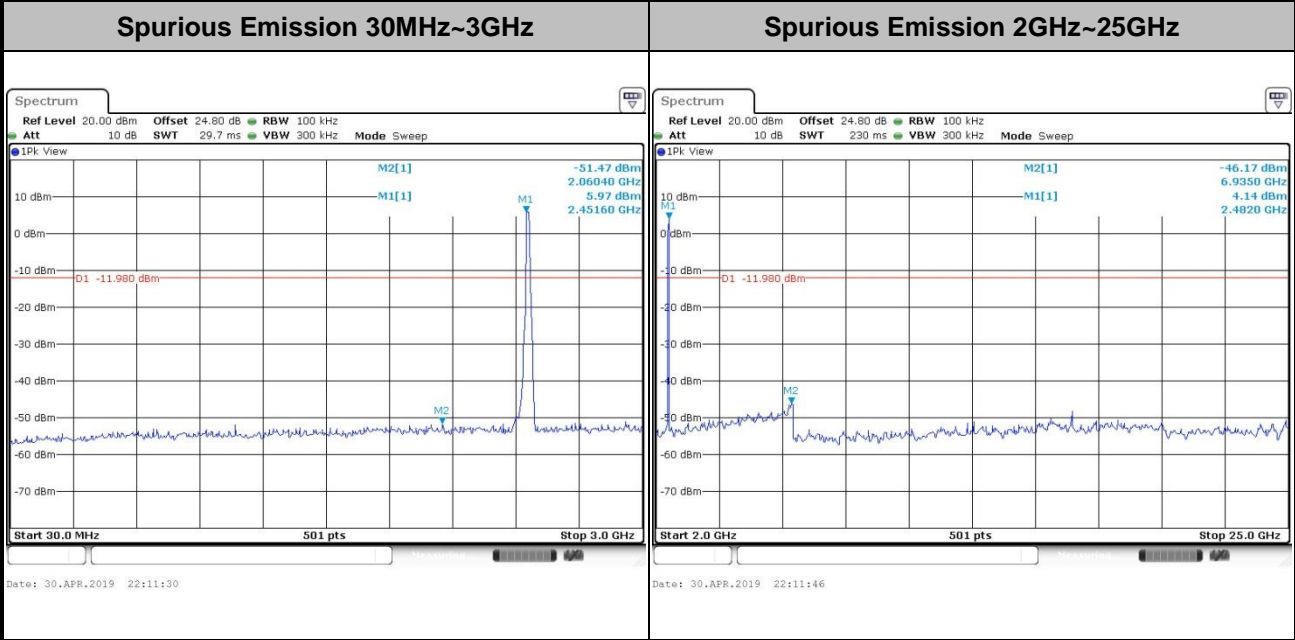
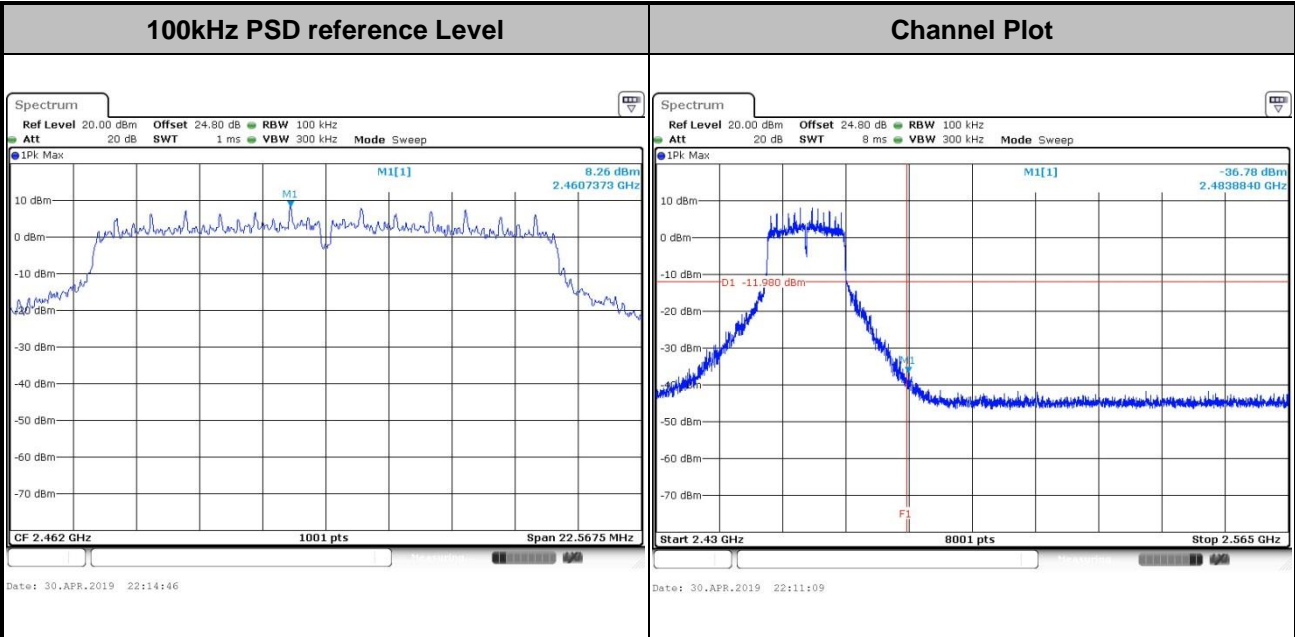



Test Mode : 802.11n HT20 Test Channel : 01

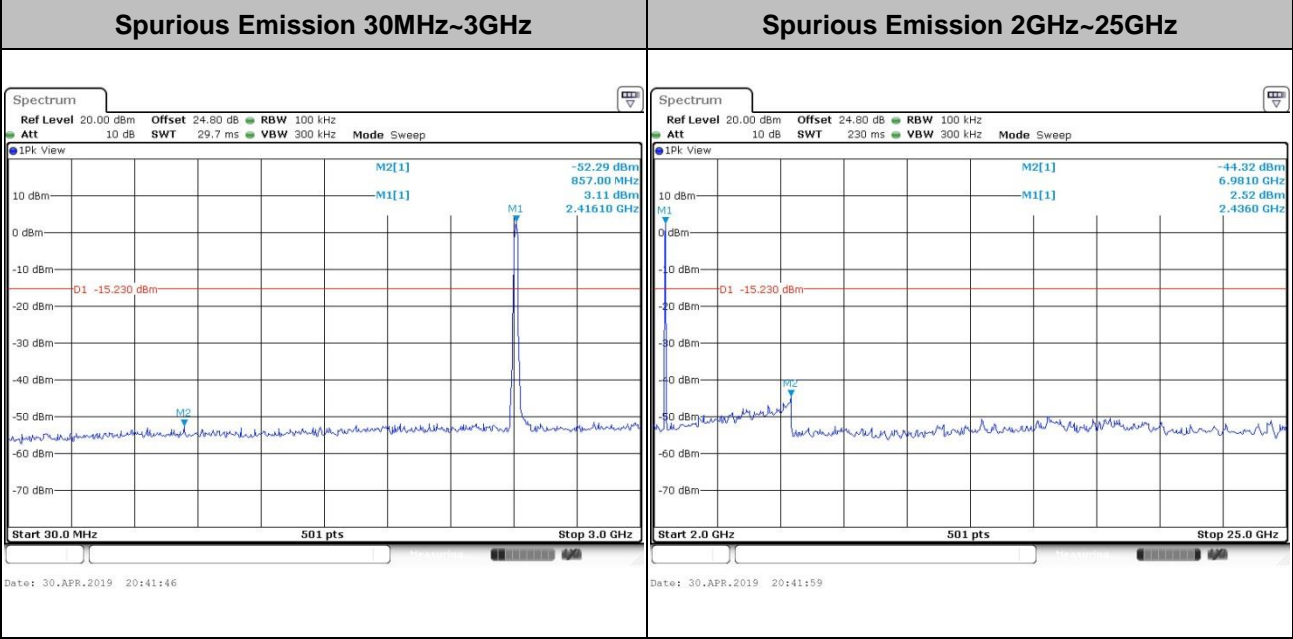
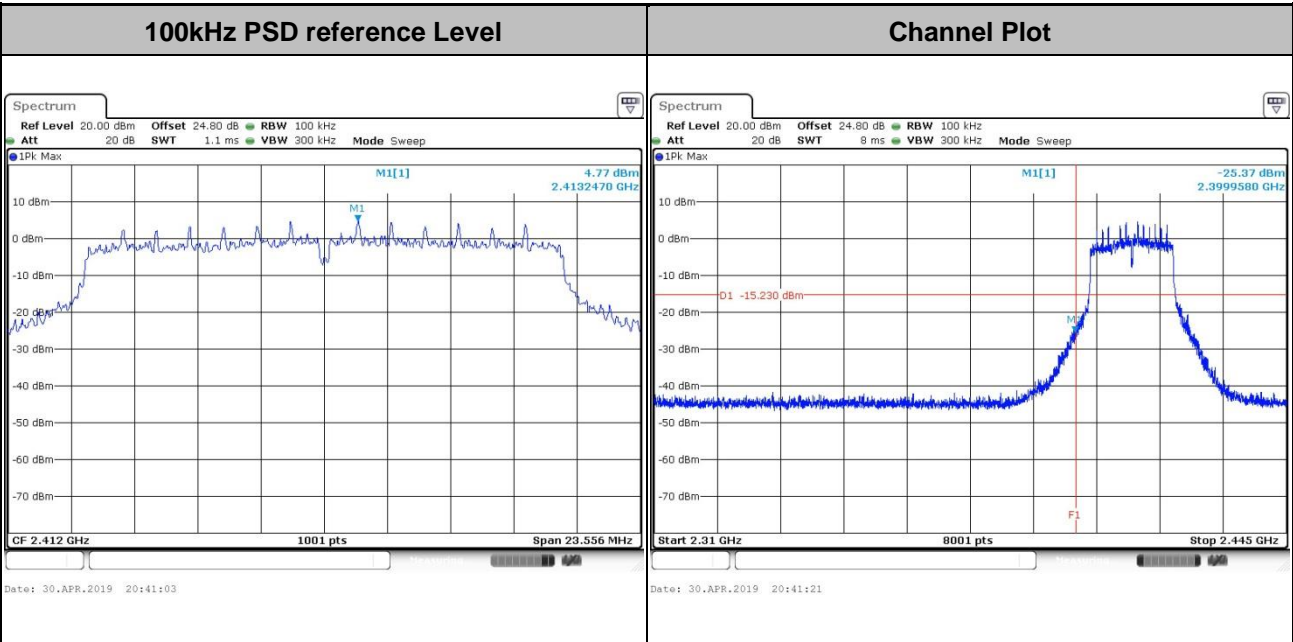



Test Mode : 802.11n HT20 Test Channel : 02

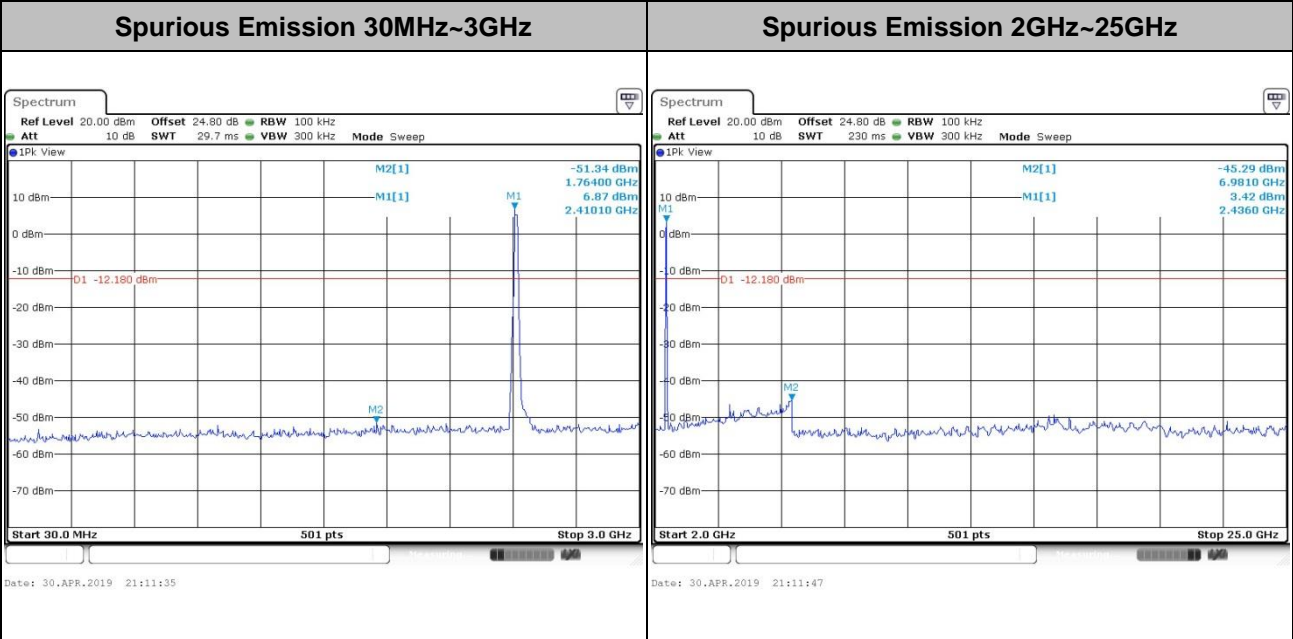
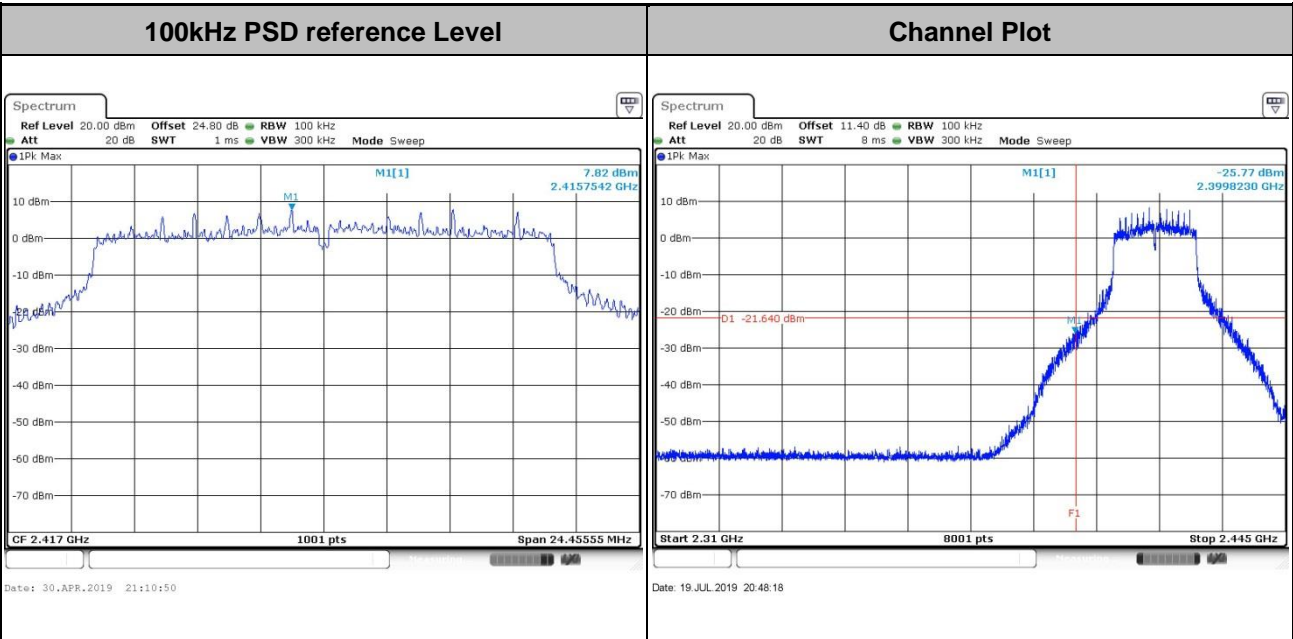



Test Mode :	802.11n HT20	Test Channel :	06
-------------	--------------	----------------	----

100kHz PSD reference Level	Channel Plot
----------------------------	--------------

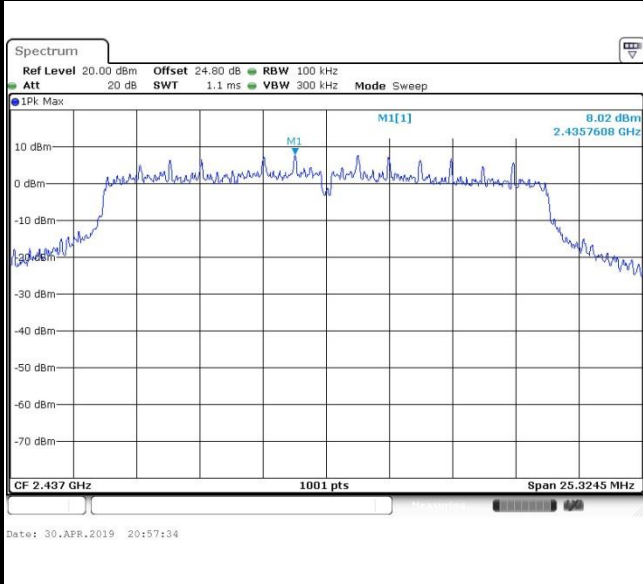

Spurious Emission 30MHz~3GHz	Spurious Emission 2GHz~25GHz
------------------------------	------------------------------

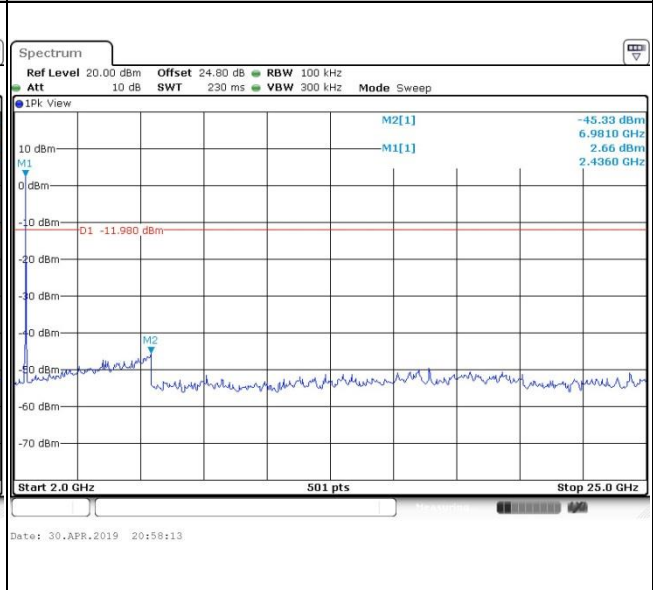
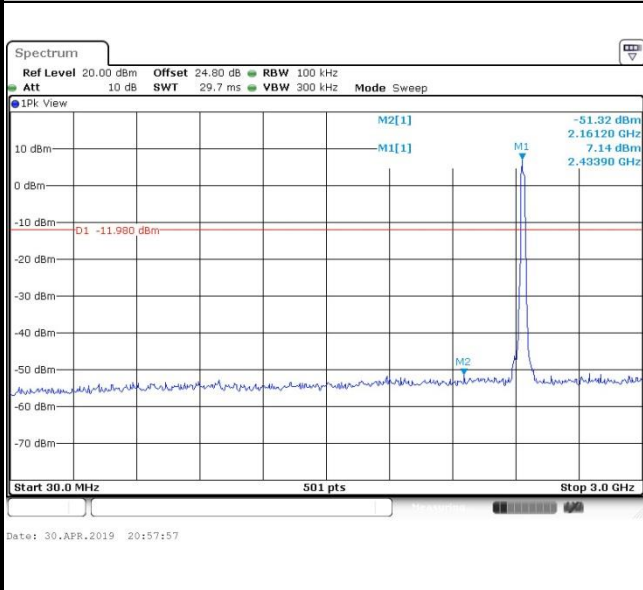



Test Mode : 802.11n HT20 Test Channel : 11

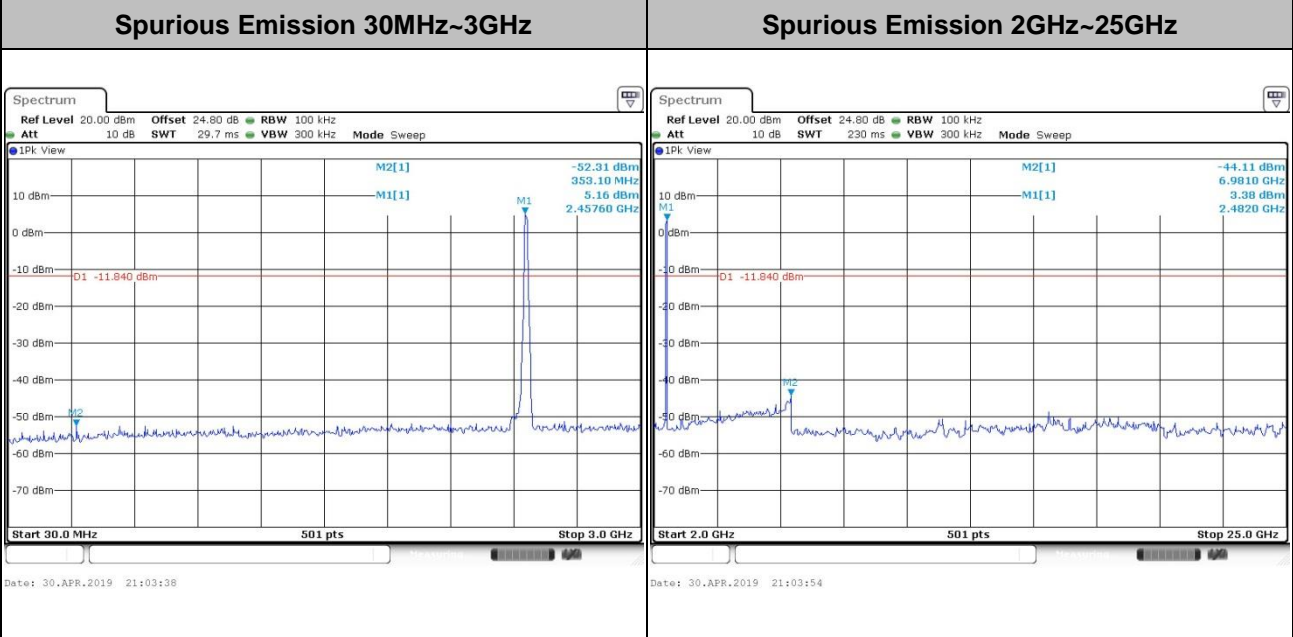
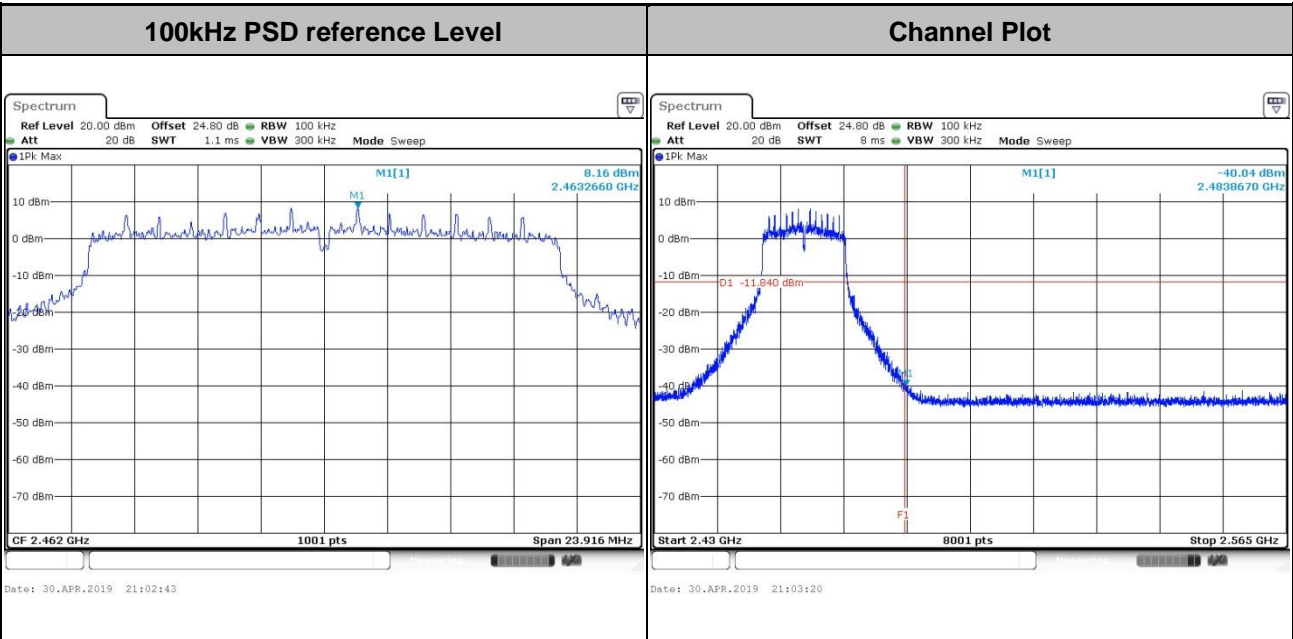



3.5 Radiated Band Edges and Spurious Emission Measurement

3.5.1 Limit of Radiated band edge and Spurious Emission Measurement

In any 100 kHz bandwidth outside the intentional radiator frequency band, all harmonics/spurious must be at least 20 dB below the highest emission level within the authorized band. If the output power of this device was measured by spectrum analyzer, the attenuation under this paragraph shall be 30 dB instead of 20 dB. In addition, radiated emissions which fall in the restricted bands must also comply with the limits as below.

Frequency (MHz)	Field Strength (microvolts/meter)	Measurement Distance (meters)
0.009 – 0.490	2400/F(kHz)	300
0.490 – 1.705	24000/F(kHz)	30
1.705 – 30.0	30	30
30 – 88	100	3
88 – 216	150	3
216 - 960	200	3
Above 960	500	3

3.5.2 Measuring Instruments

See list of measuring equipment of this test report.



3.5.3 Test Procedures

1. The testing follows the ANSI C63.10 Section 11.12.1 Radiated emission measurements.
2. The EUT was arranged to its worst case and then tune the antenna tower (from 1 m to 4 m) and turntable (from 0 degree to 360 degrees) to find the maximum reading. A pre-amp and a high pass filter are used for the test in order to get better signal level.
3. The EUT was placed on a turntable with 0.8 meter for frequency below 1GHz and 1.5 meter for frequency above 1GHz respectively above ground.
4. The EUT was set 3 meters from the interference receiving antenna, which was mounted on the top of a variable height antenna tower.
5. Corrected Reading: Antenna Factor + Cable Loss + Read Level - Preamp Factor = Level
6. For testing below 1GHz, if the emission level of the EUT in peak mode was 3 dB lower than the limit specified, then peak values of EUT will be reported, otherwise, the emissions will be repeated one by one using the CISPR quasi-peak method and reported.
7. For testing above 1GHz, the emission level of the EUT in peak mode was 20dB lower than average limit (that means the emission level in average mode also complies with the limit in average mode), then peak values of EUT will be reported, otherwise, the emissions will be measured in average mode again and reported.
8. Use the following spectrum analyzer settings:
 - (1) Span shall wide enough to fully capture the emission being measured;
 - (2) Set RBW=100 kHz for $f < 1$ GHz; $VBW \geq RBW$; Sweep = auto; Detector function = peak; Trace = max hold;
 - (3) Set RBW = 1 MHz, VBW= 3MHz for $f \geq 1$ GHz for peak measurement.
For average measurement:
 - $VBW = 10$ Hz, when duty cycle is no less than 98 percent.
 - $VBW \geq 1/T$, when duty cycle is less than 98 percent where T is the minimum transmission duration over which the transmitter is on and is transmitting at its maximum power control level for the tested mode of operation.

3.5.4 Test Setup

For radiated emissions below 30MHz

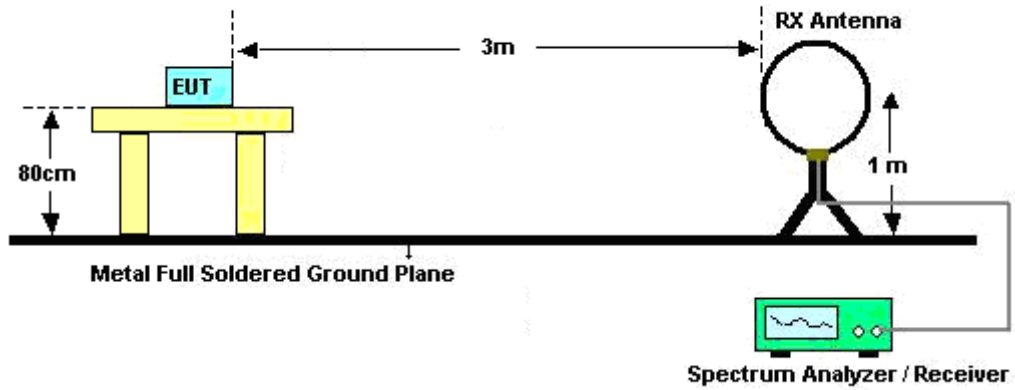

For radiated emissions from 30MHz to 1GHz

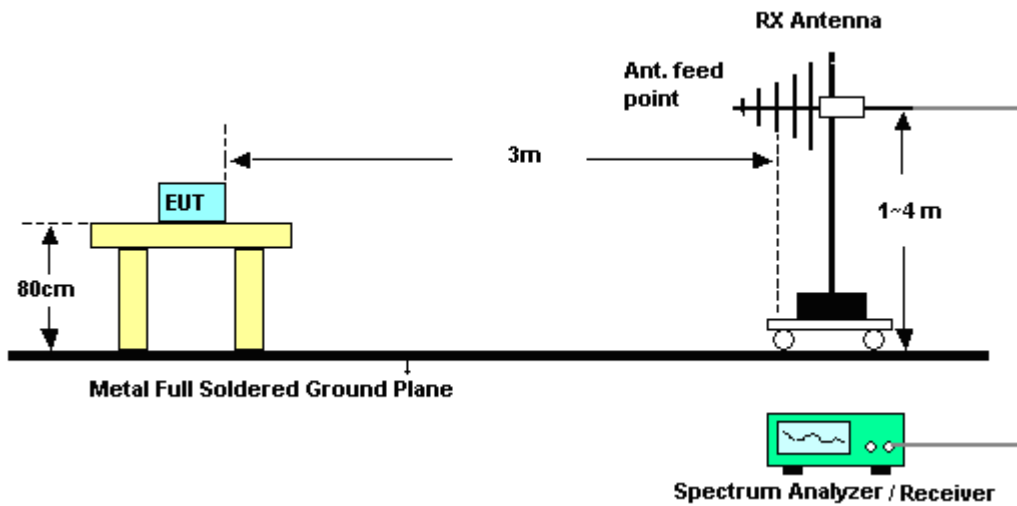

For radiated emissions above 1GHz

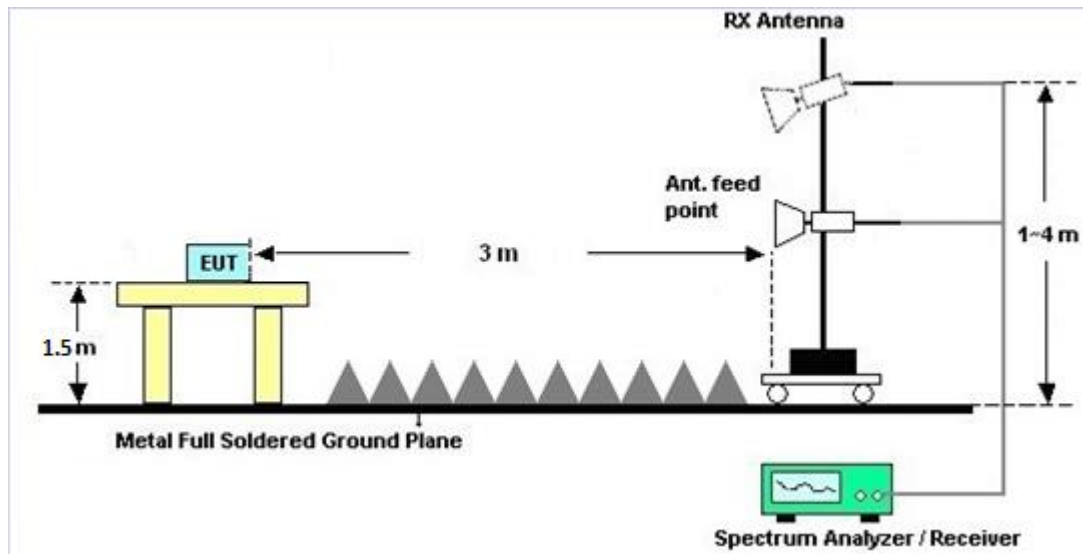

3.5.5 Test Results of Radiated Spurious Emissions (9kHz ~ 30MHz)

The low frequency, which started from 9 kHz to 30MHz, was pre-scanned and the result which was 20dB lower than the limit line was not reported.

There is a comparison data of both open-field test site and alternative test site - semi-Anechoic chamber according to 414788 D01 Radiated Test Site v01r01, and the result came out very similar.

3.5.6 Test Result of Radiated Spurious at Band Edges

Please refer to Appendix C and D.

3.5.7 Duty Cycle

Please refer to Appendix E.

3.5.8 Test Result of Radiated Spurious Emission (30MHz ~ 10th Harmonic)

Please refer to Appendix C and D.



3.6 AC Conducted Emission Measurement

3.6.1 Limit of AC Conducted Emission

For equipment that is designed to be connected to the public utility (AC) power line, the radio frequency voltage that is conducted back onto the AC power line on any frequency or frequencies within the band 150 kHz to 30 MHz shall not exceed the limits in the following table.

Frequency of Emission (MHz)	Conducted Limit (dB μ V)	
	Quasi-Peak	Average
0.15-0.5	66 to 56*	56 to 46*
0.5-5	56	46
5-30	60	50

*Decreases with the logarithm of the frequency.

3.6.2 Measuring Instruments

See list of measuring equipment of this test report.

3.6.3 Test Procedures

1. The EUT was placed 0.4 meter from the conducting wall of the shielding room, and it was kept at least 80 centimeters from any other grounded conducting surface.
2. Connect EUT to the power mains through a line impedance stabilization network (LISN).
3. All the support units are connecting to the other LISN.
4. The LISN provides 50 ohm coupling impedance for the measuring instrument.
5. The FCC states that a 50 ohm, 50 microhenry LISN should be used.
6. Both sides of AC line were checked for maximum conducted interference.
7. The frequency range from 150 kHz to 30 MHz was searched.
8. Set the test-receiver system to Peak Detect Function and specified bandwidth (IF bandwidth = 9kHz) with Maximum Hold Mode.

3.6.4 Test Setup

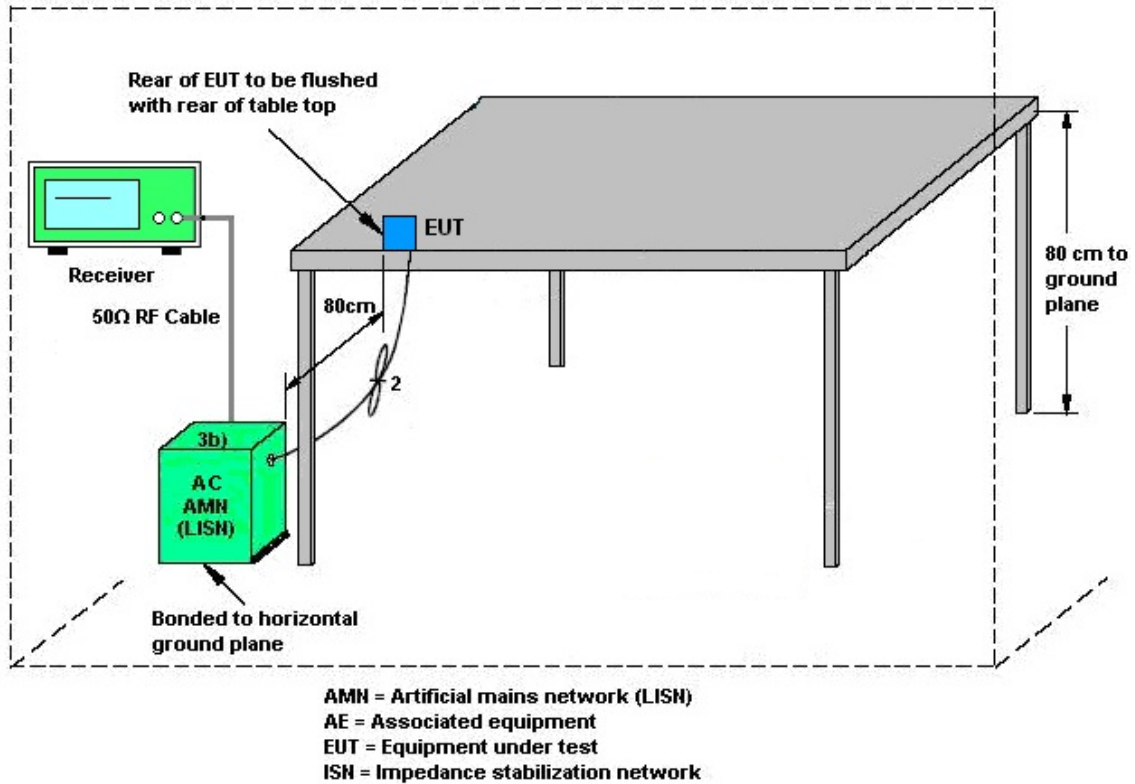

3.6.5 Test Result of AC Conducted Emission

Please refer to Appendix B.



3.7 Antenna Requirements

3.7.1 Standard Applicable

If directional gain of transmitting Antennas is greater than 6dBi, the power shall be reduced by the same level in dB comparing to gain minus 6dBi. The use of a permanently attached Antenna or of an Antenna that uses a unique coupling to the intentional radiator shall be considered sufficient to comply with the rule.

3.7.2 Antenna Anti-Replacement Construction

An embedded-in antenna design is used.

3.7.3 Antenna Gain

<CDD Modes >

FCC KDB 662911 D01 Multiple Transmitter Output **v02r01**

For CDD transmissions, directional gain is calculated as

Directional gain = G_{ANT} + Array Gain, where Array Gain is as follows.

For power spectral density (PSD) measurements on all devices,

Array Gain = $10 \log(N_{ANT}/N_{SS}=1)$ dB.

For power measurements on IEEE 802.11 devices,

Array Gain = 0 dB (i.e., no array gain) for $N_{ANT} \leq 4$.

Directional gain may be calculated by using the formulas applicable to equal gain antennas with G_{ANT} set equal to the gain of the antenna having the highest gain;

The EUT supports CDD mode.

For power, the directional gain G_{ANT} is set equal to the antenna having the highest gain, i.e., F)2)f)i).

For PSD, the directional gain calculation is following F)2)f)ii) of KDB 662911 D01 **v02r01**.

The power and PSD limit should be modified if the directional gain of EUT is over 6 dBi,

The directional gain "DG" is calculated as following table.

<CDD Modes>						
			DG for Power (dBi)	DG for PSD (dBi)	Power Limit Reduction (dB)	PSD Limit Reduction (dB)
	Ant. 1 (dBi)	Ant. 2 (dBi)				
2.4 GHz	1.36	0.10	1.36	3.76	0.00	0.00

$Power\ Limit\ Reduction = DG(Power) - 6dBi, (min = 0)$

$PSD\ Limit\ Reduction = DG(PSD) - 6dBi, (min = 0)$



4 List of Measuring Equipment

Instrument	Manufacturer	Model No.	Serial No.	Characteristics	Calibration Date	Test Date	Due Date	Remark
Amplifier	MITEQ	TTA1840-35-HG	1871923	18GHz~40GHz, VSWR : 2.5:1 max	Jul. 16, 2018	Apr. 08, 2019~ Apr. 25, 2019	Jul. 15, 2019	Radiation (03CH11-HY)
Amplifier	SONOMA	310N	187312	9kHz~1GHz	Dec. 04, 2018	Apr. 08, 2019~ Apr. 25, 2019	Dec. 03, 2019	Radiation (03CH11-HY)
Bilog Antenna	TESEQ	CBL 6111D&N-6-0 6	35414&AT- N0602	30MHz~1GHz	Oct. 13, 2018	Apr. 08, 2019~ Apr. 25, 2019	Oct. 12, 2019	Radiation (03CH11-HY)
Horn Antenna	SCHWARZBE CK	BBHA 9120 D	9120D-132 6	1GHz ~ 18GHz	Oct. 30, 2018	Apr. 08, 2019~ Apr. 25, 2019	Oct. 29, 2019	Radiation (03CH11-HY)
Loop Antenna	Rohde & Schwarz	HFH2-Z2	100488	9 kHz~30 MHz	Jan. 07, 2019	Apr. 08, 2019~ Apr. 25, 2019	Jan. 06, 2020	Radiation (03CH11-HY)
Preamplifier	Keysight	83017A	MY532700 80	1GHz~26.5GHz	Nov. 14, 2018	Apr. 08, 2019~ Apr. 25, 2019	Nov. 13, 2020	Radiation (03CH11-HY)
Spectrum Analyzer	Keysight	N9010A	MY542004 86	10Hz ~ 44GHz	Oct. 19, 2018	Apr. 08, 2019~ Apr. 25, 2019	Oct. 18, 2019	Radiation (03CH11-HY)
Antenna Mast	EMEC	AM-BS-4500- B	N/A	1~4m	N/A	Apr. 08, 2019~ Apr. 25, 2019	N/A	Radiation (03CH11-HY)
Turn Table	EMEC	TT 2000	N/A	0~360 Degree	N/A	Apr. 08, 2019~ Apr. 25, 2019	N/A	Radiation (03CH11-HY)
Preamplifier	Jet-Power	JPA0118-55-3 03	171000180 0054001	1GHz~18GHz	Apr. 16, 2018	Apr. 08, 2019~ Apr. 13, 2019	Apr. 15, 2019	Radiation (03CH11-HY)
Preamplifier	Jet-Power	JPA0118-55-3 03	171000180 0055007	1GHz~18GHz	Apr. 01, 2019	Apr. 22, 2019~ Apr. 25, 2019	Mar. 31, 2020	Radiation (03CH11-HY)
SHF-EHF Horn Antenna	SCHWARZBE CK	BBHA 9170	BBHA9170 584	18GHz- 40GHz	Dec. 05, 2018	Apr. 08, 2019~ Apr. 25, 2019	Dec. 04, 2019	Radiation (03CH11-HY)
EMI Test Receiver	Keysight	N9038A(MXE)	MY554201 70	N/A	Mar. 08, 2019	Apr. 08, 2019~ Apr. 25, 2019	Mar. 07, 2020	Radiation (03CH11-HY)
Software	Audix	E3 6.2009-8-24	RK-00104 2	N/A	N/A	Apr. 08, 2019~ Apr. 25, 2019	N/A	Radiation (03CH11-HY)
RF Cable	HUBER + SUHNER	SUCOFLEX 104	MY9837/4 PE	9kHz-30MHz	Mar. 13, 2019	Apr. 08, 2019~ Apr. 25, 2019	Mar. 12, 2020	Radiation (03CH11-HY)
RF Cable	HUBER + SUHNER	SUCOFLEX 102	MY2859/2	30MHz-40GHz	Mar. 13, 2019	Apr. 08, 2019~ Apr. 25, 2019	Mar. 12, 2020	Radiation (03CH11-HY)
RF Cable	HUBER + SUHNER	SUCOFLEX 104	MY9837/4 PE	30M-18G	Mar. 13, 2019	Apr. 08, 2019~ Apr. 25, 2019	Mar. 12, 2020	Radiation (03CH11-HY)
RF Cable	HUBER + SUHNER	SUCOFLEX 102	MY4274/2	30MHz-40GHz	Mar. 13, 2019	Apr. 08, 2019~ Apr. 25, 2019	Mar. 12, 2020	Radiation (03CH11-HY)
Filter	Wainwright	WLK4-1000-1 530-8000-40S S	SN11	1G Low Pass	Sep. 16, 2018	Apr. 08, 2019~ Apr. 25, 2019	Sep. 17, 2019	Radiation (03CH11-HY)
Filter	Wainwright	WHKX12-270 0-3000-18000 -60SS	SN3	2.7G High Pass	Sep. 16, 2018	Apr. 08, 2019~ Apr. 25, 2019	Sep. 17, 2019	Radiation (03CH11-HY)



Instrument	Manufacturer	Model No.	Serial No.	Characteristics	Calibration Date	Test Date	Due Date	Remark
Hygrometer	Testo	DTM-303A	TP157075	N/A	Nov. 05, 2018	Apr. 13, 2019 ~ Jul. 19, 2019	Nov. 04, 2019	Conducted (TH05-HY)
Power Sensor	Anritsu	MA2411B	1126017	300MHz~40GHz	Aug. 16, 2018	Apr. 13, 2019 ~ Jul. 19, 2019	Aug. 15, 2019	Conducted (TH05-HY)
Power Meter	Anritsu	ML2495A	1132003	N/A	Aug. 16, 2018	Apr. 13, 2019 ~ Jul. 19, 2019	Aug. 15, 2019	Conducted (TH05-HY)
Power Sensor	DARE	RPR3006W	13I00030S NO32	9kHz~6GHz	Dec. 03, 2018	Apr. 13, 2019 ~ Jul. 19, 2019	Dec. 02, 2019	Conducted (TH05-HY)
Signal Analyzer	Rohde & Schwarz	FSV40	101397	10Hz~40GHz	Nov. 13, 2018	Apr. 13, 2019 ~ Jul. 19, 2019	Nov. 12, 2019	Conducted (TH05-HY)
Switch Box & RF Cable	Burgeon	ETF-058	EC120838 2	N/A	Mar. 27, 2019	Apr. 13, 2019 ~ Jul. 19, 2019	Mar. 26, 2020	Conducted (TH05-HY)
AC Power Source	ChainTek	APC-1000W	N/A	N/A	N/A	May 21, 2019	N/A	Conduction (CO05-HY)
EMI Test Receiver	Rohde & Schwarz	ESR3	102388	9KHz~3.6GHz	Nov. 12, 2018	May 21, 2019	Nov. 11, 2019	Conduction (CO05-HY)
Hygrometer	Testo	608-H1	34913912	N/A	Mar. 19, 2019	May 21, 2019	Mar. 18, 2020	Conduction (CO05-HY)
LISN	Rohde & Schwarz	ENV216	100080	9kHz~30MHz	Nov. 14, 2018	May 21, 2019	Nov. 13, 2019	Conduction (CO05-HY)
LISN	Rohde & Schwarz	ENV216	100081	9kHz~30MHz	Nov. 09, 2018	May 21, 2019	Nov. 08, 2019	Conduction (CO05-HY)
Software	Rohde & Schwarz	EMC32 V10.30	N/A	N/A	N/A	May 21, 2019	N/A	Conduction (CO05-HY)
LF Cable	HUBER + SUHNER	RG-214/U	LF01	N/A	Dec. 31, 2018	May 21, 2019	Dec. 30, 2019	Conduction (CO05-HY)
Pulse Limiter	Rohde & Schwarz	ESH3-Z2	100851	N/A	Dec. 31, 2018	May 21, 2019	Dec. 30, 2019	Conduction (CO05-HY)



5 Uncertainty of Evaluation

Uncertainty of Conducted Emission Measurement (150kHz ~ 30MHz)

Measuring Uncertainty for a Level of Confidence of 95% ($U = 2Uc(y)$)	2.2 dB
---	--------

Uncertainty of Radiated Emission Measurement (30 MHz ~ 1000 MHz)

Measuring Uncertainty for a Level of Confidence of 95% ($U = 2Uc(y)$)	5.2 dB
---	--------

Uncertainty of Radiated Emission Measurement (1000 MHz ~ 18000 MHz)

Measuring Uncertainty for a Level of Confidence of 95% ($U = 2Uc(y)$)	5.5 dB
---	--------

Uncertainty of Radiated Emission Measurement (18000 MHz ~ 40000 MHz)

Measuring Uncertainty for a Level of Confidence of 95% ($U = 2Uc(y)$)	5.2 dB
---	--------

Appendix A. Test Result of Conducted Test Items

Test Engineer:	Leo Li	Temperature:	21~25	°C
Test Date:	2019/4/13~2019/7/19	Relative Humidity:	51~54	%

TEST RESULTS DATA
6dB and 99% Occupied Bandwidth

2.4GHz Band										
Mod.	Data Rate	N _{TX}	CH.	Freq. (MHz)	99% Occupied BW (MHz)		6dB BW (MHz)		6dB BW Limit (MHz)	Pass/Fail
					Ant 1	Ant 2	Ant 1	Ant 2		
11b	1Mbps	2	1	2412	14.34	13.84	8.07	8.49	0.50	Pass
11b	1Mbps	2	6	2437	13.99	13.79	8.53	8.53	0.50	Pass
11b	1Mbps	2	11	2462	14.24	13.99	9.03	8.07	0.50	Pass
11g	6Mbps	2	1	2412	16.93	16.68	16.26	15.88	0.50	Pass
11g	6Mbps	2	6	2437	16.78	16.78	15.44	15.40	0.50	Pass
11g	6Mbps	2	11	2462	16.98	16.63	15.68	15.05	0.50	Pass
HT20	MCS0	2	1	2412	18.08	17.98	16.78	15.70	0.50	Pass
HT20	MCS0	2	2	2417	18.18	17.98	15.96	16.30	0.50	Pass
HT20	MCS0	2	6	2437	17.93	17.98	15.92	16.88	0.50	Pass
HT20	MCS0	2	11	2462	18.13	17.93	16.78	15.94	0.50	Pass

TEST RESULTS DATA
Peak Output Power

2.4GHz Band																
Mod.	Data Rate	NTx	CH.	Freq. (MHz)	Peak Conducted Power (dBm)			Conducted Power Limit (dBm)		DG (dBi)		EIRP Power (dBm)		EIRP Power Limit (dBm)		Pass /Fail
					Ant 1	Ant 2	SUM	Ant 1	Ant 2	Ant 1	Ant 2	Ant 1	Ant 2	Ant 1	Ant 2	
11b	1Mbps	2	1	2412	21.06	21.28	24.18	30.00		1.36		25.54		36.00		Pass
11b	1Mbps	2	6	2437	21.47	21.12	24.31	30.00		1.36		25.67		36.00		Pass
11b	1Mbps	2	11	2462	21.16	21.23	24.21	30.00		1.36		25.57		36.00		Pass
11g	6Mbps	2	1	2412	20.43	20.50	23.48	30.00		1.36		24.84		36.00		Pass
11g	6Mbps	2	6	2437	22.89	22.43	25.68	30.00		1.36		27.04		36.00		Pass
11g	6Mbps	2	11	2462	22.54	22.64	25.60	30.00		1.36		26.96		36.00		Pass
HT20	MCS0	2	1	2412	19.62	19.61	22.63	30.00		1.36		23.99		36.00		Pass
HT20	MCS0	2	2	2417	22.50	22.41	25.47	30.00		1.36		26.83		36.00		Pass
HT20	MCS0	2	6	2437	22.87	22.42	25.66	30.00		1.36		27.02		36.00		Pass
HT20	MCS0	2	11	2462	22.55	22.40	25.49	30.00		1.36		26.85		36.00		Pass

Note: Measured power (dBm) has offset with cable loss.

TEST RESULTS DATA
Average Output Power

2.4GHz Band									
Mod.	Data Rate	N _{TX}	CH.	Freq. (MHz)	Duty Factor (dB)		Average Conducted Power (dBm)		
					Ant 1	Ant 2	Ant 1	Ant 2	SUM
11b	1Mbps	2	1	2412	0.00	0.00	19.30	18.90	22.11
11b	1Mbps	2	6	2437	0.00	0.00	19.10	18.70	21.91
11b	1Mbps	2	11	2462	0.00	0.00	19.10	18.60	21.87
11g	6Mbps	2	1	2412	0.09	0.07	15.90	16.00	18.96
11g	6Mbps	2	6	2437	0.09	0.07	18.60	18.20	21.41
11g	6Mbps	2	11	2462	0.09	0.07	18.40	18.20	21.31
HT20	MCS0	2	1	2412	0.09	0.09	14.80	14.70	17.76
HT20	MCS0	2	2	2417	0.09	0.09	18.30	18.10	21.21
HT20	MCS0	2	6	2437	0.09	0.09	18.40	18.10	21.26
HT20	MCS0	2	11	2462	0.09	0.09	18.10	17.90	21.01

Note: Measured power (dBm) has offset with cable loss.

TEST RESULTS DATA
Peak Power Spectral Density

2.4GHz Band												
Mod.	Data Rate	NTX	CH.	Freq. (MHz)	Peak PSD (dBm/3kHz)			DG (dBi)		Peak PSD Limit (dBm/3kHz)		Pass/Fail
					Ant 1	Ant 2	Worse + 3.01	Ant 1	Ant 2	Ant 1	Ant 2	
11b	1Mbps	2	1	2412	-3.70	-3.72	-0.69	3.76		8.00		Pass
11b	1Mbps	2	6	2437	-4.50	-4.35	-1.34	3.76		8.00		Pass
11b	1Mbps	2	11	2462	-3.14	-3.96	-0.13	3.76		8.00		Pass
11g	6Mbps	2	1	2412	-11.90	-11.39	-8.38	3.76		8.00		Pass
11g	6Mbps	2	6	2437	-8.37	-8.54	-5.36	3.76		8.00		Pass
11g	6Mbps	2	11	2462	-9.56	-9.00	-5.99	3.76		8.00		Pass
HT20	MCS0	2	1	2412	-12.34	-12.77	-9.33	3.76		8.00		Pass
HT20	Ant1	2	2	2417	-9.08	-8.93	-5.92	3.76		8.00		Pass
HT20	MCS0	2	6	2437	-8.99	-8.99	-5.98	3.76		8.00		Pass
HT20	MCS0	2	11	2462	-8.58	-8.29	-5.28	3.76		8.00		Pass

Measured power density (dBm) has offset with cable loss.



Appendix B. AC Conducted Emission Test Results

Test Engineer :	Eric Jeng	Temperature :	22~25°C
		Relative Humidity :	52~55%
Test Voltage :	120Vac / 60Hz	Phase :	Line

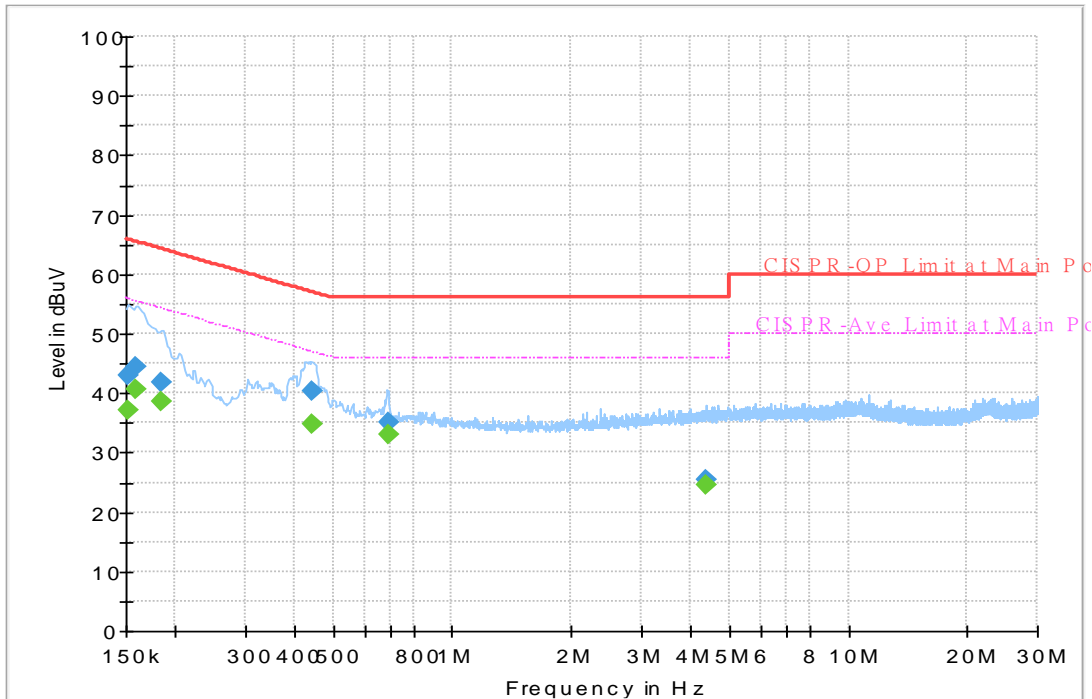

Final Result :

Frequency	QuasiPeak	CAverage	Limit	Margin	Line	Filter	Corr.
0.152250	---	37.06	55.88	18.82	L1	OFF	19.5
0.152250	43.10	---	65.88	22.78	L1	OFF	19.5
0.159000	---	40.65	55.52	14.87	L1	OFF	19.5
0.159000	44.33	---	65.52	21.19	L1	OFF	19.5
0.183750	---	38.46	54.31	15.85	L1	OFF	19.5
0.183750	41.87	---	64.31	22.44	L1	OFF	19.5
0.442500	---	34.88	47.02	12.14	L1	OFF	19.5
0.442500	40.37	---	57.02	16.65	L1	OFF	19.5
0.687750	---	33.08	46.00	12.92	L1	OFF	19.6
0.687750	35.05	---	56.00	20.95	L1	OFF	19.6
4.382250	---	24.57	46.00	21.43	L1	OFF	19.7
4.382250	25.53	---	56.00	30.47	L1	OFF	19.7



Test Engineer :	Eric Jeng	Temperature :	22~25°C
		Relative Humidity :	52~55%
Test Voltage :	120Vac / 60Hz	Phase :	Neutral

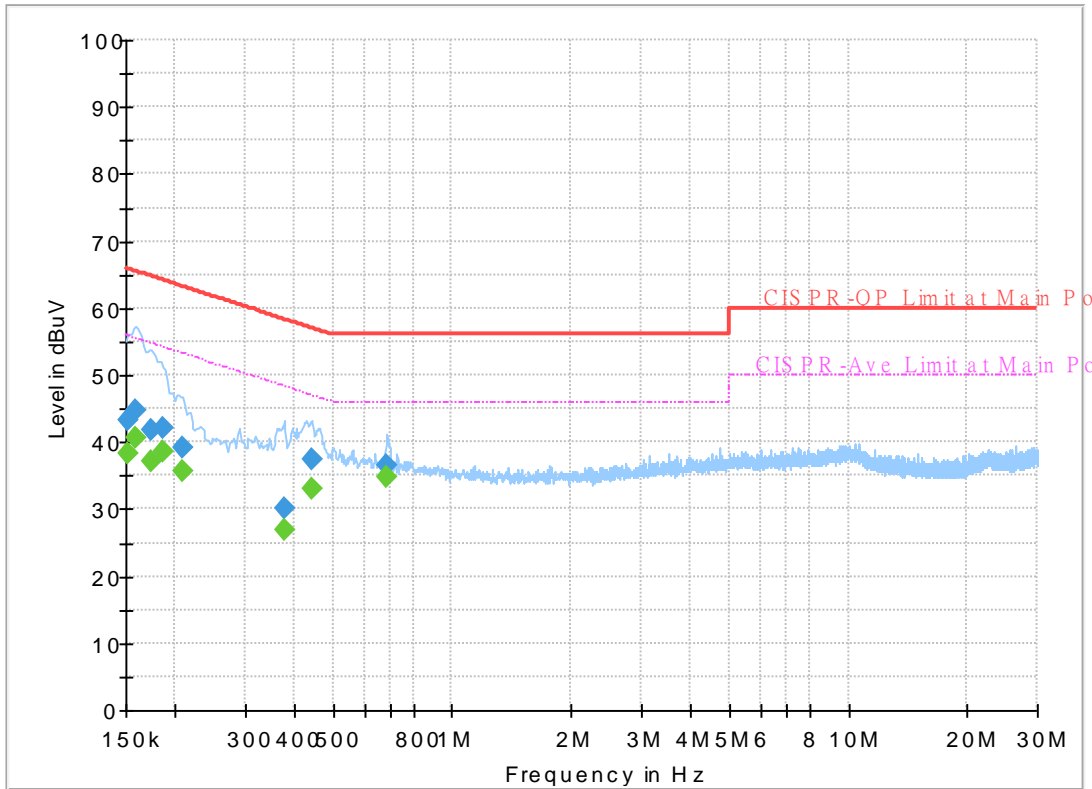

Final Result :

Frequency (MHz)	QuasiPeak (dBuV)	CAverage (dBuV)	Limit (dBuV)	Margin (dB)	Line	Filter	Corr. (dB)
0.152250	---	38.19	55.88	17.69	N	OFF	19.5
0.152250	43.38	---	65.88	22.50	N	OFF	19.5
0.159000	---	40.62	55.52	14.90	N	OFF	19.5
0.159000	44.86	---	65.52	20.66	N	OFF	19.5
0.174750	---	37.05	54.73	17.68	N	OFF	19.5
0.174750	41.82	---	64.73	22.91	N	OFF	19.5
0.186000	---	38.71	54.21	15.50	N	OFF	19.5
0.186000	42.16	---	64.21	22.05	N	OFF	19.5
0.208500	---	35.61	53.27	17.66	N	OFF	19.5
0.208500	39.14	---	63.27	24.13	N	OFF	19.5
0.377250	---	26.87	48.34	21.47	N	OFF	19.5
0.377250	29.99	---	58.34	28.35	N	OFF	19.5
0.442500	---	32.92	47.02	14.10	N	OFF	19.5
0.442500	37.54	---	57.02	19.48	N	OFF	19.5
0.683250	---	34.77	46.00	11.23	N	OFF	19.6
0.683250	36.44	---	56.00	19.56	N	OFF	19.6



Appendix C. Radiated Spurious Emission

Test Engineer :	Hao Xu, Ken Wu, Fu Chen	Temperature :	20~25°C
		Relative Humidity :	50~54%

**2.4GHz 2400~2483.5MHz
WIFI 802.11b (Band Edge @ 3m)**

WIFI Ant. 1+2	Note	Frequency (MHz)	Level (dBμV/m)	Over Limit (dB)	Limit Line (dBμV/m)	Read Level (dBμV)	Antenna Factor (dB/m)	Path Loss (dB)	Preamp Factor (dB)	Ant Pos (cm)	Table Pos (deg)	Peak Avg. (P/A)	Pol. (H/V)
802.11b CH 01 2412MHz		2390	54.84	-19.16	74	44.39	27.44	16.64	33.63	100	238	P	H
		2387.28	45.82	-8.18	54	35.36	27.45	16.64	33.63	100	238	A	H
	*	2412	114	-	-	103.58	27.38	16.66	33.62	100	238	P	H
	*	2412	110.69	-	-	100.27	27.38	16.66	33.62	100	238	A	H
		2389.275	55.19	-18.81	74	44.74	27.44	16.64	33.63	272	273	P	V
		2388.645	44.73	-9.27	54	34.27	27.45	16.64	33.63	272	273	A	V
	*	2412	113.22	-	-	102.8	27.38	16.66	33.62	272	273	P	V
	*	2412	110.01	-	-	99.59	27.38	16.66	33.62	272	273	A	V
802.11b CH 06 2437MHz		2389.04	52.96	-21.04	74	42.51	27.44	16.64	33.63	110	315	P	H
		2389.2	42.8	-11.2	54	32.35	27.44	16.64	33.63	110	315	A	H
	*	2437	114.08	-	-	103.67	27.33	16.69	33.61	110	315	P	H
	*	2437	110.89	-	-	100.48	27.33	16.69	33.61	110	315	A	H
		2484.88	53.37	-20.63	74	42.93	27.3	16.74	33.6	110	315	P	H
		2484.88	42.94	-11.06	54	32.5	27.3	16.74	33.6	110	315	A	H
		2385.68	53.55	-20.45	74	43.09	27.46	16.63	33.63	294	85	P	V
		2389.36	42.3	-11.7	54	31.85	27.44	16.64	33.63	294	85	A	V
	*	2437	110.7	-	-	100.29	27.33	16.69	33.61	294	85	P	V
	*	2437	107.56	-	-	97.15	27.33	16.69	33.61	294	85	A	V
		2498.96	52.58	-21.42	74	42.12	27.3	16.75	33.59	294	85	P	V
		2484.08	42.6	-11.4	54	32.16	27.3	16.74	33.6	294	85	A	V



802.11b CH 11 2462MHz	*	2462	111.32	-	-	100.9	27.3	16.72	33.6	264	266	P	H
	*	2462	108.38	-	-	97.96	27.3	16.72	33.6	264	266	A	H
		2485.36	53.76	-20.24	74	43.32	27.3	16.74	33.6	264	266	P	H
		2486.72	43	-11	54	32.55	27.3	16.74	33.59	264	266	A	H
	*	2462	108.98	-	-	98.56	27.3	16.72	33.6	300	246	P	V
	*	2462	105.9	-	-	95.48	27.3	16.72	33.6	300	246	A	V
		2487.88	52.77	-21.23	74	42.32	27.3	16.74	33.59	300	246	P	V
		2483.52	42.95	-11.05	54	32.51	27.3	16.74	33.6	300	246	A	V
Remark	1. No other spurious found. 2. All results are PASS against Peak and Average limit line.												



**2.4GHz 2400~2483.5MHz
WIFI 802.11b (Harmonic @ 3m)**

WIFI Ant.	Note	Frequency	Level	Over Limit	Limit Line	Read Level	Antenna Factor	Path Loss	Preamplifier Factor	Ant Pos	Table Pos	Peak Avg.	Pol.
1+2		(MHz)	(dBμV/m)	(dB)	(dBμV/m)	(dBμV)	(dB/m)	(dB)	(dB)	(cm)	(deg)	(P/A)	(H/V)
802.11b CH 01 2412MHz		4824	46.73	-27.27	74	63.64	31.1	10.56	58.57	100	0	P	H
		4824	47.65	-26.35	74	64.56	31.1	10.56	58.57	100	0	P	V
802.11b CH 06 2437MHz		4874	47.22	-26.78	74	64.11	31.05	10.61	58.55	100	0	P	H
		7311	44.94	-29.06	74	54.12	36.52	13.13	58.83	100	0	P	H
		4874	47.73	-26.27	74	64.62	31.05	10.61	58.55	100	0	P	V
		7311	43.91	-30.09	74	53.09	36.52	13.13	58.83	100	0	P	V
802.11b CH 11 2462MHz		4924	49.98	-24.02	74	66.72	31.14	10.65	58.53	100	0	P	H
		7386	41.5	-32.5	74	50.71	36.46	13.05	58.72	100	0	P	H
		4924	48.83	-25.17	74	65.57	31.14	10.65	58.53	100	0	P	V
		7386	41.72	-32.28	74	50.93	36.46	13.05	58.72	100	0	P	V
Remark	1. No other spurious found. 2. All results are PASS against Peak and Average limit line.												



**2.4GHz 2400~2483.5MHz
WIFI 802.11g (Band Edge @ 3m)**

WIFI Ant.	Note	Frequency	Level	Over Limit	Limit Line	Read Level	Antenna Factor	Path Loss	Preamp Factor	Ant Pos	Table Pos	Peak Avg.	Pol.
1+2		(MHz)	(dBμV/m)	(dB)	(dBμV/m)	(dBμV)	(dB/m)	(dB)	(dB)	(cm)	(deg)	(P/A)	(H/V)
802.11g CH 01 2412MHz		2389.8	65.03	-8.97	74	54.58	27.44	16.64	33.63	295	287	P	H
		2390	52.84	-1.16	54	42.39	27.44	16.64	33.63	295	287	A	H
	*	2412	111.82	-	-	101.4	27.38	16.66	33.62	295	287	P	H
	*	2412	103.57	-	-	93.15	27.38	16.66	33.62	295	287	A	H
		2389.59	62.92	-11.08	74	52.47	27.44	16.64	33.63	274	272	P	V
		2390	51.52	-2.48	54	41.07	27.44	16.64	33.63	274	272	A	V
	*	2412	110.33	-	-	99.91	27.38	16.66	33.62	274	272	P	V
	*	2412	102.89	-	-	92.47	27.38	16.66	33.62	274	272	A	V
802.11g CH 06 2437MHz		2390	55.09	-18.91	74	44.64	27.44	16.64	33.63	294	287	P	H
		2390	44.03	-9.97	54	33.58	27.44	16.64	33.63	294	287	A	H
	*	2437	114.83	-	-	104.42	27.33	16.69	33.61	294	287	P	H
	*	2437	106.66	-	-	96.25	27.33	16.69	33.61	294	287	A	H
		2483.84	55.39	-18.61	74	44.95	27.3	16.74	33.6	294	287	P	H
		2484.48	44.96	-9.04	54	34.52	27.3	16.74	33.6	294	287	A	H
		2386.16	53.87	-20.13	74	43.41	27.46	16.63	33.63	266	273	P	V
		2390	43.38	-10.62	54	32.93	27.44	16.64	33.63	266	273	A	V
	*	2437	114.1	-	-	103.69	27.33	16.69	33.61	266	273	P	V
	*	2437	105.8	-	-	95.39	27.33	16.69	33.61	266	273	A	V
		2486.08	54.8	-19.2	74	44.36	27.3	16.74	33.6	266	273	P	V
		2484.56	43.01	-10.99	54	32.57	27.3	16.74	33.6	266	273	A	V



802.11g CH 11 2462MHz	*	2462	114.35	-	-	103.93	27.3	16.72	33.6	291	284	P	H
	*	2462	106.6	-	-	96.18	27.3	16.72	33.6	291	284	A	H
		2483.68	62.59	-11.41	74	52.15	27.3	16.74	33.6	291	284	P	H
		2484.12	52.31	-1.69	54	41.87	27.3	16.74	33.6	291	284	A	H
	*	2462	111.85	-	-	101.43	27.3	16.72	33.6	297	273	P	V
	*	2462	104.46	-	-	94.04	27.3	16.72	33.6	297	273	A	V
		2484.08	60.37	-13.63	74	49.93	27.3	16.74	33.6	297	273	P	V
		2483.52	49.65	-4.35	54	39.21	27.3	16.74	33.6	297	273	A	V
Remark	1. No other spurious found. 2. All results are PASS against Peak and Average limit line.												



**2.4GHz 2400~2483.5MHz
WIFI 802.11g (Harmonic @ 3m)**

WIFI Ant.	Note	Frequency	Level	Over Limit	Limit Line	Read Level	Antenna Factor	Path Loss	Preamplifier Factor	Ant Pos	Table Pos	Peak Avg.	Pol.
1+2		(MHz)	(dBμV/m)	(dB)	(dBμV/m)	(dBμV)	(dB/m)	(dB)	(dB)	(cm)	(deg)	(P/A)	(H/V)
802.11g CH 01 2412MHz		4824	41.01	-32.99	74	57.92	31.1	10.56	58.57	100	0	P	H
		4824	41.69	-32.31	74	58.6	31.1	10.56	58.57	100	0	P	V
802.11g CH 06 2437MHz		4874	44.51	-29.49	74	61.4	31.05	10.61	58.55	100	0	P	H
		7311	43.63	-30.37	74	52.81	36.52	13.13	58.83	100	0	P	H
		4874	43.06	-30.94	74	59.95	31.05	10.61	58.55	100	0	P	V
		7311	42.65	-31.35	74	51.83	36.52	13.13	58.83	100	0	P	V
802.11g CH 11 2462MHz		4924	44.99	-29.01	74	61.73	31.14	10.65	58.53	100	0	P	H
		7386	43	-31	74	52.21	36.46	13.05	58.72	100	0	P	H
		4924	44.29	-29.71	74	61.03	31.14	10.65	58.53	100	0	P	V
		7386	41.41	-32.59	74	50.62	36.46	13.05	58.72	100	0	P	V
Remark	1. No other spurious found. 2. All results are PASS against Peak and Average limit line.												



**2.4GHz 2400~2483.5MHz
WIFI 802.11n HT20 (Band Edge @ 3m)**

WIFI Ant. 1+2	Note	Frequency (MHz)	Level (dBμV/m)	Over Limit (dB)	Limit Line (dBμV/m)	Read Level (dBμV)	Antenna Factor (dB/m)	Path Loss (dB)	Preamp Factor (dB)	Ant Pos (cm)	Table Pos (deg)	Peak Avg. (P/A)	Pol. (H/V)
802.11n HT20 CH 01 2412MHz		2390	63.71	-10.29	74	53.26	27.44	16.64	33.63	295	287	P	H
		2390	52.45	-1.55	54	42	27.44	16.64	33.63	295	287	A	H
	*	2412	110.69	-	-	100.27	27.38	16.66	33.62	295	287	P	H
	*	2412	102.89	-	-	92.47	27.38	16.66	33.62	295	287	A	H
		2390	60.82	-13.18	74	50.37	27.44	16.64	33.63	274	272	P	V
		2390	51.26	-2.74	54	40.81	27.44	16.64	33.63	274	272	A	V
	*	2412	110.45	-	-	100.03	27.38	16.66	33.62	274	272	P	V
	*	2412	102.29	-	-	91.87	27.38	16.66	33.62	274	272	A	V
802.11n HT20 CH 02 2417MHz		2389.66	62.92	-11.08	74	52.47	27.44	16.64	33.63	104	244	P	H
		2389.94	52.21	-1.79	54	41.76	27.44	16.64	33.63	104	244	A	H
	*	2417	114.22	-	-	103.8	27.37	16.67	33.62	104	244	P	H
	*	2417	106.41	-	-	95.99	27.37	16.67	33.62	104	244	A	H
		2389.24	61	-13	74	50.55	27.44	16.64	33.63	100	98	P	V
		2389.94	49.54	-4.46	54	39.09	27.44	16.64	33.63	100	98	A	V
	*	2417	112.26	-	-	101.84	27.37	16.67	33.62	100	98	P	V
	*	2417	103.79	-	-	93.37	27.37	16.67	33.62	100	98	A	V



802.11n HT20 CH 06 2437MHz		2390	54.53	-19.47	74	44.08	27.44	16.64	33.63	294	287	P	H
		2390	44.36	-9.64	54	33.91	27.44	16.64	33.63	294	287	A	H
	*	2437	113.2	-	-	102.79	27.33	16.69	33.61	294	287	P	H
	*	2437	103.91	-	-	93.5	27.33	16.69	33.61	294	287	A	H
		2484.48	56.22	-17.78	74	45.78	27.3	16.74	33.6	294	287	P	H
		2484.24	44.87	-9.13	54	34.43	27.3	16.74	33.6	294	287	A	H
		2390	54.54	-19.46	74	44.09	27.44	16.64	33.63	266	273	P	V
		2390	43.5	-10.5	54	33.05	27.44	16.64	33.63	266	273	A	V
	*	2437	112.75	-	-	102.34	27.33	16.69	33.61	266	273	P	V
	*	2437	103.55	-	-	93.14	27.33	16.69	33.61	266	273	A	V
802.11n HT20 CH 11 2462MHz		2484	54.1	-19.9	74	43.66	27.3	16.74	33.6	266	273	P	V
		2484.72	42.87	-11.13	54	32.43	27.3	16.74	33.6	266	273	A	V
	*	2462	113.02	-	-	102.6	27.3	16.72	33.6	291	284	P	H
	*	2462	105.64	-	-	95.22	27.3	16.72	33.6	291	284	A	H
		2484.16	62.57	-11.43	74	52.13	27.3	16.74	33.6	291	284	P	H
		2483.52	51.19	-2.81	54	40.75	27.3	16.74	33.6	291	284	A	H
	*	2462	110.92	-	-	100.5	27.3	16.72	33.6	297	273	P	V
*	2462	102	-	-	91.58	27.3	16.72	33.6	297	273	A	V	
	2483.68	61.34	-12.66	74	50.9	27.3	16.74	33.6	297	273	P	V	
	2483.52	51	-3	54	40.56	27.3	16.74	33.6	297	273	A	V	
Remark	1. No other spurious found. 2. All results are PASS against Peak and Average limit line.												



**2.4GHz 2400~2483.5MHz
WIFI 802.11n HT20 (Harmonic @ 3m)**

WIFI Ant. 1+2	Note	Frequency (MHz)	Level (dBμV/m)	Over Limit (dB)	Limit Line (dBμV/m)	Read Level (dBμV)	Antenna Factor (dB/m)	Path Loss (dB)	Preamp Factor (dB)	Ant Pos (cm)	Table Pos (deg)	Peak Avg. (P/A)	Pol. (H/V)
802.11n HT20 CH 01 2412MHz		4824	40.56	-33.44	74	57.47	31.1	10.56	58.57	100	0	P	H
		4824	39.12	-34.88	74	56.03	31.1	10.56	58.57	100	0	P	V
802.11n HT20 CH 06 2437MHz		4874	43.49	-30.51	74	60.38	31.05	10.61	58.55	100	0	P	H
		7311	46.8	-27.2	74	55.98	36.52	13.13	58.83	100	0	P	H
		4874	43.36	-30.64	74	60.25	31.05	10.61	58.55	100	0	P	V
		7311	46.24	-27.76	74	55.42	36.52	13.13	58.83	100	0	P	V
802.11n HT20 CH 11 2462MHz		4924	45.5	-28.5	74	62.24	31.14	10.65	58.53	100	0	P	H
		7386	42.58	-31.42	74	51.79	36.46	13.05	58.72	100	0	P	H
		4924	46.49	-27.51	74	63.23	31.14	10.65	58.53	100	0	P	V
		7386	43.24	-30.76	74	52.45	36.46	13.05	58.72	100	0	P	V
Remark	1. No other spurious found. 2. All results are PASS against Peak and Average limit line.												



**Emission below 1GHz
2.4GHz WIFI 802.11g (LF)**

WIFI Ant.	Note	Frequency	Level	Over Limit	Limit Line	Read Level	Antenna Factor	Path Loss	Preamp Factor	Ant Pos	Table Pos	Peak Avg.	Pol.
1+2		(MHz)	(dBμV/m)	(dB)	(dBμV/m)	(dBμV)	(dB/m)	(dB)	(dB)	(cm)	(deg)	(P/A)	(H/V)
2.4GHz 802.11g LF		40.67	22.76	-17.24	40	35.59	18.7	0.84	32.37	-	-	P	H
		192.96	24.05	-19.45	43.5	39.69	14.68	1.93	32.25	-	-	P	H
		222.06	24.16	-21.84	46	39.1	15.24	2.05	32.23	-	-	P	H
		751.68	30.76	-15.24	46	31.11	27.83	3.82	32	-	-	P	H
		871.96	31.78	-14.22	46	29.92	29.24	4.12	31.5	-	-	P	H
		952.47	34.17	-11.83	46	30.04	30.68	4.32	30.87	-	-	P	H
		40.67	34.77	-5.23	40	47.6	18.7	0.84	32.37	100	0	Q	V
		40.67	38.67	-1.33	40	51.5	18.7	0.84	32.37	100	0	P	V
		123.12	23.73	-19.77	43.5	37.17	17.38	1.48	32.3	-	-	P	V
		151.25	23.51	-19.99	43.5	37.31	16.81	1.67	32.28	-	-	P	V
		768.17	30.23	-15.77	46	30.47	27.87	3.85	31.96	-	-	P	V
		865.17	32.25	-13.75	46	30.39	29.28	4.11	31.53	-	-	P	V
		960	34.67	-11.33	46	30.13	31	4.34	30.8	-	-	P	V
Remark	1. No other spurious found. 2. All results are PASS against limit line.												



Note symbol

*	Fundamental Frequency which can be ignored. However, the level of any unwanted emissions shall not exceed the level of the fundamental frequency.
!	Test result is over limit line.
P/A	Peak or Average
H/V	Horizontal or Vertical



A calculation example for radiated spurious emission is shown as below:

WIFI Ant.	Note	Frequency	Level	Over Limit	Limit Line	Read Level	Antenna Factor	Path Loss	Preamp Factor	Ant Pos	Table Pos	Peak Avg.	Pol.
1+2		(MHz)	(dBμV/m)	(dB)	(dBμV/m)	(dBμV)	(dB/m)	(dB)	(dB)	(cm)	(deg)	(P/A)	(H/V)
802.11b CH 01 2412MHz		2390	55.45	-18.55	74	54.51	32.22	4.58	35.86	103	308	P	H
		2390	43.54	-10.46	54	42.6	32.22	4.58	35.86	103	308	A	H

1. Path Loss(dB) = Cable loss(dB) + Filter loss(dB) + Attenuator loss(dB)
2. Level(dBμV/m) =
Antenna Factor(dB/m) + Path Loss(dB) + Read Level(dBμV) - Preamp Factor(dB)
3. Over Limit(dB) = Level(dBμV/m) – Limit Line(dBμV/m)

For Peak Limit @ 2390MHz:

1. Level(dBμV/m)
= Antenna Factor(dB/m) + Path Loss(dB) + Read Level(dBμV) - Preamp Factor(dB)
= 32.22(dB/m) + 4.58(dB) + 54.51(dBμV) – 35.86 (dB)
= 55.45 (dBμV/m)
2. Over Limit(dB)
= Level(dBμV/m) – Limit Line(dBμV/m)
= 55.45(dBμV/m) – 74(dBμV/m)
= -18.55(dB)

For Average Limit @ 2390MHz:

1. Level(dBμV/m)
= Antenna Factor(dB/m) + Path Loss(dB) + Read Level(dBμV) - Preamp Factor(dB)
= 32.22(dB/m) + 4.58(dB) + 42.6(dBμV) – 35.86 (dB)
= 43.54 (dBμV/m)
2. Over Limit(dB)
= Level(dBμV/m) – Limit Line(dBμV/m)
= 43.54(dBμV/m) – 54(dBμV/m)
= -10.46(dB)

Both peak and average measured complies with the limit line, so test result is “PASS”.



Appendix D. Radiated Spurious Emission Plots

Test Engineer :	Hao Xu, Ken Wu, Fu Chen	Temperature :	20~25°C
		Relative Humidity :	50~54%

Note symbol

-L	Low channel location
-R	High channel location



2.4GHz 2400~2483.5MHz
WIFI 802.11b (Band Edge @ 3m)

WIFI	2.4GHz 2400~2483.5MHz Band Edge @ 3m	
ANT	802.11b CH01 2412MHz	
1+2	Horizontal	Fundamental
Peak	<p>Date: 2019-04-09</p> <p>Site : 03CH11-HY Condition : PEAK_BE_74 3m HORN 9120D-HF HORIZONTAL RBW:1000.000KHz VBW:3000.000KHz SWT:Auto Detector : Peak Project : 932216 Setting : 19</p>	<p>Date: 2019-04-09</p> <p>Site : 03CH11-HY Condition : PEAK_74 3m HORN 9120D-HF HORIZONTAL RBW:1000.000KHz VBW:3000.000KHz SWT:Auto Detector : Peak Project : 932216 Setting : 19</p>
Avg.	<p>Date: 2019-04-09</p> <p>Site : 03CH11-HY Condition : AVG_BE_54 3m HORN 9120D-HF HORIZONTAL RBW:1000.000KHz VBW:0.010KHz SWT:Auto Detector : Peak Project : 932216 Setting : 19</p>	<p>Date: 2019-04-09</p> <p>Site : 03CH11-HY Condition : AVG_54 3m HORN 9120D-HF HORIZONTAL RBW:1000.000KHz VBW:0.010KHz SWT:Auto Detector : Peak Project : 932216 Setting : 19</p>

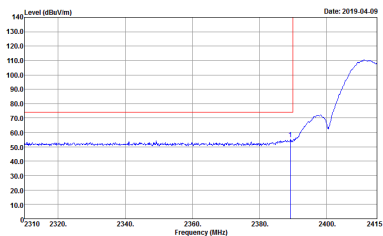
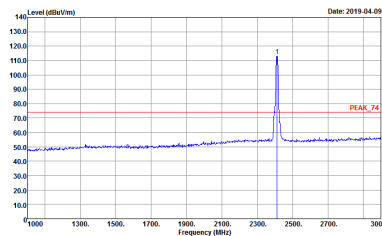
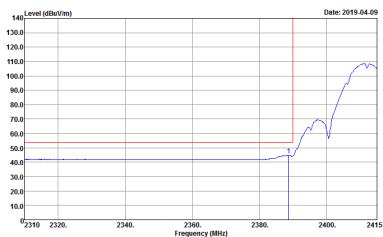
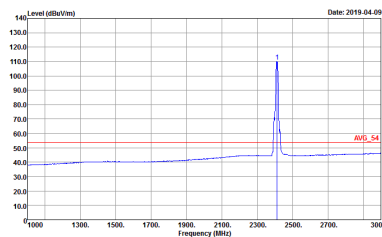

WIFI	2.4GHz 2400~2483.5MHz Band Edge @ 3m	
ANT	802.11b CH01 2412MHz	
1+2	Vertical	Fundamental
<p>Peak</p>	 <p>Site : 03CH11-HY Condition : PEAK_BE_74 3m HORN 91200-HF VERTICAL RBW:1000.000KHz VBW:3000.000KHz SWT:Auto Detector : Peak Project : 932216 Setting : 19</p>	 <p>Site : 03CH11-HY Condition : PEAK_74 3m HORN 91200-HF VERTICAL RBW:1000.000KHz VBW:3000.000KHz SWT:Auto Detector : Peak Project : 932216 Setting : 19</p>
<p>Avg.</p>	 <p>Site : 03CH11-HY Condition : AVG_BE_54 3m HORN 91200-HF VERTICAL RBW:1000.000KHz VBW:0.010KHz SWT:Auto Detector : Peak Project : 932216 Setting : 19</p>	 <p>Site : 03CH11-HY Condition : AVG_54 3m HORN 91200-HF VERTICAL RBW:1000.000KHz VBW:0.010KHz SWT:Auto Detector : Peak Project : 932216 Setting : 19</p>

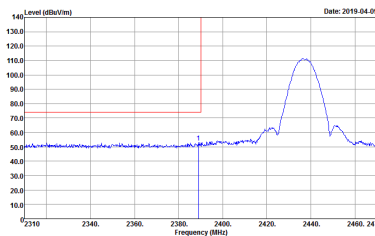
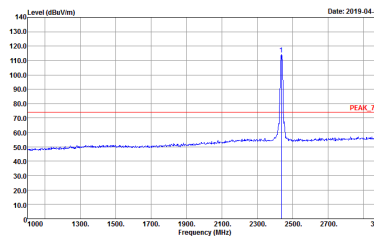
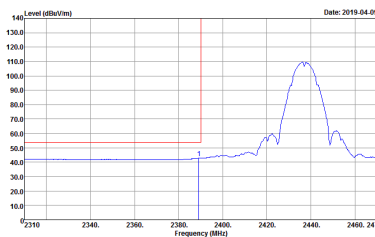
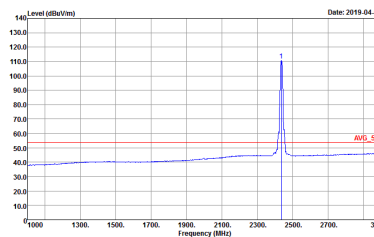

WIFI	2.4GHz 2400~2483.5MHz Band Edge @ 3m	
ANT	802.11b CH06 2437MHz - L	
1+2	Horizontal	Fundamental
<p>Peak</p>	 <p>Date: 2019-04-09</p> <p>Site : 03CH11-HY Condition : PEAK_BE_74 3m HORN 91200-HF HORIZONTAL RBW:1000.000KHz VBW:3000.000KHz SWT:Auto Detector : Peak Project : 932216 Setting : 19</p>	 <p>Date: 2019-04-09</p> <p>Site : 03CH11-HY Condition : PEAK_74 3m HORN 91200-HF HORIZONTAL RBW:1000.000KHz VBW:3000.000KHz SWT:Auto Detector : Peak Project : 932216 Setting : 19</p>
<p>Avg.</p>	 <p>Date: 2019-04-09</p> <p>Site : 03CH11-HY Condition : AVG_BE_54 3m HORN 91200-HF HORIZONTAL RBW:1000.000KHz VBW:0.010KHz SWT:Auto Detector : Peak Project : 932216 Setting : 19</p>	 <p>Date: 2019-04-09</p> <p>Site : 03CH11-HY Condition : AVG_54 3m HORN 91200-HF HORIZONTAL RBW:1000.000KHz VBW:0.010KHz SWT:Auto Detector : Peak Project : 932216 Setting : 19</p>



WIFI	2.4GHz 2400~2483.5MHz Band Edge @ 3m	
ANT	802.11b CH06 2437MHz - R	
1+2	Horizontal	Fundamental
Peak	<p>Site : 03CH11-HY Condition : PEAK_BE_74 3m HORN 91200-HF HORIZONTAL RBW:1000.000KHz VBW:3000.000KHz SWT:Auto Detector : Peak Project : 932216 Setting : 19</p>	Left blank
Avg.	<p>Site : 03CH11-HY Condition : AVG_BE_54 3m HORN 91200-HF HORIZONTAL RBW:1000.000KHz VBW:0.010KHz SWT:Auto Detector : Peak Project : 932216 Setting : 19</p>	Left blank