



FCC Test Report

Report Number : 709502306981-00A Date of Issue: September 26, 2023

Model / Serial No. : RC90C, RC4693702/01BRP, RC469XXXX/XXRP,
RC469XXXX/XXBRP("X"=0-9,"B" means packed with battery)

Product Type : Remote control

Applicant : HCS (Suzhou) Limited

Address : 19F-20F, Building B-3rd, No.209 Zhuyuan Road, New District,
Suzhou, P.R.China

Factory : Himit (Yueyang) Technology Ltd.

Address : Building 4, Lingang High-tech Industrial Park, Yueyang Area,
China (Hunan) Free Trade Pilot Zone

Test Result : Positive Negative

Total pages : 20

Date of Test : September 15, 2023

Prepared by : 

Yong ZHANG

Approved by : 

Jiaxi XU

DISCLAIMER AND COPYRIGHT

This non-binding report has been prepared by TÜV SÜD Certification and Testing (China) Co., Ltd. Shanghai Branch with all reasonable skill and care. The reports apply only to the specific samples tested under stated test conditions. The document is confidential to the potential Client and TÜV SÜD Certification and Testing (China) Co., Ltd. Shanghai Branch. No part of this document may be reproduced without the prior written approval of TÜV SÜD Certification and Testing (China) Co., Ltd. Shanghai Branch.

Report Number: 709502306981-00A

Page 1 of 20

Rev.23.00

TÜV SÜD Certification and Testing (China) Co., Ltd. Shanghai Branch
3-13, No.151, Heng Tong Road, Shanghai, 200070, P.R. China
Phone: +86 21 61410123, Fax: +86 21 61408600



TABLE OF CONTENTS

Description	Page
1. Report Modification Record.....	3
2. Test Facility.....	3
3. EUT Information.....	4
4. Test Summary.....	5
5. Conducted Emission.....	6-7
6. Radiated Emission.....	8-18
7. Measurement Uncertainty.....	19
8. EUT Photograph.....	20



1. Report Modification Record

Alterations and additions to this report will be issued to the holders of each copy in the form of a complete document.

Report No.	Description of Change	Date of Issue
709502306981-00A	First Issue	09/26/2023

2. Test Facility

Test Site 1

Company name: TÜV SÜD Certification and Testing (China) Co., Ltd. Shanghai Branch
No.16 Lane, 1951 Du Hui Road,
Shanghai 201108, P.R. China

Test Firm FCC 820234
Registration Number:

Designation number: CN1183
IC Company Number: 25988

CAB identifier: CN0101
Telephone: +86 21 6141 0123
Fax: +86 21 6140 8600

Ambient Condition in laboratory:

Items	Test	Required(IEC68-1)	Actual
Temperature(°C)	ANSI.C 63.4 CE	15-35	N/A
Humidity (%)		25-75	N/A
Atmospheric Pressure(mbar)		860-1060	N/A
Temperature(°C)	ANSI.C 63.4 RE	15-35	21.3
Humidity (%)		25-75	42.7
Atmospheric Pressure(mbar)		860-1060	1036



3. EUT Information

3.1 EUT Description

Product Type	:	Remote control
Model / Serial No.	:	RC90C, RC4693702/01BRP, RC469XXXX/XXRP, RC469XXXX/XXBRP("X"=0-9,"B" means packed with battery)
EUT Voltage	:	3V DC
FCC ID:	:	2AGOFRC469B

The sample's mentioned in this report is/are submitted/ supplied/ manufactured by client. The laboratory therefore assumes no responsibility for accuracy of information on the brand name, model number, origin of manufacture, consignment or any information supplied.

3.2 EUT Configuration

RC4693702/01BRP	:	3V DC
-----------------	---	-------

3.3 EUT Operating Mode

The equipment under test was operated under the following conditions during emissions testing:

- Standby
- Test Program (H - Pattern)
- Test Program (Color Bar)
- Test Program (Customer Specified)
- Normal Operating Mode
- _____

3.4 Peripheral devices and interface cables were connected during the testing:

- _____ Type : _____

3.5 EUT Exercise Software:

The EUT is not programmable and does not use software.

3.6 EUT Modification

N/A

4. Test Summary

Test according to:

- - CFR Title 47 Part 15 Subpart B
- - ICES-003 Issue 7

Test	Specification	Test Result	Remark
Conducted Emission	CFR47 Part 15 §15.107	NA	NA
Radiated Emission	CFR47 Part 15 §15.109	Pass	Refer to page 8-18

Remarks:

According to the section 15.33 of FCC part 15, the work frequency is above 1GHz (2402MHz and 2480MHz), so the radiated emission range is 30MHz to 12400MHz. (We tested it up to 13000MHz)

Highest frequency generated or used in the device or on which the device operates or tunes (MHz)	Upper frequency of measurement range (MHz)
Below 1.705	30.
1.705-108	1000.
108-500	2000.
500-1000	5000.
Above 1000	5th harmonic of the highest frequency or 40 GHz, whichever is lower.

The EUT was a remote control with BLE module.

All models are identical in electrical structure, mechanical, PCB and RF performance. There are only cosmetic differences (color/painting/printed).

We chose model RC4693702/01BRP to perform test and listed the worst data in this report.

5. Conducted Emission

5.1 Test Equipment

The following test equipments are used:

Used	Instrument	Manufacturer	Type No	TE No	Calibration Date	Calibration Due
<input type="checkbox"/>	EMI test receiver	R & S	ESR3	S1503001-YQ-EMC	2023.8.1	2024.7.31
<input type="checkbox"/>	2-Line V-network	R & S	ENV216	S1503103-YQ-EMC	2023.8.1	2024.7.31
<input type="checkbox"/>	4-Line V-network	R & S	ENV4200	S1503106-YQ-EMC	2023.8.1	2024.7.31

5.2 Test Specification

Tests are performed according to CFR47 Part 15 subpart B.

Limit as below:

CFR47 Part 15 subpart B §15.107 (dB μ V)				
Frequency (MHz)	Class A		Class B	
	QP	AV	QP	AV
0.15-0.5	79	66	66-56	56-46
0.5-5.0	73	60	56	46
5.0-30	73	60	60	50

5.3 Test Procedure

The test is performed in shield room. EUT is placed on the table which is 80cm above ground plane and connected to a line Impedance Stabilization Network (LISN).

The conducted emission is scanned over the frequency from 150KHz to 30MHz with peak detector. A final measurement is performed with quasi-peak detector and average detector. IF bandwidth is 10KHz.

5.4 Test Setup

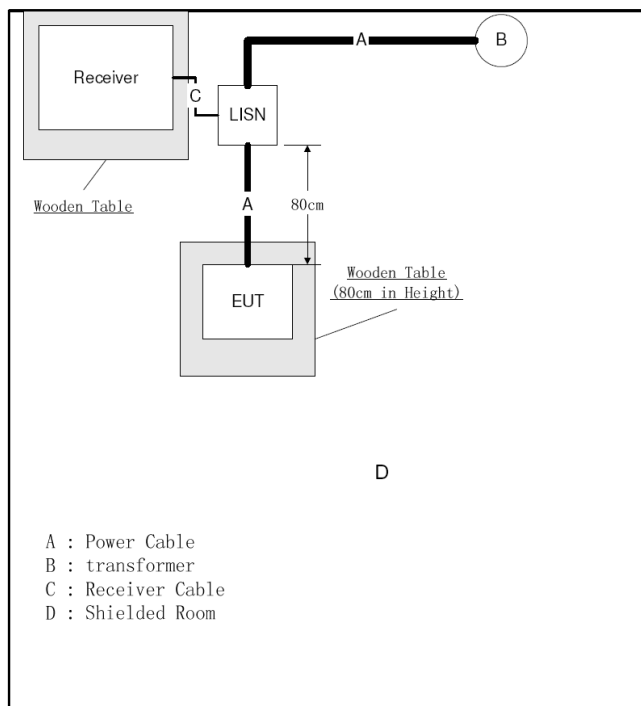

5.5 Test Photo

N/A

5.6 Test Result

N/A

Note 1: Emission Level = Reading level + Correction Factor
Correction Factor = LISN Factor + Cable Loss + Attenuator Factor
Margin=Limit – Emission Level

6 Radiated Emission

6.1 Test Equipment

The following test Equipment are used:

Used	Instrument	Manufacturer	Type No	TE No	Calibration Date	Calibration Due
■	EMI test receiver	R & S	ESR3	S1503109-YQ-EMC	2023.8.1	2024.7.31
■	Trilog super broadband test antenna	SCHWARZBECK	VULB9168	S1808296-YQ-EMC	2021.9.23	2024.9.22
■	3 meter semi-anechoic chamber	TDK	3m	S1503231-YQ-EMC	2021.5.8	2024.5.7
■	Signal conditioning unit	R&S	SCU-18D	S1503012-YQ-EMC	2023.8.1	2024.7.31
■	Double-ridged waveguide horn antenna	R&S	HF907	S1503009-YQ-EMC	2021.4.13	2024.4.12
■	Signal and spectrum analyzer	R&S	FSV40	S1503003-YQ-EMC	2023.8.1	2024.7.31

6.2 Test Specification

Tests are performed according to CFR47 Part 15 subpart B.

Limit as below:

CFR47 Part 15 subpart B §15.109 (dB μ V/m)				
Frequency (MHz)	Class A		Class B	
	Distance	QP	Distance	QP
30-88	10m	39	3m	40
88-216	10m	43.5	3m	43.5
216-960	10m	46.4	3m	46
Above 960	10m	49.5	3m	54

6.3 Test Procedure

The EUT is placed on a turntable which is 80cm above ground plane. The turn table rotates 360 degrees and antenna moves up and down between 1m and 4 m to find maximum emission. Both horizontal and vertical polarizations of antenna are set in the measurement. For class A equipment, the EUT is positioned at 10m away from antenna and for class B equipment, the EUT is positioned at 3m away from antenna.

6.4 Test Setup

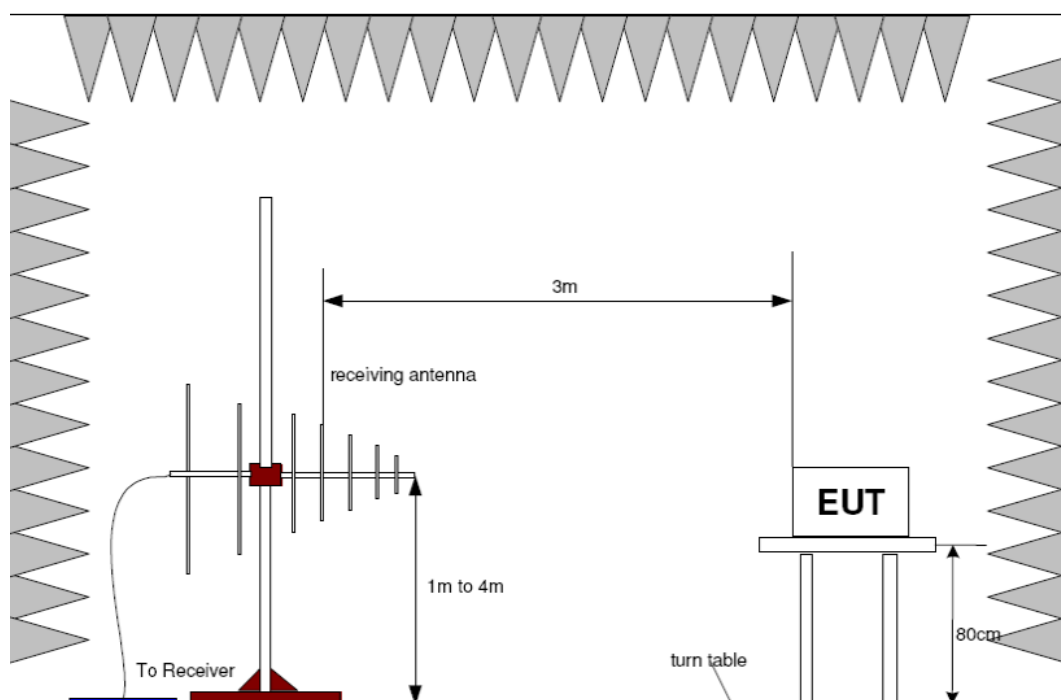

Note: w : The dimension of the line tangent to the EUT formed by $\theta_{-3\text{dB}}$ at the measurement distance 3m

w value	Measurement frequency band	Antenna Model
1.6m	1~18GHz	HF907
1.95m	18~26.5GHz	3116C-PA
0.74m	26.5~40GHz	3116C-PA



6.5 Test Photo

Refer to the < Test Setup photos >

6.6 Test Result

30-1000MHz Radiated Emission Test

EUT Information

EUT Name: Remote control
 Model: RC4693702/01BRP
 Client: HCS (Suzhou) Limited
 Op Cond: Power on, DC 3V, T20.9, H63.4%, P100.1kPa
 Operator: Cheng Huali
 Test Spec: FCC Part 15B Class B
 Comment: Horizontal
 Sample No: SHA-756331-1

Sweep Setup: RE_VULB9168_pre_Cont_30-1000 [EMI radiated]

Hardware Setup: RE_VULB9168
 Receiver: [ESR 3]
 Level Unit: dBuV/m

Subrange	Step Size	Detectors	Bandwidth	Sweep Time	Preamp
30 MHz - 1 GHz	48.5 kHz	PK+	120 kHz	0.2 s	20 dB
RE_VULB9168_pre_Cont_30-1000					

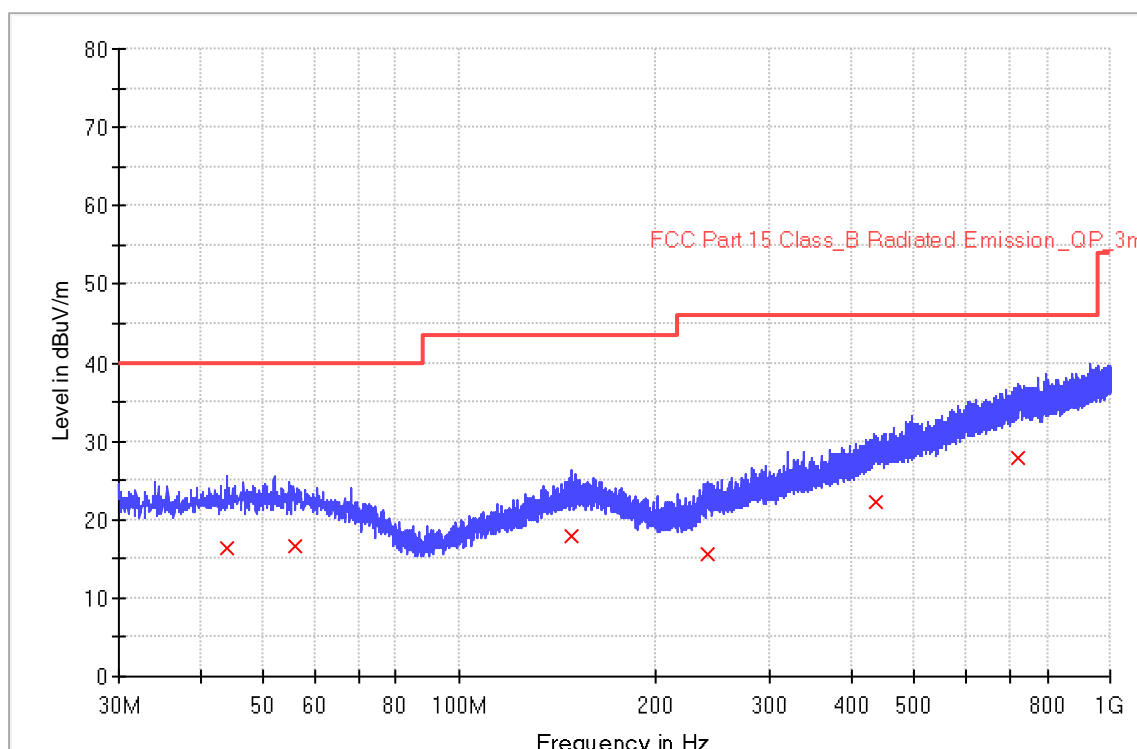



Limit and Margin

Frequency (MHz)	QuasiPeak (dBuV/m)	Meas. Time (ms)	Bandwidth (kHz)	Height (cm)	Pol	Azimuth (deg)	Corr. (dB/m)	Margin - QPK (dB)	Limit - QPK (dBuV/m)
44.000000	16.4	1000.0	120.000	175.0	H	174.0	20.3	23.6	40.0
55.760000	16.5	1000.0	120.000	135.0	H	301.0	20.5	23.5	40.0
148.920000	18.0	1000.0	120.000	106.0	H	95.0	21.0	25.5	43.5
241.160000	15.6	1000.0	120.000	185.0	H	36.0	19.6	30.4	46.0
436.400000	22.3	1000.0	120.000	210.0	H	105.0	25.6	23.7	46.0
723.400000	27.9	1000.0	120.000	116.0	H	226.0	31.2	18.1	46.0

Note 1: Emission Level = Reading level + Correction Factor
Corrector Factor = Antenna Factor + Cable Loss - Pre-amplifier Gain
Margin=Limit – Emission Level



30-1000MHz Radiated Emission Test

EUT Information

EUT Name: Remote control
Model: RC4693702/01BRP
Client: HCS (Suzhou) Limited
Op Cond: Power on, DC 3V, T20.9, H63.4%, P100.1kPa
Operator: Cheng Huali
Test Spec: FCC Part 15B Class B
Comment: Vertical
Sample No: SHA-756331-1

Sweep Setup: RE_VULB9168_pre_Cont_30-1000 [EMI radiated]

Hardware Setup: RE_VULB9168
Receiver: [ESR 3]
Level Unit: dBuV/m

Subrange	Step Size	Detectors	Bandwidth	Sweep Time	Preamp
30 MHz - 1 GHz	48.5 kHz	PK+	120 kHz	0.2 s	20 dB
RE_VULB9168_pre_Cont_30-1000					

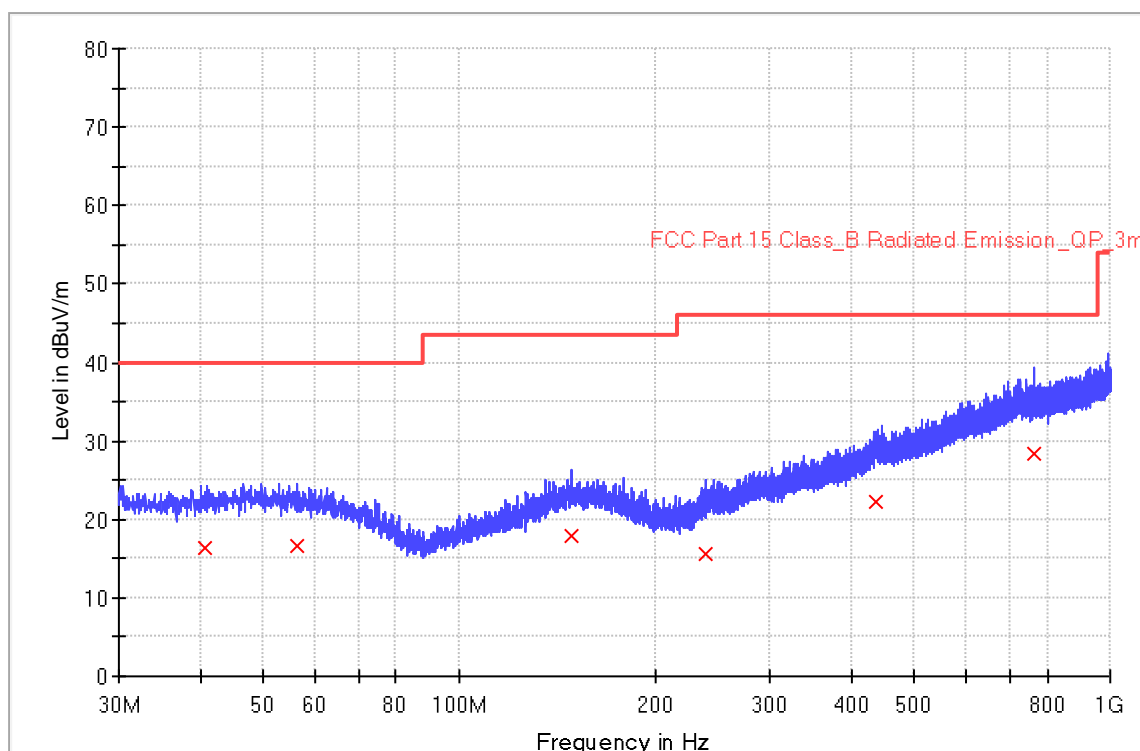



Limit and Margin

Frequency (MHz)	QuasiPeak (dBuV/m)	Meas. Time (ms)	Bandwidth (kHz)	Height (cm)	Pol	Azimuth (deg)	Corr. (dB)	Margin - QPK (dB)	Limit - QPK (dBuV/m)
40.640000	16.4	1000.0	120.000	105.0	V	105.0	20.1	23.6	40.0
56.240000	16.5	1000.0	120.000	100.0	V	169.0	20.4	23.5	40.0
148.680000	18.0	1000.0	120.000	103.0	V	32.0	21.0	25.5	43.5
239.280000	15.7	1000.0	120.000	126.0	V	247.0	19.5	30.3	46.0
435.080000	22.3	1000.0	120.000	115.0	V	87.0	25.5	23.7	46.0
766.480000	28.4	1000.0	120.000	121.0	V	321.0	31.9	17.6	46.0

Note 1: Emission Level = Reading level + Correction Factor
Corrector Factor = Antenna Factor + Cable Loss - Pre-amplifier Gain
Margin=Limit – Emission Level



1-13GHz Radiated Emission Test

EUT Information

EUT Name: Remote control
Model: RC4693702/01BRP
Client: HCS (Suzhou) Limited
Op Cond: Power on, DC 3V, T20.9, H63.4%, P100.1kPa
Operator: Cheng Huali
Test Spec: FCC Part 15B Class B
Comment: Horizontal
Sample No: SHA-756331-1

Sweep Setup: RE_HF907_pre [EMI radiated]

Hardware Setup: RE_HF907
Receiver: [FSV 40]
Level Unit: dBuV/m

Subrange	Step Size	Detectors	Bandwidth	Sweep Time	Preamp
1 GHz - 13 GHz	566.667 kHz	PK+ ; AVG	1 MHz	0.1 s	0 dB
Full Spectrum					

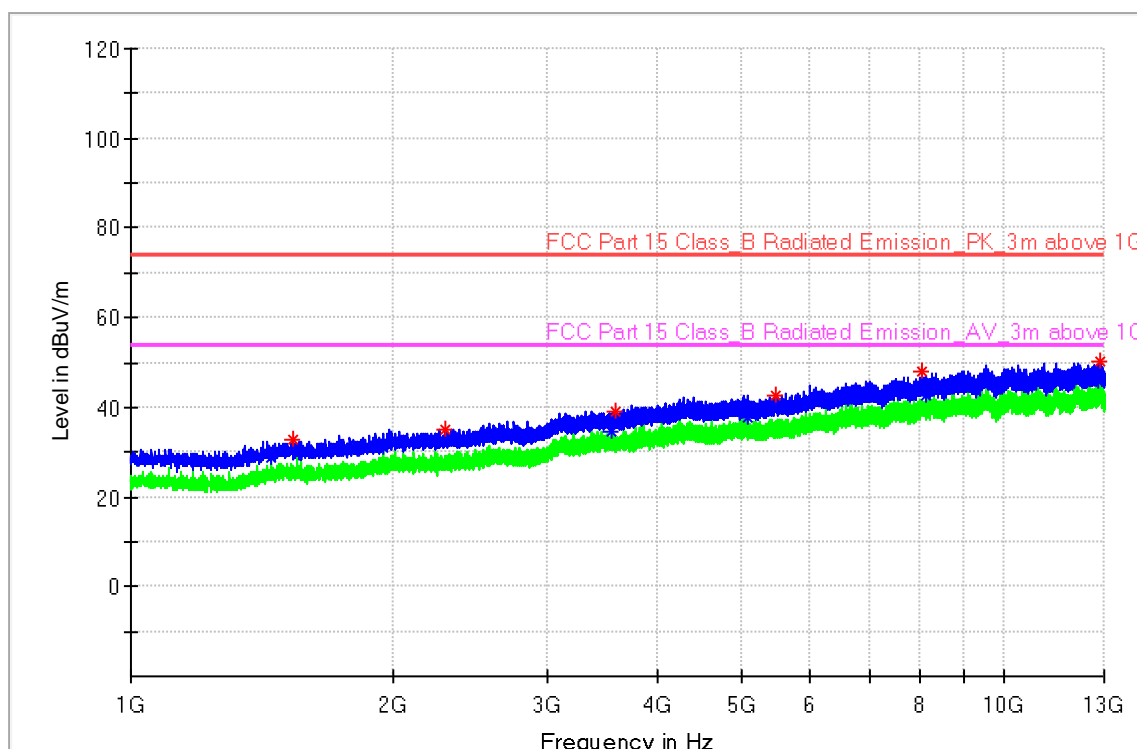

Critical_Freqs

Frequency (MHz)	MaxPeak (dBuV/m)	Average (dBuV/m)	Limit (dBuV/m)	Margin (dB)	Height (cm)	Pol	Azimuth (deg)
1532.000000	32.62	---	74.00	41.38	100.0	H	0.0
5074.000000	---	37.78	54.00	16.22	100.0	H	0.0
5479.600000	42.75	---	74.00	31.25	100.0	H	0.0
8060.000000	48.09	---	74.00	25.91	100.0	H	0.0
12863.200000	50.35	---	74.00	23.65	100.0	H	0.0
3554.400000	---	34.69	54.00	19.31	100.0	H	178.0
1948.400000	---	31.17	54.00	22.83	100.0	H	204.0
3595.200000	39.18	---	74.00	34.82	100.0	H	302.0
2289.200000	35.09	---	74.00	38.91	100.0	H	317.0
12794.000000	---	45.73	54.00	8.27	100.0	H	317.0
1448.400000	---	28.69	54.00	25.31	100.0	H	332.0
8140.400000	---	42.63	54.00	11.37	100.0	H	352.0

Note 1: Emission Level = Reading level + Correction Factor
 Corrector Factor = Antenna Factor + Cable Loss - Pre-amplifier Gain
 Margin=Limit – Emission Level



1-13GHz Radiated Emission Test

EUT Information

EUT Name: Remote control
Model: RC4693702/01BRP
Client: HCS (Suzhou) Limited
Op Cond: Power on, DC 3V, T20.9, H63.4%, P100.1kPa
Operator: Cheng Huali
Test Spec: FCC Part 15B Class B
Comment: Vertical
Sample No: SHA-756331-1

Sweep Setup: RE_HF907_pre [EMI radiated]

Hardware Setup: RE_HF907
Receiver: [FSV 40]
Level Unit: dBuV/m

Subrange	Step Size	Detectors	Bandwidth	Sweep Time	Preamp
1 GHz - 13 GHz	566.667 kHz	PK+ ; AVG	1 MHz	0.1 s	0 dB

Full Spectrum

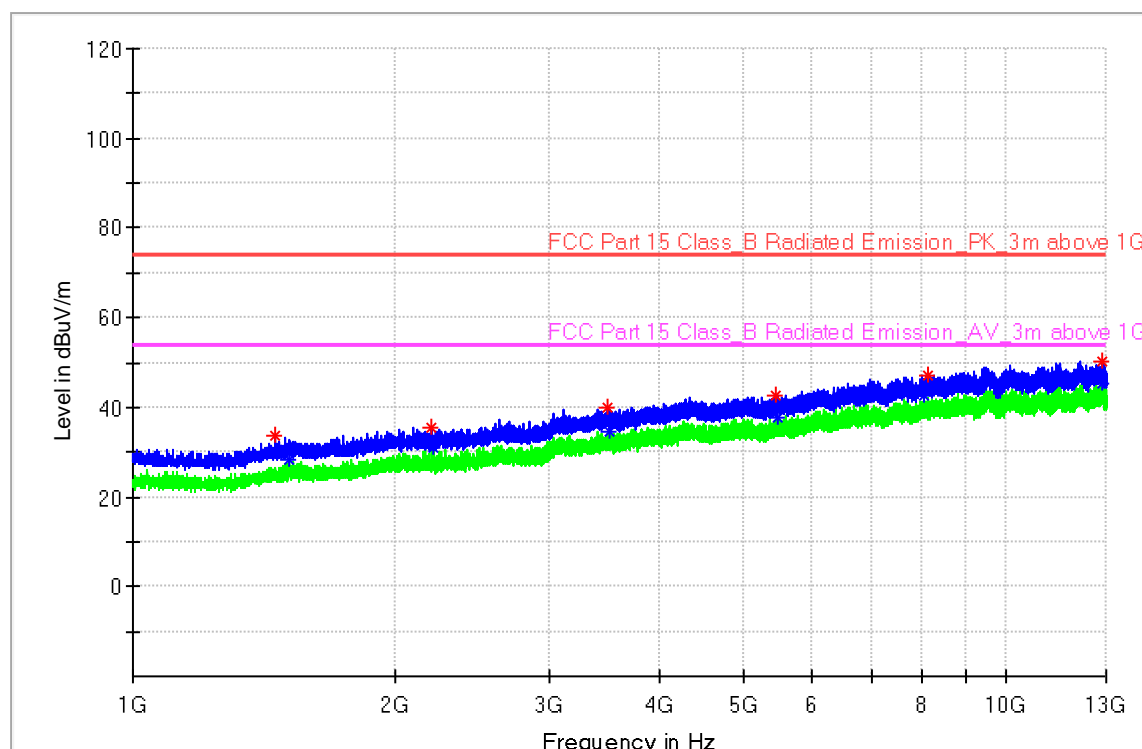

Critical Freqs

Frequency (MHz)	MaxPeak (dBuV/m)	Average (dBuV/m)	Limit (dBuV/m)	Margin (dB)	Height (cm)	Pol	Azimuth (deg)
5466.800000	---	37.75	54.00	16.25	100.0	V	8.0
8050.000000	---	42.47	54.00	11.53	100.0	V	8.0
1507.200000	---	28.11	54.00	25.89	100.0	V	36.0
8134.000000	47.31	---	74.00	26.69	100.0	V	80.0
12848.000000	50.42	---	74.00	23.58	100.0	V	117.0
1452.800000	33.53	---	74.00	40.47	100.0	V	148.0
2212.800000	---	30.93	54.00	23.07	100.0	V	164.0
3516.000000	---	34.74	54.00	19.26	100.0	V	211.0
12873.600000	---	45.23	54.00	8.77	100.0	V	226.0
2201.200000	35.64	---	74.00	38.36	100.0	V	270.0
5448.800000	42.78	---	74.00	31.22	100.0	V	280.0
3485.200000	39.87	---	74.00	34.13	100.0	V	359.0

Note 1: Emission Level = Reading level + Correction Factor

Corrector Factor = Antenna Factor + Cable Loss - Pre-amplifier Gain

Margin=Limit – Emission Level

7 Measurement Uncertainty

For a 95% confidence level, the measurement expanded uncertainties for defined systems, in accordance with the recommendations of ISO 17025 were:

Items	Extended Uncertainty
Radiated Disturbance	30MHz to 1GHz, 5.03dB (Horizontal)
	5.12dB (Vertical)
	1GHz to 18GHz, 5.49dB
	18GHz to 40GHz, 5.63dB

Measurement Uncertainty Decision Rule:

Determination of conformity with the specification limits is based on the decision rule according to IEC Guide 115: 2021, clause 4.4.3 and 4.5.1.



8 EUT Photograph

Refer to the < External Photos > & < Internal Photos >.

-----End of Test Report-----