

Trademark Acknowledgements

X-Star™ and Venture™ are trademarks of Autel Robotics Co.,Ltd., registered in China, the United States and other countries. The Autel® logo is trademark of Autel Corp. registered in the United States and other countries. All other marks are trademarks or registered trademarks of their respective holders.

Copyright Warning

No part of this manual may be reproduced, stored in a retrieval system or transmitted, in any form or by any means, such as electronic, mechanical, photocopying, recording, or otherwise without the written permission of Autel Robotics.

Disclaimer

All information, specifications and illustrations in this manual are based on the latest information available at the time of printing. Autel Robotics reserves the right to make changes at any time without notice. While information of this manual has been carefully checked for accuracy, no guarantee is given to the completeness and correctness of the contents, including but not limited to the product specifications, functions, and illustrations.

When using the X-Star/X-Star Premium, always refer to and follow the safety instructions in this manual. Autel Robotics accepts no responsibility or warranty for direct or indirect product damage or injury if the user fails to follow the safety instructions. Autel Robotics will not be liable for any direct damages or for any legal, special, incidental, indirect damages or for any financial consequences (including the loss of profits).

The safety instructions herein covers situations which Autel Robotics is aware of. Autel Robotics cannot know, evaluate or advise you as to all of the possible hazards. You must be certain that any condition or service procedure encountered do not jeopardize your personal safety.

The content of this document is subject to change. Please download the latest version from <http://www.autelrobotics.com>.

Safety Information



IMPORTANT

Before operating or maintaining this unit, please read this manual carefully, paying extra attention to the safety warnings and precautions.

For your own safety and the safety of others, and to prevent damaging the product and its features, it is important for you to read and understand the instructions and all safety information presented throughout the product manual.

! IMPORTANT

This product is not intended for use by children without adult supervision. Do not use with incompatible components or alter the product in any way inconsistent with the instructions provided by Autel Robotics.

Take-off and Landing

- The aircraft should be placed in a distance of approximately 5 meters heading away from you on a leveled surface.
- Do not take-off or land on slopes or uneven surfaces.
- Fly in an open and safe area; keep away from buildings, trees, people and moving vehicles
- Keep the aircraft steady still and approaching to the ground by one meter or less before landing.
- Land immediately when the low battery warning sign is displayed even if the flight is soon to be finished. The temperature and wind condition may use more energy from the battery.

In Flight

- Avoid flying beside or above yourself or other people.
- Avoid flying the aircraft out of sight.
- Keep the aircraft away from potential obstacles such as trees, buildings etc.
- Leave enough space for turning and moving.
- Do not fly in severe weather conditions, including but not limited to typhoon, tornadoes, rain, storms, thunders, hail or snow.
- Avoid flying near hazardous situations, including but not limited to fire, explosions, landslides, floods or earthquakes.
- Keep away from facilities that could produce electromagnetic interference to avoid failure of location accuracy, including but not limited to power plants, power transmission lines, transformer substations or broadcasting towers.
- Avoid interferences from other remote controller transmitters or deliberate jamming attempts.
- Follow the instructions once you see a warning on the app.

! WARNING

If any part of the aircraft (including motor, battery, gimbal, compass, propellers, LED lights, binding buttons, etc) or the remote controller fails to function properly or has visible/invisible damages, DO NOT FLY THE AIRCRAFT.

Battery Usage

The aircraft is powered by a Lithium-Polymer battery. LiPo/Li-Ion batteries can be extremely hazardous and special attention is required during usage.

Read and follow carefully all safety messages and instructions presented to avoid personal injury or property damage.

! WARNING

The Lithium-Polymer battery is factory replaceable only; incorrect replacement or tampering with the battery pack may cause an explosion.

- Only use the battery and battery charger provided by Autel Robotics. Use of an unqualified battery or charger may present a risk of fire, explosion, leakage, or other hazards. Autel Robotics takes no responsibility for any damage caused by non-Autel-Robotics batteries or charging devices.
- Always turn off the aircraft before installing or removing the battery.
- Remove the battery before assembly or when not in use.
- Keep the battery away from water or any kind of liquid. If the battery gets in touch with liquid, it may lead to an explosion while using or charging.
- Do not expose the battery to fire, explosion or other hazards.
- Do not disassemble, open, crush, bend, deform, puncture or shred the battery.
- Do not modify, remanufacture, or attempt to insert foreign objects into the battery.
- Do not place heavy objects on the batteries or charger.
- Stop using or charging the battery immediately whenever the battery starts to swell, smoke or leak.
- Use the battery in temperatures between -10°C and 40°C. Extremely high temperatures may cause a fire or explosion, extremely low temperatures may lead to permanent battery damage.
- Do not use the battery in strong electrostatic or electromagnetic environments. Electrostatic or electromagnetic interference may lead to serious accidents during flight.
- Keep the battery out of reach of children and pets.
- Do not leave the battery close to moist or heat sources. Store the battery in a

dry and ventilated area at room temperature (ideally 22°C-28°C).

- Do not place the battery beside hard or sharp items, or on a conductive surface (e.g., metal plate).
- Do not place the battery in wet grass or in the pocket with metal objects.
- Battery electrolytes are highly corrosive. If any electrolytes make contact with your skin or eyes, immediately wash the affected area with fresh running water and see a doctor .
- Remove the battery from the aircraft immediately if the aircraft falls into water during flight. Leave the battery in an open area and keep a safe distance away until it is completely dry. Never use and charge the battery again.
- Do not use a damaged battery charger.
- Disconnect the charger when not in use and examine the charger's condition regularly.
- Do not leave the charging battery unattended.
- Do not charge the battery immediately after using it, as overheat protection will be activated to prevent the battery from being charged before it has cooled down completely.
- The battery recharging time varies depending on the remaining battery level.
- Disconnect and remove the Li-Po battery from the aircraft after use to prevent trickle discharge. During storage, make sure the battery level does not fall below 3V.
- Since over charging may shorten battery life, unplug the charger and stop charging once the battery of the aircraft and the remote controller has been fully charged.
- The heavier the payload, the shorter the flight time will be as more battery power may be consumed.
- Using or storing the battery in extreme environments may reduce battery life.
- Battery life inevitably shortens over time. And battery life may be reduced if the battery is left unused over extended periods of time.
- Completely discharge the battery before disposal.
- Dispose the battery properly at specified battery recycling locations.

Reminders

- Flying with an experienced pilot for the first flight is strongly recommended.
- Keep small or electrical parts out of the reach of children.
- Keep away from heat sources or humid and hostile environments.
- Check the weather before flying, including air temperature and wind speed.
- Make a thorough preflight check before each flight ( 28)
- Use only authorized accessories approved or provided by Autel Robotics.
- Do not attempt to disassemble, modify or reconstruct any part of the devices.

Autel Robotics will not be responsible for damages resulting from any artificial reason.

- Do not use this product for illegal purposes.

Services and Support

 www.autelrobotics.com

 (844)-898-0290 (U.S.A.)

 support@autelrobotics.com

Or contact your local retail agent for technical assistance.

Contents

■ BEFORE STARTING	1
USING THIS MANUAL	1
BEFORE YOUR FIRST FLIGHT	1
■ GETTING TO KNOW THE SMART DRONE	2
AIRCRAFT	2
REMOTE CONTROLLER	10
■ PREPARING THE FLIGHT	18
PREPARING THE BATTERY	18
PREPARING THE AIRCRAFT	20
PREPARING THE REMOTE CONTROLLER	22
BINDING THE AIRCRAFT AND THE REMOTE CONTROLLER	23
PREPARING THE MOBILE DEVICE	24
CALIBRATING THE COMPASS	26
■ FLIGHT OPERATIONS	28
PREFLIGHT CHECKLIST	28
REMOTE CONTROLLER AND FLIGHT OPERATIONS	29
USING THE STARLINK APP	38
■ MAINTENANCE AND SERVICE	59
FIRMWARE UPGRADE	59
TROUBLESHOOTING TIPS	60
STORAGE AND MAINTENANCE INSTRUCTIONS	61
CUSTOMER SERVICE	62
■ WARRANTY	63
■ APPENDIX	64
REGULATORY COMPLIANCE AND FLIGHT RESTRICTED AREA	64
TECHNICAL SPECIFICATIONS	66





1

Before Starting

Using This Manual

Thank you for purchasing the **X-Star** series product. Please read the manual carefully before you use the smart drone and retain the manual for future reference. Should your smart drone fail to operate correctly, refer to **Troubleshooting Tips** (📄 59).

Legend

-  **WARNING:** Precautions of a potentially hazardous situation which if not avoided could result in personal injury or property damage.
-  **IMPORTANT:** Important information that demands special attention related to the smart drone's operation.
-  **NOTE:** Additional information that complement the current topic.
-  **TIPS:** Information that helps to improve the usability of the smart drone.
-  **Reference:** A page number that guides you to the section containing relevant information in this manual.

Before Your First Flight

Read the following documents before using the X-Star/X-Star Premium:

- X-Star/X-Star Premium Packing List*
- X-Star/X-Star Premium Quick Guide*
- X-Star/X-Star Premium User Manual*

2

Getting to Know the Smart Drone

The **X-Star** series is a new generation of smart unmanned aerial vehicle. It is extremely easy to fly and reliable. Featuring the advanced built-in Smart Flight System and a high-performance remote controller, combined with a powerful mobile app, the **X-Star** allows safe and stable flight maneuvers which can be operated both manually and automatically. The stabilized 3-axis camera gimbal offers ideal solutions for smooth aerial photographing and video recording, making the system incredibly versatile and powerful.

The X-Star series comes in three models: the **X-Star Go** features an H4 gimbal ready for the GoPro® HERO4 camera; the **X-Star** and **X-Star Premium** are both equipped with an integrated 4k camera gimbal. The **X-Star** adopts a self-generated WiFi network, while the **X-Star Premium** utilizes HD video streaming to establish a live video link with the X-Star mobile app **Starlink** as you fly.

This manual provides detailed descriptions of the functions and operations about the **X-Star** and the **X-Star Premium**.

Aircraft

The **X-Star/X-Star Premium** aircraft is a quadcopter with an integrated stabilized camera gimbal. An HD camera is also integrated.

Functionality Description

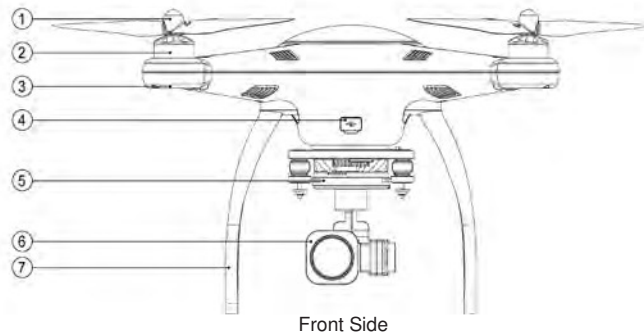

Front Side

- ① Propeller
- ② Motor
- ③ Front LED Indicator Light (5)
- ④ Micro-USB Port
- ⑤ 3-axis Gimbal (8)
- ⑥ Camera
- ⑦ Front Sticker

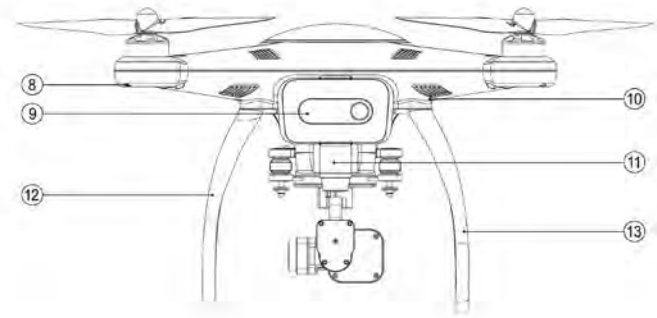

Rear Side

- ⑧ Rear LED Indicator Light (5)
- ⑨ Aircraft Battery (6)
- ⑩ RC Binding Button
- ⑪ Starpoint Positioning Module
- ⑫ Landing Gear
- ⑬ Compass Module

Built-in Smart Flight System

The **X-Star/X-Star Premium** features a built-in Smart Flight System which provides stable and user-friendly flight control. The Smart Flight System consists of various sensors such as the Global Navigation Satellite System (GNSS) receiver, the Compass, the Inertial Measurement Unit (IMU) and Barometer. It works as the central computer of the aircraft and supports various functions, such as Intelligent Orientation Control (IOC), Go Home, Failsafe, Starpoint Positioning System, etc.

Smart Flight System Modules	
Module	Description
IMU	An electronic device consisting of a 3-axis gyroscope and a 3-axis accelerometer that measure the acceleration and angular rates of the aircraft. An automatic IMU calibration is performed every time you start the aircraft.
Compass	Measures geomagnetic field and provides heading reference to the aircraft.
GNSS Receiver	Receives GNSS (GPS/GLONASS) signals to determine the latitude, longitude and altitude of the aircraft.

Barometer	Measures atmospheric pressure to determine the pressure altitude of the aircraft.
Ultrasonic Sensors	Measures the distance between the aircraft and the ground.
Monochrome Camera	Tracks the x- and y-axis location of the moving aircraft relative to the ground.

Smart Flight System Functions	
Function	Description
IOC	Configures the aircraft to fly in the direction relative to the home point. (📄 32)
Go Home	Commands the aircraft to return and land at the specified home point. (📄 33)
Failsafe	Enables the aircraft to take automatic protection measure in the event of lost communication between the aircraft and remote controller, or low battery situation. (📄 34)
Starpoint Positioning System	Enables the aircraft to hover precisely in areas where GPS signal is not available. (📄 35)

NOTE

A home point is usually memorized by the system each time as the point where the aircraft takes off. The home point can also be repositioned during flight. (📄 33).

Supported Flight Modes	
Flight Modes	Description
GPS Mode	Stabilizes and holds the aircraft in position and altitude on stick release (requires at least 6 GNSS satellite signals), providing stable and smooth flight maneuvers, as well as safety features including Go Home, IOC and Failsafe.
ATTI Mode	Stabilizes and holds the aircraft in altitude on stick release. The ATTI mode provides more agility in flight control by commanding the attitude (roll and pitch angles) of the aircraft directly.

NOTE

It is highly recommended to operate outdoor flights in GPS mode for maximum safety. ATTI mode is disabled by default, and GPS mode is always enabled when good GPS reception is available. ATTI mode can be enabled through the mobile app: **Settings** (⚙️) > **Flight Control Settings** (🔧) > **Advanced Settings** > **Enable ATTI Mode**.

Flight LED Indicator

The LED indicators on the aircraft can be found on both the front and rear arms. The front indicators help you identify the position of the aircraft's nose, and the rear indicators show the current flight status of the aircraft.

The LED indicators will light up when you turn on the aircraft. The table below describes the meanings of the LED indicator's statuses.

- Indicates solid light
- ⦿ Indicates slow flashing light
- ⦿⦿ Indicates quick flashing light
- R Indicates red colored light
- G Indicates green colored light
- Y Indicates yellow colored light

Example: "R-●" stands for RED SOLID light.

Definitions of Flight LED Indicator Light Status	
R-● (Front LEDs)	Indicates the direction of the aircraft's nose after the aircraft is powered on.
R&G-⦿⦿ (Rear LEDs)	Indicates a warm-up procedure is activated when the aircraft is powered on and more than 6 GPS satellites are available.
R&Y-⦿⦿ (Rear LEDs)	Indicates a warm-up procedure is activated when the aircraft is powered on and less than 6 GPS satellites are available.
G-⦿ (Rear LEDs)	Indicates the aircraft is in GPS mode, or the Starpoint Positioning System is working. GPS mode can be activated only when more than 6 GPS satellites are found.
Y-⦿ (Rear LEDs)	Indicates the aircraft is in non-GPS mode (or less than 6 GPS satellites are found), and the Starpoint Positioning System is not working.
Y-⦿⦿ (Rear LEDs)	Indicates the communication between the aircraft and remote controller is lost.
Y-● (Rear LEDs)	Indicates abnormal magnetic field. Make sure that the aircraft is free from all magnetic interferences.

R-● (Rear LEDs)	Indicates Low Battery Warning, meaning the battery level is less than 25%.
R-○○ (Rear LEDs)	Indicates Critical Low Battery Warning, meaning the battery level is less than 15%.
R-● (Front & Rear LEDs) Accompanied by a beep	Indicates hardware problems possibly caused by IMU deviation or other abnormalities.

NOTE

The rear LEDs will flash green light twice when a new parameter or waypoint setting has been acknowledged.

Aircraft Battery

The aircraft battery is a rechargeable Li-Po battery with the capacity of 4900mAh specially designed for the X-Star/X-Star Premium aircraft. It can only be charged with the charger supplied in the X-Star/X-Star Premium package, and can provide up to 25 minutes of continuous flight if fully charged.

Smart Features

The aircraft battery features several smart functionalities for charge-discharge management that preserves battery life.

Aircraft Battery Features	
Balancing	Balances the voltage of each battery cell to prevent overcharging or over-discharging.
Communication	Retrieves and transfers battery info, including battery level, current, voltage, battery life, and temperature to the aircraft and the remote controller.
Charging Temperature Detection	Stops charging when temperature is out of the suitable range.
LED Capacity Indicator	Indicates current battery level.
Overcharging & Over-discharging Protection	<ul style="list-style-type: none"> Stops charging when battery voltage reaches 17V. Stops discharging when battery voltage reaches 10.8V.

Short Circuit Protection	<ul style="list-style-type: none"> Cuts off power supply when a short circuit occurs. All LED lights on the battery front panel will flash green when a short circuit is detected.
Power Saving	Turns off the battery automatically after 10 minutes of inactivity.

Basic Functions

The front panel of the aircraft battery contains 4 LED capacity indicators and 1 **Power** button.

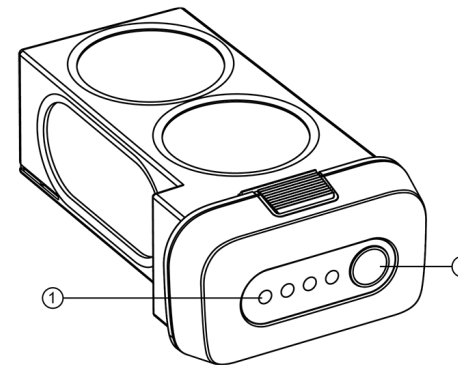

Aircraft Battery

- Capacity Level Indicator Lights
- Power Button – allows you to check the battery level and turn on/off the battery

To turn on/off the battery

Press and hold the **Power** button for 3 seconds.

To check the battery level when the battery is powered off

Press the **Power** button.

The table below describes the corresponding battery levels indicated by the capacity indicator lights once you press the **Power** button.

Battery Level Indicator Status While Discharging				
91%~100%	76%~90%	66%~75%	51%~65%	41%~50%
●●●●○	●●●●○	●●●○	●●○○○	●●○○○
26%~40%	16%~25%	1%~15%	0%	
●○○○○	●○○○○	○●○○○	○○○○○	
● - Indicates solid green light; ◎ - Indicates flashing green light; ○ - Indicates no light				

XI-5S Gimbal

The XI-5S camera gimbal is a quick-mount stabilized gimbal with three axes. It is specially designed to minimize camera vibration and deliver smooth aerial photography.

It is powered through the aircraft battery, and therefore turned on at the same time with the aircraft. A self-test is performed each time when the gimbal starts up.

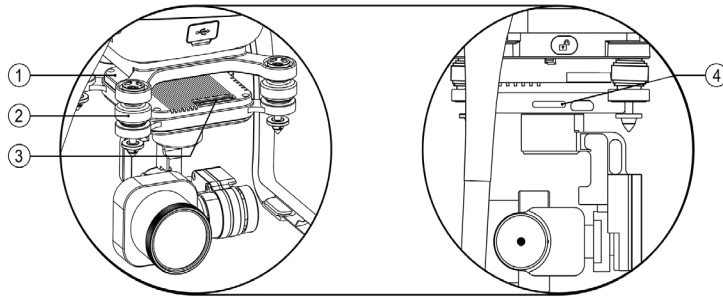

① Quick-mount Module
② Vibration Absorber

③ Aircraft Communication Port
④ Micro-SD card Slot

NOTE

- A Micro-SD card is provided inside the Micro-SD card slot with different storage capacity according to your aircraft model.
- The XI-5S Camera Gimbal is attached with a gimbal holder which protects the gimbal from incidental rotation to avoid damage. Remove the holder before powering up the aircraft (20).

The XI-5S camera gimbal for **X-Star/X-Star Premium** supports 2 working modes:

Stabilized Mode – enables stabilized camera tilting control for creative aerial photography by synchronizing the gimbal yaw movement with the aircraft.

FPV Mode – synchronizes the gimbal roll and yaw movements with the aircraft to provide a real-time video piloting experience from a first person view.

➤ To remove the gimbal

1. Hold the aircraft with one hand.
2. Hold the **Quick-mount Module** and press the **Unlock** button () at

the side of this module with another hand.

3. Slide the **Quick-mount Module** out towards the **Unlock** direction () indicated beside the **Unlock** button.

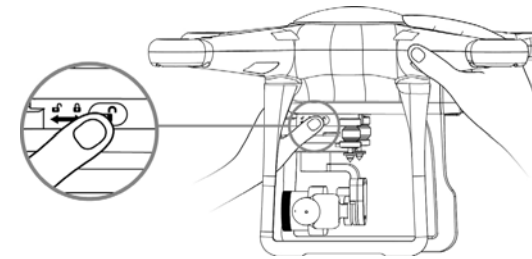

➤ To install the gimbal

1. Match the **Quick-mount Module** attached to the gimbal and the **Quick-mount Base** at the bottom of the aircraft.

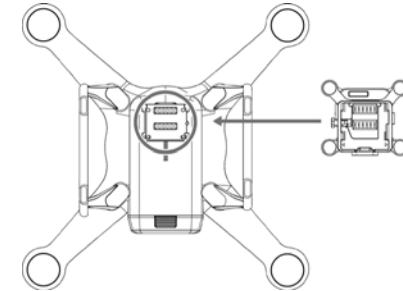

2. Slide the **Quick-mount Module** onto the **Quick-mount Base** towards the **Lock** direction () indicated beside the **Unlock** button. You will hear a clicking sound when the gimbal is properly installed.

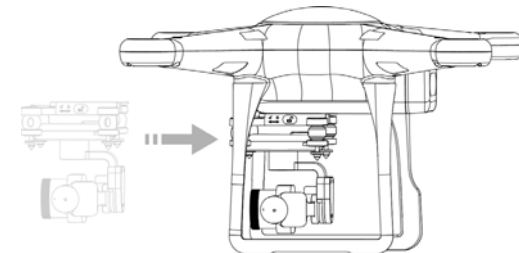

Camera

The **X-Star** and **X-Star Premium** are both equipped with a 4k UHD camera. The camera supports various shooting modes including single shot, burst shooting, AEB and time lapse. Videos can be recorded in MOV or MP4 formats, and photos can be saved in JPG or DNG formats. An HD live view from the camera can be displayed on your mobile device through the mobile app **Starlink**.

Remote Controller

The remote controller enables wireless communication with the aircraft through a 5.8GHz radio frequency band. The maximum working range of the remote controller in an open area is about 400m when set as CE standard, or about 1000m (**X-Star**)/2000m (**X-Star Premium**) when set as FCC standard.

The built-in 2.4GHz WiFi module of the **X-Star** remote controller and 900MHz HD video streaming module of the **X-Star Premium** remote controller allow video downlink from the aircraft for real-time flight and video data displayed on the app, enabling convenient control of aerial photography and remote piloting.

! IMPORTANT

The X-Star network is only established when the aircraft, the remote controller and the mobile device are properly connected through the WiFi network (**X-Star**) or HD video streaming (**X-Star Premium**).

Functionality Description

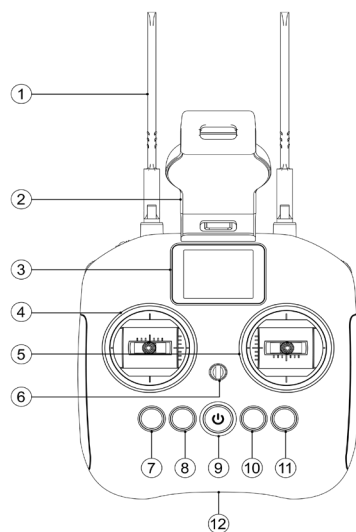

① Antennas	<ul style="list-style-type: none"> The left antenna transmits 5.8GHz RF signal to the aircraft for sending commands and receiving flight information. Both antennas receive 2.4GHz WiFi signal (X-Star) or 900MHz HD video signals (X-Star Premium) from the aircraft and transfer the flight data and camera data to the connected mobile app.
② Mobile Device Holder	Holds the mobile device with a 180° adjustable viewing angle for optimum visibility.
③ Flight Information Panel	Displays the flight status, warning messages and real-time instructions. (13)
④ Left Command Stick	Set by default: Upward / Downward and Turn Left / Turn Right
⑤ Right Command Stick	Set by default: Forward / Backward and Move Left / Move Right
⑥ Strap Hole	Attached to a neck strap for easy portability.
⑦ Motor Starter	Starts the motors.
⑧ Take-off/Landing Button	Commands the aircraft to take off or land.
⑨ Power Button	Press and hold for 2 seconds to turn on/off the remote controller. You will hear a buzz sound. The power button shows a solid green light when you turn on the remote controller.
⑩ Go Home Button	Commands the aircraft to return to the home point.
⑪ Pause Button	Commands the aircraft to stop moving temporarily and hover in position when necessary.
⑫ Power Port	Connected to the X-Star/X-Star Premium charger to charge the built-in battery of the remote controller.

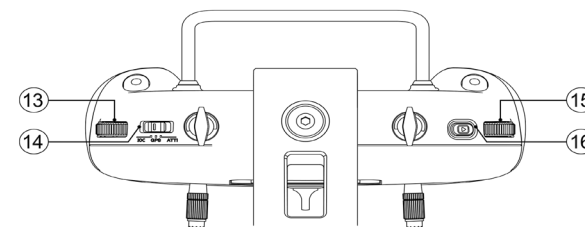

⑬ Gimbal Pitch Dial	Turn the dial to control the tilt angle of the gimbal.
⑭ Flight Mode Switch	Switch between IOC, GPS and ATTI modes.
⑮ Camera Settings Dial	Turn the dial to adjust the Advanced Camera Settings . ( 43)
⑯ Playback Button	Playback the captured images or videos. (Only functions when the remote controller is connected to the mobile app.)

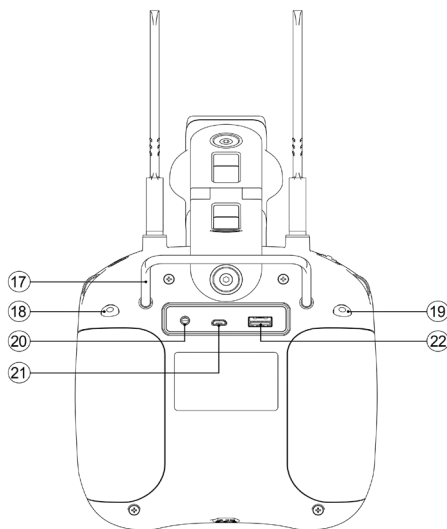

⑰ Support Stand	Holds up the remote controller at a 40 degree angle.
⑱ Shutter Button	Takes a photo. If burst mode is selected, the set number of photos will be taken with one press.
⑲ Record Button	Record a video. Press again to stop recording.
⑳ CAN-Bus Port	Connects two remote controllers with one operator as the instructor and the other as the learner.
㉑ Micro-USB Port	Reserved port.
㉒ USB Port	Connects to a mobile device through a USB cable.



Flight Information Panel

The LCD **Flight Information Panel** found on the **X-Star/X-Star Premium** remote controller is designed to provide you with intuitive information during the flight, including the flight status, warning messages, real-time instructions, etc. This section introduces the function of this panel.

● Remote Controller Calibration

When using the remote controller for the first time, you need to calibrate the two command sticks and the Gimbal Pitch Dial first. You can calibrate your remote controller according to the following steps, or using the mobile app instead ( 54).

➤ To calibrate the remote controller

1. When the remote controller is in the powered-off state, press and hold the () and () buttons simultaneously until the **Flight Information Panel** is switched from the boot screen to the RC calibration screen as shown below. The two crossed bars in the central screen represent the left and right command sticks, and the horizontal bar at the bottom stands for the Gimbal Pitch Dial.

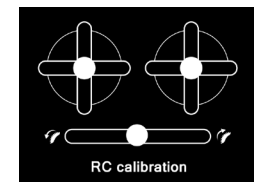
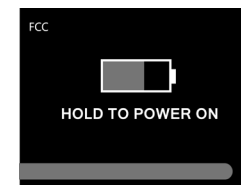

2. Release both command sticks and the Gimbal Pitch Dial naturally to the central position. The three central rounds on the RC calibration screen will be highlighted successively.

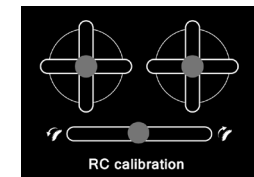

3. Push both command sticks to the ends of their 4 directions and hold for 2s successively; and turn the Gimbal Pitch Dial clockwise and counterclockwise to its 2 ends and hold for 2s. All the bars on the screen will be fully highlighted when your calibration is completed.

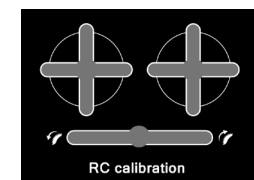

NOTE

The remote controller should be power off before you start the RC calibration. You do NOT need to repeat this operation unless you change a new remote controller.

Remote Controller Binding

After calibrating the remote controller, you need to bind your remote controller to your aircraft. When the remote controller is in power-off state, press and hold the (🏠) and (🔌) buttons simultaneously until the the remote controller is powered on.

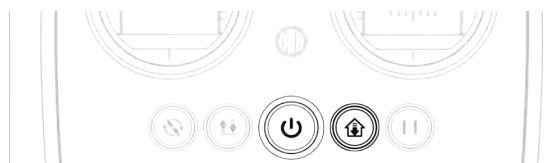

NOTE

RC binding is only available when RC calibration has been finished. The remote controller should be power off before you start to perform binding. There is no need to repeat this operation unless you change any part of the devices (e.g., aircraft, remote controller, gimbal).

Main Interface

When the video link has been connected properly, the main interface will appear as follows:



Indicator Lights

On the remote controller, there are 5 indicator lights in total. They are found on the Motor Starter (🔌), the Take-off/Landing Button (🏠), the Power Button (🔌), the Go Home Button (🏠), and the Pause Button (⏸). Each of them shows a different status in a different situation.

The following table describes the definitions of the indicator light status.

●	Indicates solid light	R	Indicates red colored light
◎	Indicates flashing light	G	Indicates green colored light
○	Indicates no light	Y	Indicates yellow colored light

Example: "R-●" stands for SOLID RED light.

① GPS Signal	Indicates the signal strength of GNSS satellites.
② Video Link Signal	Indicates the WiFi video signal (X-Star) or HD video signal (X-Star Premium) strength.
③ Flight Orientation	Indicates the tilt angle of the aircraft.
④ Remote Controller Signal	Indicates the control signal strength of the remote controller.
⑤ Remote Controller Battery	Indicates the battery level of the remote controller.
⑥ Aircraft Battery	Indicates the battery level of the aircraft.
⑦ Flight Speed	Indicates the flight speed of the aircraft.
⑧ Pitch Angle	Indicates the tilt angle of the camera.
⑨ Flight Distance	Indicates the horizontal distance between the aircraft and the home point.
⑩ Flight Altitude	Indicates the altitude of the aircraft relative to the home point.
⑪ Flight Status Bar	Displays the real-time flight status, the function of the button you have activated, and warning messages.



G-●: A. Sufficient battery when RC is in use
B. Fully charged in charging state with power on

G-○: In charging state with power on

Y-●: Low battery warning

R-●: In charging state with power off

R-○: In process of RC firmware update

○: A. Fully charged in charging state with power off
B. Power off while not in charging state



G-●: Activate each button by holding for 2s until you hear a beep sound

○: 1s after you release the button

G-○: (Go Home Button) The aircraft is performing the **Go Home** procedure



G-●: Simply press the button shortly to activate the **Pause** function

○: When you release the button

Remote Controller Buzzer Alerts

The built-in buzzer of the remote controller makes different alert sounds according to various status alarms, such as low battery warning, lost WiFi connection or lost

aircraft communication. The different alerts are described below.

Remote Controller Buzzer Alerts	
Aircraft Low Battery Warning (about 25%)	1 quick beep every second (lasts for 5s), followed by 2 RC vibrations
Aircraft Critical Low Battery Warning (about 15%)	5 quick beeps every second (last for 5s), followed by 5 RC vibrations
RC Low Battery Warning (10%)	1 quick beep every second (lasts for 5s)
RC Critical Low Battery Warning (5%)	5 quick beeps every second (last for 3s), followed by 2 RC vibrations
Aircraft & RC Communication Lost	2 quick beeps every second (last for 5s), followed by 1 RC vibration
Video Link Disconnected	3 quick beeps in 1 second
Compass Interference	1 beep followed by 1 RC vibration
Standby Notification Tone	3 beeps every 15 minutes of inactivity

3

Preparing the Flight

The **X-Star/X-Star Premium** features a user-friendly design that requires very simple assembly to get the aircraft ready to fly. However, it is essential to read and follow all the instructions and warnings in this manual prior to assembly, setup or use, in order to operate safely.

⚠ WARNING

Do not use incompatible components or alter this product in any way inconsistent with this manual. Failure to operate this product in a safe and responsible manner could result in injury or damage.

Preparing the Battery

Installing and Removing the Aircraft Battery

➤ To install the battery

1. Make sure the battery is powered off before installation.
2. Insert the battery into the aircraft battery compartment as shown on the right. The battery will firmly click in when it is properly installed.

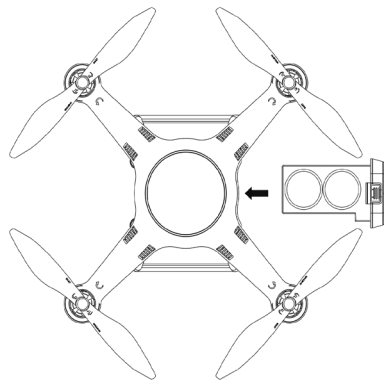

➤ To remove the battery

1. Make sure the battery is powered off before removal.
2. Press and hold the top and bottom tabs on the battery, and pull it out slowly.

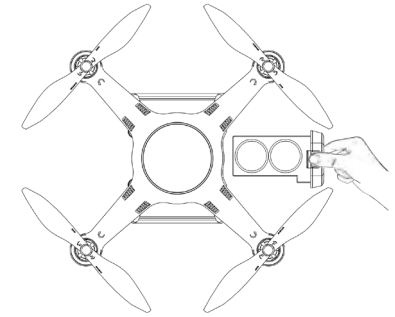

Charging

The aircraft battery and the remote controller can be charged simultaneously with the charger supplied in the **X-Star/X-Star Premium** package.

➤ To charge the aircraft and remote controller

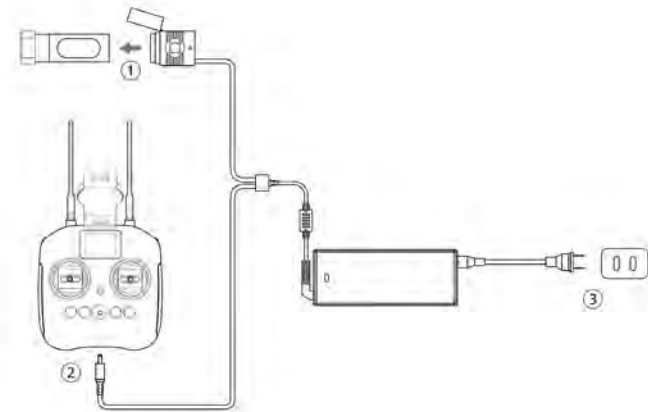

1. Remove the battery from the aircraft and connect it to the charger.

⚠ IMPORTANT

- The aircraft battery should be fully charged before use for the first time.
- If the current battery level is $\geq 80\%$, turn on the battery before charging.

2. Connect the charging cable to the Power Port on your remote controller.

3. Connect the charger to a power outlet.
 - The battery level indicator lights on the aircraft battery will illuminate and indicate the current battery level during charging, and will turn off when the battery is fully charged.

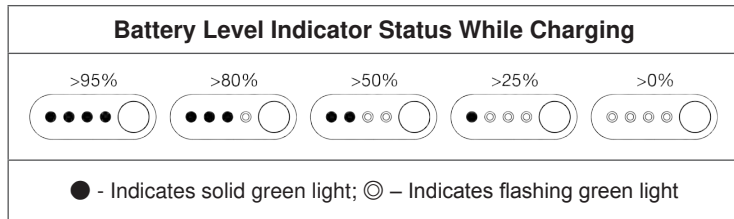

- The button on the remote controller will illuminate solid green light (when RC power on) or solid red light (when RC power off) during charging. When charging is completed, it is prompted on the **Flight Information Panel**, and you will hear two beep sounds.
4. When charging is completed, disconnect the charger and the aircraft battery/remote controller.

NOTE

For a full charge, the aircraft battery requires 1 hour and the remote controller requires 4.5 hours approximately.

Preparing the Aircraft

Follow the instructions in this section to prepare the aircraft for a safe flight.

Removing Gimbal Holder

Remove the gimbal holder before powering up the aircraft to avoid damage. Pull out the attached gimbal holder carefully as illustrated below.

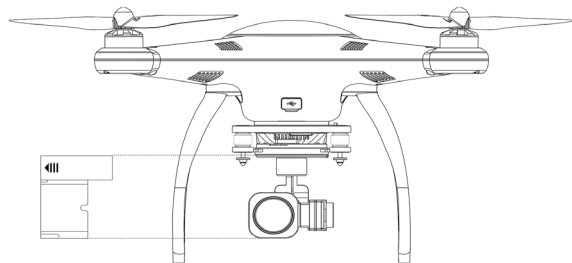

Reinstall the gimbal holder after using the aircraft to protect the gimbal from unwanted movements when not in use.

Installing Propellers

WARNING

Do not power up the aircraft while installing or removing the propellers.

IMPORTANT

It is recommended to wear protective gloves when assembling or removing the propellers to protect you from the sharp edges. Use tools (e.g., wrench, plier, etc.) when necessary.

On each of the propellers there is one **Lock** icon and one **Unlock** icon indicating the rotate direction to fasten or unfasten the propellers.

Fasten the propeller by rotating the propeller in the indicated direction.

Unfasten the propeller by rotating the propeller in the indicated direction.

➤ To install the propellers

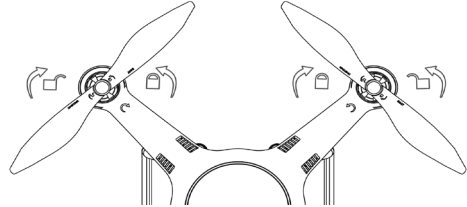
1. Remove the warning cards from motors after reading. Do not power up the aircraft.
 2. Match two of the propellers with red nuts to the corresponding motors with red paint, and the other two with silver/black nuts to the unpainted motors.
- 
3. Fasten the propeller by rotating in the direction indicated by the icon.

➤ To remove the propellers

1. Power off the aircraft.
2. Unfasten the propeller by rotating in the direction indicated by the icon.

! IMPORTANT

- Check and ensure every propeller is stably mounted and in good condition before each flight. Do not use aged or damaged propellers.
- Power off the aircraft before installing or removing the propellers. Keep off the propellers or motors when they are spinning. Remove the propellers when testing the motors' operation.

💡 TIPS

It is recommended to remove the propellers when the aircraft is not in use.

○ Preparing the Remote Controller

➤ To power up the remote controller

Press and hold the  button for 2 seconds until it lights up as solid green.

! IMPORTANT

It is recommended to power up the remote controller before turning on the aircraft.

➤ To power off the remote controller

Press and hold the  button for 2 seconds until you hear a short beep sound.

🔧 NOTE

The remote controller makes an alert sound after 15 minutes of inactivity, and turns off automatically after 30 minutes of inactivity.

When powering on/off the remote controller, make sure to hold the () button until the **Flight Status Bar** is fully highlighted. You can check the CE/FCC standard on the upper left corner.

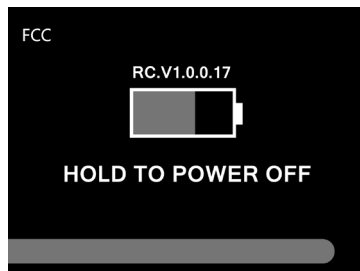
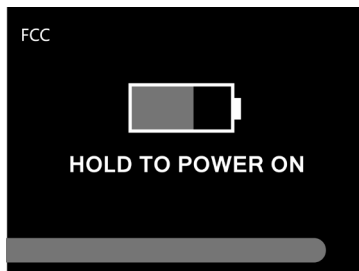

🔧 NOTE

The remote controller is made to comply with both CE and FCC standards. The system automatically chooses to comply with CE or FCC depending on the GPS locations.

○ Binding the Aircraft and The Remote Controller

The remote controller and the aircraft are bound by default, which enables the devices to bind automatically when both devices are powered up. Rebinding the aircraft and the remote controller is required only when part of the devices (e.g., aircraft/ gimbal/ remote controller) has been replaced. In this case, perform rebinding through the **RC Binding button** on the aircraft.

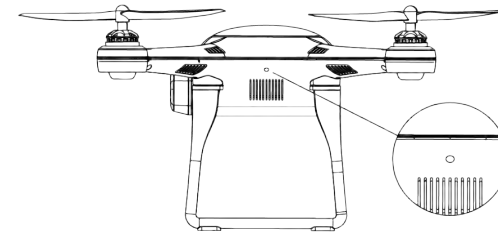

➤ To rebind the aircraft and the remote controller

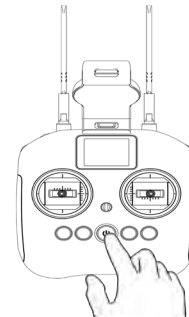

1. Turn off the remote controller.

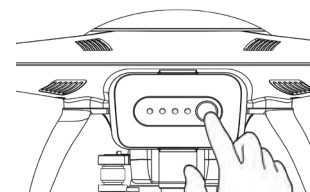

2. Turn on the aircraft.

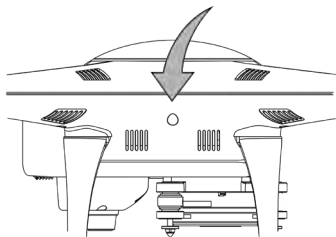

3. Press and hold the **RC Binding button** on the aircraft for about 3 seconds, the binding indicator beside the **RC Binding button** will flash slowly in green light indicating the aircraft is ready to rebind.

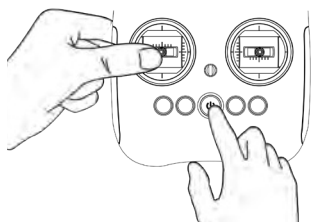

4. Push and hold the **Left Command Stick** leftward while pressing and holding the **Power** button on the remote controller for a few seconds, the binding indicator will turn to solid green light when binding is successful.

NOTE

For Step 4, you may also use the app as follows: **Settings** (⚙️) > **RC Settings** (📶) > **RC Binding**. (📄 55)

Preparing the Mobile Device

By connecting your mobile device to the aircraft, the X-Star mobile app **Starlink** configures your mobile device to perform as a First Person View (FPV) monitor and a ground station for remote piloting, flight configuration and waypoint navigation.

The **Starlink** app works on both iOS and Android smart phones and tablets. You can download it from our official website, Google Play, App Store, or by scanning the QR code shown on the package.

Supported systems:

- iOS 8.0 or later (only compatible with iPhone 5 or later iPhone models)
- Android 4.0 or later

Installing the Mobile App – Starlink

Download and install the **X-Star/X-Star Premium** mobile app **Starlink** according to the following procedures.

➤ **To install Starlink:**

- A. Search in App Store/Google Play by entering the keyword **Starlink** (case insensitive) to download and install the app on your mobile device.



- B. Download Starlink from the official website:

1. Visit <http://www.autelrobotics.com>
2. Download from **Support** > **Downloads** > **Software & App**
3. Install the mobile app on your mobile device

NOTE

Starlink will be updated regularly. Please check occasionally for latest updates.

Connecting the Mobile Device

The **X-Star/X-Star Premium** network is established when the aircraft, the remote controller and the mobile device are properly connected. This enables the mobile device to receive real-time flight data and video footage during flight so you can monitor flight maneuvers through the mobile app.

➤ **To connect the mobile device to the aircraft**

1. Power up the remote controller and the aircraft successively.
2. Connect your mobile device.

X-Star:

Turn on the WiFi connection on your mobile device, select **X-Star_******* from the WiFi list, and enter the default password **99999999**.



X-Star Premium:

Use a USB cable to connect your mobile device to the USB Port on the back of the remote controller.

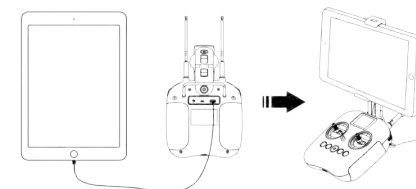

3. Launch the mobile app  on your mobile device. When the connection is successful, the **Home Page** of the app displays **Connected** in the upper left corner, and the **Flight Information Panel** on the remote controller displays **App Connected** in the **Flight Status Bar**.

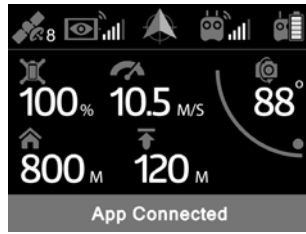

Calibrating the Compass

Make sure to calibrate the compass every time when flying in a new location. The rear 2 LEDs on the aircraft will show solid yellow light when the flight system detects compass deviation, indicating that you should change a place and calibrate the compass. If a drift occurs when the aircraft is hovering, the compass calibration is also necessary.



WARNING

The compass is very sensitive to electromagnetic interference that may cause compass error and poor flight. If you find the compass abnormal after calibration, move the aircraft to another location and try again.

Remember to meet the following requirements when carrying out compass calibration:

- Operate calibration outdoors (ideally on an open space such as a lawn).
- Be free from all magnetic interferences, such as magnetite or steel reinforcement found in concrete.
- Stay away from both underground and overhead power lines.
- Do not carry ferromagnetic materials (e.g., keys, cell phones) with you.

➤ **To calibrate the compass:**

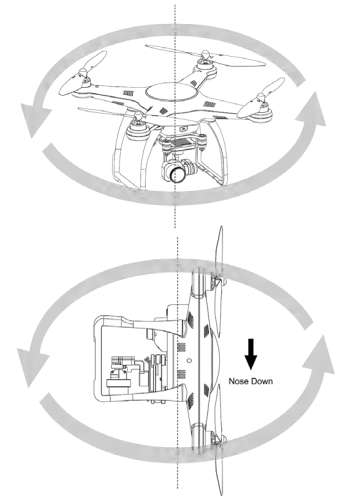

1. Begin calibration with your app: **Settings** () > **Flight Control Settings** () > **Compass Calibration**, and follow the on-screen instructions that help you monitor the calibration status. You will be informed when the calibration process has been initiated, then the 4 LEDs on the aircraft will flash yellow light.

2. Rotate the aircraft horizontally for 360°. The 4 LEDs on the aircraft will change into flashing green light when this step is completed successfully.



3. Hold the aircraft vertically and rotate it for another 360° with its nose facing downwards. When calibration succeeds, you will be informed by the app, and the 4 LEDs on the aircraft will illuminate solid green light for 5s.

NOTE

- When the mobile app displays instructions or alerts, please perform the required task in time to ensure your operation can be carried out successfully.
- You can also start the calibration process with the remote controller by pressing  and  simultaneously for 2 seconds. Then continue to perform Step 2 and 3 to complete the procedure.

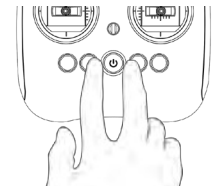

WARNING

- If the calibration is unsuccessful, the 4 LEDs on the aircraft will illuminate solid yellow light. In this case, repeat the above steps to try again.
- If severe drifting occurs during flight or the aircraft seems unstable for any reason, please land immediately.

4

Flight Operations

After all pre-flight preparations have been done properly, take a few minutes to familiarize yourself with the controls of your **X-Star/X-Star Premium** by following the operation instructions described in this section before flying.

! IMPORTANT

Before flying the **X-Star/X-Star Premium** aircraft, make sure those who operate or come into contact with this product have read and understood all safety instructions presented throughout this manual.

Preflight Checklist

Follow the steps below to carry out a full preflight check-up to maximize safety.

- The aircraft battery, the remote controller and the mobile device are fully charged
- The gimbal holder is removed.
- The propellers are properly installed and are in good condition.
- The antennas of the remote controller are unfolded and well adapted for a good position to obtain the best transmission quality ( 29).
- The aircraft and the remote controller are bound.
- The mobile app is properly installed and your mobile device is connected to the aircraft.
- The camera view on the X-Star mobile app is synchronized with the mounted camera.
- The firmware has been updated to the latest version.
- Familiarize yourself with the flight controls.
- Your flight area is an open, unobstructed and uncrowded area.

Remote Controller and Flight Operations

The remote controller has 2 command sticks designed for convenient remote flight controls for aerial maneuvers, including aircraft ascent/descent, left/right rotation, forward/backward and left/right sideways movements.

! WARNING

When less than 6 satellite signals are received, the aircraft will not take off in GPS mode.

For the aircraft to receive maximum signal strength from the controller, position the two antennas so that they are parallel to each other and that their pointing direction is perpendicular to the direction of the aircraft's position, as shown in the images below.

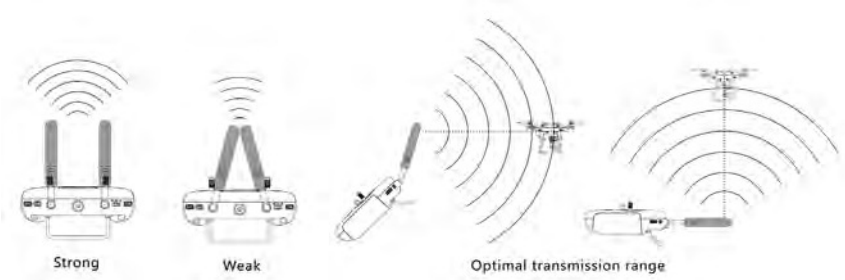

Motor Start-up and Take-off

Start the motors before commanding the aircraft to take off.

🔧 NOTE

The aircraft will not take off if the battery level is 15% or lower.

➤ Start the motors in one of the following ways:



Motor Starter:

Hold for 2s

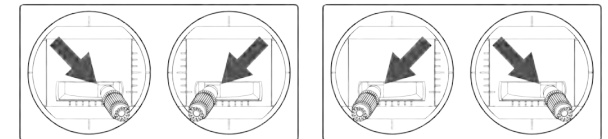

Both Command Sticks:

Hold toe-in or toe-out for 2s

- **When the motors are turned on, use one of the following methods to take off the aircraft:**



Takeoff/Landing Button:
Hold for 2s

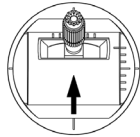

Left Command Stick
Push upward

If you command the aircraft to take off using , the aircraft will ascend automatically to a height of 4 meters.

 **NOTE**

 can only be activated after 3 seconds upon motor start-up, and does not work in ATTI Mode.

 **WARNING**

Do not block any of the air vents located beside the motors. Make sure the motors have cooled down completely before you touch it.

Command Stick Control

The aircraft reacts to the control of the command sticks through the RF transmission. The flight speed depends on the magnitude of the stick commands.

 **TIPS**

For beginners, it is recommended to move the command sticks lightly and slowly to keep the aircraft flying in a controllable speed.

- **Left Command Stick**

- A. **Ascent/Descent** – commands the aircraft to ascend by pushing the stick upward, and descend by pushing it downward.

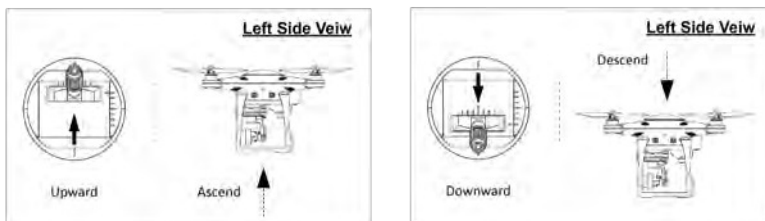

- B. **Rotate Left/Rotate Right** – commands the heading of the aircraft to rotate left or right by pushing the stick left or right.

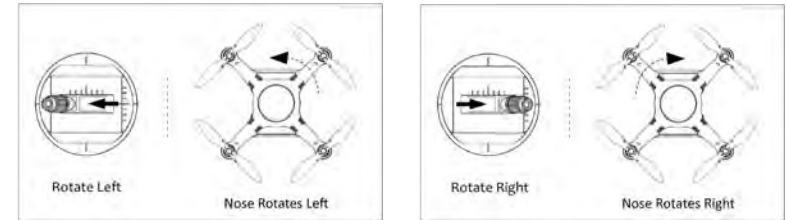

- **Right Command Stick**

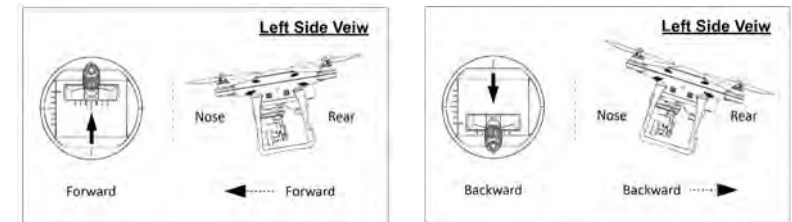

- A. **Forward/Backward** – commands the aircraft to move forward or backward by pushing the stick upward or downward.

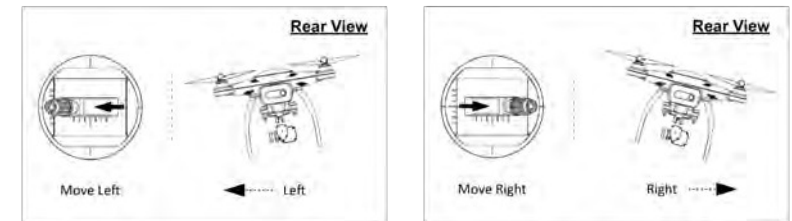

- B. **Move Left/Move Right** – commands the aircraft to move left or right by pushing the stick left or right.



 **NOTE**

The controls illustrated above are set as the default command stick mode (Mode 2). The left command stick controls aircraft ascent/descent and left/right rotation; The right command stick controls aircraft forward/backward and left/right sideways movements. You can change the control settings via the app: **Settings** () > **RC Settings** () > **Command Stick Mode**. ( 55)

Smart Flight Features

● Intelligent Orientation Control (IOC)

To activate the **IOC** function during flight, slide the **Flight Mode Switch** at the side of the remote controller to the left.

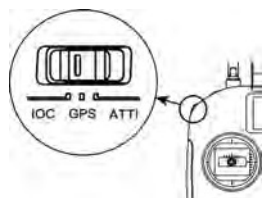

IOC mode is also known as Carefree Mode. It is used to keep the aircraft's direction controls locked regardless of its nose direction. It is most useful when you are unable to observe the nose direction of the aircraft. IOC works only in GPS mode, and has 2 control modes: **Home Lock** and **Course Lock**.

Home Lock

The Forward/Backward and Move Left/Right command stick controls are always in the radial or tangential directions of the aircraft position relative to the home point regardless of the aircraft nose direction.

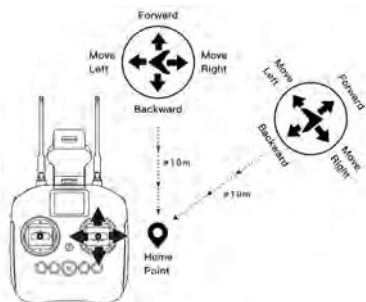

Course Lock

The Forward/Backward and Move Left/Right command stick controls are set in the parallel and perpendicular directions, respectively, to the reference line between the home point and the point where the IOC is activated regardless of the aircraft nose direction.

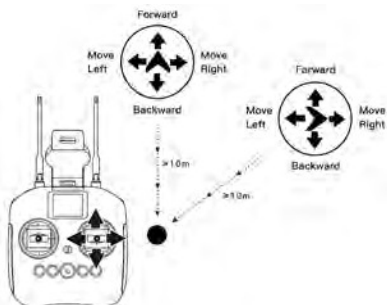

NOTE

- The flight direction is relative to the home point instead of the location of the pilot.
- **IOC** mode can only be activated when the aircraft is at least 10 meters away from you.



● Go Home

The **Go Home** function only works in **GPS** mode. To manually activate **Go Home** function, you can press the **Go Home** button () on the remote controller.

When the **Go Home** command has been successfully received, the aircraft automatically maneuvers itself to return directly and land at the preset home point. Make sure there are no buildings or other obstacles in the flight path.

When **Go Home** is activated, the remote controller's functionality will be disabled temporarily while the aircraft returns to the home point. The remote controller's functionality can be regained during this period, allowing you to stop the aircraft Going Home when you consider it is safe.

! IMPORTANT

- For safety reasons, if the aircraft is hovering at the altitude lower than 30 meters when **Go Home** function is activated, it will ascend to an altitude of 30 meters above the home point before starting to return. You can adjust the Go Home altitude in the app: **Settings** () > **Flight Control Settings** () > **Go Home Altitude** ( 53).
- If **Go Home** function is activated within 10 meters radius from the home point, the aircraft will land automatically onsite.

➤ To manually regain control of the aircraft during Go Home procedure:

Push the left command stick (Mode 2) upward to the position of 90% in range and hold for 2 seconds. The aircraft will stop flying towards the home point and may fly upward slightly when the remote controller control is recovered.

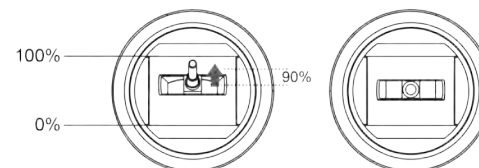



Alternatively, you can simply press the Pause Button () to regain control of your aircraft.

➤ To reposition the home point during flight

1. Maneuver the aircraft to the desired location.
2. Release the command sticks when the aircraft reaches the target

position to let it hover.

3. Press and hold the  Button until you hear a beep sound.
4. Press the  Button again within 5 seconds and hold the button until you hear a beep sound.

The rear LEDs of the aircraft will flash green light quickly for 3 seconds indicating the home point reset is successful.

 **NOTE**

The altitude of the original home point remains unchanged.

● Failsafe

The **Failsafe** function is designed to help your **X-Star/X-Star Premium** automatically return home or land onsite when necessary.

• Communication Lost

Failsafe will be triggered after 5s when the communication between your aircraft and remote controller is lost.

If GPS is available when **Failsafe** is activated, the aircraft will start the **Go Home** procedure automatically.

If GPS is unavailable (i.e. less than 6 satellites are found) when **Failsafe** is activated, the aircraft will hover for 10s. If 6 or more satellites are found during this period, the aircraft will start the **Go Home** procedure; otherwise, the aircraft will land onsite.

• Low Aircraft Battery

Failsafe will also be activated if one of the following low battery conditions are met.

- A. Your aircraft's battery constantly calculates the required battery level needed for the aircraft to return to the home point from its current location. When the battery level reaches the minimum level required for the aircraft to return to the home point, **Failsafe** will be activated and your aircraft will automatically **Go Home**. You can regain control of the aircraft during the **Go Home** process ( 33).
- B. Anytime your aircraft's remaining battery level reaches 25% (**Low Battery Warning**), **Failsafe** will be activated and your aircraft will automatically **Go Home**. If you choose to regain control during this process, the aircraft will automatically land onsite when the remaining battery reaches 15% (**Critical Low Battery Warning**).

 **NOTE**

- If the aircraft is only within 50m away from the home point when your aircraft's battery level reaches 25% (**Low Battery Warning**), the aircraft will not perform the **Go Home** procedure.
 - When GPS is unavailable when **Failsafe** is activated at **Low Battery Warning**, the aircraft will hover for 10 seconds. If the GPS signal becomes acceptable again in this period, the aircraft will start to Go Home; otherwise, the aircraft will land onsite.
-



● Starpoint Positioning System

The **Starpoint Positioning System** installed on the **X-Star/X-Star Premium** functions through a **monocular camera** ① and two **ultrasonic sensors** ② on the bottom of the aircraft.

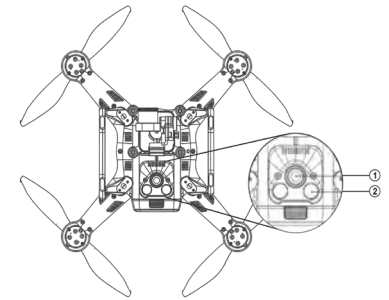
The sensors help to identify the current height of the aircraft through ultrasound, and the camera obtains location information through image analysis. With the help of the **Starpoint Positioning System**, the aircraft can hover in place more precisely when flying indoors or in other environments where the GPS signal is unavailable.



 **NOTE**

- The **Starpoint Positioning System** is activated by default when the aircraft is turned on. To turn off the **Starpoint Positioning System**, go to the app: **Settings** () > **Flight Control Settings** () > **Advanced Settings** > **Starpoint Positioning System**.
 - The **Starpoint Positioning System** works both in GPS and ATTI modes and is only valid when the aircraft is less than 3.5 meters above the surface.
-

! IMPORTANT

The performance of the **Starpoint Positioning System** is affected by the brightness and texture of the surface over which the aircraft is flying. The ultrasound may not work accurately above sound-absorbing materials. So try to avoid the following situations:

- Flying over a monochrome surface (e.g. pure black, white, or red) or a highly reflective surface (e.g. water, transparent surfaces).
- Flying over extremely dark or bright surfaces, or in an area where the lighting changes frequently.
- Flying over surfaces with unclear patterns or texture, or highly repeating patterns or texture (e.g. tiles with the same design).
- Flying over surfaces (e.g. thick carpet) that can absorb or deflect sound waves.
- Flying at a high speed: over 8m/s at a 2-meter height, or over 4m/s at a 1-meter height.
- Flying over moving surfaces or objects.

💡 TIPS

- Always keep the monocular camera lens clean to maintain a clear view.
- Do not use other 40KHz ultrasonic devices nearby when the **Starpoint Positioning System** is activated.

Landing and Motor Shut-down

The aircraft can be landed manually, automatically, or passively.

! IMPORTANT

The aircraft must be landed gently on a flat surface to avoid damage.

● Manual Landing

You can manually land the aircraft whenever and wherever you want by maneuvering the command sticks on the remote controller.

➤ To land the aircraft manually

1. Maneuver the aircraft to the desired position for landing.

2. Release the command sticks when the aircraft reaches the target position to let it hover.
3. Push the left command stick down steadily and gently to land the aircraft.

➤ To shut down the motors

When the aircraft has properly landed, operate with one of the command methods below to turn off the motors:

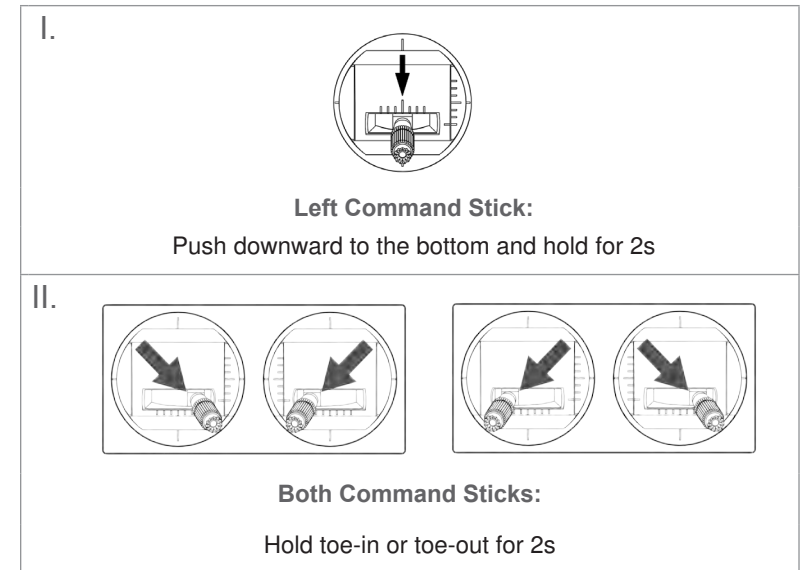

⚠ WARNING

Toe-in action will always shut down the motors even if the aircraft is in midair. Please be extra cautious and use this feature only during an emergency, e.g., the aircraft gets out of control.

● Automatic Landing

You can use the () button on the remote controller to land the aircraft automatically from its current hover position with one single click.

➤ To land the aircraft using the button automatically:

1. Maneuver the aircraft to the desired position for landing.
2. Release the command sticks when the aircraft reaches the target

position to let it hover.

3. Press and hold the () button for 2 seconds until you hear a beep sound.
4. The aircraft will descend to land and shut off its motors automatically. During descent, you will also have controls to roll, pitch and yaw for adjustments.

TIPS

During the automatic descent process, you can regain control by pushing the left command stick (Mode 2) to at least 90% level and maintaining for 2 seconds. ( 33)

NOTE

- Automatic landing can also be engaged in ATTI mode but you should control the attitude of the aircraft manually.
- It is recommended that you land the aircraft immediately when Low Battery Warning (25% or lower) is shown, i.e., the rear LEDs on the aircraft illuminate flashing red light, and the () button on the remote controller lights up in solid yellow light.

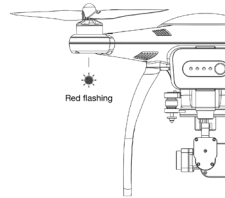

● Passive landing

When Failsafe is triggered by any of the following conditions, the aircraft will be forced to land onsite automatically.

- The connection between the aircraft and remote controller breaks down.
- **Low Battery Warning** is activated in non-GPS environment.
- **Critical Low Battery Warning** is activated.

○ Using the Starlink App

The **X-Star/X-Star Premium** mobile application, **Starlink**, is a newly-designed program with full features including aircraft control, flight data review, remote camera shooting, preset-waypoint navigation, general settings and so on. Your mobile device will perform as the central monitor for remote piloting control, aerial photographing and filming, and flight parameter tuning to achieve optimal flight performance.

Home Page

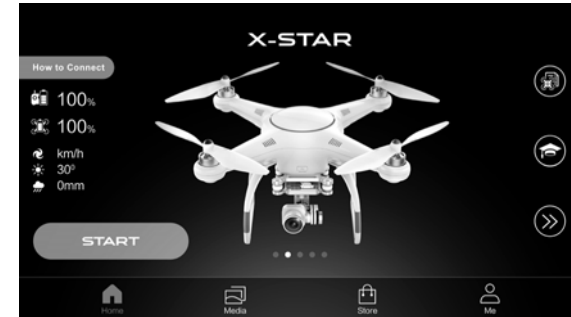

FLIGHT RECORD

View detailed record of all your flights such as time, distance and actions taken.

ACADEMY

View the documents of Packing List, Quick Guide, User Manual and the video of Guided Tour.

LEARN MORE

Slide the center of the screen to find the aircraft you wish to learn more about and tap on it to get more information.

MEDIA

View and edit the photos and videos that you have downloaded.

STORE

Enter Autel's online store where you can purchase the products and accessories.

ME



Register or log into your Autel account.

How to Connect

Slide the center of the screen to choose your aircraft and tap this button to follow the pop-up instructions to connect your mobile device. When your connection is successful, this button turns to green and displays **Connected**.

NOTE

When your aircraft is used for the first time, you will be led to the registration page after the connection is completed. Please follow the on-screen instructions to activate your **X-Star/X-Star Premium**:

1. Create an account and set a password for your account.
2. Name your **X-Star/X-Star Premium**.
3. Select the **Command Stick Mode**, **Parameter Unit** and **System** based on your preferences.
4. Confirm that the **Beginner Mode** is enabled. This mode is enabled by default when you use the product for the first time, and you may disable Beginner Mode through the app: **Settings** () > **Flight Control Settings** () > **Beginner Mode** ( 52).

START

Enter the camera screen for a **First Person View**.

When your mobile device has been connected to the aircraft, the system will start a self-check to ensure it is safe to fly. You can check the overall status in a prompted window and eliminate the abnormal conditions before your flight.

First Person View (FPV)

This interface synchronizes your screen display with the on-board camera for a real-time first person view, allowing you to perform various camera operations and configurations for aerial photography.



- ① Flight Control Panel
- ② Aircraft Status Bar
- ③ Camera Operation Panel
- ④ General Information Bar
- ⑤ Map Split Screen

Flight Control Panel



BACK

Return to the **Home Page** of **Starlink**.



FLIGHT MODE

The information of this icon varies depending on the current flight mode of the aircraft, including GPS, ATTI and IOC. You can also tap this icon to enter the **Flight Control Settings** page.



AUTO-PILOT

Command the aircraft to fly automatically according to the intelligent flight mode you have selected, including Orbit, Follow and Waypoint modes. ( 45)



TAKE-OFF / LAND

Command the aircraft to take off or land.





GO HOME

Command the aircraft to return to the specified home point.



HOME POINT

Choose a new location as your home point. Options include the location where you are standing () and the real-time location of the aircraft when you tap this icon ().

Aircraft Status Bar



DISTANCE

The horizontal distance between the aircraft and the home point.



ALTITUDE

The altitude of the aircraft relative to the home point level.



FLIGHT SPEED

The current flying speed of the aircraft.



REMAINING TIME

The remaining time for the aircraft to fly.



BATTERY LEVEL

The current battery level of the aircraft.



STARPOINT INDOOR POSITIONING

The distance between the surface and the **Starpoint Positioning System's** sensors. This icon is highlighted only when the **Starpoint Positioning System** is in working state.



FLIGHT STATUS

- The arrow indicates the tilt angle of the aircraft's nose.
- The colored ring indicates the current battery level of the aircraft. The green bar is present when there is abundant battery. The yellow bar indicates **Low Battery** and you should let your aircraft Go Home. The red bar means **Critical Low Battery** and the aircraft will land onsite.

● Camera Operation Panel



PITCH CONTROL BUTTON

Tap this button to open the **Pitch Scroll Bar** which you can scroll up and down to control the camera pitch movement. A camera pitch angle indicator will show up accordingly on the right upper corner of this button.



PLAY BUTTON

This icon displays the most recent photo/video taken. You may tap it to view and download/delete your photos and videos one by one or in groups.



RECORD BUTTON

Tap this button to record a video. Tap it again to stop recording. **Video Settings** are available in ().



SHUTTER BUTTON

Tap this button to take a photo. **Photo Settings** are available in (). Before taking a photo, select a shooting mode (Single Shot, Burst Shooting, AEB, Time Lapse) from **Photo Settings**. This icon may appear differently depending on different shooting modes you have chosen.



ADVANCED CAMERA SETTINGS

Automatic Settings () allow you to adjust **EV**; Manual Settings () allow you to adjust **ISO** and **Shutter Speed**.



CAMERA SETTINGS

Perform **Photo Settings** (), **Video Settings** () and **Camera Settings** ().

(* default value)	
Mode	*Single Shot, Burst Shooting (3/*5/7), AEB (*3/5), Time Lapse (*5/7/10/20/30)
Size	*4000×3000 (4:3), 4000×2250(16:9)
Format	*JPG, DNG, JPG+DNG
Style	*Standard, Soft, Landscape, Custom
WB	*Auto, Sunny, Cloudy, Incandescent, Neon
Color	*None, Nostalgia, Art, Beach, Classic, Vivid, Dream, Film, Log, B&W

(* default value)	
Resolution	*4096×2160p 24/25, 3840×2160p 24/25/30, 2704×1520p 24/25/30, 1920×1080p 24/25/30/48/50/60/120, 1280×720p 24/25/30/48/50/60/240
Standard	*NTSC, PAL
Format	*MOV, MP4
Style	*Standard, Soft, Landscape, Custom
WB	*Auto, Sunny, Cloudy, Incandescent, Neon
Color	*None, Nostalgia, Art, Beach, Classic, Vivid, Dream, Film, Log, B&W

(* default value)	
Histogram	ON, *OFF
Over Exposure Warning	ON, *OFF
Video Caption	ON, *OFF
Anti-Flicker	*Auto, 50Hz, 60Hz
Grid	*None, Grid Lines, Grid+Diagonals, Center Point
File Index Mode	Continuous, *Reset
Reset Settings	ON, *OFF
Format SD Card	ON, *OFF
Version	Displays the current version of the camera

⚠ WARNING

The **Format SD Card** option in **Camera Settings** will format the inserted SD card. Make sure to back up your files before doing so. For whatever reasons, Autel will not be responsible for any unrecorded or unreadable image or video.

✎ NOTE

It is recommended that you format the SD card only via the **Starlink** app. The camera may not be able to recognize the SD card if you format it using other devices.

● General Information Bar



SETTINGS

Tap this icon to open the **Settings** page where you can manage **Flight Control**, **Remote Controller**, **Video Link**, **Aircraft Battery**, **Gimbal** and **General Settings**. (📄 52)



REMOTE CONTROLLER SIGNAL

Displays the strength of remote controller signal. Tapping this icon opens **Remote Controller Settings**.



VIDEO LINK SIGNAL

Displays the signal strength of the WiFi Video Link (**X-Star**) or HD Video Streaming (**X-Star Premium**) between the aircraft and the remote controller. Tapping this icon will open the **Video Link Settings**.



GPS SIGNAL

Displays the current GPS signal strength.

Ready to Fly

SYSTEM STATUS

Displays the real-time status of your aircraft.

● Map Split Screen

In the FPV interference, you will see a smaller split screen at the bottom left displaying a map of the surrounding area of your aircraft. Tap on this screen to switch to the map view as shown below.



You can use your fingers to zoom in or zoom out the map for a preferred view, and also move the map to view different areas.



The three function icons on the right provide different options for you to view the map:

Icon	Name	Function
	Location	Choose the area around the home point.
		Choose the area around the aircraft's location.
	Compass	Lock/unlock the compass of the map.
	Map View	Choose a map view from Normal , Hybrid and Satellite view.

Auto-Pilot

The **Auto-pilot** function includes a series of intelligent flight modes that command your aircraft to fly in a specific pattern automatically that gives you a carefree piloting experience. Tapping (🚁) leads you to the auto-pilot options below. By tapping the **Tutorial** button, you will see the instructions for each mode:



! IMPORTANT

During auto-pilot mode, please always keep a clear path for the aircraft as it cannot avoid obstacles that come into the flight path autonomously.

● Orbit Mode

When **Orbit** mode is activated, the aircraft flies in a circle with the camera fixed on a point of interest (POI). Please follow the app to perform **Orbit**:

1. Choose a POI you prefer from below:



- **Aircraft:** The current location of the aircraft
 - **Me:** Your current location
 - **New:** Pin a new point on the map within a safe area
2. You may set the orbit radius through one of the methods as shown below and start the program.
 - A. Move your aircraft to a desired location to set the orbit radius.

POI	Orbit Radius
Aircraft	Distance between the current location of the aircraft and the later position you move the aircraft to.
Me	Distance between you and the aircraft.
New	Distance between the point you choose on the map and the location of the aircraft.

- B. Tap on the top box in the panel on the right side of the screen to input a number to manually adjust the orbit radius between the aircraft and the POI. Then decide the laps, the orbit direction (**CW/CCW**), and whether the aircraft is to hover or Go Home when **Orbit** is finished. The aircraft will automatically face the POI when you initiate **Orbit** mode. However, you can manually control the camera any time you wish. Click **Start** when ready.



3. A **Go Home Altitude** setting will pop up for you to set a safe altitude for the aircraft to perform **Go Home** at low battery level. Once you click **OK**, your aircraft will initiate auto-pilot.



4. Use the left and right command sticks to adjust the position of the aircraft as illustrated on the right side of the screen. You can also turn the aircraft's nose towards the POI (**Face POI**) or change the orbit direction (**CW/CCW**).

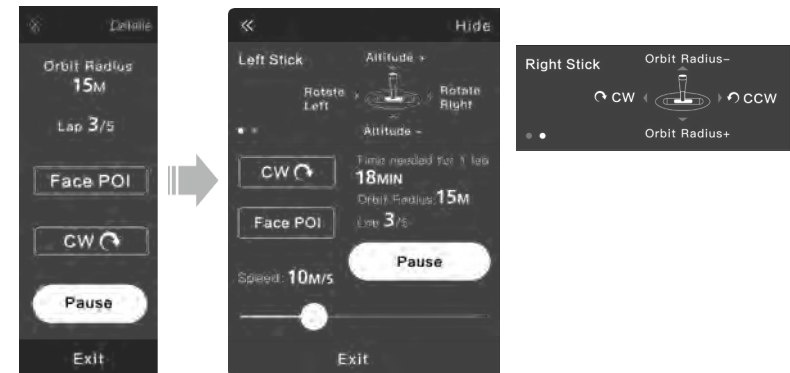

5. Tap **Pause** to let the aircraft hover, or tap **Exit** to exit **Orbit** mode.



 **NOTE**

The orbit radius can only be set between 10m and 100m. When flying beyond 100m radius centering the POI, the aircraft will switch to hover mode; when flying within 10m, the aircraft will adjust the orbit radius to 10m automatically.

● **Follow Mode**

In Follow mode, the aircraft tracks you as you move with its nose pointed at you. The speed will depend on your moving speed but cannot exceed the maximum speed of the aircraft (16m/s).

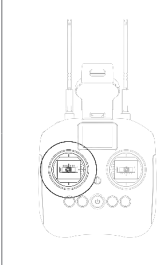
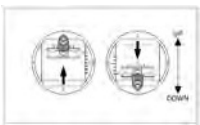
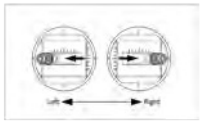
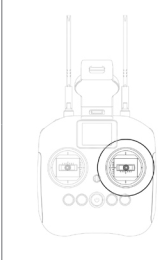
The table below illustrates how to control the relative position of the aircraft using the remote controller during Follow mode.

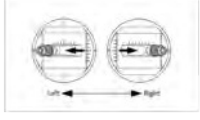
		Adjust the altitude of the aircraft.
		Change the direction of the aircraft's nose.
		Adjust the distance between you and the aircraft.
		Command the aircraft to follow you in a circular course leftward or rightward.

 **NOTE**

- **Follow** mode is valid within 100 meters radius centering the mobile device. However, the aircraft will not turn its nose towards the mobile device when the distance between them is less than 3 meters.

 **IMPORTANT**

- You cannot activate **Orbit** or **Follow** mode when the aircraft is within a 10-meter height from the home point. Once you have activated **Follow** or **Orbit** mode, the altitude limit will be cancelled.
- You can choose a location (your current position or the initial home point) for your aircraft to return to when **Failsafe** is activated in **Orbit** or **Follow** mode.
- In **Follow** or **Orbit** mode, if the GPS signal of your mobile device is too weak, the aircraft will switch to hover mode until the GPS signal quality becomes acceptable again. Follow/Orbit mode will be cancelled automatically after 15 seconds of poor GPS reception of the mobile device.

● **Waypoint Mode**

This mode allows the aircraft to fly in a preset route according to the waypoints you have set. You can command the aircraft to fly along the route you have saved in **My Favourite Routes**, or create a new route.

 **IMPORTANT**

For **X-Star Premium**, you can use this function directly and the map will be downloaded automatically. For **X-Star**, if you use the app on an Android mobile device, you need to download the map before using this function for the first time; this is not necessary if you use an iOS device, as the iOS system allows simultaneous connection with the aircraft self-generated WiFi network and the 3G/4G network.

➤ **To download the map on X-Star**

1. Disconnect your mobile device from the X-Star WiFi network.
2. Connect your mobile device to the Internet and enter the map from Map Split Screen to download the map.
3. Connect your mobile device to the X-Star WiFi network again and come back to this function.

➤ **To perform Waypoint mode**

1. Choose one of the following 3 ways to set up your waypoints.
 - **Aircraft** - Select **Aircraft** from the drop-down box of **Waypoint Location**. Move your aircraft to a target position and tap **Mark Waypoint** to set it as one of your waypoints. The rest of your waypoints can be done in the same manner. The **Delete Waypoint** button is used to remove the last waypoint you set. When you

have confirmed all the waypoints, tap **Finish**.



- **Draw on Map** - Select **Draw on Map** from the drop-down box of **Waypoint Location** and your screen will be switched to the map. Move your finger to draw a route on the map, and the waypoints will be identified automatically according to your route. The **Clear Waypoints** button is used to delete the entire route. When you have confirmed your route, tap **Finish**.



- **Point on Map** - Select **Point on Map** from the drop-down box of **Waypoint Location** and your screen will display the map. Tap on the map to pin down up to 15 waypoints and they will be linked automatically as a route. Tapping **Delete Waypoint** can remove the last waypoint you pinned down. When you have confirmed all the waypoints, tap **Finish**.



NOTE

To edit a selected waypoint before **Finish**, tap on the waypoint you wish to edit and **Waypoint Settings** will pop up. You can then set the waypoint altitude, hover duration, and decide whether to delete the waypoint.



2. Choose whether the aircraft will **Hover** or **Go Home** upon task completion, and adjust the aircraft's flight speed before **Start**.



3. Set a safe altitude for the aircraft to perform **Go Home** at low battery level.



4. When the aircraft is performing a **Waypoint** mission, you can make adjustments with the panel on the right side of the screen. The **Exit** button is used to exit this mode. Tapping (☆) on the upper right corner will save the current route into **My Favourite Routes**.



TIPS

To terminate the **Waypoint** mission at any point, perform one of the following actions:

- Regain control of the aircraft by sliding the **Flight Mode Switch** on the remote controller to **ATTI** position. (Only available when **ATTI** is enabled on the app) The aircraft will terminate the mission and respond to the remote controller.
- Press (🏠) on the remote controller and hold for 2 seconds. The aircraft will terminate the mission and land at the home point.
- Push the left command stick (Mode 2) upward to the position of 90% in range and hold for 2 seconds. This is the same with the method to regain control of the aircraft during **Go Home**. (📖 33)

Settings

Tapping the Settings icon (⚙️) on the **General Information Bar** allows you to adjust 6 categories of settings displayed on this menu, including **Flight Control Settings** (🛩️), **Remote Controller Settings** (📶), **Video Link Settings** (📹), **Aircraft Battery Settings** (🔋), **Gimbal Settings** (📷) and **General Settings** (☰).

• Flight Control Settings

You can also enter this section by tapping (🛩️) on the **Flight Control Panel**. In **Flight Control Settings**, you can manage the following settings:

1. Compass Calibration

Please refer to details on Page 26.

2. Beginner Mode

Slide this button to enable or disable **Beginner Mode**. This mode has a fixed maximum flight altitude (30m), distance (30m) and speed (horizontal: 6m/s, ascent: 3m/s, descent: 1m/s) designed to keep beginners' flights safe.

🔗 NOTE

When **Beginner Mode** is activated, the motors cannot be started in non-GPS mode.

3. Flight Speed

Set a horizontal speed when **Beginner Mode** is disabled. (default: 15m/s)

4. Altitude Limit

Set a maximum altitude for your flight when **Beginner Mode** is disabled to protect the aircraft from losing signal or flying out of sight. (default: 120m)

5. Distance Limit

Slide this button to enable or disable the default distance limit (800m) when **Beginner Mode** is disabled.

🔗 NOTE

When the altitude and distance limits are determined, the aircraft cannot fly outside the preset boundaries under GPS mode. In non-GPS mode, the aircraft is only restricted to the preset altitude limit; the distance limit under non-GPS mode may vary depending on the regulations and laws in different areas and countries.

6. Go Home Altitude

Set a safe altitude for your aircraft to **Go Home** automatically in case of an emergency. If you set the **Go Home Altitude** to a certain value, the aircraft will adjust its altitude to this value before returning to the home point. The default **Go Home Altitude** is 30m.

7. Advanced Settings

• Enable ATTI Mode

Switch this button on so you can activate **ATTI** mode on the remote controller directly, as this mode is disabled by default to prevent accidental disabling of GPS mode.

• IOC Mode

You can choose from **Home Lock** and **Course Lock** as you need. (📖 32)

- **Front LED Indicator Lights**

Slide this button to turn on or turn off the two red front LED indicator lights. These LEDs help you to identify the aircraft's nose direction during flight.

- **Starpoint Positioning System**

Slide this button to enable or disable the **Starpoint Positioning System**. (📍 35).

- **Read Flight Data**

Connect your aircraft to a computer with a USB cable to read the flight data. Then you need to reboot the aircraft before use.

- **Remote Controller Settings**

You can also enter this section by tapping (📱) on the **General Information Bar**. The **Remote Controller Settings** function grants access to Gimbal Pitch Dial Speed, RC Binding, RC Calibration, Command Stick Mode and RC Language Settings.

1. **Gimbal Pitch Dial Speed**

Slide the scroll bar left or right to adjust the speed of the **Gimbal Pitch Dial** on the remote controller.

2. **RC Calibration**

This function includes the calibration of the **Left Command Stick**, **Right Command Stick** and **Gimbal Pitch Dial**. You will only need to calibrate your remote controller when using it for the first time or after your remote controller has been replaced.

The horizontal bar on the upper part of the screen represents the Pitch Control Dial, and the two crossed bars on the sides represent the left and right command sticks.

➤ **To calibrate the remote controller**

- I. Release the two command sticks and the Gimbal Pitch Dial to their central position and tap **Start**.

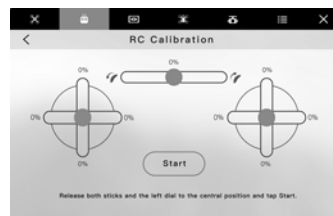

- II. Push both command sticks and the Gimbal Pitch Dial to their complete range of motion. The progress bars will be in response to your calibration. Below is an example for illustration.

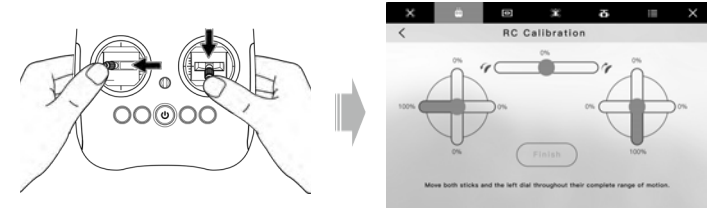

III. After each bar has been highlighted 100%, tap **Finish** and your remote controller calibration is completed.

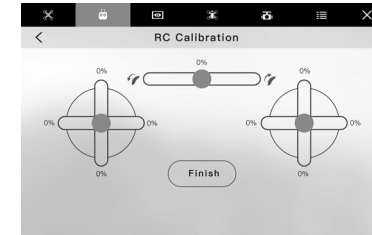

3. **RC Binding**

When any part of the devices has been replaced, you need to bind your remote controller and the aircraft. Press the **Bind** button and then hold the **RC Binding Button** on the aircraft for 3s as shown on the screen. You will be prompted when this is done successfully.

4. **Command Stick Mode**

Choose a command stick mode to control your aircraft. There are 3 modes available: Mode 1, Mode 2 and Mode 3. Each mode controls the aircraft differently. Below are the illustrations of these 3 modes.

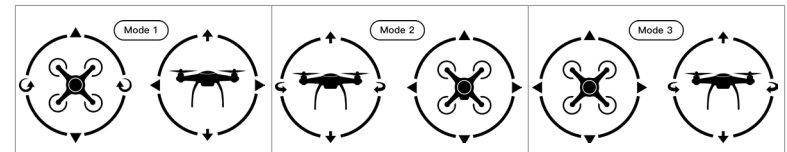

Indicator Icons		Aircraft Movement	
↑	↓	Ascend	Descend
↶ / ↷	↷ / ↶	Nose rotates left	Nose rotates right
▲	▼	Move forward	Move backward
◀	▶	Move left	Move right

5. **RC Language**

Set your preferred language displayed on the LCD **Flight Information Panel**.

● Video Link Settings

For the **X-Star**, you can rename the WiFi SSID and reset the password in this section.

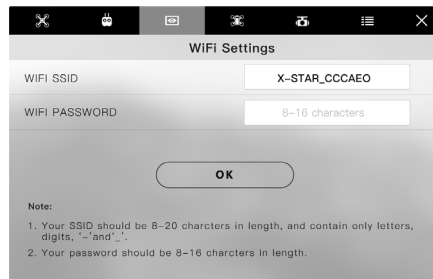

🔧 NOTE

To reset the WiFi video link, toggle the **Flight Mode Switch** back and forth quickly for at least 4 times. The remote controller will make a beep sound when the WiFi SSID and password have been reset to the default values.

For the **X-Star Premium**, you can check the noise condition of each channel and choose the one with minimum noise.

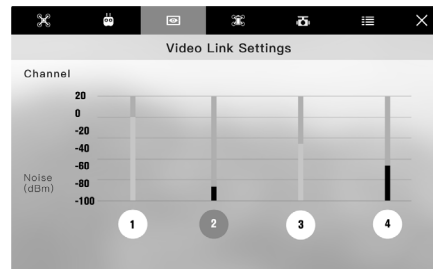

● Aircraft Battery Settings

You can also enter this section by tapping (🔋) on the **Aircraft Status Bar**. This function allows you to view the current status and general information of the aircraft battery. **Low Battery Warning** and **Critical Low Battery Warning** settings are also available in this section.

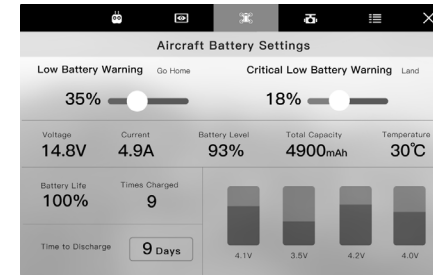

🔧 NOTE

For your own safety, the **Low Battery Warning** cannot be set below 25%, i.e., the minimum battery level for Go Home; and the **Critical Low Battery Warning** cannot be set below 15%, i.e., the minimum battery level for landing.

● Gimbal Settings

This section allows you to adjust gimbal settings.

1. Gimbal Mode

Choose a working mode for your gimbal from **Stabilized** mode and **PFV** mode. (📷 8)

2. Gimbal Auto Calibration

Make sure your aircraft is levelled and the motors are not started. Then tap **Calibrate** to start an automatic calibration of the gimbal. This helps to keep the gimbal levelled and steady for smooth photographing and filming.

🔧 NOTE

Do NOT move or turn off your aircraft during this procedure. Reboot the aircraft when the auto calibration has been finished.

3. Default Gimbal Angle

The gimbal angle is set as 0° by default. You can change the default gimbal angle in the range between 0° and 90°. There are some shortcuts to change the gimbal's tilt angle: tap **Forward** to command the camera to face forward horizontally; tap **Default** and the gimbal will come back to the default angle you set; tap **Downward** to command the camera to face downward vertically.

● General Settings

1. Parameter Unit

Choose your preferred unit system: **Imperial** or **Metric**.

2. Voice Prompt

Slide this button to enable or disable the voice prompt.

3. Tutorial

Slide this button to display or hide tips displayed before your operation.

4. Map

• Show Flight Route

Slide this button to display or hide your flight route on the map.

• Calibrate Coordinates (For Mainland China)

Slide this button to enable or disable the map calibration.

• Background Caching

Slide this button to enable or disable map caching in the background.

• Clear Flight Route

Clear your flight route on the map.

5. YouTube Live Streaming

Slide this button to enable or disable the real-time YouTube streaming.

6. Video Cache

• Cache Video While Recording

Slide this button to enable or disable video cache while recording.

• Auto Clear Cache (over 2 GB)

Slide this button to enable or disable automatic deleting of video cache when its volume exceeds 2GB.

7. Firmware Version

View the firmware version of different components.

8. About

View your **Starlink** version.

Firmware Upgrade

To optimize the performance of your **X-Star/X-Star Premium**, the firmware updates will be provided when necessary. You can download the latest firmware (Flight Control, Gimbal, Camera, Remote Controller, etc.) in one package from our official website. When a firmware update is available, you will be prompted by the app once it is connected to the aircraft.

! IMPORTANT

Before updating, please make sure:

- The four motors have stopped completely.
- The battery level of both your aircraft and remote controller is not less than 50%.
- There is enough space available in your camera's SD card to store the firmware upgrade data.

➤ To download and upgrade the firmware

1. Download the all-in-one firmware upgrade package from Autel Robotics' official website: www.autelrobotics.com.
2. Insert the SD card into your computer and extract the downloaded file into your SD card. Then remove your SD card from the computer.
3. Turn on the remote controller and aircraft.
4. Insert the SD card into the aircraft to start the upgrade process automatically. You can check the real-time upgrade status displayed on the **Flight Information Panel**.
5. Reboot all of the devices before use.

NOTE

- The upgrade process lasts about 30 minutes. Do not turn off any device or take out your SD card from the camera during the process. Do not start the motors.
 - After the upgrade is complete, the remote controller may be unbound with the aircraft and you will need to rebind the devices.
-

Troubleshooting Tips

Should you have any issues operating the product, read this section for possible solutions.

When the aircraft indicates failure during self-check *(with 4 LED lights flashing quickly in red and the buzzers beep continuously)*

- Check if the remote controller parameters are properly calibrated

When the aircraft motors fail to start up

- Check if the remote controller and the aircraft are properly bound
- Check if the remote controller parameters are properly calibrated

When take-off fails after motors start

- Make sure the **Flight Mode Switch** is not in the **GPS** position if there are less than 6 GPS satellites
- Check if the battery level is above 15%
- Check if the aircraft is in a no-fly zone
- Make sure the aircraft is placed on a flat, leveled surface

When the aircraft's flight time reduces

- This is possibly due to low temperature of the operating environment or increased take-off weight

When pairing up, the aircraft does not respond to the remote controller

- Make sure there are no metal objects, wireless sources or other remote controllers around

If Video link fails or disconnects frequently

- Make sure your aircraft and remote controller are free from all magnetic or signal interferences

If the camera is powered off during video recording

- Keep the Micro-SD card inside the camera. Restart the camera and wait until the video files are recovered (partial data may be lost)

If acquisition of the SSID fails

- Check if both the aircraft and the remote controller are powered on
- Make sure WiFi is enabled on the mobile device

If the aircraft is out of sight and the video link is lost

- Enable **Go Home** procedure to have the aircraft automatically return or activate **IOC** procedure (**Home Lock**) to manually navigate it to return

If the camera fails to be synchronized with the mobile device

- Check if your mobile device supports synchronization of the 1080P/60fps video files
- If the video size is too large, it cannot be synchronized to the mobile device
- Check if your mobile device is connected to the **X-Star/X-Star Premium** network

If the mobile app is accidentally closed when the aircraft is executing a Waypoint mission

- If the app is closed when the flight mission is under execution, the aircraft will continue to execute the given command
- If the app is closed when the flight mission is being suspended, and fails to reconnect with the aircraft in 1 minute, the **Go Home** procedure will be automatically activated
- You can regain manual control of the aircraft using the remote controller at any time

Storage and Maintenance Instructions

To ensure optimum performance of the product, we advise you read and follow the maintenance instructions in this section carefully.

- Keep the devices in a clean, dry and ventilated environment within normal operating temperatures.
- Keep the devices out of sunlight when not in use
- Dry your hands before using the devices.
- Use a soft cloth with alcohol or a mild window cleaner to clean the lens of the camera, instead of any abrasive cleansers, detergent or chemicals.
- Ensure that the battery charger does not come in contact with conductive material.
- Avoid dropping your devices, especially on a hard surface. Check it in detail after any crash or impact, and contact a local Autel Robotics agent in time if you have any problem.

- Only use the battery chargers or other accessories authorized by Autel Robotics. Failure to do so may void the warranty.

Customer Service

This section contains information regarding technical support, repair service, and application for replacements or optional parts.

Technical Support

If you have any questions or concerns regarding our products, please contact us by:

- Telephone: (844)-898-0290 (U.S.A.)
- Email: support@autelrobotics.com
- In person: local distributors or agents

Repair Service

If it is necessary to return your device for repair, please fill in and submit the repair service form on <http://www.autelrobotics.com>. The following information is required:

- Contact name
- Email address
- Mailing address
- Telephone number
- Product name
- Complete description of the problem with photo attachments
- Proof-of-purchase for warranty repairs
- Preferred method of payment for non-warranty repairs

Autel Robotics' support team will review your application within 48 hours after receiving your application. After a preliminary evaluation of the problem, our customer support will contact you for further updates or follow-ups.

6 Warranty

Autel Robotics (the Company) warrants to the original retail purchaser of this product, that should this product or any part thereof during normal consumer usage and conditions, be proven defective in material or workmanship that results in product failure within the valid warrant period from the date of purchase, such defect(s) will be repaired, or replaced (with new or refurbished parts or products) at the Company's option, with Proof of Purchase, without charge for parts or labor directly related to the defect(s). Some states do not allow limitation on how long an implied warranty lasts, so the above limitations may not apply to you.

The Company shall not be liable for any incidental or consequential damages arising from the use, misuse, or mounting of the device. The extent of Autel Robotics' liability under this warranty is limited to the repair and replacement provided above and, in no event, shall its liability exceed the purchase price paid by purchaser for the product.

Please visit www.autelrobotics.com for details of the limited periods warranted for the different parts of this product.

This warranty does not apply to:

- Battery that cycle charged more than 200 times;
- Products subjected to abnormal use or environmental conditions, accident, mishandling, neglect, unauthorized alteration, misuse, improper installation or repair, or improper storage;
- Products with signs of tempering or altering of the serial number label, waterproof mark, etc.;
- Damage resulting from connection to, or use of any accessory or other product not approved or authorized by the Company;
- Defects in appearance, cosmetic, decorative or structural items such as framing and non-operative parts.
- Products damaged from external causes including but not limited to fire, water, dirt, sand, battery leakage, blown fuse, theft or improper usage of any electrical source.

Appendix

Regulatory Compliance and Flight Restricted Area

Compliance and Advisory

Warning

Any Changes or modifications not expressly approved by the party responsible for compliance could void the user's authority to operate the equipment.

FCC Compliance

This device complies with Part 15 of the FCC rules. Operation is subject to the following two conditions: (1) This device may not cause harmful interference, and (2) this device must accept any interference received, including interference that may cause undesired operation.

FCC Radiation Exposure Statement

This device abides by FCC radiation exposure limits releasing for an uncontrolled environment. The minimum distance between the radiator and the user is designed to be 20cm when the aircraft and its accessories are in function. It is also forbidden to co-ordinate any other transmitter or antenna with this transmitter in use.

Autel Robotics announces that the X-Star and X-Star Premium are in compliance with the essential requirements and other relevant provisions of Directive 1995/5/EC.

IC RSS Warning

This device complies with Industry Canada license-exempt RSS standard(s). Operation is subject to the following two conditions: (1) This device may not cause harmful interference, and (2) this device must accept any interference, including interference that may cause undesired operation of the device.

IC Radiation Exposure Statement

This equipment complies with IC RF radiation exposure limits set forth for an uncontrollable environment. This transmitter must not be co-located or operating in conjunction with any other antennas or transmitter. This equipment should be installed and operated with at least 20cm between the radiator and your body.

Any changes or modifications not expressly approved by the party responsible for compliance could void the user's authority to operate the equipment.

Flight Restricted Area Illustration

The X-Star and X-Star Premium system automatically recognizes the Flight Restricted Area, in which flights are limited by default. This feature guarantees

pilots' safe and legal operations of the product. The flight restricted areas are divided into 2 protection categories.

Category I: Major airports and flight areas where manned aircrafts operate at low altitudes

- **Take-off Restricted Zones (No-Fly Zones)**

These areas are set within 2.4km around the central point of specified airports.

- **Altitude Restricted Zones**

In these areas, the aircraft is only allowed to fly within limited altitudes. From 8km to 2.4km around the airport's central point, the flight altitude decreases progressively from 120m to 10.5m.

- **Warning Zones**

Once the aircraft enters a region within 8.1 km from the central point of the airport, the app will prompt a warning message.

NOTE

If the aircraft enters any **Altitude Restricted Zones**, its maximum allowable altitude will be reduced accordingly. If the aircraft enters any **Take-off Restricted Zones**, it will land automatically. You should pay special attention to the warning messages displayed on your app.

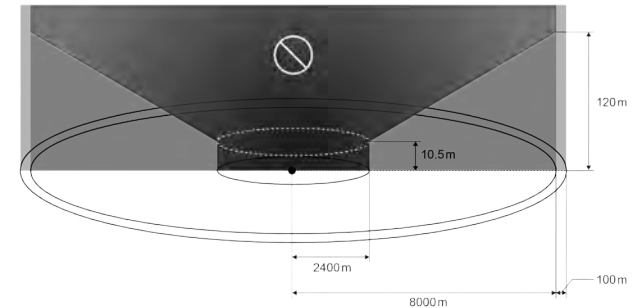

Category II: Sensitive areas and institutes such as military sites and border lines between countries

- **Take-off Restricted Zones (No-Fly Zones)**

These areas are set within 1km around the center of the specified sites where take-off and flight are prohibited.

- **Warning Zone**

Once the aircraft enters the region within 2km from the center of the site, the

app will prompt a warning message.

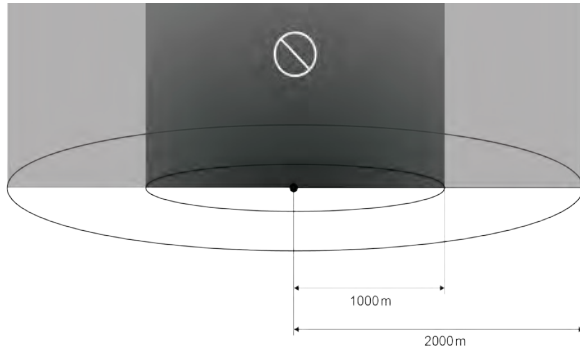

Technical Specifications

Aircraft Specifications

Hover Precision	Horizontal: ±2m; Vertical: ±1m;
Max. Yaw Rate	150°/s
Max. Inclination Angle	GPS Mode: 20°; ATTI Mode: 30°
Max. Ascent/Descent Speed	Ascent: 6m/s; Descent: 3m/s
Max. Horizontal Speed	15m/s
Diagonal Wheelbase	352mm
Propeller Size	9.4"x5.5"
Video Link Frequency	X-Star (WiFi): 2.412GHz~2.462GHz X-Star Premium(HD Video): 902MHz~928MHz
Receiver Frequency	5.727GHz~5.799GHz
Flight Modes	GPS, ATTI, IOC
Operating Environment Temperature	0°C~40°C (32°F~104°F)
Storage Temperature	-20°C~80°C (-4°F~176°F)
Weight (Battery & Propellers included)	1.42kg

Aircraft Battery Specifications

Battery Type	Rechargeable Li-Po battery
Capacity	4900mAh
Battery Voltage	14.8V

Charging Environment Temperature	10°C~45°C (50°F~113°F)
Discharging Environment Temperature	-20°C~60°C (-4°F~140°F)
Storage Temperature & Humidity	Temp: -10°C~45°C (14°F~113°F); Humidity: 5~70%

Camera Gimbal Specifications

Operating Current	650mA@12V (Non-video Mode) 760mA@12V (Video Mode)
Input Voltage	12V
Operating Temperature	-10°C~50°C
Weight	175g (Camera incl.)
Dimensions (Damping Device excl.)	88mm X 76.5mm X 80mm
Control Accuracy	Pitch: ±0.015° Roll: ±0.02° Yaw: ±0.02°
Max. Angular Velocity	Pitch: ±300°/S Yaw: ±360°/S
Controllable Range	Pitch: 0°~90° Yaw: ±50°

Camera Specifications

Operating Environment Temperature	0°C~40°C (32°F~104°F)
Still Photography Modes	Single shot Burst shooting: 3/5/7 frames Auto Exposure Bracketing (AEB): 3/5 Bracketed frames at 0.7EV Bias Time-lapse
Video Recording Modes	UHD: 4096x2160p 24/25, 3840x2160p 24/25/30 QHD: 2704x1520p 24/25/30 FHD: 1920x1080p 24/25/30/48/50/60/120 HD: 1280x720p 24/25/30/48/50/60/240 SUPERVIEW: 1920x1080p 24/25/30/48/50/60
Max. Field of View	108°
Supported SD Card Types	Micro-SD card Storage capacity: 4GB - 64GB Class level: Class 10 or UHS-1 rating required

File Formats	FAT32/exFAT Photo: JPG/DNG/JPG+DNG Video: MOV/MP4
--------------	---

Remote Controller Specifications		
RF Receiver Operating Frequency	5.727GHz~5.799GHz	
Video Link Frequency	X-Star	2.412GHz~2.462GHz
	X-Star Premium	902MHz~928MHz (America)
		915MHz~928MHz (Australia)
Operating Temperature	0°C~50°C	
Storage Temperature	Less than 3 months: -20°C~45°C More than 3 months: 22°C~28°C	
Communication Distance (Open Area)	X-Star	CE: 400m; FCC: 1000m
	X-Star Premium	FCC: 2000m
Operating Current/Voltage	X-Star	750mA/3.7V
	X-Star Premium	350mA/3.7V (App disconnected)
		1400mA/3.7V (App connected)
Battery	6000mAh rechargeable Li-Ion Battery	
Power Consumption	X-Star	2.8W
	X-Star Premium	5.2W
Weight (battery included)	X-Star	830g
	X-Star Premium	840g

IC Warning

This device complies with Industry Canada licence-exempt RSS standard(s). Operation is subject to the following two conditions:

- (1) this device may not cause interference, and
- (2) this device must accept any interference, including interference that may cause undesired operation of the device.

Le présent appareil est conforme aux CNR d'Industrie Canada applicables aux appareils radio exempts de licence. L'exploitation est autorisée aux deux conditions suivantes :

- (1) l'appareil n' doit pas produire de brouillage, et*
- (2) l'utilisateur de l'appareil doit accepter tout brouillage radioélectrique subi, même si le brouillage est susceptible d'en compromettre le fonctionnement.*

The remote (EF5B) is compliance with RF exposure guidelines, users can obtain Canadian information on RF exposure and compliance. Le présent appareil est conforme Après examen de ce matériel aux conformité ou aux limites d'intensité de champ RF, les utilisateurs peuvent sur l'exposition aux radiofréquences et la conformité and compliance d'acquérir les informations correspondantes.

The aircraft (X-Star) is compliance with RF exposure guidelines, users can obtain Canadian information on RF exposure and compliance. The minimum distance from body to use the device is 20cm. Le présent appareil est conforme Après examen de ce matériel aux conformité ou aux limites d'intensité de champ RF, les utilisateurs peuvent sur l'exposition aux radiofréquences et la conformité and compliance d'acquérir les informations correspondantes. La distance minimale du corps à utiliser le dispositif est de 20cm.