

# TEST REPORT

**Applicant Name :** Autel Robotics Co., Ltd.  
**Address :** 9th Floor, Bldg.B1, Zhiyuan, 1001 Xueyuan Rd. Xili, Nanshan, Shenzhen, China  
**Report Number :** CR21090095-SA  
**FCC ID:** 2AGNTEFA2409A  
**IC:** 20910-EFA2409A

## Test Standard (s)

FCC Part 2.1093

## Sample Description

**Product Type:** Remote Control  
**Model No.:** EFA  
**Date Received:** 2021/11/10  
**Date of Test:** 2021/11/19~2021/11/21  
**Report Date:** 2021/11/22

Test Result:	Pass*
--------------	-------

\* In the configuration tested, the EUT complied with the standards above.

## Prepared and Checked By:



Lance Li  
 EMC Engineer

## Approved By:



Candy Li  
 EMC Engineer

Note: This report may contain data that are not covered by the A2LA accreditation and are marked with an asterisk "\*" .

Shenzhen Accurate Technology Co., Ltd. is not responsible for the authenticity of any test data provided by the applicant. Data included from the applicant that may affect test results are marked with an asterisk "\*". Customer model name, addresses, names, trademarks etc. are not considered data.

This report cannot be reproduced except in full, without prior written approval of the Company. Unless otherwise stated the results shown in this test report refer only to the sample(s) tested. This report is valid only with a valid digital signature. The digital signature may be available only under the Adobe software above version 7.0.

## Shenzhen Accurate Technology Co., Ltd.

1/F., Building A, Changyuan New Material Port, Science & Industry Park, Nanshan District, Shenzhen, Guangdong, P.R. China  
 Tel: +86 755-26503290 Fax: +86 755-26503396 Web: www.atc-lab.com

Attestation of Test Results			
<b>EUT Information</b>	<b>EUT Description</b>	Remote Control	
	<b>Tested Model</b>	EFA	
	<b>FCC ID</b>	2AGNTEFA2409A	
	<b>IC</b>	20910-EFA2409A	
	<b>Serial Number</b>	CR21090095-SA-S1	
	<b>Test Date</b>	2021/11/19 ~ 2021/11/21	
<b>MODE</b>		<b>Max. SAR Level(s) Reported(W/kg)</b>	<b>Limit (W/kg)</b>
<b>SRD 2.4G</b>	10g Extremity SAR	0.94	<b>4.0</b>
<b>SRD 5.2G</b>	10g Extremity SAR	1.10	
<b>SRD 5.8G</b>	10g Extremity SAR	<b>1.92</b>	
<b>Simultaneous</b>	10g Extremity SAR	<b>3.19</b>	
<b>SRD 2.4G</b>	1g Body SAR	0.73	<b>1.6</b>
<b>SRD 5.2G</b>	1g Body SAR	0.20	
<b>SRD 5.8G</b>	1g Body SAR	<b>0.82</b>	
<b>Simultaneous</b>	1g Body SAR	<b>1.51</b>	
<b>Applicable Standards</b>	<b>FCC 47 CFR part 2.1093</b> Radiofrequency radiation exposure evaluation: portable devices		
	<b>RSS-102 Issue 5 March 2015</b> Radio Frequency (RF) Exposure Compliance of Radio communication Apparatus (All Frequency Bands).		
	<b>RF Exposure Procedures: TCB Workshop April 2019</b>		
	<b>IEC/IEEE 62209-1528:2020</b> Measurement procedure for the assessment of specific absorption rate of human exposure to radio frequency fields from hand-held and body-mounted wireless communication devices – Part 1528: Human models, instrumentation, and procedures (Frequency range of 4 MHz to 10 GHz)		
	<b>KDB procedures</b> KDB 447498 D01 General RF Exposure Guidance v06. KDB 865664 D01 SAR Measurement 100 MHz to 6 GHz v01r04 KDB 865664 D02 RF Exposure Reporting v01r02 KDB 941225 D07 UMPC Mini Tablet v01r02		
<b>Note:</b> This wireless device has been shown to be capable of compliance for localized specific absorption rate (SAR) for General Population/Uncontrolled Exposure limits specified in <b>FCC 47 CFR part 2.1093/RSS-102 Issue 5 March 2015</b> and has been tested in accordance with the measurement procedures specified in IEEE 1528-2013 and RF exposure KDB procedures.			
<b>The results and statements contained in this report pertain only to the device(s) evaluated.</b>			

## TABLE OF CONTENTS

**DOCUMENT REVISION HISTORY**..... 4

**EUT DESCRIPTION** ..... 5

TECHNICAL SPECIFICATION ..... 5

**REFERENCE, STANDARDS, AND GUIDELINES**..... 6

SAR LIMITS..... 7

**FACILITIES** ..... 8

**DESCRIPTION OF TEST SYSTEM**..... 9

**EQUIPMENT LIST AND CALIBRATION**..... 14

EQUIPMENTS LIST & CALIBRATION INFORMATION..... 14

**SAR MEASUREMENT SYSTEM VERIFICATION** ..... 15

LIQUID VERIFICATION ..... 15

SYSTEM ACCURACY VERIFICATION..... 17

SAR SYSTEM VALIDATION DATA..... 18

**EUT TEST STRATEGY AND METHODOLOGY**..... 21

TEST POSITIONS FOR DEVICE OPERATING NEXT TO A PERSON’S EAR ..... 21

CHEEK/TOUCH POSITION ..... 22

EAR/TILT POSITION ..... 22

TEST POSITIONS FOR BODY-WORN AND OTHER CONFIGURATIONS..... 23

TEST DISTANCE FOR SAR EVALUATION..... 23

SAR EVALUATION PROCEDURE ..... 24

**CONDUCTED OUTPUT POWER MEASUREMENT** ..... 25

PROVISION APPLICABLE ..... 25

TEST PROCEDURE ..... 25

MAXIMUM TARGET OUTPUT POWER ..... 25

TEST RESULTS:..... 25

**STANDALONE SAR TEST EXCLUSION CONSIDERATIONS**..... 27

ANTENNAS LOCATION: ..... 27

ANTENNA DISTANCE TO EDGE..... 27

STANDALONE SAR TEST EXCLUSION CONSIDERATIONS(KDB) ..... 27

STANDALONE SAR TEST EXCLUSION CONSIDERATIONS(RSS 102)..... 28

STANDALONE SAR TEST EXCLUSION CONSIDERATIONS(KDB): ..... 29

STANDALONE SAR TEST EXCLUSION CONSIDERATIONS(RSS 102):..... 30

SAR TEST EXCLUSION FOR THE EUT EDGE CONSIDERATIONS RESULT(RSS 102) ..... 31

**SAR MEASUREMENT RESULTS** ..... 32

SAR TEST DATA ..... 32

**SAR MEASUREMENT VARIABILITY**..... 43

**SAR SIMULTANEOUS TRANSMISSION DESCRIPTION**..... 44

**SAR PLOTS** ..... 46

**APPENDIX A MEASUREMENT UNCERTAINTY** ..... 47

**APPENDIX B EUT TEST POSITION PHOTOS**..... 48

**APPENDIX C PROBE CALIBRATION CERTIFICATES**..... 49

**APPENDIX D DIPOLE CALIBRATION CERTIFICATES** ..... 50

**DOCUMENT REVISION HISTORY**

<b>Revision Number</b>	<b>Report Number</b>	<b>Description of Revision</b>	<b>Date of Revision</b>
0	CR21090095-SA	Original Report	2021-11-22

## EUT DESCRIPTION

This report has been prepared on behalf of **Autel Robotics Co., Ltd.** and their product **Remote Control**, Model: **EFA**, FCC ID: **2AGNTEFA2409A**, IC: **20910-EFA2409A** or the EUT (Equipment under Test) as referred to in the rest of this report.

*\*All measurement and test data in this report was gathered from production sample serial number: CR21090095-SA-S1 (Assigned by ATC). The EUT supplied by the applicant was received on 2021-09-27.*

### Technical Specification

<b>Device Type:</b>	Portable
<b>Exposure Category:</b>	Population / Uncontrolled
<b>Antenna Type(s):</b>	Internal Antenna
<b>Operation Mode :</b>	SRD 2.4G, SRD 5.2G, SRD 5.8G
<b>Accessories:</b>	None
<b>Frequency Band:</b>	SRD 2.4G_1.4M: 2403.5-2475.5MHz SRD 2.4G_20M: 2412.5~2462.5MHz SRD 5.2G_1.4M: 5154~5246MHz SRD 5.2G_20M: 5167~5233MHz SRD 5.8G_1.4M: 5728~5847MHz SRD 5.8G_20M: 5738~5839MHz
<b>Conducted RF Power:</b>	SRD 2.4G: 23 dBm SRD 5.2G: 11.83 dBm SRD 5.8G: 19.81 dBm
<b>Power Source:</b>	3.7 VDC Rechargeable Battery
<b>Normal Operation:</b>	Handheld and Close to Body

*Note: The band of SRD 2.4G/5.2G/5.8G is for FCC certification, and the band of SRD 2.4G/5.8G is for IC certification.*

## REFERENCE, STANDARDS, AND GUIDELINES

---

### FCC:

The Report and Order requires routine SAR evaluation prior to equipment authorization of portable transmitter devices, including portable telephones. For consumer products, the applicable limit is 1.6 mW/g as recommended by the ANSI/IEEE standard C95.1-1992 [6] for an uncontrolled environment (Paragraph 65). According to the Supplement C of OET Bulletin 65 "Evaluating Compliance with FCC Guide-lines for Human Exposure to Radio frequency Electromagnetic Fields", released on Jun 29, 2001 by the FCC, the device should be evaluated at maximum output power (radiated from the antenna) under "worst-case" conditions for normal or intended use, incorporating normal antenna operating positions, device peak performance frequencies and positions for maximum RF energy coupling.

This report describes the methodology and results of experiments performed on wireless data terminal. The objective was to determine if there is RF radiation and if radiation is found, what is the extent of radiation with respect to safety limits. SAR (Specific Absorption Rate) is the measure of RF exposure determined by the amount of RF energy absorbed by human body (or its parts) – to determine how the RF energy couples to the body or head which is a primary health concern for body worn devices. The limit below which the exposure to RF is considered safe by regulatory bodies in North America is 1.6 mW/g average over 1 gram of tissue mass.

### CE:

The order requires routine SAR evaluation prior to equipment authorization of portable transmitter devices, including portable telephones. For consumer products, the applicable limit is 2 mW/g as recommended by EN62209-1 for an uncontrolled environment. According to the Standard, the device should be evaluated at maximum output power (radiated from the antenna) under "worst-case" conditions for normal or intended use, incorporating normal antenna operating positions, device peak performance frequencies and positions for maximum RF energy coupling.

This report describes the methodology and results of experiments performed on wireless data terminal. The objective was to determine if there is RF radiation and if radiation is found, what is the extent of radiation with respect to safety limits. SAR (Specific Absorption Rate) is the measure of RF exposure determined by the amount of RF energy absorbed by human body (or its parts) – to determine how the RF energy couples to the body or head which is a primary health concern for body worn devices. The limit below which the exposure to RF is considered safe by regulatory bodies in Europe is 2 mW/g average over 10 gram of tissue mass.

The test configurations were laid out on a specially designed test fixture to ensure the reproducibility of measurements. Each configuration was scanned for SAR. Analysis of each scan was carried out to characterize the above effects in the device.

**SAR Limits****FCC Limit(1g Tissue)**

EXPOSURE LIMITS	SAR (W/kg)	
	(General Population / Uncontrolled Exposure Environment)	(Occupational / Controlled Exposure Environment)
Spatial Average (averaged over the whole body)	0.08	0.4
Spatial Peak (averaged over any 1 g of tissue)	<b>1.60</b>	8.0
Spatial Peak (hands/wrists/feet/ankles averaged over 10 g)	<b>4.0</b>	20.0

**CE Limit(10g Tissue)**

EXPOSURE LIMITS	SAR (W/kg)	
	(General Population / Uncontrolled Exposure Environment)	(Occupational / Controlled Exposure Environment)
Spatial Average (averaged over the whole body)	0.08	0.4
Spatial Peak (averaged over any 10 g of tissue)	2.0	10
Spatial Peak (hands/wrists/feet/ankles averaged over 10 g)	4.0	20.0

Population/Uncontrolled Environments are defined as locations where there is the exposure of individual who have no knowledge or control of their exposure.

Occupational/Controlled Environments are defined as locations where there is exposure that may be incurred by people who are aware of the potential for exposure (i.e. as a result of employment or occupation).

General Population/Uncontrolled environments Spatial Peak limit 4.0W/kg for 10g Extremity SAR and 1.6W/kg for 1g Body SAR applied to the EUT.

## **FACILITIES**

---

The test site used by Shenzhen Accurate Technology Co., Ltd. to collect test data is located on the 1/F., Building A, Changyuan New Material Port, Science & Industry Park, Nanshan District, Shenzhen, Guangdong, P.R. China.

The test site has been approved by the FCC under the KDB 974614 D01 and is listed in the FCC Public Access Link (PAL) database, FCC Registration No.: 708358, the FCC Designation No.: CN1189. Accredited by American Association for Laboratory Accreditation (A2LA) The Certificate Number is 4297.01 . Listed by Innovation, Science and Economic Development Canada (ISED), the Registration Number is 5077A.

The test site has been registered with ISED Canada under ISED Canada Registration Number CN0016.



## DESCRIPTION OF TEST SYSTEM

These measurements were performed with the automated near-field scanning system DASY5 from Schmid & Partner Engineering AG (SPEAG) which is the Fifth generation of the system shown in the figure hereinafter:



### DASY5 System Description

The DASY5 system for performing compliance tests consists of the following items:

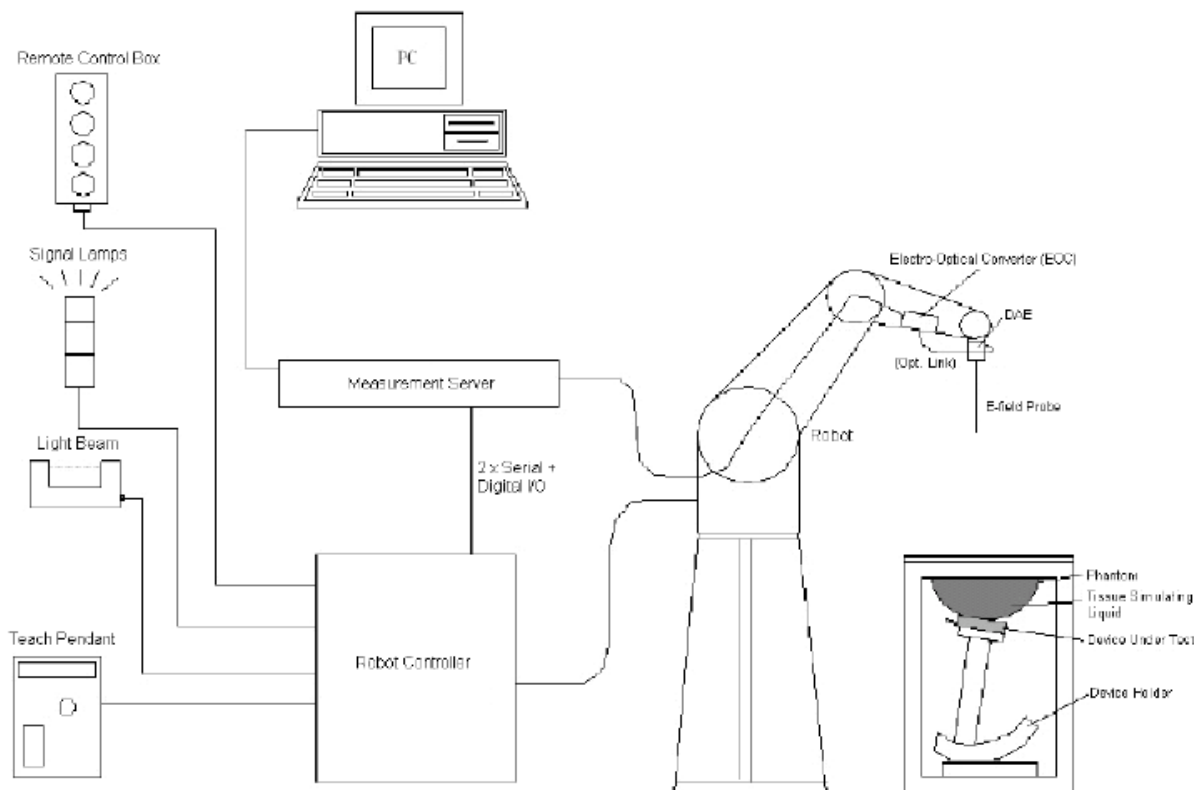

- A standard high precision 6-axis robot (Staubli TX=RX family) with controller, teach pendant and software. An arm extension for accommodating the data acquisition electronics (DAE).
- An isotropic field probe optimized and calibrated for the targeted measurement.
- A data acquisition electronics (DAE) which performs the signal application, signal multiplexing, AD-conversion, offset measurements, mechanical surface detection, collision detection, etc. The unit is battery powered with standard or rechargeable batteries. The signal is optically transmitted to the EOC.
- The Electro-optical converter (EOC) performs the conversion from optical to electrical signals for the digital communication to the DAE. To use optical surface detection, a special version of the EOC is required. The EOC signal is transmitted to the measurement server.
- The function of the measurement server is to perform the time critical tasks such as signal filtering, control of the robot operation and fast movement interrupts.
- The Light Beam used is for probe alignment. This improves the (absolute) accuracy of the probe positioning.
- A computer running Win7 professional operating system and the DASY52 software.
- Remote control and teach pendant as well as additional circuitry for robot safety such as warning lamps, etc.
- The phantom, the device holder and other accessories according to the targeted measurement.

### **DASY5 Measurement Server**

The DASY5 measurement server is based on a PC/104 CPU board with a 400 MHz Intel ULV Celeron, 128 MB chip-disk and 128 MB RAM. The necessary circuits for communication with the DAE4 (or DAE3) electronics box, as well as the 16-bit AD converter system for optical detection and digital I/O interface are contained on the DASY6 I/O board, which is directly connected to the PC/104 bus of the CPU board.

The measurement server performs all real-time data evaluations of field measurements and surface detection, controls robot movements, and handles safety operations. The PC operating system cannot interfere with these time-critical processes. All connections are supervised by a watchdog, and disconnection of any of the cables to the measurement server will automatically disarm the robot and disable all program- controlled robot movements. Furthermore, the measurement server is equipped with an expansion port, which is reserved for future applications. Please note that this expansion port does not have a standardized pinout, and therefore only devices provided by SPEAG can be connected. Connection of devices from any other supplier could seriously damage the measurement server.

### **Data Acquisition Electronics**

The data acquisition electronics (DAE4) consist of a highly sensitive electrometer-grade preamplifier with auto-zeroing, a channel and gain-switching multiplexer, a fast 16 bit AD-converter and a command decoder with a control logic unit. Transmission to the measurement server is accomplished through an optical downlink for data and status information, as well as an optical uplink for commands and the clock.

The mechanical probe mounting device includes two different sensor systems for frontal and sideways probe contacts. They are used for mechanical surface detection and probe collision detection.

The input impedance of both the DAE4 as well as of the DAE3 box is 200M $\Omega$ ; the inputs are symmetrical and floating. Common mode rejection is above 80 dB.

**EX3DV4 E-Field Probes**

<b>Frequency</b>	10 MHz to > 6 GHz Linearity: ± 0.2 dB (30 MHz to 6 GHz)
<b>Directivity</b>	± 0.3 dB in TSL (rotation around probe axis) ± 0.5 dB in TSL (rotation normal to probe axis)
<b>Dynamic Range</b>	10 µW/g to > 100 mW/g Linearity: ± 0.2 dB (noise: typically < 1 µW/g)
<b>Dimensions</b>	Overall length: 337 mm (Tip: 20 mm) Tip diameter: 2.5 mm (Body: 12 mm) Typical distance from probe tip to dipole centers: 1 mm
<b>Application</b>	High precision dosimetric measurements in any exposure scenario (e.g., very strong gradient fields); the only probe that enables compliance testing for frequencies up to 6 GHz with precision of better 30%.
<b>Compatibility</b>	DASY3, DASY4, DASY52 SAR and higher, EASY4/MRI

**SAM Twin Phantom**

The SAM Twin Phantom (shown in front of DASY5) is a fiberglass shell phantom with shell thickness 2 mm, except in the ear region where the thickness is increased to 6 mm..

When the phantom is mounted inside allocated slot of the DASY5 platform, phantom reference points can be taught directly in the DASY5 V5.2 software. When the DASY5 platform is used to mount the

Phantom, some of the phantom teaching points cannot be reached by the robot in DASY5 V5.2. A special tool called P1a-P2aX-Former is provided to transform two of the three points, P1 and P2, to reachable locations. To use these new teaching points, a revised phantom configuration file is required.

In addition to our standard broadband liquids, the phantom can be used with the following tissue simulating liquids:

Sugar-water-based liquids can be left permanently in the phantom.

Always cover the liquid when the system is not in use to prevent changes in liquid parameters due to water evaporation.

DGBE-based liquids should be used with care. As DGBE is a softener for most plastics, the liquid should be taken out of the phantom, and the phantom should be dried when the system is not in use (desirable at least once a week).

Do not use other organic solvents without previously testing the solvent resistivity of the phantom. Approximately 25 liters of liquid is required to fill the SAM Twin phantom.



## Area Scans

Area scans are defined prior to the measurement process being executed with a user defined variable spacing between each measurement point (integral) allowing low uncertainty measurements to be conducted. Scans defined for FCC applications utilize a 15mm 2 step integral, with 1.5mm interpolation used to locate the peak SAR area used for zoom scan assessments.

Where the system identifies multiple SAR peaks (which are within 25% of peak value) the system will provide the user with the option of assessing each peak location individually for zoom scan averaging.

## Zoom Scan (Cube Scan Averaging)

The averaging zoom scan volume utilized in the DASY5 software is in the shape of a cube and the side dimension of a 1 g or 10 g mass is dependent on the density of the liquid representing the simulated tissue. A density of  $1000 \text{ kg/m}^3$  is used to represent the head and body tissue density and not the phantom liquid density, in order to be consistent with the definition of the liquid dielectric properties, i.e. the side length of the 1g cube is 0mm, with the side length of the 10g cube is 21.5mm.

When the cube intersects with the surface of the phantom, it is oriented so that 3 vertices touch the surface of the shell or the center of a face is tangent to the surface. The face of the cube closest to the surface is modified in order to conform to the tangent surface.

The zoom scan integer steps can be user defined so as to reduce uncertainty, but normal practice for typical test applications (including FCC) utilize a physical step of  $7 \times 7 \times 7$  (5mmx5mmx5mm) providing a volume of 30 mm in the X & Y & Z axis.

## Recommended Tissue Dielectric Parameters for Head liquid

Table 2 – Dielectric properties of the tissue-equivalent medium

Frequency MHz	Real part of the complex relative permittivity, $\epsilon'$	Conductivity, $\sigma$ S/m	Penetration depth (E-field), $\delta$ mm
4	55,0	0,75	293,0
13	55,0	0,75	165,5
30	55,0	0,75	112,8
150	52,3	0,78	62,0
300	45,3	0,87	46,1
450	43,5	0,87	43,0
750	41,9	0,89	39,8
835	41,5	0,90	39,0
900	41,5	0,97	36,2
1 450	40,5	1,20	28,6
1 800	40,0	1,40	24,3
1 900	40,0	1,40	24,3
1 950	40,0	1,40	24,3
2 000	40,0	1,40	24,3
2 100	39,8	1,49	22,8
2 450	39,2	1,80	18,7
2 600	39,0	1,96	17,2
3 000	38,5	2,40	14,0
3 500	37,9	2,91	11,4
4 000	37,4	3,43	10,0
4 500	36,8	3,94	9,7

Frequency MHz	Real part of the complex relative permittivity, $\epsilon'$	Conductivity, $\sigma$ S/m	Penetration depth (E-field), $\delta$ mm
5 000	36,2	4,45	1,5
5 200	36,0	4,66	8,4
5 400	35,8	4,86	8,1
5 600	35,5	5,07	7,5
5 800	35,3	5,27	7,3
6 000	35,1	5,48	7,0
6 500	34,5	6,07	6,7
7 000	33,9	6,65	6,4
7 500	33,3	7,24	6,1
8 000	32,7	7,84	5,9
8 500	32,1	8,46	5,3
9 000	31,6	9,08	4,8
9 500	31,0	9,71	4,4
10 000	30,4	10,40	4,0

NOTE For convenience, permittivity and conductivity values are linearly interpolated for frequencies that are not a part of the original data from Drossos et al. [2]. They are shown in italics in Table 2. The italicized values are linearly interpolated (below 5 800 MHz) or extrapolated (above 5 800 MHz) from the non-italicized values that are immediately above and below these values.

## EQUIPMENT LIST AND CALIBRATION

### Equipments List & Calibration Information

Equipment	Model	S/N	Calibration Date	Calibration Due Date
DASY5 Test Software	DASY52 52.10.2	N/A	NCR	NCR
DASY5 Measurement Server	DASY5 6.0.31	N/A	NCR	NCR
Data Acquisition Electronics	DAE4	1354	2021/9/1	2022/8/31
E-Field Probe	EX3DV4	7329	2020/11/30	2021/11/29
Mounting Device	MD4HHTV5	SD 000 H01 KA	NCR	NCR
SAM Twin Phantom	SAM-Twin V5.0	1744	NCR	NCR
Dipole,2450MHz	D2450V2	751	2020/10/13	2023/10/12
Dipole,5GHz	D5GHzV2	1301	2020/01/10	2023/01/09
Simulated Tissue Liquid Head(500-9500MHz)	HBBL600-10000V6	180622-2	Each Time	/
Network Analyzer	8753D	3410A08288	2021/7/07	2022/7/06
Dielectric Assessment Kit	DAK-3.5	1248	NCR	NCR
Signal Generator	SMB100A	108362	2020/12/24	2021/12/23
USB wideband power sensor	U2021XA	MY52350001	2021/7/31	2022/7/30
Pre-Amplifier	PAM-0118	135	2021/01/04	2022/01/03
Directional Coupler	4223-20	3.113.277	2020/12/25	2021/12/24
6dB Attenuator	8493B 6dB Attenuator	2708A 04769	2020/12/25	2021/12/24

# SAR MEASUREMENT SYSTEM VERIFICATION

## Liquid Verification

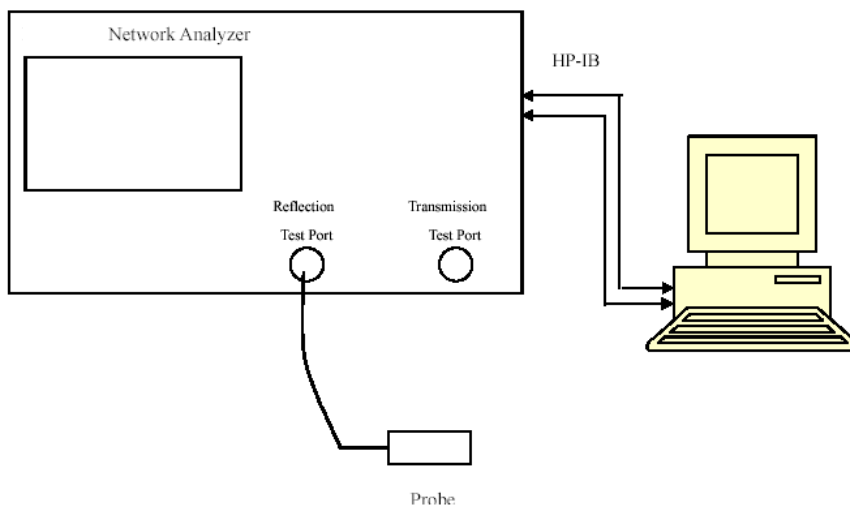

Liquid Verification Setup Block Diagram

## Liquid Verification Results

Frequency (MHz)	Liquid Type	Liquid Parameter		Target Value		Delta (%)		Tolerance (%)
		$\epsilon_r$	$\sigma$ (S/m)	$\epsilon_r$	$\sigma$ (S/m)	$\Delta\epsilon_r$	$\Delta\sigma$ (S/m)	
2403.5	Simulated Tissue Liquid	39.302	1.738	39.29	1.76	0.03	-1.25	$\pm 10$
2412.5	Simulated Tissue Liquid	39.206	1.749	39.28	1.77	-0.19	-1.19	$\pm 10$
2437.5	Simulated Tissue Liquid	39.169	1.764	39.23	1.79	-0.16	-1.45	$\pm 10$
2439.5	Simulated Tissue Liquid	39.157	1.779	39.22	1.79	-0.16	-0.61	$\pm 10$
2450	Simulated Tissue Liquid	39.126	1.812	39.2	1.8	-0.19	0.67	$\pm 10$
2462.5	Simulated Tissue Liquid	39.093	1.826	39.18	1.81	-0.22	0.88	$\pm 10$
2475.5	Simulated Tissue Liquid	39.054	1.849	39.17	1.83	-0.3	1.04	$\pm 10$

\*Liquid Verification above was performed on 2021/11/19.

Frequency (MHz)	Liquid Type	Liquid Parameter		Target Value		Delta (%)		Tolerance (%)
		$\epsilon_r$	$\sigma$ (S/m)	$\epsilon_r$	$\sigma$ (S/m)	$\Delta\epsilon_r$	$\Delta\sigma$ (S/m)	
5154	Simulated Tissue Liquid	36.244	4.628	36.05	4.61	0.54	0.39	$\pm 10$
5167	Simulated Tissue Liquid	36.122	4.649	36.03	4.63	0.26	0.41	$\pm 10$
5201	Simulated Tissue Liquid	36.037	4.667	36	4.66	0.1	0.15	$\pm 10$
5233	Simulated Tissue Liquid	35.914	4.678	35.97	4.69	-0.16	-0.26	$\pm 10$
5246	Simulated Tissue Liquid	35.861	4.703	35.95	4.71	-0.25	-0.15	$\pm 10$
5250	Simulated Tissue Liquid	35.815	4.716	35.95	4.71	-0.38	0.13	$\pm 10$

\*Liquid Verification above was performed on 2021/11/20.



Frequency (MHz)	Liquid Type	Liquid Parameter		Target Value		Delta (%)		Tolerance (%)
		$\epsilon_r$	$\sigma$ (S/m)	$\epsilon_r$	$\sigma$ (S/m)	$\Delta\epsilon_r$	$\Delta\sigma$ (S/m)	
5728	Simulated Tissue Liquid	35.394	5.223	35.37	5.2	0.07	0.44	$\pm 10$
5738	Simulated Tissue Liquid	35.365	5.237	35.36	5.21	0.01	0.52	$\pm 10$
5789	Simulated Tissue Liquid	35.355	5.243	35.31	5.26	0.13	-0.32	$\pm 10$
5790	Simulated Tissue Liquid	35.273	5.251	35.31	5.26	-0.1	-0.17	$\pm 10$
5800	Simulated Tissue Liquid	35.26	5.275	35.3	5.27	-0.11	0.09	$\pm 10$
5839	Simulated Tissue Liquid	35.215	5.289	35.26	5.31	-0.13	-0.4	$\pm 10$
5847	Simulated Tissue Liquid	35.161	5.294	35.25	5.32	-0.25	-0.49	$\pm 10$

\*Liquid Verification above was performed on 2021/11/21.



### System Accuracy Verification

Prior to the assessment, the system validation kit was used to test whether the system was operating within its specifications of  $\pm 10\%$ . The validation results are tabulated below. And also the corresponding SAR plot is attached as well in the SAR plots files.

The spacing distances in the **System Verification Setup Block Diagram** is given by the following:

- a)  $s = 15 \text{ mm} \pm 0,2 \text{ mm}$  for  $300 \text{ MHz} \leq f \leq 1\,000 \text{ MHz}$ ;
- b)  $s = 10 \text{ mm} \pm 0,2 \text{ mm}$  for  $1\,000 \text{ MHz} < f \leq 3\,000 \text{ MHz}$ ;
- c)  $s = 10 \text{ mm} \pm 0,2 \text{ mm}$  for  $3\,000 \text{ MHz} < f \leq 6\,000 \text{ MHz}$ .

### System Verification Setup Block Diagram

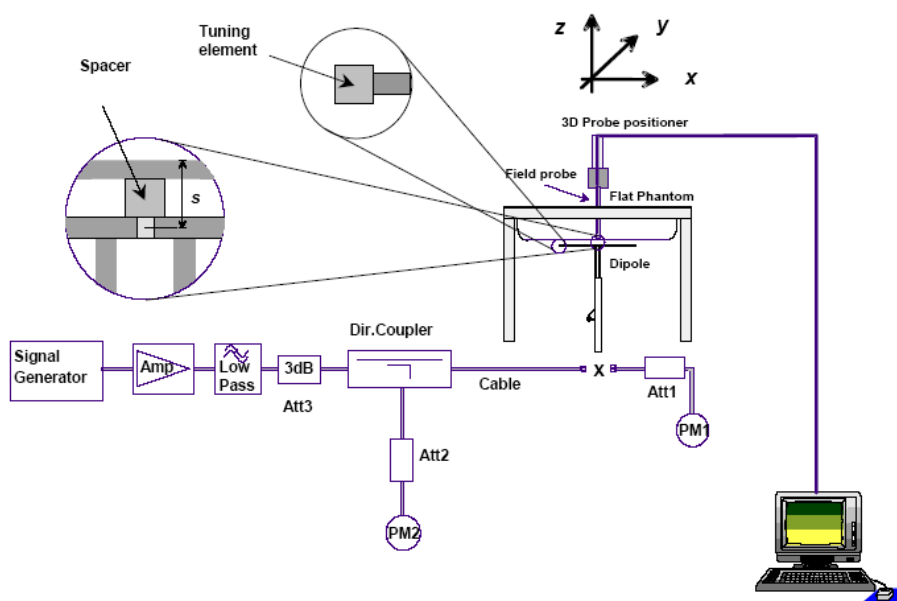

### System Accuracy Check Results

Date	Frequency Band	Liquid Type	Input Power (mW)	Measured SAR (W/kg)		Normalized to 1W (W/kg)	Target Value (W/kg)	Delta (%)	Tolerance (%)
2021/11/19	2450 MHz	Head	100	1g	5.11	51.1	53	-3.58	$\pm 10$
				10g	2.34	23.4	24.4	-4.1	$\pm 10$
2021/11/20	5250 MHz	Head	100	1g	7.86	78.6	80.7	-2.6	$\pm 10$
				10g	2.19	21.9	23	-4.78	$\pm 10$
2021/11/21	5800 MHz	Head	100	1g	8.04	80.4	80.2	0.25	$\pm 10$
				10g	2.29	22.9	22.6	1.33	$\pm 10$

\*The SAR values above are normalized to 1 Watt forward power.

**SAR SYSTEM VALIDATION DATA**

**System Performance 2450MHz**

**DUT: D2450V2; Type: 2450 MHz; Serial: 751**

Communication System: CW; Frequency: 2450 MHz;Duty Cycle: 1:1  
 Medium parameters used:  $f = 2450 \text{ MHz}$ ;  $\sigma = 1.812 \text{ S/m}$ ;  $\epsilon_r = 39.126$ ;  $\rho = 1000 \text{ kg/m}^3$   
 Phantom section: Flat Section

DASY5 Configuration:

- Probe: EX3DV4 - SN7329; ConvF(7.44, 7.44, 7.44) @ 2450 MHz; Calibrated: 2020/11/30
- Sensor-Surface: 1.4mm (Mechanical Surface Detection)
- Electronics: DAE4 Sn1354; Calibrated: 2021/9/1
- Phantom: Head model; Type: QD000P40CC; Serial: TP:1744
- Measurement SW: DASY52, Version 52.10 (4); SEMCAD X Version 14.6.14 (7501)

**Area Scan (51x81x1):** Interpolated grid:  $dx=1.200 \text{ mm}$ ,  $dy=1.200 \text{ mm}$   
 Maximum value of SAR (interpolated) = 8.51 W/kg

**Zoom Scan (5x5x7)/Cube 0:** Measurement grid:  $dx=8\text{mm}$ ,  $dy=8\text{mm}$ ,  $dz=5\text{mm}$   
 Reference Value = 49.71 V/m; Power Drift = 0.14 dB  
 Peak SAR (extrapolated) = 10.4 W/kg  
**SAR(1 g) = 5.11 W/kg; SAR(10 g) = 2.34 W/kg**  
 Maximum value of SAR (measured) = 8.12 W/kg

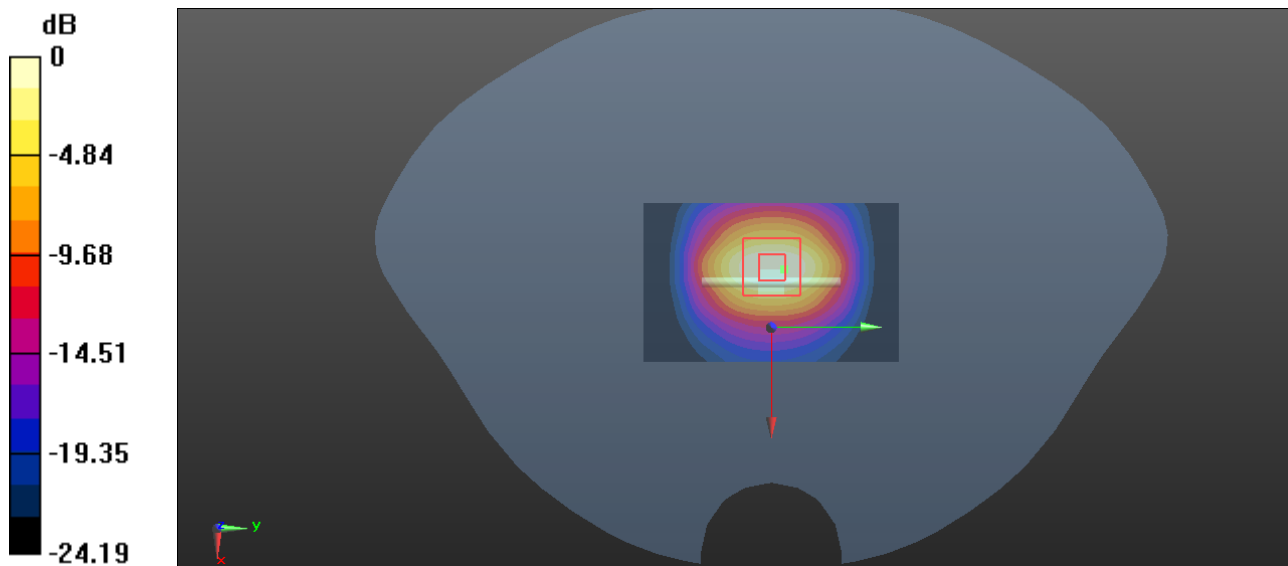

0 dB = 8.12 W/kg = 9.10 dBW/kg

**System Performance 5250 MHz****DUT: Dipole D5GHzV2; Type: 5250 MHz; Serial: SN:1301**

Communication System: CW; Frequency: 5250 MHz; Duty Cycle: 1:1

Medium parameters used:  $f = 5250$  MHz;  $\sigma = 4.716$  S/m;  $\epsilon_r = 35.815$ ;  $\rho = 1000$  kg/m<sup>3</sup>

Phantom section: Flat Section

DASY5 Configuration:

- Probe: EX3DV4 - SN7329; ConvF(5.55, 5.55, 5.55) @ 5250 MHz; Calibrated: 2020/11/30
- Sensor-Surface: 1.4mm (Mechanical Surface Detection)
- Electronics: DAE4 Sn1354; Calibrated: 2021/9/1
- Phantom: Head model; Type: QD000P40CC; Serial: TP:1744
- Measurement SW: DASY52, Version 52.10 (4); SEMCAD X Version 14.6.14 (7501)

**Area Scan (41x51x1):** Interpolated grid: dx=1.000 mm, dy=1.000 mm

Maximum value of SAR (interpolated) = 23.1 W/kg

**Zoom Scan (7x7x6)/Cube 0:** Measurement grid: dx=5mm, dy=5mm, dz=2mm

Reference Value = 44.07 V/m; Power Drift = -0.04 dB

Peak SAR (extrapolated) = 36.5 W/kg

**SAR(1 g) = 7.86 W/kg; SAR(10 g) = 2.19 W/kg**

Maximum value of SAR (measured) = 21.3 W/kg

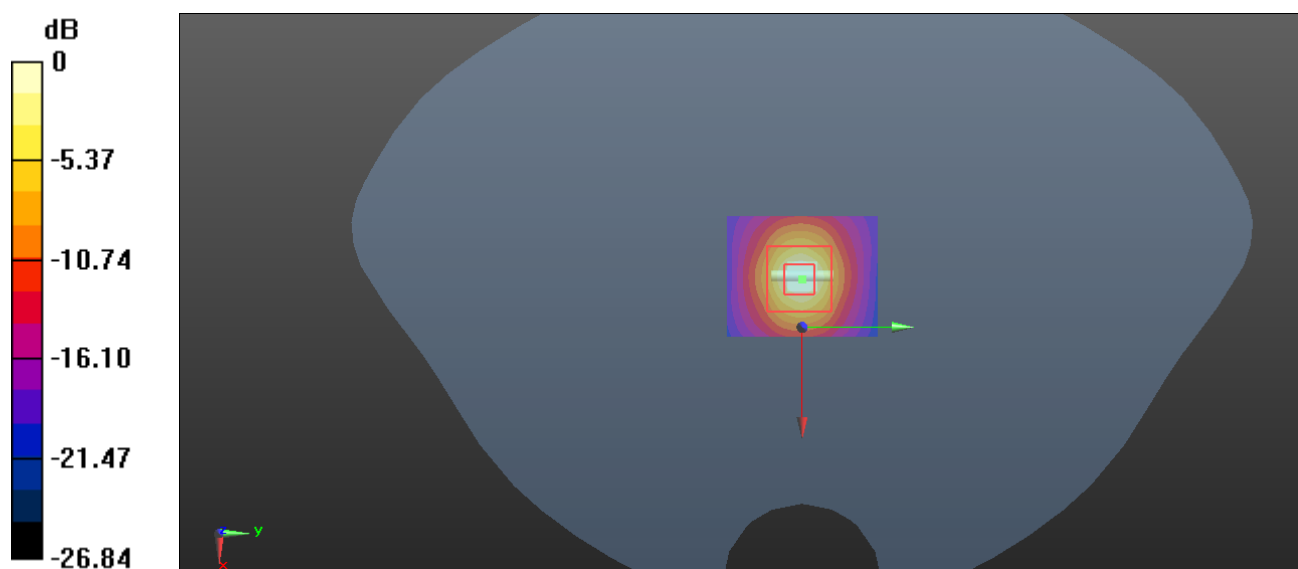

0 dB = 21.3 W/kg = 13.28 dBW/kg

**System Performance 5800 MHz****DUT: Dipole D5GHzV2; Type: 5800 MHz; Serial: SN:1301**

Communication System: CW; Frequency: 5800 MHz; Duty Cycle: 1:1

Medium parameters used:  $f = 5800$  MHz;  $\sigma = 5.275$  S/m;  $\epsilon_r = 35.26$ ;  $\rho = 1000$  kg/m<sup>3</sup>

Phantom section: Flat Section

DASY5 Configuration:

- Probe: EX3DV4 - SN7329; ConvF(4.72, 4.72, 4.72) @ 5800 MHz; Calibrated: 2020/11/30
- Sensor-Surface: 1.4mm (Mechanical Surface Detection)
- Electronics: DAE4 Sn1354; Calibrated: 2021/9/1
- Phantom: Head model; Type: QD000P40CC; Serial: TP:1744
- Measurement SW: DASY52, Version 52.10 (4); SEMCAD X Version 14.6.14 (7501)

**Area Scan (41x51x1):** Interpolated grid: dx=1.000 mm, dy=1.000 mm

Maximum value of SAR (interpolated) = 24.3 W/kg

**Zoom Scan (7x7x6)/Cube 0:** Measurement grid: dx=5mm, dy=5mm, dz=2mm

Reference Value = 41.06 V/m; Power Drift = -0.04 dB

Peak SAR (extrapolated) = 39.4 W/kg

**SAR(1 g) = 8.04 W/kg; SAR(10 g) = 2.29 W/kg**

Maximum value of SAR (measured) = 21.6 W/kg

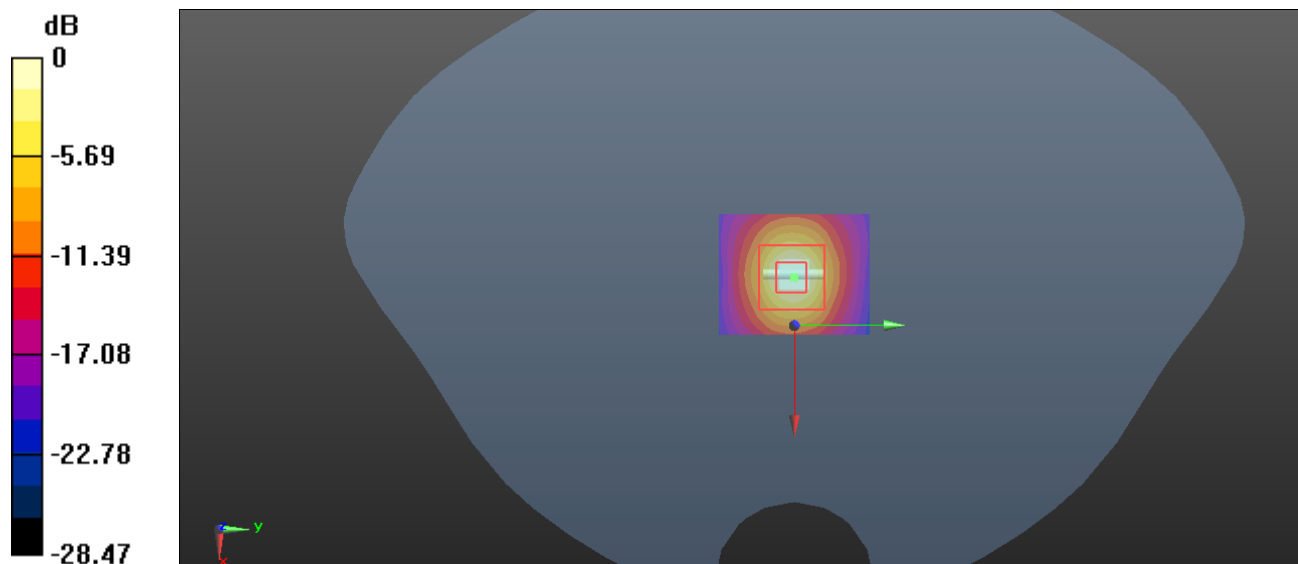

0 dB = 21.6 W/kg = 13.34 dBW/kg

## EUT TEST STRATEGY AND METHODOLOGY

### Test Positions for Device Operating Next to a Person’s Ear

This category includes most wireless handsets with fixed, retractable or internal antennas located toward the top half of the device, with or without a foldout, sliding or similar keypad cover. The handset should have its earpiece located within the upper ¼ of the device, either along the centerline or off-centered, as perceived by its users. This type of handset should be positioned in a normal operating position with the “test device reference point” located along the “vertical centerline” on the front of the device aligned to the “ear reference point”. The “test device reference point” should be located at the same level as the center of the earpiece region. The “vertical centerline” should bisect the front surface of the handset at its top and bottom edges. A “ear reference point” is located on the outer surface of the head phantom on each ear spacer. It is located 1.5 cm above the center of the ear canal entrance in the “phantom reference plane” defined by the three lines joining the center of each “ear reference point” (left and right) and the tip of the mouth.

A handset should be initially positioned with the earpiece region pressed against the ear spacer of a head phantom. For the SCC-34/SC-2 head phantom, the device should be positioned parallel to the “N-F” line defined along the base of the ear spacer that contains the “ear reference point”. For interim head phantoms, the device should be positioned parallel to the cheek for maximum RF energy coupling. The “test device reference point” is aligned to the “ear reference point” on the head phantom and the “vertical centerline” is aligned to the “phantom reference plane”. This is called the “initial ear position”. While maintaining these three alignments, the body of the handset is gradually adjusted to each of the following positions for evaluating SAR:

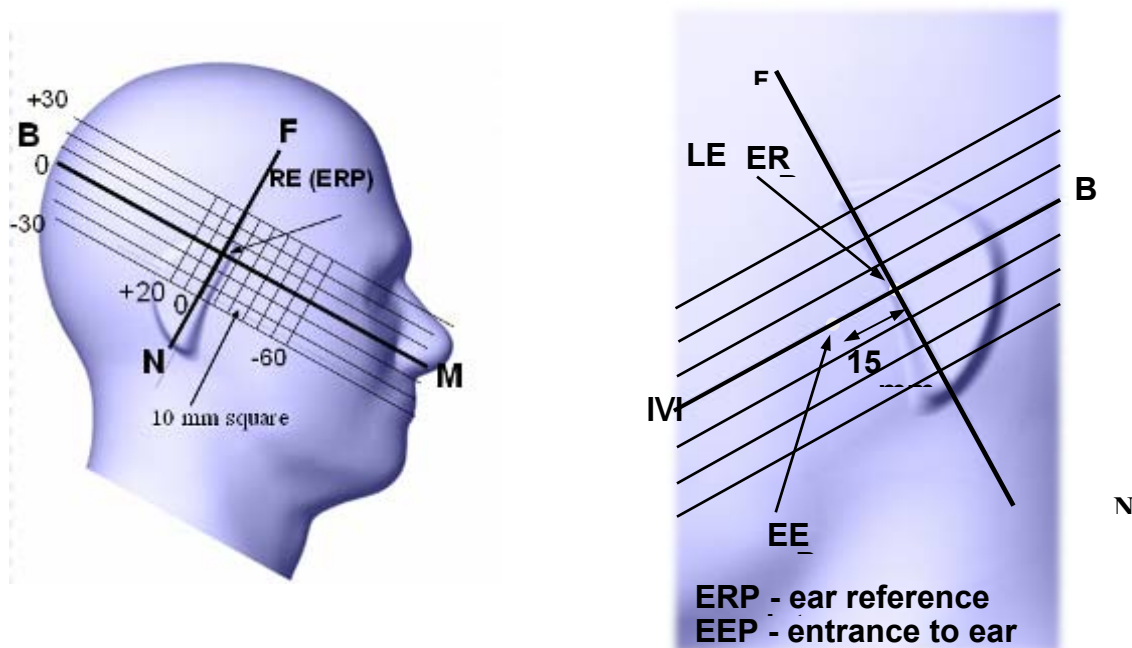

## Cheek/Touch Position

The device is brought toward the mouth of the head phantom by pivoting against the “ear reference point” or along the “N-F” line for the SCC-34/SC-2 head phantom.

This test position is established:

When any point on the display, keypad or mouthpiece portions of the handset is in contact with the phantom.

(or) When any portion of a foldout, sliding or similar keypad cover opened to its intended self-adjusting normal use position is in contact with the cheek or mouth of the phantom.

For existing head phantoms – when the handset loses contact with the phantom at the pivoting point, rotation should continue until the device touches the cheek of the phantom or breaks its last contact from the ear spacer.

### Cheek /Touch Position

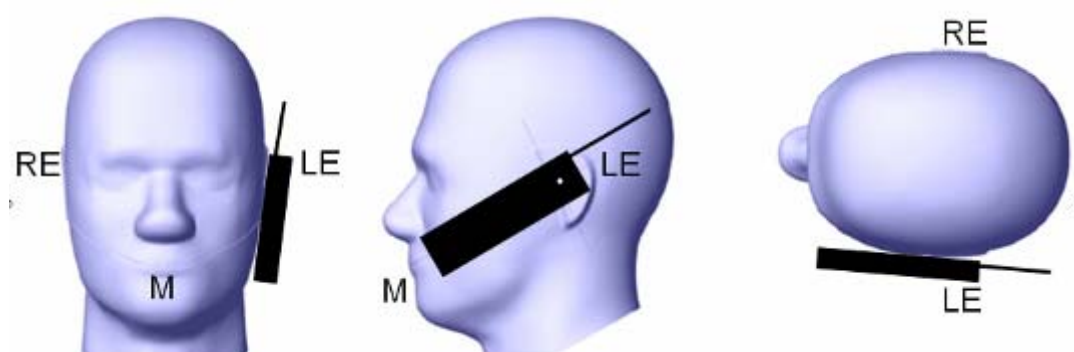

## Ear/Tilt Position

With the handset aligned in the “Cheek/Touch Position”:

1) If the earpiece of the handset is not in full contact with the phantom’s ear spacer (in the “Cheek/Touch position”) and the peak SAR location for the “Cheek/Touch” position is located at the ear spacer region or corresponds to the earpiece region of the handset, the device should be returned to the “initial ear position” by rotating it away from the mouth until the earpiece is in full contact with the ear spacer.

2) (otherwise) The handset should be moved (translated) away from the cheek perpendicular to the line passes through both “ear reference points” (note: one of these ear reference points may not physically exist on a split head model) for approximate 2-3 cm. While it is in this position, the device handset is tilted away from the mouth with respect to the “test device reference point” until the inside angle between the vertical centerline on the front surface of the phone and the horizontal line passing through the ear reference point is by 15 80°. After the tilt, it is then moved (translated) back toward the head perpendicular to the line passes through both “ear reference points” until the device touches the phantom or the ear spacer. If the antenna touches the head first, the positioning process should be repeated with a tilt angle less than 15° so that the device and its antenna would touch the phantom simultaneously. This test position may require a device holder or positioner to achieve the translation and tilting with acceptable positioning repeatability.

If a device is also designed to transmit with its keypad cover closed for operating in the head position, such positions should also be considered in the SAR evaluation. The device should be tested on the left and right side of the head phantom in the “Cheek/Touch” and “Ear/Tilt” positions. When applicable, each configuration should be tested with the antenna in its fully extended and fully retracted positions. These test configurations should be tested at the high, middle and low frequency channels of each operating mode; for example, AMPS, CDMA, and TDMA. If the SAR measured at the middle channel for each test configuration (left, right, Cheek/Touch, Tilt/Ear, extended and retracted) is at least 2.0 dB lower than the SAR limit, testing at the high and low channels is optional for such test configuration(s). If the transmission band of the test device is less than 10 MHz, testing at the high and low frequency channels is optional.

**Ear /Tilt 15° Position**

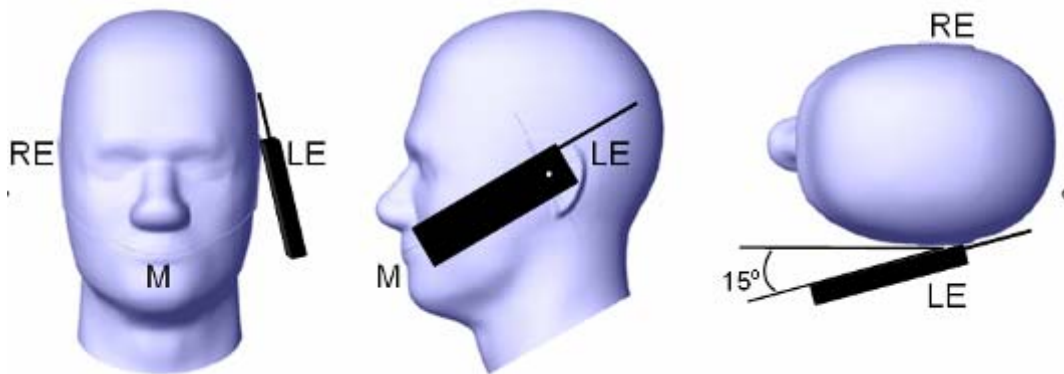

**Test positions for body-worn and other configurations**

Body-worn operating configurations should be tested with the belt-clips and holsters attached to the device and positioned against a flat phantom in normal use configurations. Devices with a headset output should be tested with a headset connected to the device. When multiple accessories that do not contain metallic components are supplied with the device, the device may be tested with only the accessory that dictates the closest spacing to the body. When multiple accessories that contain metallic components are supplied with the device, the device must be tested with each accessory that contains a unique metallic component. If multiple accessories share an identical metallic component (e.g., the same metallic belt-clip used with different holsters with no other metallic components), only the accessory that dictates the closest spacing to the body must be tested.

Body-worn accessories may not always be supplied or available as options for some devices that are intended to be authorized for body-worn use. A separation distance of 1.5 cm between the back of the device and a flat phantom is recommended for testing body-worn SAR compliance under such circumstances. Other separation distances may be used, but they should not exceed 2.5 cm. In these cases, the device may use body-worn accessories that provide a separation distance greater than that tested for the device provided however that the accessory contains no metallic components.

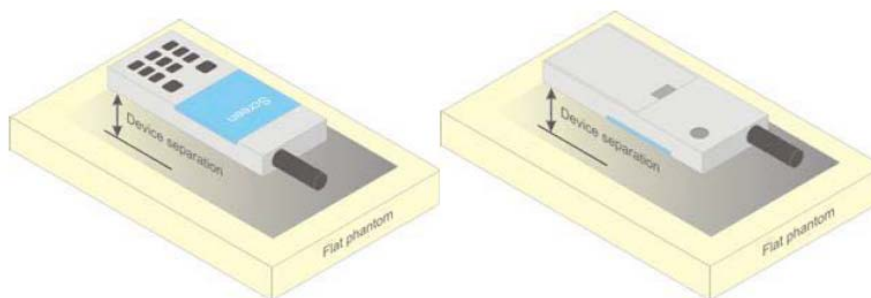

Figure 5 – Test positions for body-worn devices

**Test Distance for SAR Evaluation**

For Handheld mode(10g Extremity SAR) the EUT(Equipment Under Test) is set directly against the phantom, the test distance is 0mm;  
 For Close to Body mode(1g Body SAR) the EUT is set 10mm away from the phantom, the test distance is 10mm.

## SAR Evaluation Procedure

The evaluation was performed with the following procedure:

Step 1: Measurement of the SAR value at a fixed location above the ear point or central position was used as a reference value for assessing the power drop. The SAR at this point is measured at the start of the test and then again at the end of the testing.

Step 2: The SAR distribution at the exposed side of the head was measured at a distance of 4 mm from the inner surface of the shell. The area covered the entire dimension of the head or radiating structures of the EUT, the horizontal grid spacing was 15 mm x 15 mm, and the SAR distribution was determined by integrated grid of 1.5mm x 1.5mm. Based on these data, the area of the maximum absorption was determined by spline interpolation. The first Area Scan covers the entire dimension of the EUT to ensure that the hotspot was correctly identified.

Step 3: Around this point, a volume of 30 mm x 30 mm x 30 mm was assessed by measuring 7x 7 x 7 points. On the basis of this data set, the spatial peak SAR value was evaluated under the following procedure:

- 1) The data at the surface were extrapolated, since the center of the dipoles is 1.2 mm away from the tip of the probe and the distance between the surface and the lowest measuring point is 1.3 mm. The extrapolation was based on a least square algorithm. A polynomial of the fourth order was calculated through the points in z-axes. This polynomial was then used to evaluate the points between the surface and the probe tip.
- 2) The maximum interpolated value was searched with a straightforward algorithm. Around this maximum the SAR values averaged over the spatial volumes (1 g or 10 g) were computed by the 3D-Spline interpolation algorithm. The 3D-Spline is composed of three one dimensional splines with the "Not a knot"-condition (in x, y and z-directions). The volume was integrated with the trapezoidal-algorithm. One thousand points (10 x 10 x 10) were interpolated to calculate the averages.

All neighboring volumes were evaluated until no neighboring volume with a higher average value was found.

Step 4: Re-measurement of the SAR value at the same location as in Step 1. If the value changed by more than 5%, the evaluation was repeated.



## CONDUCTED OUTPUT POWER MEASUREMENT

### Provision Applicable

The measured peak output power should be greater and within 5% than EMI measurement.

### Test Procedure

The RF output of the transmitter was connected to the input port of the Power Meter through Connector.

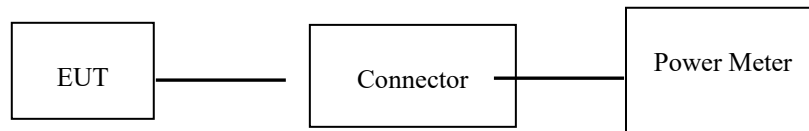

### SRD

### Maximum Target Output Power

Band	Mode	Maximum Target Output Power (dBm)	
		Chain 0	Chain 1
SRD 2.4GHz	1.4 M	22.9	22.7
	20 M	23.1	22.8
SRD 5.2GHz	1.4 M	11.9	10.1
	20 M	10.8	9.9
SRD 5.8GHz	1.4 M	19.8	19.9
	20 M	19.6	18.8

### Test Results:

#### SRD 2.4G:

Mode	Frequency (MHz)	Max Average Conducted Output Power (dBm)		
		Chain 0	Chain 1	Total
1.4 MHz	2403.5	22.8	22.62	25.83
	2439.5	22.53	22.6	25.56
	2475.5	22.58	22.57	25.69
20M	2412.5	22.59	22.71	25.6
	2437.5	<b>23</b>	<b>22.73</b>	25.85
	2462.5	22.76	22.53	25.7

#### SRD 5.2G:

Mode	Frequency (MHz)	Max Average Conducted Output Power (dBm)		
		Chain 0	Chain 1	Total
1.4 MHz	5154	<b>11.83</b>	<b>10.02</b>	13.96
	5201	11.73	9.97	13.91
	5246	11.62	9.61	13.66
20 MHz	5167	10.66	9.63	13.08
	5201	10.75	9.65	13.21
	5233	10.68	9.83	13.25

**SRD 5.8G:**

Mode	Frequency (MHz)	Max Average Conducted Output Power (dBm)		
		Chain 0	Chain 1	Total
1.4 MHz	5728	19.45	19.6	22.45
	5789	<b>19.72</b>	<b>19.81</b>	22.78
	5847	19.34	19.63	22.29
20 MHz	5738	18.17	18.65	21.42
	5790	19.23	18.46	21.85
	5839	19.47	18.58	22.01

*Note: The band of SRD 2.4G/5.2G/5.8G is for FCC certification, and the band of SRD 2.4G/5.8G is for IC certification.*

### Standalone SAR test exclusion considerations

**Antennas Location:**

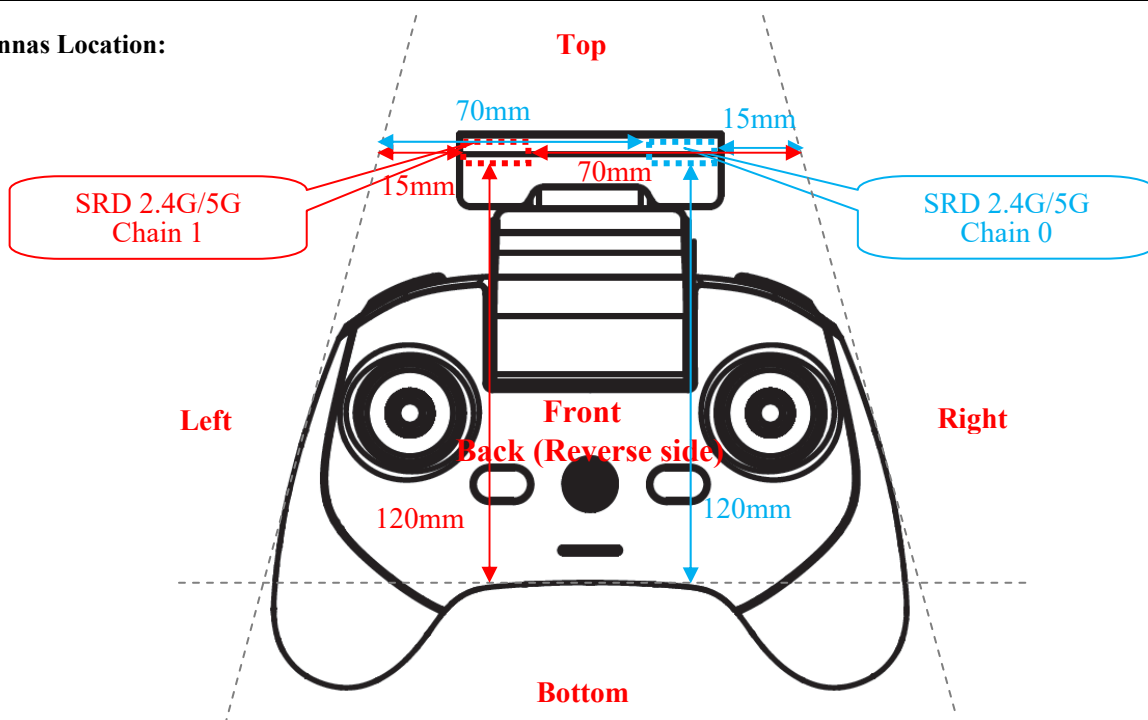

**Antenna Distance To Edge**

Antenna Distance To Edge(mm)						
Mode	Back	Front	Left	Right	Top	Bottom
SRD 2.4G/5G Chain 0	<5	<5	70	15	<5	120
SRD 2.4G/5G Chain 1	<5	<5	15	70	<5	120

**Standalone SAR test exclusion considerations(KDB)**

**Handheld**

Mode	Frequency (MHz)	Pavg (dBm)	Pavg (mW)	Distance (mm)	Calculated value	Threshold (10-g)	SAR Test Exclusion
SRD 2.4G Chain 0	2475.5	23.1	204.2	0	64.3	7.5	NO
SRD 2.4G Chain 1	2475.5	22.8	190.5	0	59.9	7.5	NO
SRD 5.2G Chain 0	5246	11.9	15.5	0	7.1	7.5	YES
SRD 5.2G Chain 1	5246	10.1	10.2	0	4.7	7.5	YES
SRD 5.8G Chain 0	5847	19.8	95.5	0	46.2	7.5	NO
SRD 5.8G Chain 1	5847	19.9	97.7	0	47.2	7.5	NO

**Close to Body**

Mode	Frequency (MHz)	Pavg (dBm)	Pavg (mW)	Distance (mm)	Calculated value	Threshold (1-g)	SAR Test Exclusion
SRD 2.4G Chain 0	2475.5	23.1	204.2	10	32.1	3	NO
SRD 2.4G Chain 1	2475.5	22.8	190.5	10	30	3	NO
SRD 5.2G Chain 0	5246	11.9	15.5	10	3.6	3	NO
SRD 5.2G Chain 1	5246	10.1	10.2	10	2.3	3	YES
SRD 5.8G Chain 0	5847	19.8	95.5	10	23.1	3	NO
SRD 5.8G Chain 1	5847	19.9	97.7	10	23.6	3	NO

**NOTE:**

The 1-g and 10-g SAR test exclusion thresholds for 100 MHz to 6 GHz at test separation distances ≤ 50 mm are determined by:

$$[(\text{max. power of channel, including tune-up tolerance, mW}) / (\text{min. test separation distance, mm})] \cdot [\sqrt{f(\text{GHz})}] \leq 3.0 \text{ for 1-g SAR and } \leq 7.5 \text{ for 10-g extremity SAR, where}$$

- f(GHz) is the RF channel transmit frequency in GHz.
- Power and distance are rounded to the nearest mW and mm before calculation.
- The result is rounded to one decimal place for comparison.
- When the minimum test separation distance is < 5 mm, a distance of 5 mm is applied to determine SAR test Exclusion.

**Standalone SAR test exclusion considerations(RSS 102)**

**Handheld**

Mode	Frequency (MHz)	Pavg (dBm)	Antenna Gain(dBi)	Pavg (mW)	Distance (mm)	Threshold (Power,mW)	SAR Test Exclusion
SRD 2.4G Chain 0	2475.5	23.1	2.7	380.2	0	9.88	NO
SRD 2.4G Chain 1	2475.5	22.8	2.7	354.8	0	9.88	NO
SRD 5.2G Chain 0	5246	11.9	3.9	38	0	3.1	NO
SRD 5.2G Chain 1	5246	10.1	3.9	25.1	0	3.1	NO
SRD 5.8G Chain 0	5847	19.8	3.9	234.4	0	2.5	NO
SRD 5.8G Chain 1	5847	19.9	3.9	239.9	0	2.5	NO

**Close to Body**

Mode	Frequency (MHz)	Pavg (dBm)	Antenna Gain(dBi)	Pavg (mW)	Distance (mm)	Threshold (Power,mW)	SAR Test Exclusion
SRD 2.4G Chain 0	2475.5	23.1	2.7	380.2	10	6.98	NO
SRD 2.4G Chain 1	2475.5	22.8	2.7	354.8	10	6.98	NO
SRD 5.2G Chain 0	5246	11.9	3.9	38	10	6	NO
SRD 5.2G Chain 1	5246	10.1	3.9	25.1	10	6	NO
SRD 5.8G Chain 0	5847	19.8	3.9	234.4	10	6	NO
SRD 5.8G Chain 1	5847	19.9	3.9	239.9	10	6	NO

Note: Only when SAR test was excluded under **KDB** and **RSS-102 Issue 5 March 2015**, SAR test is not required.

**Standalone SAR test exclusion considerations(KDB):**

**Handheld Mode:**

Mode	Frequency (MHz)	Pavg (dBm)	Pavg (mW)	Test Exclusion Distance (mm)
SRD 2.4G Chain 0	2475.5	23.1	204.2	50
SRD 2.4G Chain 1	2475.5	22.8	190.5	39.4
SRD 5.2G Chain 0	5246	11.9	15.5	<5
SRD 5.2G Chain 1	5246	10.1	10.2	<5
SRD 5.8G Chain 0	5847	19.8	95.5	30.3
SRD 5.8G Chain 1	5847	19.9	97.7	31

**Close to Body Mode:**

Mode	Frequency (MHz)	Pavg (dBm)	Pavg (mW)	Test Exclusion Distance (mm)
SRD 2.4G Chain 0	2475.5	23.1	204.2	42.9
SRD 2.4G Chain 1	2475.5	22.8	190.5	40
SRD 5.2G Chain 0	5246	11.9	15.5	4.8
SRD 5.2G Chain 1	5246	10.1	10.2	3.2
SRD 5.8G Chain 0	5847	19.8	95.5	30.8
SRD 5.8G Chain 1	5847	19.9	97.7	31.5

**Handheld Mode:**

SAR Test Exclusion for the EUT Edges Considerations						
Mode	Back	Front	Left	Right	Top	Bottom
SRD 2.4G Chain 0	Required	Required	Exclusion	Required	Required	Exclusion
SRD 2.4G Chain 1	Required	Required	Required	Exclusion	Required	Exclusion
SRD 5.2G Chain 0	Required	Required	Exclusion	Required	Required	Exclusion
SRD 5.2G Chain 1	Required	Required	Required	Exclusion	Required	Exclusion
SRD 5.8G Chain 0	Required	Required	Exclusion	Required	Required	Exclusion
SRD 5.8G Chain 1	Required	Required	Required	Exclusion	Required	Exclusion

**Close to Body Mode:**

SAR Test Exclusion for the EUT Edges Considerations						
Mode	Back	Front	Left	Right	Top	Bottom
SRD 2.4G Chain 0	Required	Required	Exclusion	Required	Required	Exclusion
SRD 2.4G Chain 1	Required	Required	Required	Exclusion	Required	Exclusion
SRD 5.2G Chain 0	Required	Required	Exclusion	Required	Required	Exclusion
SRD 5.2G Chain 1	Required	Required	Required	Exclusion	Required	Exclusion
SRD 5.8G Chain 0	Required	Required	Exclusion	Required	Required	Exclusion
SRD 5.8G Chain 1	Required	Required	Required	Exclusion	Required	Exclusion

**SAR test exclusion for the EUT edge considerations detail:**

**Distance < 50mm (To Edges)**

The 1-g and 10-g SAR test exclusion thresholds for 100 MHz to 6 GHz at test separation distances ≤ 50 mm are determined by:

$$[(\text{max. power of channel, including tune-up tolerance, mW}) / (\text{min. test separation distance, mm})] \cdot [\sqrt{f(\text{GHz})}] \leq 3.0 \text{ for 1-g SAR and } \leq 7.5 \text{ for 10-g extremity SAR, where}$$

1. f(GHz) is the RF channel transmit frequency in GHz.
2. Power and distance are rounded to the nearest mW and mm before calculation.
3. The result is rounded to one decimal place for comparison.
4. When the minimum test separation distance is < 5 mm, a distance of 5 mm is applied to determine SAR test Exclusion.
5. The Time based average Power is used for calculation

**Distance > 50mm (To Edges)**

At 100 MHz to 6 GHz and for test separation distances > 50 mm, the SAR test exclusion threshold is determined according to the following:

- a) [Power allowed at numeric threshold for 50 mm in step 1) + (test separation distance - 50 mm) · ( f(MHz)/150)] mW, at 100 MHz to 1500 MHz
- b) [Power allowed at numeric threshold for 50 mm in step 1) + (test separation distance - 50 mm) · 10] mW at > 1500 MHz and ≤ 6 GHz.

**Standalone SAR test exclusion considerations (RSS 102):**

**Handheld Mode:**

Mode	Frequency (MHz)	Pavg (dBm)	Antenna Gain (dBi)	Pavg (mW)	Test Exclusion Distance (mm)
SRD 2.4G Chain 0	2475.5	23.1	2.7	380.2	38
SRD 2.4G Chain 1	2475.5	22.8	2.7	354.8	36.9
SRD 5.2G Chain 0	5246	11.9	3.9	38	15
SRD 5.2G Chain 1	5246	10.1	3.9	25.1	12.2
SRD 5.8G Chain 0	5847	19.8	3.9	234.4	43.5
SRD 5.8G Chain 1	5847	19.9	3.9	239.9	44.5

**Close to Body Mode:**

Mode	Frequency (MHz)	Pavg (dBm)	Antenna Gain (dBi)	Pavg (mW)	Test Exclusion Distance (mm)
SRD 2.4G Chain 0	2475.5	23.1	2.7	380.2	62
SRD 2.4G Chain 1	2475.5	22.8	2.7	354.8	57.5
SRD 5.2G Chain 0	5246	11.9	3.9	38	23.1
SRD 5.2G Chain 1	5246	10.1	3.9	25.1	19
SRD 5.8G Chain 0	5847	19.8	3.9	234.4	109.7
SRD 5.8G Chain 1	5847	19.9	3.9	239.9	112.5

**SAR test exclusion for the EUT edge considerations Result(RSS 102)****Handheld Mode:**

SAR Test Exclusion for the EUT Edges Considerations						
Mode	Back	Front	Left	Right	Top	Bottom
SRD 2.4G Chain 0	Required	Required	Exclusion	Required	Required	Exclusion
SRD 2.4G Chain 1	Required	Required	Required	Exclusion	Required	Exclusion
SRD 5.2G Chain 0	Required	Required	Exclusion	Required	Required	Exclusion
SRD 5.2G Chain 1	Required	Required	Required	Exclusion	Required	Exclusion
SRD 5.8G Chain 0	Required	Required	Exclusion	Required	Required	Exclusion
SRD 5.8G Chain 1	Required	Required	Required	Exclusion	Required	Exclusion

**Close to Body Mode:**

SAR Test Exclusion for the EUT Edges Considerations						
Mode	Back	Front	Left	Right	Top	Bottom
SRD 2.4G Chain 0	Required	Required	Required	Required	Required	Exclusion
SRD 2.4G Chain 1	Required	Required	Required	Required	Required	Exclusion
SRD 5.2G Chain 0	Required	Required	Required	Required	Required	Exclusion
SRD 5.2G Chain 1	Required	Required	Required	Required	Required	Exclusion
SRD 5.8G Chain 0	Required	Required	Required	Required	Required	Exclusion
SRD 5.8G Chain 1	Required	Required	Required	Required	Required	Exclusion

Only when the distance from the antenna to edge is large than **Test Exclusion Distance** specified under **KDB** and **RSS-102 Issue 5 March 2015**, SAR test is not required

## SAR MEASUREMENT RESULTS

---

This page summarizes the results of the performed dosimetric evaluation.

### SAR Test Data

#### Environmental Conditions

<b>Temperature:</b>	22.6-23.7 °C	22.8-23.6 °C	22.3-23.4 °C
<b>Relative Humidity:</b>	42-56%	44-55%	41-59%
<b>ATM Pressure:</b>	100.2 kPa	100.5 kPa	100.7 kPa
<b>Test Date:</b>	2021/11/19	2021/11/20	2021/11/21

*Testing was performed by Seven Liang, Jacky Yang, Kelly Wang.*



**SRD 2.4G Chain 0:**

EUT Position	Bandwidth (MHz)	Frequency (MHz)	Max. Meas. Power (dBm)	Max. Rated Power (dBm)	10 g SAR (W/kg), Limit=4.0W/kg				
					Scaled Factor	Meas. SAR	Scaled SAR	Corrected SAR	Plot
Handheld Back (0mm)	1.4M	2403.5	/	/	/	/	/	/	/
		2439.5	22.53	22.9	1.089	0.102	0.111	0.11	1#
		2475.5	/	/	/	/	/	/	/
Handheld Front (0mm)	1.4M	2403.5	/	/	/	/	/	/	/
		2439.5	22.53	22.9	1.089	0.054	0.059	0.06	2#
		2475.5	/	/	/	/	/	/	/
Handheld Left (0mm)	1.4M	2403.5	/	/	/	/	/	/	/
		2439.5	22.53	22.9	1.089	0.023	0.025	0.03	3#
		2475.5	/	/	/	/	/	/	/
Handheld Right (0mm)	1.4M	2403.5	/	/	/	/	/	/	/
		2439.5	22.53	22.9	1.089	0.034	0.037	0.04	4#
		2475.5	/	/	/	/	/	/	/
Handheld Top (0mm)	1.4M	2403.5	22.8	22.9	1.023	0.857	0.877	0.88	5#
		2439.5	22.53	22.9	1.089	0.862	0.939	<b>0.94</b>	<b>6#</b>
		2475.5	22.58	22.9	1.076	0.835	0.898	0.90	7#
	20M	2437.5	23	23.1	1.023	0.826	0.845	0.85	8#

EUT Position	Bandwidth (MHz)	Frequency (MHz)	Max. Meas. Power (dBm)	Max. Rated Power (dBm)	1 g SAR (W/kg), Limit=1.6W/kg				
					Scaled Factor	Meas. SAR	Scaled SAR	Corrected SAR	Plot
Close to Body Back (10mm)	1.4M	2403.5	/	/	/	/	/	/	/
		2439.5	22.53	22.9	1.089	0.069	0.075	0.08	9#
		2475.5	/	/	/	/	/	/	/
Close to Body Front (10mm)	1.4M	2403.5	/	/	/	/	/	/	/
		2439.5	22.53	22.9	1.089	0.06	0.065	0.07	10#
		2475.5	/	/	/	/	/	/	/
Close to Body Left (10mm)	1.4M	2403.5	/	/	/	/	/	/	/
		2439.5	22.53	22.9	1.089	0.034	0.037	0.04	11#
		2475.5	/	/	/	/	/	/	/
Close to Body Right (10mm)	1.4M	2403.5	/	/	/	/	/	/	/
		2439.5	22.53	22.9	1.089	0.015	0.016	0.02	12#
		2475.5	/	/	/	/	/	/	/
Close to Body Top (10mm)	1.4M	2403.5	22.8	22.9	1.023	0.713	0.729	<b>0.73</b>	<b>13#</b>
		2439.5	22.53	22.9	1.089	0.606	0.66	0.66	14#
		2475.5	22.58	22.9	1.076	0.618	0.665	0.67	15#
	20M	2437.5	23	23.1	1.023	0.406	0.415	0.42	16#

**SRD 2.4G Chain 1:**

EUT Position	Bandwidth (MHz)	Frequency (MHz)	Max. Meas. Power (dBm)	Max. Rated Power (dBm)	10 g SAR (W/kg), Limit=4.0W/kg				
					Scaled Factor	Meas. SAR	Scaled SAR	Corrected SAR	Plot
Handheld Back (0mm)	1.4M	2403.5	/	/	/	/	/	/	/
		2439.5	22.6	22.7	1.023	0.056	0.057	0.06	17#
		2475.5	/	/	/	/	/	/	/
Handheld Front (0mm)	1.4M	2403.5	/	/	/	/	/	/	/
		2439.5	22.6	22.7	1.023	0.22	0.225	0.23	18#
		2475.5	/	/	/	/	/	/	/
Handheld Left (0mm)	1.4M	2403.5	/	/	/	/	/	/	/
		2439.5	22.6	22.7	1.023	0.455	0.465	0.47	19#
		2475.5	/	/	/	/	/	/	/
Handheld Right (0mm)	1.4M	2403.5	/	/	/	/	/	/	/
		2439.5	22.6	22.7	1.023	0.011	0.011	0.01	20#
		2475.5	/	/	/	/	/	/	/
Handheld Top (0mm)	1.4M	2403.5	22.62	22.7	1.019	0.516	0.526	0.53	21#
		2439.5	22.6	22.7	1.023	0.699	0.715	<b>0.72</b>	<b>22#</b>
		2475.5	22.57	22.7	1.03	0.41	0.422	0.42	23#
	20M	2437.5	22.73	22.8	1.016	0.513	0.521	0.52	24#

EUT Position	Bandwidth (MHz)	Frequency (MHz)	Max. Meas. Power (dBm)	Max. Rated Power (dBm)	1 g SAR (W/kg), Limit=1.6W/kg				
					Scaled Factor	Meas. SAR	Scaled SAR	Corrected SAR	Plot
Close to Body Back (10mm)	1.4M	2403.5	/	/	/	/	/	/	/
		2439.5	22.6	22.7	1.023	0.148	0.151	0.15	25#
		2475.5	/	/	/	/	/	/	/
Close to Body Front (10mm)	1.4M	2403.5	/	/	/	/	/	/	/
		2439.5	22.6	22.7	1.023	0.065	0.066	0.07	26#
		2475.5	/	/	/	/	/	/	/
Close to Body Left (10mm)	1.4M	2403.5	/	/	/	/	/	/	/
		2439.5	22.6	22.7	1.023	0.137	0.14	0.14	27#
		2475.5	/	/	/	/	/	/	/
Close to Body Right (10mm)	1.4M	2403.5	/	/	/	/	/	/	/
		2439.5	22.6	22.7	1.023	0.048	0.049	0.05	28#
		2475.5	/	/	/	/	/	/	/
Close to Body Top (10mm)	1.4M	2403.5	22.62	22.7	1.019	0.602	0.613	<b>0.61</b>	<b>29#</b>
		2439.5	22.6	22.7	1.023	0.565	0.578	0.58	30#
		2475.5	22.57	22.7	1.03	0.452	0.466	0.47	31#
	20M	2437.5	22.73	22.8	1.016	0.413	0.42	0.42	32#

**SRD 5.2G Chain 0:**

EUT Position	Bandwidth (MHz)	Frequency (MHz)	Max. Meas. Power (dBm)	Max. Rated Power (dBm)	10 g SAR (W/kg), Limit=4.0W/kg				
					Scaled Factor	Meas. SAR	Scaled SAR	Corrected SAR	Plot
Handheld Back (0mm)	1.4M	5154	/	/	/	/	/	/	/
		5201	11.73	11.9	1.04	0.136	0.141	0.14	33#
		5246	/	/	/	/	/	/	/
Handheld Front (0mm)	1.4M	5154	/	/	/	/	/	/	/
		5201	11.73	11.9	1.04	0.18	0.187	0.19	34#
		5246	/	/	/	/	/	/	/
Handheld Left (0mm)	1.4M	5154	/	/	/	/	/	/	/
		5201	11.73	11.9	1.04	0.042	0.044	0.04	35#
		5246	/	/	/	/	/	/	/
Handheld Right (0mm)	1.4M	5154	/	/	/	/	/	/	/
		5201	11.73	11.9	1.04	0.053	0.055	0.06	36#
		5246	/	/	/	/	/	/	/
Handheld Top (0mm)	1.4M	5154	11.83	11.9	1.016	0.789	0.802	0.80	37#
		5201	11.73	11.9	1.04	0.851	0.885	<b>0.89</b>	<b>38#</b>
		5246	11.62	11.9	1.067	0.818	0.873	0.87	39#
	20M	5201	10.75	10.8	1.012	0.75	0.759	0.76	40#

EUT Position	Bandwidth (MHz)	Frequency (MHz)	Max. Meas. Power (dBm)	Max. Rated Power (dBm)	1 g SAR (W/kg), Limit=1.6W/kg				
					Scaled Factor	Meas. SAR	Scaled SAR	Corrected SAR	Plot
Close to Body Back (10mm)	1.4M	5154	/	/	/	/	/	/	/
		5201	11.73	11.9	1.04	0.12	0.125	0.13	41#
		5246	/	/	/	/	/	/	/
Close to Body Front (10mm)	1.4M	5154	/	/	/	/	/	/	/
		5201	11.73	11.9	1.04	0.093	0.097	0.10	42#
		5246	/	/	/	/	/	/	/
Close to Body Left (10mm)	1.4M	5154	/	/	/	/	/	/	/
		5201	11.73	11.9	1.04	0.078	0.081	0.08	43#
		5246	/	/	/	/	/	/	/
Close to Body Right (10mm)	1.4M	5154	/	/	/	/	/	/	/
		5201	11.73	11.9	1.04	0.088	0.092	0.09	44#
		5246	/	/	/	/	/	/	/
Close to Body Top (10mm)	1.4M	5154	11.83	11.9	1.016	0.138	0.14	0.14	45#
		5201	11.73	11.9	1.04	0.183	0.19	<b>0.19</b>	<b>46#</b>
		5246	11.62	11.9	1.067	0.145	0.155	0.16	47#
	20M	5201	10.75	10.8	1.012	0.12	0.121	0.12	48#

**SRD 5.2G Chain 1:**

EUT Position	Bandwidth (MHz)	Frequency (MHz)	Max. Meas. Power (dBm)	Max. Rated Power (dBm)	10 g SAR (W/kg), Limit=4.0W/kg				
					Scaled Factor	Meas. SAR	Scaled SAR	Corrected SAR	Plot
Handheld Back (0mm)	1.4M	5154	/	/	/	/	/	/	/
		5201	9.97	10.1	1.03	0.118	0.122	0.12	49#
		5246	/	/	/	/	/	/	/
Handheld Front (0mm)	1.4M	5154	/	/	/	/	/	/	/
		5201	9.97	10.1	1.03	0.157	0.162	0.16	50#
		5246	/	/	/	/	/	/	/
Handheld Left (0mm)	1.4M	5154	/	/	/	/	/	/	/
		5201	9.97	10.1	1.03	0.433	0.446	0.45	51#
		5246	/	/	/	/	/	/	/
Handheld Right (0mm)	1.4M	5154	/	/	/	/	/	/	/
		5201	9.97	10.1	1.03	0.056	0.058	0.06	52#
		5246	/	/	/	/	/	/	/
Handheld Top (0mm)	1.4M	5154	10.02	10.1	1.019	0.911	0.928	0.93	53#
		5201	9.97	10.1	1.03	0.826	0.851	0.85	54#
		5246	9.61	10.1	1.119	0.987	1.104	<b>1.10</b>	<b>55#</b>
	20M	5201	9.65	9.9	1.059	0.653	0.692	0.69	56#

EUT Position	Bandwidth (MHz)	Frequency (MHz)	Max. Meas. Power (dBm)	Max. Rated Power (dBm)	1 g SAR (W/kg), Limit=1.6W/kg				
					Scaled Factor	Meas. SAR	Scaled SAR	Corrected SAR	Plot
Close to Body Back (10mm)	1.4M	5154	/	/	/	/	/	/	/
		5201	9.97	10.1	1.03	0.143	0.147	0.15	57#
		5246	/	/	/	/	/	/	/
Close to Body Front (10mm)	1.4M	5154	/	/	/	/	/	/	/
		5201	9.97	10.1	1.03	0.128	0.132	0.13	58#
		5246	/	/	/	/	/	/	/
Close to Body Left (10mm)	1.4M	5154	/	/	/	/	/	/	/
		5201	9.97	10.1	1.03	0.118	0.122	0.12	59#
		5246	/	/	/	/	/	/	/
Close to Body Right (10mm)	1.4M	5154	/	/	/	/	/	/	/
		5201	9.97	10.1	1.03	0.063	0.065	0.07	60#
		5246	/	/	/	/	/	/	/
Close to Body Top (10mm)	1.4M	5154	10.02	10.1	1.019	0.149	0.152	0.15	61#
		5201	9.97	10.1	1.03	0.156	0.161	0.16	62#
		5246	9.61	10.1	1.119	0.179	0.2	<b>0.20</b>	<b>63#</b>
	20M	5201	9.65	9.9	1.059	0.144	0.152	0.15	64#

**SRD 5.8G Chain 0:**

EUT Position	Bandwidth (MHz)	Frequency (MHz)	Max. Meas. Power (dBm)	Max. Rated Power (dBm)	10 g SAR (W/kg), Limit=4.0W/kg				
					Scaled Factor	Meas. SAR	Scaled SAR	Corrected SAR	Plot
Handheld Back (0mm)	1.4M	5728	/	/	/	/	/	/	/
		5789	19.72	19.8	1.019	0.192	0.196	0.2	65#
		5847	/	/	/	/	/	/	/
Handheld Front (0mm)	1.4M	5728	/	/	/	/	/	/	/
		5789	19.72	19.8	1.019	0.111	0.113	0.11	66#
		5847	/	/	/	/	/	/	/
Handheld Left (0mm)	1.4M	5728	/	/	/	/	/	/	/
		5789	19.72	19.8	1.019	0.057	0.058	0.06	67#
		5847	/	/	/	/	/	/	/
Handheld Right (0mm)	1.4M	5728	/	/	/	/	/	/	/
		5789	19.72	19.8	1.019	0.078	0.079	0.08	68#
		5847	/	/	/	/	/	/	/
Handheld Top (0mm)	1.4M	5728	19.45	19.8	1.084	1.07	1.16	1.16	69#
		5789	19.72	19.8	1.019	0.779	0.794	0.79	70#
		5847	19.34	19.8	1.112	1.14	1.268	1.27	71#
	20M	5790	19.23	19.6	1.089	0.754	0.821	0.82	72#

EUT Position	Bandwidth (MHz)	Frequency (MHz)	Max. Meas. Power (dBm)	Max. Rated Power (dBm)	1 g SAR (W/kg), Limit=1.6W/kg				
					Scaled Factor	Meas. SAR	Scaled SAR	Corrected SAR	Plot
Close to Body Back (10mm)	1.4M	5728	/	/	/	/	/	/	/
		5789	19.72	19.8	1.019	0.201	0.205	0.21	73#
		5847	/	/	/	/	/	/	/
Close to Body Front (10mm)	1.4M	5728	/	/	/	/	/	/	/
		5789	19.72	19.8	1.019	0.094	0.096	0.10	74#
		5847	/	/	/	/	/	/	/
Close to Body Left (10mm)	1.4M	5728	/	/	/	/	/	/	/
		5789	19.72	19.8	1.019	0.127	0.129	0.13	75#
		5847	/	/	/	/	/	/	/
Close to Body Right (10mm)	1.4M	5728	/	/	/	/	/	/	/
		5789	19.72	19.8	1.019	0.117	0.119	0.12	76#
		5847	/	/	/	/	/	/	/
Close to Body Top (10mm)	1.4M	5728	19.45	19.8	1.084	0.634	0.687	<b>0.69</b>	77#
		5789	19.72	19.8	1.019	0.566	0.577	0.58	78#
		5847	19.34	19.8	1.112	0.614	0.683	0.68	79#
	20M	5790	19.23	19.6	1.089	0.505	0.55	0.55	80#

**SRD 5.8G Chain 1:**

EUT Position	Bandwidth (MHz)	Frequency (MHz)	Max. Meas. Power (dBm)	Max. Rated Power (dBm)	10 g SAR (W/kg), Limit=4.0W/kg				
					Scaled Factor	Meas. SAR	Scaled SAR	Corrected SAR	Plot
Handheld Back (0mm)	1.4M	5728	/	/	/	/	/	/	/
		5789	19.81	19.9	1.021	0.167	0.171	0.17	81#
		5847	/	/	/	/	/	/	/
Handheld Front (0mm)	1.4M	5728	/	/	/	/	/	/	/
		5789	19.81	19.9	1.021	0.227	0.232	0.23	82#
		5847	/	/	/	/	/	/	/
Handheld Left (0mm)	1.4M	5728	/	/	/	/	/	/	/
		5789	19.81	19.9	1.021	0.125	0.128	0.13	83#
		5847	/	/	/	/	/	/	/
Handheld Right (0mm)	1.4M	5728	/	/	/	/	/	/	/
		5789	19.81	19.9	1.021	0.035	0.036	0.04	84#
		5847	/	/	/	/	/	/	/
Handheld Top (0mm)	1.4M	5728	19.6	19.9	1.072	1.06	1.136	1.14	85#
		5789	19.81	19.9	1.021	1.1	1.123	1.12	86#
		5847	19.63	19.9	1.064	1.8	1.915	<b>1.92</b>	<b>87#</b>
	20M	5790	18.46	18.8	1.081	0.77	0.832	0.83	88#

EUT Position	Bandwidth (MHz)	Frequency (MHz)	Max. Meas. Power (dBm)	Max. Rated Power (dBm)	1 g SAR (W/kg), Limit=1.6W/kg				
					Scaled Factor	Meas. SAR	Scaled SAR	Corrected SAR	Plot
Close to Body Back (10mm)	1.4M	5728	/	/	/	/	/	/	/
		5789	19.81	19.9	1.021	0.349	0.356	0.36	89#
		5847	/	/	/	/	/	/	/
Close to Body Front (10mm)	1.4M	5728	/	/	/	/	/	/	/
		5789	19.81	19.9	1.021	0.143	0.146	0.15	90#
		5847	/	/	/	/	/	/	/
Close to Body Left (10mm)	1.4M	5728	/	/	/	/	/	/	/
		5789	19.81	19.9	1.021	0.673	0.687	0.69	91#
		5847	/	/	/	/	/	/	/
Close to Body Right (10mm)	1.4M	5728	/	/	/	/	/	/	/
		5789	19.81	19.9	1.021	0.077	0.079	0.08	92#
		5847	/	/	/	/	/	/	/
Close to Body Top (10mm)	1.4M	5728	19.6	19.9	1.072	0.399	0.428	0.43	93#
		5789	19.81	19.9	1.021	0.686	0.700	0.70	94#
		5847	19.63	19.9	1.064	0.768	0.817	<b>0.82</b>	<b>95#</b>
	20M	5790	18.46	18.8	1.081	0.505	0.546	0.55	96#

**Note:**

1. When the SAR value is less than half of the limit, testing for other channels are optional.
2. When SAR or MPE is not measured at the maximum power level allowed for production units, the results must be scaled to the maximum tune-up tolerance limit according to the power applied to the individual channels tested to determine compliance.
3. For modes that peak SAR is too low to evaluate, a SAR value 0.01W/kg is considered as their Scaled SAR.
4. The highest output power bandwidth 1.4MHz was selected as primary mode, for the worst case of the primary

mode other bandwidth 20 MHz, was selected to test.

5. According to IEC/IEEE 62209-1528:2020, If the correction  $\Delta$ SAR has a positive sign, the measured SAR results shall not be corrected.
6. *The band of SRD 2.4G/5.2G/5.8G is for FCC certification, and the band of SRD 2.4G/5.8G is for IC certification.*

### 7.8.2 SAR correction formula

From Douglas et al. ([28], [29]), a linear relationship was found between the percentage change in SAR (denoted  $\Delta SAR$ ) and the percentage change in the permittivity and conductivity from the target values in Table 2 (denoted  $\Delta \epsilon_r$  and  $\Delta \sigma$ , respectively). This linear relationship agrees with the results of Kuster and Balzano [30] and Bit-Babik et al. [31]. The relationship is given by:

$$\Delta SAR = c_\epsilon \Delta \epsilon_r + c_\sigma \Delta \sigma \quad (8)$$

where

$c_\epsilon = \partial(\Delta SAR)/\partial(\Delta \epsilon)$  is the coefficient representing the sensitivity of SAR to permittivity where SAR is normalized to output power;

$c_\sigma = \partial(\Delta SAR)/\partial(\Delta \sigma)$  is the coefficient representing the sensitivity of SAR to conductivity, where SAR is normalized to output power.

The values of  $c_\epsilon$  and  $c_\sigma$  have a simple relationship with frequency that can be described using polynomial equations. For dipole antennas at frequencies from 4 MHz to 6 GHz, the 1 g averaged SAR  $c_\epsilon$  and  $c_\sigma$  are given by

$$c_\epsilon = -7,854 \times 10^{-4} f^3 + 9,402 \times 10^{-3} f^2 - 2,742 \times 10^{-2} f - 0,2026 \quad (9)$$

$$c_\sigma = 9,804 \times 10^{-3} f^3 - 8,661 \times 10^{-2} f^2 + 2,981 \times 10^{-2} f + 0,7829 \quad (10)$$

where  $f$  is the frequency in GHz. Above 6 GHz, the sensitivity is non-varying with frequency due to the small penetration depth; the values of  $c_\epsilon = -0,198$  and  $c_\sigma = 0$  shall be used.

For frequencies from 4 MHz to 6 GHz, the 10 g averaged SAR  $c_\epsilon$  and  $c_\sigma$  are given by:

$$c_\epsilon = 3,456 \times 10^{-3} f^3 - 3,531 \times 10^{-2} f^2 + 7,675 \times 10^{-2} f - 0,1860 \quad (11)$$

$$c_\sigma = 4,479 \times 10^{-3} f^3 - 1,586 \times 10^{-2} f^2 - 0,1972 f + 0,7717 \quad (12)$$



## Corrected SAR Evaluation Table

Frequency (MHz)	Liquid Type	$C \varepsilon$	$\Delta \varepsilon r$	$C \delta$	$\Delta \delta$	$\Delta SAR$ (%)
2403.5	1g Head	-0.225	0.03	0.490	-1.25	-0.62
2412.5	1g Head	-0.225	-0.19	0.488	-1.19	-0.54
2437.5	1g Head	-0.225	-0.16	0.483	-1.45	-0.66
2439.5	1g Head	-0.225	-0.16	0.483	-0.61	-0.26
2450	1g Head	-0.225	-0.19	0.480	0.67	0.36
2462.5	1g Head	-0.225	-0.22	0.478	0.88	0.47
2475.5	1g Head	-0.225	-0.3	0.475	1.04	0.56
2403.5	10g Head	-0.158	0.03	0.268	-1.25	-0.34
2412.5	10g Head	-0.158	-0.19	0.267	-1.19	-0.29
2437.5	10g Head	-0.159	-0.16	0.262	-1.45	-0.35
2439.5	10g Head	-0.159	-0.16	0.261	-0.61	-0.13
2450	10g Head	-0.159	-0.19	0.259	0.67	0.20
2462.5	10g Head	-0.160	-0.22	0.257	0.88	0.26
2475.5	10g Head	-0.160	-0.3	0.254	1.04	0.31

Frequency (MHz)	Liquid Type	$C \varepsilon$	$\Delta \varepsilon r$	$C \delta$	$\Delta \delta$	$\Delta SAR$ (%)
5154	1g Head	-0.202	0.54	-0.022	0.39	-0.12
5167	1g Head	-0.202	0.26	-0.023	0.41	-0.06
5201	1g Head	-0.201	0.1	-0.026	0.15	-0.02
5233	1g Head	-0.201	-0.16	-0.028	-0.26	0.04
5246	1g Head	-0.201	-0.25	-0.029	-0.15	0.05
5250	1g Head	-0.201	-0.38	-0.029	0.13	0.07
5154	10g Head	-0.255	0.54	-0.053	0.39	-0.16
5167	10g Head	-0.255	0.26	-0.053	0.41	-0.09
5201	10g Head	-0.256	0.1	-0.053	0.15	-0.03
5233	10g Head	-0.256	-0.16	-0.053	-0.26	0.05
5246	10g Head	-0.256	-0.25	-0.053	-0.15	0.07
5250	10g Head	-0.256	-0.38	-0.053	0.13	0.09

Frequency (MHz)	Liquid Type	C $\epsilon$	$\Delta \epsilon_r$	C $\delta$	$\Delta \delta$	$\Delta$ SAR (%)
5728	1g Head	-0.199	0.07	-0.046	0.44	-0.03
5738	1g Head	-0.199	0.01	-0.045	0.52	-0.03
5789	1g Head	-0.199	0.13	-0.045	-0.32	-0.01
5790	1g Head	-0.199	-0.1	-0.045	-0.17	0.03
5800	1g Head	-0.199	-0.11	-0.045	0.09	0.02
5839	1g Head	-0.199	-0.13	-0.044	-0.4	0.04
5847	1g Head	-0.198	-0.25	-0.044	-0.49	0.07
5728	10g Head	-0.255	0.07	-0.036	0.44	-0.03
5738	10g Head	-0.255	0.01	-0.036	0.52	-0.02
5789	10g Head	-0.255	0.13	-0.032	-0.32	-0.02
5790	10g Head	-0.255	-0.1	-0.032	-0.17	0.03
5800	10g Head	-0.254	-0.11	-0.032	0.09	0.03
5839	10g Head	-0.254	-0.13	-0.029	-0.4	0.04
5847	10g Head	-0.254	-0.25	-0.028	-0.49	0.08

$$\Delta\text{SAR} = c_{\epsilon} \Delta\epsilon_r + c_{\sigma} \Delta\sigma$$

where

$f$  is the frequency in GHz.

$$\text{Corrected SAR} = \text{Measured SAR} * ((100 + (\Delta\text{SAR} \times -1)) / 100)$$

## SAR Measurement Variability

In accordance with published RF Exposure KDB procedure 865664 D01 SAR measurement 100 MHz to 6 GHz v01. These additional measurements are repeated after the completion of all measurements requiring the same head or body tissue-equivalent medium in a frequency band. The test device should be returned to ambient conditions (normal room temperature) with the battery fully charged before it is re-mounted on the device holder for the repeated measurement(s) to minimize any unexpected variations in the repeated results

- 1) Repeated measurement is not required when the original highest measured SAR is < 0.80 W/kg; steps 2) through 4) do not apply.
- 2) When the original highest measured SAR is  $\geq 0.80$  W/kg, repeat that measurement once.
- 3) Perform a second repeated measurement only if the ratio of largest to smallest SAR for the original and first repeated measurements is > 1.20 or when the original or repeated measurement is  $\geq 1.45$  W/kg (~ 10% from the 1-g SAR limit).
- 4) Perform a third repeated measurement only if the original, first or second repeated measurement is  $\geq 1.5$  W/kg and the ratio of largest to smallest SAR for the original, first and second repeated measurements is > 1.20.

*Note: The same procedures should be adapted for measurements according to extremity and occupational exposure limits by applying a factor of 2.5 for extremity exposure and a factor of 5 for occupational exposure to the corresponding SAR thresholds.*

### The Highest Measured SAR Configuration in Each Frequency Band

#### Handheld SAR

SAR probe calibration point	Frequency Band	Freq.(MHz)	EUT Position	Meas. SAR (W/kg)		Largest to Smallest SAR Ratio
				Original	Repeated	
/	/	/	/	/	/	/

#### Body SAR

SAR probe calibration point	Frequency Band	Freq.(MHz)	EUT Position	Meas. SAR (W/kg)		Largest to Smallest SAR Ratio
				Original	Repeated	
/	/	/	/	/	/	/

**Note:**

1. Second Repeated Measurement is not required since the ratio of the largest to smallest SAR for the original and first repeated measurement is not > 1.20.
2. The measured SAR results **do not** have to be scaled to the maximum tune-up tolerance to determine if repeated measurements are required.
3. SAR measurement variability must be assessed for each frequency band, which is determined by the **SAR probe calibration point and tissue-equivalent medium** used for the device measurements..

## SAR SIMULTANEOUS TRANSMISSION DESCRIPTION

### Simultaneous Transmission:

Description of Simultaneous Transmit Capabilities	
Transmitter Combination	Simultaneous?
SRD 2.4G Chain 0+ SRD 2.4G Chain 1	√
SRD 5.2G Chain 0+ SRD 5.2G Chain 1	√
SRD 5.8G Chain 0+ SRD 5.8G Chain 1	√
SRD 2.4G Chain 0+ SRD 5G Chain 1	×

### Simultaneous SAR test exclusion considerations:

#### 10g Extremity SAR:

Mode(SAR1+SAR2)	Position	Reported SAR(W/kg)		$\Sigma$ SAR < 4W/kg
		SAR1	SAR2	
SRD 2.4G Chain 0+ SRD 2.4G Chain 1	Handheld Back	0.11	0.06	0.17
	Handheld Front	0.06	0.23	0.29
	Handheld Left	0.03	0.47	0.5
	Handheld Right	0.04	0.01	0.05
	Handheld Top	0.94	0.72	1.66
SRD 5.2G Chain 0+ SRD 5.2G Chain 1	Handheld Back	0.14	0.12	0.26
	Handheld Front	0.19	0.16	0.35
	Handheld Left	0.04	0.45	0.49
	Handheld Right	0.06	0.06	0.12
	Handheld Top	0.89	1.1	1.99
SRD 5.8G Chain 0+ SRD 5.8G Chain 1	Handheld Back	0.2	0.17	0.37
	Handheld Front	0.11	0.23	0.34
	Handheld Left	0.06	0.13	0.19
	Handheld Right	0.08	0.04	0.12
	Handheld Top	1.27	1.92	<b>3.19</b>

### Conclusion:

Sum of SAR:  $\Sigma$  SAR < 4.0 W/kg, simultaneous transmission SAR with Volume Scans is **not required**.

**1g Body SAR:**

Mode(SAR1+SAR2)	Position	Reported SAR(W/kg)		$\Sigma$ SAR < 1.6W/kg
		SAR1	SAR2	
SRD 2.4G Chain 0+ SRD 2.4G Chain 1	Close to Body Back	0.08	0.15	0.23
	Close to Body Front	0.07	0.07	0.14
	Close to Body Left	0.04	0.14	0.18
	Close to Body Right	0.02	0.05	0.07
	Close to Body Top	0.73	0.61	1.34
SRD 5.2G Chain 0+ SRD 5.2G Chain 1	Close to Body Back	0.13	0.15	0.28
	Close to Body Front	0.10	0.13	0.23
	Close to Body Left	0.08	0.12	0.2
	Close to Body Right	0.09	0.07	0.16
	Close to Body Top	0.19	0.2	0.39
SRD 5.8G Chain 0+ SRD 5.8G Chain 1	Close to Body Back	0.21	0.35	0.56
	Close to Body Front	0.10	0.15	0.25
	Close to Body Left	0.13	0.68	0.81
	Close to Body Right	0.12	0.08	0.2
	Close to Body Top	0.69	0.82	<b>1.51</b>

**Conclusion:**

Sum of SAR:  $\Sigma$  SAR < 1.6 W/kg, simultaneous transmission SAR with Volume Scans is **not required**.

## SAR Plots

---

**Please Refer to the Attachment.**

---

## APPENDIX A MEASUREMENT UNCERTAINTY

---

KDB 865664 D01 SAR measurement 100MHz to 6GHz, when the highest measured 1-g SAR within a frequency band is < 1.5 W/kg and the measured 10-g SAR within a frequency band is < 3.75 W/kg. The expanded SAR measurement uncertainty must be  $\leq 30\%$ , for a confidence interval of  $k = 2$ . If these conditions are met, extensive SAR measurement uncertainty analysis described in IEEE Std 1528-2013 is not required in SAR reports submitted for equipment approval. For this device, the highest measured 1-g SAR is less 1.5W/kg and highest measured 10-g SAR is less 3.75W/kg. Therefore, the measurement uncertainty table is not required in this report

---

## **APPENDIX B EUT TEST POSITION PHOTOS**

---

**Please Refer to the Attachment.**



---

## APPENDIX C PROBE CALIBRATION CERTIFICATES

---

**Please Refer to the Attachment.**

---

## APPENDIX D DIPOLE CALIBRATION CERTIFICATES

---

**Please Refer to the Attachment.**

**\*\*\*\*\* END OF REPORT \*\*\*\*\***