

# QUICK START GUIDE

Autel Smart Controller

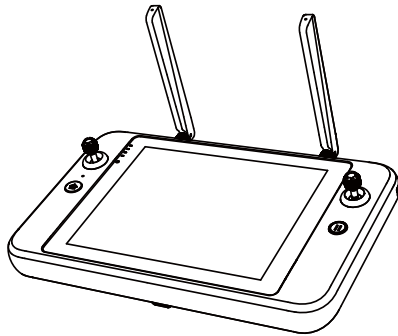

**AUTEL**  
ROBOTICS

## Contents

1. Disclaimer	1
2. Battery Safety	1
3. Precautions	1
4. Getting To Know the Autel Smart Controller	2
5. Item List	2
6. Controller Layout	4
7. Powering On the Smart Controller	5
7.1 Check the Battery Information	5
7.2 Power On/Off	6
7.3 Charging	6
8. Antenna Adjustment	6
9. Frequency Match	7
10. Flying	8
11. Command Stick Operations (Mode 2)	9
12. Specifications	10

## 1. DISCLAIMER

To ensure safe and successful operation of your Autel smart remote controller, please strictly follow the operating instructions and steps in this guide.

If the user does not abide by the safety operation instructions, Autel Robotics will not be responsible for any product damage or loss in use, whether direct or indirect, legal, special, accident or economic loss (including but not limited to loss of profit), and does not provide warranty service. Do not use incompatible parts or use any method that does not comply with the official instructions of Autel Robotics to modify the product.

The safety guidelines in this document will be updated from time to time. To ensure you get the latest version, please visit the official website:  
<https://www.autelrobotics.com/>

## 2. BATTERY SAFETY

The Autel smart remote controller is powered by a smart lithium-ion battery. Improper use of lithium-ion batteries can be dangerous. Please ensure that the following battery usage, charging and storage guidelines are strictly followed.

### WARNING:

- Only use the battery and charger provided by Autel Robotics. It is forbidden to modify the battery assembly and its charger or use a third-party equipment to replace it.
- The electrolyte in the battery is extremely corrosive. If the electrolyte spills into your eyes or skin accidentally, please rinse the affected area with clean water and seek medical attention immediately.

## 3. PRECAUTIONS

When using the Autel Smart Controller (hereinafter referred to as the "Smart Controller"), if improperly used, the aircraft may cause a certain degree of injury and damage to people and property. Please be cautious while using it. For details, please refer to the aircraft's disclaimer and safety operation guidelines.

1. Before each flight, make sure that the Smart Controller is fully charged.
2. Make sure the Smart Controller antennas are unfolded and adjusted to the appropriate position to ensure the best possible flight results.







3. If the Smart Controller antennas are damaged, it will affect the performance, please contact the after-sales technical support immediately.
4. If the aircraft is changed, it needs to be repaired before using.
5. Make sure to turn off the aircraft power before turning off the remote controller each time.
6. When not in use, make sure to fully charge the smart controller every three months.
7. Once the power of the smart controller is less than 10%, please charge it to prevent an over-discharge error. This is caused by the long-term storage with a low battery charge. When the smart controller will not be in use for an extended time, discharge the battery between 40%-60% before storage.
8. Do not block the vent of the Smart Controller to prevent overheating and diminished performance.
9. Do not disassemble the smart controller. If any parts of the controller are damaged, contact Autel Robotics After-Sale Support.

#### 4. AUTEL SMART CONTROLLER

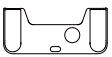
The Autel Smart Controller can be used with any supported aircraft, and it provides a high-definition real time image transmission and it can control the aircraft and camera up to 13km (8.08 miles) [1] communication distance. The Smart Controller has a built-in 7.9-inch 2048x1536 ultra-high-definition, ultra-bright screen with a maximum 2000nit brightness. It provides clear image display under the bright sunlight. With its convenient, built-in 128G memory it can store your photos and videos on board. The operating time is about 4.5 hours when the battery is fully charged and the screen is at 50% brightness <sup>②</sup>.

#### 5. ITEM LIST

NO	DIAGRAM	ITEM NAME	QTY
1		7.9 inch Smart Remote Controller	1PC

2		Smart Controller Protective Case	1PC
3		A/C adapter	1PC
4		USB Type-C cable	1PC
5		Chest Strap	1PC
6		Spare Command Sticks	2PCS
7		Documentation (Quick Start Guide)	1PC

[1] Fly in an open, unobstructed, electromagnetic interference-free environment. The smart controller can reach the maximum communication distance under FCC standards. Actual distance may be less based on the local flight environment.

[2] The above-mentioned working time is measured in a laboratory environment at room temperature. The battery life will vary in different usage scenarios.

## 6. CONTROLLER LAYOUT

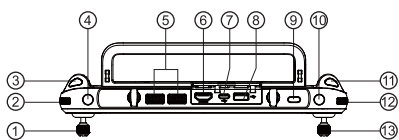

Top view

- |                             |                            |                          |
|-----------------------------|----------------------------|--------------------------|
| 1. Left Command Stick       | 5. Air Outlet              | 11. Photo Shutter Button |
| 2. Gimbal Pitch Angle Wheel | 6. HDMI Port               | 12. * Zoom Control Wheel |
| 3. Video Recording Button   | 7. USB TYPE-C Port         | 13. Right Command Stick  |
| 4. Customizable Button C1   | 8. USB TYPE-A Port         |                          |
|                             | 9. Power Button            |                          |
|                             | 10. Customizable Button C2 |                          |

\*The function may alter, please take the practical effect as standard.

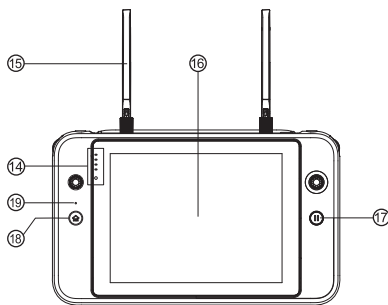

Front view

- |                       |                                 |
|-----------------------|---------------------------------|
| 14. Battery Indicator | 17. Pause Button                |
| 15. Antenna           | 18. Return to Home (RTH) Button |
| 16. Touch Screen      | 19. Microphone                  |

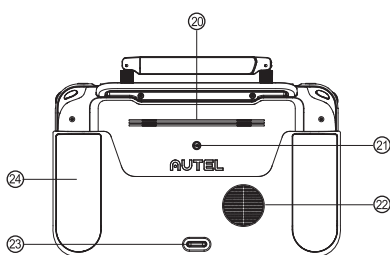

Rear view

- 20. Speaker hole
- 21. Tripod Mount Hole
- 22. Air Vent
- 23. Bottom Hook
- 24. Grips

**7. POWER ON THE SMART CONTROLLER**

**7.1 Check Battery Level**

Press the power button to check the battery life





	1 light solid on: Battery $\geq$ 25%
	2 lights solid on: Battery $\geq$ 50%
	3 lights solid on: Battery $\geq$ 75%
	4 lights solid on: Battery $\geq$ 100%

### 7.2 Powering on/off

Press and hold the power button for 2 sec to turn on and off the Smart Controller.

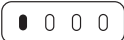
### 7.3 Charging

Remote Controller indication light status

	1 light solid on: Battery $\geq$ 25%
	2 lights solid on: Battery $\geq$ 50%
	3 lights solid on: Battery $\geq$ 75%
	4 lights solid on: Battery $\geq$ 100%

 **NOTE:** LED indication light will blink while charging

## 8. ANTENNA ADJUSTMENT

Unfold the Smart Controller antennas and adjust them to the optimal angle. The signal strength varies when the antenna angle is different. When the antenna and the back of the remote controller are at an angle of 180° or 260°, and the antenna surface is facing the aircraft, the signal quality of aircraft and controller will reach the optimal condition.



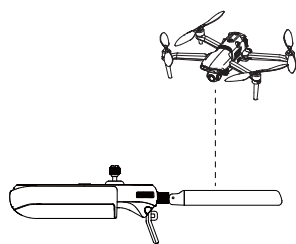

**NOTE:**

LED indicator will flash while charging

- Do not use other communication equipment which has the same frequency band at the same time, to avoid the interference to the Smart Controller signal.
- During operation, the Autel Explorer app, will prompt the user when the image transmission signal is poor. Adjust the antenna angles according to the prompts to ensure the Smart Controller and aircraft have the best communication range.

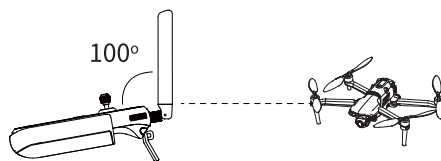

## 9. FREQUENCY MATCH

When the Smart Controller and the aircraft are purchased as a set, the Smart Controller has been matched to the aircraft at the factory, and it can be used directly after the aircraft is activated.

If purchased separately, please use the following methods to link.

1. Press (short press) the linking button next to the USB port on the right side of the aircraft body to put the aircraft into the linking mode.
2. Power on the Smart Controller and run the Autel Explorer app, enter the mission flight interface, click the gear icon in the upper right corner, enter the settings menu, click "remote control -> data transmission and image transmission linking-> start linking", wait a few seconds until the data transmission is set correctly and the linking is a success.





## 10. FLIGHT

Open the Autel Explorer app and enter the flight interface.

Before takeoff, place the aircraft on a flat and level surface and face the rear side of the aircraft towards you.

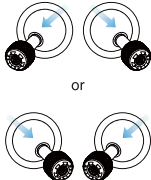
### Manual takeoff and landing (Mode 2)

Toe in or out on both command sticks for about 2 seconds to start the motors

Manual Takeoff	
 <p>or</p>	 <p>Push up slowly Left Command Stick (mode 2)</p>
Manual landing	Automatic takeoff and landing
 <p>Push down slowly Left Command Stick (Mode 2)</p>	 <p>Press and hold the take-off/landing button 3 seconds</p>



**NOTE:**

Before takeoff, place the aircraft on a flat and level surface and face the rear side of the aircraft towards you.

Mode 2 is the default control mode of the Smart Controller. During the flight, you can use the left stick to control the flight altitude and direction, and use the right stick to control the forward, backward, left and right directions of the aircraft.



**NOTE:**

- Please make sure that the Smart Controller has successfully matched with the aircraft.
- For more functions of the Smart Controller, please read the user manual for details

### 11. Command Stick Control (Mode 2)

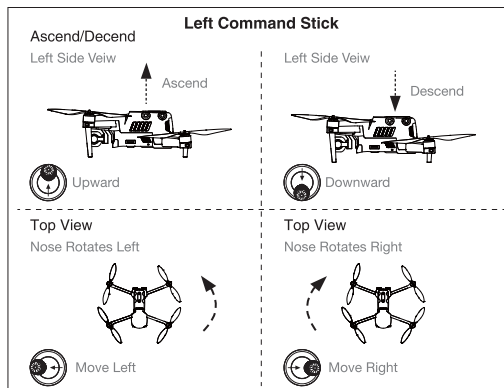

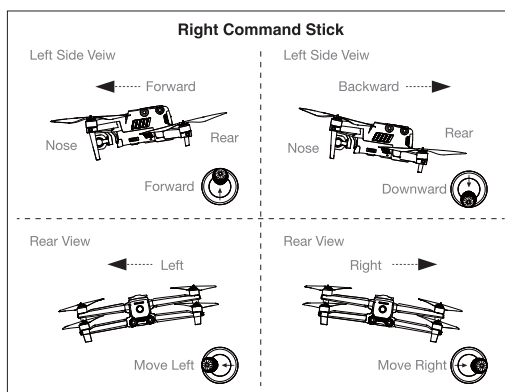

## 12. Specifications

### Image Transmission

Max Signal Transmission Distance (No interference, No obstacles)	FCC: 13 km CE / MIC: 7 km SRRC: 7 km
---	--

### Digital transmission

Working Frequency	5.725 - 5.755 GHz
-------------------	-------------------

### Wi-Fi

Protocol	Wi-Fi Direct, Wi-Fi Display, 802.11a/b/g/n/ac Support 2 x 2 MIMO Wi-Fi
----------	--

\* Working Frequency            2.400 - 2.4835 GHz;  
5.150 - 5.250GHz;  
5.650 - 5.755GHz;  
5.725 - 5.850 GHz

#### **Other Specifications**

---

Battery	Name: Intelligent Li-ion battery Capacity: 5800mAh Voltage: 11.55V Battery Type: Li-ion Battery Energy: 67 Wh Charging time: 120 min
Operating Hours	~ 3h (Max Brightness) ~ 4.5 h (50% Brightness)
Internal Storage	128GB
Video Output port	HDMI Port
USB-A Voltage/Current	5V / 2A
Operating Environment Temp	-20 C to 40 C
Storage temperature	-20 C to 60 C (within a month) -20 C to 45 C (between one to three months) -20 C to 23 C (one year)
Charging Environment Temp	0 C to 40 C
**Supported Aircrafts	EVO II Series EVO II RTK Series EVO II Enterprise
Satellite Positioning Module	GPS + GLONASS + Galileo
Dimensions	303x190x87mm (with antenna folded) 303x273x87mm (with antenna unfolded)
Weight	1150g (without protective case) 1250g (with protective case)

 **NOTE:**

- When external devices are connected and powered by the remote controller, the battery life may be reduced.
- \* The working frequency band varies according to different countries and models.
- \*\* We will support more Autel Robotics aircraft in the future, please visit our official website <https://www.autelrobotics.com/> for the latest information.

**FCC Caution:**

Operation of 5150-5250 MHz is restricted to indoor use only.

Any Changes or modifications not expressly approved by the party responsible for compliance could void the user's authority to operate the equipment.

This device complies with part 15 of the FCC Rules. Operation is subject to the following two conditions: (1) This device may not cause harmful interference, and (2) this device must accept any interference received, including interference that may cause undesired operation.

**IMPORTANT NOTE:**

Note: This equipment has been tested and found to comply with the limits for a Class B digital device, pursuant to part 15 of the FCC Rules. These limits are designed to provide reasonable protection against harmful interference in a residential installation. This equipment generates, uses and can radiate radio frequency energy and, if not installed and used in accordance with the instructions, may cause harmful interference to radio communications. However, there is no guarantee that interference will not occur in a particular installation. If this equipment does cause harmful interference,

you may wish to take the following steps to correct the interference: (1) Turn the equipment off and on, (2) reorient or relocate the receiving antenna, (3) increase the separation between the equipment and receiver, (4) connect the equipment into an outlet on a circuit different from that to which the receiver is connected, (5) consult the dealer or an experienced radio/TV technician for help.

—Reorient or relocate the receiving antenna.

—Increase the separation between the equipment and receiver.

—Connect the equipment into an outlet on a circuit different from that to which the receiver is connected.

—Consult the dealer or an experienced radio/TV technician for help.

**Specific Absorption Rate (SAR) information**

SAR tests are conducted using standard operating positions accepted by the FCC with the device transmitting at its highest certified power level in all tested frequency bands, although the SAR is determined at the highest certified power level, the actual SAR level of the device while operating can be well below the maximum value. In general, the closer you are to a wireless base station antenna, the lower the power output. Before a new model device is available for sale to the public, it must be tested and certified to the FCC that it does not exceed the exposure limit established by the FCC. Tests for each device are performed in positions and locations (e.g. at the ear and worn on the body) as required by the FCC.

For limb worn operation, this device has been tested and meets the FCC RF exposure guidelines when used with an accessory designated for this product or when used with an accessory that contains no metal.

For body worn operation, this device has been tested and meets the FCC RF exposure guidelines when used with an accessory designated for this product or when used with an accessory that contains no metal and that positions the device a minimum of 10mm from the body.

#### ISED Warning

Operation of 5150-5250 MHz is restricted to indoor use only.

This device complies with Innovation, Science, and Economic Development Canada licence-exempt RSS standard(s).

Operation is subject to the following two conditions: (1) this device may not cause interference, and (2) this device must accept any interference, including interference that may cause undesired operation of the device.

Le fonctionnement de 5150-5250 MHz est limité à une utilisation en intérieur uniquement. Le présent appareil est conforme aux CNR d'Innovation, Sciences et Développement économique Canada applicables aux appareils radio exempts de licence. L'exploitation est autorisée aux deux conditions suivantes :

- (1) l'appareil ne doit pas produire de brouillage, et
- (2) l'utilisateur de l'appareil doit accepter tout brouillage radioélectrique subi, même si le brouillage est susceptible d'en compromettre le fonctionnement.

#### IMPORTANT NOTE:

Specific Absorption Rate (SAR) information SAR tests are conducted using standard operating positions accepted by the ISED with the device transmitting at its highest certified power level in all tested frequency bands, although the SAR is determined at the highest certified power level, the actual SAR level of the device while operating can be well below the maximum value, in general, the closer you are to a wireless base station antenna, the lower the power output.

Before a new model device is available for sale to the public, it must be tested and certified to the ISED that it does not exceed the exposure limit established by the ISED. Tests for each device are performed in positions and locations (e.g. at the ear and worn on the body) as required by the ISED.

For limb worn operation, this device has been tested and meets the ISED CRF exposure guidelines when used with an accessory designated for this product or when used with an accessory that contains no metal.

For body worn operation, this device has been tested and meets the ISED RF exposure guidelines when used with an accessory designated for this product or when used with an accessory that contains no metal and that positions the device a minimum of 10mm from the body.

Taux d'absorption spécifique (SAR) informations les tests SAR sont effectués en utilisant les positions opérationnelles normalisées acceptées par la ISED, le dispositif émettant à son niveau de puissance certifié le plus élevé dans toutes les bandes de fréquence testées. Avant qu'un nouveau modèle de dispositif ne soit disponible à la vente au public, il doit être testé et certifié à la ISED qu'il ne dépasse pas la limite d'exposition établie par la ISED, les Tests pour chaque dispositif sont effectués dans des positions et des emplacements (par exemple à l'oreille et porté sur le corps) comme l'exige la ISED.

Pour le fonctionnement des membres usés, cet appareil a été testé et répond aux lignes directrices d'exposition aux RF ISED lorsqu'il est utilisé avec un accessoire désigné pour ce produit ou lorsqu'il est utilisé avec un accessoire qui ne contient pas de métal.

Pour le fonctionnement du corps usé, cet appareil a été testé et répond aux lignes directrices d'exposition RF ISED lorsqu'il est utilisé avec un accessoire désigné pour ce produit ou lorsqu'il est utilisé avec un accessoire qui ne contient pas de métal et qui positionne cet appareil à au moins 10mm du corps.

#### Steps to use electronic tags

Step 1: Select "Camera"

Step 2: Click the gear icon in the upper right corner, enter the settings menu

Step 3: Select "Certification Mark"

**AUTEL**

[WWW.AUTELROBOTICS.COM](http://WWW.AUTELROBOTICS.COM)

© 2020-2021 Autel Robotics Co., Ltd. All Rights Reserved