

# EVO™

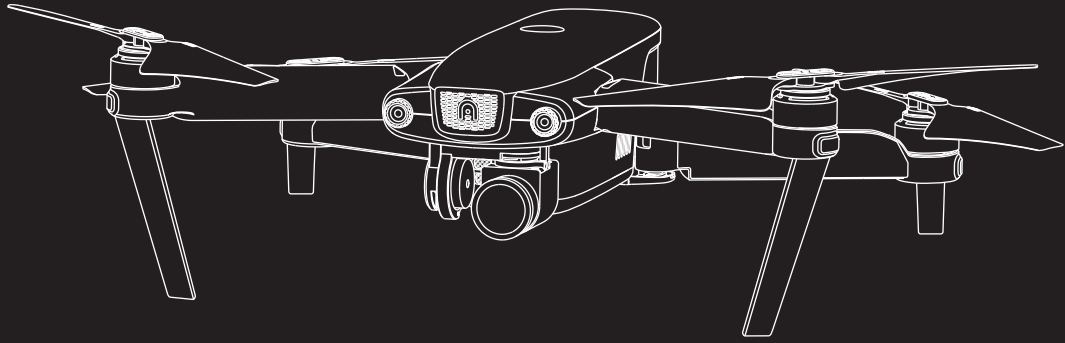

## Quick Guide

With XI-5A Gimbal

**AUTEL**  
ROBOTICS

# 1. WELCOME TO EVO

Now you can create, discover and explore like never before.

EVO delivers not only advanced features like obstacle avoidance and intelligent flight modes but also the high-tech muscle that brings home a top speed of 44 mph, 30-minute flight time and an operating distance of 4.2 miles.

In-flight performance, however, is just the start. EVO's stabilized 3-axis camera allows you to shoot at up to 4K/60p, and view the live feed at up to 720p on your mobile device or the remote control's built-in OLED screen.

Welcome to the Autel Robotics family. Use this guide to get an overview of EVO's features and how to use them.

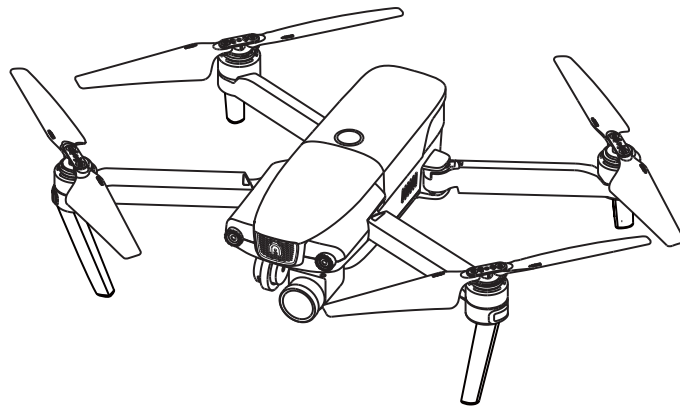

## IMPORTANT:

Consult all reviewable documentation before your first flight. Failure to operate the aircraft responsibly could lead to injury or damages and may void any applicable warranty coverage.

## 2. AIRCRAFT FRONT & RIGHT VIEWS

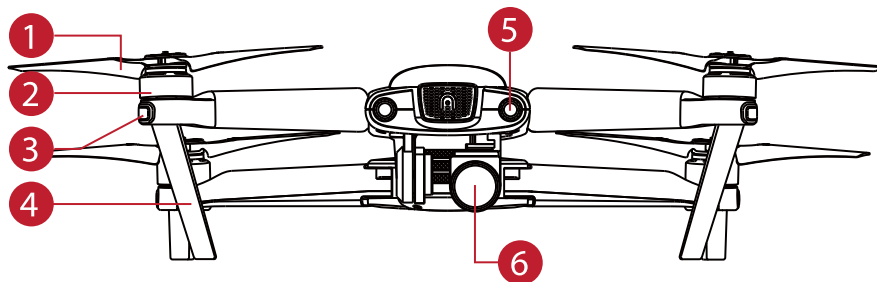

- |                         |                          |
|-------------------------|--------------------------|
| 1. Propellers           | 4. Landing Gear          |
| 2. Motors               | 5. Forward Vision System |
| 3. Front LED Indicators | 6. Camera Gimbal         |

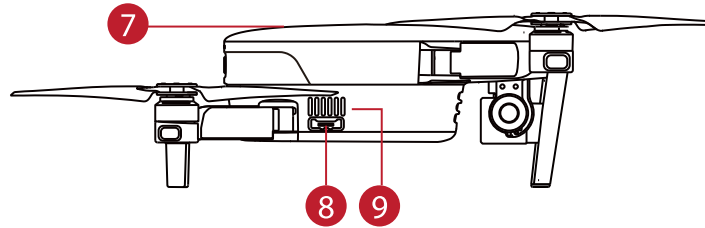

- 7. Aircraft Battery
- 8. Micro-SD Card Slot
- 9. Fan Exhaust

### 3. AIRCRAFT REAR & BOTTOM VIEWS

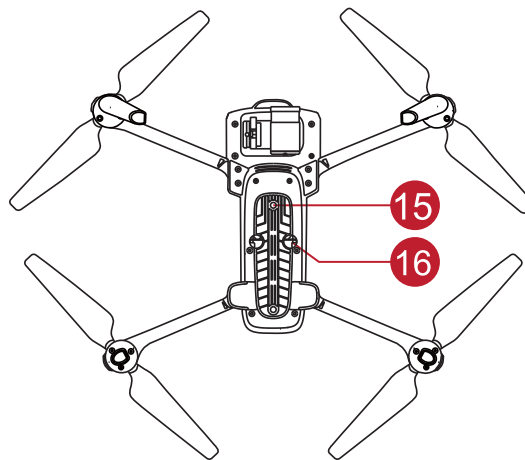
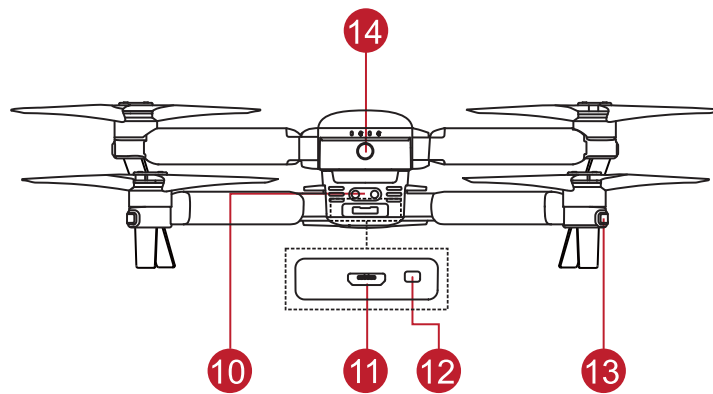

- |   |                            |
|---|----------------------------|
| 10. Rear Avoidance Sensor                           | 13. Rear LED Indicators    |
| 11. Micro-USB Port                                  | 14. Power Button           |
| 12. Remote Control Pairing Button/Pairing Indicator | 15. Downward Vision System |
|   | 16. Ultrasonic Sensor      |

### 4. FLIGHT LED INDICATIONS

An LED indicator is located on the end of each aircraft arm. The front two LEDs will light up solid red to help you identify the direction of the aircraft's nose. The rear LEDs will display the current flight status of the aircraft. Refer to this chart to confirm the meaning of the different status indicators.

**Color Key :**

R — Red Color

Y — Yellow Color

G — Green Color

**Indicator Key:**

Solid Light

Slow Flashing: Flashes once every two seconds

Fast Flashing: Flashes two times per second

Double Flashing: Flashes two times then pauses and repeats

Alternate flashing: Alternate among different colors

Example: “R- Solid Light” Solid Red light

<b>Normal Status</b>	
<b>RGY</b> -Alternate Flashing	System self-test is activated
<b>YG</b> -Alternate Flashing	The aircraft is warming up
<b>G</b> -Slow Flashing	The aircraft is in GPS mode
<b>Warning</b>	
<b>Y</b> -Slow Flashing	The aircraft is in ATTI mode
<b>Y</b> -Fast Flashing	No connection between the aircraft and remote control
<b>R</b> -Slow Flashing	Low Battery Warning (less than 25%)
<b>R</b> -Fast Flashing	Critically Low Battery Warning (less than 15%)
<b>R</b> -Solid Light	Critical problems, IMU error
<b>RY</b> -Alternate Flashing	Abnormal compass, calibration is required / Magnetometer interference
<b>Compass Calibration</b>	
<b>Y</b> - Fast Flashing	Be ready to calibrate the compass / The aircraft is calibrating
<b>G</b> -Solid Light	Calibration is successful
<b>R</b> - Solid Light	Calibration is failed

## 5. REMOTE CONTROL

1. Mobile Device Holder
2. Flight Information Panel
3. Command Sticks
4. Hand Grips
5. Take-off/Landing Button
6. Power Button
7. USB Ports
8. Pause Button
9. Go Home Button
10. Antennas

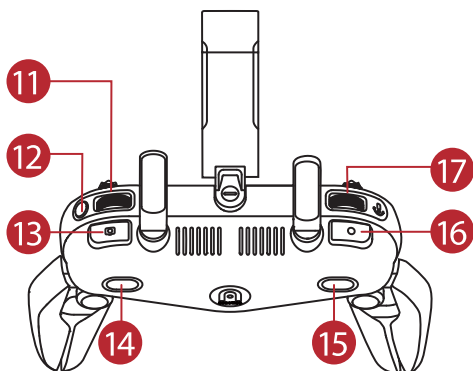
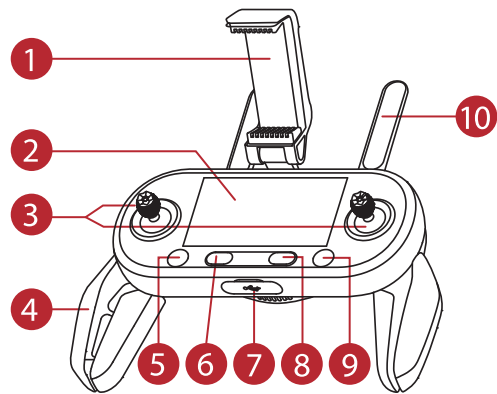

11. Screen Navigation Dial
12. Screen Navigation Button
13. Shutter Button
14. Customizable Button A
15. Customizable Button B
16. Record Button
17. Gimbal Pitch Dial

## 6. CHARGING THE AIRCRAFT & REMOTE CONTROL

The aircraft battery and remote control can be charged simultaneously using the supplied charger and following the steps below.

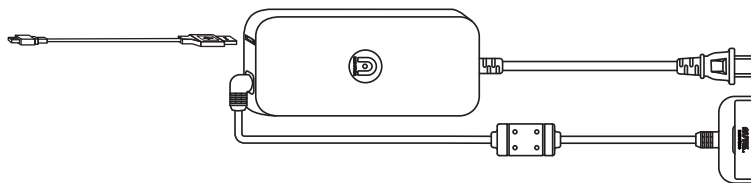

1. Aircraft Battery: Plug the connector cable into the charging port.

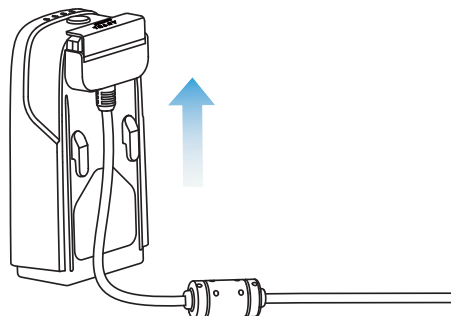

**IMPORTANT:** The aircraft battery isn't activated out of the box. Plug the charging connector into the battery to activate it before initial use.

2. Remote Control: Open the USB port's protective cover. Then plug the USB charging cable into the port.

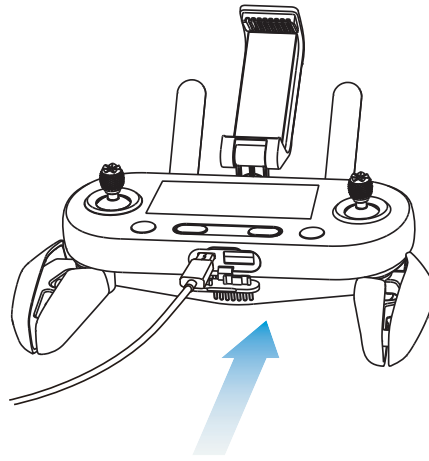

3. Plug in the charger to a power outlet.

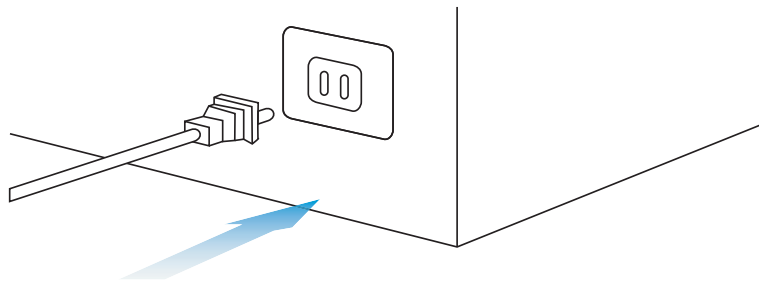

**NOTE:** Always fly with both aircraft and remote control batteries fully charged.  
For a complete charge, the aircraft battery requires approximately 80 minutes, and the remote control 180 minutes.

## 7. INSTALLING THE AUTEL EXPLORER™ APP (OPTIONAL)

While the aircraft can be flown using only the remote control, our mobile app offers you access to advanced flight, photography and video functionality. Follow the steps below to get connected.

1. Search for “Autel Explorer” from the App Store or Google Play and install the app for EVO on your mobile device.
2. Launch the app on your mobile device.
3. Connect the mobile device to the remote control by following the onscreen prompts.



**NOTE:** Autel Explorer™ supports iOS 9.0 or later and Android 4.4 or later.

## 8. PREPARING THE AIRCRAFT

1. Remove the gimbal holder, as well as the warning cards from the motors.

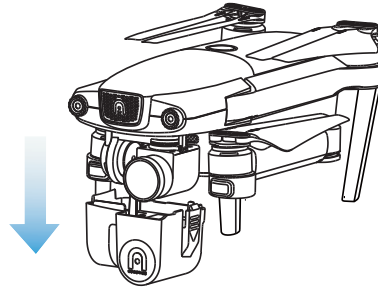

2. Unfold the front arms and propellers.

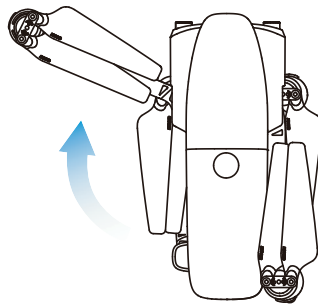

3. Unfold the rear arms and propellers.

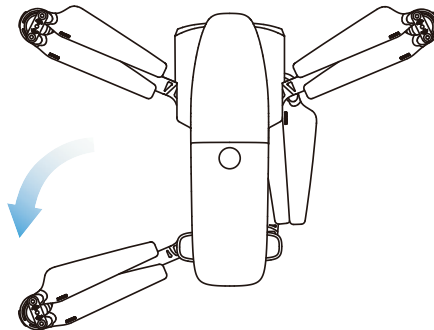

### **IMPORTANT:**

**Usage:** Unfold the front arms first, then the rear arms.

**Storage:** Fold the rear arms first, then the front arms.

## 9. INSTALLING NEW PROPELLERS

Because the propellers come attached to the aircraft, the following instructions apply if you need to reinstall propellers. Propellers must be undamaged and firmly attached.

The propellers and motors are color-coded in order to clearly mark how they should be paired.

## Attaching the Propellers

1. Make sure the aircraft is powered off.
2. Match the propeller to its paired motor according to the color code.

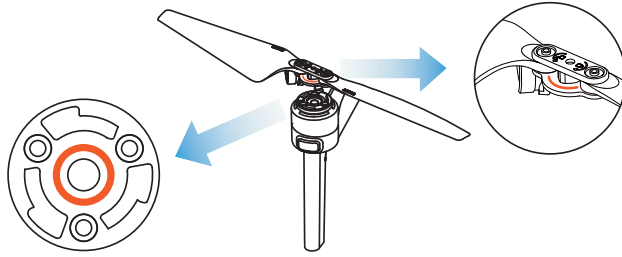

3. Press down and rotate in the lock direction until the propeller is firmly attached.

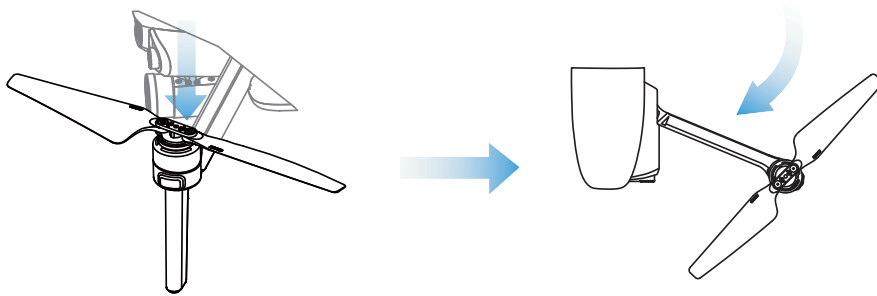

## Detaching the Propellers

1. Make sure the aircraft is powered off.
2. Press each propeller down firmly and rotate in the unlock direction to detach the propeller.

**NOTE:** When the aircraft is not in use, we recommend folding in the arms and propellers.

## 10. PREPARING THE REMOTE CONTROL

1. Unfold the mobile device holder, antennas, and hand grips.

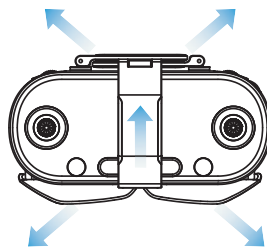

2. Position the antennas vertically in order to ensure the strongest possible signal.

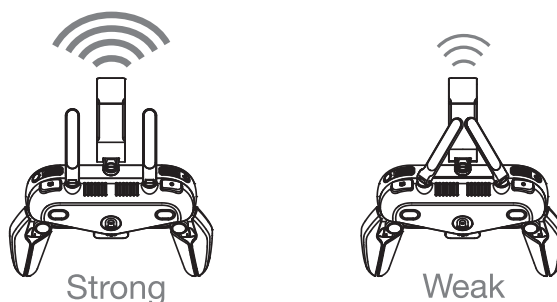



## 11. POWERING UP

1. Press and hold the power button for 2 seconds.

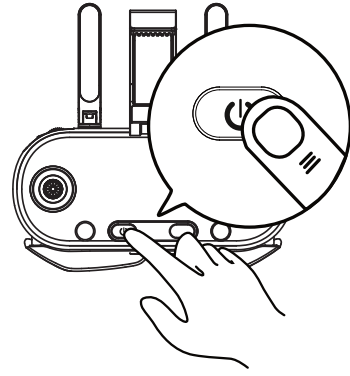

2. Press and hold the aircraft power button for 3 seconds. The current battery level will be clearly displayed.

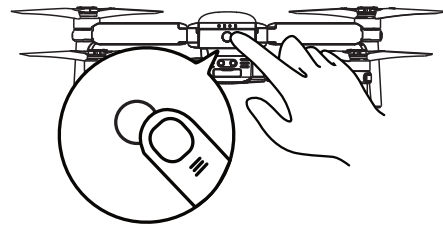

**IMPORTANT:** Make sure that you always turn on the remote control before turning on the aircraft. Similarly, the aircraft should be powered down before turning off the remote control.

## 12. TAKEOFF

1. Place the aircraft on a level surface. Stand well clear of the rear of the aircraft.
2. Start the motors by holding both command sticks for two seconds in one of these positions:

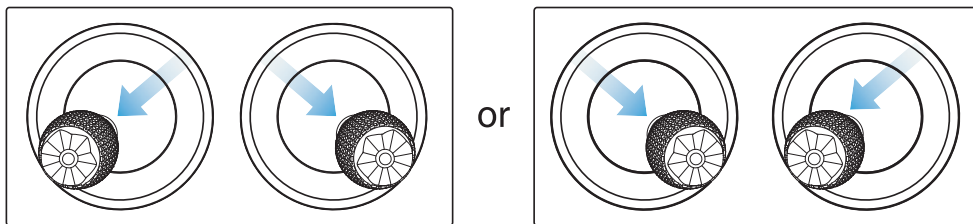

3. With the motors spinning, choose one of the following methods to take off:





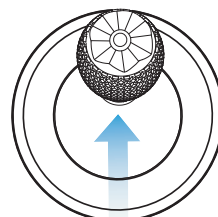





Hold the Takeoff/Landing Button for 2s

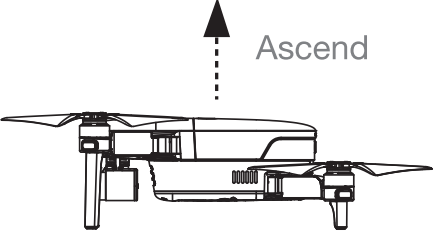

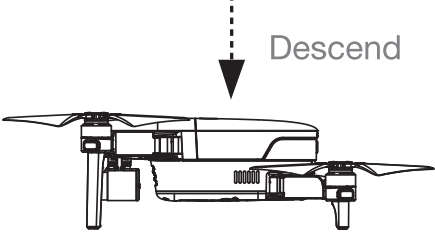

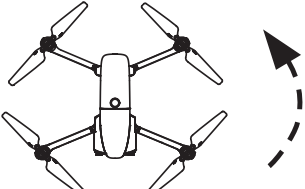

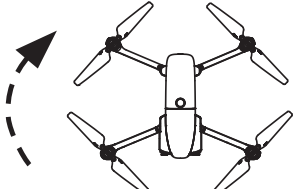

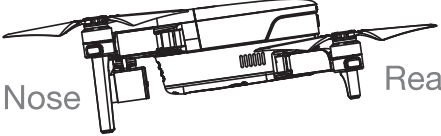

Push the Left Command Stick slowly upward (Mode 2)

# 13. COMMAND STICK CONTROLS(MODE 2)

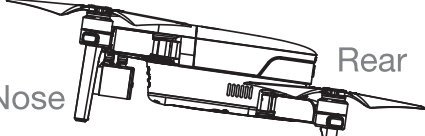
### Left Command Stick

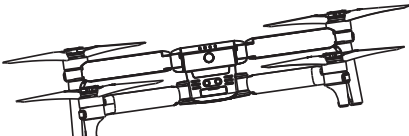
<p>Left Side Veiw</p> <p>Ascend</p>  <p>Upward</p> 	<p>Left Side Veiw</p> <p>Descend</p>  <p>Downward</p> 
<p>Top View</p> <p>Nose Rotates Left</p>  <p>Move Left</p> 	<p>Top View</p> <p>Nose Rotates Right</p>  <p>Move Right</p> 

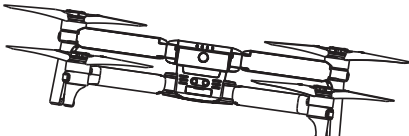
### Right Command Stick

<p>Left Side Veiw</p> <p>Forward</p>  <p>Nose</p> <p>Rear</p> <p>Upward</p> 	<p>Left Side Veiw</p> <p>Backward</p>  <p>Nose</p> <p>Rear</p> <p>Downward</p> 
<p>Rear View</p> <p>Left</p>  <p>Move Left</p> 	<p>Rear View</p> <p>Right</p>  <p>Move Right</p> 

## 14. LANDING & MOTOR SHUTDOWN (MODE 2)

### IMPORTANT:

Make sure to land the aircraft on a flat and level surface in an open area.

1. Choose one of the following methods to land the aircraft:



Hold the Takeoff/Landing Button for 2s

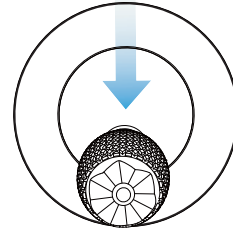

Push the Left Command Stick slowly downwards

2. After landing, shut down the motors by one of the following methods:

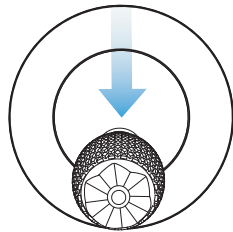

Push the Left Command Stick to the bottom and hold for 2s

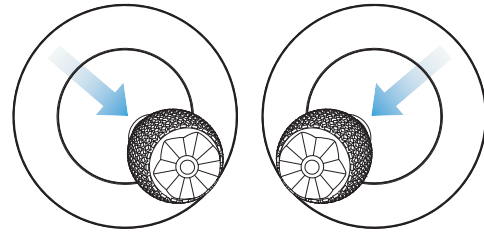

Hold both Command Sticks toe-in for 2s

## Aircraft Battery Specifications

Battery Type	Lithium-Polymer
Capacity	4300mAh
Battery Voltage	11.4V
Charging Environment Temperature	10°C~45°C (50°F~113°F)
Discharging Environment Temperature	-20°C~60°C (-4°F~140°F)
Storage Temperature & Humidity	Temp: -10°C~40°C (14°F~104°F) Humidity: 65±20%RH
Flight Time	30 mins

## Camera Gimbal Specifications

Operating Current	150mA@12V (Non-video Mode)
Input Voltage	12V
Operating Temperature	-10°C~50°C (14°F~122°F)
Weight	67.5g (Camera incl.)
Dimensions (Damping device excl.)	42m x 49mm x 45mm
Control Accuracy	Pitch: ±0.015° / Roll: ±0.015° / Yaw: ±0.015°
Max. Angular Velocity	Pitch: ±200°/S / Yaw: ±200°/S
Controllable Range	Pitch: 0°~90° / Yaw: ±50°

## Camera Specifications

Operating Environment Temperature	0°C~40°C (32°F~104°F)
Still Photography Modes	Single shot Burst shooting Auto Exposure Bracketing (AEB) Time-lapse
Video Recording Modes	Normal
Max. Field of View	94°

Supported SD Card Types	Micro-SD card
Storage Capacity	4GB-128GB
Lense Diameter	25mm
Camera Bit Rate	100M
File Formats	FAT32/exFAT Photo: JPG/DNG Video: MOV/MP4

### Aircraft Specifications

Max. Take-off Weight	1000g
Hover Precision	GPS+ Ultrasonic+ IMU: Horizontal: $\pm 1.5\text{m}$ , Vertical: $\pm 0.2\text{m}$ ; Vision+ IMU: Horizontal: $\pm 0.1\text{m}$ , Vertical: $\pm 0.1\text{m}$
Max. Yaw Rate	200dps
Max. Inclination Angle	35deg
Max. Ascent/Descent Speed	Ascent: 5m/s; Descent: 3m/s
Max. Horizontal Speed	20m/s
Diagonal Wheelbase	338mm
Propeller Size	8.3inches
Video Link Frequency	2.4GHz~2.4835GHz
Receiver Frequency	2.4GHz~2.4835GHz
Flight Modes	GPS Mode, ATTI Mode
Operating Environment Temperature	0°C~40°C (32°F~104°F)
Storage Temperature	-10°C~40°C (14°F~104°F)
Weight (Battery&Propellers included)	863g

## Remote Control Specifications

OLED Screen Nits	330
Max Operating Time	3.8 hours
RF Receiver Operating Frequency	2.4GHz~2.4835GHz
Video Link Frequency	2.4GHz~2.4835GHz
Operating Temperature	0°C~40°C (32°F~104°F)
Storage Temperature	1 year: -20~25°C(-4°F~77°F) 3 months: -20~45°C (-4°F~113°F)
Max Control and Video Transmission Distance	7km
Transmission Power (EIRP)	FCC: <=26 dBm CE: <=20 dBm
Operating Current/Voltage	2A @ 3.7V
Battery	5000mAH
Power Consumption	7.4W
Weight (battery included)	370g

## FCC Compliance

### FCC Warning Message

Any changes or modifications not expressly approved by the party responsible for compliance could void the user's authority to operate the equipment.

This device complies with part 15 of the FCC Rules. Operation is subject to the following two conditions: (1) This device may not cause harmful interference, and (2) this device must accept any interference received, including interference that may cause undesired operation.

### FCC Radiation Exposure Statement:

#### For EVO Pro

This equipment complies with FCC radiation exposure limits set forth for an uncontrolled environment. This equipment should be installed and operated with minimum distance 20cm between the radiator& your body. This transmitter must not be co-located or operating in conjunction with any other antenna or transmitter.

**For EF7-1, SAR tests are conducted using standard operating positions accepted by the FCC/ISED with the device. when used, please keep the distance with a minimum of 10mm from the body.**

Note: This equipment has been tested and found to comply with the limits for a Class B digital device, pursuant to part 15 of the FCC Rules. These limits are designed to provide reasonable protection against harmful interference in a residential installation. This equipment generates uses and can radiate radio frequency energy and, if not installed and used in accordance with the instructions, may cause harmful interference to radio communications. However, there is no guarantee that interference will not occur in a particular installation. If this equipment does cause harmful interference to radio or television reception, which can be determined by turning the equipment off and on, the user is encouraged to try to correct the interference by one or more of the following measures:

- Reorient or relocate the receiving antenna.
- Increase the separation between the equipment and receiver.
- Connect the equipment into an outlet on a circuit different from that to which the receiver is connected.
- Consult the dealer or an experienced radio/TV technician for help.

### ISED RSS warning

This device complies with ISED licence-exempt RSS standard (s). Operation is subject to the following two conditions: (1) this device may not cause interference, and (2) this device must accept any interference, including interference that may cause undesired operation of the device.

Le présent areil est conforme aux CNR d'Industrie Canada licables aux areils radio exempts de licence.

L'exploitation est autorisée aux deux conditions suivantes:

- (1) l'areil ne doit pas produire de brouillage, et
- (2) l'utilisateur de l'areil doit accepter tout brouillage radioélectrique subi, même si le brouillage est susceptible d'en compromettre le fonctionnement.

### ISED Radiation Exposure Statement:

#### For EVO Pro

This equipment complies with ISED RF radiation exposure limits set forth for an uncontrolled environment. This transmitter must not be co-located or operating in conjunction with any other antenna or transmitter. This equipment should be installed and operated with minimum distance 20cm between the radiator& your body.

**For EF7-1, SAR tests are conducted using standard operating positions accepted by the FCC/ISED with the device. when used, please keep the distance with a minimum of 10mm from the body.**

Any Changes or modifications not expressly approved by the party responsible for compliance could void the user's authority to operate the equipment.

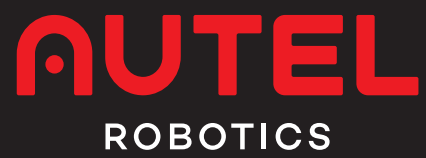

[WWW.AUTELROBOTICS.COM](http://WWW.AUTELROBOTICS.COM)

© 2017-2018 Autel Robotics Co., Ltd. All Rights Reserved