

---

# FCC Test Report

---

Report No.: AGC09900170402F1

**FCC ID** : 2AGND50XX  
**TYPE OF AUTHORIZATION** : Certification  
**APPLICATION PURPOSE** : Original Equipment  
**PRODUCT DESIGNATION** : Dualband two way radio  
**BRAND NAME** : BTECH  
**TEST MODEL** : UV-50X2  
**CLIENT** : BTECH (BaoFeng Tech)  
**DATE OF ISSUE** : Apr.28, 2017  
**STANDARD(S)** : FCC Part 15 Rules  
**REPORT VERSION** : V 1.0

Attestation of Global Compliance (Shenzhen) Co., Ltd



**CAUTION:**

This report shall not be reproduced except in full without the written permission of the test laboratory and shall not be quoted out of context.



### Report Revise Record

Report Version	Revise Time	Issued Date	Valid Version	Notes
V1.0	/	Apr.28, 2017	Valid	Original Report

## TABLE OF CONTENTS

<b>1. VERIFICATION OF COMPLIANCE .....</b>	<b>4</b>
<b>2. PRODUCT INFORMATION .....</b>	<b>5</b>
<b>3. TEST FACILITY .....</b>	<b>6</b>
<b>4. SUPPORT EQUIPMENT LIST .....</b>	<b>7</b>
<b>5. SYSTEM DESCRIPTION.....</b>	<b>7</b>
<b>6. SUMMARY OF TEST RESULTS .....</b>	<b>8</b>
<b>7. FCC LINE CONDUCTED EMISSION TEST .....</b>	<b>9</b>
7.1. TEST EQUIPMENT OF LINE CONDUCTED EMISSION TEST.....	9
7.2. LIMITS OF LINE CONDUCTED EMISSION TEST.....	9
7.3. BLOCK DIAGRAM OF LINE CONDUCTED EMISSION TEST .....	9
<b>8. FCC RADIATED EMISSION TEST .....</b>	<b>12</b>
8.1. TEST EQUIPMENT OF RADIATED EMISSION .....	12
8.2. LIMITS OF RADIATED EMISSION TEST .....	12
8.3. BLOCK DIAGRAM OF RADIATED EMISSION TEST.....	12
8.4. PROCEDURE OF RADIATED EMISSION TEST .....	13
8.5. TEST RESULT OF RADIATED EMISSION TEST.....	14
<b>9. ANTENNA CONDUCTED POWER FOR RECEIVERS.....</b>	<b>16</b>
<b>APPENDIX 1 PHOTOGRAPHS OF TEST SETUP .....</b>	<b>19</b>
<b>APPENDIX 2 PHOTOGRAPHS OF EUT .....</b>	<b>20</b>

## 1. VERIFICATION OF COMPLIANCE

<b>Applicant</b>	BTECH (BaoFeng Tech)
<b>Address</b>	702 N Industrial Ave Arlington South Dakota United States 57212
<b>Manufacturer</b>	BTECH (BaoFeng Tech)
<b>Address</b>	702 N Industrial Ave Arlington South Dakota United States 57212
<b>Product Designation</b>	Dualband two way radio
<b>Brand name:</b>	BTECH
<b>Test Model</b>	UV-50X2
<b>Hardware Version:</b>	XTJ-K-CP-V1.5
<b>Software Version:</b>	UC2M12
<b>Measurement Procedure</b>	ANSI C63.4: 2014
<b>Date of test:</b>	Apr.24, 2017 to Apr.28, 2017

The above equipment was tested by Dongguan Precise Testing Service Co., Ltd. for compliance with the requirements set forth in the FCC Rules and Regulations Part 15, the measurement procedure according to ANSI C63.4:2014. This said equipment in the configuration described in this report shows the maximum emission levels emanating from equipment are within the compliance requirements.

The test results of this report relate only to the tested sample identified in this report.

Tested by



Steven Zhou(Zhou Pengyun) Apr.28, 2017

Reviewed by



Bart Xie(Xie Xiaobin) Apr.28, 2017

Approved by



Solger Zhang(Zhang Hongyi)  
Authorized Officer Apr.28, 2017

## 2. PRODUCT INFORMATION

The EUT is a Dualband two way radio designed for voice communication. It is designed by way of utilizing the FM modulation achieves the system operating.

A major technical description of EUT is described as following:

<b>Communication Type</b>	Voice / Tone only
<b>Modulation</b>	FM
<b>RX Frequency Range</b>	RX:136 MHz -174MHz / 400 MHz -520MHz
<b>Emission Type</b>	16K0F3E(Wide) / 11K0F3E(Narrow)
<b>Antenna Designation</b>	Detachable
<b>Antenna type</b>	External antenna
<b>Antenna Gain</b>	0dBi
<b>Power Supply</b>	DC 13.8V by DC source

**I/O Port Information (Applicable Not Applicable)**

<b>I/O Port of EUT</b>			
<b>I/O Port Type</b>	<b>Q'TY</b>	<b>Cable</b>	<b>Tested with</b>
DC Input Port	1	2.2m, Unshielded	1
Antenna Connect Port	1	0	1
Hand-Operated Microphone Connect Port	1	0.6m, Unshielded	1

### 3. TEST FACILITY

<b>Site</b>	Dongguan Precise Testing Service Co., Ltd.
<b>Location</b>	Building D, Baoding Technology Park, Guangming Road2, Dongcheng District, Dongguan, Guangdong, China.
<b>Description</b>	The test site is constructed and calibrated to meet the FCC requirements in documents TIA/EIA 603
<b>FCC Registration No.</b>	371540

#### 4. SUPPORT EQUIPMENT LIST

Device Type	Manufacturer	Model Name	Serial No.	Data Cable	Power Cable
--	--	--	--	--	--

#### 5. SYSTEM DESCRIPTION

**EUT test procedure:**

1. Connect EUT and peripheral devices.
2. Power on the EUT, the EUT begins to work.
3. Running data transmission and make sure the EUT normal working.

#### EMC TEST MODES

No.	TEST MODES
1	Scanning mode + Receiving mode

**Note:** Only the result of the worst case was recorded in the report.

## 6. SUMMARY OF TEST RESULTS

FCC Rules	Description Of Test	Result
§15.107	Conduction Emission	N/A
§15.109	Radiated Emission	Compliant
§15.111	Antenna Conducted Power for receivers	Compliant



## 7. FCC LINE CONDUCTED EMISSION TEST

### 7.1. TEST EQUIPMENT OF LINE CONDUCTED EMISSION TEST

Description	Manufacturer	Model	Identifier	Cal. Date	Cal. Due
EMI Test Receiver	Rohde & Schwarz	ESCI	101417	July 3, 2016	July 2, 2017
Artificial Mains Network	Narda	L2-16B	000WX31025	July 3, 2016	July 2, 2017
RF Cable	SCHWARZBECK	AK9515E	96222	July 3, 2016	July 2, 2017

### 7.2 .LIMITS OF LINE CONDUCTED EMISSION TEST

Frequency	Maximum RF Line Voltage	
	Q.P.( dBuV)	A.V( dBuV)
150kHz~500kHz	66-56	56-46
500kHz~5MHz	56	46
5MHz~30MHz	60	50

\*\*Note: 1. The lower limit shall apply at the transition frequency.

2. The limit decreases linearly with the logarithm of the frequency in the range 0.15 MHz to 0.50 MHz

### 7.3. BLOCK DIAGRAM OF LINE CONDUCTED EMISSION TEST

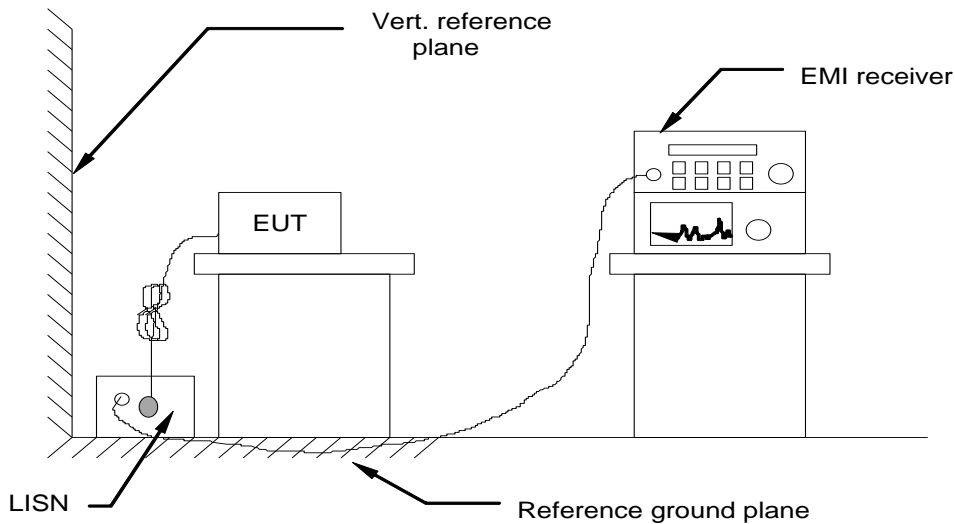

#### 7.4. PROCEDURE OF LINE CONDUCTED EMISSION TEST

- 1) The equipment was set up as per the test configuration to simulate typical actual usage per the user's manual. When the EUT is a tabletop system, a wooden table with a height of 0.8 meters is used and is placed on the ground plane as per ANSI C63.4 (see Test Facility for the dimensions of the ground plane used). When the EUT is a floor-standing equipment, it is placed on the ground plane which has a 3-12 mm non-conductive covering to insulate the EUT from the ground plane.
- 2) Support equipment, if needed, was placed as per ANSI C63.4.
- 3) All I/O cables were positioned to simulate typical actual usage as per ANSI C63.4. The EUT received power through a Line Impedance Stabilization Network (LISN) that was grounded to the protect earth.
- 4) The EUT test program was started. Emissions were measured on each current carrying line of the EUT using a spectrum Analyzer / Receiver connected to the LISN powering the EUT. The LISN has two monitoring points: Line 1 (Hot Side) and Line 2 (Neutral Side). Two scans were taken: one with Line 1 connected to Analyzer / Receiver and Line 2 connected to a 50 ohm load; the second scan had Line 1 connected to a 50 ohm load and Line 2 connected to the Analyzer / Receiver.
- 5) Analyzer / Receiver scanned from 150 kHz to 30MHz for emissions in each of the test modes.
- 6) During the above scans, the emissions were maximized by cable manipulation.
- 7) A scan was taken on both power lines, Line 1 and Line 2, recording at least the six highest emissions.
- 8) Emission frequency and amplitude were recorded into a computer in which correction factors were used to calculate the emission level and compare reading to the applicable limit. If EUT emission level was less -2dB to the A.V. limit in Peak mode, then the emission signal was re-checked using Q.P and Average detector.

The test data of the worst case condition (mode 2) was reported on the following Data page.

**7.5 TEST RESULT OF LINE CONDUCTED EMISSION TEST**

N/A

## 8. FCC RADIATED EMISSION TEST

### 8.1. TEST EQUIPMENT OF RADIATED EMISSION

Description	Manufacturer	Model	Identifier	Cal. Date	Cal. Due
Trilog Broadband Antenna (25M-1GHz)	SCHWARZBECK	VULB9160	9160-3355	July 3, 2016	July 2, 2017
RF Cable	SCHWARZBECK	AK9515E	96221	July 3, 2016	July 2, 2017
3m Anechoic Chamber	CHENGYU	966	PTS-001	June 3, 2016	June 2, 2017
MULTI-DEVICE Positioning Controller	Max-Full	MF-7802	MF780208339	N/A	N/A
Spectrum analyzer	Agilent	E4407B	MY46185649	June 3, 2016	June 2, 2017
Horn Antenna (1G-18GHz)	SCHWARZBECK	BBHA9120D	9120D-1246	June 3, 2016	June 2, 2017

### 8.2. LIMITS OF RADIATED EMISSION TEST

Frequency (MHz)	Distance (m)	Maximum Field Strength Limit (dBuV/m/ Q.P.)
30~88	3	40.0
88~216	3	43.5
216~960	3	46.0
Above 960	3	54.0

\*\*Note: The lower limit shall apply at the transition frequency.

### 8.3 BLOCK DIAGRAM OF RADIATED EMISSION TEST

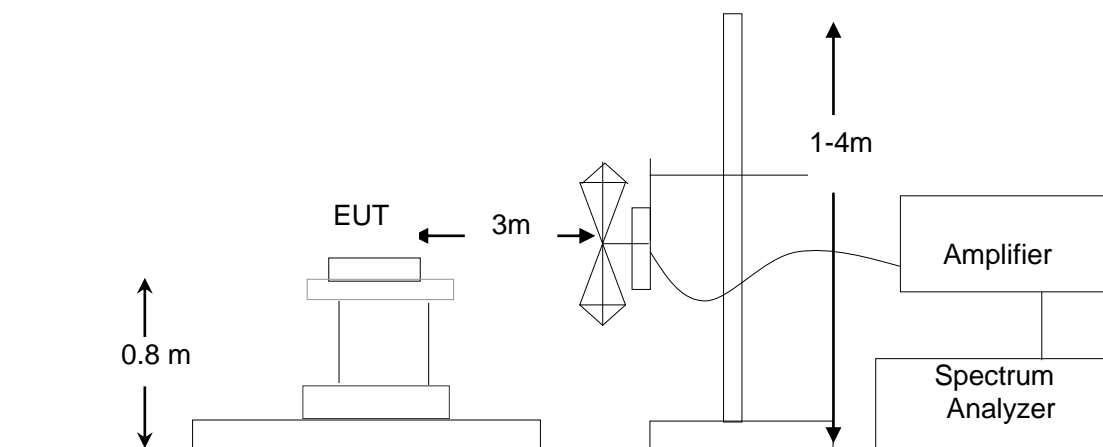

#### 8.4 PROCEDURE OF RADIATED EMISSION TEST

- 1) The equipment was set up as per the test configuration to simulate typical actual usage per the user's manual. When the EUT is a tabletop system, a wooden turntable with a height of 0.8 meters is used which is placed on the ground plane as per ANSI C63.4 (see Test Facility for the dimensions of the ground plane used). When the EUT is floor-standing equipment, it is placed on the ground plane which has a 3-12 mm non-conductive covering to insulate the EUT from the ground plane.
- 2) Support equipment, if needed, was placed as per ANSI C63.4.
- 3) All I/O cables were positioned to simulate typical actual usage as per ANSI C63.4.
- 4) The EUT received DC 13.8V by DC source. All support equipments received AC 120V/60Hz power from socket under the turntable, if any.
- 5) The antenna was placed at 3 meter away from the EUT as stated in FCC Part 15. The antenna connected to the Analyzer via a cable and at times a pre-amplifier would be used.
- 6) The Analyzer / Receiver quickly scanned from 30MHz to 1000MHz. The EUT test program was started. Emissions were scanned and measured rotating the EUT to 360 degrees and positioning the antenna 1 to 4 meters above the ground plane, in both the vertical and the horizontal polarization, to maximize the emission reading level.
- 7) The test mode(s) were scanned during the test:
- 8) Recorded at least the six highest emissions. Emission frequency, amplitude, antenna position, polarization and turntable position were recorded into a computer in which correction factors were used to calculate the emission level and compare reading to the applicable limit and Q.P./Peak reading is presented.

The test data of the worst case condition (mode 1) was reported on the following Data page

### 8.5 TEST RESULT OF RADIATED EMISSION TEST

Radiated Emission Test –Horizontal -3m

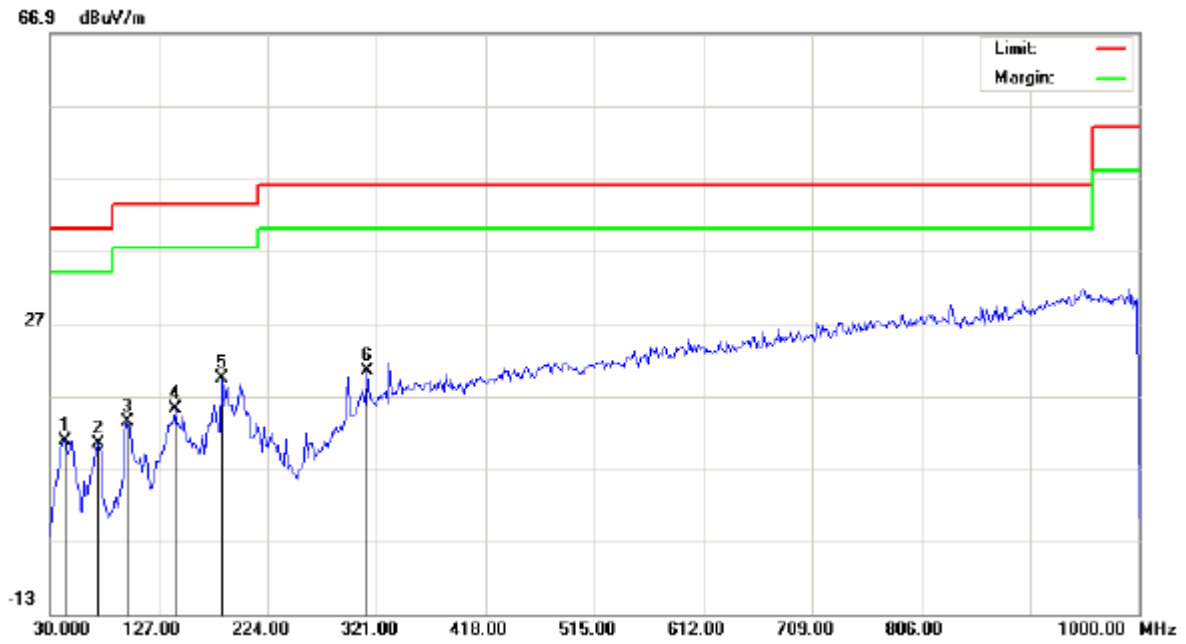

No.	Mk	Freq.	Reading	Factor	Measurement	Limit	Over	Detector	Antenna Height	Table Degree	Comment
		MHz	dBuV	dB/m	dBuV/m	dBuV/m	dB		cm	degree	
1		42.9333	-0.81	11.71	10.90	40.00	-29.10	peak			
2		73.6500	3.78	6.70	10.48	40.00	-29.52	peak			
3		99.5167	3.49	10.00	13.49	43.50	-30.01	peak			
4		141.5500	0.39	14.82	15.21	43.50	-28.29	peak			
5	*	183.5833	8.07	11.24	19.31	43.50	-24.19	peak			
6		312.9167	4.14	16.27	20.41	46.00	-25.59	peak			

**RESULT: PASS**

Radiated Emission Test –Vertical -3m

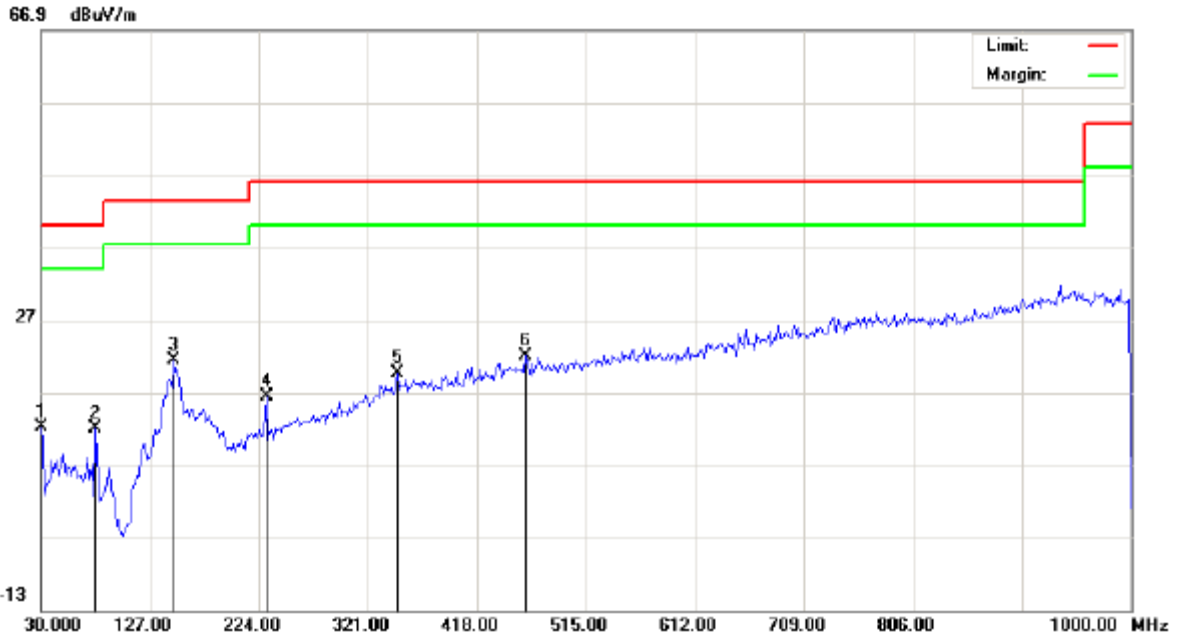

No.	Mk	Freq.	Reading	Factor	Measurement	Limit	Over	Detector	Antenna Height	Table Degree	Comment
		MHz	dBuV	dB/m	dBuV/m	dBuV/m	dB		cm	degree	
1		30.0000	16.48	-4.20	12.28	40.00	-27.72	peak			
2		78.5000	9.87	2.17	12.04	40.00	-27.96	peak			
3	*	148.0167	6.07	15.25	21.32	43.50	-22.18	peak			
4		230.4667	4.33	11.99	16.32	46.00	-29.68	peak			
5		346.8667	1.10	18.53	19.63	46.00	-26.37	peak			
6		461.6500	1.34	20.72	22.06	46.00	-23.94	peak			

**RESULT: PASS**

- Note:**
1. Factor=Antenna Factor + Cable loss - Amplifier gain, Margin=Measurement-Limit.
  2. The "Factor" value can be calculated automatically by software of measurement system.
  3. Emissions range from 1GHz to 12.5GHz have 20dB margin. No recording in the test report.
  4. Only the data of the worst case would be record in this test report.

## 9. ANTENNA CONDUCTED POWER FOR RECEIVERS

### LIMIT

The antenna conducted power of the receiver as defined in §15.111 shall not exceed the values given in the following tables

Frequency Range	9 KHz to 2GHz
Limit	2.0 nW (-57 dBm )

### TEST CONFIGURATION

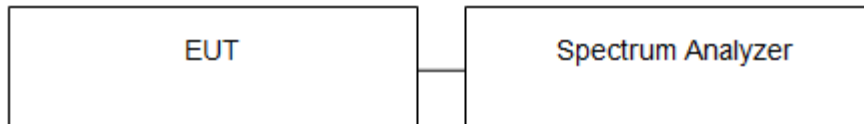

### TEST PROCEDURE

1. The receiver antenna terminal connected to a spectrum analyzer.
2. The test data of the worst case condition (mode 1) was reported on the following Data page.



**TEST RESULTS**

**Conducted Measurement (9 KHz to 150 KHz)**

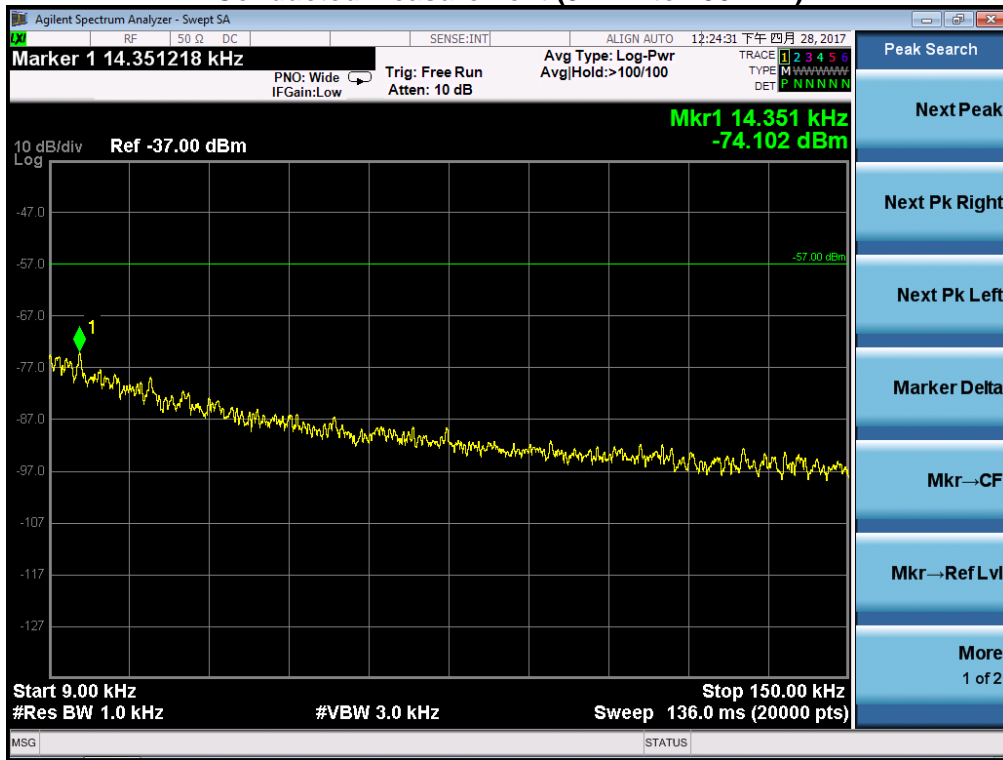

**Conducted Measurement (150 KHz to 30MHz)**

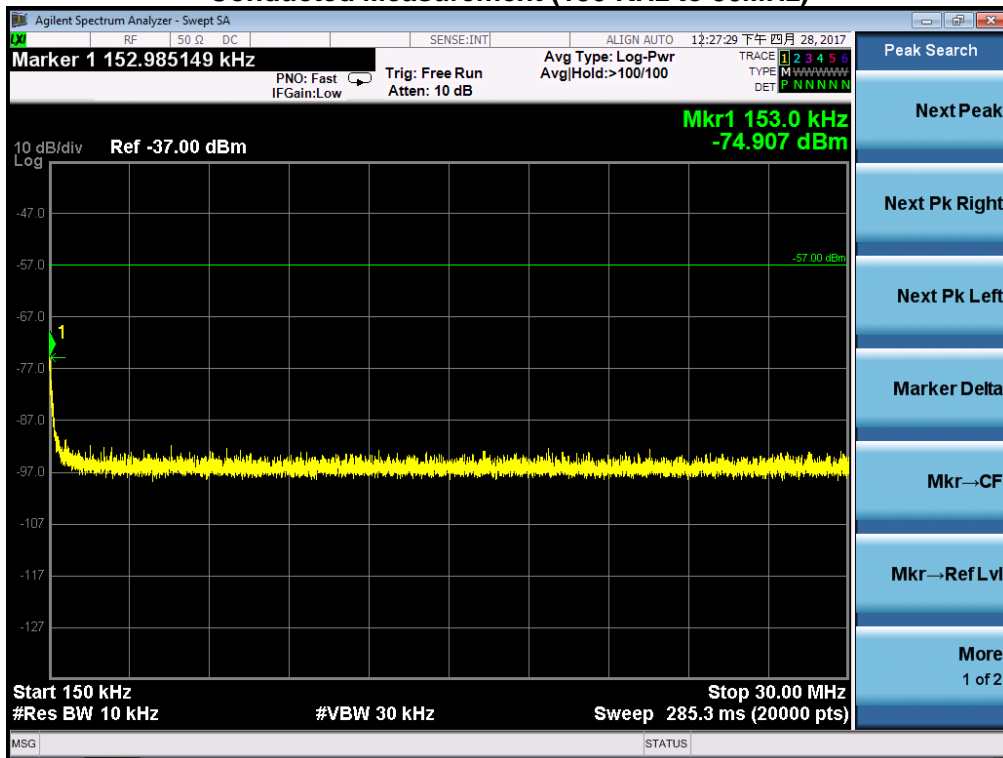

### Conducted Measurement (30MHz to 1GHz)

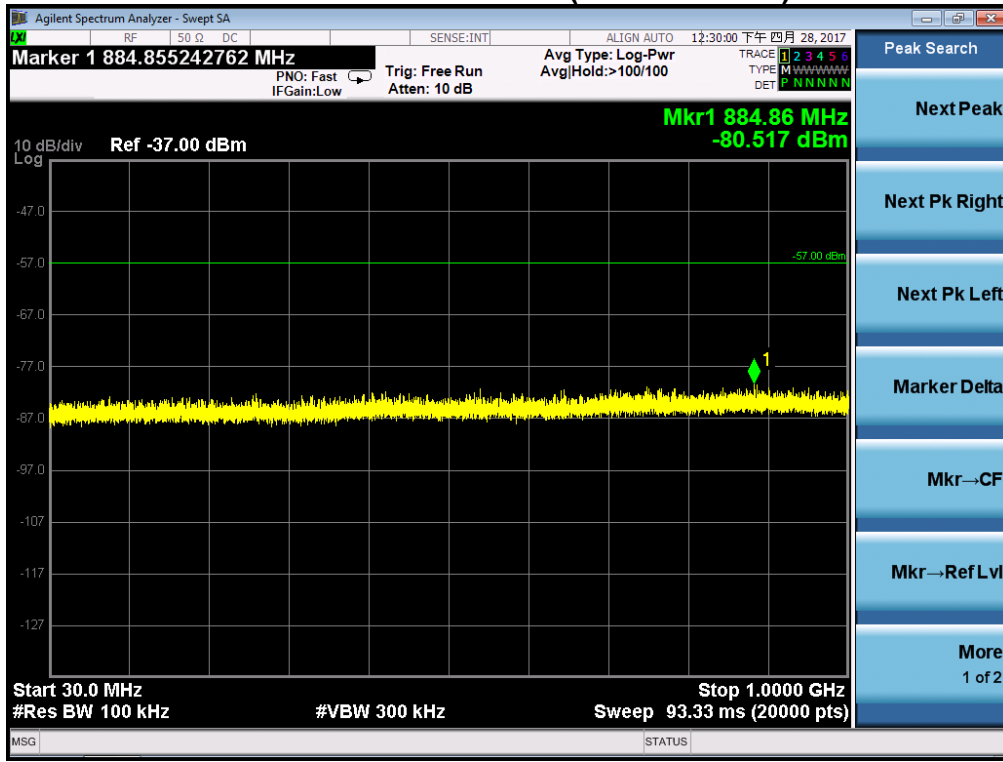

### Conducted Measurement (1GHz to 2GHz)

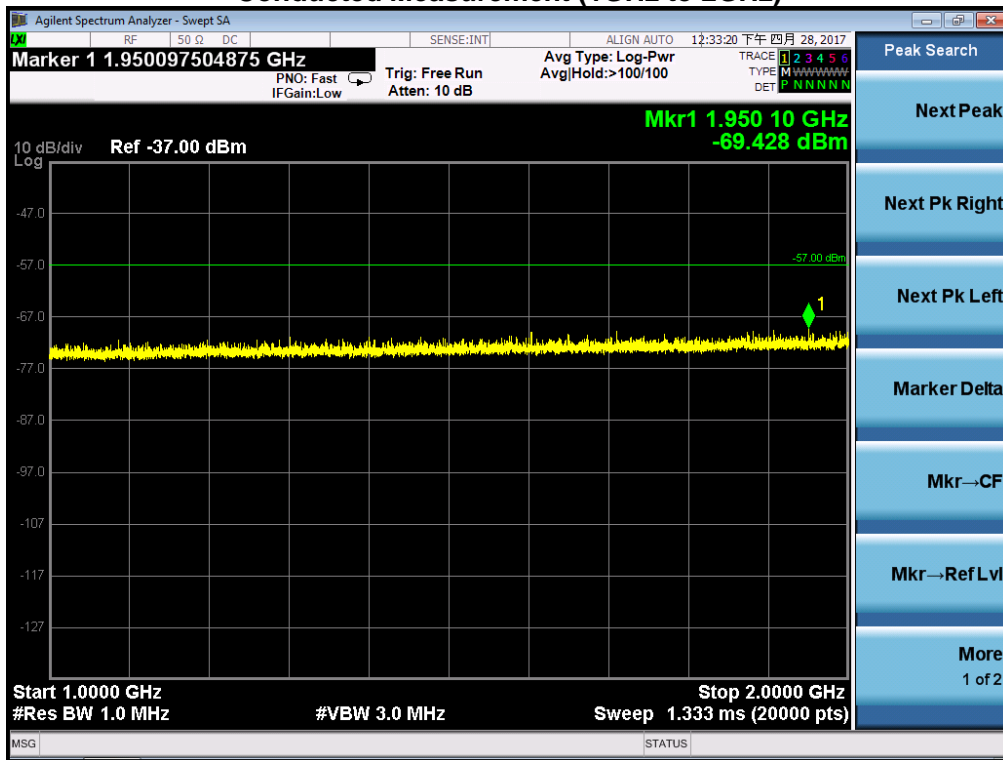

RESULT: PASS

## APPENDIX 1 PHOTOGRAPHS OF TEST SETUP

### RADIATED TEST SETUP

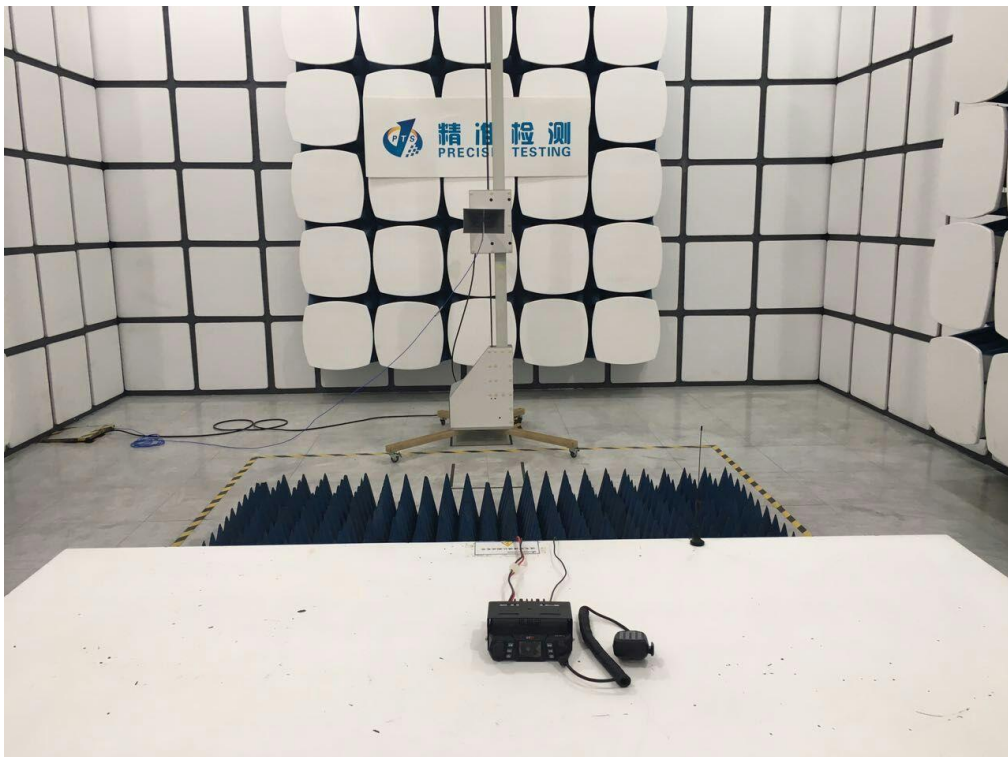
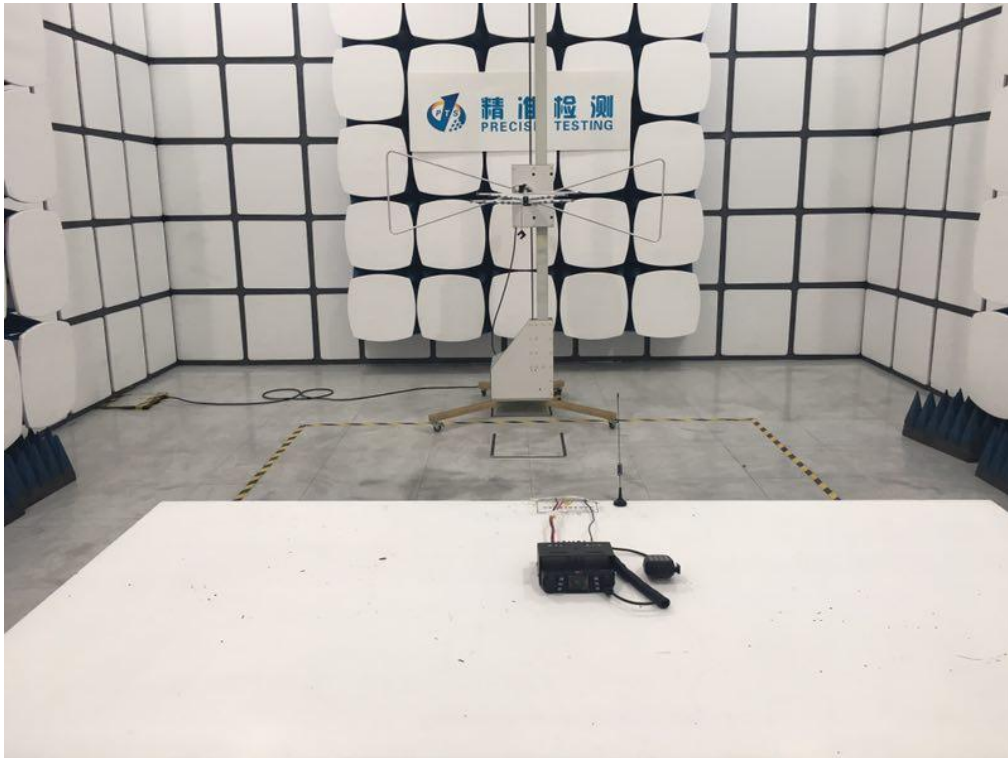

## APPENDIX 2 PHOTOGRAPHS OF EUT WHOLE VIEW OF EUT



PART 1

## TOP VIEW OF EUT



BOTTOM VIEW OF EUT



FRONT VIEW OF EUT



BACK VIEW OF EUT

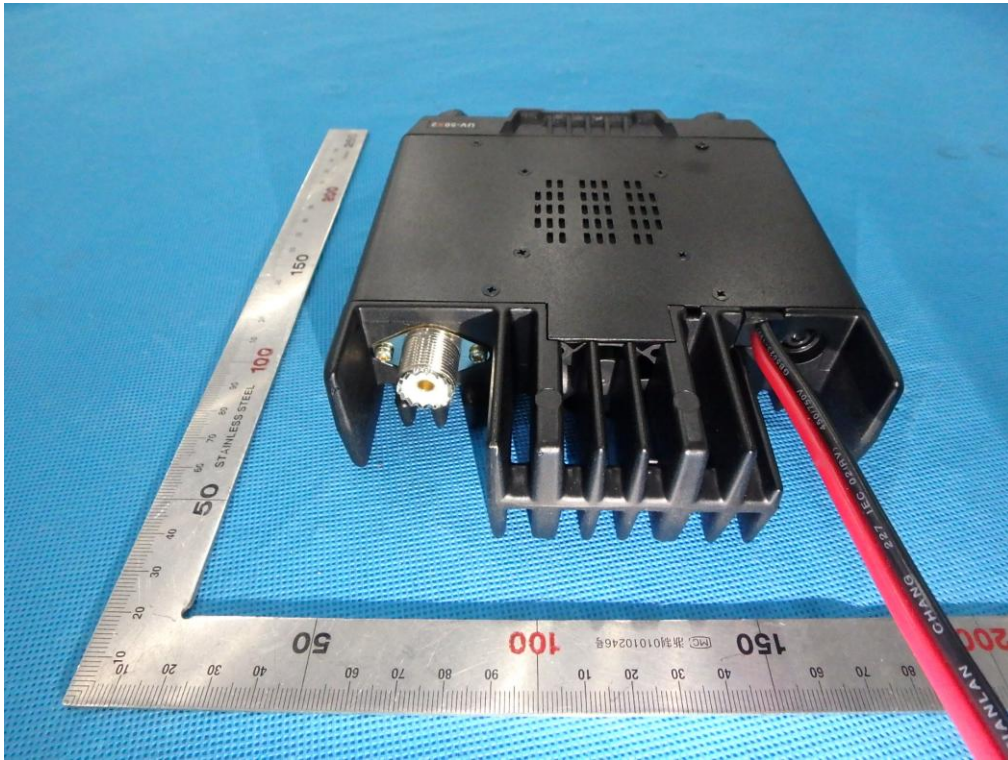

LEFT VIEW OF EUT

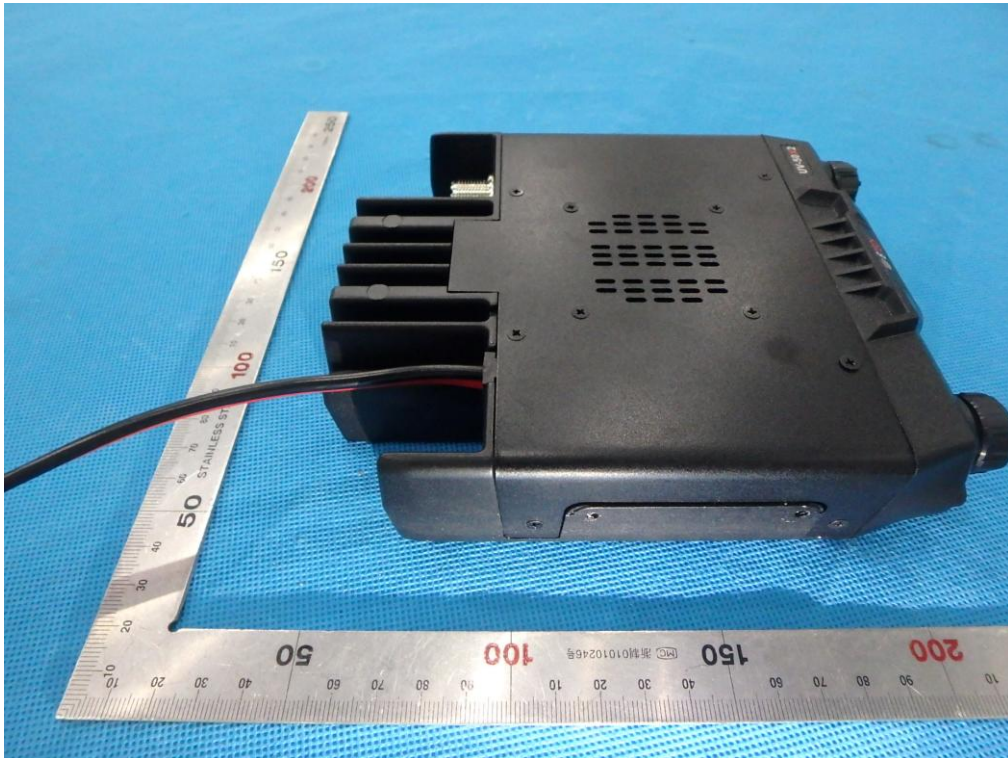

RIGHT VIEW OF EUT



OPEN VIEW-1 OF EUT

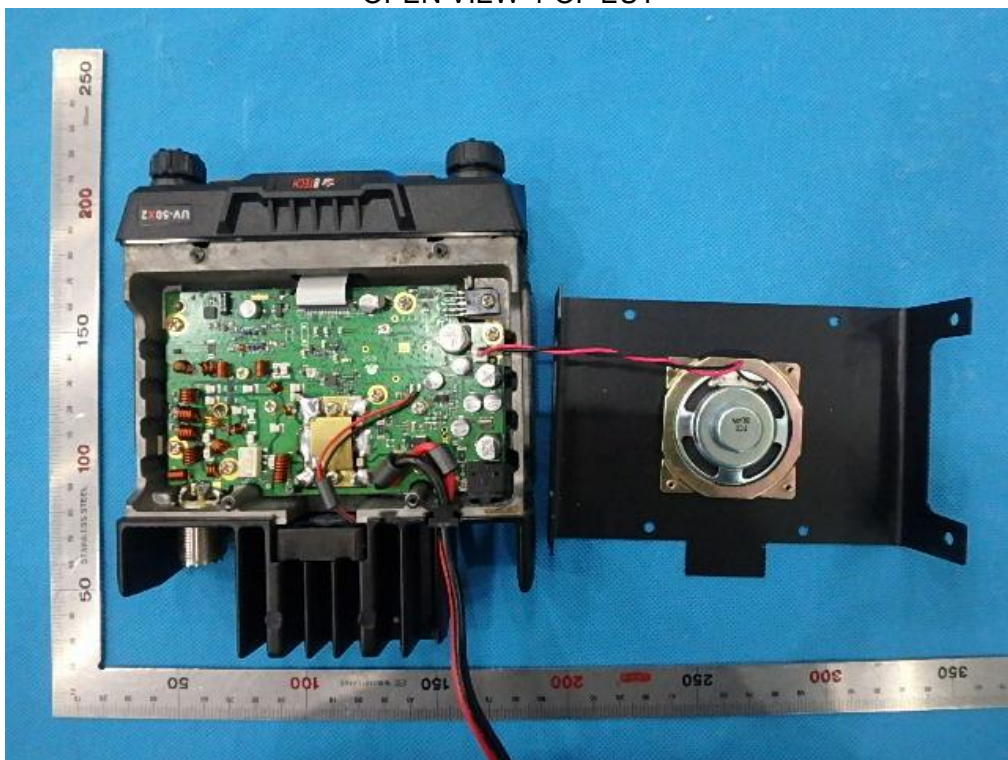

OPEN VIEW-2 OF EUT



OPEN VIEW-3 OF EUT

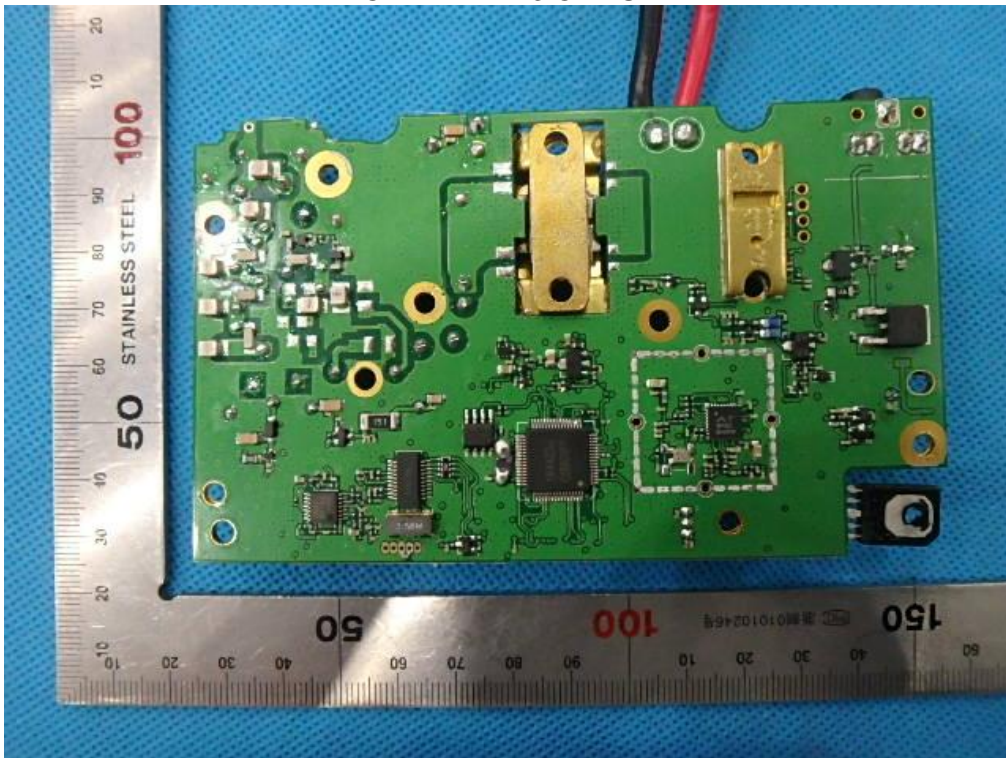



OPEN VIEW-4 OF EUT

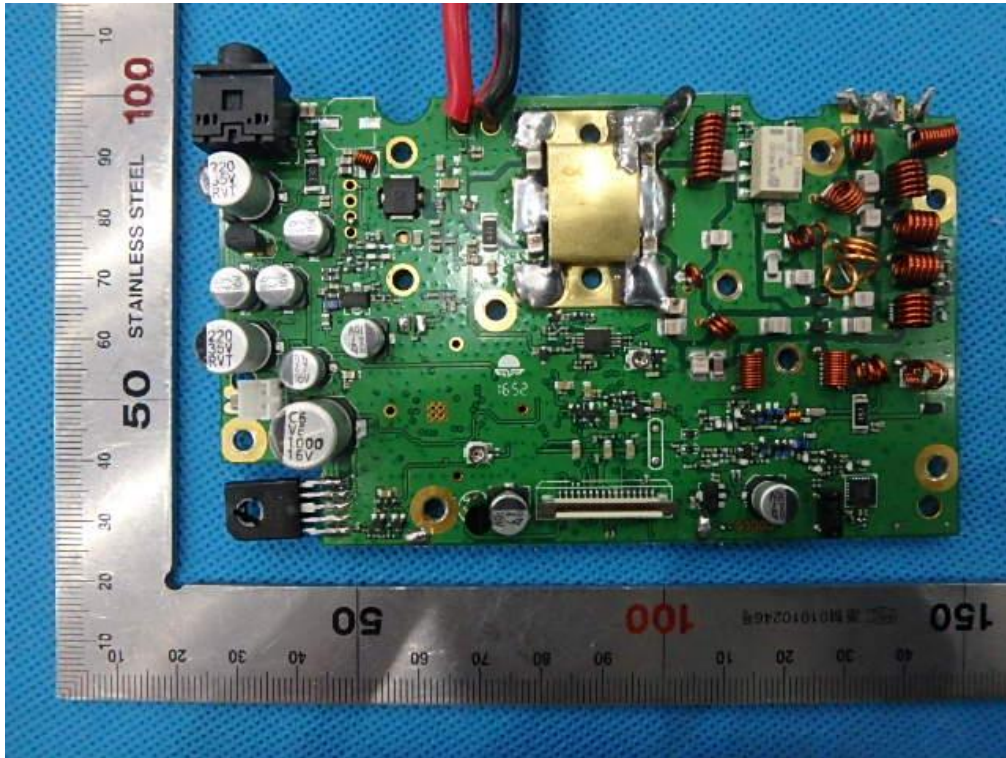

OPEN VIEW-5 OF EUT

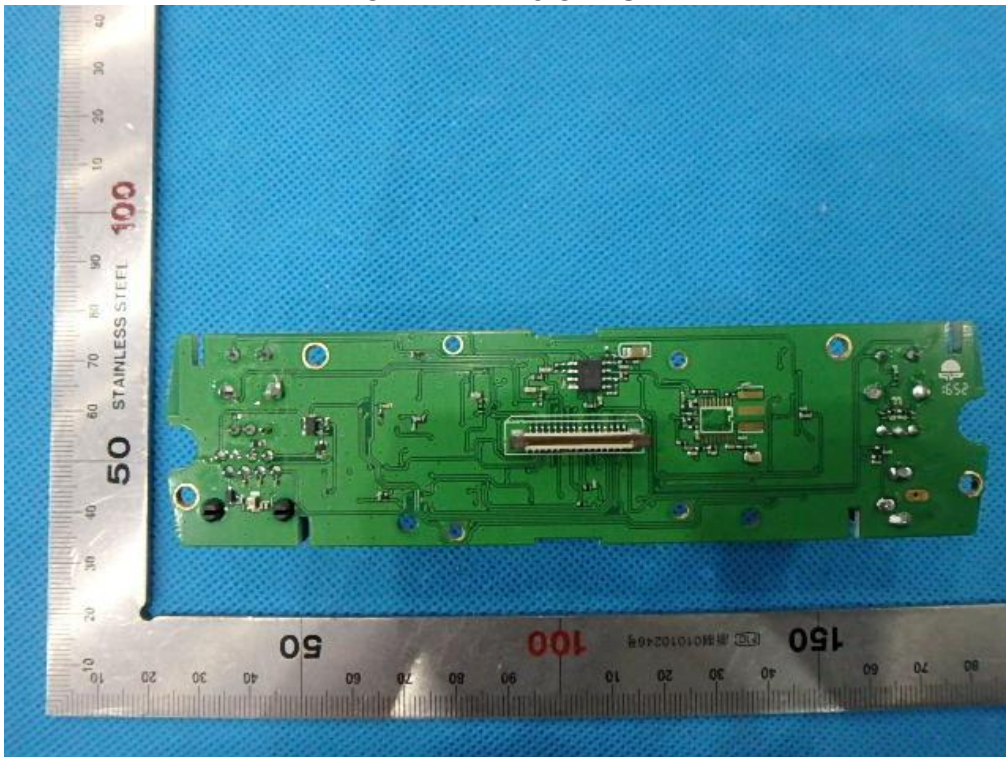

OPEN VIEW-6 OF EUT

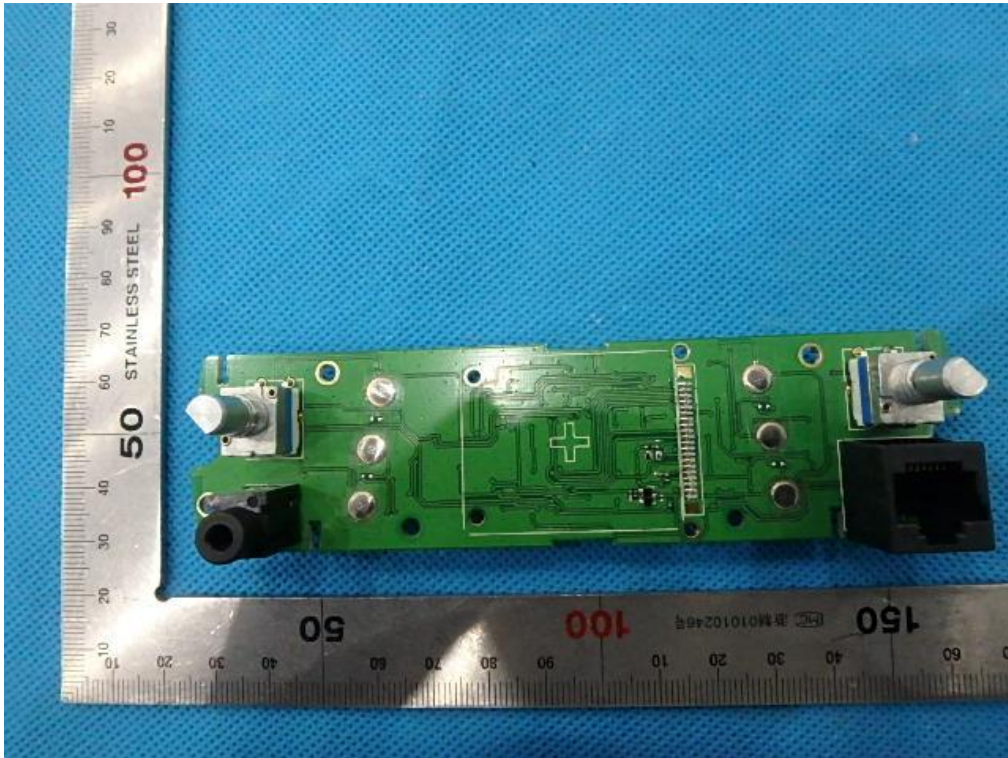

PART 2

TOP VIEW OF EUT



BOTTOM VIEW OF EUT

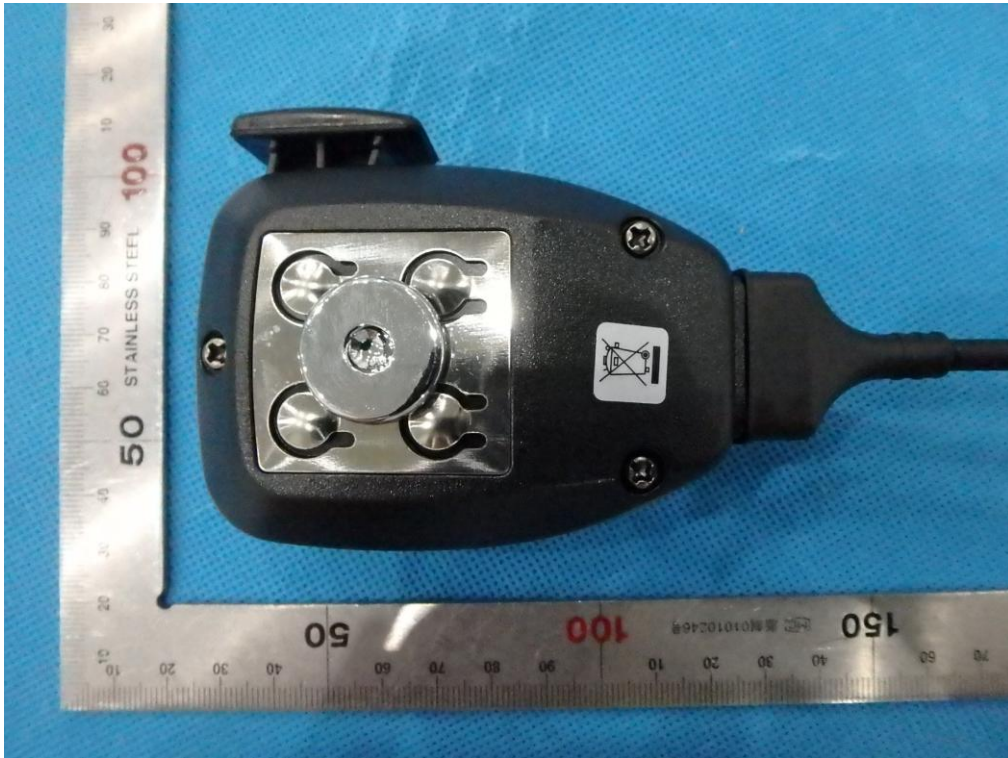

FRONT VIEW OF EUT



BACK VIEW OF EUT



LEFT VIEW OF EUT



RIGHT VIEW OF EUT



OPEN VIEW OF EUT

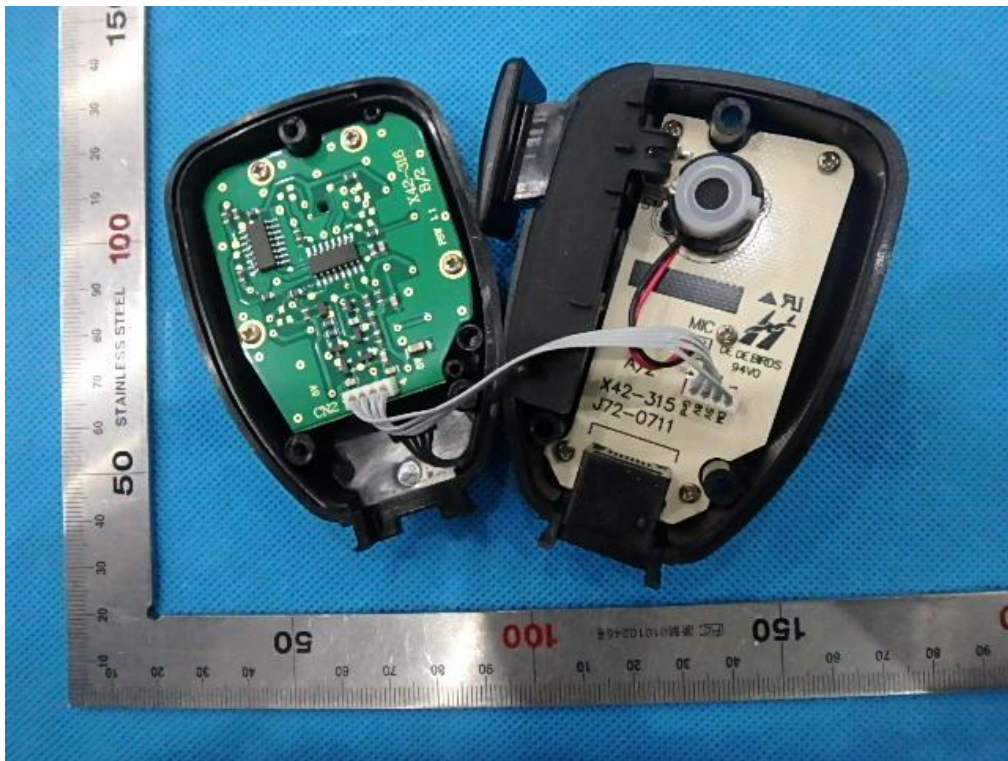

INTERNAL VIEW-1 OF EUT

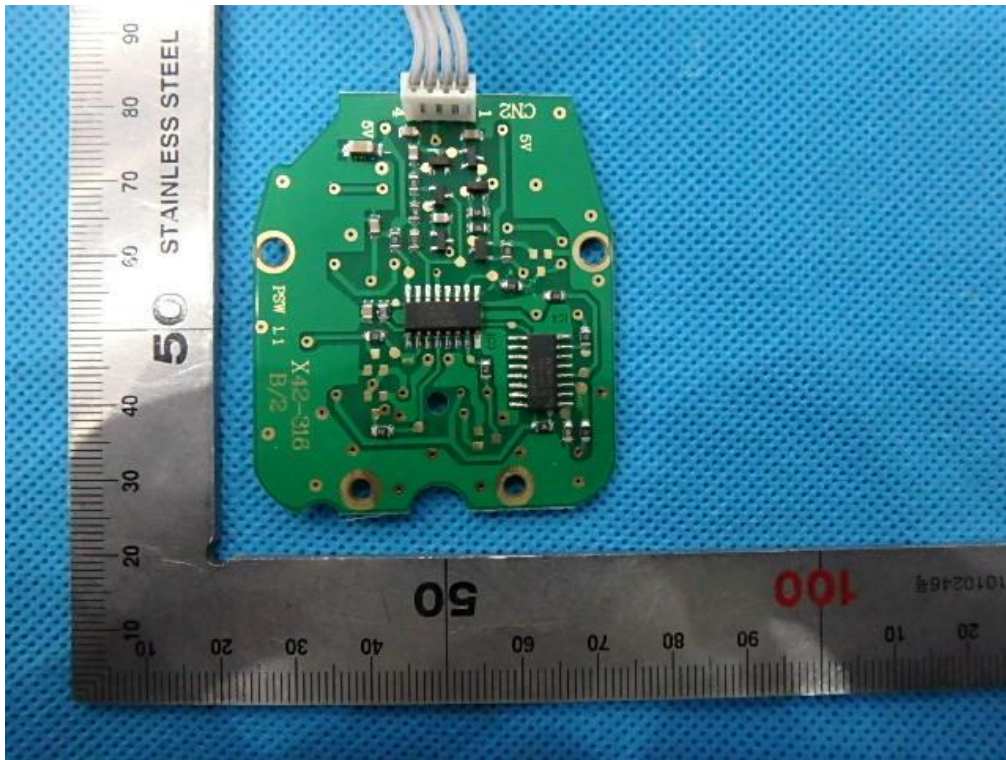

INTERNAL VIEW-2 OF EUT

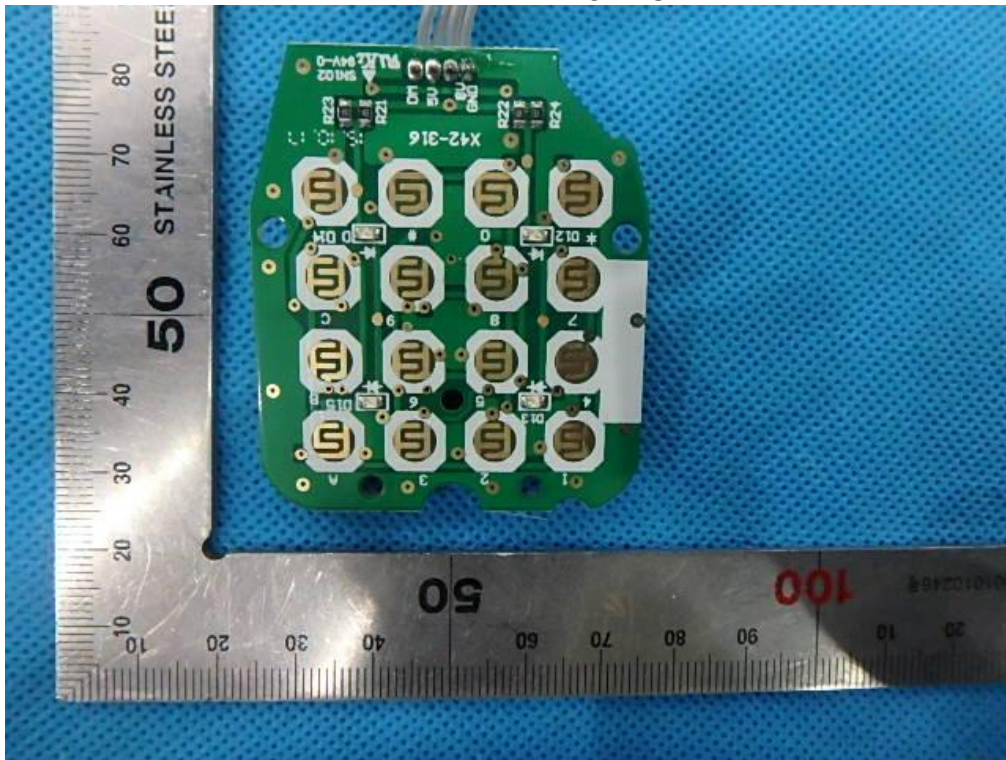

INTERNAL VIEW-3 OF EUT

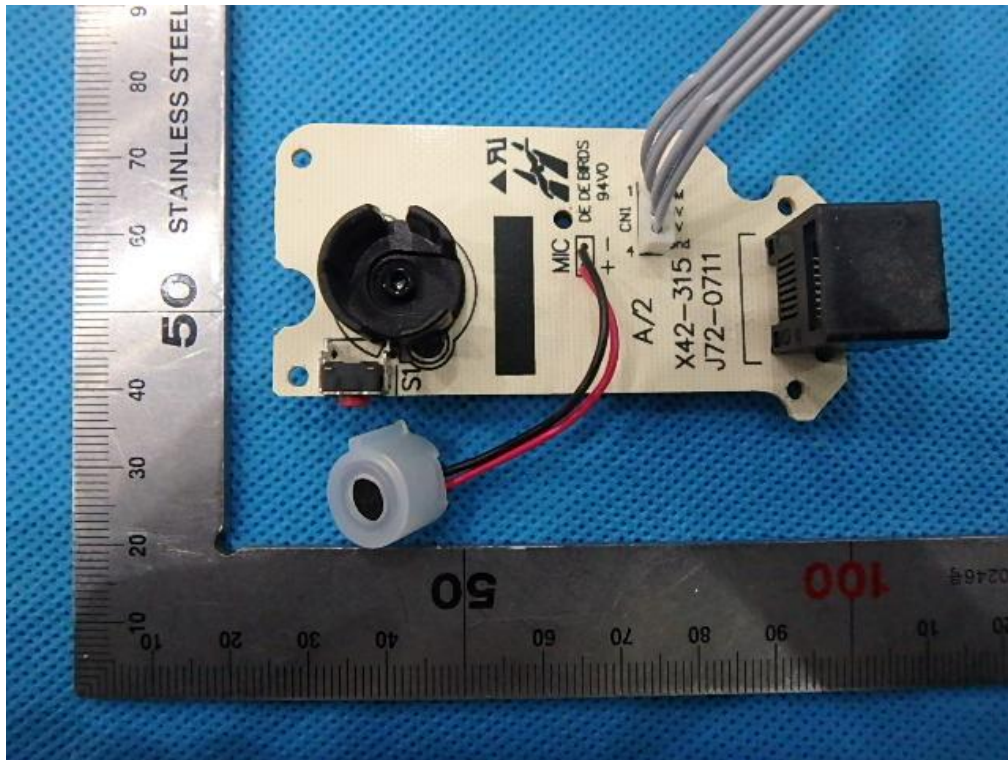

INTERNAL VIEW-4 OF EUT

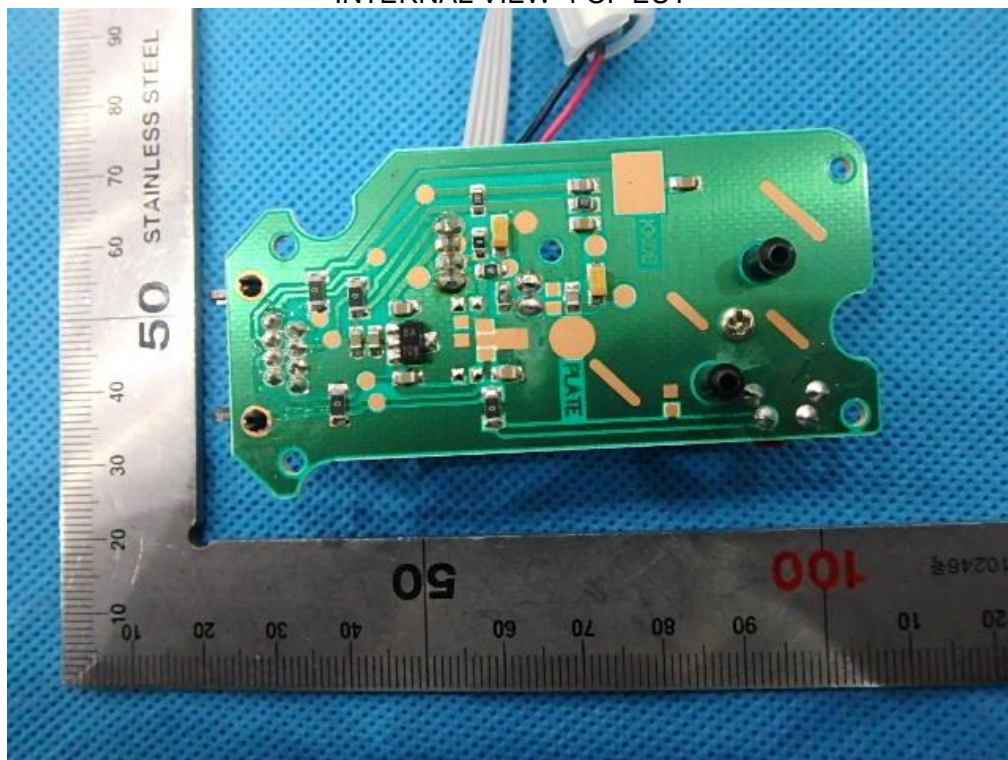

-----END OF REPORT-----