



Copyright © 2022 by BTECH; <https://baofengtech.com/>

All rights reserved. No part of this publication may be reproduced, distributed, or transmitted in any form or by any means, including photocopying, recording, or other electronic or mechanical methods, without the prior written permission of the publisher, except in the case of brief quotations embodied in critical reviews and certain other noncommercial uses permitted by copyright law. For permission requests, write to the publisher.

Contributions taken from: Miklor.com Resource Site, and Jim Unroe, KC9HI. Used by permission. All rights reserved.

**THANK YOU FOR YOUR PURCHASE OF THE BTECH GMRS-50V2. THIS  
MULTI-BAND RADIO WILL DELIVER INSTANT RELIABLE  
COMMUNICATION.**

**PLEASE READ THIS MANUAL CAREFULLY BEFORE USE**

## Table of Contents

<b>Part I. Getting started</b> .....	<b>1</b>
<b>Chapter 1. – Getting Started</b> .....	<b>2</b>
Unpacking and Inspecting .....	4
GMRS-50V2: Overview of the Front Panel .....	6
GMRS-50V2: Overview of the Rear Ports .....	8
Hand Held Mic Keys and Description .....	10
Color Display and Icon Descriptions.....	11
Antenna Basics.....	14
Ground Plane.....	14
Antenna Requirements .....	15
<b>Chapter 2. - GMRS Information and FCC Declaration</b> .....	<b>17</b>
GMRS Repeaters.....	17
FCC NOTICE AND DECLARATION.....	17
FCC LICENSE REQUIRED FOR GMRS OPERATION.....	18
GMRS Frequency Chart, Channel Guide.....	19
<b>Chapter 3. – Basic Shortcuts and Use</b> .....	<b>20</b>

---

<b>Microphone Keys .....</b>	<b>20</b>
Pound # Key.....	20
Star * Key.....	20
<b>Front Panel Buttons (Keys) .....</b>	<b>21</b>
V/M.....	21
Call.....	21
H/L Lock.....	21
FM .....	21
EXIT A/B/C/D .....	21
<b>General Operation .....</b>	<b>22</b>
Turning the unit on .....	22
Turning the unit off.....	22
Adjusting the volume.....	22
<b>Making a call .....</b>	<b>23</b>
<b>Channel selection .....</b>	<b>23</b>
Frequency (VFO) mode.....	23
Channel (MR) mode.....	24
<b>Monitor Both VFO &amp; MR Modes.....</b>	<b>25</b>

---

<b>Chapter 4. – Programming Scanning Channels</b> .....	<b>26</b>
<b>Manual programming</b> .....	<b>26</b>
Adding Scanning Channels.....	27
<b>NOAA Weather Channels</b> .....	<b>28</b>
Adding a NOAA Channel .....	28
<b>Adding GMRS Channels</b> .....	29
<b>Computer programming</b> .....	<b>30</b>
<b>Chapter 5. – Other Settings</b> .....	<b>31</b>
Toggle from High, Mid, to Low Power .....	31
Storing an FM Radio Station and Scanning.....	31
Radio Lock .....	31
PTT ID Setting .....	31
DTMF RX Settings .....	32
DTMF TX Settings .....	32
Remote Stun.....	33
Remote Kill .....	34
Remote Revive.....	34
Read More About Remote Commands .....	35
DTMF Receive Settings, Transmit Setting (Call Key).....	35
2TONE Receive Settings, Transmit Setting (Call Key) .....	35

---

5Tone Receive Settings, Transmit Setting (Call Key) .....	36
<b>Scanning modes</b> .....	<b>37</b>
Time operation.....	37
Carrier operation .....	37
Search operation.....	37
<b>SKIP Scanning Channels</b> .....	<b>38</b>
<b>Scanning a Frequency Range (VFO Mode)</b> .....	<b>38</b>
<b>Tone Scanning</b> .....	<b>39</b>
Scanning for CTCSS and DCS Tones/Codes .....	39
<b>Dual, Tri, and Quad Watch (TMR)</b> .....	<b>42</b>
<b>Chapter 6. - Selective calling</b> .....	<b>44</b>
CTCSS .....	46
DCS .....	47
1000Hz, 1450Hz, 1750Hz, 2100Hz Tone-burst.....	48
<b>Part III. How-to and setup guides.</b> .....	<b>49</b>
<b>Chapter 7. - Customization</b> .....	<b>49</b>

---

---

Text Display Colors.....	49
Sync Display Channels .....	51
<b>Appendix A. - Menu definitions .....</b>	<b>52</b>
FCC Notice.....	63
<b>Appendix B. - Technical specifications.....</b>	<b>65</b>
<b>General .....</b>	<b>65</b>
Receiver.....	65
Transmit.....	66
<b>DCS table .....</b>	<b>67</b>
<b>CTCSS table.....</b>	<b>70</b>

# Part I. Getting started

*Part one covers the basic setup and use of your mobile two-way transceiver.*

**CHAPTER 1. - GETTING STARTED**

**CHAPTER 2. - GMRS INFORMATION AND FCC DECLARATION**

**CHAPTER 3. - BASIC USE**

**CHAPTER 4. - PROGRAMMING SCANNING CHANNELS**

**CHAPTER 5. - OTHER SETTINGS**

**CHAPTER 6. - SELECTIVE CALLING**



# Chapter 1. – Getting Started

## BEFORE PROCEEDING INSURE:

- Qualified technicians shall service this equipment only. Do not modify the radio for any reason.
- Use only BTECH supplied or approved accessories.
- **Turn off your radio prior to entering any area with explosive and flammable materials. Do NOT USE your transceiver at a gas/fuel station**
- For vehicles with an air bag, do not mount your radio in the area over an air bag or in the air bag deployment area.
- Do not expose the radio to direct sunlight over a long time, nor place it close to a heating source.
- If the unit emits smoke or an odor, you should immediately cut off the power supply. Then send the radio to the nearest service center or dealer
- Do not operate the mobile transceiver on high power unless it is necessary. Do not transmit for long periods of time, as it may overheat the transceiver.
- Keep the unit away from dusty, damp and wet environments
- Use the correct power supply (~13.8VDC); do not use incorrect or higher voltage (e.g., 24VDC)

## Exposure to Radio Frequency Energy

Your BTECH radio is designed to comply with the following national and international standards and guidelines regarding exposure of human being to radio frequency electromagnetic energy:

- United States Federal Communications Commission, Code of Federal Regulations: 47 CFR part 2 sub-part J
- American National Standards Institute (ANSI)/Institute of Electrical & Electronic Engineers (IEEE) C95. 1-1992
- Institute of Electrical and Electronic Engineer (IEEE) C95. 1-1999 Edition
- National Council on Radiation Protection and Measurements (NCRP) of the United States, Report 86, 1986
- International Commission on Non-ionizing Radiation Protection (ICNIRP) 1998

To control your exposure and ensure compliance with the general population or uncontrolled environment exposure limits, transmit no more than 50% of the time. The radio generates measurable RF energy exposure only when transmitting.

# Unpacking and Inspecting

- Please check the packaging of your radio for any signs of damage.
- Carefully open the box and confirm you received the items listed below.
- If you find the radio or the included accessories are damaged or lost, immediately contact your dealer.

## What's in the Box



GMRS-50V2

Mobile Radio



Microphone



Power Cable (Direct Connect)



Mounting Screws  
and Fuse

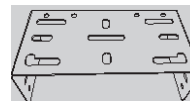

Mounting Bracket

## FIND TUTORIALS, SUPPORT AND MORE

<https://www.facebook.com/BaoFeng.Tech.Radio> 

<https://www.youtube.com/c/Baofengtechradio> 

## GMRS-50V2: Overview of the Front Panel

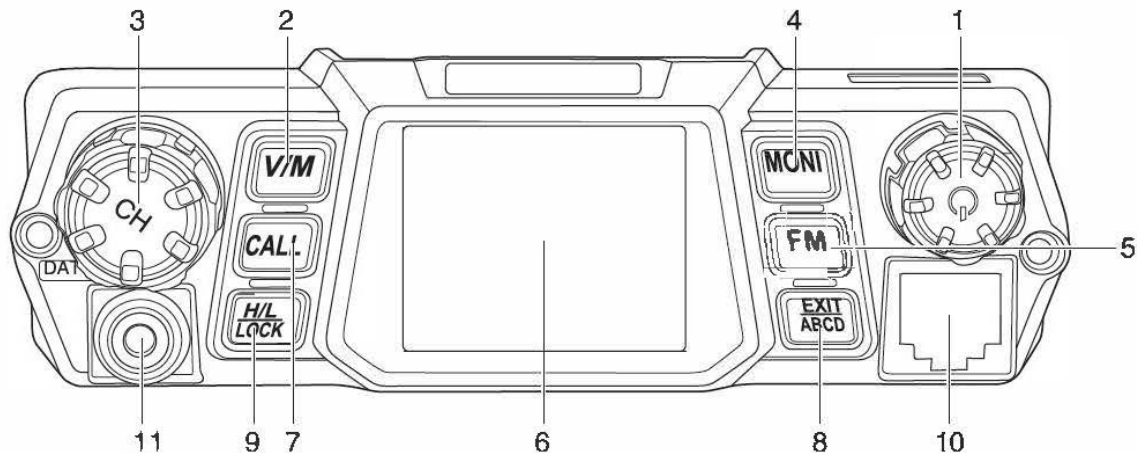

1. Power, On/Off (Press) + Volume Knob
2. V/M Mode Switch (Channel/Frequency)
3. Confirm/Select Key (Press) +Main Selector (Menu Knob)
4. Monitor function
5. FM radio On/Off key
6. Display screen
7. Call key
8. Exit Menu + A/B/C/D signal switching + alarm function
9. High/Mid/Low Power Switch + Lock
10. Microphone Connector
11. DATA, Programming Jack: PC-04 Programming Cable Jack

**CALL**: when in standby, press to send caller ID (ANI) in the selected signaling mode; while transmitting, press to send activate signaling.

**MONI**: press to turn off the squelch, repeat to turn on the squelch.

**V/M**: press to switch between channel mode (Memory) and frequency mode (VFO).

**EXIT ABCD**: press to choose between A, B, C, or D frequencies --- Or exit function mode.

**FM**: press to enter and exit FM radio

**H/L LOCK**: press to toggle high/mid/low power; hold to key-lock/or key-unlock

## RJ45 Connector:

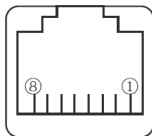

- |              |              |
|--------------|--------------|
| ① Data Input | ⑤ PTT.       |
| ② RPT CTRL   | ⑥ GND        |
| ③ MIC        | ⑦ +8V DC Out |
| ④ MIC Ground | ⑧ Null       |

## GMRS-50V2: Overview of the Rear Ports

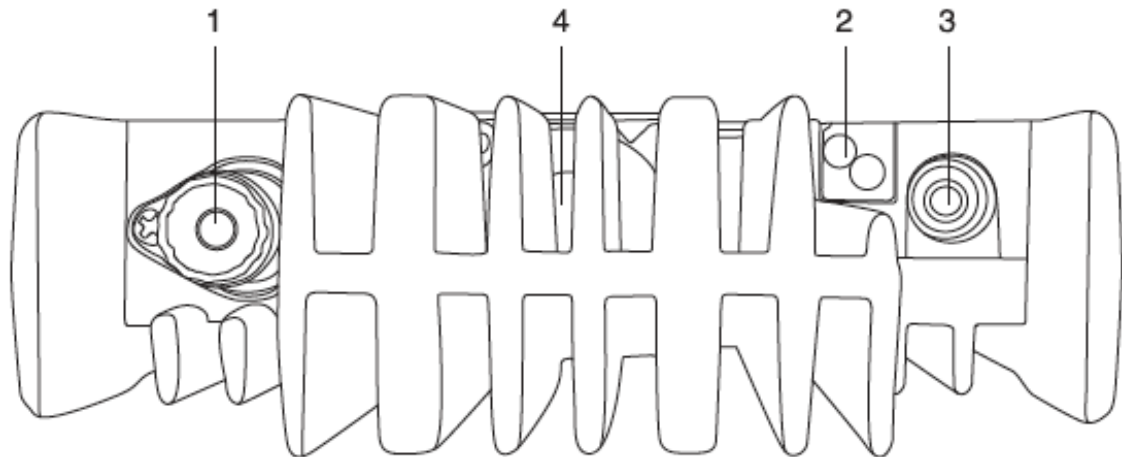

1. SO-239 RF Antenna Connector:  
Connects to PL-259 Antennas
2. DC Power Input (13.8V – 20A Peak)
3. TS Line Out: Includes Audio-out/GND
4. Cooling Fan

**TS Line-Out Connector:** The GMRS-50V2 uses a 3.5MM TS MONO Speaker out in the rear – it is compatible with standard 3.5MM TS Mono Speakers

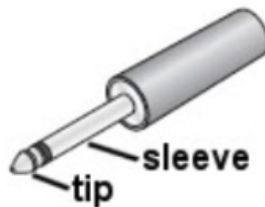

## Programming Cable:

PC-04 Cable available at: [www.baofengtech.com/accessories](http://www.baofengtech.com/accessories)

Programming software available at: [www.baofengtech.com/download](http://www.baofengtech.com/download)



# Hand Held Mic Keys and Description

- 1 "MENU": Function key  
**VFO/MR Toggle (Long Press)**
- 2 "UP": Higher frequency or item
- 3 "DOWN": Lower frequency or item
- 4 "EXIT/AB": Exit, AB channel switch, and alarm function  
**Alarm Activate (Long Press)**
- 5 "\*" /SCAN": Scanning function
- 6 "#/LOCK": High / Low Power Toggle, Lock  
**Keyboard Lock (Long Press)**
- 7 "0": Number 0
- 8 "1": Number 1
- 9 "2": Number 2
- 10 "3": Number 3
- 11 "4": Number 4
- 12 "5": Number 5
- 13 "6": Number 6
- 14 "7": Number 7
- 15 "8": Number 8
- 16 "9": Number 9

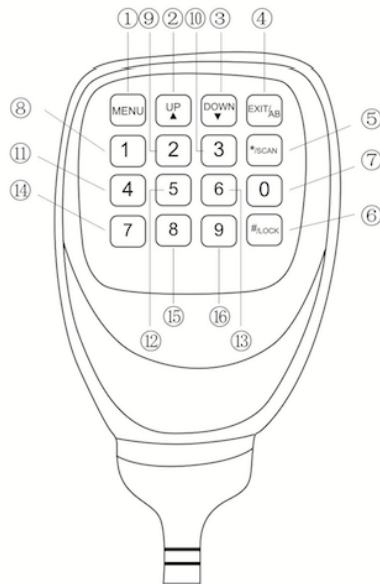

# Color Display and Icon Descriptions

The Top Line on the LCD will show the current selected channel's settings at a glimpse:

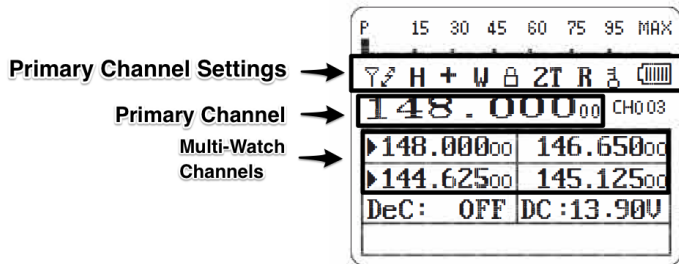

Icon	Description	Icon	Description	Icon	Description
	Channel allowed to TX and RX	<b>DCS</b>	DCS Enabled (TX, RX or Both)		Positive Offset (Freq. Mode)
<b>N</b>	Channel set to Narrowband	<b>L</b>	Transmit Power: Low		Negative Offset (Freq. Mode)
<b>W</b>	Channel set to Wideband	<b>M</b>	Transmit Power: Mid		Offset Enabled (Chan. Mode)
<b>R</b>	Channel Reverse Enabled	<b>H</b>	Transmit Power: High		
	Keypad is Locked	<b>2T</b>	2Tone Calling Enabled		
<b>CT</b>	CTCSS Enabled (TX, RX or Both)	<b>5T</b>	5Tone Calling Enabled		
	Battery Strength (Weak Battery Indicator)	<b>DT</b>	DTMF Calling Enabled		

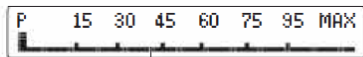

Transmit power indicator bar

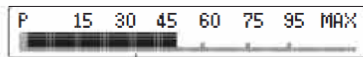

Medium power transmit indicator

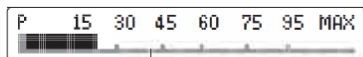

Low power transmit indicator

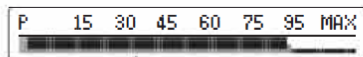

High power transmit indicator

Main frequency transmitting color according to the menu color settings.

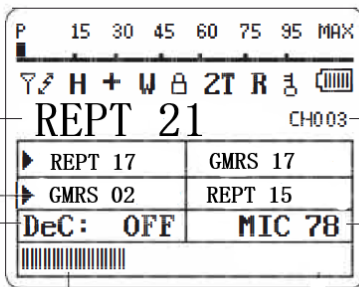

The current mode is channel mode, channel number 003

Display transmit Dec  
Microphone volume indicator bar

Transmitting microphone volume figure indicator

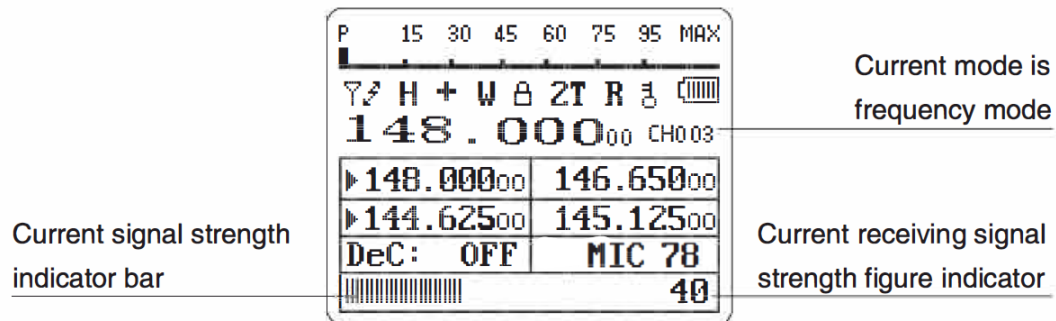
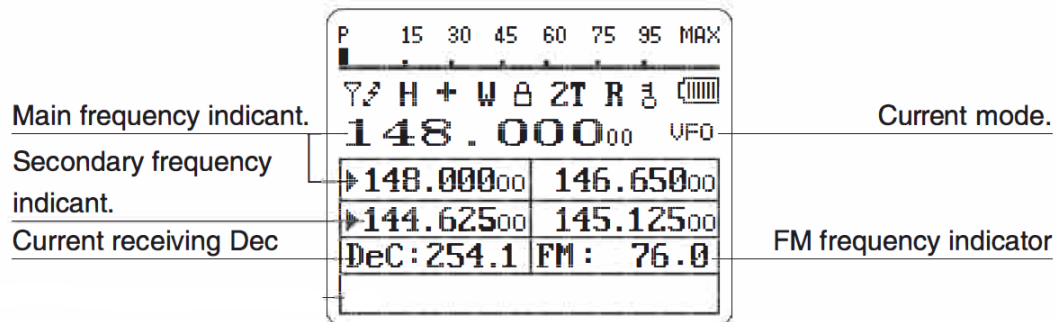

## Antenna Basics

Your Mobile Radio Kit does not include an Antenna. It is VERY Important to NOT transmit without an antenna or dummy load attached to the mobile radio. Doing so, will cause harm to the internal components of your radio.

You will want to choose a suitable antenna for the bands you plan on transmitting and receiving on. If you plan on transmitting on GMRS Channels you will want to ensure you have picked an antenna that states it is capable of working on 462-467MHz. If an antenna is not properly tuned for the frequency you transmit on – it can cause damage with the reflected power going back into the radio.

**Pick an antenna with SWR of less than 1.5:1 to safely transmit. (See page 16 for tuning hints)**

## Ground Plane

Antennas require an appropriate ground plane to properly work. This can be a car body (not a fiberglass car body, but some metal), or a set of ground radials for homebrewed antennas or commercially designed antennas which do not require an external set of radials.

## Magnetically Mounted Antennas:

These antennas must be grounded to a metal surface, such as a vehicle body. Magnetic base antennas do not properly operate unless they are fully magnetically grounded first. This is usually accomplished via the metal car body. Magnetic Antennas do NOT function properly on Plastic or fiberglass bodies.

## NMO or PL-259 Base Antennas:

These antennas will normally require a base or mobile hardware kit. These kits are grounded either through hardware or clamp inserts on vehicles, magnetically mounted, or available as stationary base hardware kits. Some antennas may include a base station ground plane or ground radial kit.

**CAUTION: When installing base antennas, stay clear of ALL power lines- they can kill you if you come in contact with them. Keep a minimum distance of 10 feet with the antenna and yourself from the lines.**

## Antenna Requirements

Antenna SWR Rating: 1.5:1 or less (on the radio frequencies in use.)

Antenna Impedance: 50 ohms (use 50 ohm rated coax and coax connectors)

Antenna Grounding: Ensure the antenna is mounted with a ground plane

Visually Inspect Coax/Connectors for any Slits or Damage – moisture should not be allowed to penetrate fittings or your coax

To maximize the life of your radio, it is important to understand antenna basics before transmitting on your radio, transmitting without an antenna, or with high SWR (Standing Wave Ratio) – can void warranty support.

An Accurate SWR Meter is a great tool to have when selecting an antenna for your needs. You can monitor and confirm that your SWR is within safe levels when setting up your radio for the first time (periodically checking SWR and your antenna set-up is advised). You will need to use an SWR meter designed for the UHF band. Other meters will NOT read correctly. Another option is an “Antenna Analyzer”. With those you can sweep the entire UHF band and find the “sweet spot” or resonant point of your antenna. Use this information to tune for the LOWEST SWR or lowest reflected power reading.

# Chapter 2. - GMRS Information and FCC Declaration

*THE BTECH GMRS-50V2 IS FCC PART 95E CERTIFIED FOR GMRS USAGE  
THE GMRS-50V2 REQUIRES A GMRS LICENSE TO TRANSMIT*

## GMRS Repeaters

The channels that are labeled "REPT" operate through repeaters that are set up for GMRS usage. Use these channels if you have permission from those that operate your local repeater for GMRS channels.

## FCC NOTICE AND DECLARATION

This device complies with part 15 of the FCC Rules. Operation is subject to the following two conditions:

1. This device may not cause harmful interference, and
2. This device must accept any interference received, including interference that may cause undesired operation

The scanning receiver in this equipment is incapable of tuning, or readily altered, by the user to operate within the frequency bands allocated to the Domestic public Cellular Telecommunications Service in Part



## FCC LICENSE REQUIRED FOR GMRS OPERATION

The GMRS-50V2 operates on GMRS (General Mobile Radio Service) frequencies, which require an FCC (Federal Communications Commission) license. You must be licensed prior to transmitting on all channels, which include the GMRS channels. Serious penalties could result for unlicensed use of GMRS channels, in violation of FCC rules, as stipulated in the Communications Act's Sections 501 and 502 (amended).

You will be issued a call sign by the FCC, which should be used for station identification when operating the radio on GMRS channels. You should also cooperate by engaging in permissible transmissions only, avoiding channel interference with other GMRS users, and being prudent with the length of your transmission time.

To obtain a license or ask questions about the license application, contact the FCC at 1-888-CALL FCC or go to the FCC's website: <https://www.fcc.gov/> and request form 605.

Or you can apply online direct for a GMRS license (<http://wireless.fcc.gov/uls/>) – a guide for this can be found at: <https://baofengtech.com/step-by-step-getting-a-gmrs-license/>

## GMRS Frequency Chart, Channel Guide

### GMRS FREQUENCY CHART

CH: Name	Ch. Freq	CH: Name	Ch. Freq	CH: Name	Ch. Freq	CH: Name	Ch. Freq	Offset
01: GMRS01*	462.56250	08: GMRS08**	467.5625	15: GMRS15	462.5500	23: REPT15	462.5500	+5MHz
02: GMRS02*	462.58750	09: GMRS09**	467.5875	16: GMRS16	462.5750	24: REPT16	462.5750	+5MHz
03: GMRS03*	462.61250	10: GMRS10**	467.6125	17: GMRS17	462.6000	25: REPT17	462.6000	+5MHz
04: GMRS04*	462.63750	11: GMRS11**	467.6375	18: GMRS18	462.6250	26: REPT18	462.6250	+5MHz
05: GMRS05*	462.66250	12: GMRS12**	467.6625	19: GMRS19	462.6500	27: REPT19	462.6500	+5MHz
06: GMRS06*	462.68750	13: GMRS13**	467.6875	20: GMRS20	462.6750	28: REPT20	462.6750	+5MHz
07: GMRS07*	462.71250	14: GMRS14**	467.7125	21: GMRS21	462.7000	29: REPT21	462.7000	+5MHz
				22: GMRS22	462.7250	30: REPT22	462.7250	+5MHz

\* Per FCC GMRS Radio Guidelines; Channels 1-7 are limited to Low Power - 5watt output

\*\*Per FCC GMRS Mobile Radio Guidelines Channels 8-14 transmitting is disabled; they can receive and monitor communications, but GMRS mobile radios cannot transmit on these channels.

# Chapter 3. – Basic Shortcuts and Use

## Microphone Keys

### Pound # Key

#### Keypad Lock

A quick toggle of the # will alternate power levels from High power to Medium Power to Low power. To enable or disable the keypad lock, press and hold the # key for about two seconds. The keypad lock will lock both the main radio buttons itself and also the handheld keypad. The PTT/MONI/and Power Buttons will not be locked when enabled.

### Star \* Key

A short momentary press of the \* key enables the reverse function (reverses the TX/RX settings according to Offset settings) This allows you to hear the signals into the system (repeater), to determine if simplex or direct radio to radio communications is possible.

When listening to broadcast FM a momentary press will start the scanning. Scanning in broadcast FM will stop as soon as an active station is found.

To enable scanning, press and hold the \* key for about two seconds

## Front Panel Buttons (Keys)

### V/M

Pressing the V/M key will switch the operation from VFO mode to Memory Recall mode. The present operational mode can be determined by looking at the text to the right of the main frequency/channel display. It will show VFO for VFO mode, and the channel number in Memory Recall mode.

### Call

Use this button to manually send the DTMF/2Tone/5Tone codes which can be set with the software programming.

### H/L Lock

Press this button momentarily to toggle the TX power levels (H→M→L).

Press and hold to Lock the front panel and microphone keys- all keys will be locked except PTT and the MONI buttons.

### FM

Press this button to turn on/off the FM Broadcast radio receiver.

### EXIT A/B/C/D

Press this button to exit the Menu, and also to cycle through the A/B/C/D Channels (A→B→C→D)

## General Operation

### Turning the unit on

To turn the unit on, simply push and hold the volume knob until it turns on. If your radio powers on correctly there should be an audible tone after about one second and the display will show a message

### Turning the unit off

To turn the unit off, simply push and hold the volume knob until it turns off. The unit is now off.

### Adjusting the volume

To turn up the volume, turn the volume knob/power knob clock-wise.

To turn down the volume, turn the volume/power knob counter-clock-wise.



*By using the monitor function (MONI button), you can more easily adjust your volume by adjusting it to the un-squelched static.*

## Making a call



Press and hold the PTT button on the side of the handheld mic to transmit. While transmitting, speak across the microphone at approximately 3-5cm (1-2 inches) from the microphone. When you release the PTT, your transceiver will go back to receive mode.

## Channel selection

There are two modes of operation: Frequency (VFO) mode, and Channel or Memory (MR) mode.

For everyday use, Channel (MR) mode is going to be a whole lot more practical than Frequency (VFO) mode. However, Frequency (VFO) mode is very handy for experimentation out in the field. Frequency (VFO) mode is also used for programming scanning channels into memory. For details on how to program your transceiver see Chapter 4.

## Frequency (VFO) mode



In Frequency (VFO) mode you can navigate up and down the band by using the microphone  and  keys (or rotating the selector knob). Each press (or rotation click) will increment or decrement your frequency according to the frequency step you've set your transceiver to (Menu Item 1: Step)

You can also input frequencies directly on your numeric keypad with kilohertz accuracy. However, the radio will tune to the nearest frequency that corresponds to your frequency step, in other words, when

you input frequencies with greater than 1kHz resolution (such as 145.6875 MHz in the example below), always round your input up.

## Channel (MR) mode

The use of Channel (MR) mode is dependent on actually having programmed in some channels to use. The GMRS-50V2 is pre-programmed with the 30 GMRS channels (see the GMRS Frequency Chart, Channel Guide in Chapter 2 for Channels and Transmitting restrictions). You can program additional analog scanning, GMRS, and NOAA channels into memory channels 000 to 255. NOAA WX Channels (RX) are loaded in memories 249-255 initially. All channels can be overwritten, or removed by the user if desired.

You can use the microphone  and  keys to navigate between channels (or rotate the selector knob)

## Monitor Both VFO & MR Modes

You can toggle between VFO and MR (Memory Recall) mode by either pressing the V/M button on the front of your radio, or you can toggle modes from the Handheld Mic by a long press of the 'Menu' button.

The VFO/MR mode will only toggle on the currently selected A/B/C/D line – while the other display lines will remain on VFO or MR as they were selected.

*This allows you to monitor both channel and frequency mode simultaneously*



# Chapter 4. – Programming Scanning Channels

The BTECH GMRS-50V2 features 226 additional (256 total) memory channels that each can hold: Receive frequencies, group signaling information, bandwidth, and a seven-character alphanumeric identifier or channel name

GMRS Channels (001-030) are programmed as a default from the factory and; also, after a full reset. Settings such as the calling tone can be edited on GMRS channels. These channels can also be removed if desired.

Channels 000-255 can be added or deleted via computer or manual programming.

## Manual programming

To create a new scanning channel, start by switching your radio to Frequency (VFO) mode (Press and Hold [MENU] button on the microphone or use the V/M button on the front panel).

When in Frequency (VFO) mode, select your desired receive frequency using the numerical keypad, or use the tuning (left) knob on the front panel. After that, use the menu system to configure the finer details of the channel you're wanting to program into a memory, such as bandwidth, CTCSS or DCS and more.

## Adding Scanning Channels

*The following steps assume that you're in Frequency (VFO) mode and that you've entered the desired frequency to store to memory.*

1. Press the **[MENU]** key to enter the menu.
2. Enter 46 on the numerical keypad to get to RCH-AD.
3. Press **[MENU]** to select.
4. Use the **▲** and **▼** keys to select an empty memory channel or enter it directly on the numerical keypad.
5. Press the **[MENU]** key to confirm.
6. Press the **[EXIT]** key to exit the menu.

Switch your radio to Memory (MR) mode by pressing the V/M button on the front panel, or press and hold the Menu button on the mic to test your new channel. If you would like to name your channel you will need to do that from a computer. More on that in the section called “Computer programming”.

# NOAA Weather Channels

162.400 MHz	162.425 MHz	162.450 MHz	162.475 MHz	162.500 MHz	162.525 MHz	162.550 MHz
01	02	03	04	05	06	07

NOAA Channel No.



## Adding a NOAA Channel

1. Press the **[MENU]** key to enter the menu.
2. Enter 64 on the numerical keypad to get to NCH-AD.
3. Press **[MENU]** to select.
4. Use the **▲** and **▼** keys to select an empty memory channel or enter it directly on the numerical keypad.
5. Press the **[MENU]** key to confirm.
6. The menu will display "NOAA\_\_", you need to enter the 2-digit NOAA channel number from the list above.

7. Press the **[MENU]** key to confirm.
8. Press the **[EXIT]** key to exit the menu.

Switch your radio to Memory (MR) (press V/M or long press MENU on mic) to test your newly added NOAA channel.

## Adding GMRS Channels

1. Press the **[MENU]** key to enter the menu.
2. Enter 63 on the numerical keypad to get to GCH-AD.
3. Press **[MENU]** to select.
4. Use the  and  keys to select an empty memory channel, or enter it directly on the numerical keypad.
5. Press the **[MENU]** key to confirm
6. The display will show “GMRS \_\_” at which point you enter the GMRS channel number (for example 02 for GMRS02). (Refer to GMRS Channel Chart in Chapter 2)
7. Press the **[MENU]** key to confirm.
8. Press the **[EXIT]** key to exit the menu.

## Computer programming

The Radio kit does not include a programming cable. To attain a PC cable please visit <https://BAOFENGTECH.com/accessories>

Download programming software at <https://baofengtech.com/> and find helpful guides at <http://www.miklor.com/> for more information on using the software

## Chapter 5. – Other Settings

### Toggle from High, Mid, to Low Power

A quick press of the Microphone '#' will alternate power levels between High, Mid, and Low power settings for TX. \*(Channels 15-30 Only)

### Storing an FM Radio Station and Scanning

Use the PC software to store FM radio channel names, you can name the FM channel and instead of displaying the frequency, your FM station will display the name. (Software FM option - FM channels are not stored, only the channel names are) Press the microphone [\*] key to scan the FM radio.

### Radio Lock

Hold the microphone [# key] for 2 seconds at standby to turn on/off the lock function. (The Lock icon appears, when the radio controls are locked- except for PTT and MONI). Hold for 2 seconds to turn off.

### PTT ID Setting

1. Use the PC software to change PTT-ID code.
2. Use Menu **18** settings on the radio to select the **PTTID** signal mode (2Tone, 5Tone, or DTMF),
3. Use Menu **20** settings to select when the **PTTID** (BOT, EOT, Both) is transmitted.

4. Use Menu 21 settings to program the PTTID transmit delay time.
5. After all the settings are set, when you transmit (Press the PTT), the radio will transmit the PTTID.





## DTMF RX Settings

This radio has DTMF encoding and decoding. Use the PC software to set the DTMF code first.

## DTMF TX Settings

In two-way radio systems, DTMF is most commonly used for automation systems and remote control. A common example would be in amateur radio repeaters where some repeaters are activated by sending out a DTMF sequence (usually a simple single-digit sequence).

**Table 7.1. DTMF frequencies and corresponding codes**

	1209 Hz	1336 Hz	1477 Hz	1633 Hz
697 Hz	1	2	3	A - 
770 Hz	4	5	6	B - 
852 Hz	7	8	9	C - 
941 Hz	*/scan	0	#/lock	D - 

The BTECH GMRS-50V2 has a full implementation of DTMF, including the A, B, C and D codes. The numerical keys, as well as the **[\*/scan]**, and **[#/lock]**, keys correspond to the matching DTMF codes as you would expect. The A, B, C and D codes are located in the **[MENU]**, **[▲]**, **[▼]** and **[EXIT/AB]** keys respectively.

**Manually TX DTMF Tones:** To manually send DTMF codes, press the key(s) while holding down the PTT key.

#### **Automatically TX DTMF Tones:**

**Save it to Memory and Transmit:** You can also program DTMF tones to the saved calling list (requires the PC software) to the one of the 15 Memory call banks in the radio. To transmit select the Pre-set DTMF saved setting on Menu 22 (S-Info) and then press the call key to send the saved DTMF TX tones.

## **Remote Stun**

**First set the DTMF Remote Stun Code and Master Control ID in Software:** When your radio receives the DTMF Remote Stun Tone Sequence (Set by software-also requires Menu 18 to accept DTMF signaling) it will command the radio to disable transmitting abilities. The Master ID station must first identify and send the PTTID (set in software as “Master ID”) – once the Master Station identifies itself, the radio is set to receive command tones, if the Monitor Remote Stun tones are received - the radio will no longer be able to transmit. *Both the master ID station and remote stun codes must be set up in software.*



## Remote Kill

**First set the DTMF Remote Kill Code and Master Control ID in Software:** When your radio receives the DTMF Remote Kill Tone Sequence (Set by software, also requires Menu 18 set to accept DTMF signaling) it will command the radio to disable transmitting and receiving. The Master ID station must first identify and send the PTTID (set in software as “Master ID”) – once the Master Station identifies itself, the radio is set to receive command tones. When the Monitor Remote Kill tones are received, the radio will no longer be able to transmit or receive. *Both the master ID station and remote kill tones must be set up in software.*

## Remote Revive

**First set the DTMF Remote Revive Code and Master Control ID in Software:** When your radio receives the DTMF Remote Revive Tone Sequence (Set by software, also requires Menu 18 set to accept DTMF signaling) it will reactivate the radio after it has been remotely stunned or killed. The Master ID station must first identify and send the PTTID (set in software as “Master ID”) – once the Master Station identifies itself, the radio is set to receive command tones. When the Monitor Remote Kill tone is received, the radio will return to normal operation from a stun/kill command. *Both the master ID station and remote revive tones must be set up in software.*

## Read More About Remote Commands

An In-Depth explanation is available at: <https://baofengtech.com/dtmf-remote-commands-on-the-uv-5x3/> which details Remote Commands and how to use them. This web page explains, with examples, on how DTMF remote commands are used

### DTMF Receive Settings, Transmit Setting (Call Key)

1. Press the **[MENU]** Key select **18 OPTSIG**, press the **[MENU]** Key, then select the DTMF function.
2. Press the **[MENU]** Key select **22 S-INFO**, press the **[MENU]** Key, then select the pre-code signal group (1-15). (The DTMF Signal must be saved first in the PC software setting under DTMF settings.
3. If properly set up (on Menu 18), your radio will open the squelch when it receives the required DTMF signal.
4. Press the **[CALL]** Key to send the same DTMF you have selected in Menu 22.

### 2TONE Receive Settings, Transmit Setting (Call Key)

1. Press the **[MENU]** Key select **18 OPTSIG**, press the **[MENU]** Key, then select the 2TONE function.
2. Press the **[MENU]** Key select **22 S-INFO**, press the **[MENU]** Key, then select the pre-code signal group (1-15). (The 2Tone Signal must be saved first in the PC software setting under 2TONE settings)

3. If properly set up (on Menu 18), your radio will open the squelch when it receives the required 2TONE signal.
4. Press the **[CALL]** Key to send the same 2TONE you have selected in Menu 22.

## 5Tone Receive Settings, Transmit Setting (Call Key)

1. Press the **[MENU]** Key select **18 OPTSIG**, press the **[MENU]** Key, then select the 5TONE function.
2. Press the **[MENU]** Key select **22 S-INFO**, press the **[MENU]** Key, then select pre-code signal group (1-15). (The 5Tone Signal must be saved first in the PC software setting under 5TONE settings)
3. If properly set up on Menu 18, your radio will open the squelch when it receives the required 5TONE signal.
4. Press the **[CALL]** Key to send the same 5TONE you have selected in Menu 22.

# Scanning modes

The scanner is configurable to one of three ways of operation: Time, carrier or search, each of which is explained in further details in their respective section below.

## Procedure 5.1. Setting scanner mode

1. Press the **[MENU]** key to enter the menu.
2. Enter **17 (SC-REV)** on your numeric keypad to come to scanner mode select.
3. Press the **[MENU]** key to select.
4. Use the **▲** and **▼** keys to select the scanning mode.
5. Press the **[MENU]** key to confirm and save.
6. Press the **[EXIT/AB]** key to exit the menu.

## Time operation

In Time Operation (TO) mode, the scanner stops when it detects a signal, and after a factory pre-set time out, it resumes scanning.

## Carrier operation

In Carrier Operation (CO) mode, the scanner stops when it detects a signal, and after a factory preset time with no signal it resumes scanning.



## Search operation

In Search Operation (SE) mode, the scanner stops when it detects a signal.

To resume scanning you must press and hold the  key again.

## SKIP Scanning Channels

You can configure channels to be added or removed from the scanning list on the fly.

1. Press the **[MENU]** key to enter the menu.
2. Enter Menu Item **16 (SC-ADD)** on your numeric keypad to come to scanning add mode.
3. Press the **[MENU]** key to select.
4. Use the  and  keys to select if the channel will be added or removed from the scanning list. The change will apply to the current channel selected
5. Press the **[MENU]** key to confirm and save.
6. Press the **[EXIT/AB]** key to exit the menu.

## Scanning a Frequency Range (VFO Mode)

The GMRS-50V2 can scan a user selected frequency range

1. Press and hold  for about 2 seconds

2. The Display will show: **RANGE ---:---**
3. Enter the Frequency Range (In MHz) Desired
4. *Example: 144:146*
5. The Radio will scan the frequency range from 144.000MHz-145.9975MHz According to Your Frequency Step (See Menu 1 Description)

## Tone Scanning

### Scanning for CTCSS and DCS Tones/Codes



*Scanning for a CTCSS tone or DCS code can be done while Frequency Mode (VFO) or Channel Mode (MR) is selected. Only when VFO mode is selected, can the detected tone/code be saved to menu 11/10.*

*CTCSS tone and DCS code scanning mode can be accessed with or without a signal being present. The scanning process itself only occurs while a signal is being received. Not all repeaters requiring a CTCSS tone or DCS code for access will transmit one back. In that case, the transmitter of a station that can access the repeater would need to be scanned. In other words: this would be done by listening to stations on the repeater's input frequency.*

## Scanning for CTCSS Tone

### *(ACTIVE SIGNAL REQUIRED)*

1. Press the **[MENU]** key to enter the menu.
2. Enter **11** on your numeric keypad to come to Menu 11: **R-CTCS**
3. Press the **[MENU]** key to select. **Insure you have a tone selected (and it is not OFF)**
4. Press the  to begin CTCSS scanning

A flashing "CT" will be in the left status display to indicate the radio is in CTCSS scanning mode. In this mode, whenever the radio is receiving an RF signal on the selected MR channel or VFO frequency, the lower display will cycle through the CTCSS tones as they are being tested. Once the frequency of the received CTCSS tone is determined, the "CT" indicator will stop flashing and you will hear the signal.

Press the **[MENU]** key to save the scanned tone into memory (VFO Mode Only) then press the **[EXIT/AB]** key to exit the menu.



*Don't forget to set VFO menu 11 back to OFF when the CTCSS tone is no longer required.*

## Scanning for a DCS tone

*(ACTIVE SIGNAL REQUIRED)*

1. Press the **[MENU]** key to enter the menu.
2. Enter **10** on your numeric keypad to come to Menu 10: **R-DCS**
3. Press the **[MENU]** key to select. **Insure you have a tone selected (and it is not off)**
4. Press the **[\*SCAN]** to begin DCS scanning

A flashing "DCS" will be in the left status display to indicate the radio is in DCS scanning mode. In this mode, whenever the radio is receiving an RF signal on the selected MR channel or VFO frequency, the lower display will cycle through the DCS codes as they are being tested. Once the bits of the received DCS code are determined, the "DCS" indicator will stop flashing and you will hear the signal.

Press the **[MENU]** key to save the scanned tone into memory (VFO Mode Only) then press the **[MENU]** key to exit the menu.



*Don't forget to set VFO menu 10 back to OFF when the DCS tone is no longer required.*



## Dual, Tri, and Quad Watch (TMR)

In certain situations, the ability to monitor two, three or even four channels at once can be a valuable asset.

The BTECH GMRS-50V2 features Dual, Tri, and Quad Watch functionality with the ability scan between two to four frequencies at a fixed interval and to lock the transmit frequency to one of the four channels it monitors

1. Press the **[MENU]** key to enter the menu.
2. Enter **0** on the numeric keypad to get to the **TMR** Watch Settings
3. Press **[MENU]** to select which channels are monitored (See Appendix A).
4. Use the **▲** and **▼** keys to enable or disable.
5. Press the **[MENU]** key to confirm.
6. Press the **[EXIT/AB]** key to exit the menu.

Due to the way the BTECH GMRS-50V2 is constructed, whenever one of the A, B, C, or D Frequencies (VFO/MR) goes active, it will default to transmit on that channel for the time you have selected on

Menu 54 – this can be turned off and is explained below:

### Locking the Default Transmit channel

1. Press the **[MENU]** key to enter the menu.
2. Enter **54** on the numeric keypad to get to **TMR-MR**.
3. Press **[MENU]** to select.
4. Select **OFF** to turn off the TMR switching time
5. Press the **[MENU]** key to confirm.
6. Press the **[EXIT/AB]** key to exit the menu.
7. The radio will now only transmit on the Main channel selected (The Main Frequency indicator arrow will be pointing at the display set as primary)
8. Setting a time value will allow the TX to occur on the last active channel. You must push the PTT within the selected time for this to be possible.

## Chapter 6. - Selective calling

Sometimes when you're working with larger groups of people using the same channel, things can get very crowded, very fast. To minimize this problem, several methods of blocking out unwanted transmissions on your frequency have developed. In general, there are two forms of selective calling in two-way radio systems: Group calling, and individual calling.

Group calling, as the name suggest, is a one-to-many form of communication. Every radio in your working group is configured the same way and any radio will make contact with every other radio in the group.

Individual calling, sometimes also known as paging, is a one-to-one form of communication. Every radio is programmed with a unique ID code. And only by sending out a matching code can you get that radio to open up to your transmissions.

The BTECH GMRS-50V2 features three additional ways of group calling  
**(2TONE, 5TONE, AND DTMF CALLING ARE FOUND IN CHAPTER 5):**

- CTCSS
- DCS

- Tone-burst (1000Hz, 1450Hz, 1750Hz, 2100Hz)



*Using these features does NOT mean that others won't be able to listen in on your transmissions.*

*They only provide a method to filter out unwanted incoming transmissions. Any communications made while using these features will still be heard by anyone not employing filtering options of their own.*

*You can change the CTCSS or DCS settings while in memory (MR) mode.*

CTCSS, DCS, and 1750Hz tone-burst are also popular methods among amateur radio operators to open up repeaters.

# CTCSS

CTCSS is set with menus **11 R-CTCS** and **13 T-CTCS**.

## Procedure 8.1. CTCSS setup how-to

1. Press the **[MENU]** key to enter the menu.
2. Enter **11** on the numeric keypad to get to receiver CTCSS (**R-CTCS**).
3. Press **[MENU]** to select.
4. Enter desired CTCSS sub-tone frequency in hertz on the numeric keypad, or rotate the main knob to set the frequency.
5. Press **[MENU]** to confirm and save.
6. Enter **13** on the numeric keypad to go to transmitter CTCSS (**T-CTCS**).
7. Press **[MENU]** to select.
8. Enter desired CTCSS sub-tone frequency in hertz on the numeric keypad, or rotate the main knob to set the desired frequency. Make sure it's the same frequency as that you entered for receiver CTCSS.
9. Press **[MENU]** to confirm and save.
10. Press **[EXIT/AB]** to exit the menu system.

To turn CTCSS off, follow the same procedure but set it to off with the 0 key, or rotate the main knob to "OFF" instead of selecting a CTCSS sub-tone frequency.

For more information see the section called “11 R-CTCS - Receiver CTCSS” and the section called “13 T-CTCS - Transmitter CTCSS” in Appendix B, Menu definitions.

## DCS

DCS is set with menus **10 R-DCS** and **12 T-DCS**.

For a complete list of available DCS codes, see Table C.1, “DCS Codes” in Appendix C, *Technical specifications*.

### Procedure 8.2. DCS setup how-to

1. Press the **[MENU]** key to enter the menu.
2. Enter **10** on the numeric keypad to get to receiver DCS (**R-DCS**).
3. Press **[MENU]** to select.
4. Scroll to the desired DCS code on the numeric keypad, or rotate the main knob to the desired frequency.
5. Press **[MENU]** to confirm and save.
6. Enter **12** on the numeric keypad to go to transmitter DCS (**T-DCS**).
7. Press **[MENU]** to select.
8. Scroll to the desired DCS code on the numeric keypad or rotate the main knob to the desired frequency. Make sure it's the same code as that you entered for receiver DCS.
9. Press **[MENU]** to confirm and save.
10. Press **[EXIT/AB]** to exit the menu system.

To turn DCS off, follow the same procedure but set it to off with the “0” key instead of selecting a DCS code.

For more information see the section called “10 R-DCS - Receiver DCS” and the section called “12 T-DCS - Transmitter DCS” in Appendix B, *Menu definitions*.

## 1000Hz, 1450Hz, 1750Hz, 2100Hz Tone-burst

To send out a tone-burst; you simultaneously will press the PTT key while holding down the Call button.

To configure which Tone Burst is transmitted select the Tone Burst desired from Menu Item 50 (REP-S)

PTT + **CALL** = Selected Tone Burst (Selectable in Menu 50: REP-S)

# Part III. How-to and setup guides.

*Part three covers is a collection of how-to documents to help you set up your radio for specific working environments.*

## Chapter 7. - Customization

### Text Display Colors

The LCD on the BTECH Mobiles are backlit multi-color LEDs, the color of which can be pre-set from the menu system into a variety of colors.

To change the colors, follow these steps:



1. Press the **[MENU]** key to enter the menu.
2. Enter one of the following on your numeric keypad:
  - a. **33** to change the status icons text color (**ST-FC**)
  - b. **34** to change the primary selected channel/frequency display text color (**MF-FC**)
  - c. **35** to change the memory bank A (TMR-A) text color (**SFA-FC**)
  - d. **36** to change the memory bank B (TMR-B) text color (**SFB-FC**)
  - e. **37** to change the memory bank C (TMR-C) text color (**SFC-FC**)



- f. **38** to change the memory bank D (TMR-D) text color (**SFC-FD**)
  - g. **39** to change the receiving privacy tone (decode) bank text color (**SUB-FC**)
  - h. **40** to change the current voltage bank text color (**FM-FC**)
  - i. **41** to change the bottom status bar text color (**SIG-FC**)
  - j. **42** to change the VFO/MR mode display color (to the right of the primary channel/frequency) (**MOD-FC**)
  - k. **43** to change the menu display text color (**MENUFC**)
  - l. **44** to change display color while transmitting on the primary display/TMR bank/and microphone input volume (**TX-FC**)
3. Press **[MENU]** key to select.
  4. Use the **▲** and **▼** keys to pick the desired color.
  5. Press **[MENU]** to confirm and save.
  6. Press **[EXIT/AB]** to exit the menu.

## Sync Display Channels

To sync channels on the display (simultaneously display channel and multi watch channels to display simultaneous information), follow these steps:

1. Press the **[MENU]** key to enter the menu.
2. Enter **32** on your numeric keypad to come to the Sync Menu
3. Press **[MENU]** key to select.
4. Use the  and  keys to select:
  - a. **OFF**- To Remove Sync of A/B, C/D, or AB+CD combinations with Main Display.
  - b. **AB** –To sync A/B Displays and Main Display
  - c. **CD** – To sync C/D Displays and Main Display
  - d. **AB+CD** – To sync either A/B or C/D Displays with Main Display (depends on which channel is being used- A, B, C, or D)
5. Press **[MENU]** to confirm and save.
6. Press **[EXIT/AB]** to exit the menu.

Use SYNC in Conjunction with Menus 27,28,29 & 30 to coordinate what is displayed on each line (Name, Frequency, or Channel Number) –See *Appendix B Menu definitions*

## Appendix A. - Menu definitions

0	TMR	Transmit Multi Receive	OFF	<p>This mode selects what displays are monitored in the background besides the primary selected channel. You can mix and match between all or partial channels to allow dual, tri, and quad watch</p> <p>Selected Memory + Displays (A, B, C, D)</p> <p>M = Selected Memory                      A = Display A                      B = Display B                      C = Display C                      D = Display D</p>
			M+A	
			M+B	
			M+C	
			M+D	
			M+A+B	
			M+A+C	
			M+A+D	
			M+B+C	
			M+B+D	
			M+C+D	
			M+A+B+C	
			M+A+B+D	
			M+A+C+D	
M+B+C+D				
A+B+C+D				
1	STEP	Frequency Step Size Setup	2.5 to 25. kHz	2.5, 5, 6.25, 10, 12.5, 25 kHz

2	SQL	Squelch Level	00 > 09	10 squelch levels 00 = minimum / normally open 10 = maximum squelch (tightest)
3	TXP	Transmit Power	High	Full Power – 50W
			Mid	Mid Power – 20W
			Low	Low Power – 5W
4	AUTOLK	Auto Keypad Lock	ON	Keypad Auto Lock Enabled
			OFF	Keypad Auto Lock Disabled
5	TOT	TX Time Out Timer	15 > 600 secs	15 second steps
6	APO	Auto Power Off	30 - 300 minutes	Time Set that radio will Power Off after last signal received.
			OFF	Turn off APO Option
7	WN	Bandwidth	Wideband	25.0 kHz
			Narrowband	12.5 kHz
8	ABR	Display Backlight Time	0-50 seconds	Set to backlight OFF (0), or time delay to shut off the Display Backlight
9	BEEP	Control Beeps	ON / OFF	Turn ON / OFF Control Beeps
10	R-DCS	Receive - Digital Coded Squelch	D023N > D754I	Squelch opens when proper DCS code is detected
			OFF	No DCS code required
11	R-CTCS	Receive - Analog	67.0 > 254.1 Hz	Squelch opens when proper CTCSS tone detected

		Tone Squelch	OFF	No CTCSS tone required
12	T-DCS	Transmit - DCS Code	D023N > D754I	Transmits specified code
			OFF	No DCS code transmitted
13	T-CTCS	Transmit - CTCSS Code	67.0 > 254.1 Hz	Transmits specified tone
			OFF	No CTCSS tone transmitted
14	DTMFST	Determines when DTMF codes are heard through speaker	OFF	No DTMF tone heard
			KEY	Only manually keyed DTMF codes are heard
			ID	Only automatically keyed DTMF codes are heard
			BOTH	All DTMF codes are heard
15	BCL	Busy Channel Lockout	ON	Prevents transmit if active signal on the channel
			OFF	No lockout
16	SC-ADD	Add Scan Channel	ON	Add channel to scan list
			OFF	Remove channel from scan list
17	SC-REV	Scan Resume Method	TO	(Time Operation) Scan stops when signal detected. The scan resumes after approximately 5 seconds (even if the channel is still active).
			CO	(Carrier Operation) Scan stops when signal detected. Scan resumes when signal disappears.
			SE	(Search Operation) Scan stops when signal detected. Scanning will not resume.

18	OPTSIG	Optional Signaling	OFF	No optional signaling
			DTMF	DTMF signaling selected
			2TONE	2TONE signaling selected
			5TONE	5TONE signaling selected
19	SPMUTE	Speaker Mute Settings	QT	Squelch opens for CTCSS/DCS tones only.
			AND	Squelch opens when CTCSS/DCS tone is recognized along with the optional signaling.
			OR	Squelch opens when either the CTCSS/DCS tone OR the optional signaling is recognized.
20	PTT-ID	PTT ID - When to send	OFF	Do not send
			BOT	Send at Beginning of Transmission
			EOT	Send at the End of Transmission
			BOTH	Send at both Beginning and End
21	PTT-LT	PTT ID - Transmit Delay	0 > 30	Set Delay Time before transmitting PTT-ID
22	S-INFO	Auto Group Dialing	Group Signal Code Memory	1 > 15
				Can only be set with software
23	EMC-TP	Alarm Mode	OFF	Alarm Mode Completely Disabled
			ALARM	Turn on Alarm sound
			ANI	Send Alarm code and ID code
			BOTH	Both of the above
24	EMC-CH	Alarm Channel	000 > 255	Specified Alarm Channel
25	SIG-BP	Signal Beep	ON	Pager Ring at Reception of Matching 2Tone/5Tone/DTMF

			OFF	Tone OFF
26	CHNAME	Channel Name Edit	In Channel Mode, edits the Current Name	
27	CA-MDF	Channel A	FREQ	In Channel Mode, display the selected format in display A
		Display Mode	CH	
			NAME	
28	CB-MDF	Channel B	FREQ	In Channel Mode, display the selected format in display B
		Display Mode	CH	
			NAME	
29	CC-MDF	Channel C	FREQ	In Channel Mode, display the selected format in display C
		Display Mode	CH	
			NAME	
30	CD-MDF	Channel D	FREQ	In Channel Mode, display the selected format in display D
		Display Mode	CH	
			NAME	
31	VOX	Voice Operated Transmitter	Off	VOX Off
			1....10	Set Level- 1 is least sensitive, 10 is most sensitive
32	SYNC	Display Sync	OFF	Separate A/B/C/D channel display.
			AB	Synchronizes display AB, CD, or AB+CD
			CD	This allows the upper display to show channel name while the lower shows the frequency, name or channel number. You can sync the left 2, right 2, or both sections simultaneously
			AB + CD	

33	ST-FC	Status Icons Color Foreground Color (Text)	Select Color	WHITE, RED, BLUE, GREEN, YELLOW, INDIGO, PURPLE, GRAY
34	MF-FC	Primary Selected Channel Foreground Color (Text)	Select Color	WHITE, RED, BLUE, GREEN, YELLOW, INDIGO, PURPLE, GRAY
35	SFA-FC	Display Channel A Text Foreground Color (Text)	Select Color	WHITE, RED, BLUE, GREEN, YELLOW, INDIGO, PURPLE, GRAY
36	SFB-FC	Display Channel B Text Foreground Color (Text)	Select Color	WHITE, RED, BLUE, GREEN, YELLOW, INDIGO, PURPLE, GRAY
37	SFC-FC	Display Channel C Text Foreground Color (Text)	Select Color	WHITE, RED, BLUE, GREEN, YELLOW, INDIGO, PURPLE, GRAY



38	SFD-FC	Display Channel D Text Foreground Color (Text)	Select Color	WHITE, RED, BLUE, GREEN, YELLOW, INDIGO, PURPLE, GRAY
39	SUB-FC	Decode Tone Text Color Foreground Color (Text)	Select Color	WHITE, RED, BLUE, GREEN, YELLOW, INDIGO, PURPLE, GRAY
40	FM-FC	Voltage Text Display Color Foreground Color (Text)	Select Color	WHITE, RED, BLUE, GREEN, YELLOW, INDIGO, PURPLE, GRAY
41	SIG-FC	Status (Bottom) Bar Display Foreground Color (Text)	Select Color	WHITE, RED, BLUE, GREEN, YELLOW, INDIGO, PURPLE, GRAY
42	MOD-FC	Main Frequency Mode/Channel Number Foreground Color (Text)	Select Color	WHITE, RED, BLUE, GREEN, YELLOW, INDIGO, PURPLE, GRAY

43	MENUFC	Menu Text Display Color Foreground Color (Text)	Select Color	WHITE, RED, BLUE, GREEN, YELLOW, INDIGO, PURPLE, GRAY
44	TX-FC	Transmitting Channel Color Foreground Color (Text)	Select Color	WHITE, RED, BLUE, GREEN, YELLOW, INDIGO, PURPLE, GRAY
45	RCH-AD	Add Receive Channel	000 > 255	Indicates channel number to be stored.
46	DEL-CH	Delete Channel	000 > 255	Indicates channel number to be deleted.
47	SFT-D	Frequency Shift Direction	OFF	Shifts TX frequency in either a plus direction or a – direction from the RX frequency
			+	
			-	
48	OFFSET	Frequency Shift Offset Amount	00.00 > 69.99	Amount of the offset frequency shift.
49	ANI	ANI ID Code	Can only be set with software	
50	ANI-L	ANI Length	3, 4, 5	Length of ANI ID code
51	REP-S	Repeater Activation Tone	1000Hz 1450Hz 1750Hz 2100Hz	Audible tone for repeater activation
52	REP-M	Repeater Forwarding	OFF	Turns Mode off
			CARRI	Carrier activates repeater

		Mode (X-Band Repeater with 2 BTECH Mobiles)	CTDCS	CTCSS or DCS Tone required to activate repeater
			TONE	Audible Tone required to activate repeater
			DTMF	DTMF code required to activate repeater
53	TMR-MR	TMR - Return Time Delay to Primary Channel; Sets the PTT to the last received transmission channel. Time delay selectable	OFF	Function OFF - Transmits always on Primary Channel
			1 > 50 seconds	This is the delay time before returning to the primary channel after secondary signal is clear.
54	STE	Squelch Tail Elimination	OFF	Function OFF
		Requires both radios have function ON.	ON	Eliminates squelch tail at end of transmission.
55	RP-STE	Repeater Squelch Tail Elimination	OFF	Function OFF
		Requires a	1 > 10	Delay Time

		repeater using this function.		
56	RPT-DL	Repeater squelch tail delay.	OFF	Function OFF
			1 > 10	Delay Time
57	DTMF-G	DTMF Gain /	0 > 60	0 = Lowest Audio Gain
		Audio Level		60 = Highest Gain
58	MIC-G	Microphone Gain /	0 > 127	0 = Lowest Audio Gain
		Audio Level		127 = Highest Gain
59	SKIPTX	Quad Frequency Operation: Randomize transmitting channels - with another corresponding mobile on the same 4 channels transmissions can be spread apart on the four channels in 2 modes.	OFF	
			SKIP1	Randomizes in between after both transmitting and receiving, requires both a received and a transmission before going to another random frequency
			SKIP2	Alternates transmitting on A, B, C, D - each PTT Press the radio will transmit on the next channel in order of their display (A-B-C-D-Repeat)

60	SC-MOD	Automatic Scan Resume Method	OFF	Scan is disabled with a Radio Reboot, or by Pressing a Menu Key / PTT
			PTT-SC	Scanning will resume after transmitting (or other Menu Operations)
			MEM-SC	Scan Memory during Radio Reboot: If scanning was active when the radio was powered down, the radio will resume scanning on restart. (Scanning also resumes after transmitting or other Menu Operations)
			PON-SC	Power on Scan: The radio will start scanning upon turning on - no matter what state it was in when powering down. Also, the radio will scan after Menu operations or transmitting
61	TMR-TX		Track	TRACKED is used with Menu 54 and will transmit in response to the active receiving channel (depending on the TMR delay time you have set on Menu 54 before returning to the primary selected channel.
			FIXED	FIXED- Will only TX on Primary Selected Channel
62	GCH-AD	Quick GMRS Channel Add	GCHxx	ADD GMRS channels to memory channels between 000-255
63	NCH-AD	Quick NOAA Channel Add	NCHxx	ADD NOAA channels to memory channels between 000-255- NOAA Channel number is found on Page 27
64	EARPHO		OFF	Turn off earphone operation
			EAR	Use Earphone only
			EAR+SPKR	Use Earphone + Internal Speaker
65	RESET	Initialize to Factory Defaults	VFO	Menu Initialization
			ALL	Menu and Channel Initialization

## FCC Notice



*NOTE: This equipment has been tested and found to comply with the limits for a Class B digital device, pursuant to part 15 of the FCC Rules. These limits are designed to provide reasonable protection against harmful interference in a residential installation. This equipment generates uses and can radiate radio frequency energy and, if not installed and used in accordance with the instructions, may cause harmful interference to radio communications. However, there is no guarantee that interference will not occur in a particular installation. If this equipment does cause harmful interference to radio or television reception, which can be determined by turning the equipment off and on, the user is encouraged to try to correct the interference by one or more of the following measures:*

- Reorient or relocate the receiving antenna.
- Increase the separation between the equipment and receiver.
- Connect the equipment into an outlet on a circuit different from that to which the receiver is connected.
- Consult the dealer or an experienced radio/TV technician for help

Changes or modifications not expressly approved by the party responsible for compliance could void the

user's authority to operate the equipment. This device complies with Part 15 of the FCC Rules. Operation is subject to the following two conditions:

- (1) this device may not cause harmful interference, and
- (2) this device must accept any interference received, including interference that may cause undesired operation.

WARNING: MODIFICATION OF THIS DEVICE TO RECEIVE CELLULAR RADIOTELEPHONE SERVICE SIGNALS IS PROHIBITED UNDER FCC RULES AND FEDERAL LAW.

## Appendix B. - Technical specifications

### General

Specification	Value
Frequency Range (MHz)	65-108 (Rx) 136-174 (Rx) 400-520 (Rx) GMRS Channels (Rx/Tx) (Channels 001-007, 015-030) GMRS Channels (Rx Only) (Channels 008-014)
Memory channels	256
Frequency stability	2.5ppm
Frequency step (kHz)	2.5K/5.0K/6.25K/10.0K/12.5K/25.0K
Squelch Setup	CARRIER / CTCSS / DCS / 5Tone / 2TONE / DTMF
Antenna impedance	50 Ohm
Operating temperature	-20°C to +60°C
Supply voltage	13.8V DC±15%: 20A Peak GMRS-50V2
Dimension	GMRS-50V2: 5.7(W) x 1.85 (H) x 7.5 (D)in; 2.2lb
Operating Temperature	-5°F - +140°F

### Receiver

#### *Receiver specifications*



	Broadband	Narrow band
Sensitivity	$\leq 0.25\mu V$	$\leq 0.35\mu V$
Channel choice	$\geq 70\text{dB}$	$\geq 60\text{dB}$
Intermodulation	$\geq 65\text{dB}$	$\geq 60\text{dB}$
Spurious Rejection	$\geq 70\text{dB}$	$\geq 70\text{dB}$
Audio response	+1~-3dB (0.3-3KHz)	+1~-3dB (0.3~2.55KHz)
Signal to noise ratio	$\geq 45\text{dB}$	$\geq 40\text{dB}$
Audio Distortion	$\leq 5\%$	
Audio output power	$\geq 2W@10\%$	

## Transmit

	Broadband	Narrow band
Output power	50W/ 20W/ 5W - GMRS-50V2	
Modulation Mode	16K $\phi$ F3E	11K $\phi$ F3E
Channel Power	$\geq 70\text{dB}$	$\geq 60\text{B}$
Signal to noise ratio	$\geq 40\text{dB}$	$\geq 36\text{dB}$
Parasitic harmonic	$\geq 60\text{dB}$	$\geq 60\text{dB}$
Audio response	+1~-3dB (0.3-3KHz)	+1~-3dB (0.3-2.55KHz)
Audio distortion	$\leq 5\%$	

# DCS table

Table C.1. DCS Codes

Number	Code	Number	Code	Number	Code	Number	Code
001	D023N	002	D025N	003	D026N	004	D031N
005	D032N	006	D036N	007	D043N	008	D047N
009	D051N	010	D053N	011	D054N	012	D065N
013	D071N	014	D072N	015	D073N	016	D074N
017	D114N	018	D115N	019	D116N	020	D122N
021	D125N	022	D131N	023	D132N	024	D134N
025	D143N	026	D145N	027	D152N	028	D155N
029	D156N	030	D162N	031	D165N	032	D172N
033	D174N	034	D205N	035	D212N	036	D223N
037	D225N	038	D226N	039	D243N	040	D244N
041	D245N	042	D246N	043	D251N	044	D252N
045	D255N	046	D261N	047	D263N	048	D265N
049	D266N	050	D271N	051	D274N	052	D306N
053	D311N	054	D315N	055	D325N	056	D331N
057	D332N	058	D343N	059	D346N	060	D351N
061	D356N	062	D364N	063	D365N	064	D371N
065	D411N	066	D412N	067	D413N	068	D423N
069	D431N	070	D432N	071	D445N	072	D446N

<b>073</b>	D452N	<b>074</b>	D454N	<b>075</b>	D455N	<b>076</b>	D462N
<b>077</b>	D464N	<b>078</b>	D465N	<b>079</b>	D466N	<b>080</b>	D503N
<b>081</b>	D506N	<b>082</b>	D516N	<b>083</b>	D523N	<b>084</b>	D526N
<b>085</b>	D532N	<b>086</b>	D546N	<b>087</b>	D565N	<b>088</b>	D606N
<b>089</b>	D612N	<b>090</b>	D624N	<b>091</b>	D627N	<b>092</b>	D631N
<b>091</b>	D627N	<b>092</b>	D631N	<b>093</b>	D632N	<b>094</b>	D645N
<b>094</b>	D645N	<b>095</b>	D654N	<b>096</b>	D662N	<b>094</b>	D645N
<b>097</b>	D664N	<b>098</b>	D703N	<b>099</b>	D718N	<b>100</b>	D723N
<b>101</b>	D731N	<b>102</b>	D732N	<b>103</b>	D734N	<b>104</b>	D743N
<b>105</b>	D754N	<b>106</b>	D023I	<b>107</b>	D025I	<b>108</b>	D026I
<b>109</b>	D031I	<b>110</b>	D032I	<b>111</b>	D036I	<b>112</b>	D043I
<b>113</b>	D047I	<b>114</b>	D051I	<b>115</b>	D053I	<b>116</b>	D054I
<b>117</b>	D065I	<b>118</b>	D071I	<b>119</b>	D072I	<b>120</b>	D073I
<b>121</b>	D074I	<b>122</b>	D114I	<b>123</b>	D115I	<b>124</b>	D116I
<b>125</b>	D122I	<b>126</b>	D125I	<b>127</b>	D131I	<b>128</b>	D132I
<b>129</b>	D134I	<b>130</b>	D143I	<b>131</b>	D145I	<b>132</b>	D152I
<b>133</b>	D155I	<b>134</b>	D156I	<b>135</b>	D162I	<b>136</b>	D165I
<b>137</b>	D172I	<b>138</b>	D174I	<b>139</b>	D205I	<b>140</b>	D212I
<b>141</b>	D223I	<b>142</b>	D225I	<b>143</b>	D226I	<b>144</b>	D243I
<b>145</b>	D244I	<b>146</b>	D245I	<b>147</b>	D246I	<b>148</b>	D251I

<b>149</b>	D252I	<b>150</b>	D255I	<b>151</b>	D261I	<b>152</b>	D263I
<b>153</b>	D265I	<b>154</b>	D266I	<b>155</b>	D271I	<b>156</b>	D274I
<b>157</b>	D306I	<b>158</b>	D311I	<b>159</b>	D315I	<b>160</b>	D325I
<b>161</b>	D331I	<b>162</b>	D332I	<b>163</b>	D343I	<b>164</b>	D346I
<b>165</b>	D351I	<b>166</b>	D356I	<b>167</b>	D364I	<b>168</b>	D365I
<b>169</b>	D371I	<b>170</b>	D411I	<b>171</b>	D412I	<b>172</b>	D413I
<b>173</b>	D423I	<b>174</b>	D431I	<b>175</b>	D432I	<b>176</b>	D445I
<b>177</b>	D446I	<b>178</b>	D452I	<b>179</b>	D454I	<b>180</b>	D455I
<b>181</b>	D462I	<b>182</b>	D464I	<b>183</b>	D465I	<b>184</b>	D466I
<b>185</b>	D503I	<b>186</b>	D506I	<b>187</b>	D516I	<b>188</b>	D523I
<b>189</b>	D526I	<b>190</b>	D532I	<b>191</b>	D546I	<b>192</b>	D565I
<b>193</b>	D606I	<b>194</b>	D612I	<b>195</b>	D624I	<b>196</b>	D627I
<b>197</b>	D631I	<b>198</b>	D632I	<b>199</b>	D645I	<b>200</b>	D654I
<b>201</b>	D662I	<b>202</b>	D664I	<b>203</b>	D703I	<b>204</b>	D712I
<b>205</b>	D723I	<b>206</b>	D731I	<b>207</b>	D732I	<b>208</b>	D734I
<b>209</b>	D743I	<b>210</b>	D754I				

# CTCSS table

**Table C.2. Default CTCSS Frequencies**

Frequency	Frequency	Frequency	Frequency
67.0	69.3	71.9	74.4
77.0	79.7	82.5	85.4
88.5	91.5	94.8	97.4
100.0	103.5	107.2	110.9
114.8	118.8	123	127.3
131.8	136.5	141.3	146.2
151.4	156.7	159.8	162.2
165.5	167.9	171.3	173.8
177.8	179.9	183.5	186.2
189.9	192.8	196.6	199.5
203.5	206.5	210.7	218.1
225.7	229.1	233.6	241.8
250.3	254.1		

**This device complies with part 15 of the FCC Rules.**

Operation is subject to the following two conditions:

- (1) This device may not cause harmful interference, and
- (2) this device must accept any interference received, including interference that may cause undesired operation.

Any Changes or modifications not expressly approved by the party responsible for compliance could void the user's authority to operate the equipment.

Note: This equipment has been tested and found to comply with the limits for a Class B digital device, pursuant to part 15 of the FCC Rules. These limits are designed to provide reasonable protection against harmful interference in a residential installation. This equipment generates uses and can radiate radio frequency energy and, if not installed and used in accordance with the instructions, may cause harmful interference to radio communications. However, there is no guarantee that interference will not occur in a particular installation. If this equipment does cause harmful interference to radio or television reception, which can be determined by turning the equipment off and on, the user is encouraged to try to correct the interference by one or more of the following measures:

- Reorient or relocate the receiving antenna.
- Increase the separation between the equipment and receiver.
- Connect the equipment into an outlet on a circuit different from that to which the receiver is connected.
- Consult the dealer or an experienced radio/TV technician for help.

**WARNING: MODIFICATION OF THIS DEVICE TO RECEIVE CELLULAR RADIOTELEPHONE SERVICE SIGNALS IS PROHIBITED UNDER FCC RULES AND FEDERAL LAW.**

**FCC PART 95 Warning**

This device operates on GMRS (General Mobile Radio Service) frequencies, which require an FCC (Federal Communications Commission) license. You must be licensed prior to transmitting on these frequencies. Serious penalties could result for unlicensed use of GMRS frequencies in violation of FCC rules, as stipulated in the Communications Act's Sections 501 and 502 (amended, You will be issued a call sign by the FCC. which should be used for station identification when operating the radio on GMRS frequencies. You should also cooperate by engaging in permissible transmissions only, avoiding channel interference with other GMRS users and being prudent with the length of your transmission time.

This equipment complies with FCC radiation exposure limits set forth for an uncontrolled environment. This equipment should be installed and operated with minimum distance 80cm between the radiator & your body.