

S

T

S

L

A

B



FCC Part 15B TEST REPORT

Report No.: STS2205214E02

Issued for

BTECH (BaoFeng Tech)

702 N Industrial Ave Arlington South Dakota United States
57212

Product Name:	GMRS mobile radio
Brand:	BTECH
Model Number:	GMRS-50V2
Series Model(s):	N/A
FCC ID:	2AGND50V2G
Test Standard:	FCC 47 CFR Part 15: Subpart B

Any reproduction of this document must be done in full. No single part of this document may be reproduced without permission from STS, All Test Data Presented in this report is only applicable to presented Test sample.





TEST RESULT CERTIFICATION

Applicant's Name: BTECH (BaoFeng Tech)
Address: 702 N Industrial Ave Arlington South Dakota United States 57212
Manufacture's Name: BTECH (BaoFeng Tech)
Address: 702 N Industrial Ave Arlington South Dakota United States 57212

Product Description:
Product Name.....: GMRS mobile radio
Brand.....: BTECH
Model Number.....: GMRS-50V2
Series Model(s): N/A
Standards.....: FCC 47 CFR Part 15: Subpart B
Test Procedure.....: ANSI C63.4-2014

This device described above has been tested by STS, and the test results show that the equipment under test (EUT) is in compliance with the FCC requirements. And it is applicable only to the tested sample identified in the report.

This report shall not be reproduced except in full, without the written approval of STS, this document may be altered or revised by STS, personal only, and shall be noted in the revision of the document.

Date of Test:
Date of Receipt of Test Item.....: 31 May 2022
Date of Performance of Tests.....: 31 May 2022~21 Oct. 2022
Date of Issue: 21 Oct. 2022
Test Result.....: Pass

Testing Engineer : Jane Chen
(Jane Chen)

Technical Manager : Bulun
(Bulun)

Authorized Signatory : Bovey Yang
(Bovey Yang)





Table of Contents

1. SUMMARY OF THE TEST RESULTS	5
1.1 TEST FACTORY	5
1.2 MEASUREMENT UNCERTAINTY	5
2. GENERAL INFORMATION	6
2.1 GENERAL DESCRIPTION OF THE EUT	6
2.2 DESCRIPTION OF THE TEST MODES	7
2.3 DESCRIPTION OF THE TEST SETUP	8
2.4 EQUIPMENTS LIST FOR ALL TEST ITEMS	9
3. EMC EMISSION TEST	10
3.1 CONDUCTED EMISSION MEASUREMENT	10
3.2 RADIATED EMISSION MEASUREMENT	14
4. ANTENNA CONDUCTED POWER FOR RECEIVERS	21
4.1 LIMIT	21
4.2 TEST PROCEDURE	21
4.3 TEST SETUP	21
4.4 TEST RESULTS	22
5. SCANNING RECEIVERS AND FREQUENCY CONVERTERS USED WITH SCANNING RECEIVERS	24
5.1 LIMIT	24
5.2 TEST PROCEDURE	24
5.3 TEST SETUP	24
5.4 TEST RESULTS	24



Revision History

Rev.	Issue Date	Report No.	Effect Page	Contents
00	21 Oct. 2022	STS2205214E02	ALL	Initial Issue





1. SUMMARY OF THE TEST RESULTS

Test procedures according to the technical standards:

EMISSION			
Standard	Item	Result	Remarks
Part 15.107	Conducted Emission	PASS	N/A
Part 15.109	Radiated Emission	PASS	N/A
Part 15.111	Antenna Conducted Power for receivers	PASS	N/A
Part 15.121(b)	Scanning receivers and frequency converters used with scanning receivers	PASS	N/A

NOTE:

(1) N/A=Not Applicable.

1.1 TEST FACTORY

Company Name:	SHENZHEN STS TEST SERVICES CO.,LTD.
Address:	A 1/F, Building B, Zhuoke Science Park, No.190 Chongqing Road, HepingShequ, Fuyong Sub-District, Bao'an District, Shenzhen, Guang Dong, China
Telephone:	+86-755 3688 6288
Fax:	+86-755 3688 6277
Registration No.:	FCC test Firm Registration Number: 625569
	IC test Firm Registration Number: 12108A
	A2LA Certificate No.: 4338.01

1.2 MEASUREMENT UNCERTAINTY

The reported uncertainty of measurement $y \pm U$, where expanded uncertainty U is based on a standard uncertainty multiplied by a coverage factor of $k=2$, providing a level of confidence of approximately 95 %.

No.	Item	Uncertainty
1	Conducted Emission (9KHz-30MHz)	$\pm 2.73\text{dB}$
2	All emissions,radiated(<1G) 30MHz-1000MHz	$\pm 4.09\text{dB}$
3	All emissions,radiated(>1G) 1GHz-6GHz	$\pm 4.92\text{dB}$
4	All emissions,radiated(>1G) 6GHz-18GHz	$\pm 5.49\text{dB}$



2. GENERAL INFORMATION

2.1 GENERAL DESCRIPTION OF THE EUT

Product Name	GMRS mobile radio
Brand	BTECH
Model Number	GMRS-50V2
Series Model(s)	N/A
Model Difference	N/A
Product Description	The EUT is a GMRS mobile radio ITE equipment having a primary function of either (or a combination of) entry, storage, display, retrieval, transmission, processing, switching, or control of data and/or telecommunication messages and which may be equipped with one or more ports typically for information transfer.
Frequency Bands	Scanning Receiver : 65-108(VHF)/136-174(VHF)/400-520MHz(UHF)
Modulation Mode	F3E
Rating	Input: DC 13.8V
Hardware Version Number	V1.5
Software Version Number	VW2205

Note: For a more detailed features description, please refer to the manufacturer's specifications or the User's Manual.



2.2 DESCRIPTION OF THE TEST MODES

To investigate the maximum EMI emission characteristics generates from EUT, the test system was pre-scanning tested base on the consideration of following EUT operation mode or test configuration mode which possibly have effect on EMI emission level. Each of these EUT operation mode(s) or test configuration mode(s) mentioned above was evaluated respectively.

Pretest Mode	Description
Mode 1	Scanning mode
Mode 2	Scanning stopped/Receiving at low channel of 136 MHz -174 MHz
Mode 3	Scanning stopped/Receiving at middle channel of 136 MHz -174 MHz
Mode 4	Scanning stopped/Receiving at high channel of 136 MHz -174 MHz
Mode 5	Scanning stopped/Receiving at low channel of 400 MHz -520 MHz
Mode 6	Scanning stopped/Receiving at middle channel of 400 MHz -520 MHz
Mode 7	Scanning stopped/Receiving at high channel of 400 MHz -520 MHz

For Conducted Test	
Final Test Mode	Description
Mode 1	Scanning mode

For Radiated Test	
Final Test Mode	Description
Mode 1	Scanning mode

Note:

1. For conducted emission test, test mode 1 was the worst case and only this mode was presented in this report.
2. For radiated emission test, test mode 1 was the worst case and only this mode was presented in this report.
3. We have be tested for all avaiable U.S. voltage and frequencies (For 120V, 50/60Hz) for which the device is capable of operation.



2.3 DESCRIPTION OF THE TEST SETUP

The EUT has been tested with associated equipment below and the test setup please refer to appendix 1 - test setup.

Necessary accessories

Item	Equipment	Mfr/Brand	Model/Type No.	Length	Note
/	DC Cable	N/A	N/A	210cm	NO

Support units

Item	Equipment	Mfr/Brand	Model/Type No.	Length	Note
/	DC Supply	HAOXIN	RXN-605D	N/A	N/A

Note:

- (1) For detachable type I/O cable should be specified the length in cm in 『Length』 column.
- (2) “YES” is means “with core”; “NO” is means “without core”.



2.4 EQUIPMENTS LIST FOR ALL TEST ITEMS

The EUT has been tested as an independent unit together with other necessary accessories or support units. The following support units or accessories were used to form a representative test configuration during the tests.

Radiation Test equipment

Kind of Equipment	Manufacturer	Type No.	Serial No.	Last Calibration	Calibrated Until
EMI Test Receiver	R&S	ESCI	101427	2022.09.29	2023.09.28
Bi-log Antenna	TESEQ	CBL6111D	45873	2021.10.08	2023.10.07
Horn Antenna	SCHWARZBECK	BBHA 9120D	1343	2022.09.28	2023.09.27
Pre-amplifier(1-26.5G)	Agilent	8449B	3008A02383	2022.07.04	2023.07.03
Pre-amplifier(0.1M-3GHz)	EM	EM330	060665	2022.07.04	2023.07.03
Spectrum Analyzer	Agilent	N9020A	MY49100060	2022.09.28	2023.09.27
RE Cable (9K-1G)	N/A	R01	N/A	2022.09.28	2023.09.27
RE Cable (1-26G)	N/A	R02	N/A	2022.09.28	2023.09.27
Temperature & Humidity	Mieo	HH660	N/A	2022.09.28	2023.09.27
Horn Antenna(18-40G)	A-INFO	LB-180400-K F	J211020657	2022.09.30	2023.09.29
Testing Software	EZ-EMC(Ver.STSLAB-03A1 RE)				

Conduction Test equipment

Kind of Equipment	Manufacturer	Type No.	Serial No.	Last Calibration	Calibrated Until
EMI Test Receiver	R&S	ESCI	101427	2022.09.28	2023.09.27
LISN	R&S	ENV216	101242	2022.09.28	2023.09.27
LISN	ETS	3810/2NM	00023625	2022.09.28	2023.09.27
Absorbing Clamp	R&S	MDS-21	100668	2022.03.02	2023.03.01
CE Cable	N/A	C01	N/A	2022.09.28	2023.09.27
Temperature & Humidity	Mieo	HH660	N/A	2022.09.30	2023.09.29
Testing Software	EZ-EMC(Ver.STSLAB-03A1 CE)				



3. EMC EMISSION TEST

3.1 CONDUCTED EMISSION MEASUREMENT

3.1.1 POWER LINE CONDUCTED EMISSION LIMITS

FREQUENCY (MHz)	<input type="checkbox"/> Class A (dB μ V)		<input checked="" type="checkbox"/> Class B (dB μ V)	
	Quasi-peak	Average	Quasi-peak	Average
0.15 ~ 0.5	79.00	66.00	66 - 56 *	56 - 46 *
0.5 ~ 5	73.00	60.00	56.00	46.00
5 ~ 30	73.00	60.00	60.00	50.00

Note:

- (1) The tighter limit applies at the band edges.
- (2) The limit of " * " marked band means the limitation decreases linearly with the logarithm of the frequency in the range.

The following table is the setting of the receiver

Receiver Parameters	Setting
Attenuation	10 dB
Start Frequency	0.15 MHz
Stop Frequency	30 MHz
IF Bandwidth	9 kHz

3.1.2 TEST PROCEDURE

- The EUT was placed 0.4 meters from the conducting wall of the shielded room with EUT being connected to the power mains through a line impedance stabilization network (LISN). Other support units were connected to the power mains through another LISN. The two LISNs provide 50 Ohm/ 50uH of coupling impedance for the measuring instrument.
- Interconnecting cables that hang closer than 40 cm to the ground plane shall be folded back and forth in the center forming a bundle 30 to 40 cm long.
- I/O cables that are not connected to a peripheral shall be bundled in the center. The end of the cable may be terminated, if required, using the correct terminating impedance. The overall length shall not exceed 1 m.
- For the actual test configuration, please refer to the related Item –EUT Test Photos.

3.1.3 DEVIATION FROM TEST STANDARD

No deviation

3.1.4 TEST SETUP

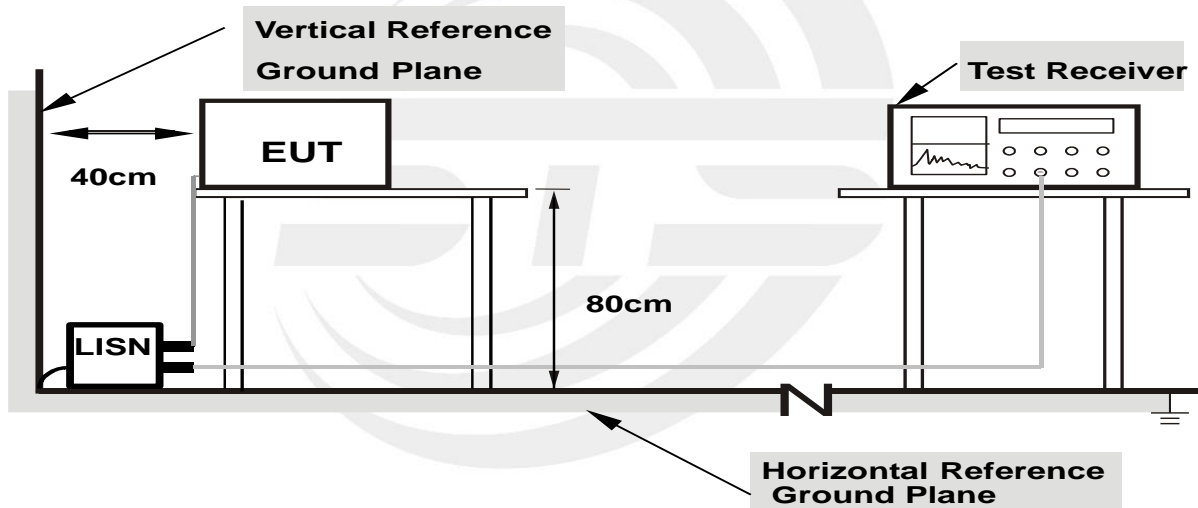

Note: 1.Support units were connected to second LISN.

2.Both of LISNs (AMN) are 80 cm from EUT and at least 80 from other units and other metal planes

3.1.5 EUT OPERATING CONDITIONS

The EUT was configured for testing in a typical fashion (as a customer would normally use it). The EUT has been programmed to continuously transmit during test. This operating condition was tested and used to collect the included data.



3.1.6 TEST RESULTS

Temperature:	25.4°C	Relative Humidity:	51%
Phase:	L	Test Mode:	Mode 1
Test Voltage:	AC 120V/60Hz	Test Date:	2022.06.02

No.	Frequency (MHz)	Reading (dBuV)	Correct Factor (dB)	Result (dBuV)	Limit (dBuV)	Margin (dB)	Detector
1	0.3100	8.40	20.73	29.13	59.97	-30.84	QP
2	0.3100	-2.97	20.73	17.76	49.97	-32.21	AVG
3	0.6580	7.16	20.39	27.55	56.00	-28.45	QP
4	0.6580	-3.28	20.39	17.11	46.00	-28.89	AVG
5	1.9940	7.28	20.30	27.58	56.00	-28.42	QP
6	1.9940	-3.14	20.30	17.16	46.00	-28.84	AVG
7	4.7660	6.77	20.45	27.22	56.00	-28.78	QP
8	4.7660	-3.93	20.45	16.52	46.00	-29.48	AVG
9	8.6820	8.31	20.92	29.23	60.00	-30.77	QP
10	8.6820	-3.39	20.92	17.53	50.00	-32.47	AVG
11	22.5940	7.11	22.75	29.86	60.00	-30.14	QP
12	22.5940	-3.83	22.75	18.92	50.00	-31.08	AVG

Remark:

1. All readings are Quasi-Peak and Average values
2. Margin = Result (Result = Reading + Factor) – Limit
3. Factor = Insertion loss + Cable loss

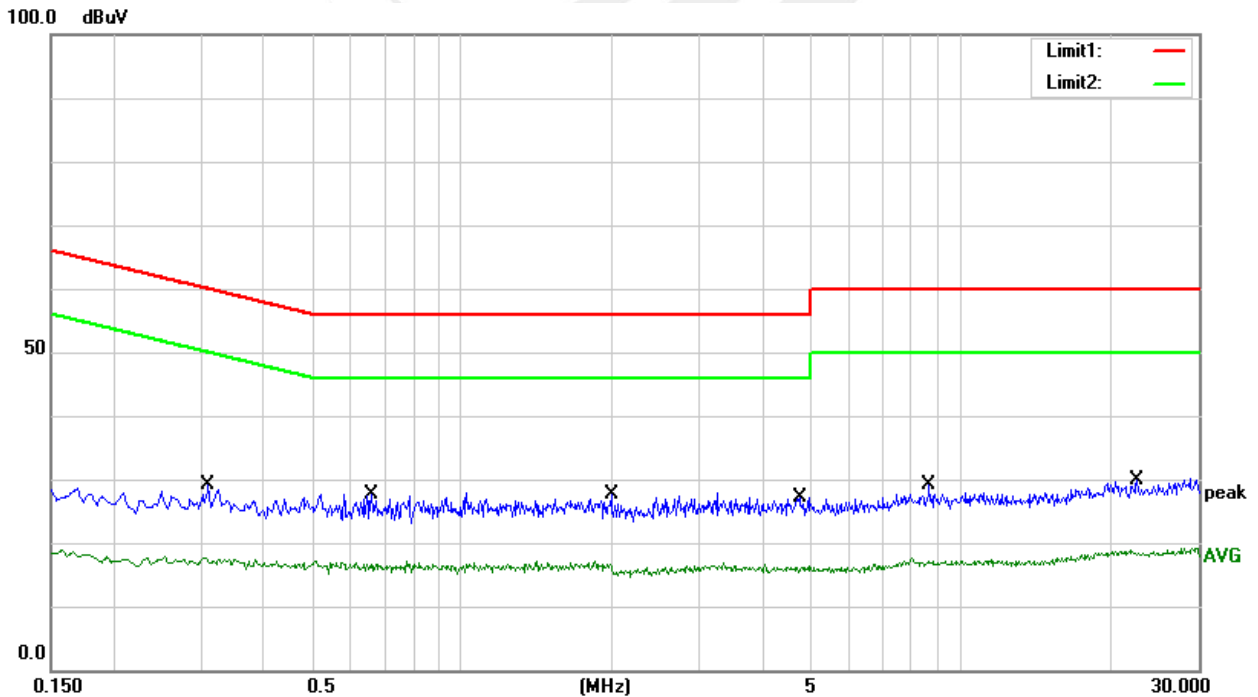



Temperature:	25.4°C	Relative Humidity:	51%
Phase:	N	Test Mode:	Mode 1
Test Voltage:	AC 120V/60Hz	Test Date:	2022.06.02

No.	Frequency (MHz)	Reading (dBuV)	Correct Factor (dB)	Result (dBuV)	Limit (dBuV)	Margin (dB)	Detector
1	0.1580	10.72	20.33	31.05	65.57	-34.52	QP
2	0.1580	-1.62	20.33	18.71	55.57	-36.86	AVG
3	0.5660	6.94	20.48	27.42	56.00	-28.58	QP
4	0.5660	-3.54	20.48	16.94	46.00	-29.06	AVG
5	1.5660	7.93	20.30	28.23	56.00	-27.77	QP
6	1.5660	-2.97	20.30	17.33	46.00	-28.67	AVG
7	3.3420	6.72	20.37	27.09	56.00	-28.91	QP
8	3.3420	-3.71	20.37	16.66	46.00	-29.34	AVG
9	9.1700	8.04	21.02	29.06	60.00	-30.94	QP
10	9.1700	-3.76	21.02	17.26	50.00	-32.74	AVG
11	22.0340	7.37	22.78	30.15	60.00	-29.85	QP
12	22.0340	-3.91	22.78	18.87	50.00	-31.13	AVG

Remark:

1. All readings are Quasi-Peak and Average values
2. Margin = Result (Result = Reading + Factor)–Limit
3. Factor = Insertion loss + Cable loss

100.0 dBuV

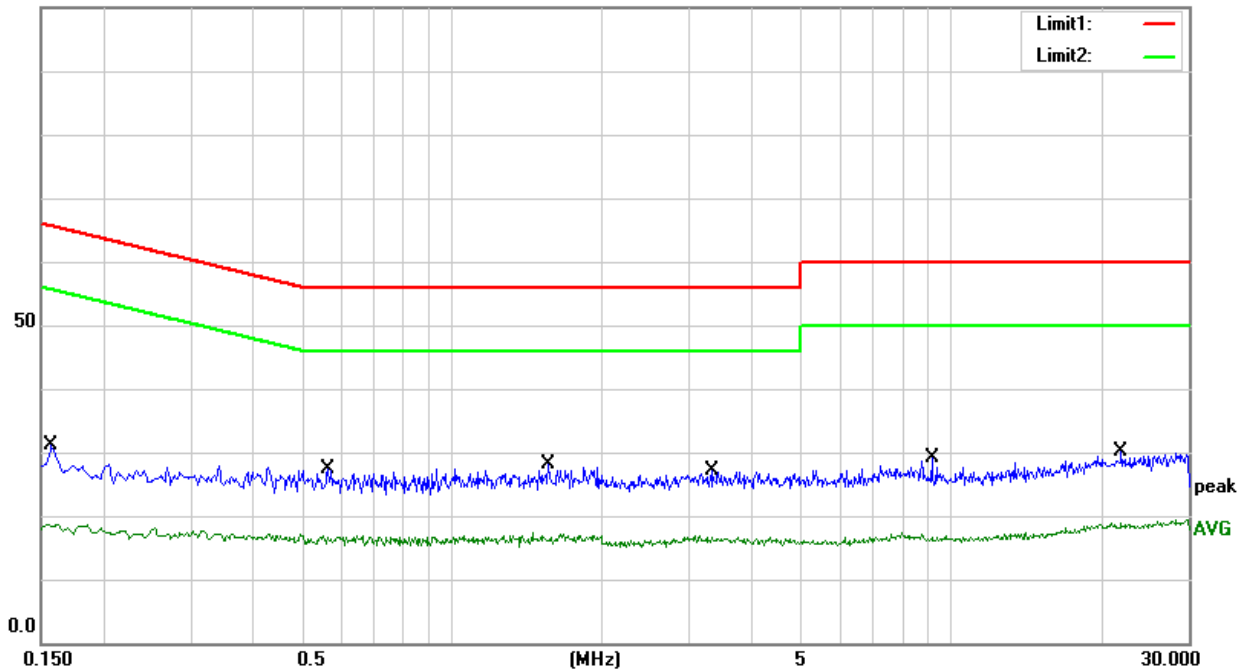



3.2 RADIATED EMISSION MEASUREMENT

3.2.1 RADIATED EMISSION LIMITS

Below 1 GHz

Measurement Method and Applied Limits:

ANSI C63.4:

Frequency (MHz)	<input type="checkbox"/> Class A		<input checked="" type="checkbox"/> Class B
	Field strength (dBuV/m) (at 10m)	Field strength (dBuV/m) (at 3m)	Field strength (dBuV/m) (at 3m)
30 ~ 88	39	49.5	40
88 ~ 216	43.5	54	43.5
216 ~ 960	46.4	56.9	46
Above 960	49.5	60	54

Above 1 GHz

Measurement Method and Applied Limits:

ANSI C63.4:

Frequency (MHz)	<input type="checkbox"/> Class A				<input checked="" type="checkbox"/> Class B	
	(dBuV/m) (at 3m)		(dBuV/m) (at 10m)		(dBuV/m) (at 3m)	
	Peak	Average	Peak	Average	Peak	Average
Above 1000	80	60	69.5	49.5	74	54

Frequency Range of Radiated Disturbance Measurement

Highest frequency generated or Upper frequency of measurement used in the device or on which the device operates or tunes (MHz)	Range (MHz)
Below 1.705	30
1.705 ~ 108	1000
108 ~ 500	2000
500 ~ 1000	5000
Above 1000	5th harmonic of the highest frequency or 40 GHz, whichever is lower

Note:

- (1) The limit for radiated test was performed in the following: FCC PART 15B.
- (2) The tighter limit applies at the band edges.
- (3) Emission level (dBuV/m) = 20log Emission level (uV/m).



3.2.2 TEST PROCEDURE

- a. The EUT was placed on the top of a rotating table 0.8 meter above the ground at a 3 meter semi-anechoic chamber room. The table was rotated 360 degrees to determine the position of the highest radiation.
- b. EUT as the center to the edge of the auxiliary device, the distance from the maximum edge to the center of the antenna is 3 meter.
- c. The height of antenna is varied from 1 meter to 4 meter above the ground to determine the maximum value of the field strength. Both horizontal and vertical polarizations of the antenna are set to make the measurement.
- d. For each suspected emission, the EUT was arranged to its worst case and then the antenna was tuned to heights from 1 meter to 4 meter and the rotatable table was turned from 0 degrees to 360 degree to find the maximum reading.
- e. The test-receiver system was set to quasi-peak detect function and specified bandwidth with maximum hold mode when the test frequency is below 1GHz.
- f. For the actual test configuration, please refer to the related Item –EUT Test Photos.

Note: Both horizontal and vertical antenna polarities were tested and performed pretest to three orthogonal axis. The worst case emissions were reported

3.2.3 DEVIATION FROM TEST STANDARD

No deviation

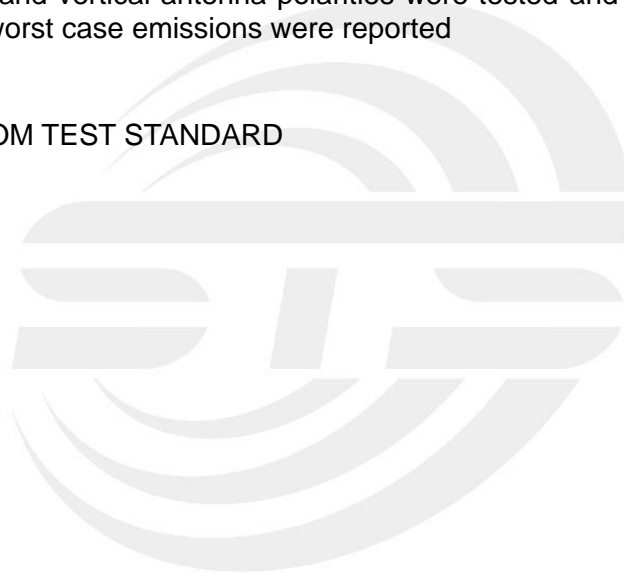

3.2.4 TEST SETUP

(A) Radiated Emission Test-Up Frequency Below 1 GHz

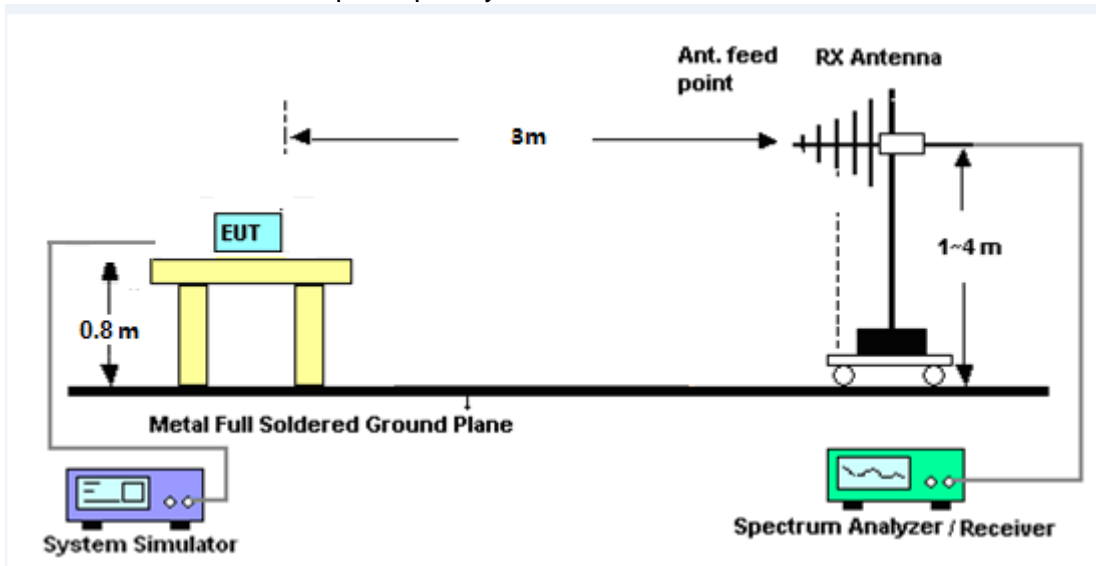

(B) Radiated Emission Test-Up Frequency Above 1GHz

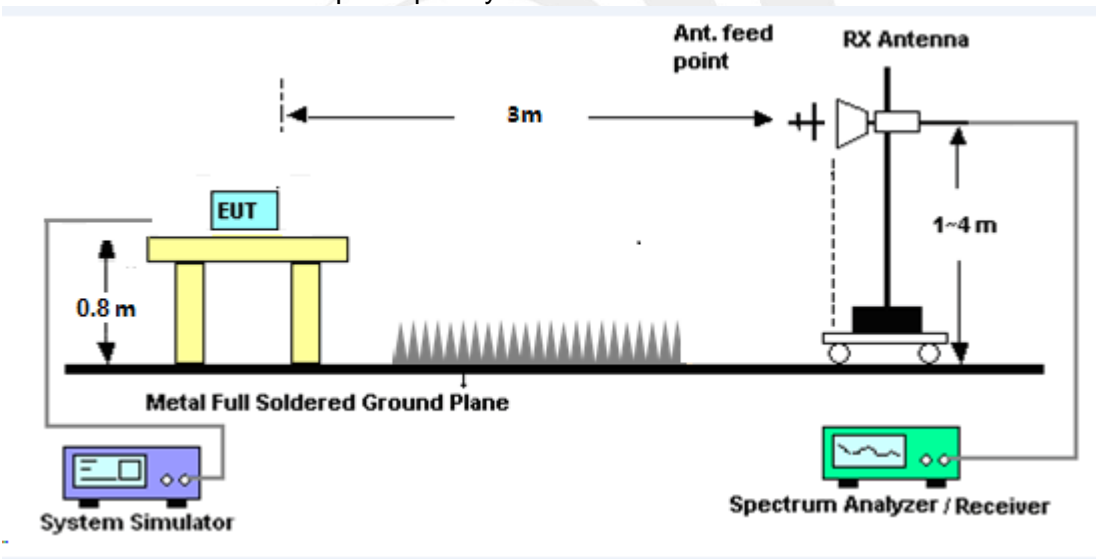

3.2.5 EUT OPERATING CONDITIONS

The EUT tested system was configured as the statements of 2.4 described unless otherwise a special operating condition is specified in the following during the testing.



3.2.6 TEST RESULTS

30MHz - 1000MHz

Temperature:	24.9°C	Relative Humidity:	57%
Phase:	Horizontal	Test Mode:	Mode 1
Test Voltage:	DC 13.8V	Test Date:	2022.06.02

No.	Frequency (MHz)	Reading (dBuV)	Correct Factor (dB)	Results (dBuV/m)	Limit (dBuV/m)	Margin (dB)	Detector
1	30.6380	27.20	-11.39	15.81	40.00	-24.19	QP
2	147.4036	29.13	-18.25	10.88	43.50	-32.62	QP
3	313.2760	34.30	-15.24	19.06	46.00	-26.94	QP
4	568.6127	28.76	-8.27	20.49	46.00	-25.51	QP
5	755.3873	29.11	-5.25	23.86	46.00	-22.14	QP
6	925.7563	29.26	-2.63	26.63	46.00	-19.37	QP

Remark:

1. All readings are Quasi-Peak
2. Margin = Result (Result = Reading + Factor) – Limit
3. Factor = Cable Loss + Antenna Factor - Amplifier Gain

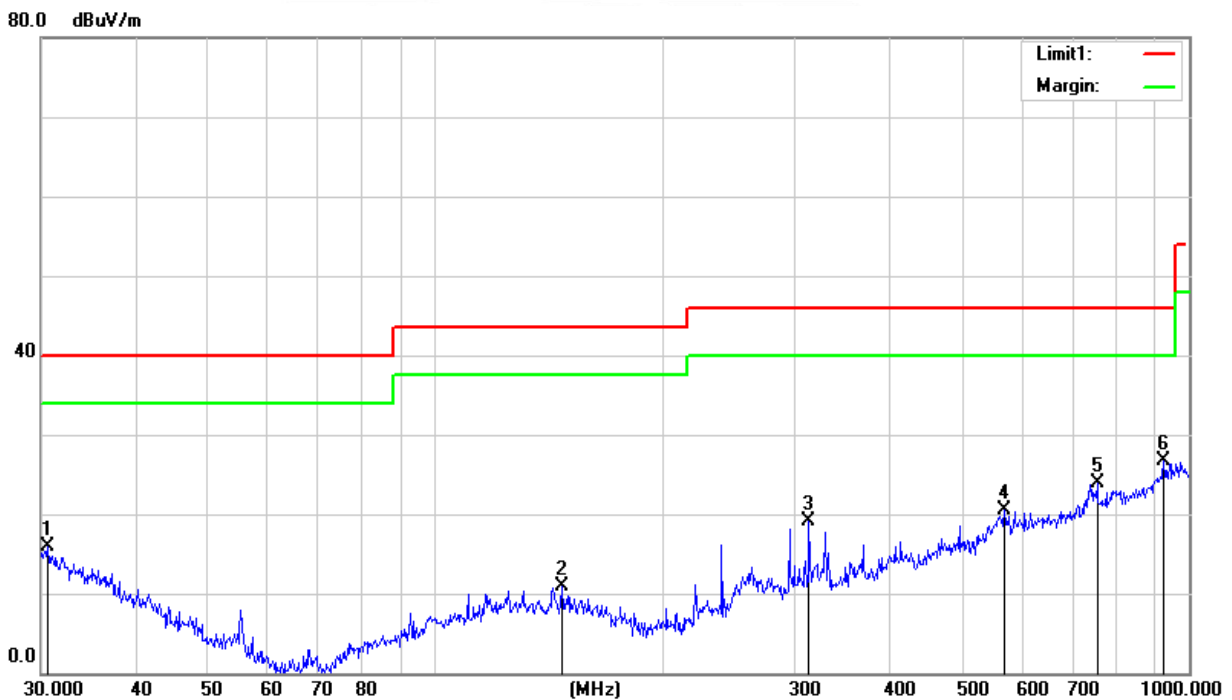



Temperature:	24.9°C	Relative Humidity:	57%
Phase:	Vertical	Test Mode:	Mode 1
Test Voltage:	DC 13.8V	Test Date:	2022.06.02

No.	Frequency (MHz)	Reading (dBuV)	Correct Factor (dB)	Results (dBuV/m)	Limit (dBuV/m)	Margin (dB)	Detector
1	30.2111	27.45	-11.15	16.30	40.00	-23.70	QP
2	55.2207	39.68	-23.87	15.81	40.00	-24.19	QP
3	161.4742	35.10	-18.85	16.25	43.50	-27.25	QP
4	298.2681	33.75	-16.33	17.42	46.00	-28.58	QP
5	739.6604	28.08	-4.37	23.71	46.00	-22.29	QP
6	972.3374	28.27	-2.03	26.24	54.00	-27.76	QP

Remark:

1. All readings are Quasi-Peak
2. Margin = Result (Result = Reading + Factor) – Limit
3. Factor = Cable Loss + Antenna Factor - Amplifier Gain

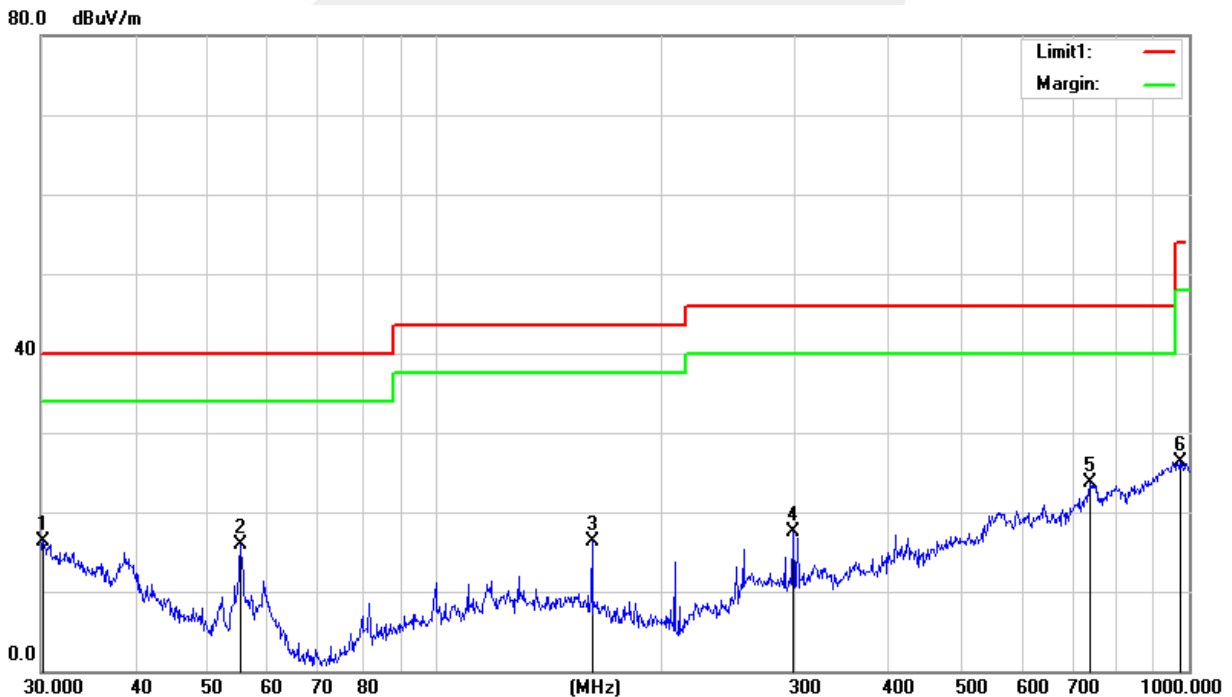



(1 GHz - 18GHz)

Temperature:	24.9°C	Relative Humidity:	57%
Phase:	Horizontal	Test Mode:	Mode 1
Test Voltage:	DC 13.8V	Test Date:	2022.06.02

No.	Frequency (MHz)	Reading (dBuV)	Correct Factor (dB)	Result (dBuV)	Limit (dBuV)	Margin (dB)	Remark
1	4026.000	41.73	4.40	46.13	74.00	-27.87	Peak
2	4026.000	34.12	4.40	38.52	54.00	-15.48	AVG
3	8225.000	36.28	11.38	47.66	74.00	-26.34	Peak
4	8225.000	28.27	11.38	39.65	54.00	-14.35	AVG
5	9627.500	34.65	13.44	48.09	74.00	-25.91	Peak
6	9627.500	25.99	13.44	39.43	54.00	-14.57	AVG
7	12381.500	34.09	15.36	49.45	74.00	-24.55	Peak
8	12381.500	25.63	15.36	40.99	54.00	-13.01	AVG
9	14574.500	33.48	18.16	51.64	74.00	-22.36	Peak
10	14574.500	25.08	18.16	43.24	54.00	-10.76	AVG
11	17957.500	30.70	24.31	55.01	74.00	-18.99	Peak
12	17957.500	22.17	24.31	46.48	54.00	-7.52	AVG

Remark:

1. All readings are Peak and Average values
2. Margin = Result (Result = Reading + Factor) - Limit
3. Factor = Cable Loss + Antenna Factor - Amplifier Gain

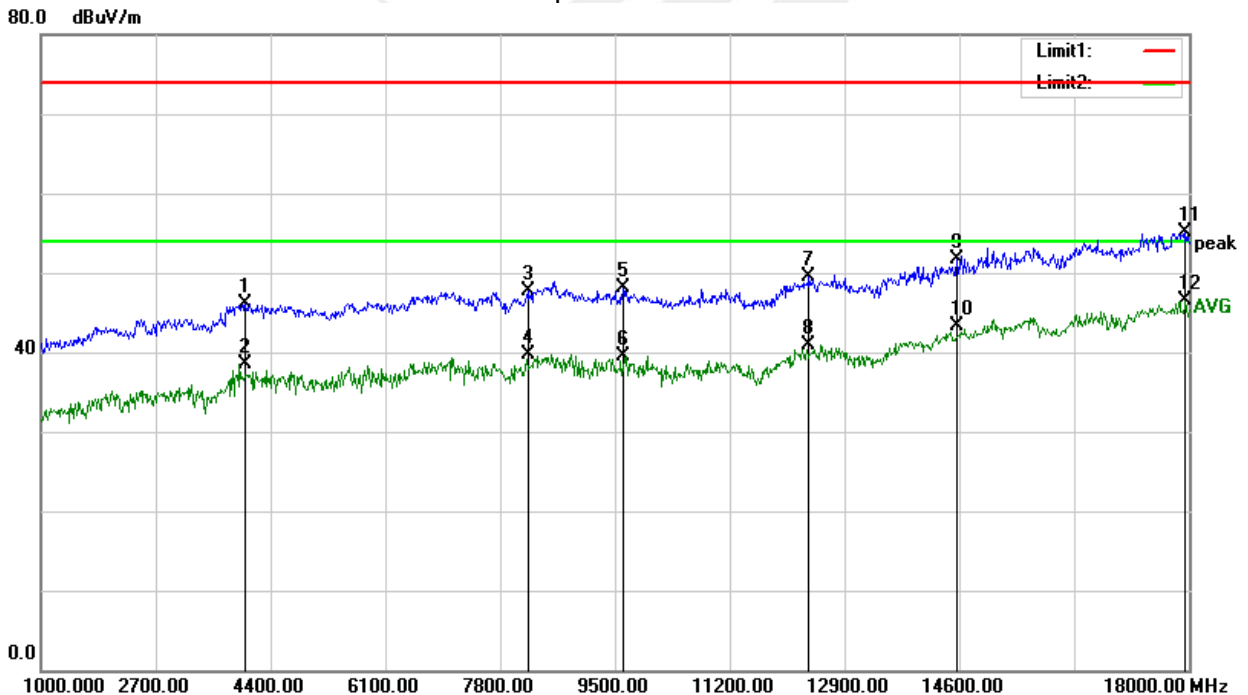



Temperature:	24.9°C	Relative Humidity:	57%
Phase:	Vertical	Test Mode:	Mode 1
Test Voltage:	DC 13.8V	Test Date:	2022.06.02

No.	Frequency (MHz)	Reading (dBuV)	Correct Factor (dB)	Result (dBuV)	Limit (dBuV)	Margin (dB)	Remark
1	3779.500	41.30	3.79	45.09	74.00	-28.91	Peak
2	3779.500	32.99	3.79	36.78	54.00	-17.22	AVG
3	7783.000	37.64	11.11	48.75	74.00	-25.25	Peak
4	7783.000	28.00	11.11	39.11	54.00	-14.89	AVG
5	9321.500	35.17	13.91	49.08	74.00	-24.92	Peak
6	9321.500	25.66	13.91	39.57	54.00	-14.43	AVG
7	13631.000	34.44	16.04	50.48	74.00	-23.52	Peak
8	13631.000	25.22	16.04	41.26	54.00	-12.74	AVG
9	15339.500	34.11	17.48	51.59	74.00	-22.41	Peak
10	15339.500	25.04	17.48	42.52	54.00	-11.48	AVG
11	17753.500	30.72	23.68	54.40	74.00	-19.60	Peak
12	17753.500	21.71	23.68	45.39	54.00	-8.61	AVG

Remark:

1. All readings are Peak and Average values
2. Margin = Result (Result = Reading + Factor) – Limit
3. Factor = Cable Loss + Antenna Factor - Amplifier Gain

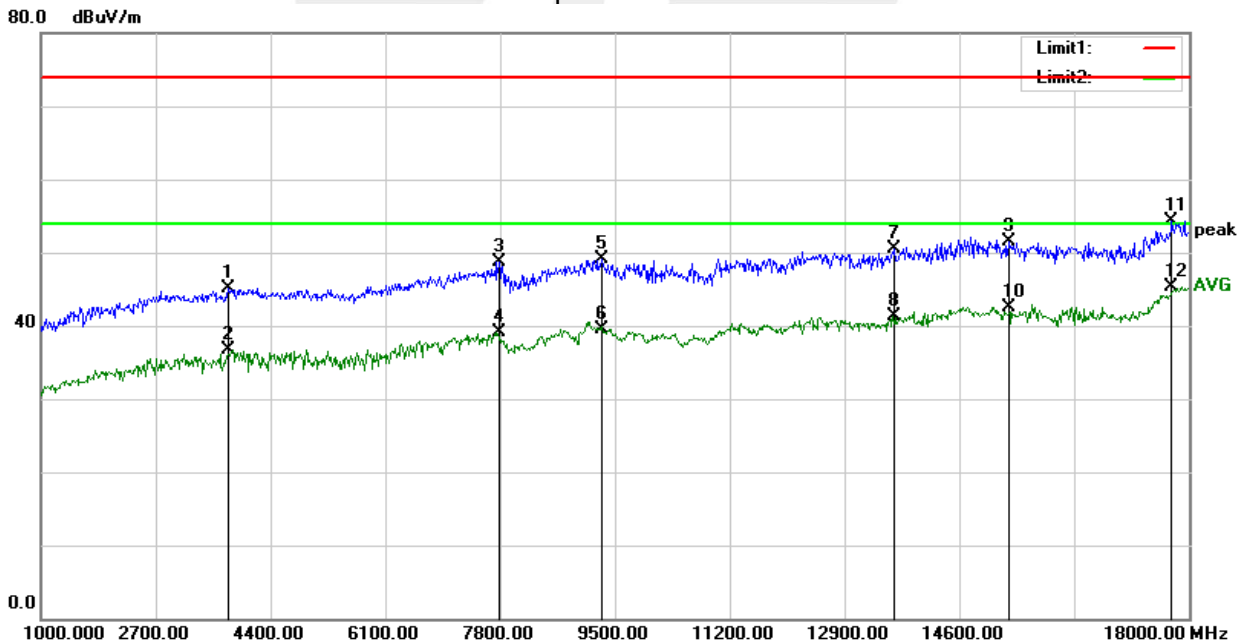

Notes:

1. Measuring frequencies from 1 GHz to 18GHz.
2. Radiated emissions measured in frequency above 1000MHz were made with an instrument using peak and average detector mode of the emission shown in Actual FS column.
3. The frequency emission of 18-25GHz is at least 20dB lower than the limit, and the frequency emission mainly comes from environmental noise.

4. ANTENNA CONDUCTED power FOR RECEIVERS

4.1 LIMIT

The antenna conducted power of the receiver as defined in part 15.111 shall not exceed the values given in the following tables

Frequency Range	Limit
9 kHz to 5 GHz	2.0nW(-57 dBm)

4.2 TEST PROCEDURE

1. The receiver antenna terminal connected to a spectrum analyzer.
2. The test data of the worst case condition (mode 1) was reported on the following Data page.

4.3 TEST SETUP

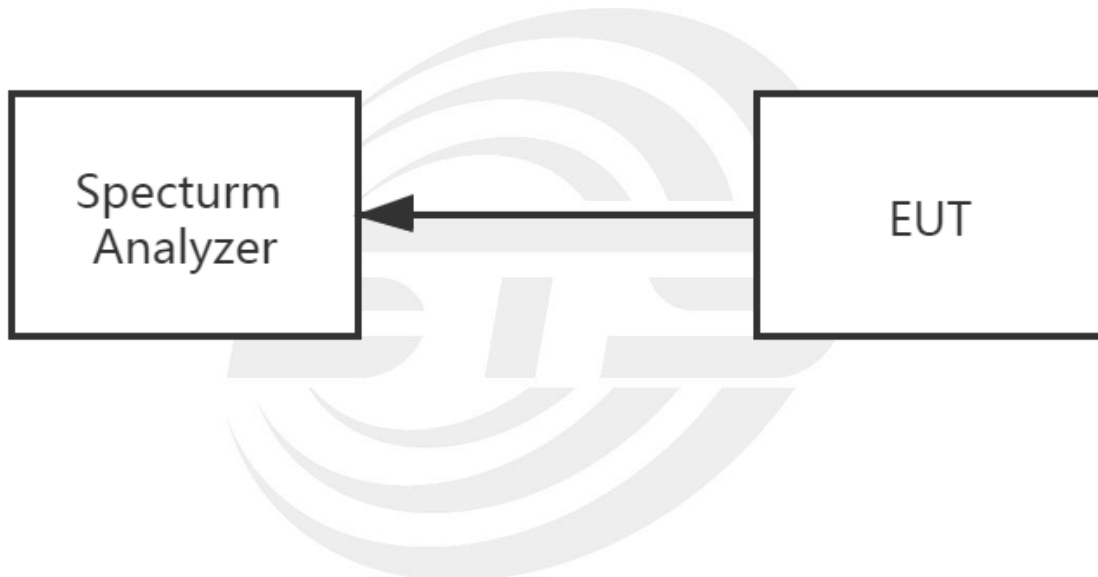



4.4 TEST RESULTS

Conducted Measurement 9KHz-150KHz

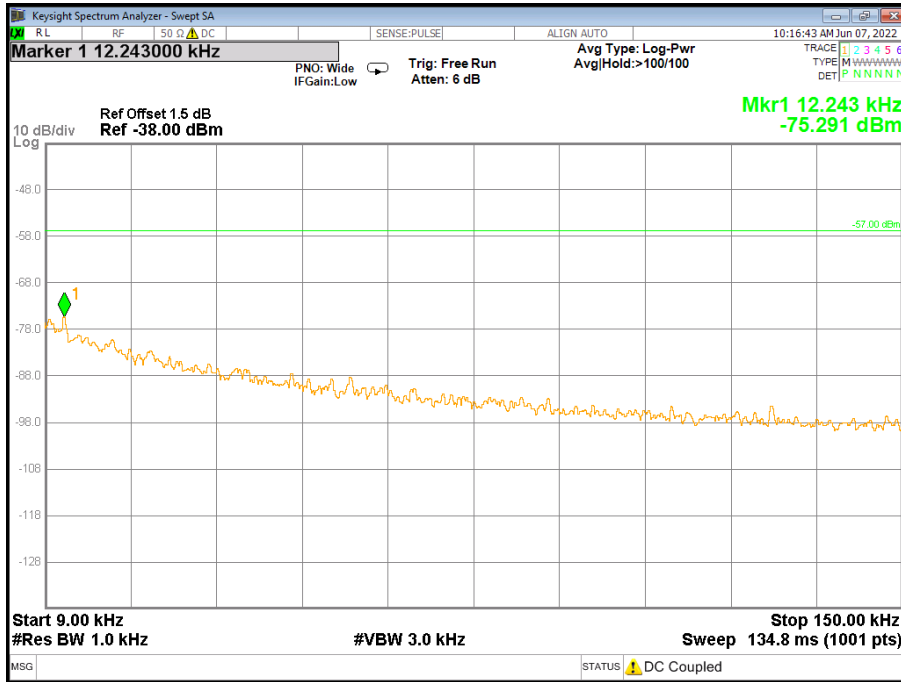

Conducted Measurement 150KHz-30MHz

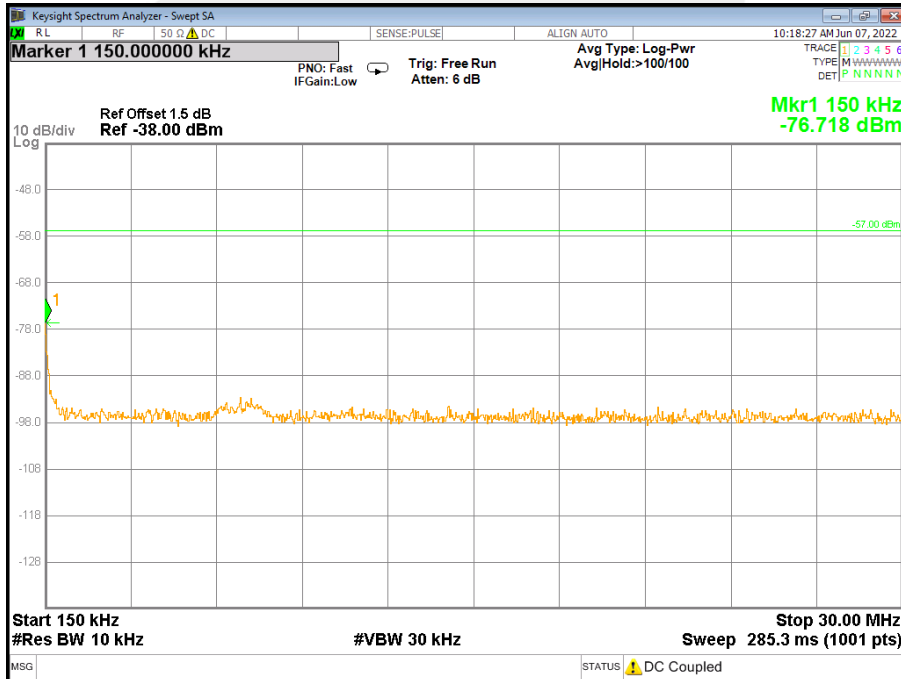



Conducted Measurement 30MHz-1G

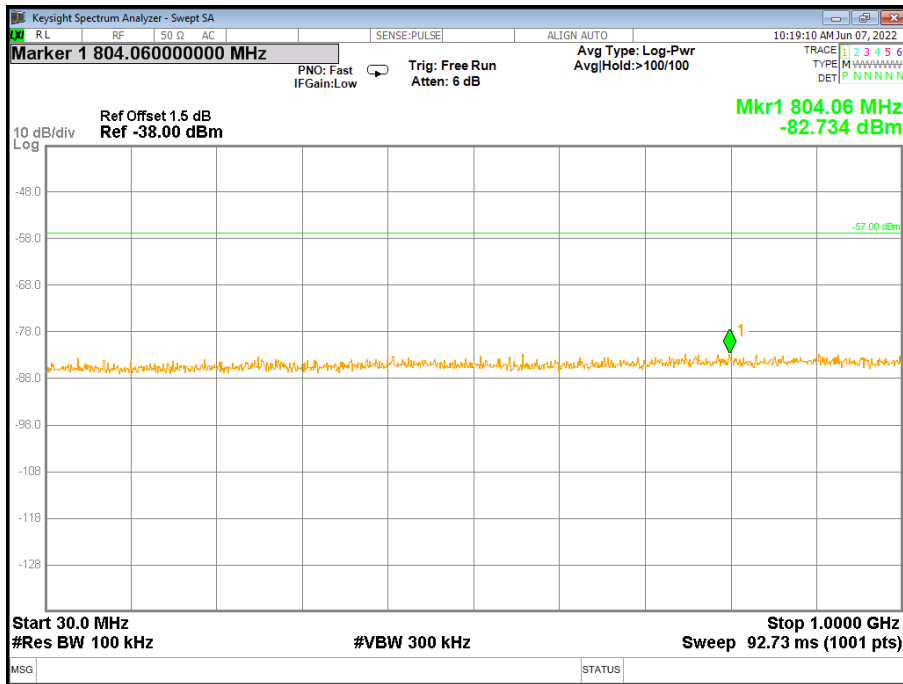

Conducted Measurement 1GHz-5GHz

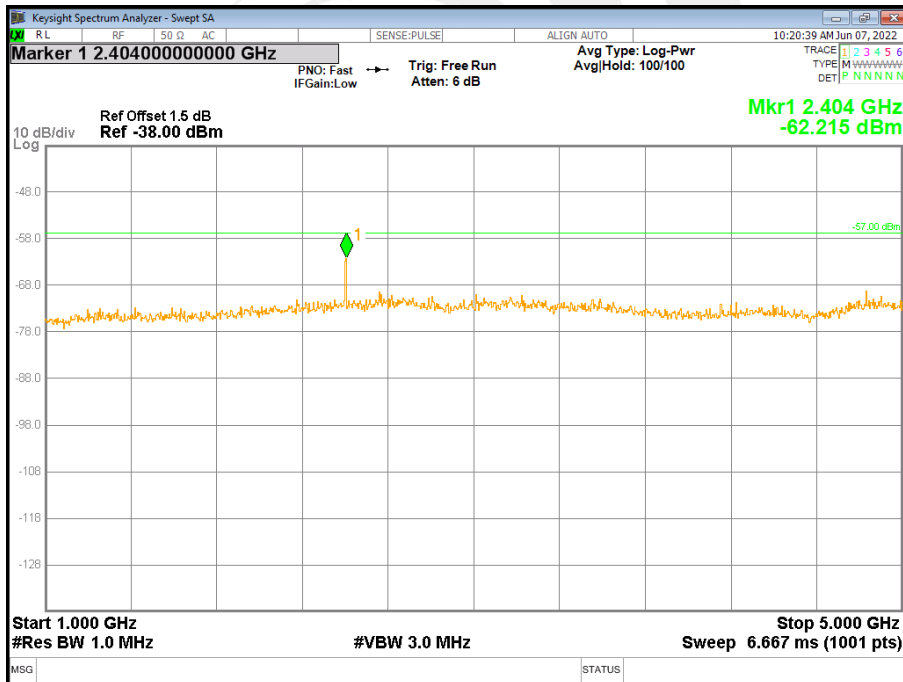

5. SCANNING RECEIVERS AND FREQUENCY CONVERTERS USED WITH SCANNING RECEIVERS

5.1 LIMIT

Except as provided in paragraph (c) of this section, scanning receivers shall reject any signals from the Cellular Radiotelephone Service frequency bands that are 38 dB or lower based upon a 12 dB SINAD measurement, which is considered the threshold where a signal can be clearly discerned from any interference that may be present.

5.2 TEST PROCEDURE

Please review the FCC Part 15.121(b) section requirement to meet the test process

5.3 TEST SETUP

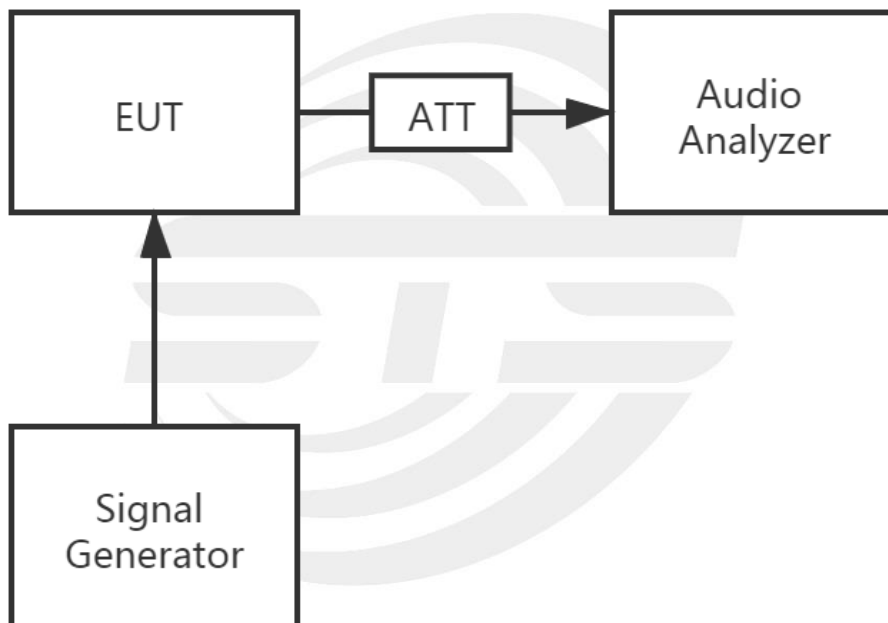

5.4 TEST RESULTS

Frequency Range (MHz)	Channel	Measurement Result(dB)	Limit
65-108	Low/Middle/High	51	>38
136-174	Low/Middle/High	49	>38
400-520	Low/Middle/High	45	>38

END OF THE REPORT