

# Radio Test Report

Report No.:STS2312145W01

Issued for

BTECH ( Baofeng Tech )

702N industrial Ave Arlington, SD 57212, US

Product Name: Bluetooth Speaker Microphone

Brand Name: BTECH

Model Name: BS-22

Series Model(s): N/A

FCC ID: 2AGND-BS-22

Test Standards: FCC Part15.247

The test results presented in this report relate only to the object tested. This report shall not be reproduced, except in full, without the written approval of the Shenzhen STS Test Services Co., Ltd.



### TEST REPORT

**Applicant's Name**.....: BTECH ( Baofeng Tech )  
 Address .....: 702N industrial Ave Arlington, SD 57212, US  
**Manufacturer's Name** .....: BTECH ( Baofeng Tech )  
 Address .....: 702N industrial Ave Arlington, SD 57212, US

#### Product Description

Product Name.....: Bluetooth Speaker Microphone  
 Brand Name .....: BTECH  
 Model Name .....: BS-22  
 Series Model(s) .....: N/A

**Test Standards**.....: FCC Part15.247  
 Test Procedure .....: ANSI C63.10-2013

This device described above has been tested by STS, the test results show that the equipment under test (EUT) is in compliance with the FCC requirements. And it is applicable only to the tested sample identified in the report.

The test results presented in this report relate only to the object tested. This report shall not be reproduced, except in full, without the written approval of the Shenzhen STS Test Services Co., Ltd.

**Date of Test**.....:  
 Date of receipt of test item .....: 22 Dec. 2023  
 Date (s) of performance of tests .....: 22 Dec. 2023 ~ 09 Jan. 2024  
 Date of Issue.....: 09 Jan. 2024  
 Test Result.....: **Pass**

Testing Engineer : Aaron Bu  
 (Aaron Bu)

Technical Manager : Chris Chen  
 (Chris Chen)

Authorized Signatory : Bovey Yang  
 (Bovey Yang)





## Table of Contents

<b>1. SUMMARY OF TEST RESULTS</b>	<b>6</b>
1.1 TEST FACTORY	7
1.2 MEASUREMENT UNCERTAINTY	7
<b>2. GENERAL INFORMATION</b>	<b>8</b>
2.1 GENERAL DESCRIPTION OF THE EUT	8
2.2 DESCRIPTION OF THE TEST MODES	10
2.3 TEST SOFTWARE AND POWER LEVEL	10
2.4 BLOCK DIAGRAM SHOWING THE CONFIGURATION OF SYSTEM TESTED	11
2.5 DESCRIPTION OF NECESSARY ACCESSORIES AND SUPPORT UNITS	12
2.6 EQUIPMENTS LIST	13
<b>3. EMC EMISSION TEST</b>	<b>14</b>
3.1 CONDUCTED EMISSION MEASUREMENT	14
3.2 TEST PROCEDURE	15
3.3 TEST SETUP	15
3.4 EUT OPERATING CONDITIONS	15
3.5 TEST RESULTS	16
<b>4. RADIATED EMISSION MEASUREMENT</b>	<b>18</b>
4.1 RADIATED EMISSION LIMITS	18
4.2 TEST PROCEDURE	20
4.3 TEST SETUP	21
4.4 EUT OPERATING CONDITIONS	21
4.5 FIELD STRENGTH CALCULATION	22
4.6 TEST RESULTS	23
<b>5. CONDUCTED SPURIOUS &amp; BAND EDGE EMISSION</b>	<b>36</b>
5.1 LIMIT	36
5.2 TEST PROCEDURE	36
5.3 TEST SETUP	36
5.4 EUT OPERATION CONDITIONS	36
5.5 TEST RESULTS	36
<b>6. POWER SPECTRAL DENSITY TEST</b>	<b>37</b>
6.1 LIMIT	37
6.2 TEST PROCEDURE	37
6.3 TEST SETUP	37

**Table of Contents**

6.4 EUT OPERATION CONDITIONS	37
6.5 TEST RESULTS	37
<b>7. BANDWIDTH TEST</b>	<b>38</b>
7.1 LIMIT	38
7.2 TEST PROCEDURE	38
7.3 TEST SETUP	38
7.4 EUT OPERATION CONDITIONS	38
7.5 TEST RESULTS	38
<b>8. PEAK OUTPUT POWER TEST</b>	<b>39</b>
8.1 LIMIT	39
8.2 TEST PROCEDURE	39
8.3 TEST SETUP	40
8.4 EUT OPERATION CONDITIONS	40
8.5 TEST RESULTS	40
<b>9. ANTENNA REQUIREMENT</b>	<b>41</b>
9.1 STANDARD REQUIREMENT	41
9.2 EUT ANTENNA	41
<b>APPENDIX 1-TEST DATA</b>	<b>42</b>
<b>1. DUTY CYCLE</b>	<b>42</b>
<b>2. MAXIMUM AVERAGE CONDUCTED OUTPUT POWER</b>	<b>46</b>
<b>3. MAXIMUM PEAK CONDUCTED OUTPUT POWER</b>	<b>50</b>
<b>4. -6DB BANDWIDTH</b>	<b>54</b>
<b>5. MAXIMUM POWER SPECTRAL DENSITY LEVEL</b>	<b>58</b>
<b>6. BAND EDGE</b>	<b>62</b>
<b>7. CONDUCTED RF SPURIOUS EMISSION</b>	<b>67</b>
<b>APPENDIX 2- EUT TEST PHOTO</b>	<b>73</b>



**Revision History**

Rev.	Issue Date	Report No.	Effect Page	Contents
00	09 Jan. 2024	STS2312145W01	ALL	Initial Issue



## 1. SUMMARY OF TEST RESULTS

Test procedures according to the technical standards:  
KDB 558074 D01 15.247 Meas Guidance v05r02.

<b>FCC Part 15.247,Subpart C</b>			
Standard Section	Test Item	Judgment	Remark
15.207	Conducted Emission	PASS	--
15.247 (a)(2)	6dB Bandwidth	PASS	--
15.247 (b)(3)	Output Power	PASS	--
15.209	Radiated Spurious Emission	PASS	--
15.247 (d)	Conducted Spurious & Band Edge Emission	PASS	--
15.247 (e)	Power Spectral Density	PASS	--
15.205	Restricted bands of operation	PASS	--
Part 15.247(d)/ Part 15.209(a)	Band Edge Emission	PASS	--
15.203	Antenna Requirement	PASS	--

## NOTE:

- (1) 'N/A' denotes test is not applicable in this Test Report.
- (2) All tests are according to ANSI C63.10-2013.



### 1.1 TEST FACTORY

SHENZHEN STS TEST SERVICES CO., LTD

Add. : 101, Building B, Zhuoke Science Park, No.190 Chongqing Road, ZhanChengShequ, Fuhai Sub-District, Bao'an District, Shenzhen, Guang Dong, China

FCC test Firm Registration Number: 625569

IC test Firm Registration Number: 12108A

A2LA Certificate No.: 4338.01

### 1.2 MEASUREMENT UNCERTAINTY

The reported uncertainty of measurement  $y \pm U$ , where expanded uncertainty  $U$  is based on a standard uncertainty multiplied by a coverage factor of  $k=2$ , providing a level of confidence of approximately **95** %.

No.	Item	Uncertainty
1	RF output power, conducted	$\pm 0.755\text{dB}$
2	Unwanted Emissions, conducted	$\pm 2.874\text{dB}$
3	All emissions, radiated 9K-30MHz	$\pm 3.80\text{dB}$
4	All emissions, radiated 30M-1GHz	$\pm 4.18\text{dB}$
5	All emissions, radiated 1G-6GHz	$\pm 4.90\text{dB}$
6	All emissions, radiated >6G	$\pm 5.24\text{dB}$
7	Conducted Emission (9KHz-150KHz)	$\pm 2.19\text{dB}$
8	Conducted Emission (150KHz-30MHz)	$\pm 2.53\text{dB}$
9	Occupied Channel Bandwidth	$\pm 3.5\%$
10	Power Spectral Density, conducted	$\pm 1.245\text{dB}$
11	Duty Cycle	$\pm 3.2\%$

2. GENERAL INFORMATION

2.1 GENERAL DESCRIPTION OF THE EUT

Product Name	Bluetooth Speaker Microphone	
Brand Name	BTECH	
Model Name	BS-22	
Series Model(s)	N/A	
Model Difference	N/A	
Product Description	The EUT is a Bluetooth Speaker Microphone	
	Operation Frequency:	2402~2480 MHz
	Modulation Type:	GFSK
	Radio Technology:	BLE
	Bluetooth Configuration:	LE(Support 1M PHY, 2M PHY)
	Number Of Channel:	40
	Antenna Type:	PCB
	Antenna Gain (dBi)	1.6 dBi
Channel List	Please refer to the Note 3.	
Rating	Input: DC 5V	
Battery	Rated Voltage:3.7V Charge Limit Voltage:4.2 Capacity: 1200	
Hardware version number	N/A	
Software version number	N/A	
Connecting I/O Port(s)	Please refer to the Note 1.	

Note:

1. For a more detailed features description, please refer to the manufacturer's specifications or the User Manual.
2. The antenna information refer the manufacturer provide report, applicable only to the tested sample identified in the report. Due to the incorrect antenna information, a series of problems such as the accuracy of the test results will be borne by the customer.





3.

Channel List							
Channel	Frequency (MHz)	Channel	Frequency (MHz)	Channel	Frequency (MHz)	Channel	Frequency (MHz)
00	2402	10	2422	20	2442	30	2462
01	2404	11	2424	21	2444	31	2464
02	2406	12	2426	22	2446	32	2466
03	2408	13	2428	23	2448	33	2468
04	2410	14	2430	24	2450	34	2470
05	2412	15	2432	25	2452	35	2472
06	2414	16	2434	26	2454	36	2474
07	2416	17	2436	27	2456	37	2476
08	2418	18	2438	28	2458	38	2478
09	2420	19	2440	29	2460	39	2480



## 2.2 DESCRIPTION OF THE TEST MODES

For conducted test items and radiated spurious emissions  
Each of these EUT operation mode(s) or test configuration mode(s) mentioned below was evaluated respectively.

Worst Mode	Description	Data/Modulation
Mode 1	TX CH00(2402MHz)	1M PHY /GFSK
Mode 2	TX CH19(2440MHz)	1M PHY /GFSK
Mode 3	TX CH39(2480MHz)	1M PHY /GFSK

Worst Mode	Description	Data/Modulation
Mode 4	TX CH00(2402MHz)	2M PHY /GFSK
Mode 5	TX CH19(2440MHz)	2M PHY /GFSK
Mode 6	TX CH39(2480MHz)	2M PHY /GFSK

Note:

(1) The measurements are performed at all Bit Rate of Transmitter, the worst data was reported.

(2) We have be tested for all avaiable U.S. voltage and frequencies(For 120V,50/60Hz and 240V, 50/60Hz) for which the device is capable of operation, and the worst case of 120V/60Hz is shown in the report.

(3) The battery is fully-charged during the radited and RF conducted test.

For AC Conducted Emission

Test Case	
AC Conducted Emission	Mode 7 : Keeping BT TX

## 2.3 TEST SOFTWARE AND POWER LEVEL

During testing channel & power controlling software provided by the customer was used to control the operating channel as well as the output power level.

RF Function	Type	Mode Or Modulation type	ANT Gain(dBi)	Power Class	Software For Testing
BLE(With 2M PHY)	BLE_1M PHY	GFSK	1.6	5	bt_tool_v1.1.2
	BLE_2M PHY	GFSK	1.6	5	

### 2.4 BLOCK DIAGRAM SHOWING THE CONFIGURATION OF SYSTEM TESTED

#### Radiated Spurious Emission Test

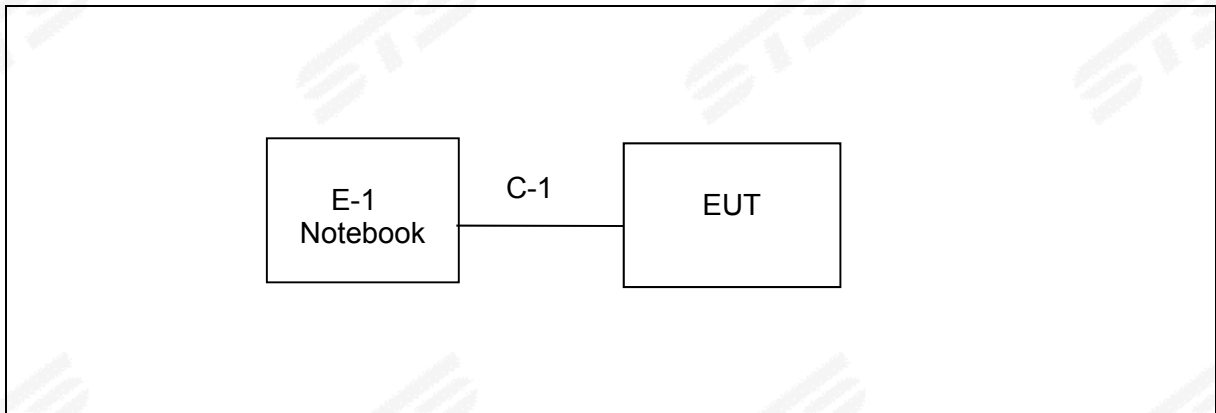

#### Conducted Emission Test

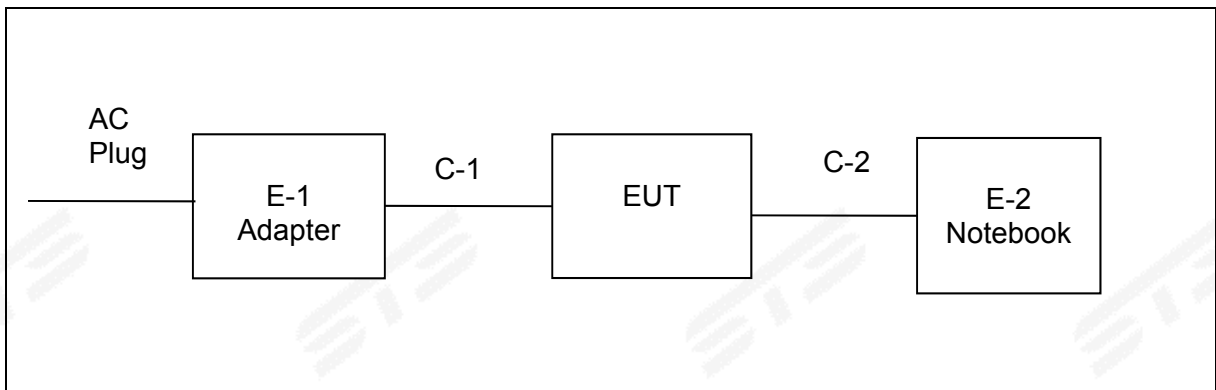

## 2.5 DESCRIPTION OF NECESSARY ACCESSORIES AND SUPPORT UNITS

The EUT has been tested as an independent unit together with other necessary accessories or support units. The following support units or accessories were used to form a representative test configuration during the tests.

### Necessary accessories

Item	Equipment	Mfr/Brand	Model/Type No.	Length	Note

### Support units

Item	Equipment	Mfr/Brand	Model/Type No.	Length	Note
	Adapter	HUAWEI	HW-050450C00	N/A	N/A
	USB Cable	N/A	N/A	110cm	NO
	Personal computer	DELL	Inspiron 14-3467	N/A	N/A
	USB Cable	N/A	N/A	150cm	NO

#### Note:

- (1) For detachable type I/O cable should be specified the length in cm in 『Length』 column.
- (2) "YES" is means "with core"; "NO" is means "without core".



## 2.6 EQUIPMENTS LIST

RF Radiation Test Equipment					
Kind of Equipment	Manufacturer	Type No.	Serial No.	Last Calibration	Calibrated Until
Temperature & Humidity	SW-108	SuWei	N/A	2023.03.03	2024.03.02
Pre-Amplifier(0.1M-3GHz)	EM	EM330	060665	2023.02.28	2024.02.27
Pre-Amplifier(1G-18GHz)	SKET	LNPA-01018G-45	SK2018080901	2023.09.26	2024.09.25
Pre-Amplifier(18G-40GHz)	SKET	LNPA_1840-50	SK2018101801	2023.03.06	2024.03.05
Active loop Antenna	ZHINAN	ZN30900C	16035	2023.02.28	2024.02.27
Bilog Antenna	TESEQ	CBL6111D	34678	2022.09.30	2024.09.29
Horn Antenna	SCHWARZBECK	BBHA 9120D	02014	2023.09.24	2025.09.23
Horn Antenna	A-INFOMW	LB-180400-KF	J211020657	2023.10.10	2025.10.09
Positioning Controller	MF	MF-7802	MF-780208587	N/A	N/A
Signal Analyzer	R&S	FSV 40-N	101823	2023.09.26	2024.09.25
Switch Control Box	N/A	N/A	N/A	N/A	N/A
Filter Box	BALUN Technology	SU319E	BL-SZ1530051	N/A	N/A
Antenna Mast	MF	MFA-440H	N/A	N/A	N/A
Turn Table	MF	SC100_1	60531	N/A	N/A
AC Power Source	APC	KDF-11010G	F214050035	N/A	N/A
DC power supply	HONGSHENGFENG	DPS-305AF	17064939	2023.09.26	2024.09.25
Test SW	EZ-EMC	Ver.STSLAB-03A1 RE			
Conduction Test equipment					
Kind of Equipment	Manufacturer	Type No.	Serial No.	Last calibration	Calibrated until
Test Receiver	R&S	ESCI	101427	2023.09.25	2024.09.24
LISN	R&S	ENV216	101242	2023.09.25	2024.09.24
LISN	EMCO	3810/2NM	23625	2023.09.25	2024.09.24
Temperature & Humidity	SW-108	SuWei	N/A	2023.03.03	2024.03.02
Test SW	EZ-EMC	Ver.STSLAB-03A1 CE			
RF Connected Test					
Kind of Equipment	Manufacturer	Type No.	Serial No.	Last calibration	Calibrated until
Signal Analyzer	Agilent	N9020A	MY51510623	2023.03.01	2024.02.28
Power Sensor	Keysight	U2021XA	MY55520005	2023.09.26	2024.09.25
Temperature & Humidity	SW-108	SuWei	N/A	2023.03.03	2024.03.02
Test SW	MW	MTS 8310_2.0.0.0			

### 3. EMC EMISSION TEST

#### 3.1 CONDUCTED EMISSION MEASUREMENT

##### 3.1.1 POWER LINE CONDUCTED EMISSION LIMITS

The radio frequency voltage that is conducted back onto the AC power line on any frequency or frequencies, within the band 150 kHz to 30 MHz, shall not exceed the limits in the following table.

FREQUENCY (MHz)	Conducted Emission limit (dBuV)	
	Quasi-peak	Average
0.15 -0.5	66 - 56 *	56 - 46 *
0.50 -5.0	56.00	46.00
5.0 -30.0	60.00	50.00

Note:

- (1) The tighter limit applies at the band edges.
- (2) The limit of “ \* ” marked band means the limitation decreases linearly with the logarithm of the frequency in the range.

The following table is the setting of the receiver

Receiver Parameters	Setting
Attenuation	10 dB
Start Frequency	0.15 MHz
Stop Frequency	30 MHz
IF Bandwidth	9 kHz

### 3.2 TEST PROCEDURE

- a. The EUT is 0.8 m from the horizontal ground plane and 0.4 m from the vertical ground plane with EUT being connected to the power mains through a line impedance stabilization network (LISN). All other support equipments are powered from additional LISN(s). The LISN provides 50 Ohm/ 50uH of coupling impedance for the measuring instrument.
- b. Interconnecting cables that hang closer than 40 cm to the ground plane shall be folded back and forth in the center forming a bundle 30 to 40 cm long.
- c. I/O cables that are not connected to a peripheral shall be bundled in the center. The end of the cable may be terminated, if required, using the correct terminating impedance. The overall length shall not exceed 1 m.
- d. LISN is at least 80 cm from the nearest part of EUT chassis.
- e. For the actual test configuration, please refer to the related Item –EUT Test Photos.

### 3.3 TEST SETUP

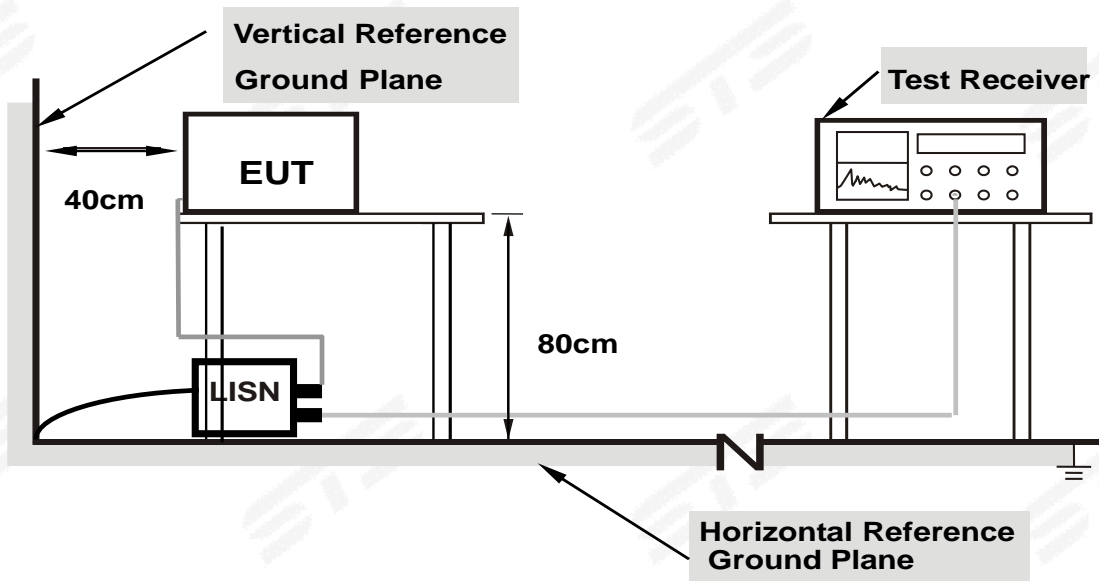

- Note: 1. Support units were connected to second LISN.**
- 2. Both of LISNs (AMN) are 80 cm from EUT and at least 80 cm from other units and other metal planes support units.**

### 3.4 EUT OPERATING CONDITIONS

The EUT was configured for testing in a typical fashion (as a customer would normally use it). The EUT has been programmed to continuously transmit during test. This operating condition was tested and used to collect the included data.



3.5 TEST RESULTS

Temperature:	24.3(C)	Relative Humidity:	41%RH
Test Voltage:	AC 120V/60Hz	Phase:	L
Test Mode:	Mode 7		

No.	Frequency (MHz)	Reading (dBuV)	Correct Factor(dB)	Result (dBuV)	Limit (dBuV)	Margin (dB)	Remark
1	0.2060	18.74	19.79	38.53	63.37	-24.84	QP
2	0.2060	7.16	19.79	26.95	53.37	-26.42	AVG
3	0.4780	19.97	20.00	39.97	56.37	-16.40	QP
4	0.4780	14.34	20.00	34.34	46.37	-12.03	AVG
5	0.9220	15.68	19.77	35.45	56.00	-20.55	QP
6	0.9220	5.23	19.77	25.00	46.00	-21.00	AVG
7	1.2740	14.94	19.75	34.69	56.00	-21.31	QP
8	1.2740	4.57	19.75	24.32	46.00	-21.68	AVG
9	8.0020	16.04	20.07	36.11	60.00	-23.89	QP
10	8.0020	5.60	20.07	25.67	50.00	-24.33	AVG
11	17.0860	10.02	20.38	30.40	60.00	-29.60	QP
12	17.0860	-1.32	20.38	19.06	50.00	-30.94	AVG

Remark:

1. All readings are Quasi-Peak and Average values
2. Margin = Result (Result =Reading + Factor)–Limit
3. Factor=LISN factor+Cable loss+Limiter (10dB)

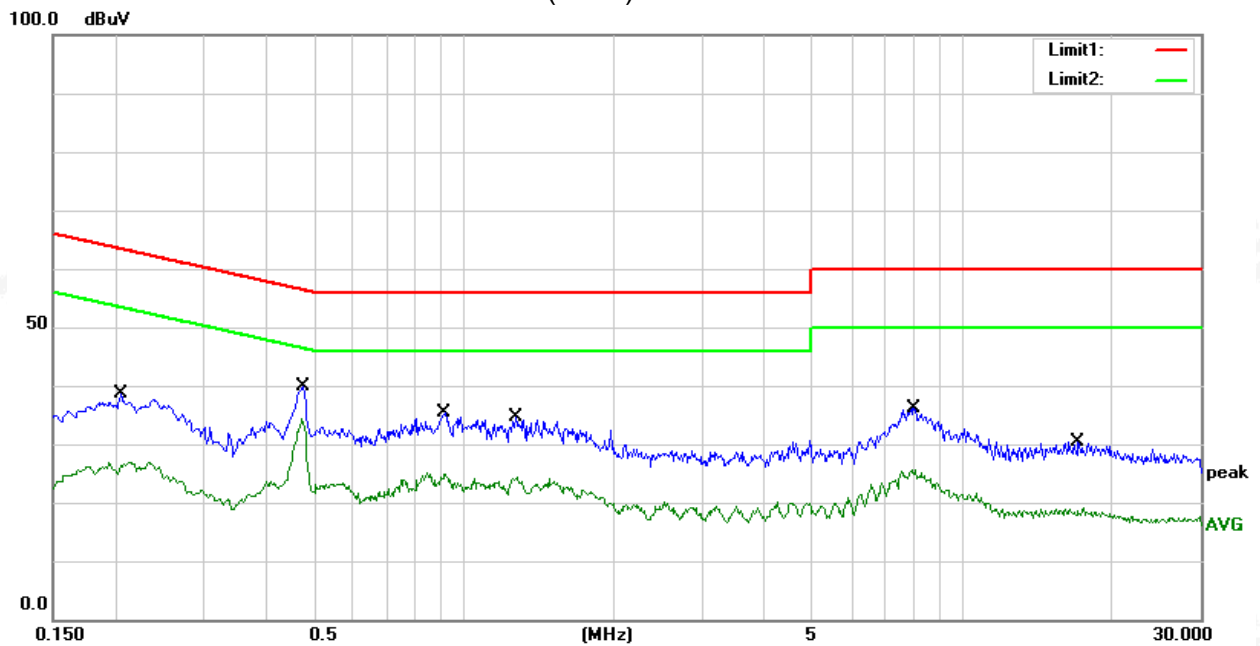





Temperature:	24.3(C)	Relative Humidity:	41%RH
Test Voltage:	AC 120V/60Hz	Phase:	N
Test Mode:	Mode 7		

No.	Frequency (MHz)	Reading (dBuV)	Correct Factor(dB)	Result (dBuV)	Limit (dBuV)	Margin (dB)	Remark
1	0.1900	20.23	19.76	39.99	64.04	-24.05	QP
2	0.1900	8.67	19.76	28.43	54.04	-25.61	AVG
3	0.2700	18.48	20.07	38.55	61.12	-22.57	QP
4	0.2700	6.33	20.07	26.40	51.12	-24.72	AVG
5	0.4700	20.20	20.00	40.20	56.51	-16.31	QP
6	0.4700	8.93	20.00	28.93	46.51	-17.58	AVG
7	0.9140	23.12	19.77	42.89	56.00	-13.11	QP
8	0.9140	9.89	19.77	29.66	46.00	-16.34	AVG
9	4.2060	11.84	19.81	31.65	56.00	-24.35	QP
10	4.2060	2.88	19.81	22.69	46.00	-23.31	AVG
11	7.9900	17.13	20.07	37.20	60.00	-22.80	QP
12	7.9900	5.45	20.07	25.52	50.00	-24.48	AVG

Remark:

- 1. All readings are Quasi-Peak and Average values
- 2. Margin = Result (Result =Reading + Factor)–Limit
- 3. Factor=LISN factor+Cable loss+Limiter (10dB)

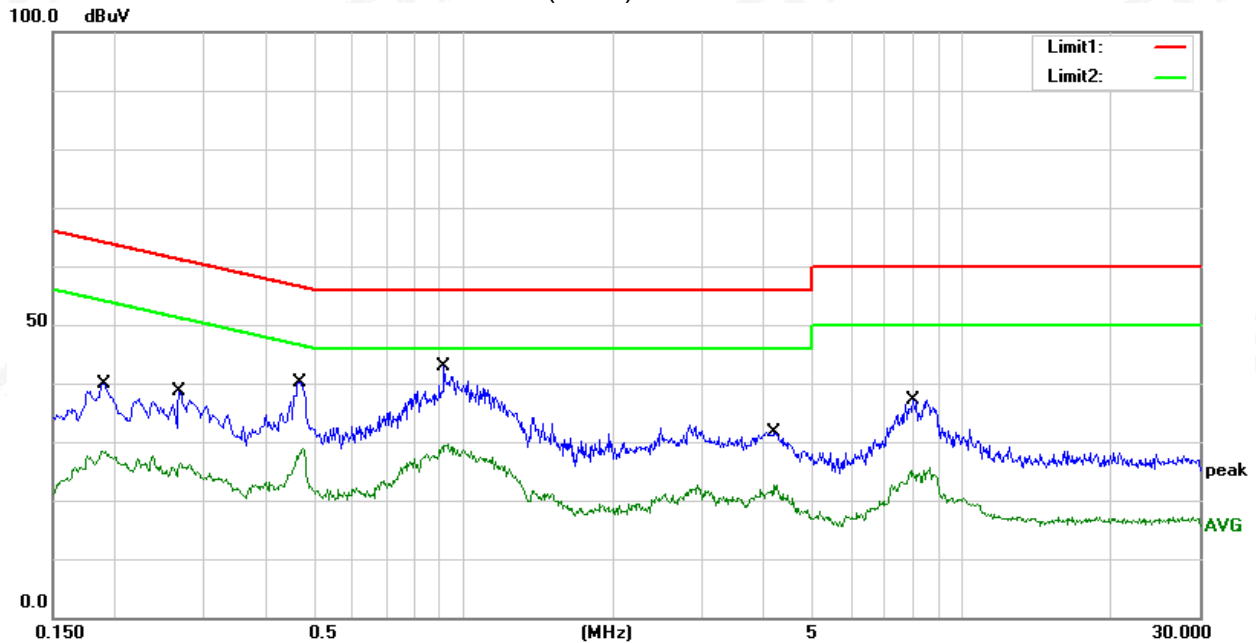



#### 4. RADIATED EMISSION MEASUREMENT

##### 4.1 RADIATED EMISSION LIMITS

In any 100 kHz bandwidth outside the operating frequency band. In case the emission fall within the Restricted band specified on Part15.205(a)&209(a) limit in the table and according to ANSI C63.10-2013 below has to be followed.

##### LIMITS OF RADIATED EMISSION MEASUREMENT (Frequency Range 9kHz-1000MHz)

Frequencies (MHz)	Field Strength (micorvolts/meter)	Measurement Distance (meters)
0.009~0.490	2400/F(KHz)	300
0.490~1.705	24000/F(KHz)	30
1.705~30.0	30	30
30~88	100	3
88~216	150	3
216~960	200	3
Above 960	500	3

##### LIMITS OF RADIATED EMISSION MEASUREMENT (Above 1000MHz)

FREQUENCY (MHz)	(dBuV/m) (at 3M)	
	PEAK	AVERAGE
Above 1000	74	54

Notes:

- (1) The limit for radiated test was performed according to FCC PART 15C.
- (2) The tighter limit applies at the band edges.
- (3) Emission level (dBuV/m)=20log Emission level (uV/m).

##### LIMITS OF RESTRICTED FREQUENCY BANDS

FREQUENCY (MHz)	FREQUENCY (MHz)	FREQUENCY (MHz)	FREQUENCY (GHz)
0.090-0.110	16.42-16.423	399.9-410	4.5-5.15
0.495-0.505	16.69475-16.69525	608-614	5.35-5.46
2.1735-2.1905	16.80425-16.80475	960-1240	7.25-7.75
4.125-4.128	25.5-25.67	1300-1427	8.025-8.5
4.17725-4.17775	37.5-38.25	1435-1626.5	9.0-9.2
4.20725-4.20775	73-74.6	1645.5-1646.5	9.3-9.5
6.215-6.218	74.8-75.2	1660-1710	10.6-12.7
6.26775-6.26825	108-121.94	1718.8-1722.2	13.25-13.4
6.31175-6.31225	123-138	2200-2300	14.47-14.5
8.291-8.294	149.9-150.05	2310-2390	15.35-16.2
8.362-8.366	156.52475-156.52525	2483.5-2500	17.7-21.4
8.37625-8.38675	156.7-156.9	2690-2900	22.01-23.12
8.41425-8.41475	162.0125-167.17	3260-3267	23.6-24.0
12.29-12.293	167.72-173.2	3332-3339	31.2-31.8
12.51975-12.52025	240-285	3345.8-3358	36.43-36.5
12.57675-12.57725	322-335.4	3600-4400	Above 38.6
13.36-13.41			



## For Radiated Emission

Spectrum Parameter	Setting
Attenuation	Auto
Detector	Peak/QP/AV
Start Frequency	9 KHz/150KHz(Peak/QP/AV)
Stop Frequency	150KHz/30MHz(Peak/QP/AV)
RB / VB (emission in restricted band)	200Hz (From 9kHz to 0.15MHz)/ 9KHz (From 0.15MHz to 30MHz); 200Hz (From 9kHz to 0.15MHz)/ 9KHz (From 0.15MHz to 30MHz)

Spectrum Parameter	Setting
Attenuation	Auto
Detector	Peak/QP
Start Frequency	30 MHz(Peak/QP)
Stop Frequency	1000 MHz (Peak/QP)
RB / VB (emission in restricted band)	120 KHz / 300 KHz

Spectrum Parameter	Setting
Attenuation	Auto
Detector	Peak/AV
Start Frequency	1000 MHz(Peak/AV)
Stop Frequency	10th carrier hamonic(Peak/AV)
RB / VB (emission in restricted band)	1 MHz / 3 MHz(Peak) 1 MHz/1/T MHz(AVG)

## For Restricted band

Spectrum Parameter	Setting
Detector	Peak/AV
Start/Stop Frequency	Lower Band Edge: 2310 to 2410 MHz Upper Band Edge: 2475 to 2500 MHz
RB / VB	1 MHz / 3 MHz(Peak) 1 MHz/1/T MHz(AVG)



Receiver Parameter	Setting
Start ~ Stop Frequency	9kHz~90kHz / RB 200Hz for PK & AV
Start ~ Stop Frequency	90kHz~110kHz / RB 200Hz for QP
Start ~ Stop Frequency	110kHz~490kHz / RB 200Hz for PK & AV
Start ~ Stop Frequency	490kHz~30MHz / RB 9kHz for QP
Start ~ Stop Frequency	30MHz~1000MHz / RB 120kHz for QP

#### 4.2 TEST PROCEDURE

- a. The measuring distance at 3 m shall be used for measurements at frequency 0.009MHz up to 1GHz, and above 1GHz.
- b. The EUT was placed on the top of a rotating table 0.8 m (above 1GHz is 1.5 m) above the ground at a 3 m anechoic chamber test site. The table was rotated 360 degree to determine the position of the highest radiation.
- c. The height of the equipment shall be 0.8 m (above 1GHz is 1.5 m); the height of the test antenna shall vary between 1 m to 4 m. Horizontal and vertical polarization of the antenna are set to make the measurement.
- d. The initial step in collecting conducted emission data is a spectrum analyzer peak detector mode pre-scanning the measurement frequency range. Significant peaks are then marked and QuasiPeak detector mode will be re-measured.
- e. If the Peak Mode measured value is compliance with and lower than Quasi Peak Mode Limit, the EUT shall be deemed to meet QP Limits and no additional QP Mode measurement was performed.
- f. For the actual test configuration, please refer to the related Item –EUT Test Photos.

**Note:**

Both horizontal and vertical antenna polarities were tested and performed pretest to three orthogonal axis. The worst case emissions were reported.

### 4.3 TEST SETUP

#### (A) Radiated Emission Test-Up Frequency Below 30MHz

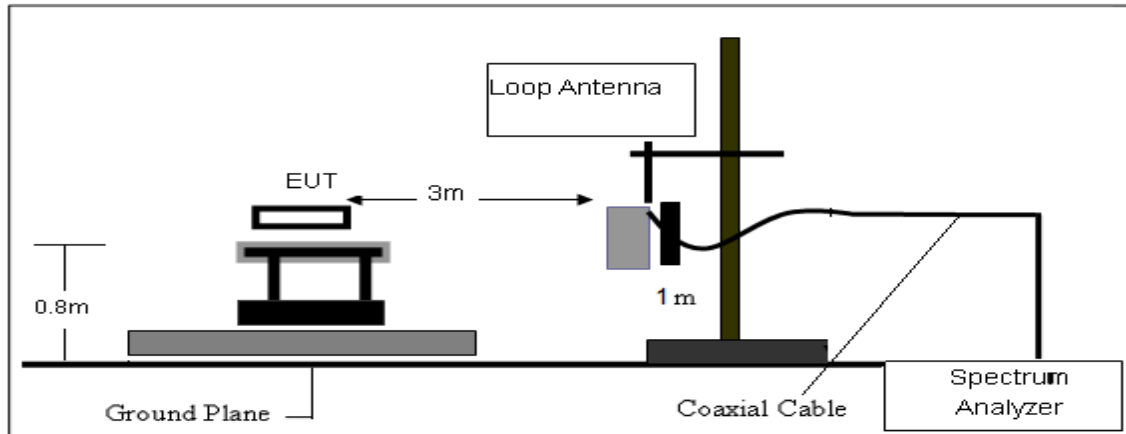

#### (B) Radiated Emission Test-Up Frequency 30MHz~1GHz

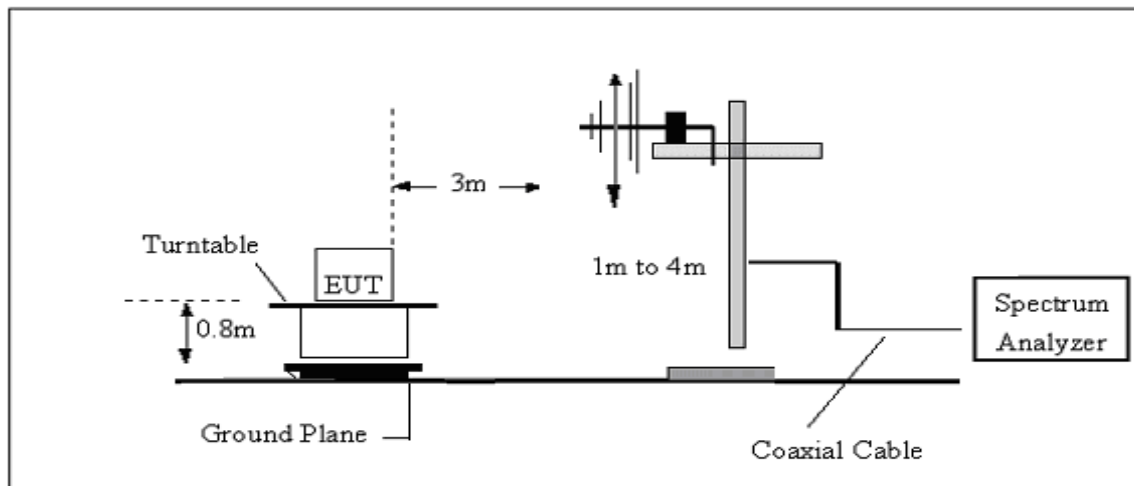

#### (C) Radiated Emission Test-Up Frequency Above 1GHz

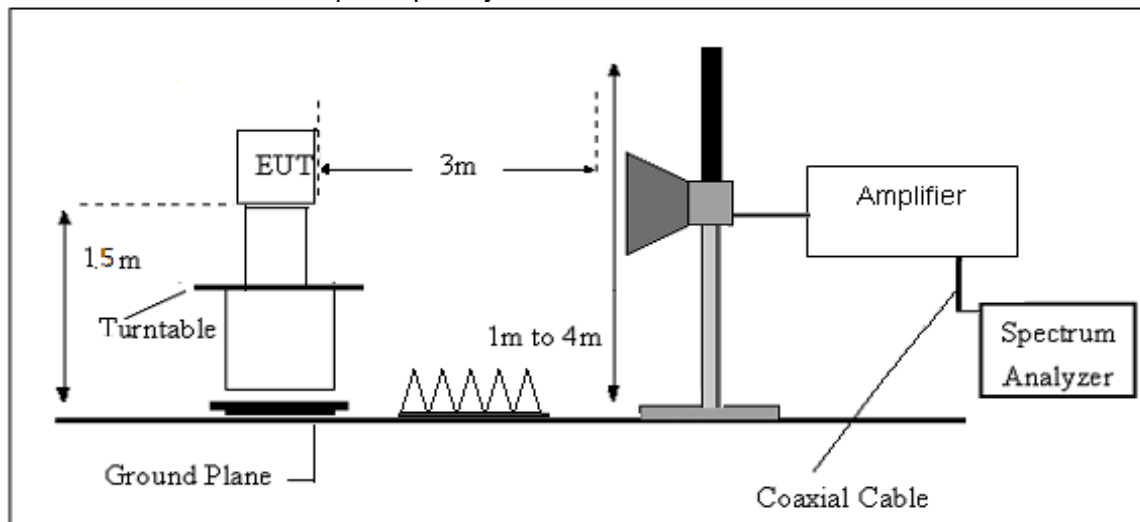

### 4.4 EUT OPERATING CONDITIONS

Please refer to section 3.4 of this report.



### 4.5 FIELD STRENGTH CALCULATION

The field strength is calculated by adding the Antenna Factor and Cable Factor and subtracting the Amplifier Gain and Duty Cycle Correction Factor (if any) from the measured reading. The basic equation with a sample calculation is as follows:

$$FS = RA + AF + CL - AG$$

Where

FS = Field Strength

CL = Cable Attenuation Factor (Cable Loss)

RA = Reading Amplitude

AG = Amplifier Gain

AF = Antenna Factor

For example

Frequency (MHz)	FS (dB $\mu$ V/m)	RA (dB $\mu$ V/m)	AF (dB)	CL (dB)	AG (dB)	Factor (dB)
300	40	58.1	12.2	1.6	31.9	-18.1

$$\text{Factor} = \text{AF} + \text{CL} - \text{AG}$$



## 4.6 TEST RESULTS

(Between 9KHz – 30 MHz)

Temperature:	23.1(C)	Relative Humidity:	60%RH
Test Voltage:	DC 3.7V	Polarization:	--
Test Mode:	TX Mode		

Freq.	Reading	Limit	Margin	State
(MHz)	(dBuV/m)	(dBuV/m)	(dB)	P/F
--	--	--	--	PASS
--	--	--	--	PASS

## Note:

The amplitude of spurious emissions which are attenuated by more than 20dB below the permissible value has no need to be reported.

Distance extrapolation factor =  $40 \log (\text{specific distance}/\text{test distance})$ (dB);

Limit line = specific limits(dBuv) + distance extrapolation factor.



(30MHz -1000MHz)

1M PHY

Temperature:	23.1(C)	Relative Humidity:	60%RH
Test Voltage:	DC 3.7V	Phase:	Horizontal
Test Mode:	Mode 1/2/3 (Mode 2 worst mode)		

No.	Frequency (MHz)	Reading (dBuV)	Correct Factor(dB/m)	Result (dBuV/m)	Limit (dBuV/m)	Margin (dB)	Remark
1	83.3500	56.22	-22.52	33.70	40.00	-6.30	peak
2	155.1300	55.18	-18.63	36.55	43.50	-6.95	peak
3	256.9800	52.51	-15.13	37.38	46.00	-8.62	peak
4	386.9600	47.37	-11.79	35.58	46.00	-10.42	peak
5	446.1300	45.27	-9.83	35.44	46.00	-10.56	peak
6	704.1500	38.55	-4.04	34.51	46.00	-11.49	peak

Remark:

1. Margin = Result (Result =Reading + Factor)–Limit
2. Factor= Antenna factor+Cable attenuation factor(cable loss)-Amplifier gain
3. All modes have been tested,only show the worst case.

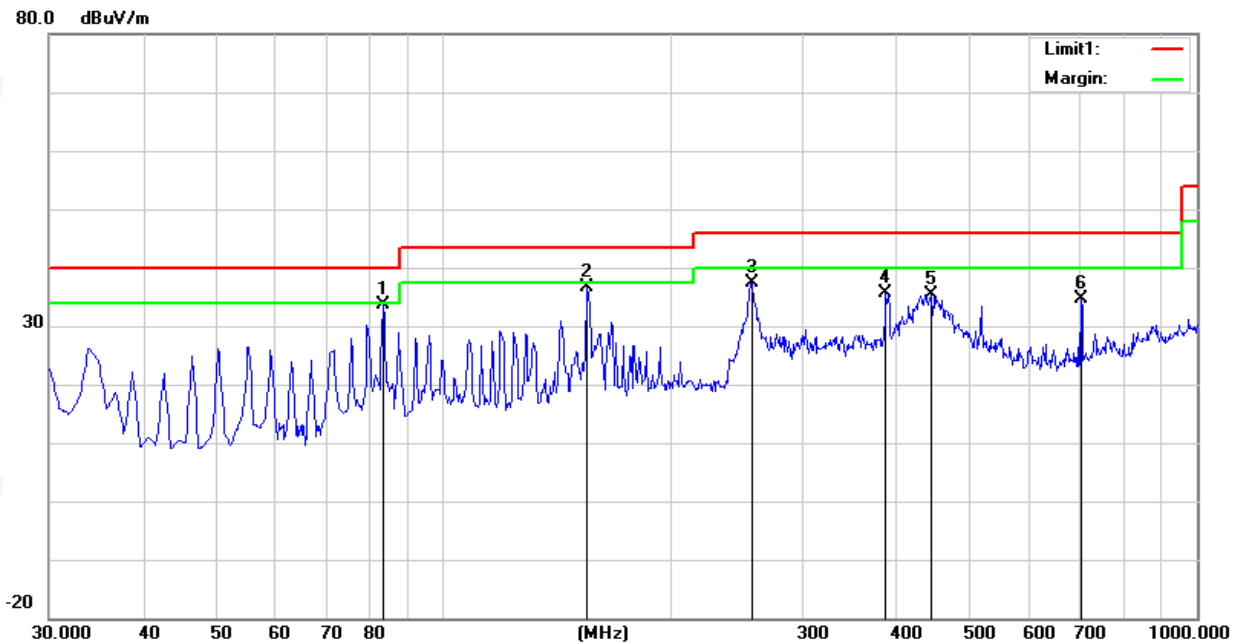





Temperature:	23.1(C)	Relative Humidity:	60%RH
Test Voltage:	DC 3.7V	Phase:	Vertical
Test Mode:	Mode 1/2/3 (Mode 2 worst mode)		

No.	Frequency (MHz)	Reading (dBUV)	Correct Factor(dB/m)	Result (dBUV/m)	Limit (dBUV/m)	Margin (dB)	Remark
1	79.4700	56.17	-23.11	33.06	40.00	-6.94	peak
2	198.7800	58.23	-21.12	37.11	43.50	-6.39	peak
3	256.9800	49.86	-15.13	34.73	46.00	-11.27	peak
4	398.6000	50.14	-11.20	38.94	46.00	-7.06	peak
5	598.4200	41.38	-5.85	35.53	46.00	-10.47	peak
6	797.2700	39.92	-2.03	37.89	46.00	-8.11	peak

Remark:

- 1. Margin = Result (Result =Reading + Factor )-Limit
- 2. Factor= Antenna factor+Cable attenuation factor(cable loss)-Amplifier gain
- 3. All modes have been tested,only show the worst case.

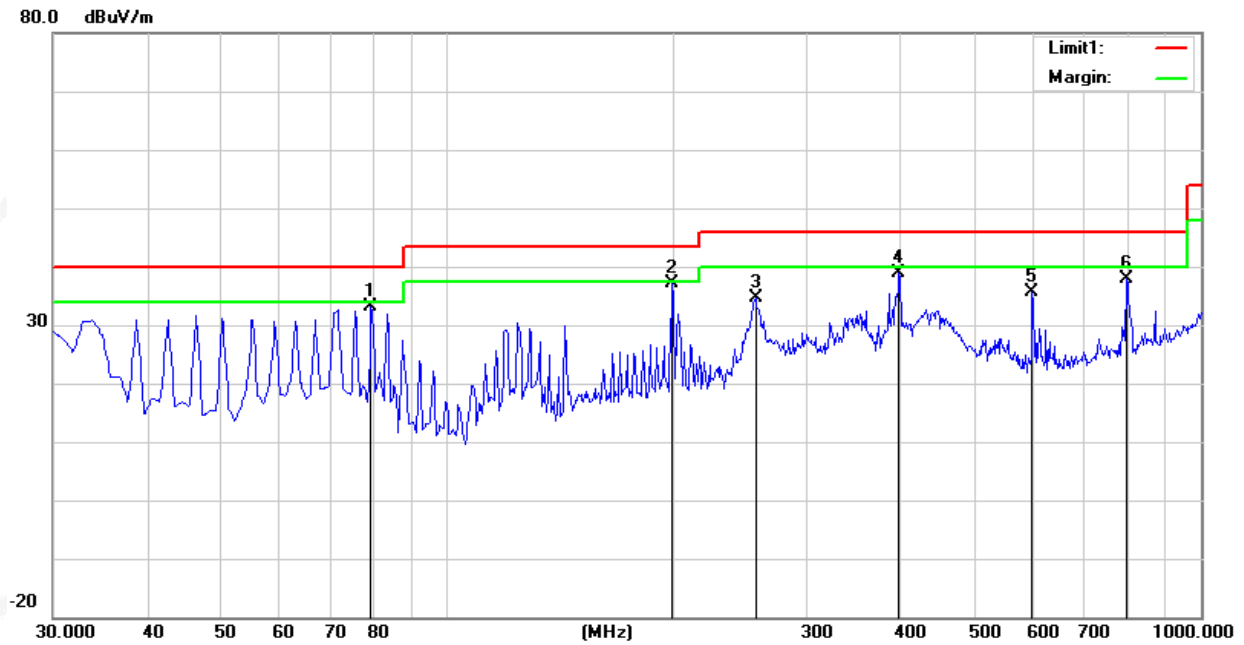



2M PHY

Temperature:	23.1(C)	Relative Humidity:	60%RH
Test Voltage:	DC 3.7V	Phase:	Horizontal
Test Mode:	Mode 4/5/6 (Mode 5 worst mode)		

No.	Frequency (MHz)	Reading (dBuV)	Correct Factor(dB/m)	Result (dBuV/m)	Limit (dBuV/m)	Margin (dB)	Remark
1	83.3500	55.33	-22.52	32.81	40.00	-7.19	peak
2	128.9400	51.74	-18.26	33.48	43.50	-10.02	peak
3	198.7800	57.36	-21.12	36.24	43.50	-7.26	peak
4	256.9800	54.42	-15.13	39.29	46.00	-6.71	peak
5	398.6000	49.59	-11.20	38.39	46.00	-7.61	peak
6	797.2700	40.92	-2.03	38.89	46.00	-7.11	peak

Remark:

- 1. Margin = Result (Result =Reading + Factor )-Limit
- 2. Factor= Antenna factor+Cable attenuation factor(cable loss)-Amplifier gain
- 3. All modes have been tested,only show the worst case.

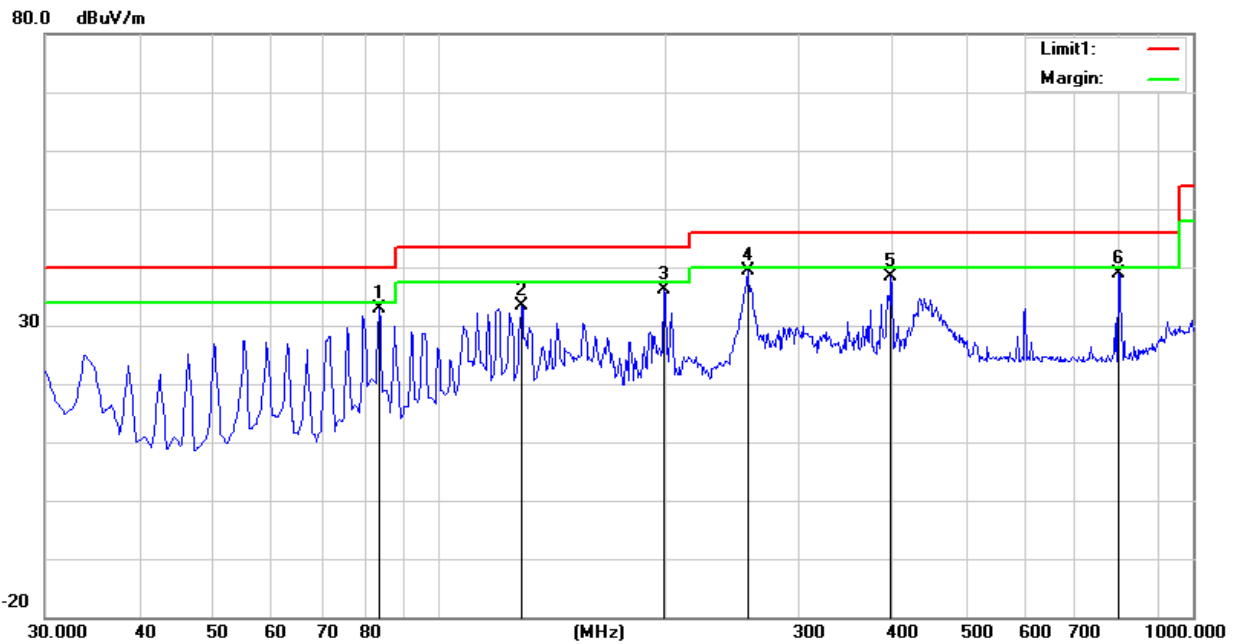



Temperature:	23.1(C)	Relative Humidity:	60%RH
Test Voltage:	DC 3.7V	Phase:	Vertical
Test Mode:	Mode 4/5/6 (Mode 5 worst mode)		

No.	Frequency (MHz)	Reading (dBuV)	Correct Factor(dB/m)	Result (dBuV/m)	Limit (dBuV/m)	Margin (dB)	Remark
1	79.4700	54.50	-23.11	31.39	40.00	-8.61	peak
2	199.7500	57.52	-21.11	36.41	43.50	-7.09	peak
3	255.0400	50.40	-15.35	35.05	46.00	-10.95	peak
4	395.6900	50.26	-11.34	38.92	46.00	-7.08	peak
5	599.3900	42.52	-5.84	36.68	46.00	-9.32	peak
6	799.2100	38.48	-2.04	36.44	46.00	-9.56	peak

Remark:

- 1. Margin = Result (Result =Reading + Factor )–Limit
- 2. Factor= Antenna factor+Cable attenuation factor(cable loss)-Amplifier gain
- 3. All modes have been tested,only show the worst case.

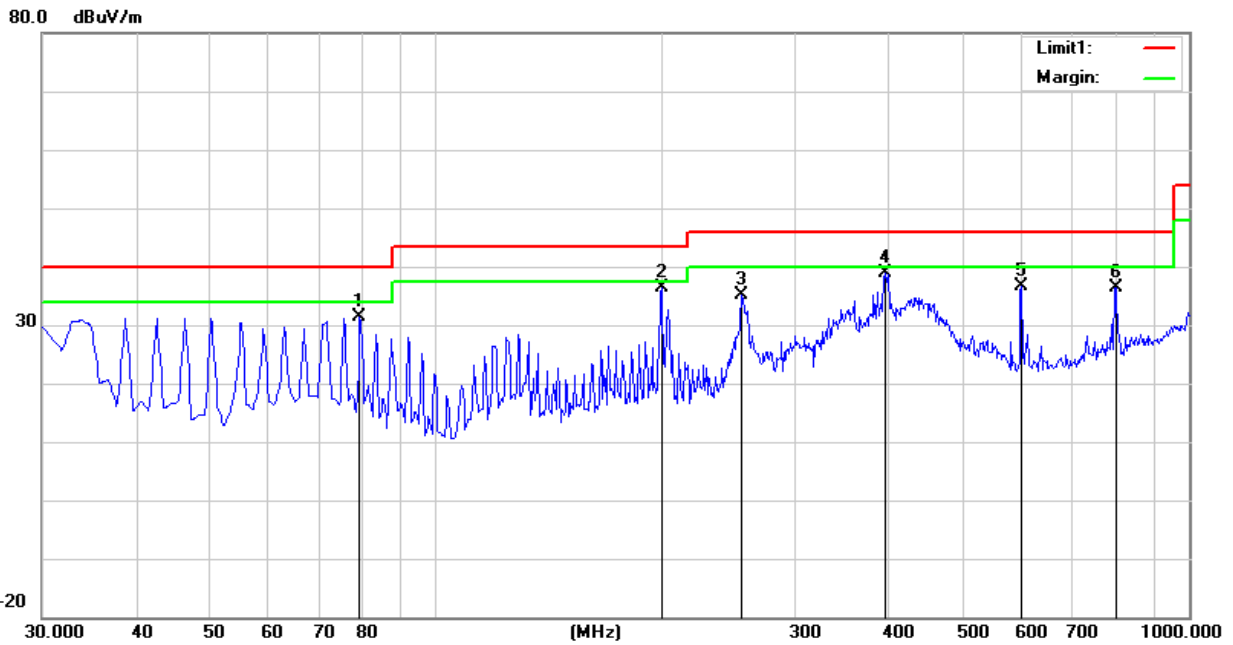



## (1GHz-25GHz) Spurious emission Requirements

1M PHY  
GFSK

Frequency (MHz)	Meter Reading (dBμV)	Amplifier (dB)	Loss (dB)	Antenna Factor (dB/m)	Corrected Factor (dB)	Emission Level (dBμV/m)	Limits (dBμV/m)	Margin (dB)	Detector Type	Comment
Low Channel (GFSK/2402 MHz)										
3264.65	61.79	44.70	6.70	28.20	-9.80	51.99	74.00	-22.01	PK	Vertical
3264.65	51.66	44.70	6.70	28.20	-9.80	41.86	54.00	-12.14	AV	Vertical
3264.69	61.47	44.70	6.70	28.20	-9.80	51.67	74.00	-22.33	PK	Horizontal
3264.69	50.86	44.70	6.70	28.20	-9.80	41.06	54.00	-12.94	AV	Horizontal
4804.29	58.94	44.20	9.04	31.60	-3.56	55.38	74.00	-18.62	PK	Vertical
4804.29	50.12	44.20	9.04	31.60	-3.56	46.56	54.00	-7.44	AV	Vertical
4804.42	58.81	44.20	9.04	31.60	-3.56	55.25	74.00	-18.75	PK	Horizontal
4804.42	50.21	44.20	9.04	31.60	-3.56	46.65	54.00	-7.35	AV	Horizontal
5359.69	49.03	44.20	9.86	32.00	-2.34	46.69	74.00	-27.31	PK	Vertical
5359.69	39.70	44.20	9.86	32.00	-2.34	37.36	54.00	-16.64	AV	Vertical
5359.77	47.56	44.20	9.86	32.00	-2.34	45.22	74.00	-28.78	PK	Horizontal
5359.77	38.26	44.20	9.86	32.00	-2.34	35.92	54.00	-18.08	AV	Horizontal
7205.71	54.28	43.50	11.40	35.50	3.40	57.68	74.00	-16.32	PK	Vertical
7205.71	44.04	43.50	11.40	35.50	3.40	47.44	54.00	-6.56	AV	Vertical
7205.87	54.75	43.50	11.40	35.50	3.40	58.15	74.00	-15.85	PK	Horizontal
7205.87	43.75	43.50	11.40	35.50	3.40	47.15	54.00	-6.85	AV	Horizontal
Middle Channel (GFSK/2440 MHz)										
3263.10	61.31	44.70	6.70	28.20	-9.80	51.51	74.00	-22.49	PK	Vertical
3263.10	51.59	44.70	6.70	28.20	-9.80	41.79	54.00	-12.21	AV	Vertical
3263.03	61.36	44.70	6.70	28.20	-9.80	51.56	74.00	-22.44	PK	Horizontal
3263.03	50.71	44.70	6.70	28.20	-9.80	40.91	54.00	-13.09	AV	Horizontal
4880.10	59.04	44.20	9.04	31.60	-3.56	55.48	74.00	-18.52	PK	Vertical
4880.10	50.00	44.20	9.04	31.60	-3.56	46.44	54.00	-7.56	AV	Vertical
4880.00	58.85	44.20	9.04	31.60	-3.56	55.29	74.00	-18.71	PK	Horizontal
4880.00	49.30	44.20	9.04	31.60	-3.56	45.74	54.00	-8.26	AV	Horizontal
5357.23	48.93	44.20	9.86	32.00	-2.34	46.59	74.00	-27.41	PK	Vertical
5357.23	38.97	44.20	9.86	32.00	-2.34	36.63	54.00	-17.37	AV	Vertical
5357.39	47.16	44.20	9.86	32.00	-2.34	44.82	74.00	-29.18	PK	Horizontal
5357.16	39.21	44.20	9.86	32.00	-2.34	36.87	54.00	-17.13	AV	Horizontal
7320.85	54.54	43.50	11.40	35.50	3.40	57.94	74.00	-16.06	PK	Vertical
7320.85	44.02	43.50	11.40	35.50	3.40	47.42	54.00	-6.58	AV	Vertical
7320.47	54.32	43.50	11.40	35.50	3.40	57.72	74.00	-16.28	PK	Horizontal
7320.47	44.59	43.50	11.40	35.50	3.40	47.99	54.00	-6.01	AV	Horizontal



High Channel (GFSK/2480 MHz)										
3264.75	62.02	44.70	6.70	28.20	-9.80	52.22	74.00	-21.78	PK	Vertical
3264.75	51.72	44.70	6.70	28.20	-9.80	41.92	54.00	-12.08	AV	Vertical
3264.65	61.38	44.70	6.70	28.20	-9.80	51.58	74.00	-22.42	PK	Horizontal
3264.65	50.16	44.70	6.70	28.20	-9.80	40.36	54.00	-13.64	AV	Horizontal
4960.39	58.78	44.20	9.04	31.60	-3.56	55.22	74.00	-18.78	PK	Vertical
4960.39	49.38	44.20	9.04	31.60	-3.56	45.82	54.00	-8.18	AV	Vertical
4960.45	59.36	44.20	9.04	31.60	-3.56	55.80	74.00	-18.20	PK	Horizontal
4960.45	49.68	44.20	9.04	31.60	-3.56	46.12	54.00	-7.88	AV	Horizontal
5359.64	47.98	44.20	9.86	32.00	-2.34	45.64	74.00	-28.36	PK	Vertical
5359.64	40.23	44.20	9.86	32.00	-2.34	37.89	54.00	-16.11	AV	Vertical
5359.60	47.81	44.20	9.86	32.00	-2.34	45.47	74.00	-28.53	PK	Horizontal
5359.60	39.01	44.20	9.86	32.00	-2.34	36.67	54.00	-17.33	AV	Horizontal
7439.86	53.94	43.50	11.40	35.50	3.40	57.34	74.00	-16.66	PK	Vertical
7439.86	43.93	43.50	11.40	35.50	3.40	47.33	54.00	-6.67	AV	Vertical
7439.83	53.67	43.50	11.40	35.50	3.40	57.07	74.00	-16.93	PK	Horizontal
7439.83	43.77	43.50	11.40	35.50	3.40	47.17	54.00	-6.83	AV	Horizontal

**Note:**

1) Factor = Antenna Factor + Cable Loss – Pre-amplifier.

Emission Level = Reading + Factor.

2) The frequency emission of peak points that did not show above the forms are at least 20dB below the limit, the frequency emission is mainly from the environment noise.



## 2M PHY GFSK

Frequency (MHz)	Meter Reading (dBμV)	Amplifier (dB)	Loss (dB)	Antenna Factor (dB/m)	Corrected Factor (dB)	Emission Level (dBμV/m)	Limits (dBμV/m)	Margin (dB)	Detector Type	Comment
Low Channel (GFSK/2402 MHz)										
3264.89	61.00	44.70	6.70	28.20	-9.80	51.20	74.00	-22.80	PK	Vertical
3264.89	50.73	44.70	6.70	28.20	-9.80	40.93	54.00	-13.07	AV	Vertical
3264.85	61.31	44.70	6.70	28.20	-9.80	51.51	74.00	-22.49	PK	Horizontal
3264.85	50.77	44.70	6.70	28.20	-9.80	40.97	54.00	-13.03	AV	Horizontal
4804.47	58.15	44.20	9.04	31.60	-3.56	54.59	74.00	-19.41	PK	Vertical
4804.47	50.20	44.20	9.04	31.60	-3.56	46.64	54.00	-7.36	AV	Vertical
4804.49	58.71	44.20	9.04	31.60	-3.56	55.15	74.00	-18.85	PK	Horizontal
4804.49	50.11	44.20	9.04	31.60	-3.56	46.55	54.00	-7.45	AV	Horizontal
5359.60	48.32	44.20	9.86	32.00	-2.34	45.98	74.00	-28.02	PK	Vertical
5359.60	40.18	44.20	9.86	32.00	-2.34	37.84	54.00	-16.16	AV	Vertical
5359.84	48.45	44.20	9.86	32.00	-2.34	46.11	74.00	-27.89	PK	Horizontal
5359.84	39.48	44.20	9.86	32.00	-2.34	37.14	54.00	-16.86	AV	Horizontal
7205.70	54.35	43.50	11.40	35.50	3.40	57.75	74.00	-16.25	PK	Vertical
7205.70	44.63	43.50	11.40	35.50	3.40	48.03	54.00	-5.97	AV	Vertical
7205.68	53.63	43.50	11.40	35.50	3.40	57.03	74.00	-16.97	PK	Horizontal
7205.68	43.96	43.50	11.40	35.50	3.40	47.36	54.00	-6.64	AV	Horizontal
Middle Channel (GFSK/2440 MHz)										
3263.09	61.71	44.70	6.70	28.20	-9.80	51.91	74.00	-22.09	PK	Vertical
3263.09	51.31	44.70	6.70	28.20	-9.80	41.51	54.00	-12.49	AV	Vertical
3263.07	62.08	44.70	6.70	28.20	-9.80	52.28	74.00	-21.72	PK	Horizontal
3263.07	50.23	44.70	6.70	28.20	-9.80	40.43	54.00	-13.57	AV	Horizontal
4879.93	59.07	44.20	9.04	31.60	-3.56	55.51	74.00	-18.49	PK	Vertical
4879.93	49.64	44.20	9.04	31.60	-3.56	46.08	54.00	-7.92	AV	Vertical
4879.91	58.14	44.20	9.04	31.60	-3.56	54.58	74.00	-19.42	PK	Horizontal
4879.91	50.39	44.20	9.04	31.60	-3.56	46.83	54.00	-7.17	AV	Horizontal
5357.10	48.87	44.20	9.86	32.00	-2.34	46.53	74.00	-27.47	PK	Vertical
5357.10	39.29	44.20	9.86	32.00	-2.34	36.95	54.00	-17.05	AV	Vertical
5357.39	47.85	44.20	9.86	32.00	-2.34	45.51	74.00	-28.49	PK	Horizontal
5357.08	38.87	44.20	9.86	32.00	-2.34	36.53	54.00	-17.47	AV	Horizontal
7320.85	53.69	43.50	11.40	35.50	3.40	57.09	74.00	-16.91	PK	Vertical
7320.85	44.45	43.50	11.40	35.50	3.40	47.85	54.00	-6.15	AV	Vertical
7320.51	53.99	43.50	11.40	35.50	3.40	57.39	74.00	-16.61	PK	Horizontal
7320.51	44.25	43.50	11.40	35.50	3.40	47.65	54.00	-6.35	AV	Horizontal



High Channel (GFSK/2480 MHz)										
3264.78	61.87	44.70	6.70	28.20	-9.80	52.07	74.00	-21.93	PK	Vertical
3264.78	50.31	44.70	6.70	28.20	-9.80	40.51	54.00	-13.49	AV	Vertical
3264.75	60.82	44.70	6.70	28.20	-9.80	51.02	74.00	-22.98	PK	Horizontal
3264.75	50.98	44.70	6.70	28.20	-9.80	41.18	54.00	-12.82	AV	Horizontal
4960.28	59.26	44.20	9.04	31.60	-3.56	55.70	74.00	-18.30	PK	Vertical
4960.28	49.75	44.20	9.04	31.60	-3.56	46.19	54.00	-7.81	AV	Vertical
4960.48	59.15	44.20	9.04	31.60	-3.56	55.59	74.00	-18.41	PK	Horizontal
4960.48	50.17	44.20	9.04	31.60	-3.56	46.61	54.00	-7.39	AV	Horizontal
5359.68	48.07	44.20	9.86	32.00	-2.34	45.73	74.00	-28.27	PK	Vertical
5359.68	39.41	44.20	9.86	32.00	-2.34	37.07	54.00	-16.93	AV	Vertical
5359.84	47.54	44.20	9.86	32.00	-2.34	45.20	74.00	-28.80	PK	Horizontal
5359.84	38.29	44.20	9.86	32.00	-2.34	35.95	54.00	-18.05	AV	Horizontal
7439.97	54.16	43.50	11.40	35.50	3.40	57.56	74.00	-16.44	PK	Vertical
7439.97	43.50	43.50	11.40	35.50	3.40	46.90	54.00	-7.10	AV	Vertical
7439.88	53.55	43.50	11.40	35.50	3.40	56.95	74.00	-17.05	PK	Horizontal
7439.88	43.90	43.50	11.40	35.50	3.40	47.30	54.00	-6.70	AV	Horizontal

**Note:**

1) Factor = Antenna Factor + Cable Loss – Pre-amplifier.

Emission Level = Reading + Factor.

2) The frequency emission of peak points that did not show above the forms are at least 20dB below the limit, the frequency emission is mainly from the environment noise.



4.6 TEST RESULTS (Restricted Bands Requirements)

**1M PHY**  
**GFSK-Low**  
Horizontal

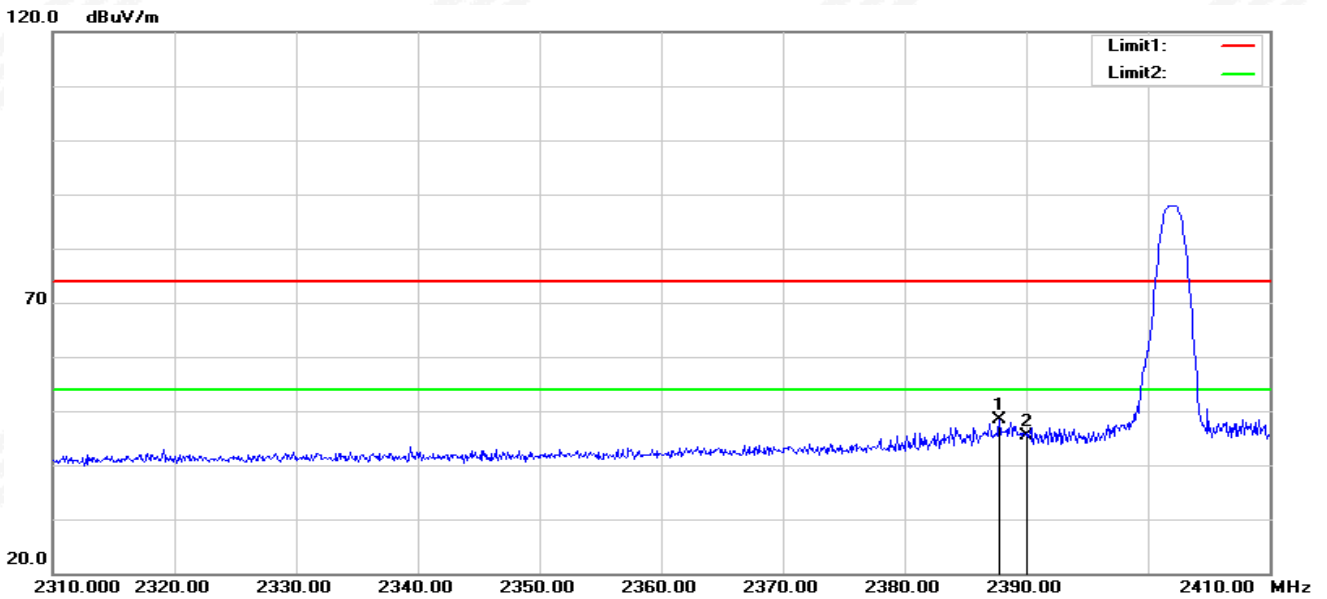

No.	Frequency (MHz)	Reading (dBuV)	Correct Factor(dB/m)	Result (dBuV/m)	Limit (dBuV/m)	Margin (dB)	Remark
1	2387.800	44.11	4.31	48.42	74.00	-25.58	peak
2	2390.000	41.10	4.34	45.44	74.00	-28.56	peak

Vertical

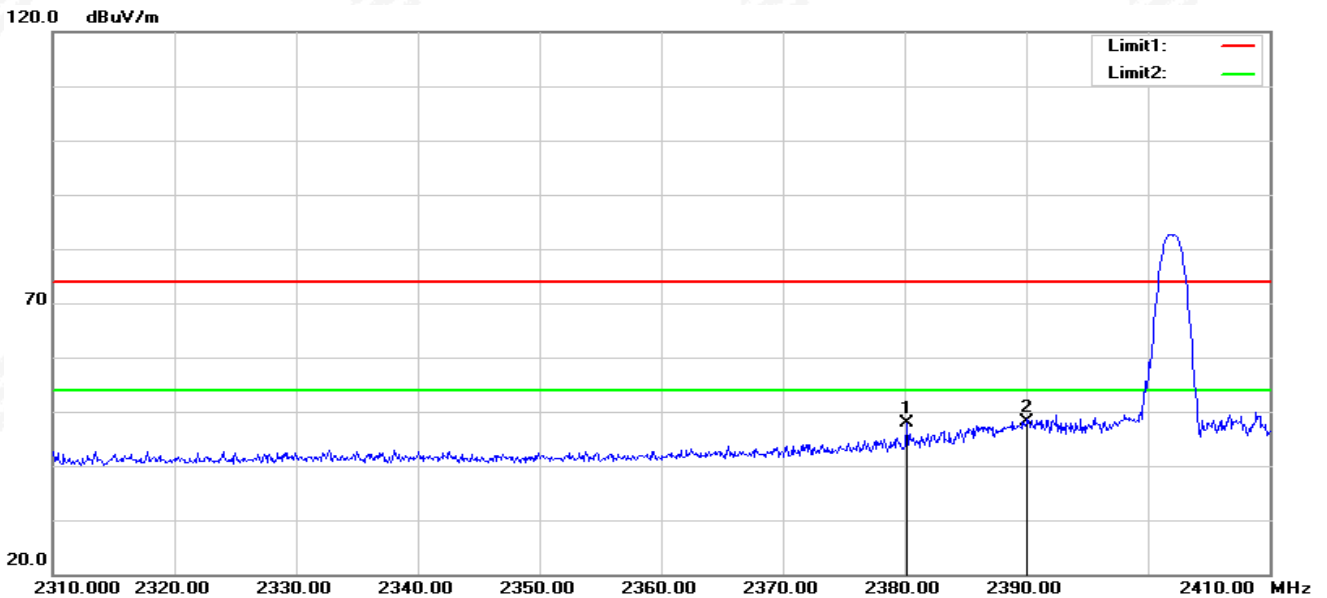

No.	Frequency (MHz)	Reading (dBuV)	Correct Factor(dB/m)	Result (dBuV/m)	Limit (dBuV/m)	Margin (dB)	Remark
1	2380.200	43.74	4.19	47.93	74.00	-26.07	peak
2	2390.000	43.90	4.34	48.24	74.00	-25.76	peak



**GFSK-High  
Horizontal**

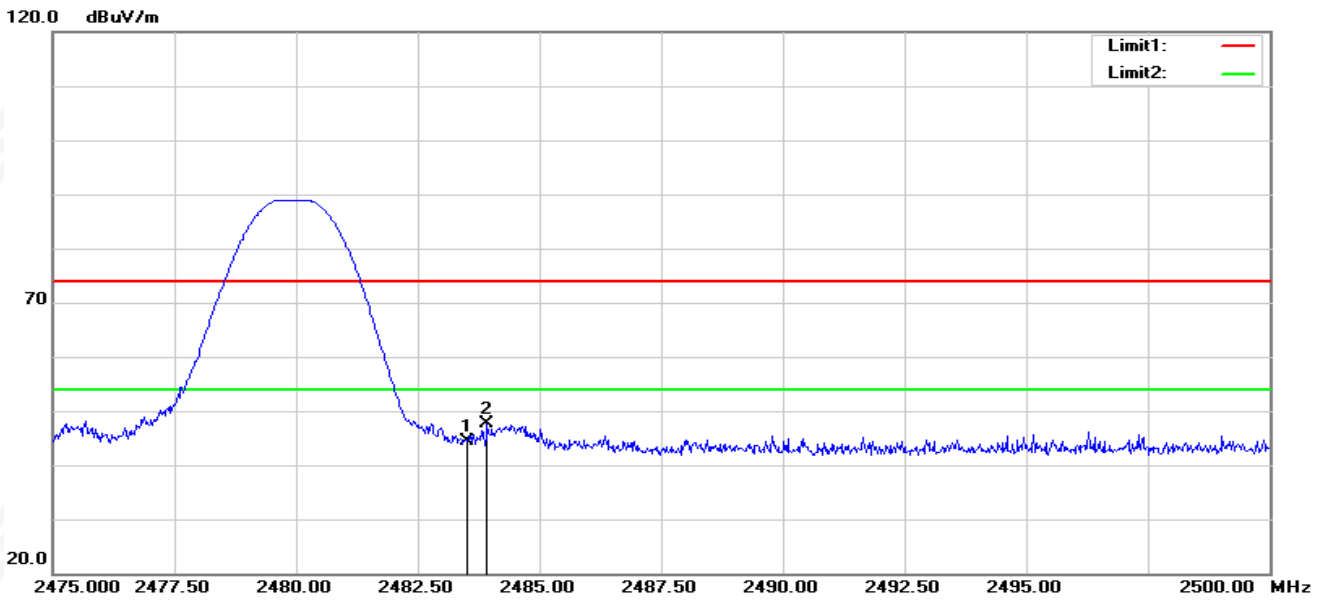

No.	Frequency (MHz)	Reading (dBuV)	Correct Factor(dB/m)	Result (dBuV/m)	Limit (dBuV/m)	Margin (dB)	Remark
1	2483.500	39.73	4.60	44.33	74.00	-29.67	peak
2	2483.925	42.94	4.61	47.55	74.00	-26.45	peak

**Vertical**

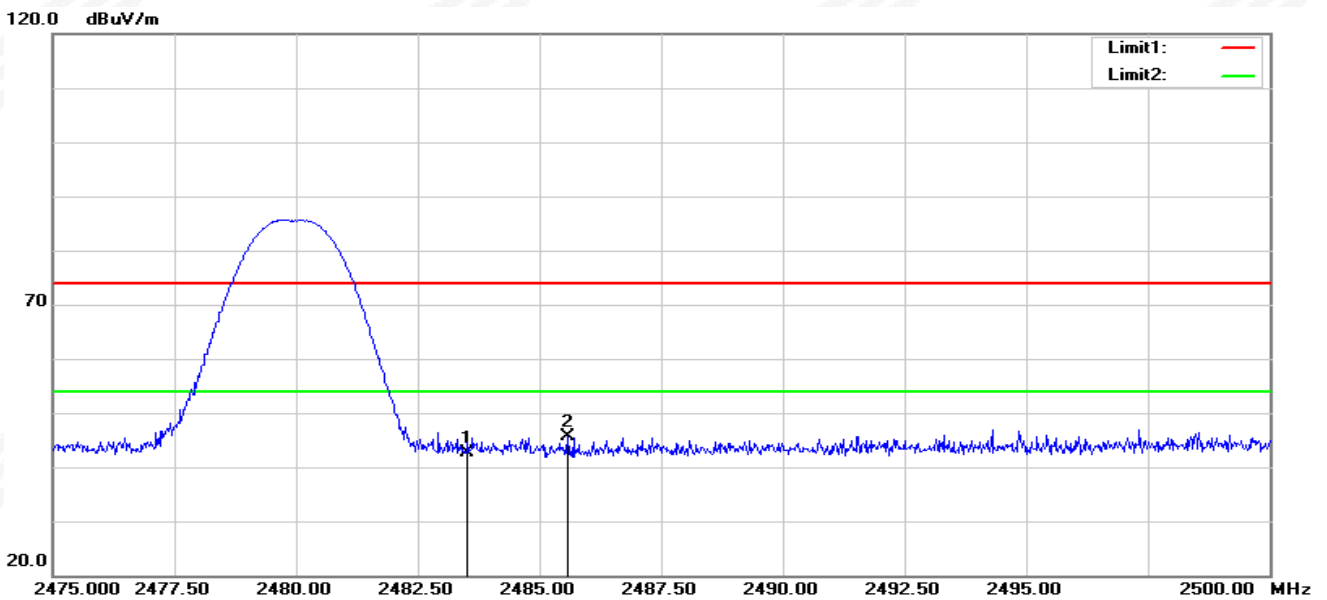

No.	Frequency (MHz)	Reading (dBuV)	Correct Factor(dB/m)	Result (dBuV/m)	Limit (dBuV/m)	Margin (dB)	Remark
1	2483.500	38.14	4.60	42.74	74.00	-31.26	peak
2	2485.575	41.02	4.61	45.63	74.00	-28.37	peak



**2M PHY  
GFSK-Low  
Horizontal**

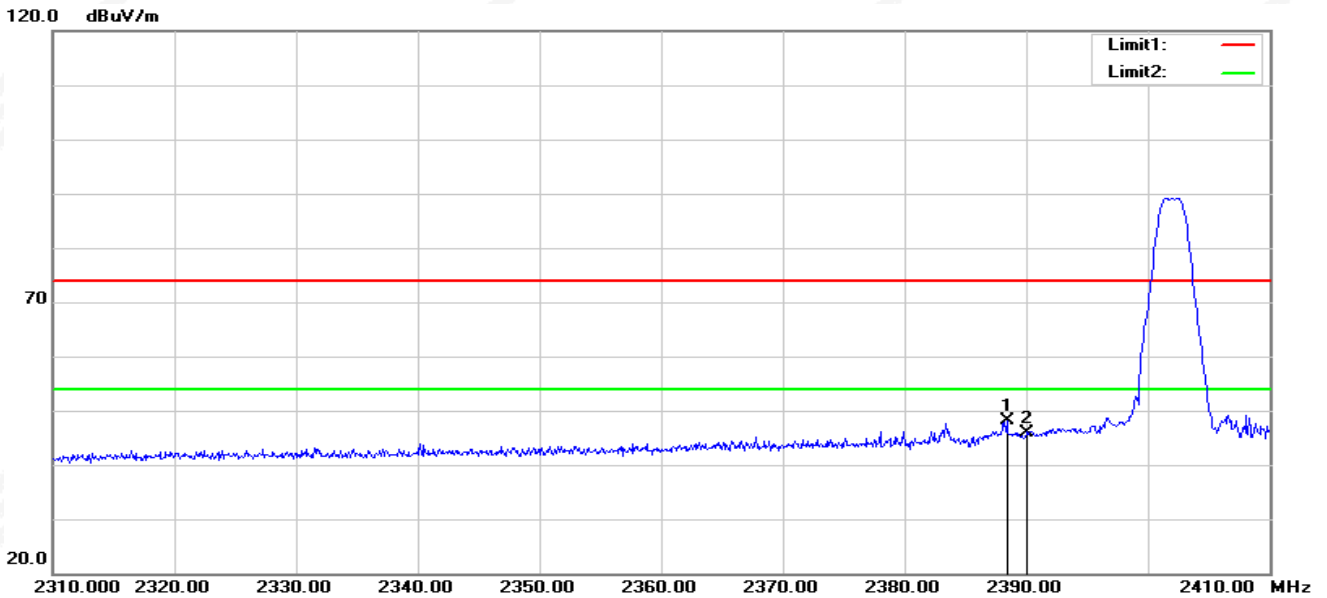

No.	Frequency (MHz)	Reading (dBuV)	Correct Factor(dB/m)	Result (dBuV/m)	Limit (dBuV/m)	Margin (dB)	Remark
1	2388.400	43.84	4.32	48.16	74.00	-25.84	peak
2	2390.000	41.47	4.34	45.81	74.00	-28.19	peak

**Vertical**

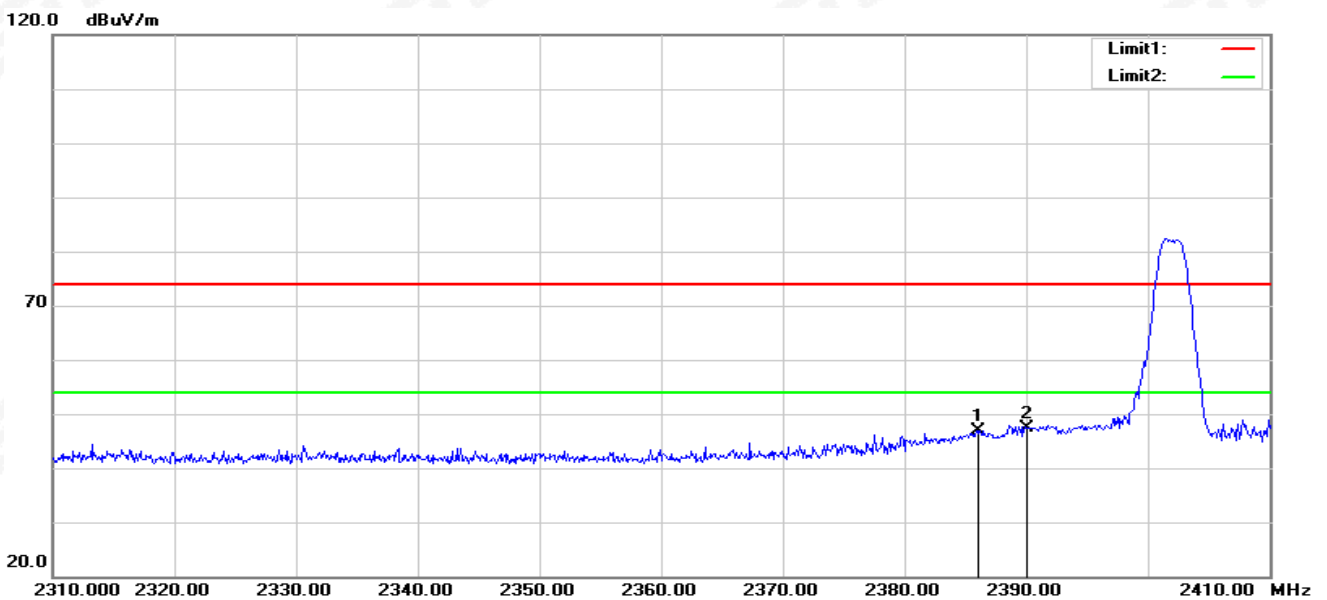

No.	Frequency (MHz)	Reading (dBuV)	Correct Factor(dB/m)	Result (dBuV/m)	Limit (dBuV/m)	Margin (dB)	Remark
1	2386.100	42.66	4.28	46.94	74.00	-27.06	peak
2	2390.000	43.04	4.34	47.38	74.00	-26.62	peak



GFSK-High  
Horizontal

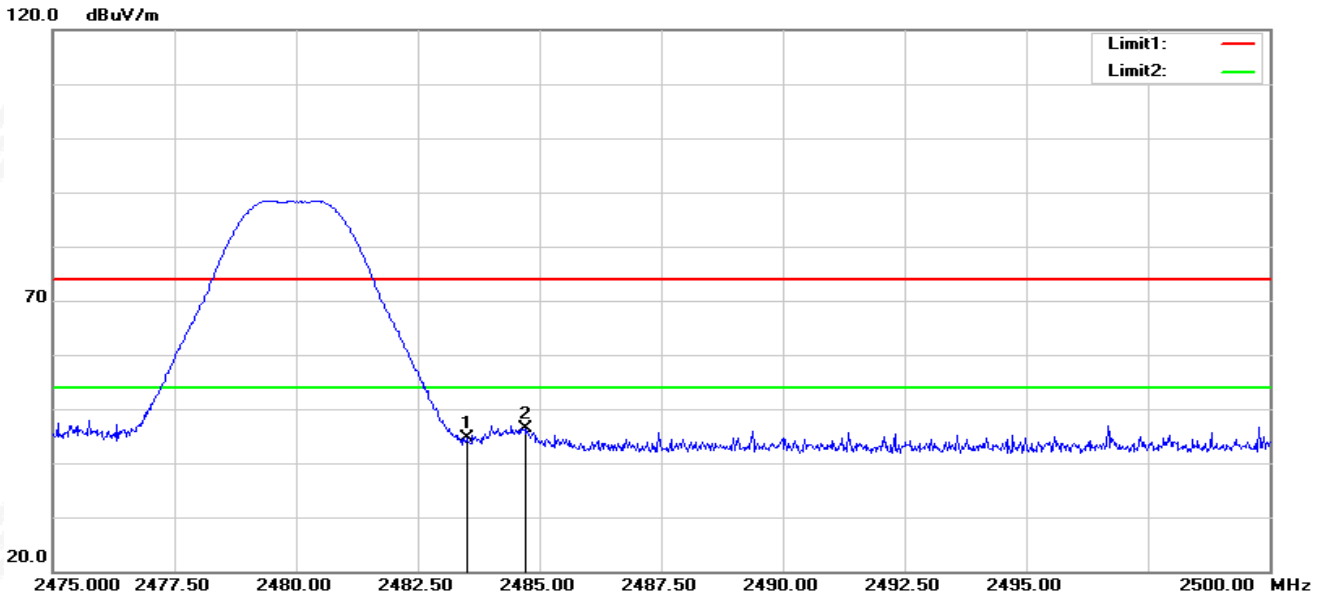

No.	Frequency (MHz)	Reading (dBuV)	Correct Factor(dB/m)	Result (dBuV/m)	Limit (dBuV/m)	Margin (dB)	Remark
1	2483.500	39.93	4.60	44.53	74.00	-29.47	peak
2	2484.700	41.81	4.61	46.42	74.00	-27.58	peak

Vertical

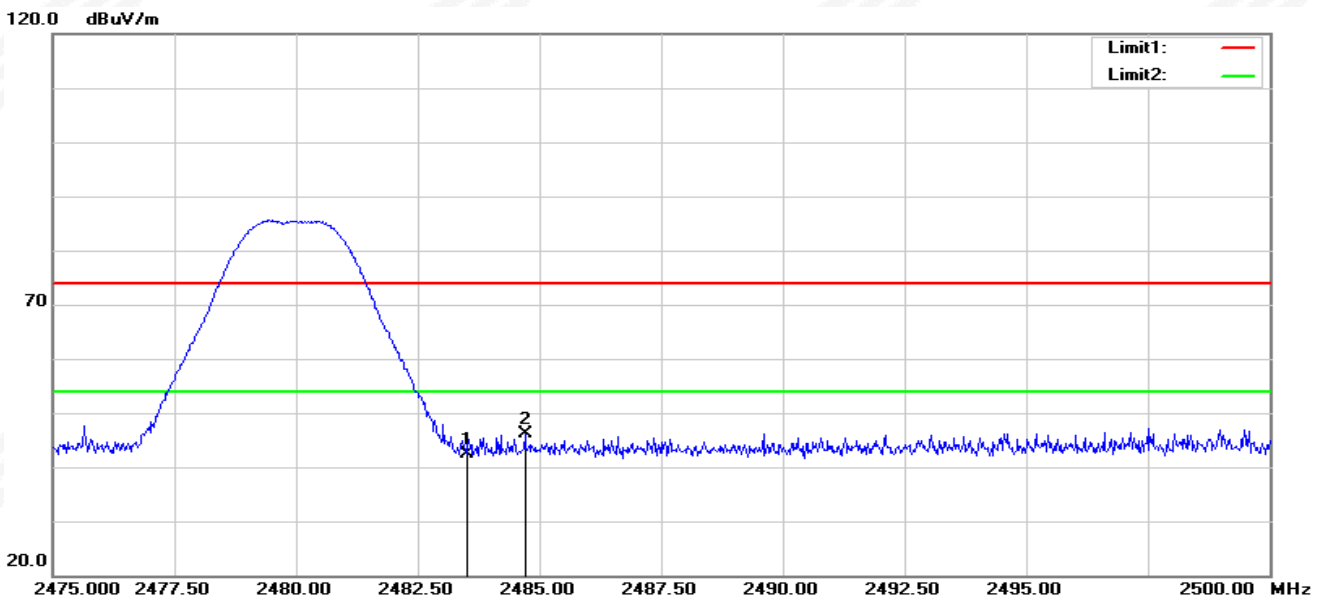

No.	Frequency (MHz)	Reading (dBuV)	Correct Factor(dB/m)	Result (dBuV/m)	Limit (dBuV/m)	Margin (dB)	Remark
1	2483.500	37.68	4.60	42.28	74.00	-31.72	peak
2	2484.700	41.48	4.61	46.09	74.00	-27.91	peak

## 5. CONDUCTED SPURIOUS & BAND EDGE EMISSION

### 5.1 LIMIT

According to FCC section 15.247(d), in any 100kHz bandwidth outside the frequency band in which the spread spectrum or digitally modulated intentional radiator is operating, the radio frequency power that is produced by the intentional radiator shall be at least 20dB below that in the 100kHz bandwidth within the band that contains the highest level of the desired power, based on either an RF conducted or a radiated measurement.

### 5.2 TEST PROCEDURE

Spectrum Parameter	Setting
Detector	Peak
Start/Stop Frequency	30 MHz to 10th carrier harmonic
RB / VB (emission in restricted band)	100 KHz/300 KHz
Trace-Mode:	Max hold

For Band edge

Spectrum Parameter	Setting
Detector	Peak
Start/Stop Frequency	Lower Band Edge: 2300 – 2407 MHz Upper Band Edge: 2475 – 2500 MHz
RB / VB (emission in restricted band)	100 KHz/300 KHz
Trace-Mode:	Max hold

### 5.3 TEST SETUP



The EUT is connected to the Spectrum Analyzer; the RF load attached to the EUT antenna terminal is 50 Ohm; the path loss as the factor is calibrated to correct the reading. Make the measurement with the spectrum analyzer's resolution bandwidth(RBW) = 100 kHz. In order to make an accurate measurement, set the span greater than RBW.

### 5.4 EUT OPERATION CONDITIONS

Please refer to section 3.4 of this report.

### 5.5 TEST RESULTS

Note: The test data please refer to APPENDIX 1.

## 6. POWER SPECTRAL DENSITY TEST

### 6.1 LIMIT

FCC Part 15.247, Subpart C				
Section	Test Item	Limit	Frequency Range (MHz)	Result
15.247(e)	Power Spectral Density	$\leq 8$ dBm (RBW $\geq 3$ kHz)	2400-2483.5	PASS

### 6.2 TEST PROCEDURE

1. Set analyzer center frequency to DTS channel center frequency.
2. Set the span to 1.5 times the DTS channel bandwidth.
3. Set the RBW to:  $100 \text{ kHz} \geq \text{RBW} \geq 3 \text{ kHz}$ .
4. Set the VBW  $\geq 3 \times \text{RBW}$ .
5. Detector = peak.
6. Sweep time = auto couple.
7. Trace mode = max hold.
8. Allow trace to fully stabilize.
9. Use the peak marker function to determine the maximum amplitude level.
10. If measured value exceeds limit, reduce RBW (no less than 3 kHz) and repeat.

### 6.3 TEST SETUP



### 6.4 EUT OPERATION CONDITIONS

Please refer to section 3.4 of this report.

### 6.5 TEST RESULTS

Note: The test data please refer to APPENDIX 1.

## 7. BANDWIDTH TEST

### 7.1 LIMIT

FCC Part 15.247, Subpart C				
Section	Test Item	Limit	Frequency Range (MHz)	Result
15.247(a)(2)	Bandwidth	$\geq 500\text{kHz}$ (6dB bandwidth)	2400-2483.5	PASS

### 7.2 TEST PROCEDURE

The automatic bandwidth measurement capability of an instrument may be employed using the X dB bandwidth mode with X set to 6 dB, if the functionality described above (i.e., RBW = 100 kHz, VBW  $\geq 3$ RBW, peak detector with maximum hold) is implemented by the instrumentation function. When using this capability, care shall be taken so that the bandwidth measurement is not influenced by any intermediate power nulls in the fundamental emission that might be  $\geq 6$  dB.

### 7.3 TEST SETUP



### 7.4 EUT OPERATION CONDITIONS

Please refer to section 3.4 of this report.

### 7.5 TEST RESULTS

Note: The test data please refer to APPENDIX 1.

## 8. PEAK OUTPUT POWER TEST

### 8.1 LIMIT

FCC Part 15.247, Subpart C				
Section	Test Item	Limit	Frequency Range (MHz)	Result
15.247(b)(3)	Output Power	1 watt or 30dBm	2400-2483.5	PASS

### 8.2 TEST PROCEDURE

One of the following procedures may be used to determine the averaging conducted output power of a DTS EUT.

Method AVGSA-2 uses trace averaging across ON and OFF times of the EUT transmissions, followed by duty cycle correction. The procedure for this method is as follows:

- a) Measure the duty cycle D of the transmitter output signal as described in 11.6.
- b) Set span to at least 1.5 times the OBW.
- c) Set RBW = 1% to 5% of the OBW, not to exceed 1 MHz.
- d) Set VBW  $\geq [3 \times \text{RBW}]$ .
- e) Number of points in sweep  $\geq [2 \times \text{span} / \text{RBW}]$ . (This gives bin-to-bin spacing  $\leq \text{RBW} / 2$ , so that narrowband signals are not lost between frequency bins.)
- f) Sweep time = auto.
- g) Detector = RMS (i.e., power averaging), if available. Otherwise, use the sample detector mode.
- h) Do not use sweep triggering. Allow the sweep to "free run."
- i) Trace average at least 100 traces in power averaging (rms) mode; however, the number of traces to be averaged shall be increased above 100 as needed such that the average accurately represents the true average over the ON and OFF periods of the transmitter.
- j) Compute power by integrating the spectrum across the OBW of the signal using the instrument's band power measurement function with band limits set equal to the OBW band edges. If the instrument does not have a band power function, then sum the spectrum levels (in power units) at intervals equal to the RBW extending across the entire OBW of the spectrum.
- k) Add  $[10 \log (1 / D)]$ , where D is the duty cycle, to the measured power to compute the average power during the actual transmission times (because the measurement represents an average over both the ON and OFF times of the transmission). For example, add  $[10 \log (1/0.25)] = 6 \text{ dB}$  if the duty cycle is 25%.

One of the following procedures may be used to determine the maximum peak conducted output power of a DTS EUT.

$\text{RBW} \geq \text{DTS bandwidth}$

The following procedure shall be used when an instrument with a resolution bandwidth that is greater than the DTS bandwidth is available to perform the measurement:

- a) Set the  $\text{RBW} \geq \text{DTS bandwidth}$ .
- b) Set  $\text{VBW} \geq [3 \times \text{RBW}]$ .
- c) Set  $\text{span} \geq [3 \times \text{RBW}]$ .
- d) Sweep time = auto couple.
- e) Detector = peak.
- f) Trace mode = max hold.
- g) Allow trace to fully stabilize.
- h) Use peak marker function to determine the peak amplitude level.

Integrated band power method:

The following procedure can be used when the maximum available RBW of the instrument is less than the

DTS bandwidth:

- a) Set the RBW = 1 MHz.
- b) Set the VBW  $\geq [3 \times \text{RBW}]$ .
- c) Set the span  $\geq [1.5 \times \text{DTS bandwidth}]$ .
- d) Detector = peak.
- e) Sweep time = auto couple.
- f) Trace mode = max hold.
- g) Allow trace to fully stabilize.
- h) Use the instrument's band/channel power measurement function with the band limits set equal to the DTS bandwidth edges (for some instruments, this may require a manual override to select the peak detector). If the instrument does not have a band power function, then sum the spectrum levels (in linear power units) at intervals equal to the RBW extending across the DTS channel bandwidth.

PKPM1 Peak power meter method:

The maximum peak conducted output power may be measured using a broadband peak RF power meter. The power meter shall have a video bandwidth that is greater than or equal to the DTS bandwidth and shall use a fast-responding diode detector.

### 8.3 TEST SETUP

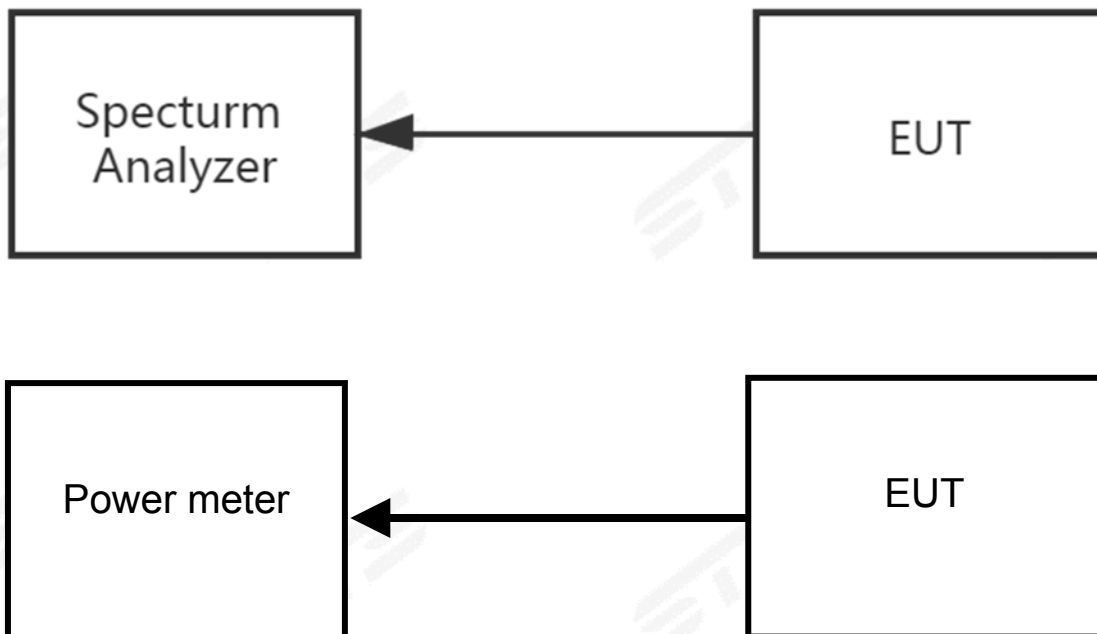

### 8.4 EUT OPERATION CONDITIONS

Please refer to section 3.4 of this report.

### 8.5 TEST RESULTS

Note: The test data please refer to APPENDIX 1.





## 9. ANTENNA REQUIREMENT

### 9.1 STANDARD REQUIREMENT

15.203 requirement: For intentional device, according to 15.203: an intentional radiator shall be designed to ensure that no antenna other than that furnished by the responsible party shall be used with the device.

### 9.2 EUT ANTENNA

The EUT antenna is PCB Antenna. It comply with the standard requirement.



APPENDIX 1-TEST DATA

### 1. Duty Cycle

Condition	Mode	Frequency (MHz)	Duty Cycle (%)	Correction Factor (dB)	1/T (kHz)
NVNT	BLE 1M	2402	66.24	1.79	2.41
NVNT	BLE 1M	2440	66.2	1.79	2.42
NVNT	BLE 1M	2480	66.07	1.8	2.42
NVNT	BLE 2M	2402	36.16	4.42	4.42
NVNT	BLE 2M	2440	36.32	4.4	4.41
NVNT	BLE 2M	2480	36.16	4.42	4.42



### Test Graphs Duty Cycle NVNT BLE 1M 2402MHz

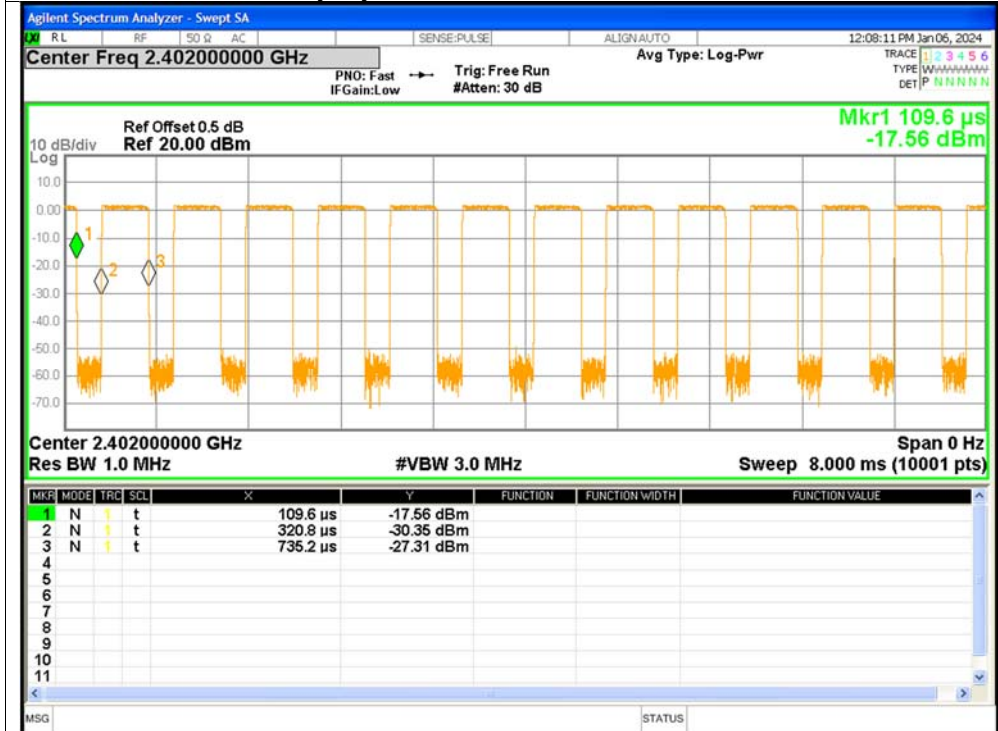

### Duty Cycle NVNT BLE 1M 2440MHz

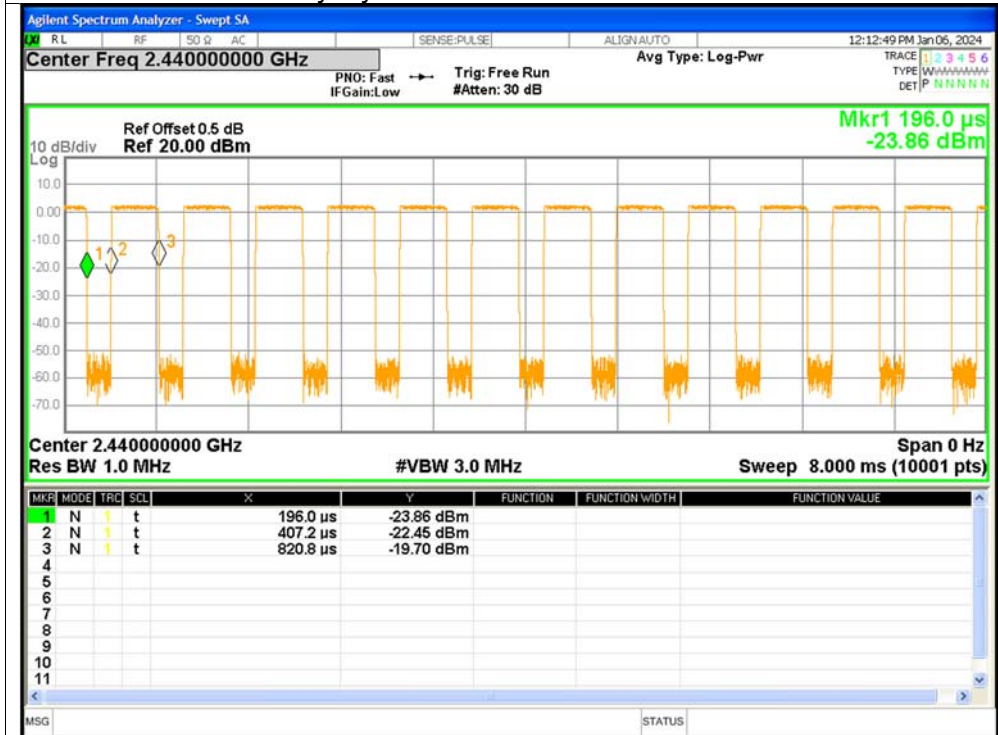







## 2. Maximum Average Conducted Output Power

Condition	Mode	Frequency (MHz)	Conducted Power (dBm)	Duty Factor (dB)	Total Power (dBm)	Limit (dBm)	Verdict
NVNT	BLE 1M	2402	-0.31	1.79	1.48	<=30	Pass
NVNT	BLE 1M	2440	0.35	1.79	2.14	<=30	Pass
NVNT	BLE 1M	2480	-0.17	1.8	1.63	<=30	Pass
NVNT	BLE 2M	2402	-2.82	4.42	1.6	<=30	Pass
NVNT	BLE 2M	2440	-2.33	4.4	2.07	<=30	Pass
NVNT	BLE 2M	2480	-2.96	4.42	1.46	<=30	Pass

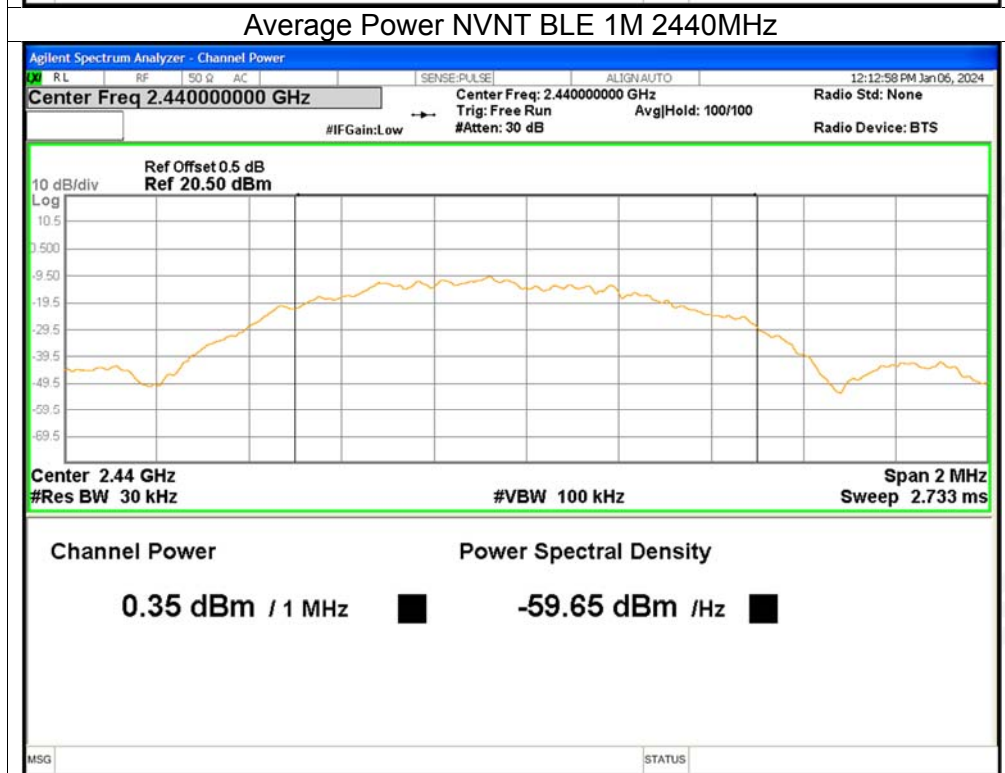
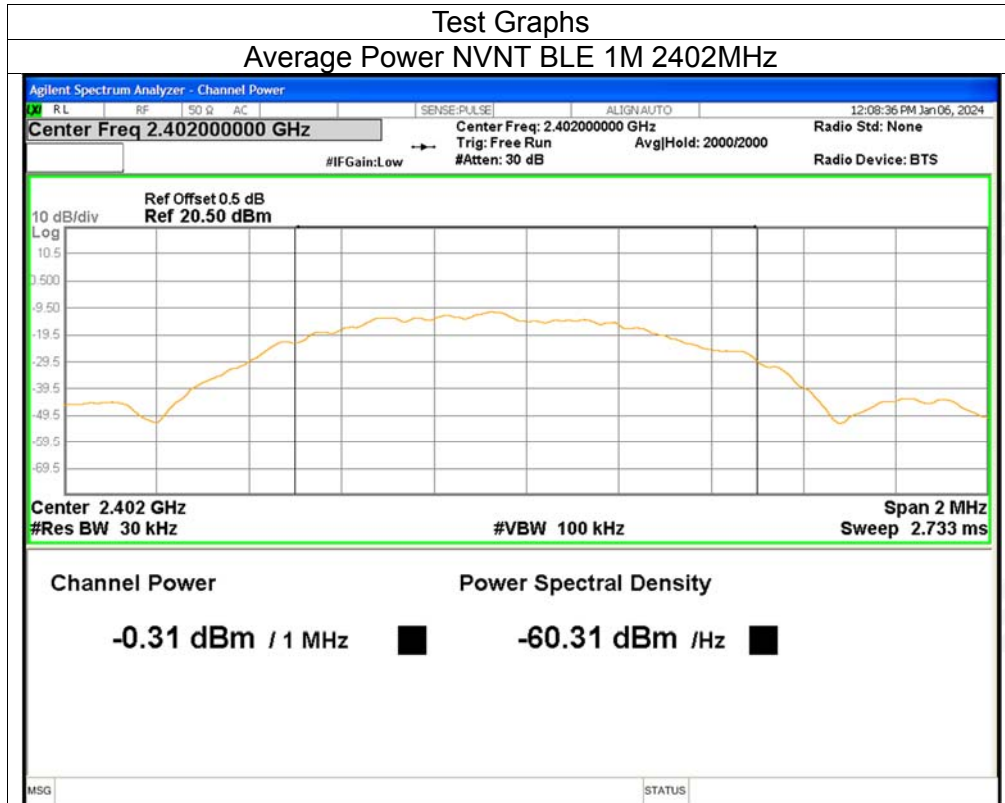



### Average Power NVNT BLE 1M 2480MHz

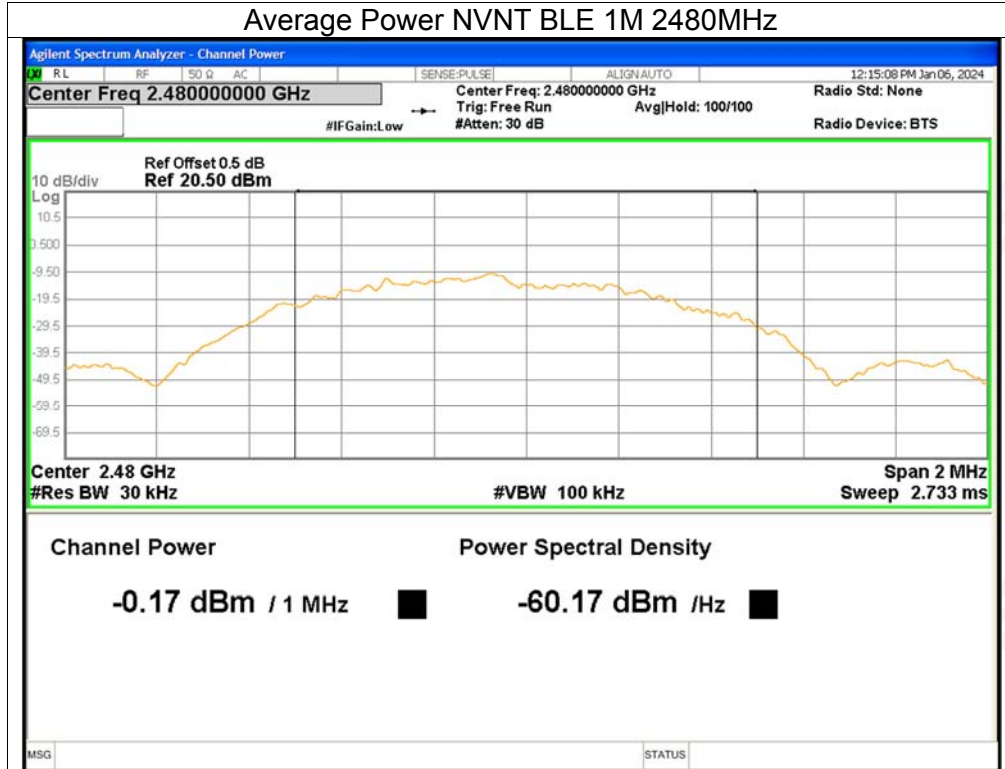

### Average Power NVNT BLE 2M 2402MHz

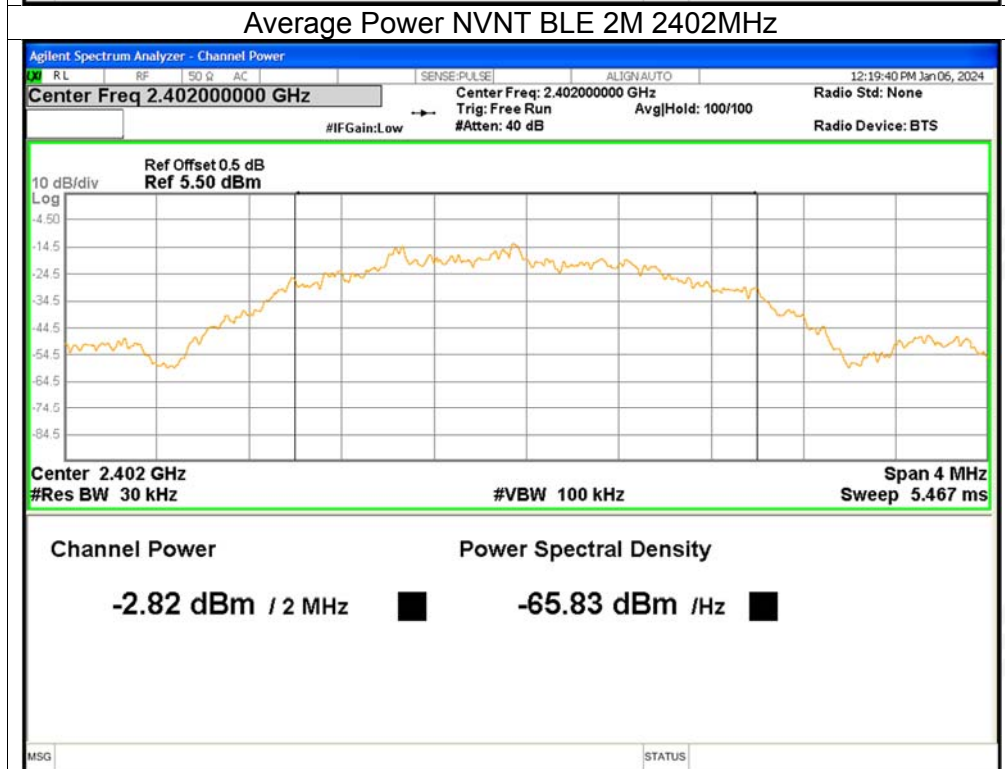





### Average Power NVNT BLE 2M 2440MHz

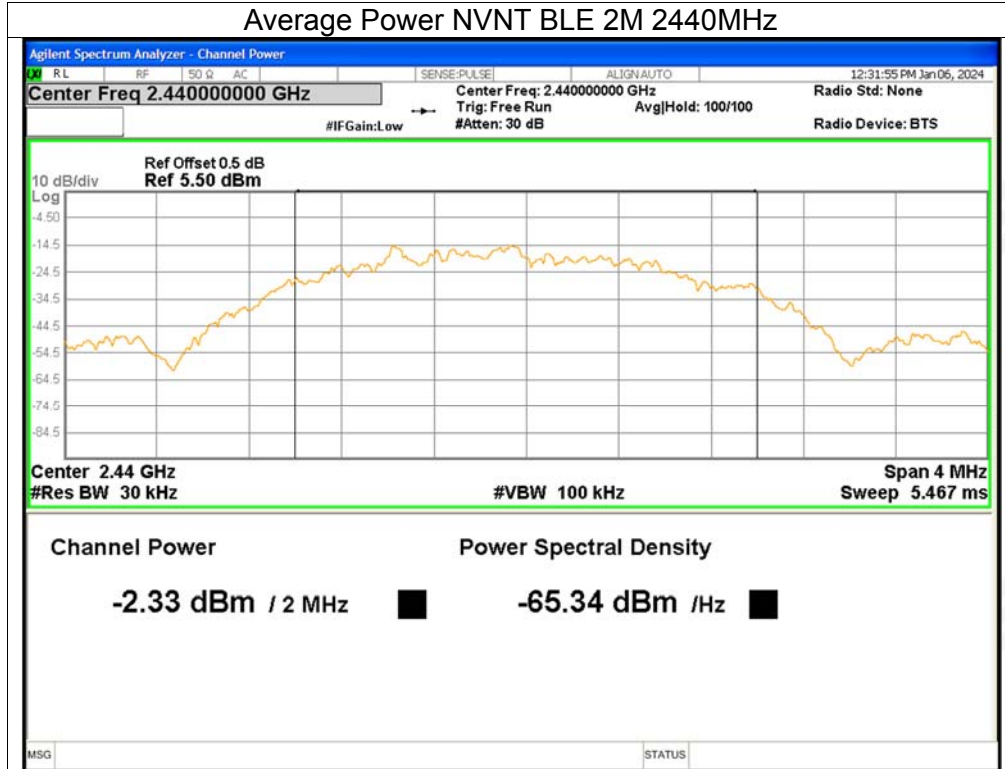

### Average Power NVNT BLE 2M 2480MHz

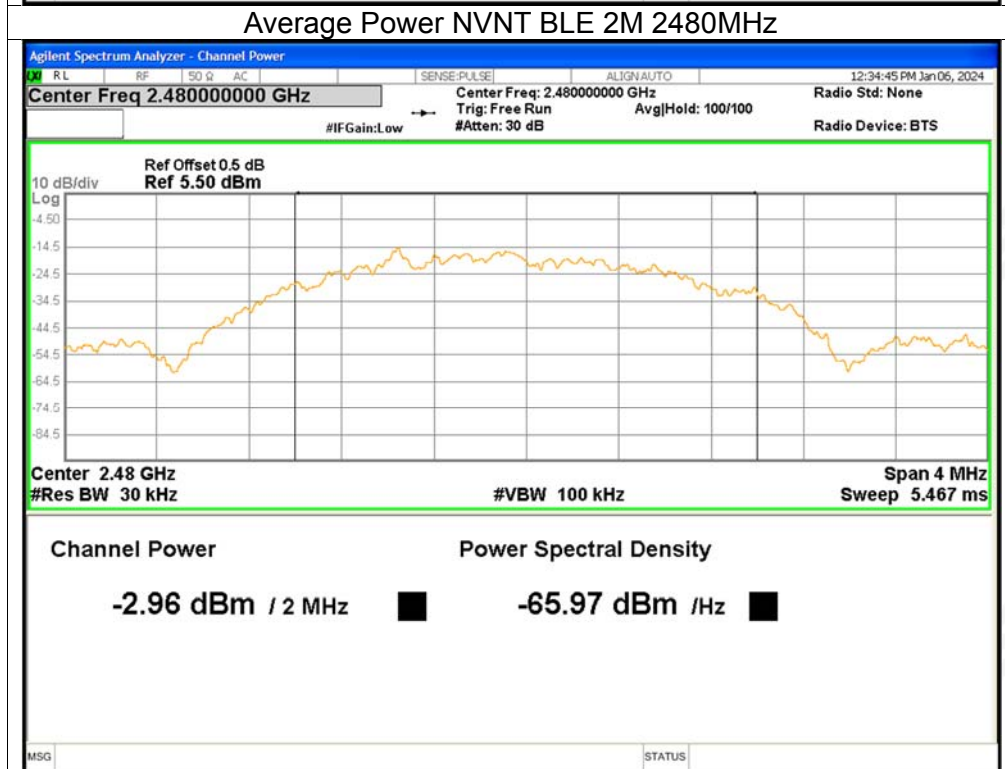



### 3. Maximum Peak Conducted Output Power

Condition	Mode	Frequency (MHz)	Conducted Power (dBm)	Limit (dBm)	Verdict
NVNT	BLE 1M	2402	2.01	<=30	Pass
NVNT	BLE 1M	2440	2.64	<=30	Pass
NVNT	BLE 1M	2480	2.13	<=30	Pass
NVNT	BLE 2M	2402	2.05	<=30	Pass
NVNT	BLE 2M	2440	2.63	<=30	Pass
NVNT	BLE 2M	2480	2.1	<=30	Pass

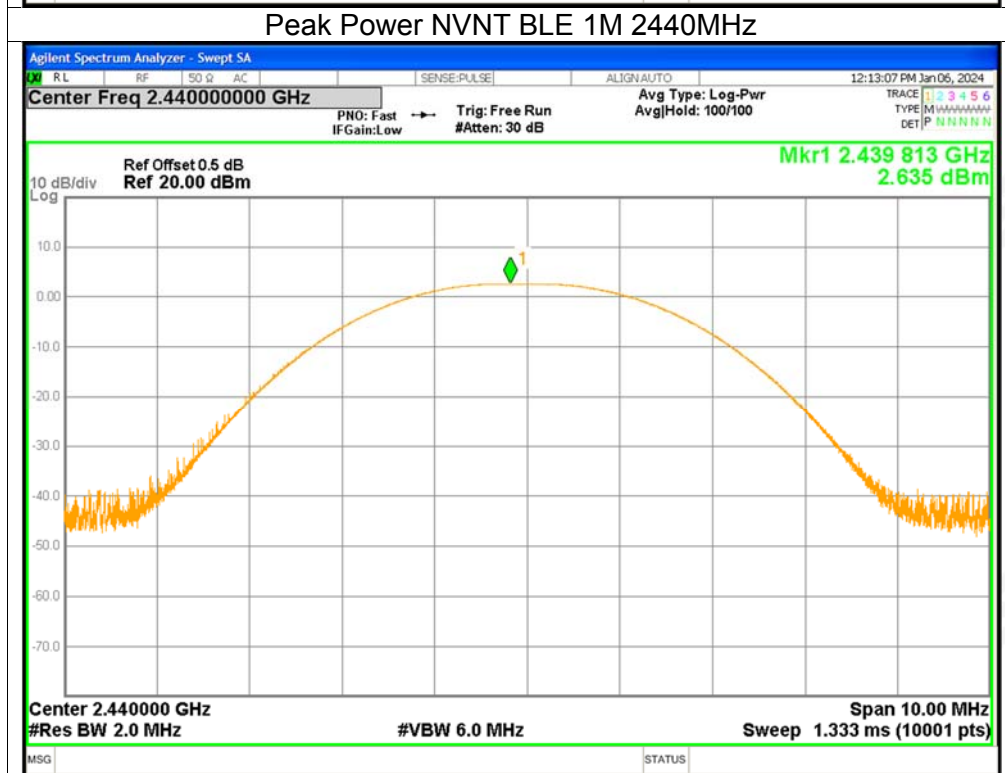
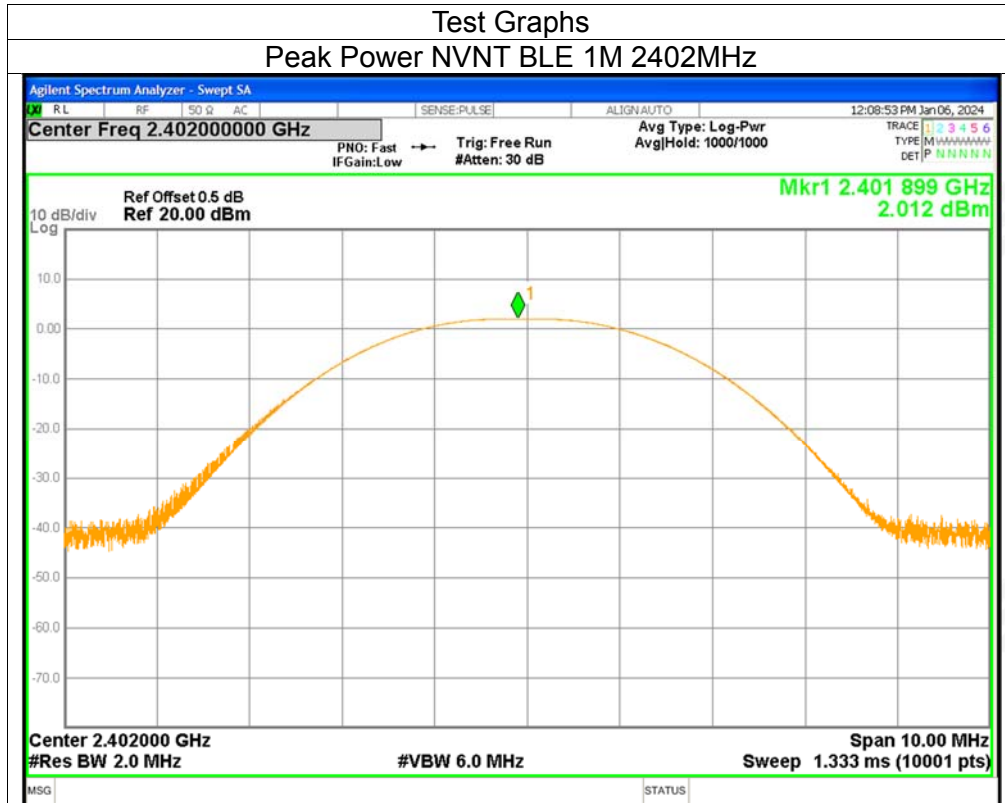



### Peak Power NVNT BLE 1M 2480MHz

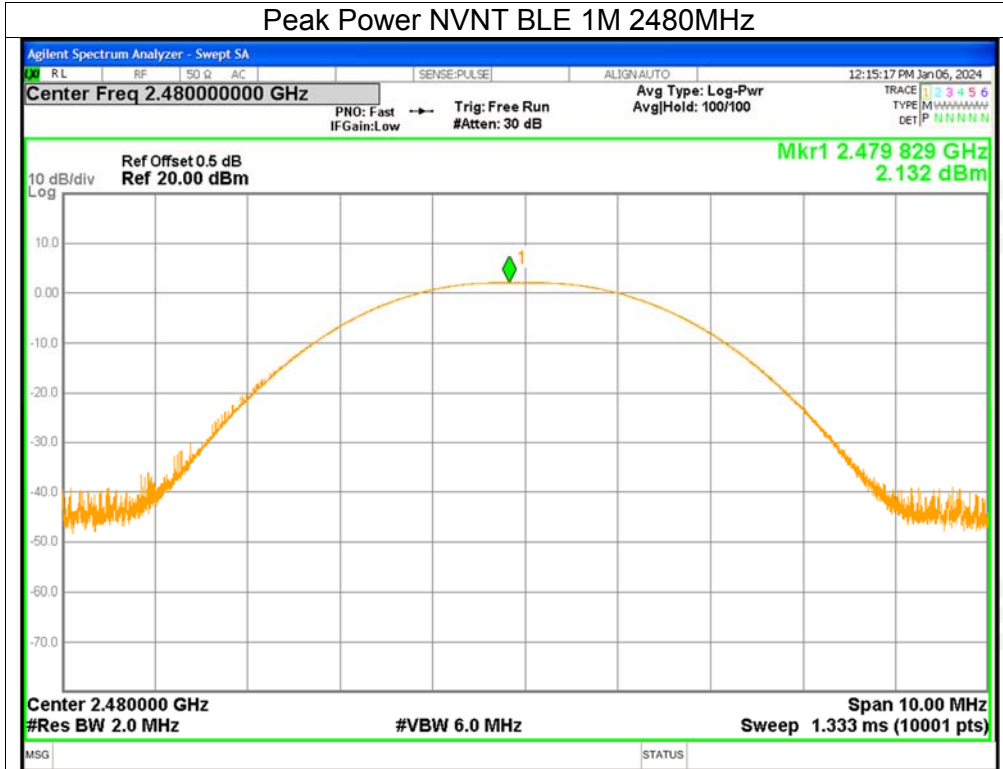

### Peak Power NVNT BLE 2M 2402MHz

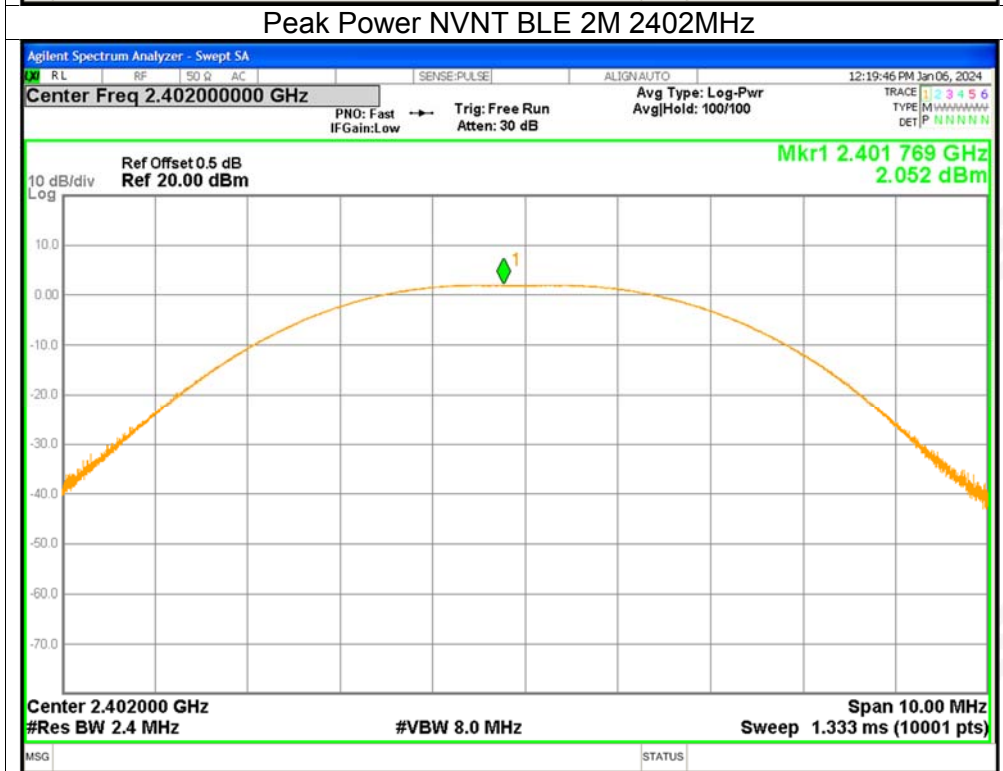



### Peak Power NVNT BLE 2M 2440MHz

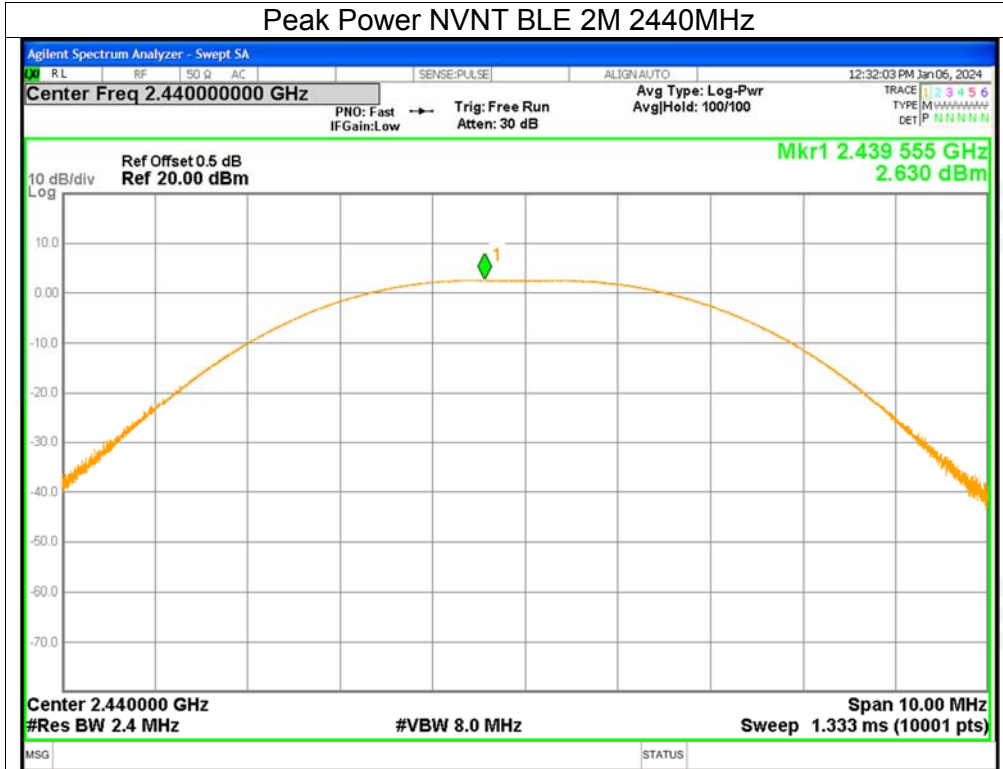

### Peak Power NVNT BLE 2M 2480MHz

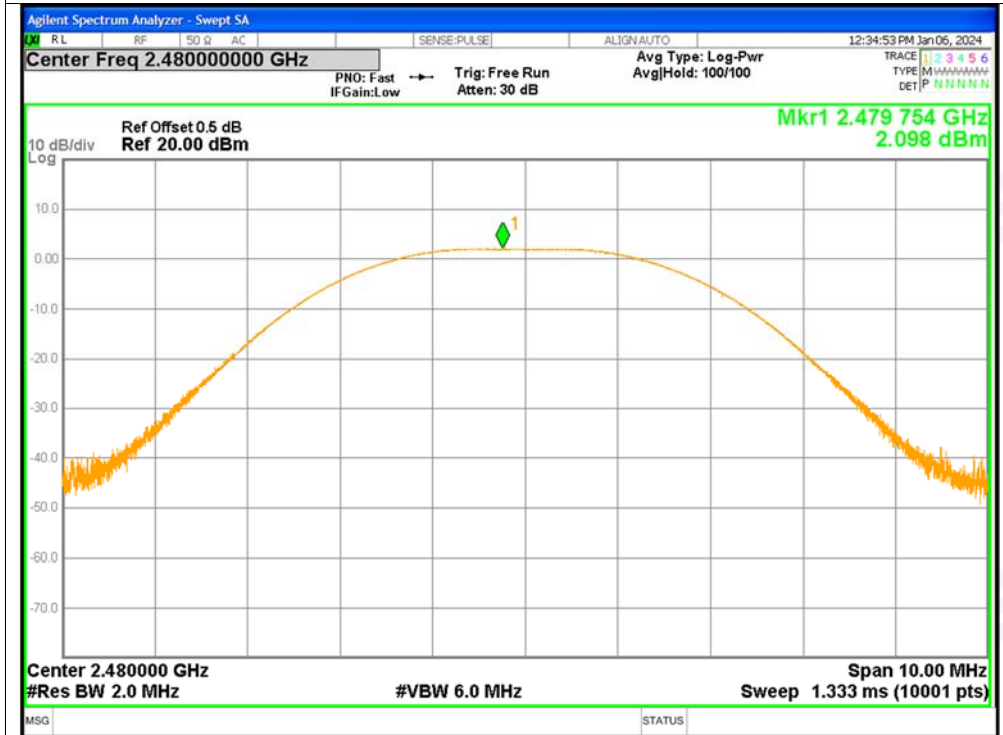



#### 4. -6dB Bandwidth

Condition	Mode	Frequency (MHz)	-6 dB Bandwidth (MHz)	Limit -6 dB Bandwidth (MHz)	Verdict
NVNT	BLE 1M	2402	0.6618	$\geq 0.5$	Pass
NVNT	BLE 1M	2440	0.6451	$\geq 0.5$	Pass
NVNT	BLE 1M	2480	0.6426	$\geq 0.5$	Pass
NVNT	BLE 2M	2402	1.0752	$\geq 0.5$	Pass
NVNT	BLE 2M	2440	1.1411	$\geq 0.5$	Pass
NVNT	BLE 2M	2480	1.1314	$\geq 0.5$	Pass

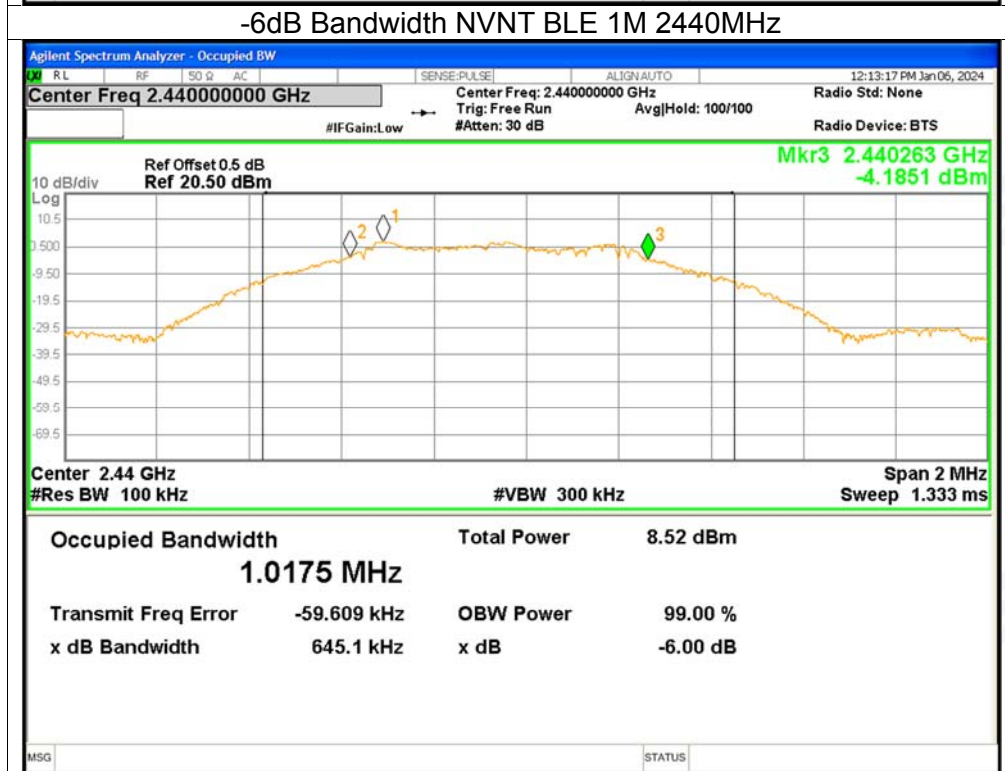
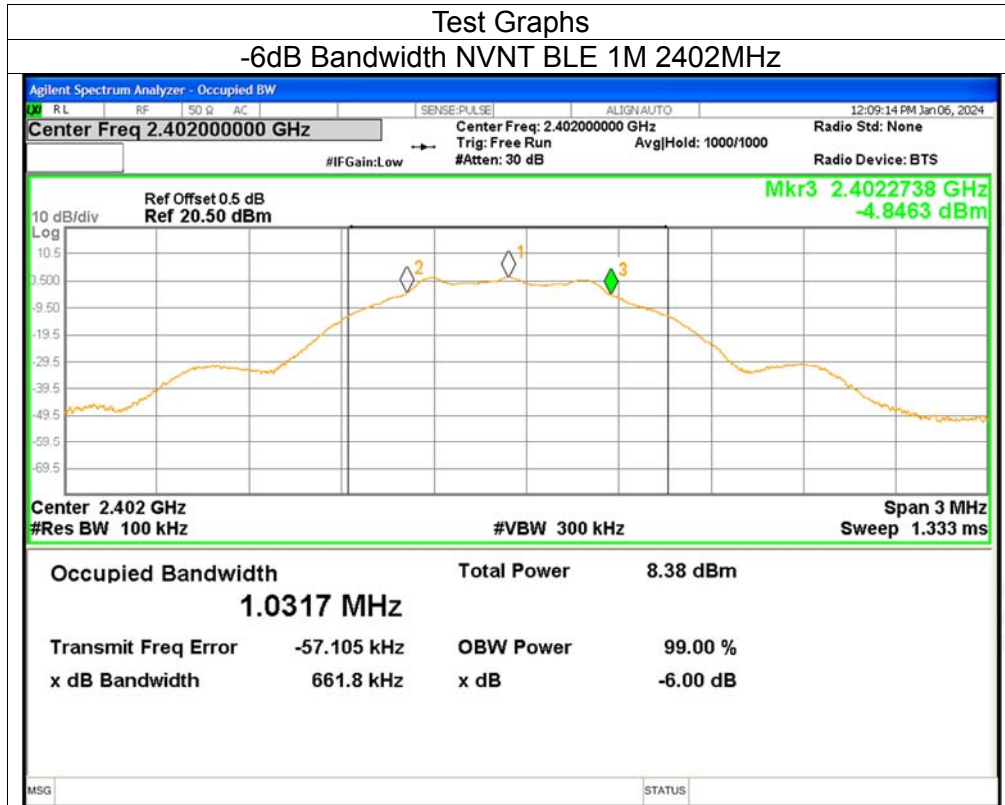



### -6dB Bandwidth NVNT BLE 1M 2480MHz



### -6dB Bandwidth NVNT BLE 2M 2402MHz

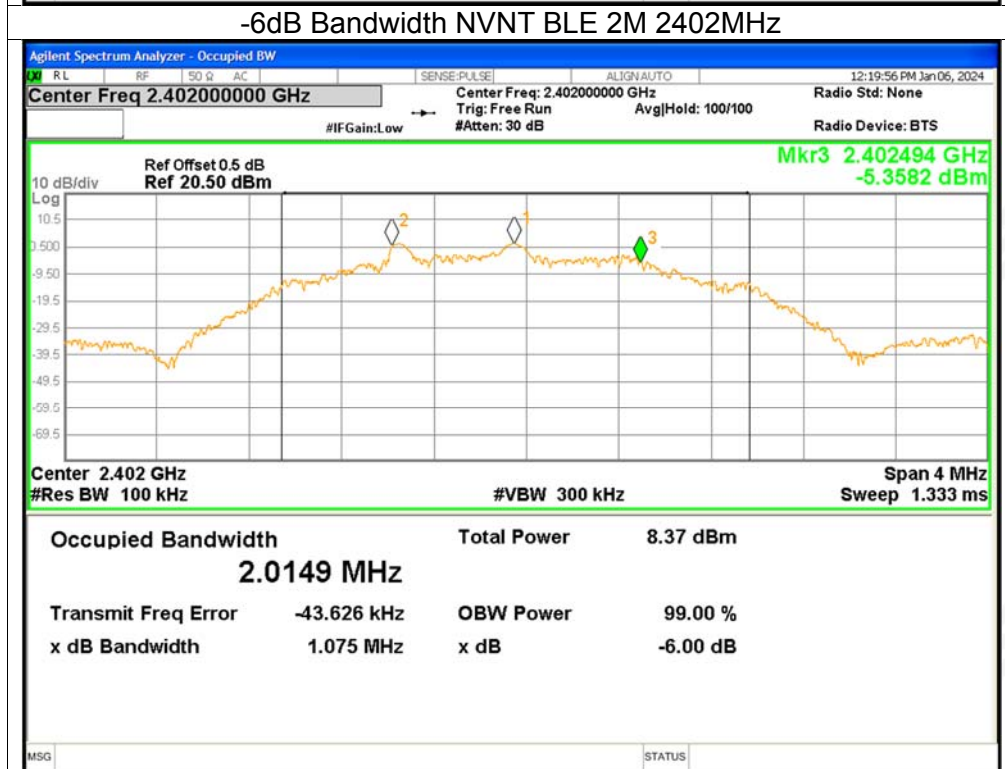





### -6dB Bandwidth NVNT BLE 2M 2440MHz



### -6dB Bandwidth NVNT BLE 2M 2480MHz

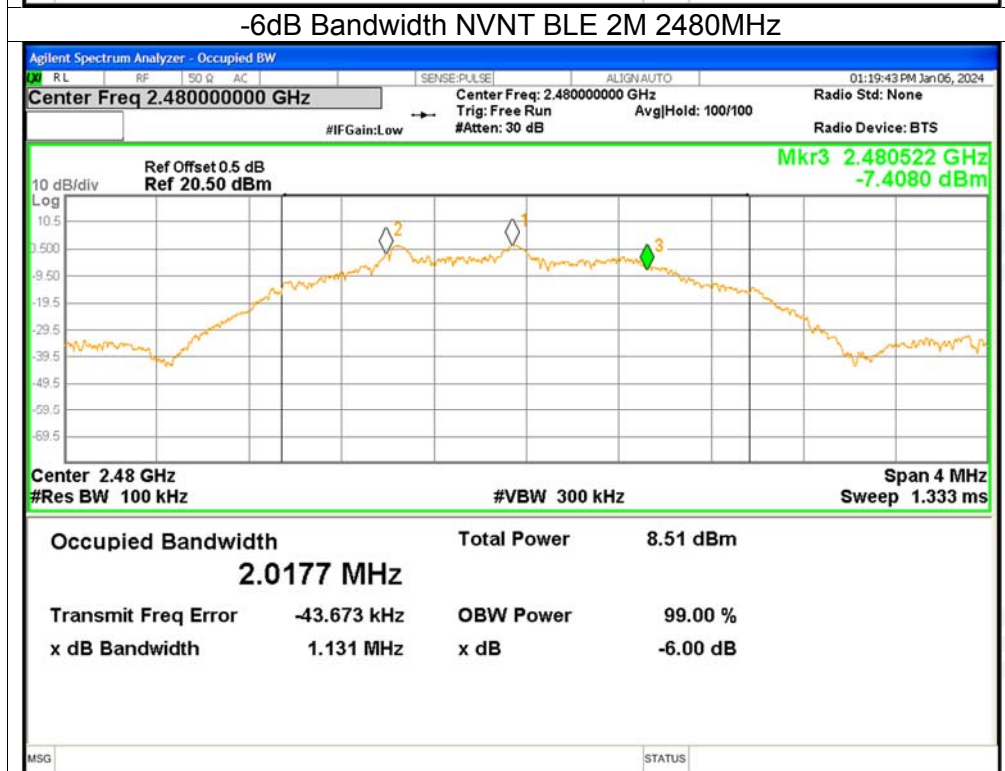



## 5. Maximum Power Spectral Density Level

Condition	Mode	Frequency (MHz)	PSD (dBm/3kHz)	Limit (dBm/3kHz)	Verdict
NVNT	BLE 1M	2402	-13.73	$\leq 8$	Pass
NVNT	BLE 1M	2440	-12.87	$\leq 8$	Pass
NVNT	BLE 1M	2480	-13.34	$\leq 8$	Pass
NVNT	BLE 2M	2402	-16.25	$\leq 8$	Pass
NVNT	BLE 2M	2440	-15.58	$\leq 8$	Pass
NVNT	BLE 2M	2480	-16.17	$\leq 8$	Pass

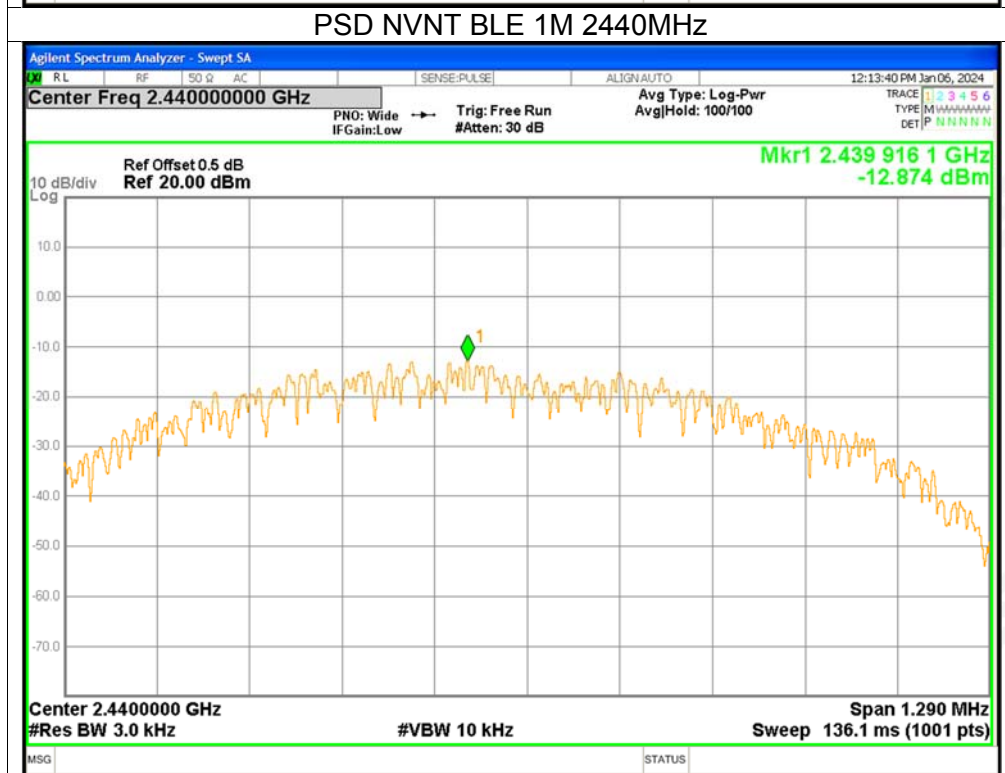
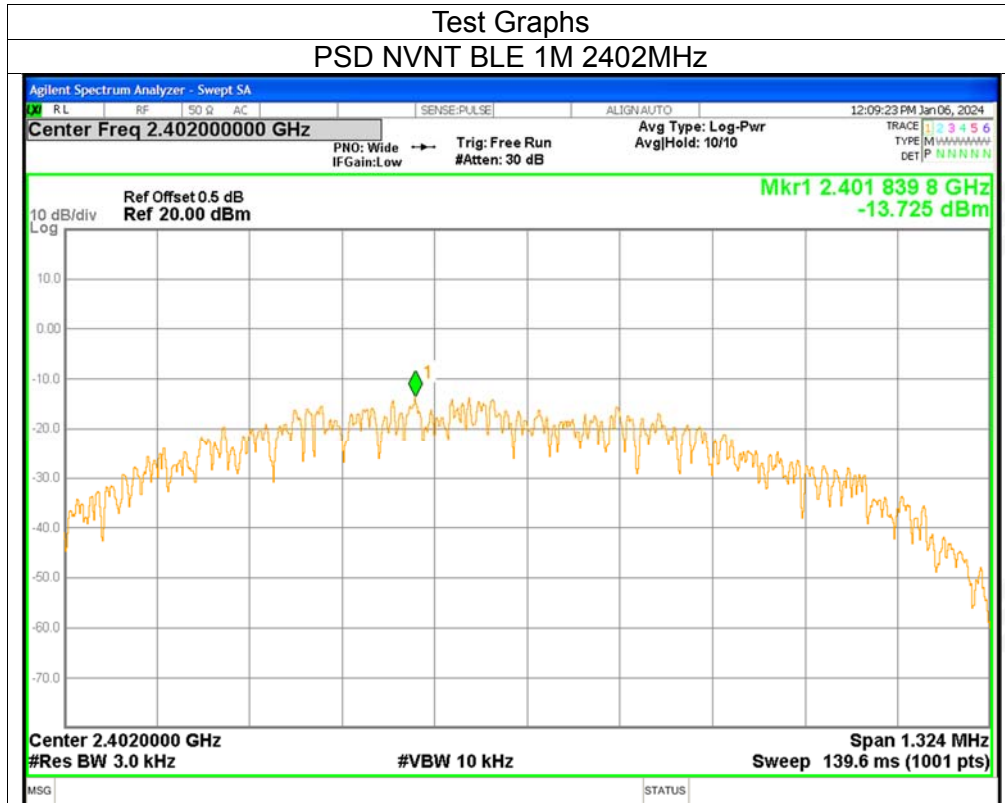



### PSD NVNT BLE 1M 2480MHz

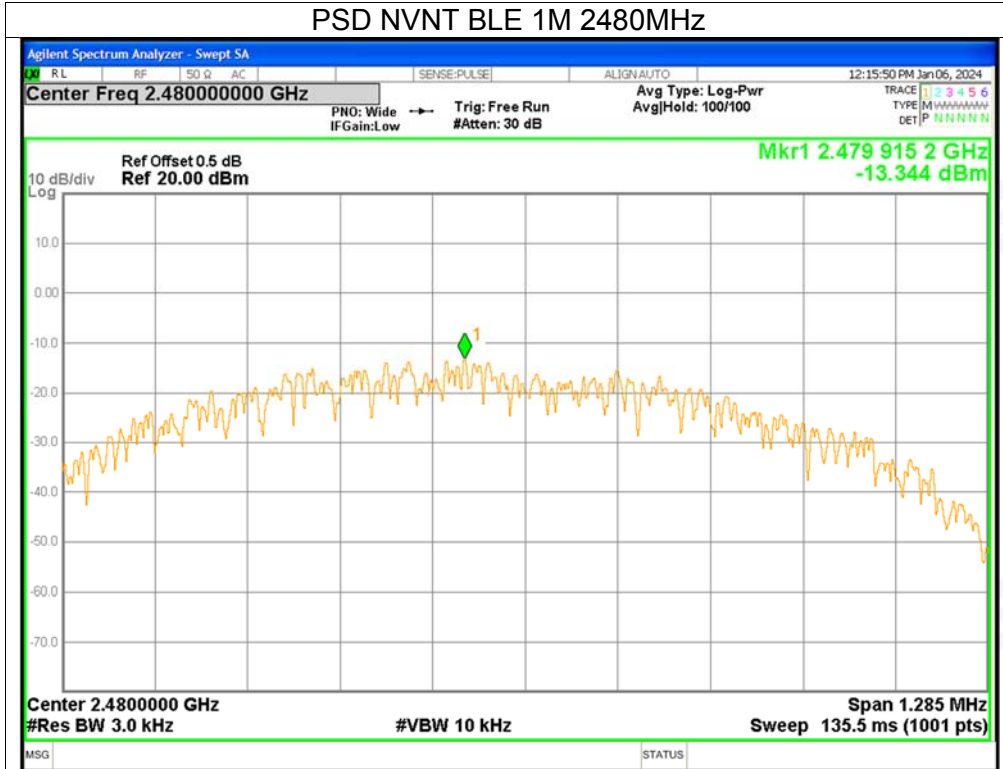

### PSD NVNT BLE 2M 2402MHz

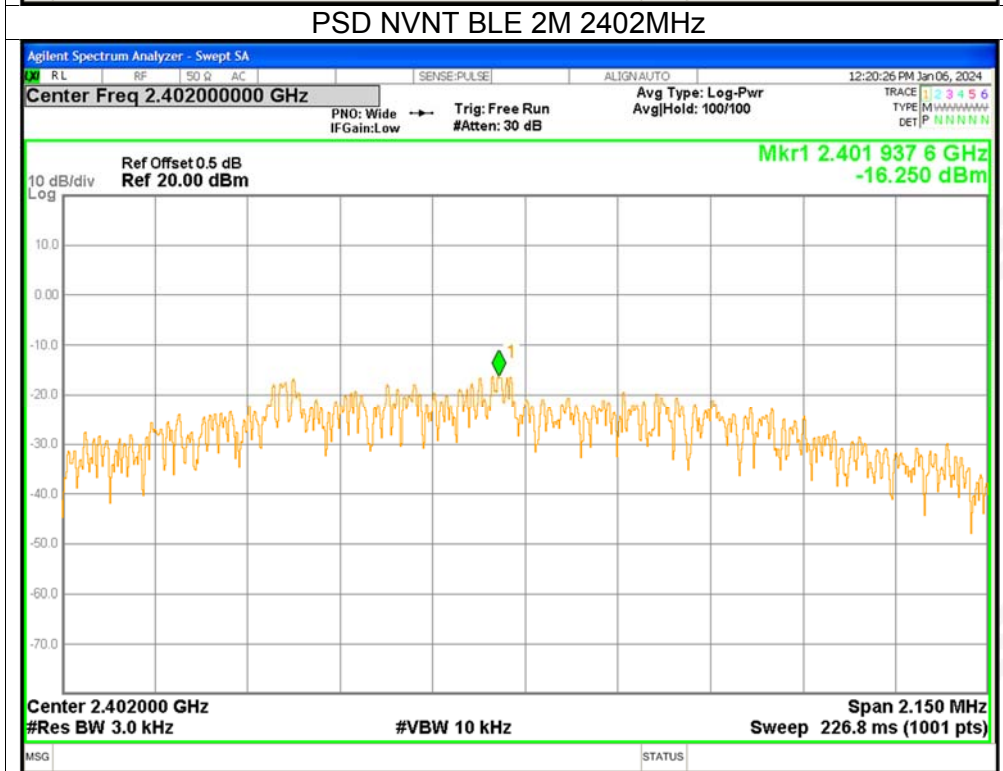



### PSD NVNT BLE 2M 2440MHz

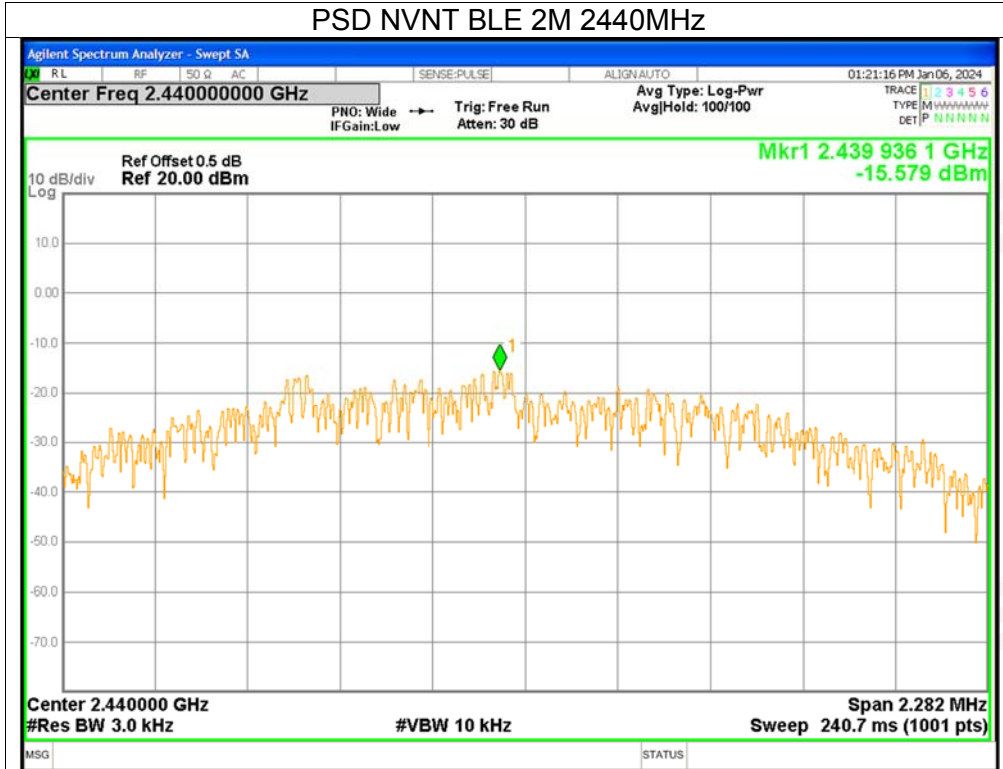

### PSD NVNT BLE 2M 2480MHz

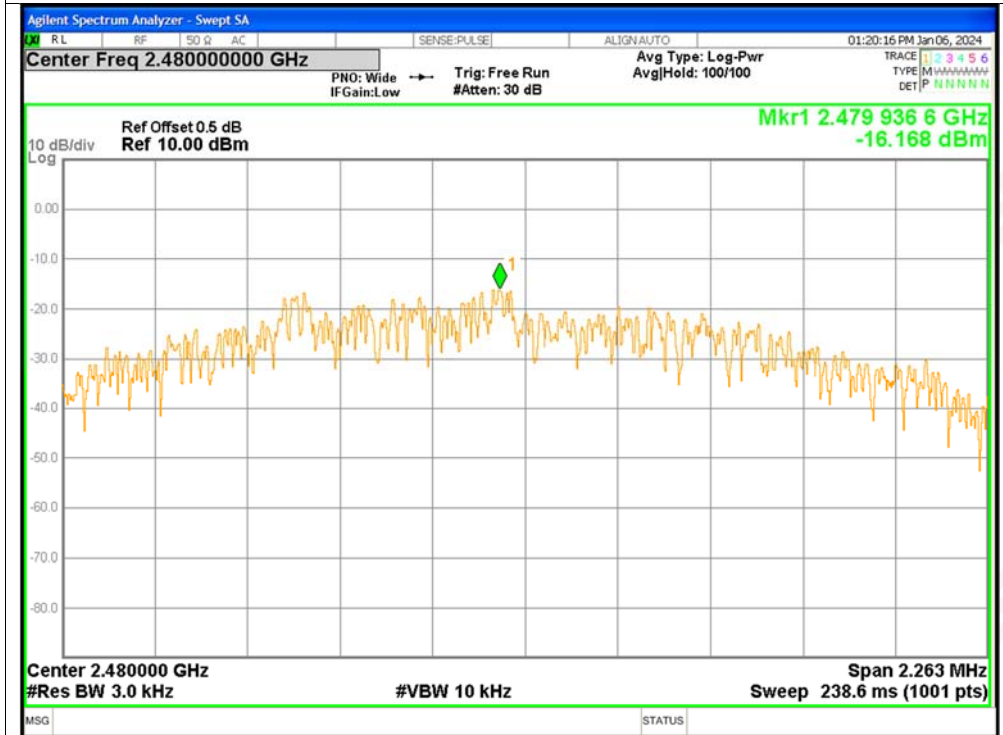



### 6. Band Edge

Condition	Mode	Frequency (MHz)	Max Value (dBc)	Limit (dBc)	Verdict
NVNT	BLE 1M	2402	-51.76	<=-20	Pass
NVNT	BLE 1M	2480	-56.02	<=-20	Pass
NVNT	BLE 2M	2402	-34.83	<=-20	Pass
NVNT	BLE 2M	2480	-51.69	<=-20	Pass





### Band Edge NVNT BLE 1M 2480MHz Ref

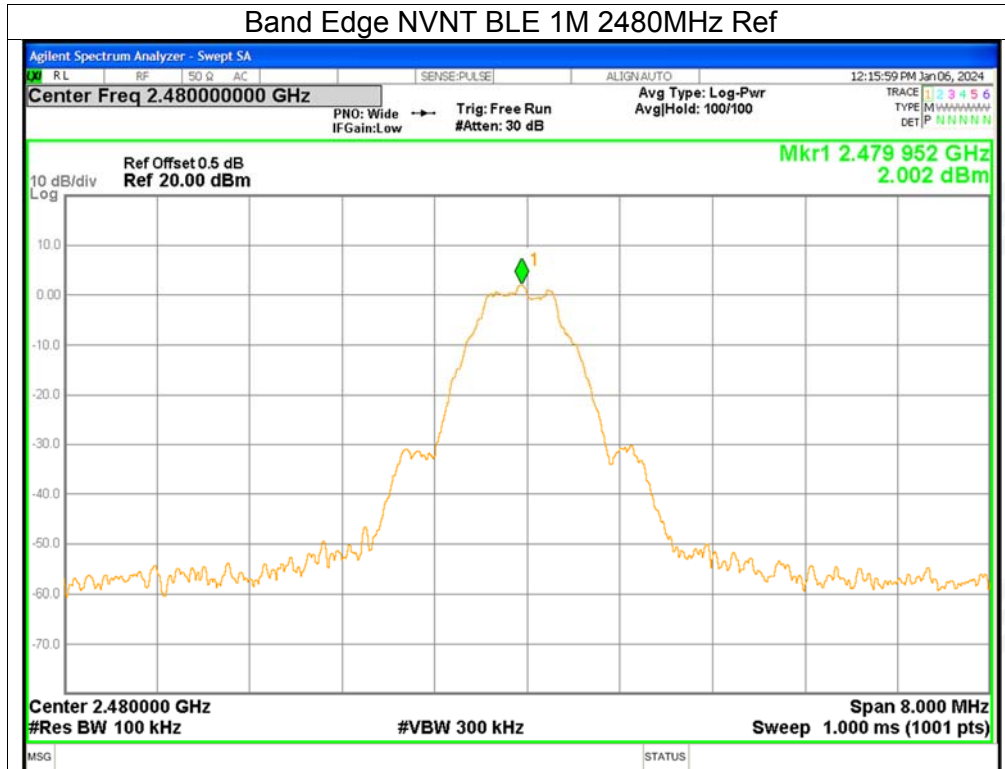

### Band Edge NVNT BLE 1M 2480MHz Emission

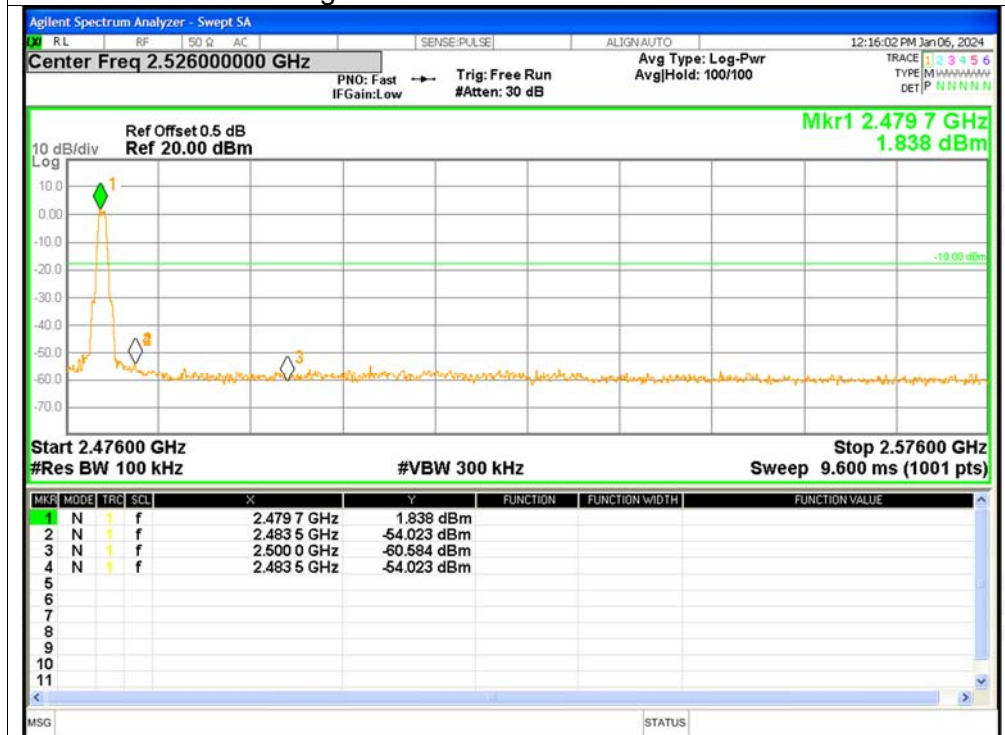









### 7. Conducted RF Spurious Emission

Condition	Mode	Frequency (MHz)	Max Value (dBc)	Limit (dBc)	Verdict
NVNT	BLE 1M	2402	-38.05	<=-20	Pass
NVNT	BLE 1M	2440	-38.08	<=-20	Pass
NVNT	BLE 1M	2480	-37.72	<=-20	Pass
NVNT	BLE 2M	2402	-42.61	<=-20	Pass
NVNT	BLE 2M	2440	-40.9	<=-20	Pass



### Test Graphs Tx. Spurious NVNT BLE 1M 2402MHz Ref

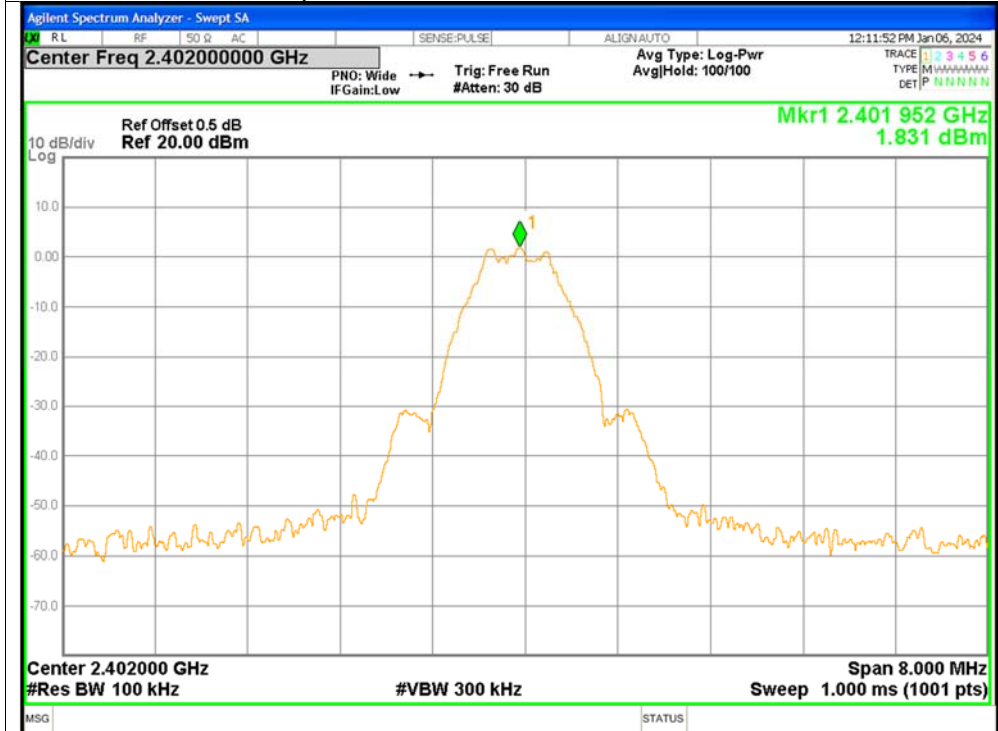

### Tx. Spurious NVNT BLE 1M 2402MHz Emission

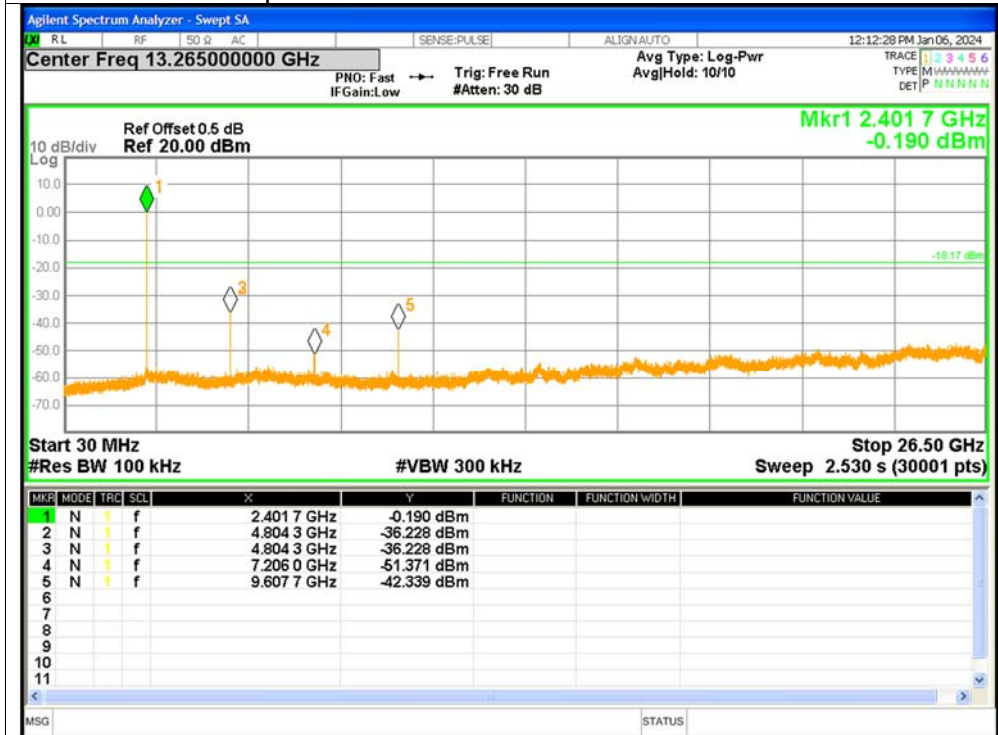





### Tx. Spurious NVNT BLE 1M 2480MHz Ref

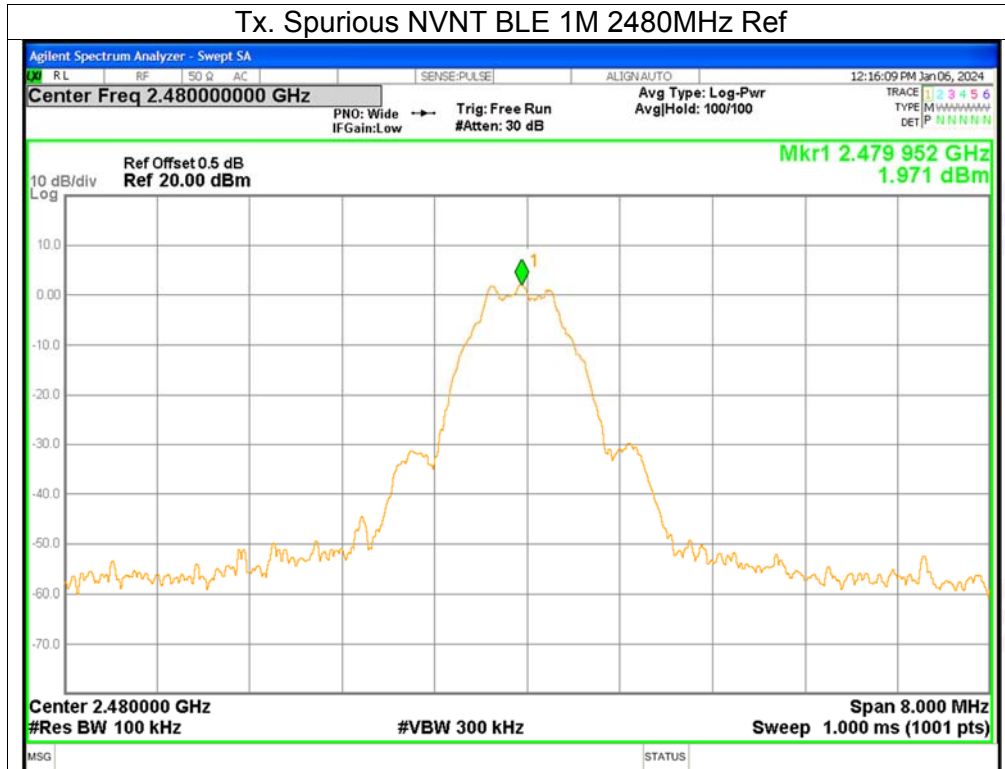

### Tx. Spurious NVNT BLE 1M 2480MHz Emission

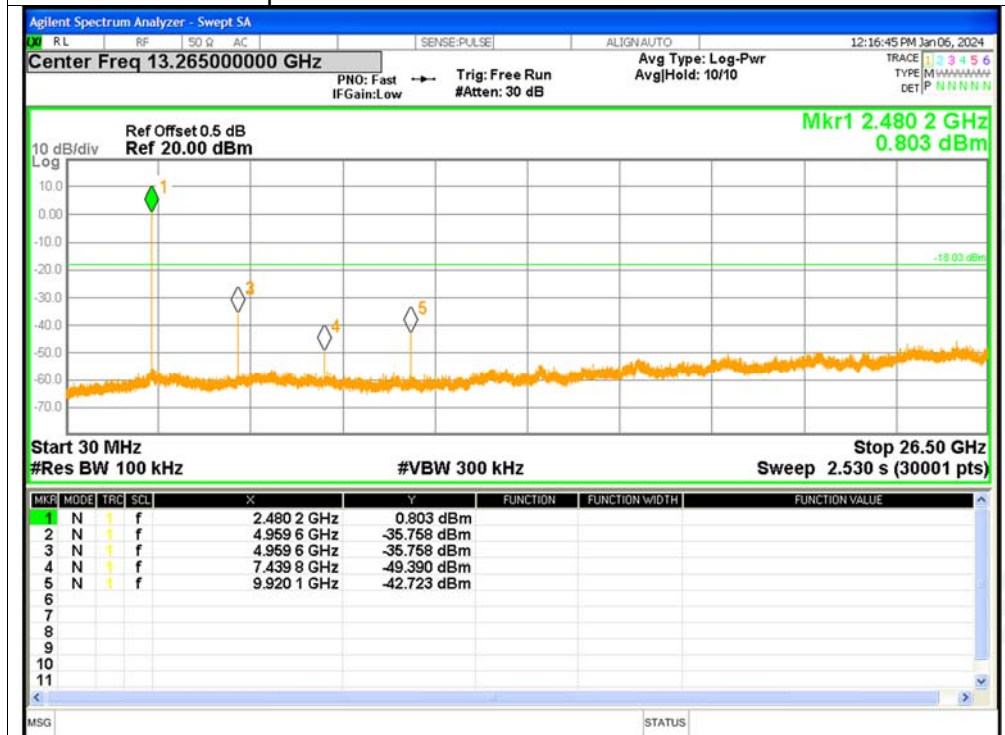









## APPENDIX 2- EUT TEST PHOTO

Note: See test photos in setup photo document for the actual connections between Product and support equipment.

\*\*\*\*\*END OF THE REPORT\*\*\*\*\*