

FCC REPORT

Applicant: AUDIO PRO AB

Address of Applicant: Garnisonsgatan 52, 25466, Helsingborg, Sweden

Equipment Under Test (EUT)

Product Name: PORTABLE WIRELESS SPEAKER

Model No.: ADDON T3

FCC ID: 2AGNC-T3

Applicable standards: FCC CFR Title 47 Part 15 Subpart C Section 15.249:2014

Date of sample receipt: November 10, 2015

Date of Test: November 11-18, 2015

Date of report issued: November 19, 2015

Test Result : PASS *

* In the configuration tested, the EUT complied with the standards specified above.

Authorized Signature:

A circular logo for GTS Global Testing Services Co., Ltd. is overlaid with a handwritten signature in black ink. The logo contains the text 'GTS' in the center, 'GLOBAL TESTING' below it, and 'GLOBAL UNITED TECHNOLOGY SERVICES CO., LTD.' around the perimeter.

Robinson Lo

Laboratory Manager

This report details the results of the testing carried out on one sample. The results contained in this test report do not relate to other samples of the same product and does not permit the use of the GTS product certification mark. The manufacturer should ensure that all products in series production are in conformity with the product sample detailed in this report.

This report may only be reproduced and distributed in full. If the product in this report is used in any configuration other than that detailed in the report, the manufacturer must ensure the new system complies with all relevant standards. Any mention of GTS or testing done by GTS in connection with, distribution or use of the product described in this report must be approved by GTS in writing.

This document cannot be reproduced except in full, without prior written approval of the Company. Any unauthorized alteration, forgery or falsification of the content or appearance of this document is unlawful and offenders may be prosecuted to the fullest extent of the law. Unless otherwise stated the results shown in this test report refer only to the sample(s) tested and such sample(s) are retained for 90 days only.

2 Version

Version No.	Date	Description
00	November 19, 2015	Original

Prepared By: Sam. Gao **Date:** November 19, 2015
Project Engineer

Check By: hank. yan **Date:** November 19, 2015
Reviewer

3 Contents

	Page
1 COVER PAGE.....	1
2 VERSION.....	2
3 CONTENTS.....	3
4 TEST SUMMARY.....	4
4.1 MEASUREMENT UNCERTAINTY.....	4
5 GENERAL INFORMATION.....	5
5.1 CLIENT INFORMATION.....	5
5.2 GENERAL DESCRIPTION OF EUT.....	5
5.3 TEST MODE.....	7
5.4 DESCRIPTION OF SUPPORT UNITS.....	7
5.5 TEST FACILITY.....	7
5.6 TEST LOCATION.....	7
5.7 DESCRIPTION OF SUPPORT UNITS.....	7
5.8 OTHER INFORMATION REQUESTED BY THE CUSTOMER.....	7
6 TEST INSTRUMENTS LIST.....	8
7 TEST RESULTS AND MEASUREMENT DATA.....	9
7.1 ANTENNA REQUIREMENT.....	9
7.2 CONDUCTED EMISSIONS.....	10
7.3 RADIATED EMISSION METHOD.....	13
7.3.1 <i>Field Strength of The Fundamental Signal</i>	15
7.3.2 <i>Spurious emissions</i>	16
7.3.3 <i>Bandedge emissions</i>	20
7.4 20dB OCCUPY BANDWIDTH.....	21
8 TEST SETUP PHOTO.....	23
9 EUT CONSTRUCTIONAL DETAILS.....	24

4 Test Summary

Test Item	Section in CFR 47	Result
Antenna requirement	15.203	Pass
AC Power Line Conducted Emission	15.207	Pass
Field strength of the fundamental signal	15.249 (a)	Pass
Spurious emissions	15.249 (a) (d)/15.209	Pass
Band edge	15.249 (d)/15.205	Pass
20dB Occupied Bandwidth	15.215 (c)	Pass

Pass: The EUT complies with the essential requirements in the standard.

Remark: Test according to ANSI C63.10 2013 and ANSI C63.4: 2014

4.1 Measurement Uncertainty

Test Item	Frequency Range	Measurement Uncertainty	Notes
Radiated Emission	9kHz ~ 30MHz	± 4.34dB	(1)
Radiated Emission	30MHz ~ 1000MHz	± 4.24dB	(1)
Radiated Emission	1GHz ~ 26.5GHz	± 4.68dB	(1)
AC Power Line Conducted Emission	0.15MHz ~ 30MHz	± 3.45dB	(1)

Note (1): The measurement uncertainty is for coverage factor of k=2 and a level of confidence of 95%.

5 General Information

5.1 Client Information

Applicant:	AUDIO PRO AB
Address of Applicant:	Garnisonsgatan 52, 25466, Helsingborg, Sweden
Manufacturer:	AUDIO PRO AB
Address of Manufacturer :	Garnisonsgatan 52, 25466, Helsingborg, Sweden
Factory:	DONGUAN TRISTAR ELECTRONIC CO., LTD.
Address of Factory:	No.24A Dongxing Ave. South, Zhenxingwei, Tangxia Town, Dongguan City, Guangdong Province P.R. China

5.2 General Description of EUT

Product Name:	PORTABLE WIRELESS SPEAKER
Model No.:	ADDON T3
Operation Frequency:	2402MHz~2480MHz
Channel numbers:	40
Channel separation:	2MHz
Modulation type:	GFSK
Antenna Type:	PCB antenna
Antenna gain:	0dBi (declare by Applicant)
Power supply:	AC 120V/60Hz DC 14.8V 2200mAh Li-ion Battery

Operation Frequency each of channel							
Channel	Frequency	Channel	Frequency	Channel	Frequency	Channel	Frequency
1	2402MHz	11	2422MHz	21	2442MHz	31	2462MHz
2	2404MHz	12	2424MHz	22	2444MHz	32	2464MHz
⋮	⋮	⋮	⋮	⋮	⋮	⋮	⋮
9	2418MHz	19	2438MHz	29	2458MHz	39	2478MHz
10	2420MHz	20	2440MHz	30	2460MHz	40	2480MHz

Note:

In section 15.31(m), regards to the operating frequency range over 10 MHz, the Lowest frequency, the middle frequency, and the highest frequency of channel were selected to perform the test, and the selected channel see below:

Channel	Frequency
The lowest channel	2402MHz
The middle channel	2440MHz
The Highest channel	2480MHz

5.3 Test mode

Transmitting mode	Keep the EUT in continuously transmitting mode
<p><i>Remark: During the test, the test voltage was tuned from 85% to 115% of the nominal rated supply voltage, and found that the worst case was under the nominal rated supply condition. So the report just shows that condition's data.</i></p>	

Per-test mode.

We have verified the construction and function in typical operation, The EUT was placed on three different polar directions; i.e. X axis, Y axis, Z axis. which was shown in this test report and defined as follows:

Axis	X	Y	Z
Field Strength(dBuV/m)	86.23	89.54	87.75

5.4 Description of Support Units

None.

5.5 Test Facility

The test facility is recognized, certified, or accredited by the following organizations:

- **FCC —Registration No.: 600491**

Global United Technology Services Co., Ltd., Shenzhen EMC Laboratory has been registered and fully described in a report filed with the (FCC) Federal Communications Commission. The acceptance letter from the FCC is maintained in files. Registration 600491, June 28, 2013.

- **Industry Canada (IC) —Registration No.: 9079A-2**

The 3m Semi-anechoic chamber of Global United Technology Services Co., Ltd. has been registered by Certification and Engineering Bureau of Industry Canada for radio equipment testing with Registration No.: 9079A-2, June 26, 2013.

5.6 Test Location

All tests were performed at:
<p>Global United Technology Services Co., Ltd. Address: Room 301-309, 3th Floor, Block A, Huafeng Jinyuan Business Building, No. 300 Laodong Industrial Zone, Xixiang Road, Baoan District, Shenzhen, China Tel: 0755-27798480 Fax: 0755-27798960</p>

5.7 Description of Support Units

None.

5.8 Other Information Requested by the Customer

None.

6 Test Instruments list

Radiated Emission:						
Item	Test Equipment	Manufacturer	Model No.	Inventory No.	Cal.Date (mm-dd-yy)	Cal.Due date (mm-dd-yy)
1	3m Semi- Anechoic Chamber	ZhongYu Electron	9.2(L)*6.2(W)* 6.4(H)	GTS250	Mar. 28 2015	Mar. 27 2016
2	Control Room	ZhongYu Electron	6.2(L)*2.5(W)* 2.4(H)	GTS251	N/A	N/A
3	Spectrum Analyzer	Agilent	E4440A	GTS533	Jun 30 2015	Jun 29 2016
4	EMI Test Receiver	Rohde & Schwarz	ESU26	GTS203	Jun 30 2015	Jun 29 2016
5	BiConiLog Antenna	SCHWARZBECK MESS-ELEKTRONIK	VULB9163	GTS214	Jun 30 2015	Jun 29 2016
6	Double -ridged waveguide horn	SCHWARZBECK MESS-ELEKTRONIK	9120D-829	GTS208	June 26 2015	June 25 2016
7	Horn Antenna	ETS-LINDGREN	3160	GTS217	Mar. 27 2015	Mar. 26 2016
8	EMI Test Software	AUDIX	E3	N/A	N/A	N/A
9	Coaxial Cable	GTS	N/A	GTS213	Mar. 28 2015	Mar. 27 2016
10	Coaxial Cable	GTS	N/A	GTS211	Mar. 28 2015	Mar. 27 2016
11	Coaxial cable	GTS	N/A	GTS210	Mar. 28 2015	Mar. 27 2016
12	Coaxial Cable	GTS	N/A	GTS212	Mar. 28 2015	Mar. 27 2016
13	Amplifier(100kHz-3GHz)	HP	8347A	GTS204	Jun. 30, 2015	Jun 29 2016
14	Amplifier(2GHz-20GHz)	HP	8349B	GTS206	Jun. 30, 2015	Jun 29 2016
15	Amplifier (18-26GHz)	Rohde & Schwarz	AFS33-18002 650-30-8P-44	GTS218	June 26 2015	June 25 2016
16	Band filter	Amindeon	82346	GTS219	Mar. 28 2015	Mar. 27 2016

Conducted Emission:						
Item	Test Equipment	Manufacturer	Model No.	Inventory No.	Cal.Date (mm-dd-yy)	Cal.Due date (mm-dd-yy)
1	Shielding Room	ZhongYu Electron	7.0(L)x3.0(W)x3.0(H)	GTS264	Jun. 30 2015	Jun. 29 2016
2	EMI Test Receiver	Rohde & Schwarz	ESCS30	GTS223	Jun. 30 2015	Jun. 29 2016
3	10dB Pulse Limita	Rohde & Schwarz	N/A	GTS224	Jun. 30 2015	Jun. 29 2016
4	Coaxial Switch	ANRITSU CORP	MP59B	GTS225	Jun. 30 2015	Jun. 29 2016
5	LISN	SCHWARZBECK MESS-ELEKTRONIK	NSLK 8127	GTS226	Jun. 30 2015	Jun. 29 2016
6	Coaxial Cable	GTS	N/A	GTS227	Jun. 30 2015	Jun. 29 2016
7	EMI Test Software	AUDIX	E3	N/A	N/A	N/A

General used equipment:						
Item	Test Equipment	Manufacturer	Model No.	Inventory No.	Cal.Date (mm-dd-yy)	Cal.Due date (mm-dd-yy)
1	Barometer	ChangChun	DYM3	GTS257	July 07 2015	July 06 2016

7 Test results and Measurement Data

7.1 Antenna requirement

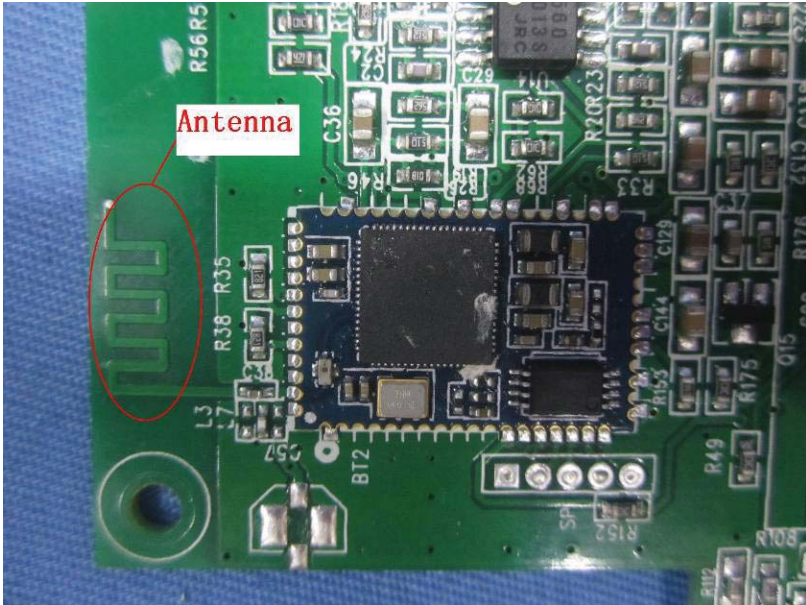
Standard requirement:	FCC Part15 C Section 15.203
<p>15.203 requirement:</p> <p>An intentional radiator shall be designed to ensure that no antenna other than that furnished by the responsible party shall be used with the device. The use of a permanently attached antenna or of an antenna that uses a unique coupling to the intentional radiator, the manufacturer may design the unit so that a broken antenna can be replaced by the user, but the use of a standard antenna jack or electrical connector is prohibited.</p>	
<p>EUT Antenna:</p>	
<p><i>The antenna is PCB antenna, the best case gain of the antenna is 0dBi</i></p> 	

7.2 Conducted Emissions

Test Requirement:	FCC Part15 C Section 15.207														
Test Method:	ANSI C63.10:2013														
Test Frequency Range:	150KHz to 30MHz														
Class / Severity:	Class B														
Receiver setup:	RBW=9KHz, VBW=30KHz, Sweep time=auto														
Limit:	<table border="1"> <thead> <tr> <th rowspan="2">Frequency range (MHz)</th> <th colspan="2">Limit (dBuV)</th> </tr> <tr> <th>Quasi-peak</th> <th>Average</th> </tr> </thead> <tbody> <tr> <td>0.15-0.5</td> <td>66 to 56*</td> <td>56 to 46*</td> </tr> <tr> <td>0.5-5</td> <td>56</td> <td>46</td> </tr> <tr> <td>5-30</td> <td>60</td> <td>50</td> </tr> </tbody> </table> <p>* Decreases with the logarithm of the frequency.</p>	Frequency range (MHz)	Limit (dBuV)		Quasi-peak	Average	0.15-0.5	66 to 56*	56 to 46*	0.5-5	56	46	5-30	60	50
Frequency range (MHz)	Limit (dBuV)														
	Quasi-peak	Average													
0.15-0.5	66 to 56*	56 to 46*													
0.5-5	56	46													
5-30	60	50													
Test setup:	<p>Remark E.U.T: Equipment Under Test LISN: Line Impedance Stabilization Network Test table height=0.8m</p>														
Test procedure:	<ol style="list-style-type: none"> 1. The E.U.T and simulators are connected to the main power through a line impedance stabilization network (L.I.S.N.). This provides a 50ohm/50uH coupling impedance for the measuring equipment. 2. The peripheral devices are also connected to the main power through a LISN that provides a 50ohm/50uH coupling impedance with 50ohm termination. (Please refer to the block diagram of the test setup and photographs). 3. Both sides of A.C. line are checked for maximum conducted interference. In order to find the maximum emission, the relative positions of equipment and all of the interface cables must be changed according to ANSI C63.10:2013 on conducted measurement. 														
Test Instruments:	Refer to section 6.0 for details														
Test mode:	Refer to section 5.3 for details														
Test results:	Pass														

Measurement data:

Line:

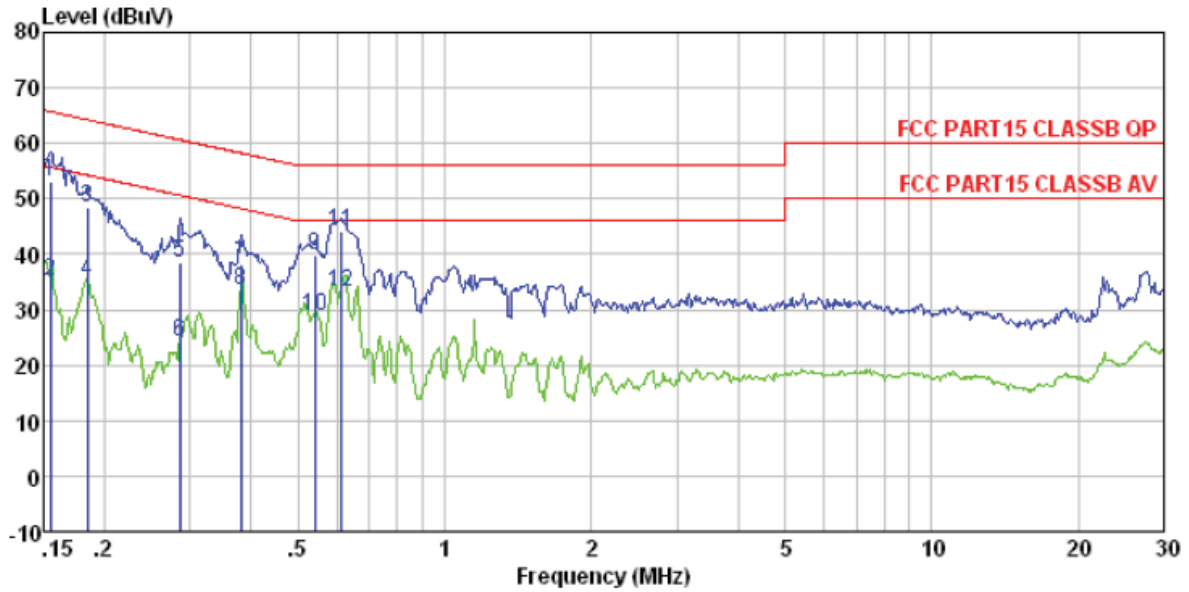

Condition : FCC PART15 CLASSB QP LISN-2013 LINE
 Job No. : 1892RF
 Test mode : Bluetooth4.0 mode
 Test Engineer: Rong

	Freq	Read Level	LISN Factor	Cable Loss	Level	Limit Line	Over Limit	Remark
	MHz	dBuV	dB	dB	dBuV	dBuV	dB	
1	0.155	52.83	0.15	0.12	53.10	65.74	-12.64	QP
2	0.155	35.00	0.15	0.12	35.27	55.74	-20.47	Average
3	0.184	48.16	0.14	0.13	48.43	64.28	-15.85	QP
4	0.184	34.89	0.14	0.13	35.16	54.28	-19.12	Average
5	0.286	38.43	0.11	0.10	38.64	60.63	-21.99	QP
6	0.286	23.90	0.11	0.10	24.11	50.63	-26.52	Average
7	0.381	38.09	0.11	0.10	38.30	58.25	-19.95	QP
8	0.381	33.42	0.11	0.10	33.63	48.25	-14.62	Average
9	0.541	39.64	0.13	0.11	39.88	56.00	-16.12	QP
10	0.541	28.54	0.13	0.11	28.78	46.00	-17.22	Average
11	0.614	43.89	0.13	0.12	44.14	56.00	-11.86	QP
12	0.614	32.84	0.13	0.12	33.09	46.00	-12.91	Average

Neutral:

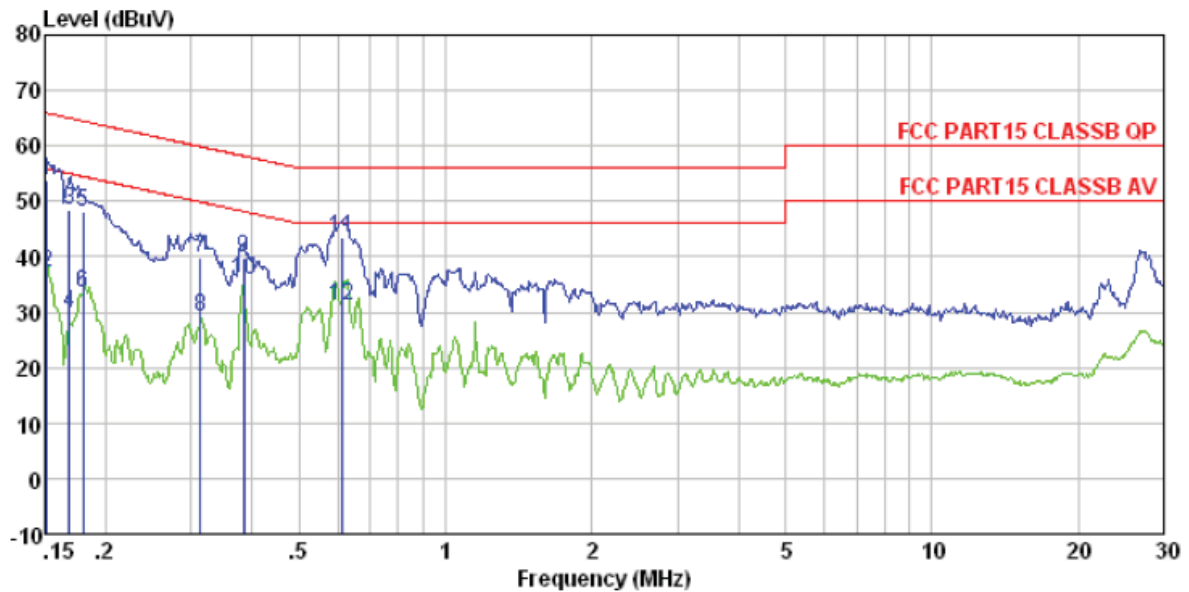

Condition : FCC PART15 CLASSB QP LISN-2013 NEUTRAL
 Job No. : 1892RF
 Test mode : Bluetooth4.0 mode
 Test Engineer: Rong

	Freq	Read Level	LISN Factor	Cable Loss	Level	Limit Line	Over Limit	Remark
	MHz	dBuV	dB	dB	dBuV	dBuV	dB	
1	0.152	53.58	0.07	0.12	53.77	65.91	-12.14	QP
2	0.152	37.09	0.07	0.12	37.28	55.91	-18.63	Average
3	0.169	48.30	0.07	0.12	48.49	65.03	-16.54	QP
4	0.169	29.53	0.07	0.12	29.72	55.03	-25.31	Average
5	0.180	47.87	0.07	0.13	48.07	64.50	-16.43	QP
6	0.180	33.41	0.07	0.13	33.61	54.50	-20.89	Average
7	0.313	39.55	0.06	0.10	39.71	59.88	-20.17	QP
8	0.313	28.96	0.06	0.10	29.12	49.88	-20.76	Average
9	0.385	39.53	0.06	0.10	39.69	58.17	-18.48	QP
10	0.385	35.53	0.06	0.10	35.69	48.17	-12.48	Average
11	0.614	43.43	0.07	0.12	43.62	56.00	-12.38	QP
12	0.614	30.96	0.07	0.12	31.15	46.00	-14.85	Average

Notes:

1. An initial pre-scan was performed on the line and neutral lines with peak detector.
2. Quasi-Peak and Average measurement were performed at the frequencies with maximized peak emission.
3. Final Level = Receiver Read level + LISN Factor + Cable Loss
4. If the average limit is met when using a quasi-peak detector receiver, the EUT shall be deemed to meet both limits and measurement with the average detector receiver is unnecessary.

7.3 Radiated Emission Method

Test Requirement:	FCC Part15 C Section 15.209				
Test Method:	ANSI C63.10:2013				
Test Frequency Range:	30MHz to 25GHz				
Test site:	Measurement Distance: 3m				
Receiver setup:	Frequency	Detector	RBW	VBW	Remark
	30MHz-1GHz	Quasi-peak	120KHz	300KHz	Quasi-peak Value
	Above 1GHz	Peak	1MHz	3MHz	Peak Value
		Peak	1MHz	10Hz	Average Value
Limit: (Field strength of the fundamental signal)	Frequency	Limit (dBuV/m @3m)		Remark	
	2400MHz-2483.5MHz	94.00		Average Value	
Limit: (Spurious Emissions)	Frequency	Limit (dBuV/m @3m)		Remark	
	30MHz-88MHz	40.00		Quasi-peak Value	
	88MHz-216MHz	43.50		Quasi-peak Value	
	216MHz-960MHz	46.00		Quasi-peak Value	
	960MHz-1GHz	54.00		Quasi-peak Value	
	Above 1GHz	54.00		Average Value	
74.00		Peak Value			
Limit: (band edge)	Emissions radiated outside of the specified frequency bands, except for harmonics, shall be attenuated by at least 50 dB below the level of the fundamental or to the general radiated emission limits in Section 15.209, whichever is the lesser attenuation.				
Test setup:	<p>Below 1GHz</p> <p>Above 1GHz</p>				

	<p>The diagram illustrates the test setup. An EUT (Equipment Under Test) is placed on a turn table. The turn table is positioned 3 meters away from an antenna tower. The antenna tower has a horn antenna mounted on it. The antenna height is varied from 1 meter to 4 meters above the ground. The turn table is rotated 360 degrees to determine the position of the highest radiation. The spectrum analyzer is connected to the antenna tower via an amplifier.</p>
<p>Test Procedure:</p>	<ol style="list-style-type: none"> 1. The EUT was placed on the top of a rotating table (0.8m for below 1GHz and 1.5 meters for above 1GHz) above the ground at a 3 meter camber. The table was rotated 360 degrees to determine the position of the highest radiation. 2. The EUT was set 3 meters away from the interference-receiving antenna, which was mounted on the top of a variable-height antenna tower. 3. The antenna height is varied from one meter to four meters above the ground to determine the maximum value of the field strength. Both horizontal and vertical polarizations of the antenna are set to make the measurement. 4. For each suspected emission, the EUT was arranged to its worst case and then the antenna was tuned to heights from 1 meter to 4 meters and the rota table was turned from 0 degrees to 360 degrees to find the maximum reading. 5. The test-receiver system was set to Peak Detect Function and Specified Bandwidth with Maximum Hold Mode. 6. If the emission level of the EUT in peak mode was 10dB lower than the limit specified, then testing could be stopped and the peak values of the EUT would be reported. Otherwise the emissions that did not have 10dB margin would be re-tested one by one using peak, quasi-peak or average method as specified and then reported in a data sheet.
<p>Test Instruments:</p>	<p>Refer to section 6.0 for details</p>
<p>Test mode:</p>	<p>Refer to section 5.3 for details</p>
<p>Test results:</p>	<p>Pass</p>

Measurement data:

7.3.1 Field Strength of The Fundamental Signal

Peak value:

Frequency (MHz)	Read Level (dBuV)	Antenna Factor (dB/m)	Cable Loss (dB)	Preamp Factor (dB)	Level (dBuV/m)	Limit Line (dBuV/m)	Over Limit (dB)	polarization
2402.00	85.76	27.58	5.39	30.18	88.55	114.00	-25.45	Vertical
2402.00	84.26	27.58	5.39	30.18	87.05	114.00	-26.95	Horizontal
2442.00	84.66	27.55	5.43	30.06	87.58	114.00	-26.42	Vertical
2442.00	83.41	27.55	5.43	30.06	86.33	114.00	-27.68	Horizontal
2480.00	86.48	27.52	5.47	29.93	89.54	114.00	-24.46	Vertical
2480.00	84.17	27.52	5.47	29.93	87.23	114.00	-26.77	Horizontal

Average value:

Frequency (MHz)	Read Level (dBuV)	Antenna Factor (dB/m)	Cable Loss (dB)	Preamp Factor (dB)	Level (dBuV/m)	Limit Line (dBuV/m)	Over Limit (dB)	polarization
2402.00	76.18	27.58	5.39	30.18	78.97	94.00	-15.03	Vertical
2402.00	74.48	27.58	5.39	30.18	77.27	94.00	-16.73	Horizontal
2442.00	74.77	27.55	5.43	30.06	77.69	94.00	-16.31	Vertical
2442.00	72.10	27.55	5.43	30.06	75.02	94.00	-18.98	Horizontal
2480.00	76.79	27.52	5.47	29.93	79.85	94.00	-14.15	Vertical
2480.00	74.51	27.52	5.47	29.93	77.57	94.00	-16.43	Horizontal

Remark: RBW 3MHz, VBW 10MHz , peak detector for PK value, RBW 3MHz, VBW 10MHz AV detector for AV value

7.3.2 Spurious emissions

■ Below 1GHz

Frequency (MHz)	Read Level (dBuV)	Antenna Factor (dB/m)	Cable Loss (dB)	Preamp Factor (dB)	Level (dBuV/m)	Limit Line (dBuV/m)	Over Limit (dB)	polarization
45.86	37.68	15.49	0.73	30.02	23.88	40.00	-16.12	Vertical
87.42	41.53	13.18	1.09	29.76	26.04	40.00	-13.96	Vertical
168.41	50.19	10.92	1.68	29.32	33.47	43.50	-10.03	Vertical
289.00	43.55	14.84	2.31	29.93	30.77	46.00	-15.23	Vertical
438.66	30.92	17.55	3.04	29.42	22.09	46.00	-23.91	Vertical
758.04	29.16	21.53	4.31	29.20	25.80	46.00	-20.20	Vertical
57.39	30.89	14.85	0.84	29.94	16.64	40.00	-23.36	Horizontal
95.43	52.17	14.87	1.16	29.72	38.48	43.50	-5.02	Horizontal
150.01	54.85	10.26	1.57	29.41	37.27	43.50	-6.23	Horizontal
300.37	51.28	15.06	2.36	29.99	38.71	46.00	-7.29	Horizontal
470.52	39.40	17.83	3.18	29.36	31.05	46.00	-14.95	Horizontal
670.49	34.36	20.71	3.98	29.23	29.82	46.00	-16.18	Horizontal

■ Above 1GHz

Test channel:	Lowest channel
---------------	----------------

Peak value:

Frequency (MHz)	Read Level (dBuV)	Antenna Factor (dB/m)	Cable Loss (dB)	Preamp Factor (dB)	Level (dBuV/m)	Limit Line (dBuV/m)	Over Limit (dB)	polarization
4804.00	35.44	31.78	8.60	32.09	43.73	74.00	-30.27	Vertical
7206.00	30.59	36.15	11.65	32.00	46.39	74.00	-27.61	Vertical
9608.00	30.37	37.95	14.14	31.62	50.84	74.00	-23.16	Vertical
12010.00	*					74.00		Vertical
14412.00	*					74.00		Vertical
4804.00	39.34	31.78	8.60	32.09	47.63	74.00	-26.37	Horizontal
7206.00	32.18	36.15	11.65	32.00	47.98	74.00	-26.02	Horizontal
9608.00	29.61	37.95	14.14	31.62	50.08	74.00	-23.92	Horizontal
12010.00	*					74.00		Horizontal
14412.00	*					74.00		Horizontal

Average value:

Frequency (MHz)	Read Level (dBuV)	Antenna Factor (dB/m)	Cable Loss (dB)	Preamp Factor (dB)	Level (dBuV/m)	Limit Line (dBuV/m)	Over Limit (dB)	polarization
4804.00	24.61	31.78	8.60	32.09	32.90	54.00	-21.10	Vertical
7206.00	19.49	36.15	11.65	32.00	35.29	54.00	-18.71	Vertical
9608.00	18.68	37.95	14.14	31.62	39.15	54.00	-14.85	Vertical
12010.00	*					54.00		Vertical
14412.00	*					54.00		Vertical
4804.00	28.63	31.78	8.60	32.09	36.92	54.00	-17.08	Horizontal
7206.00	21.54	36.15	11.65	32.00	37.34	54.00	-16.66	Horizontal
9608.00	18.26	37.95	14.14	31.62	38.73	54.00	-15.27	Horizontal
12010.00	*					54.00		Horizontal
14412.00	*					54.00		Horizontal

Remark:

1. Final Level = Receiver Read level + Antenna Factor + Cable Loss – Pre-amplifier Factor
2. “*”, means this data is the too weak instrument of signal is unable to test.

Test channel:	Middle
---------------	--------

Peak value:

Frequency (MHz)	Read Level (dBuV)	Antenna Factor (dB/m)	Cable Loss (dB)	Preamp Factor (dB)	Level (dBuV/m)	Limit Line (dBuV/m)	Over Limit (dB)	polarization
4884.00	35.40	31.85	8.67	32.12	43.80	74.00	-30.20	Vertical
7326.00	30.57	36.37	11.72	31.89	46.77	74.00	-27.23	Vertical
9768.00	30.35	38.35	14.25	31.62	51.33	74.00	-22.67	Vertical
12210.00	*					74.00		Vertical
14652.00	*					74.00		Vertical
4884.00	39.30	31.85	8.67	32.12	47.70	74.00	-26.30	Horizontal
7326.00	32.16	36.37	11.72	31.89	48.36	74.00	-25.64	Horizontal
9768.00	29.59	38.35	14.25	31.62	50.57	74.00	-23.43	Horizontal
12210.00	*					74.00		Horizontal
14652.00	*					74.00		Horizontal

Average value:

Frequency (MHz)	Read Level (dBuV)	Antenna Factor (dB/m)	Cable Loss (dB)	Preamp Factor (dB)	Level (dBuV/m)	Limit Line (dBuV/m)	Over Limit (dB)	polarization
4884.00	24.58	31.85	8.67	32.12	32.98	54.00	-21.02	Vertical
7326.00	19.47	36.37	11.72	31.89	35.67	54.00	-18.33	Vertical
9768.00	18.67	38.35	14.25	31.62	39.65	54.00	-14.35	Vertical
12210.00	*					54.00		Vertical
14652.00	*					54.00		Vertical
4884.00	28.60	31.85	8.67	32.12	37.00	54.00	-17.00	Horizontal
7326.00	21.52	36.37	11.72	31.89	37.72	54.00	-16.28	Horizontal
9768.00	18.24	38.35	14.25	31.62	39.22	54.00	-14.78	Horizontal
12210.00	*					54.00		Horizontal
14652.00	*					54.00		Horizontal

Remark:

1. Final Level = Receiver Read level + Antenna Factor + Cable Loss – Preamplifier Factor
2. “*”, means this data is the too weak instrument of signal is unable to test.

Test channel:	Highest
---------------	---------

Peak value:

Frequency (MHz)	Read Level (dBuV)	Antenna Factor (dB/m)	Cable Loss (dB)	Preamp Factor (dB)	Level (dBuV/m)	Limit Line (dBuV/m)	Over Limit (dB)	polarization
4960.00	35.05	31.93	8.73	32.16	43.55	74.00	-30.45	Vertical
7440.00	30.34	36.59	11.79	31.78	46.94	74.00	-27.06	Vertical
9920.00	30.14	38.81	14.38	31.88	51.45	74.00	-22.55	Vertical
12400.00	*					74.00		Vertical
14880.00	*					74.00		Vertical
4960.00	38.88	31.93	8.73	32.16	47.38	74.00	-26.62	Horizontal
7440.00	31.89	36.59	11.79	31.78	48.49	74.00	-25.51	Horizontal
9920.00	29.35	38.81	14.38	31.88	50.66	74.00	-23.34	Horizontal
12400.00	*					74.00		Horizontal
14880.00	*					74.00		Horizontal

Average value:

Frequency (MHz)	Read Level (dBuV)	Antenna Factor (dB/m)	Cable Loss (dB)	Preamp Factor (dB)	Level (dBuV/m)	Limit Line (dBuV/m)	Over Limit (dB)	polarization
4960.00	24.31	31.93	8.73	32.16	32.81	54.00	-21.19	Vertical
7440.00	19.29	36.59	11.79	31.78	35.89	54.00	-18.11	Vertical
9920.00	18.51	38.81	14.38	31.88	39.82	54.00	-14.18	Vertical
12400.00	*					54.00		Vertical
14880.00	*					54.00		Vertical
4960.00	28.29	31.93	8.73	32.16	36.79	54.00	-17.21	Horizontal
7440.00	21.32	36.59	11.79	31.78	37.92	54.00	-16.08	Horizontal
9920.00	18.05	38.81	14.38	31.88	39.36	54.00	-14.64	Horizontal
12400.00	*					54.00		Horizontal
14880.00	*					54.00		Horizontal

Remark:

1. *Final Level = Receiver Read level + Antenna Factor + Cable Loss – Pre-amplifier Factor*
2. *“**”, means this data is the too weak instrument of signal is unable to test.*
3. *The emission levels of other frequencies are very lower than the limit and not show in test report.*

7.3.3 Bandedge emissions

All of the restriction bands were tested, and only the data of worst case was exhibited.

Test channel:	Lowest channel
---------------	----------------

Peak value:

Frequency (MHz)	Read Level (dBuV)	Antenna Factor (dB/m)	Cable Loss (dB)	Preamp Factor (dB)	Level (dBuV/m)	Limit Line (dBuV/m)	Over Limit (dB)	Polarization
2390.00	37.14	27.59	5.38	30.18	39.93	74.00	-34.07	Horizontal
2400.00	53.11	27.58	5.39	30.18	55.90	74.00	-18.10	Horizontal
2390.00	37.15	27.59	5.38	30.18	39.94	74.00	-34.06	Vertical
2400.00	54.54	27.58	5.39	30.18	57.33	74.00	-16.67	Vertical

Average value:

Frequency (MHz)	Read Level (dBuV)	Antenna Factor (dB/m)	Cable Loss (dB)	Preamp Factor (dB)	Level (dBuV/m)	Limit Line (dBuV/m)	Over Limit (dB)	Polarization
2390.00	28.99	27.59	5.38	30.18	31.78	54.00	-22.22	Horizontal
2400.00	39.89	27.58	5.39	30.18	42.68	54.00	-11.32	Horizontal
2390.00	28.53	27.59	5.38	30.18	31.32	54.00	-22.68	Vertical
2400.00	40.99	27.58	5.39	30.18	43.78	54.00	-10.22	Vertical

Test channel:	Highest channel
---------------	-----------------

Peak value:

Frequency (MHz)	Read Level (dBuV)	Antenna Factor (dB/m)	Cable Loss (dB)	Preamp Factor (dB)	Level (dBuV/m)	Limit Line (dBuV/m)	Over Limit (dB)	Polarization
2483.50	38.57	27.53	5.47	29.93	41.64	74.00	-32.36	Horizontal
2500.00	38.83	27.55	5.49	29.93	41.94	74.00	-32.06	Horizontal
2483.50	38.45	27.53	5.47	29.93	41.52	74.00	-32.48	Vertical
2500.00	39.28	27.55	5.49	29.93	42.39	74.00	-31.61	Vertical

Average value:

Frequency (MHz)	Read Level (dBuV)	Antenna Factor (dB/m)	Cable Loss (dB)	Preamp Factor (dB)	Level (dBuV/m)	Limit Line (dBuV/m)	Over Limit (dB)	Polarization
2483.50	31.75	27.53	5.47	29.93	34.82	54.00	-19.18	Horizontal
2500.00	30.57	27.55	5.49	29.93	33.68	54.00	-20.32	Horizontal
2483.50	32.48	27.53	5.47	29.93	35.55	54.00	-18.45	Vertical
2500.00	30.02	27.55	5.49	29.93	33.13	54.00	-20.87	Vertical

Remark:

1. Final Level = Receiver Read level + Antenna Factor + Cable Loss – Preamplifier Factor

7.4 20dB Occupy Bandwidth

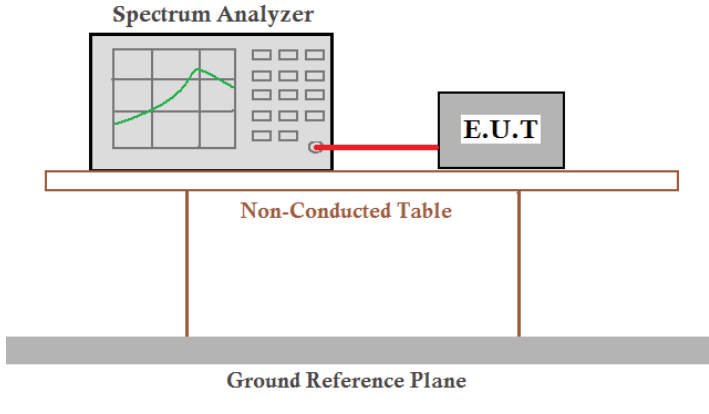
Test Requirement:	FCC Part15 C Section 15.249/15.215
Test Method:	ANSI C63.10:2013
Limit:	Operation Frequency range 2400MHz~2483.5MHz
Test setup:	 <p>The diagram illustrates the test setup. A Spectrum Analyzer is connected to an E.U.T. (Equipment Under Test) via a red cable. Both are placed on a Non-Conducted Table, which is supported by a Ground Reference Plane.</p>
Test Instruments:	Refer to section 6.0 for details
Test mode:	Refer to section 5.3 for details
Test results:	Pass

Measurement Data

Test channel	20dB bandwidth(MHz)	Result
Lowest	1.097	Pass
Middle	1.103	Pass
Highest	1.103	Pass

Test plot as follows:

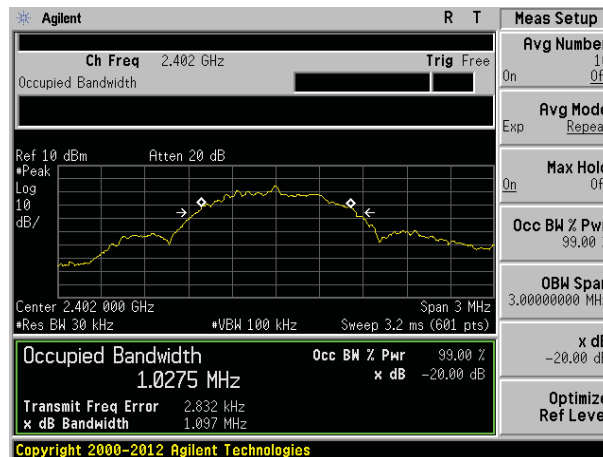

Lowest channel

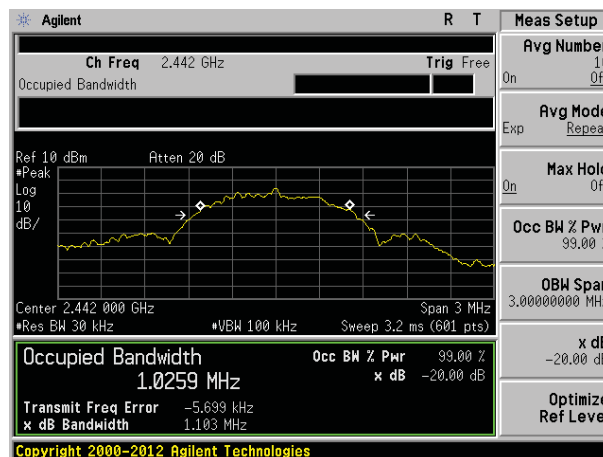

Middle channel

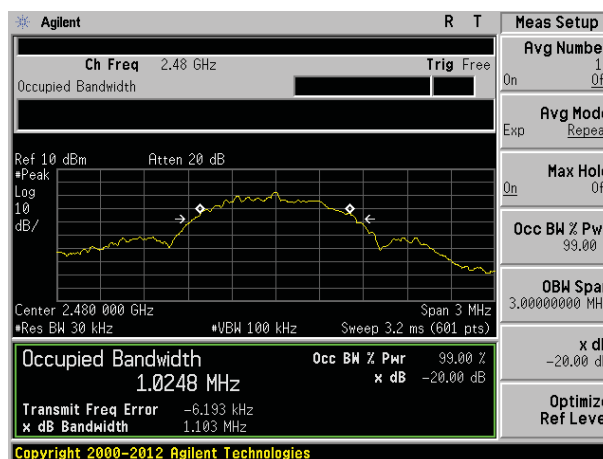

Highest channel

8 Test Setup Photo

Radiated Emission

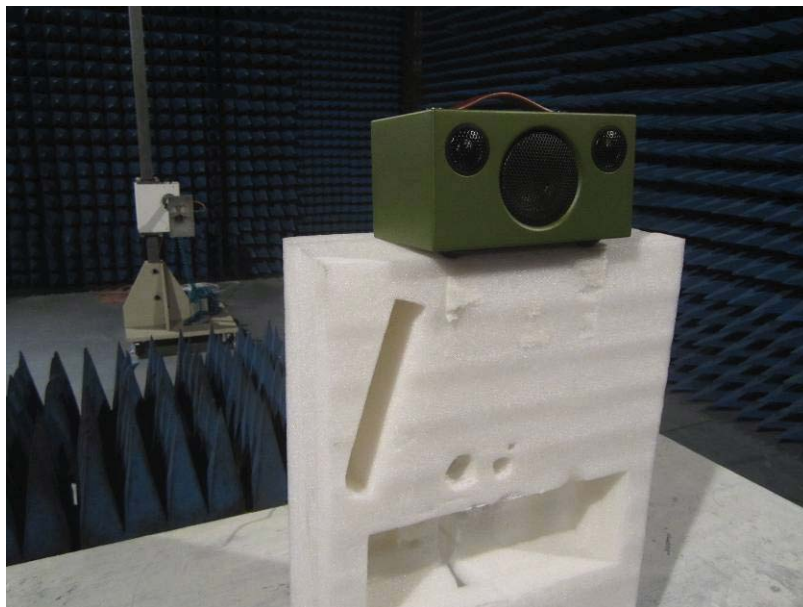

Conducted Emission



9 EUT Constructional Details

Reference to the test report No. GTSE15100189201

----- End -----