

6. UNWANTED EMISSIONS AND BAND EDGE

6.1. Limit

The maximum emissions outside of the frequency bands of operation shall be attenuated in accordance with the following limits:

- (1) For transmitters operating in the 5.15-5.25 GHz band: All emissions outside of the 5.15-5.35 GHz band shall not exceed an e.i.r.p. of -27 dBm/MHz.
- (2) For transmitters operating in the 5.25-5.35 GHz band: All emissions outside of the 5.15-5.35 GHz band shall not exceed an e.i.r.p. of -27 dBm/MHz.
- (3) For transmitters operating in the 5.47-5.725 GHz band: All emissions outside of the 5.47-5.725 GHz band shall not exceed an e.i.r.p. of -27 dBm/MHz.
- (4) For transmitters operating in the 5.725-5.85 GHz band: All emissions shall be limited to a level of -27 dBm/MHz at 75 MHz or more above or below the band edge increasing linearly to 10 dBm/MHz at 25 MHz above or below the band edge, and from 25 MHz above or below the band edge increasing linearly to a level of 15.6 dBm/MHz at 5 MHz above or below the band edge, and from 5 MHz above or below the band edge increasing linearly to a level of 27 dBm/MHz at the band edge.

The unwanted emissions which fall in Restricted bands shall not exceed the field strength levels specified in the following table:

15.209 Radiated emission limits

Frequency (MHz)	Field Strength(μV/m)	Distance(m)
0.009-0.490	2400/F(kHz)	300
0.490-1.705	24000/F(kHz)	30
1.705-30	30	30
30-88	100	3
88-216	150	3
216-960	200	3
Above 960	500	3

15.205 Restricted frequency band

MHz	MHz	MHz	GHz
0.090 - 0.110	16.42 - 16.423	399.9 - 410	4.5 - 5.15
¹ 0.495 - 0.505	16.69475 - 16.69525	608 - 614	5.35 - 5.46
2.1735 - 2.1905	16.80425 - 16.80475	960 - 1240	7.25 - 7.75
4.125 - 4.128	25.5 - 25.67	1300 - 1427	8.025 - 8.5
4.17725 - 4.17775	37.5 - 38.25	1435 - 1626.5	9.0 - 9.2
4.20725 - 4.20775	73 - 74.6	1645.5 - 1646.5	9.3 - 9.5
6.215 - 6.218	74.8 - 75.2	1660 - 1710	10.6 - 12.7
6.26775 - 6.26825	108 - 121.94	1718.8 - 1722.2	13.25 - 13.4
6.31175 - 6.31225	123 - 138	2200 - 2300	14.47 - 14.5
8.291 - 8.294	149.9 - 150.05	2310 - 2390	15.35 - 16.2
8.362 - 8.366	156.52475 - 156.52525	2483.5 - 2500	17.7 - 21.4
8.37625 - 8.38675	156.7 - 156.9	2690 - 2900	22.01 - 23.12
8.41425 - 8.41475	162.0125 - 167.17	3260 - 3267	23.6 - 24.0
12.29 - 12.293	167.72 - 173.2	3332 - 3339	31.2 - 31.8
12.51975 - 12.52025	240 - 285	3345.8 - 3358	36.43 - 36.5
12.57675 - 12.57725	322 - 335.4	3600 - 4400	(²)

Note:

1. $\text{dB}\mu\text{V}/\text{m} = 20 \text{Log}(\mu\text{V}/\text{m})$
2. Above 1GHz the formula is used to convert the EIRP to field strength

$$E[\text{dB}\mu\text{V}/\text{m}] = \text{EIRP}[\text{dBm}] - 20 \log(d[\text{m}]) + 104.77,$$
 where E is field strength and d is distance at which the field strength limit is specified in the applicable requirements.
 for example, 3m field strength $(\text{dB}\mu\text{V}/\text{m}) = \text{EIRP} - 20\log(3) + 104.77 = \text{EIRP} + 95.2$

6.2. Test Setup

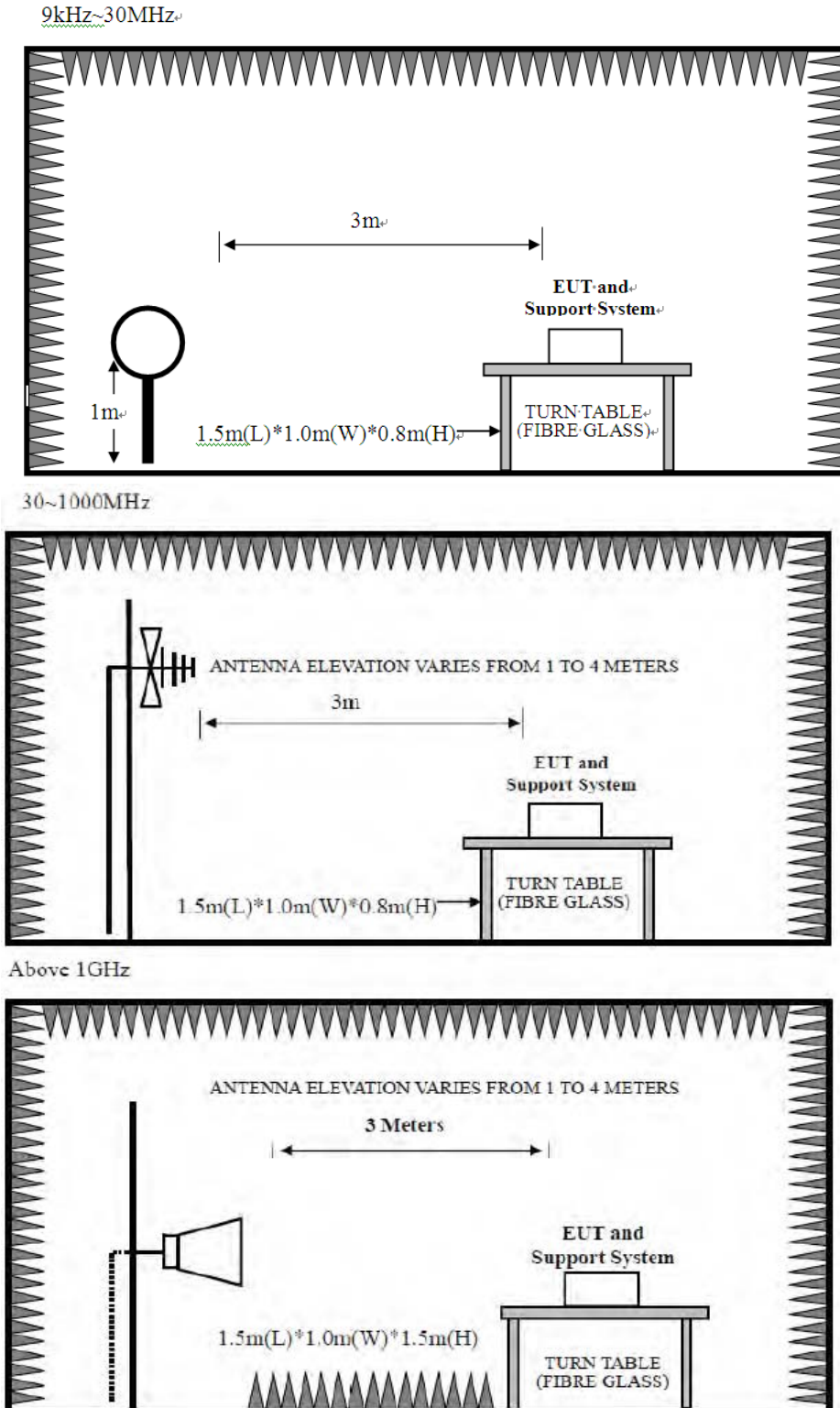

6.3. Spectrum Analyzer Setting

For 9KHz-150KHz

Spectrum Parameters	Setting
RBW	300Hz(for Peak&AVG)/CISPR 200Hz(for QP)
VBW	300Hz(for Peak&AVG)/CISPR 200Hz(for QP)
Start frequency	9KHz
Stop frequency	150KHz
Sweep Time	Auto
Detector	PEAK/QP/AVG
Trace Mode	Max Hold

Note : For 9KHz-90KHz&110KHz-150KHz,the detector is average,other frequency is CISPR QP detector.

For 150KHz-30MHz

Spectrum Parameters	Setting
RBW	9KHz
VBW	9KHz
Start frequency	150KHz
Stop frequency	30MHz
Sweep Time	Auto
Detector	QP
Trace Mode	Max Hold

Note : For 150KHz-490KHz,the detector is average,other frequency is CISPR QP detector.

For 30MHz-1GHz

Spectrum Parameters	Setting
RBW	120KHz
VBW	300KHz
Start frequency	30MHz
Stop frequency	1GHz
Sweep Time	Auto
Detector	QP
Trace Mode	Max Hold

For Above 1GHz

Spectrum Parameters	Setting
RBW	1MHz
VBW	PEAK Measurement
	AVG Measurement Duty cycle $\geq 98\%$, VBW=10Hz Duty cycle $< 98\%$, VBW $\geq 1/T$ Video bandwidth mode=RMS (power averaging)
Start frequency	1GHz
Stop frequency	25GHz
Sweep Time	Auto
Detector	PEAK
Trace Mode	Max Hold

Note : T is the on-time time of the duty cycle,when EUT transmit continuously with maximum output power,unit is seconds. reference section 2.7 for the on-time time.

6.4. Test Procedure

- a. EUT was placed on a turn table, which is 0.8 meter high above ground for below 1GHz test, and which is 1.5 meter high above ground for above 1GHz test.
- b. EUT is set 3 meters away from the receiving antenna, which is mounted on a antenna tower.
- c. Set the EUT transmit continuously with maximum output power.
- d. The turn table can rotate 360 degrees to determine the position of the maximum emission level.
- e. The antenna can be moved up and down between 1 meter and 4 meters to find out the maximum emission level. Both horizontal and vertical polarization of the antenna are set on test.
- f. Spectrum analyzer setting parameters in accordance with section 6.3.
- g. Repeat above procedures until all channels were measured.
- h. Record the results in the test report.
- i. IEEE 802.11a, IEEE 802.11n HT20, IEEE 802.11n HT40, IEEE 802.11ac VHT20, IEEE 802.11ac VHT40, IEEE 802.11ac VHT80 all have been tested. The antenna 2 test data is recorded in report, only worst case 802.11ac VHT20 is recorded.

6.5. Test Result

Radiated Emissions Below 1GHz

EST Technology

Chilingxiang, Qishantou, Santun,
Houjie, Dongguan, Guangdong, China
Tel: +86-769-83081888
Fax: +86-769-83081878

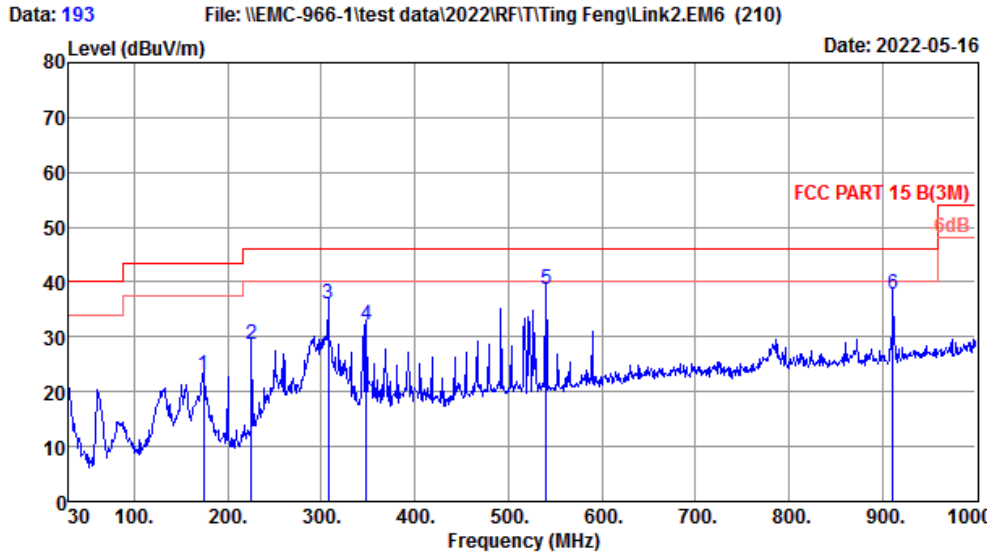

Site no. : 1# 966 Chamber Data no. : 193
 Dis. / Ant. : 3m 37062 Ant. pol. : HORIZONTAL
 Limit : FCC PART 15 B(3M)
 Env. / Ins. : Temp:23.9°C, Humi:52.3%; Press:101.82KPa
 Engineer : XJF
 EUT : MULTIROOM WIFI PLAYER
 Power : AC 120V/60Hz
 M/N : LINK2
 Test Mode : TX Mode

	Freq. (MHz)	ANT Factor (dB/m)	Cable Loss (dB)	Reading (dBuV)	Emission Level (dBuV/m)	Limit (dBuV/m)	Margin (dB)	Remark
1	174.53	10.00	1.17	11.73	22.90	43.50	20.60	QP
2	224.97	10.60	1.44	16.65	28.69	46.00	17.31	QP
3	307.42	13.90	1.66	20.31	35.87	46.00	10.13	QP
4	348.16	15.46	1.79	14.87	32.12	46.00	13.88	QP
5	540.22	19.20	2.14	17.23	38.57	46.00	7.43	QP
6	911.73	24.22	2.82	10.67	37.71	46.00	8.29	QP

Remarks: 1. Emission Level= Antenna Factor + Cable Loss + Reading.
 2. Margin= Limit - Emission Level.
 3. The emission levels that are 20dB below the official limit are not reported.

EST Technology

Chilingxiang, Qishantou, Santun,
Houjie, Dongguan, Guangdong, China
Tel: +86-769-83081888
Fax: +86-769-83081878

Data: 194 File: \\EMC-966-1\test data\2022\RFIT\Ting Feng\Link2.EM6 (210) Date: 2022-05-16

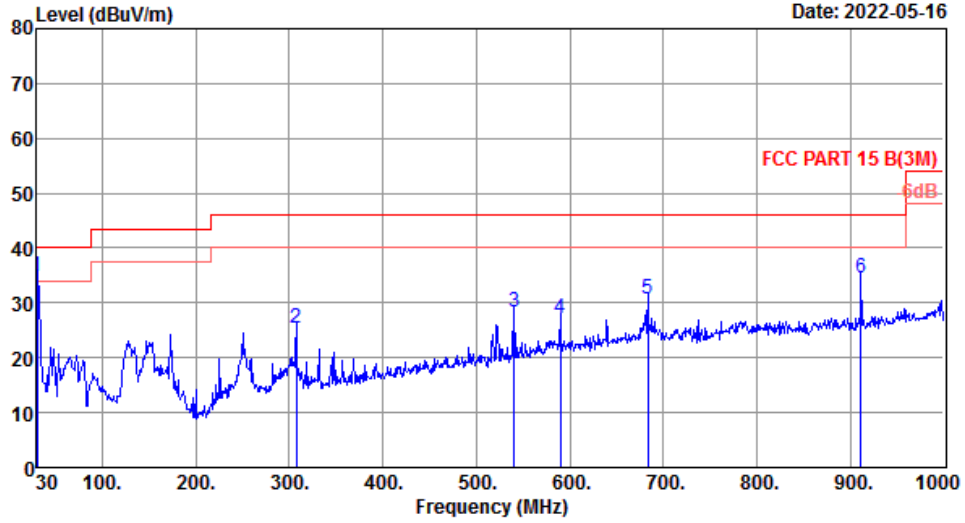

Site no. : 1# 966 Chamber Data no. : 194
 Dis. / Ant. : 3m 37062 Ant. pol. : VERTICAL
 Limit : FCC PART 15 B(3M)
 Env. / Ins. : Temp:23.9°C, Humi:52.3%; Press:101.82KPa
 Engineer : XJF
 EUT : MULTIROOM WIFI PLAYER
 Power : AC 120V/60Hz
 M/N : LINK2
 Test Mode : TX Mode

	Freq. (MHz)	ANT Factor (dB/m)	Cable Loss (dB)	Reading (dBuV)	Emission Level (dBuV/m)	Limit (dBuV/m)	Margin (dB)	Remark
1	30.00	18.90	0.59	15.44	34.93	40.00	5.07	QP
2	307.42	13.90	1.66	9.93	25.49	46.00	20.51	QP
3	540.22	19.20	2.14	7.07	28.41	46.00	17.59	QP
4	589.69	20.50	2.23	4.45	27.18	46.00	18.82	QP
5	683.78	21.86	2.42	6.38	30.66	46.00	15.34	QP
6	911.73	24.22	2.82	7.45	34.49	46.00	11.51	QP

Remarks: 1. Emission Level= Antenna Factor + Cable Loss + Reading.
 2. Margin= Limit - Emission Level.
 3. The emission levels that are 20dB below the official limit are not reported.

Note:

1. The amplitude of 9KHz to 30MHz spurious emission that is attenuated by more than 20dB below the permissible limit has no need to be reported.
2. All channels had been pre-test, only the worst case was reported.



Radiated Emissions Above 1G

EST Technology

Chilingxiang, Qishantou, Santun,
Houjie, Dongguan, Guangdong, China
Tel: +86-769-83081888
Fax: +86-769-83081878

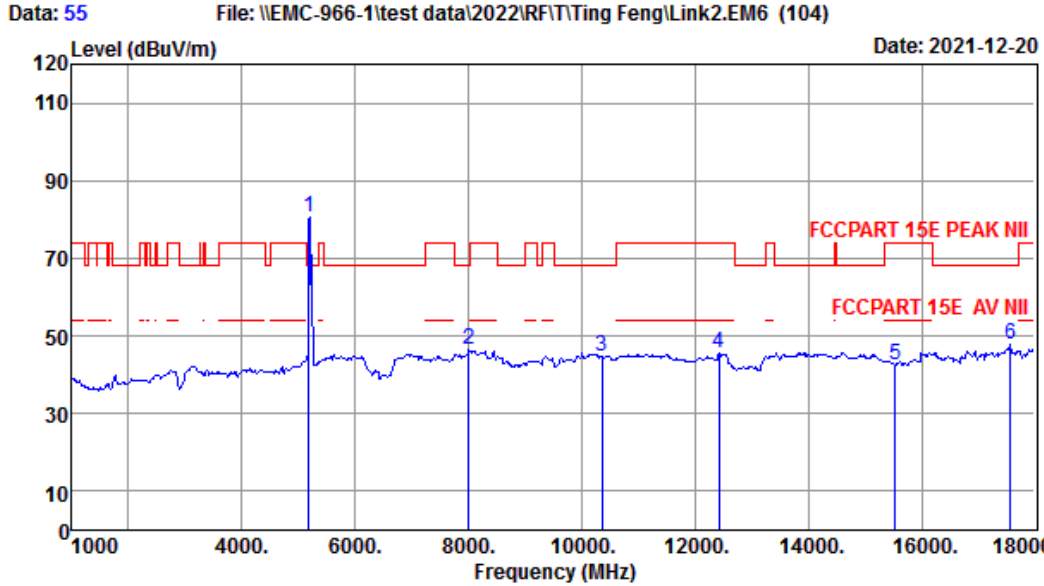

Site no. : 1# 966 Chamber Data no. : 55
 Dis. / Ant. : 3m ANT9120D 1-18G Ant. pol. : HORIZONTAL
 Limit : FCCPART 15E PEAK NII
 Env. / Ins. : Temp:23.4';Humi:50%;Press:101.52kPa
 Engineer : JBR
 EUT : MULTIROOM WIFI PLAYER
 Power : AC 120V/60Hz
 M/N : LINK2
 Test Mode : IEEE 802.11ac 20 TX 5180MHz

	Freq. (MHz)	Ant. Factor (dB/m)	Cable Loss (dB)	Amp Factor (dB)	Reading (dBuV)	Emission Level (dBuV/m)	Limits (dBuV/m)	Margin (dB)	Remark
1	5180.00	32.20	3.52	34.63	79.63	80.72	68.20	-12.52	Peak
2	8004.00	36.90	5.82	34.90	38.54	46.36	68.20	21.84	Peak
3	10360.00	39.27	5.99	34.31	33.65	44.60	68.20	23.60	Peak
4	12424.00	39.69	6.17	34.63	34.32	45.55	74.00	28.45	Peak
5	15540.00	40.31	6.46	34.39	30.05	42.43	74.00	31.57	Peak
6	17575.00	45.51	7.96	34.34	28.63	47.76	68.20	20.44	Peak

Remarks: 1. Emission Level= Antenna Factor + Cable Loss - Amp Factor + Reading.
 2. Margin= Limit - Emission Level.
 3. The emission levels that are 20dB below the official limit are not reported.

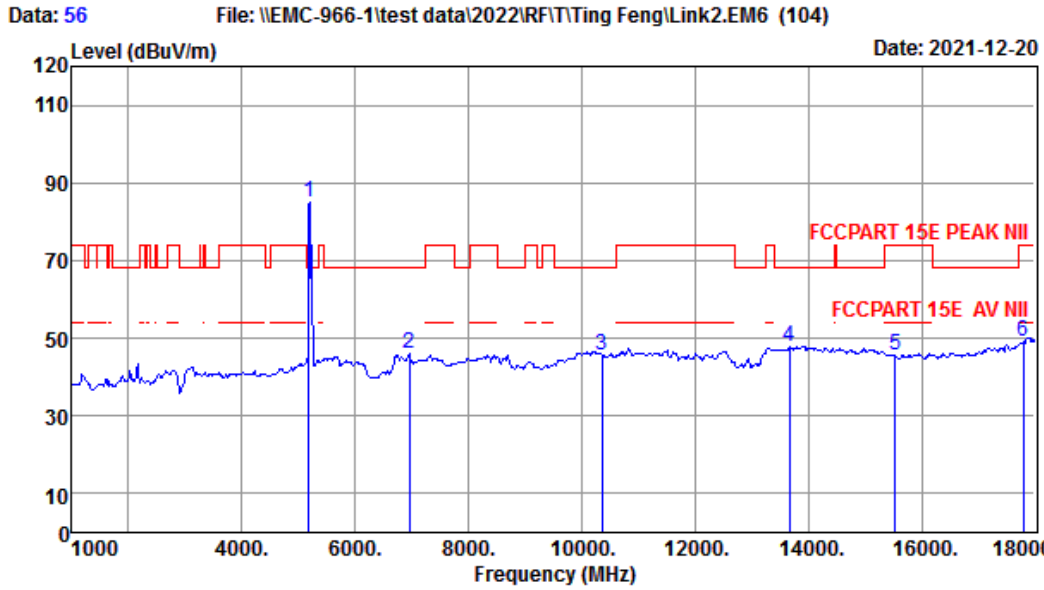

Site no. : 1# 966 Chamber Data no. : 56
 Dis. / Ant. : 3m ANT9120D 1-18G Ant. pol. : VERTICAL
 Limit : FCCPART 15E PEAK NII
 Env. / Ins. : Temp:23.4';Humi:50%;Press:101.52kPa
 Engineer : JBR
 EUT : MULTIROOM WIFI PLAYER
 Power : AC 120V/60Hz
 M/N : LINK2
 Test Mode : IEEE 802.11ac 20 TX 5180MHz

	Freq. (MHz)	Ant. Factor (dB/m)	Cable Loss (dB)	Amp Factor (dB)	Reading (dBUV)	Emission Level (dBUV/m)	Limits (dBUV/m)	Margin (dB)	Remark
1	5180.00	32.20	3.52	34.63	83.75	84.84	68.20	-16.64	Peak
2	6950.00	35.68	5.09	34.77	39.85	45.85	68.20	22.35	Peak
3	10360.00	39.27	5.99	34.31	34.76	45.71	68.20	22.49	Peak
4	13665.00	40.52	6.40	34.33	35.10	47.69	68.20	20.51	Peak
5	15540.00	40.31	6.46	34.39	33.05	45.43	74.00	28.57	Peak
6	17796.00	47.27	8.11	34.32	27.93	48.99	74.00	25.01	Peak

Remarks: 1. Emission Level= Antenna Factor + Cable Loss - Amp Factor + Reading.
 2. Margin= Limit - Emission Level.
 3. The emission levels that are 20dB below the official limit are not reported.

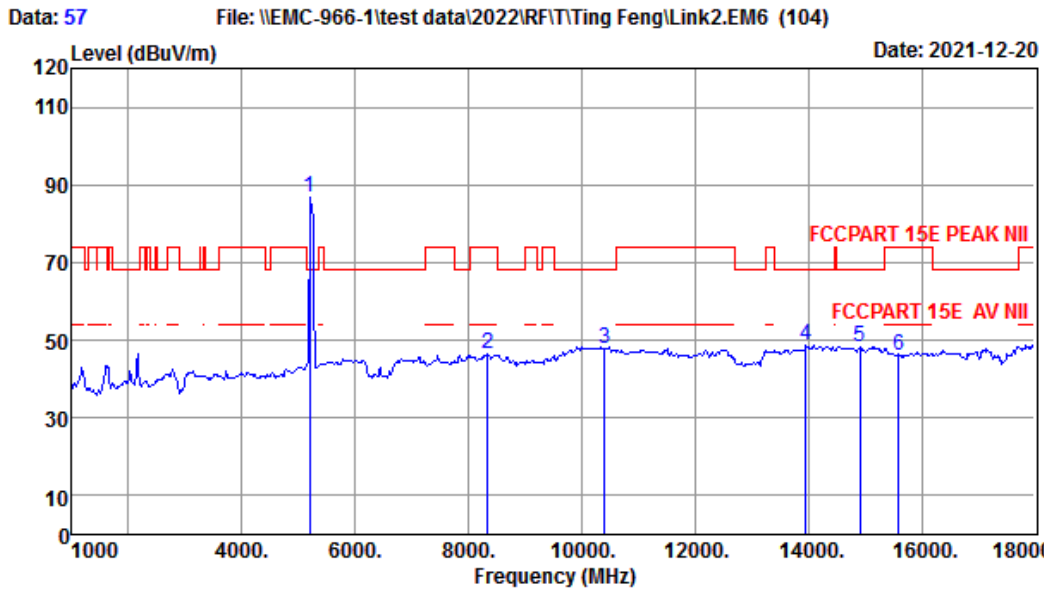

Site no. : 1# 966 Chamber Data no. : 57
 Dis. / Ant. : 3m ANT9120D 1-18G Ant. pol. : VERTICAL
 Limit : FCCPART 15E PEAK NII
 Env. / Ins. : Temp:23.4';Humi:50%;Press:101.52kPa
 Engineer : JBR
 EUT : MULTIROOM WIFI PLAYER
 Power : AC 120V/60Hz
 M/N : LINK2
 Test Mode : IEEE 802.11ac 20 TX 5200MHz

	Freq. (MHz)	Ant. Factor (dB/m)	Cable Loss (dB)	Amp Factor (dB)	Reading (dBuV)	Emission Level (dBuV/m)	Limits (dBuV/m)	Margin (dB)	Remark
1	5200.00	32.24	3.53	34.62	85.69	86.84	68.20	-18.64	Peak
2	8344.00	36.90	5.39	34.73	38.79	46.35	74.00	27.65	Peak
3	10400.00	39.31	5.99	34.32	36.89	47.87	68.20	20.33	Peak
4	13954.00	41.01	6.51	34.31	35.43	48.64	68.20	19.56	Peak
5	14906.00	40.92	6.83	34.57	35.29	48.47	68.20	19.73	Peak
6	15600.00	40.24	6.53	34.36	33.75	46.16	74.00	27.84	Peak

Remarks: 1. Emission Level= Antenna Factor + Cable Loss - Amp Factor + Reading.
 2. Margin= Limit - Emission Level.
 3. The emission levels that are 20dB below the official limit are not reported.

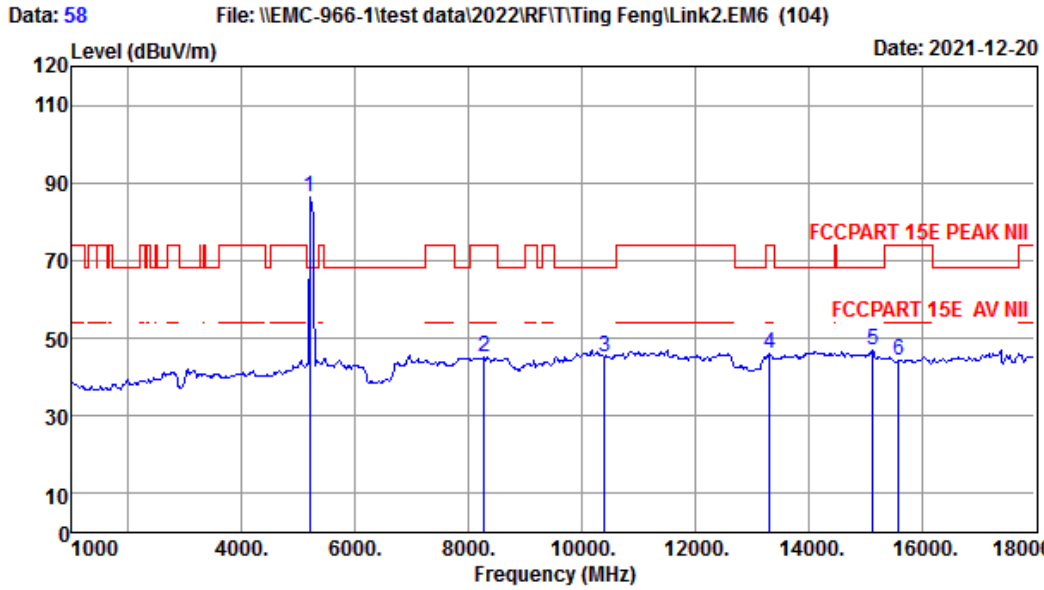

Site no. : 1# 966 Chamber Data no. : 58
 Dis. / Ant. : 3m ANT9120D 1-18G Ant. pol. : HORIZONTAL
 Limit : FCCPART 15E PEAK NII
 Env. / Ins. : Temp:23.4';Humi:50%;Press:101.52kPa
 Engineer : JBR
 EUT : MULTIROOM WIFI PLAYER
 Power : AC 120V/60Hz
 M/N : LINK2
 Test Mode : IEEE 802.11ac 20 TX 5200MHz

	Freq. (MHz)	Ant. Factor (dB/m)	Cable Loss (dB)	Amp Factor (dB)	Reading (dBuV)	Emission Level (dBuV/m)	Limits (dBuV/m)	Margin (dB)	Remark
1	5200.00	32.24	3.53	34.62	85.22	86.37	68.20	-18.17	Peak
2	8276.00	36.90	5.47	34.76	37.74	45.35	74.00	28.65	Peak
3	10400.00	39.31	5.99	34.32	34.37	45.35	68.20	22.85	Peak
4	13325.00	39.95	6.31	34.37	34.05	45.94	74.00	28.06	Peak
5	15144.00	40.75	6.71	34.54	34.09	47.01	68.20	21.19	Peak
6	15600.00	40.24	6.53	34.36	31.70	44.11	74.00	29.89	Peak

Remarks: 1. Emission Level= Antenna Factor + Cable Loss - Amp Factor + Reading.
 2. Margin= Limit - Emission Level.
 3. The emission levels that are 20dB below the official limit are not reported.

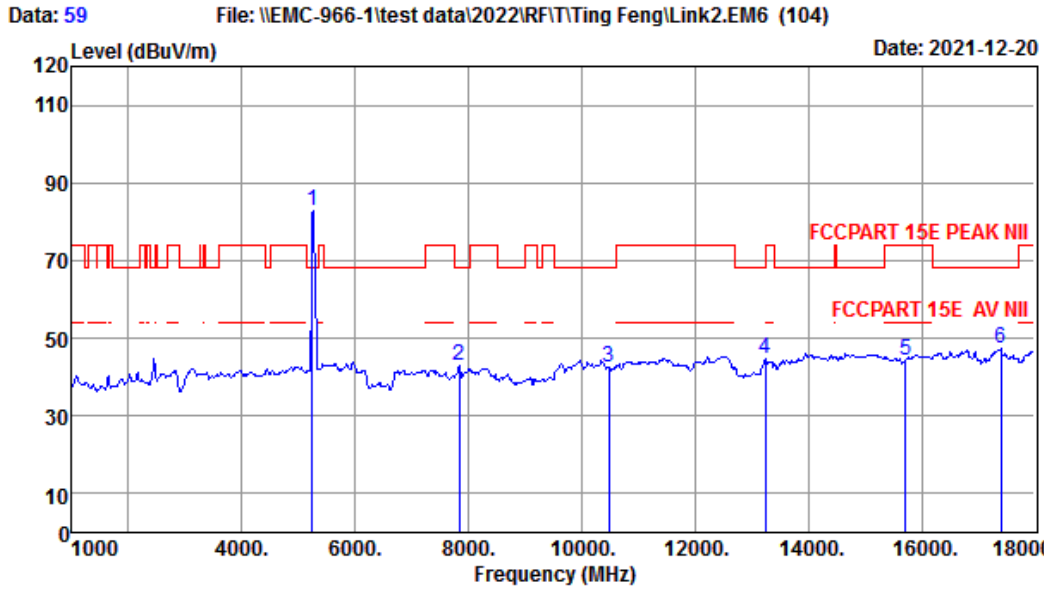

Site no. : 1# 966 Chamber Data no. : 59
 Dis. / Ant. : 3m ANT9120D 1-18G Ant. pol. : VERTICAL
 Limit : FCCPART 15E PEAK NII
 Env. / Ins. : Temp:23.4';Humi:50%;Press:101.52kPa
 Engineer : JBR
 EUT : MULTIROOM WIFI PLAYER
 Power : AC 120V/60Hz
 M/N : LINK2
 Test Mode : IEEE 802.11ac 20 TX 5240MHz

	Freq. (MHz)	Ant. Factor (dB/m)	Cable Loss (dB)	Amp Factor (dB)	Reading (dBUV)	Emission Level (dBUV/m)	Limits (dBUV/m)	Margin (dB)	Remark
1	5240.00	32.31	3.55	34.61	81.71	82.96	68.20	-14.76	Peak
2	7834.00	36.87	5.64	34.88	35.53	43.16	68.20	25.04	Peak
3	10480.00	39.39	6.02	34.35	31.34	42.40	68.20	25.80	Peak
4	13240.00	39.80	6.30	34.38	33.16	44.88	68.20	23.32	Peak
5	15720.00	40.10	6.65	34.31	31.91	44.35	74.00	29.65	Peak
6	17405.00	44.15	7.82	34.36	29.55	47.16	68.20	21.04	Peak

Remarks: 1. Emission Level= Antenna Factor + Cable Loss - Amp Factor + Reading.
 2. Margin= Limit - Emission Level.
 3. The emission levels that are 20dB below the official limit are not reported.

EST Technology

Chilingxiang, Qishantou, Santun,
Houjie, Dongguan, Guangdong, China
Tel: +86-769-83081888
Fax: +86-769-83081878

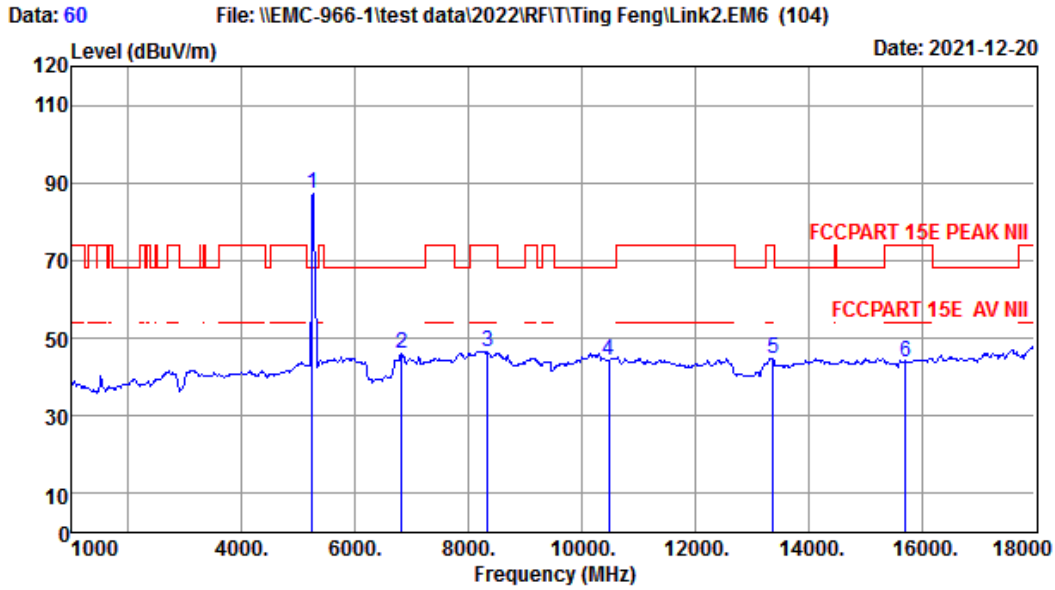

Site no. : 1# 966 Chamber Data no. : 60
 Dis. / Ant. : 3m ANT9120D 1-18G Ant. pol. : HORIZONTAL
 Limit : FCCPART 15E PEAK NII
 Env. / Ins. : Temp:23.4';Humi:50%;Press:101.52kPa
 Engineer : JBR
 EUT : MULTIROOM WIFI PLAYER
 Power : AC 120V/60Hz
 M/N : LINK2
 Test Mode : IEEE 802.11ac 20 TX 5240MHz

	Freq. (MHz)	Ant. Factor (dB/m)	Cable Loss (dB)	Amp Factor (dB)	Reading (dBuV)	Emission Level (dBuV/m)	Limits (dBuV/m)	Margin (dB)	Remark
1	5240.00	32.31	3.55	34.61	85.94	87.19	68.20	-18.99	Peak
2	6814.00	35.34	4.97	34.71	40.23	45.83	68.20	22.37	Peak
3	8344.00	36.90	5.39	34.73	39.11	46.67	74.00	27.33	Peak
4	10480.00	39.39	6.02	34.35	33.39	44.45	68.20	23.75	Peak
5	13376.00	40.03	6.32	34.36	32.76	44.75	74.00	29.25	Peak
6	15720.00	40.10	6.65	34.31	31.59	44.03	74.00	29.97	Peak

Remarks: 1. Emission Level= Antenna Factor + Cable Loss - Amp Factor + Reading.
 2. Margin= Limit - Emission Level.
 3. The emission levels that are 20dB below the official limit are not reported.

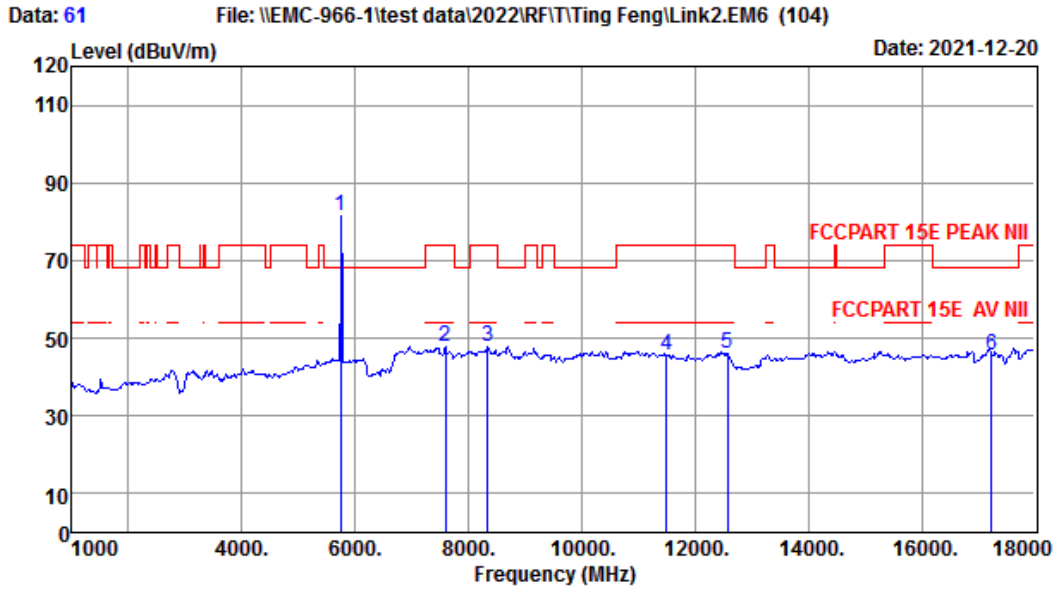

Site no. : 1# 966 Chamber Data no. : 61
 Dis. / Ant. : 3m ANT9120D 1-18G Ant. pol. : HORIZONTAL
 Limit : FCCPART 15E PEAK NII
 Env. / Ins. : Temp:23.4';Humi:50%;Press:101.52kPa
 Engineer : JBR
 EUT : MULTIROOM WIFI PLAYER
 Power : AC 120V/60Hz
 M/N : LINK2
 Test Mode : IEEE 802.11ac 20 TX 5745MHz

	Freq. (MHz)	Ant. Factor (dB/m)	Cable Loss (dB)	Amp Factor (dB)	Reading (dBuV)	Emission Level (dBuV/m)	Limits (dBuV/m)	Margin (dB)	Remark
1	5745.00	32.85	4.00	34.40	78.92	81.37	68.20	-13.17	Peak
2	7596.00	36.82	5.38	34.86	40.31	47.65	74.00	26.35	Peak
3	8344.00	36.90	5.39	34.73	40.32	47.88	74.00	26.12	Peak
4	11490.00	39.90	6.15	34.65	34.25	45.65	74.00	28.35	Peak
5	12577.00	39.61	6.22	34.57	34.58	45.84	74.00	28.16	Peak
6	17235.00	42.80	7.65	34.38	29.70	45.77	68.20	22.43	Peak

Remarks: 1. Emission Level= Antenna Factor + Cable Loss - Amp Factor + Reading.
 2. Margin= Limit - Emission Level.
 3. The emission levels that are 20dB below the official limit are not reported.

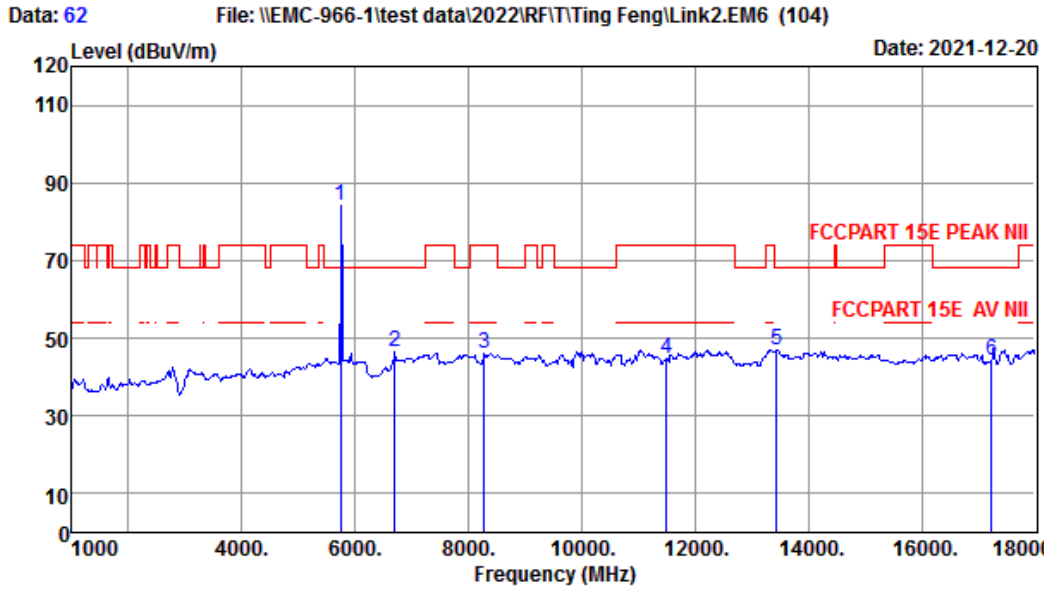

Site no. : 1# 966 Chamber Data no. : 62
 Dis. / Ant. : 3m ANT9120D 1-18G Ant. pol. : VERTICAL
 Limit : FCCPART 15E PEAK NII
 Env. / Ins. : Temp:23.4';Humi:50%;Press:101.52kPa
 Engineer : JBR
 EUT : MULTIROOM WIFI PLAYER
 Power : AC 120V/60Hz
 M/N : LINK2
 Test Mode : IEEE 802.11ac 20 TX 5745MHz

	Freq. (MHz)	Ant. Factor (dB/m)	Cable Loss (dB)	Amp Factor (dB)	Reading (dBuV)	Emission Level (dBuV/m)	Limits (dBuV/m)	Margin (dB)	Remark
1	5745.00	32.85	4.00	34.40	81.67	84.12	68.20	-15.92	Peak
2	6695.00	35.06	4.88	34.65	41.12	46.41	68.20	21.79	Peak
3	8276.00	36.90	5.47	34.76	38.52	46.13	74.00	27.87	Peak
4	11490.00	39.90	6.15	34.65	33.21	44.61	74.00	29.39	Peak
5	13444.00	40.15	6.32	34.36	34.94	47.05	68.20	21.15	Peak
6	17235.00	42.80	7.65	34.38	28.26	44.33	68.20	23.87	Peak

Remarks: 1. Emission Level= Antenna Factor + Cable Loss - Amp Factor + Reading.
 2. Margin= Limit - Emission Level.
 3. The emission levels that are 20dB below the official limit are not reported.

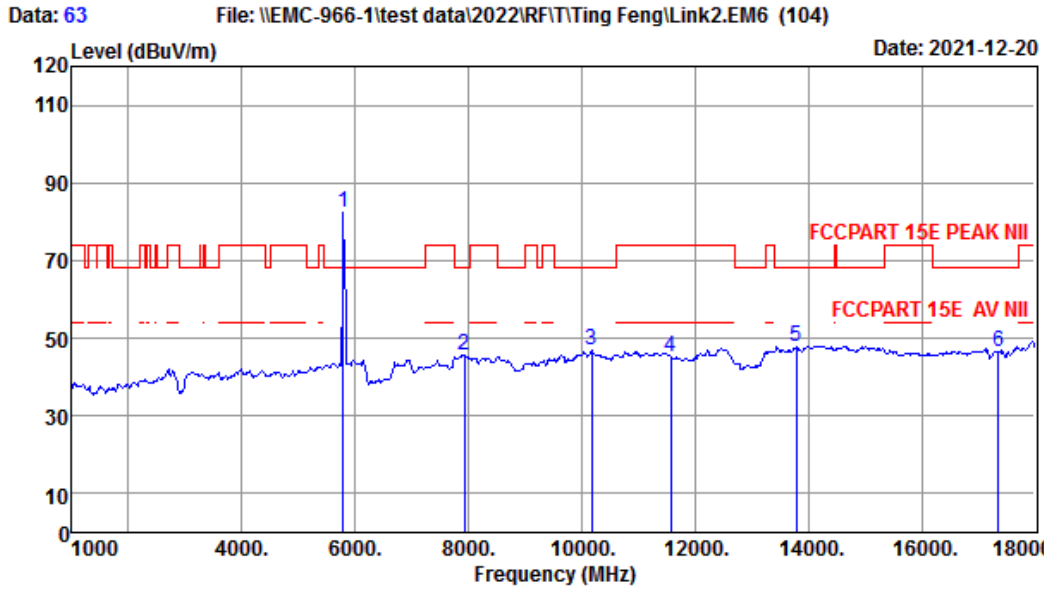

Site no. : 1# 966 Chamber Data no. : 63
 Dis. / Ant. : 3m ANT9120D 1-18G Ant. pol. : HORIZONTAL
 Limit : FCCPART 15E PEAK NII
 Env. / Ins. : Temp:23.4';Humi:50%;Press:101.52kPa
 Engineer : JBR
 EUT : MULTIROOM WIFI PLAYER
 Power : AC 120V/60Hz
 M/N : LINK2
 Test Mode : IEEE 802.11ac 20 TX 5785MHz

	Freq. (MHz)	Ant. Factor (dB/m)	Cable Loss (dB)	Amp Factor (dB)	Reading (dBuV)	Emission Level (dBuV/m)	Limits (dBuV/m)	Margin (dB)	Remark
1	5785.00	32.84	4.05	34.39	79.65	82.15	68.20	-13.95	Peak
2	7936.00	36.89	5.75	34.89	37.97	45.72	68.20	22.48	Peak
3	10180.00	39.09	5.94	34.26	35.96	46.73	68.20	21.47	Peak
4	11570.00	39.90	6.12	34.67	33.91	45.26	74.00	28.74	Peak
5	13784.00	40.73	6.44	34.32	34.96	47.81	68.20	20.39	Peak
6	17355.00	43.75	7.77	34.36	29.24	46.40	68.20	21.80	Peak

Remarks: 1. Emission Level= Antenna Factor + Cable Loss - Amp Factor + Reading.
 2. Margin= Limit - Emission Level.
 3. The emission levels that are 20dB below the official limit are not reported.

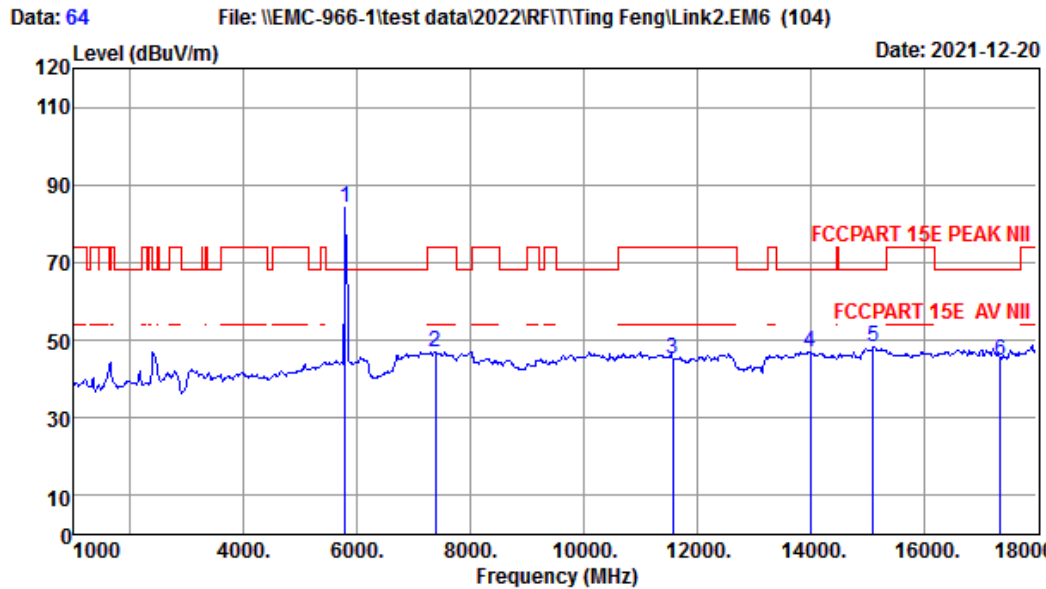

Site no. : 1# 966 Chamber Data no. : 64
 Dis. / Ant. : 3m ANT9120D 1-18G Ant. pol. : VERTICAL
 Limit : FCCPART 15E PEAK NII
 Env. / Ins. : Temp:23.4';Humi:50%;Press:101.52kPa
 Engineer : JBR
 EUT : MULTIROOM WIFI PLAYER
 Power : AC 120V/60Hz
 M/N : LINK2
 Test Mode : IEEE 802.11ac 20 TX 5785MHz

	Freq. (MHz)	Ant. Factor (dB/m)	Cable Loss (dB)	Amp Factor (dB)	Reading (dBUV)	Emission Level (dBUV/m)	Limits (dBUV/m)	Margin (dB)	Remark
1	5785.00	32.84	4.05	34.39	81.57	84.07	68.20	-15.87	Peak
2	7375.00	36.56	5.24	34.84	40.14	47.10	74.00	26.90	Peak
3	11570.00	39.90	6.12	34.67	33.99	45.34	74.00	28.66	Peak
4	14005.00	41.10	6.53	34.30	33.78	47.11	68.20	21.09	Peak
5	15110.00	40.79	6.73	34.56	35.42	48.38	68.20	19.82	Peak
6	17355.00	43.75	7.77	34.36	27.59	44.75	68.20	23.45	Peak

Remarks: 1. Emission Level= Antenna Factor + Cable Loss - Amp Factor + Reading.
 2. Margin= Limit - Emission Level.
 3. The emission levels that are 20dB below the official limit are not reported.

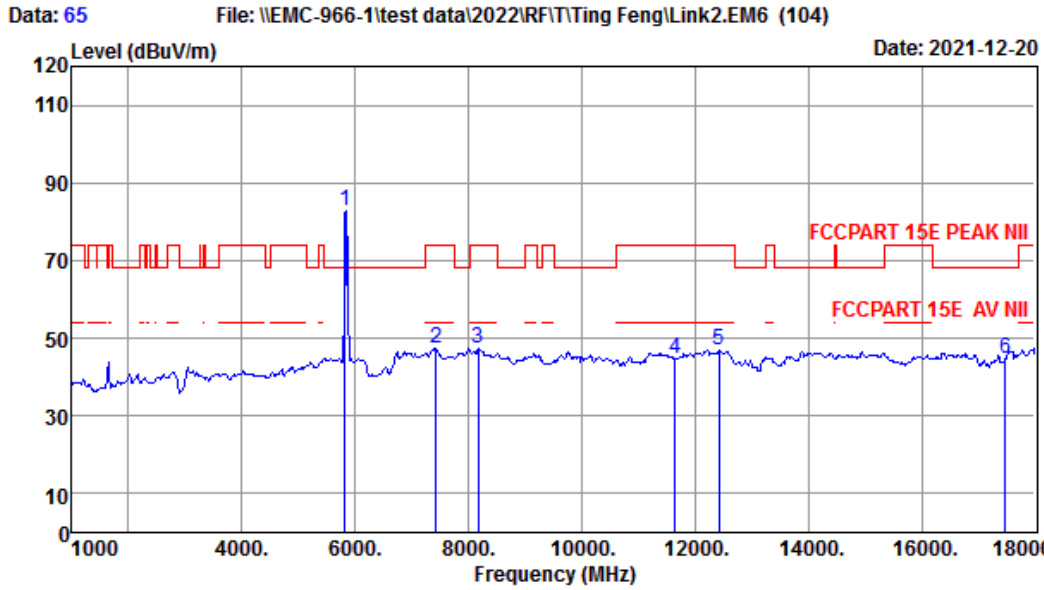

Site no. : 1# 966 Chamber Data no. : 65
 Dis. / Ant. : 3m ANT9120D 1-18G Ant. pol. : VERTICAL
 Limit : FCCPART 15E PEAK NII
 Env. / Ins. : Temp:23.4';Humi:50%;Press:101.52kPa
 Engineer : JBR
 EUT : MULTIROOM WIFI PLAYER
 Power : AC 120V/60Hz
 M/N : LINK2
 Test Mode : IEEE 802.11ac 20 TX 5825MHz

	Freq. (MHz)	Ant. Factor (dB/m)	Cable Loss (dB)	Amp Factor (dB)	Reading (dBUV)	Emission Level (dBUV/m)	Limits (dBUV/m)	Margin (dB)	Remark
1	5825.00	32.83	4.11	34.37	80.24	82.81	68.20	-14.61	Peak
2	7426.00	36.66	5.25	34.84	40.14	47.21	74.00	26.79	Peak
3	8174.00	36.90	5.60	34.82	39.74	47.42	74.00	26.58	Peak
4	11650.00	39.90	6.08	34.69	33.48	44.77	74.00	29.23	Peak
5	12424.00	39.69	6.17	34.63	35.49	46.72	74.00	27.28	Peak
6	17475.00	44.70	7.89	34.35	26.28	44.52	68.20	23.68	Peak

Remarks: 1. Emission Level= Antenna Factor + Cable Loss - Amp Factor + Reading.
 2. Margin= Limit - Emission Level.
 3. The emission levels that are 20dB below the official limit are not reported.

EST Technology

Chilingxiang, Qishantou, Santun,
Houjie, Dongguan, Guangdong, China
Tel: +86-769-83081888
Fax: +86-769-83081878

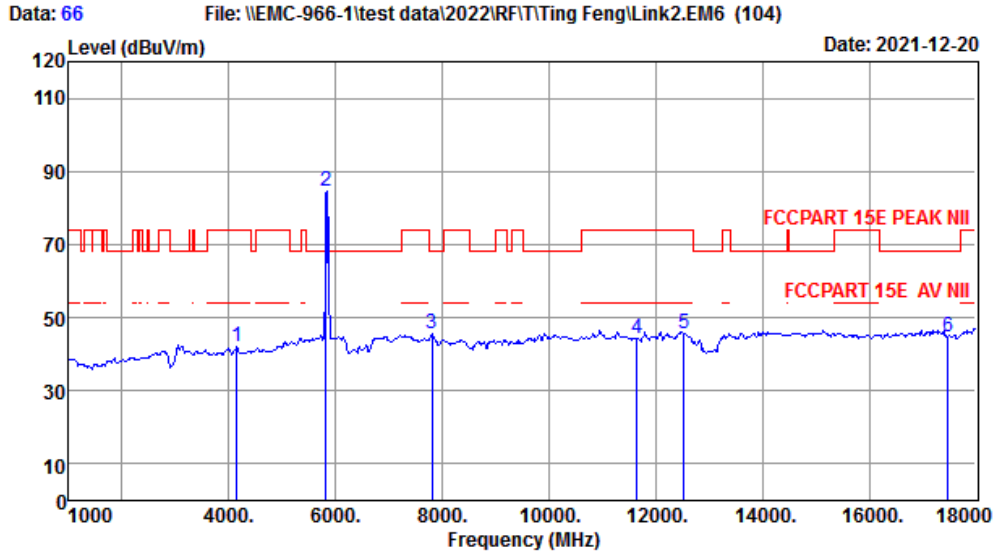

Site no. : 1# 966 Chamber Data no. : 66
 Dis. / Ant. : 3m ANT9120D 1-18G Ant. pol. : HORIZONTAL
 Limit : FCCPART 15E PEAK NII
 Env. / Ins. : Temp:23.4';Humi:50%;Press:101.52kPa
 Engineer : JBR
 EUT : MULTIROOM WIFI PLAYER
 Power : AC 120V/60Hz
 M/N : LINK2
 Test Mode : IEEE 802.11ac 20 TX 5825MHz

	Freq. (MHz)	Ant. Factor (dB/m)	Cable Loss (dB)	Amp Factor (dB)	Reading (dBuV)	Emission Level (dBuV/m)	Limits (dBuV/m)	Margin (dB)	Remark
1	4145.00	29.86	2.93	34.53	43.93	42.19	74.00	31.81	Peak
2	5825.00	32.83	4.11	34.37	82.16	84.73	68.20	-16.53	Peak
3	7800.00	36.86	5.60	34.88	38.24	45.82	68.20	22.38	Peak
4	11650.00	39.90	6.08	34.69	33.04	44.33	74.00	29.67	Peak
5	12526.00	39.64	6.21	34.59	34.54	45.80	74.00	28.20	Peak
6	17475.00	44.70	7.89	34.35	26.40	44.64	68.20	23.56	Peak

Remarks: 1. Emission Level= Antenna Factor + Cable Loss - Amp Factor + Reading.
 2. Margin= Limit - Emission Level.
 3. The emission levels that are 20dB below the official limit are not reported.

Note:

1. The amplitude of 18GHz to 25GHz spurious emission that is attenuated by more than 20dB below the permissible limit has no need to be reported.

Radiated Band Edge

EST Technology

Chilingxiang, Qishantou, Santun,
Houjie, Dongguan, Guangdong, China
Tel: +86-769-83081888
Fax: +86-769-83081878

Data: 67 File: \\EMC-966-1\test data\2022\RFITTING Feng\Link2.EM6 (104)

Date: 2021-12-20

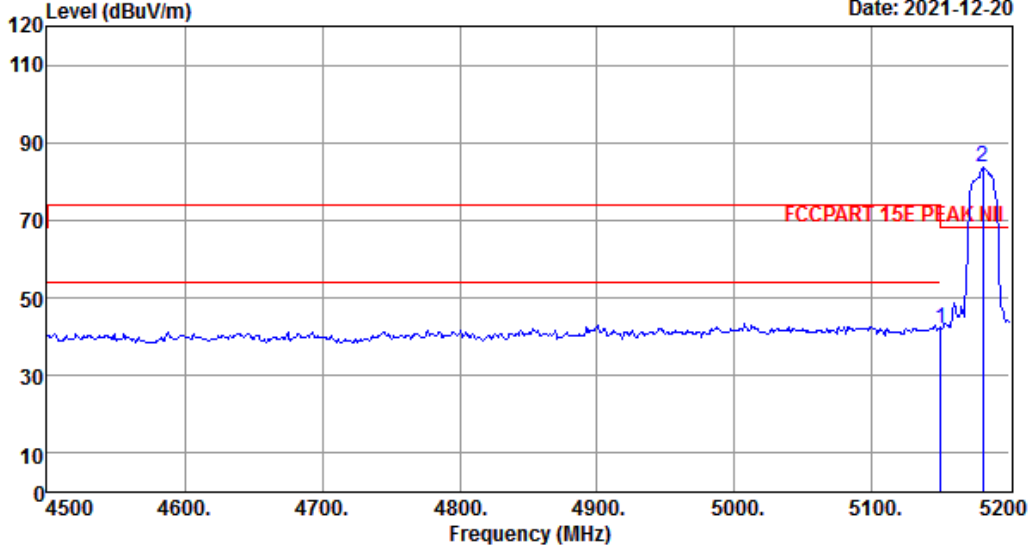

Site no. : 1# 966 Chamber Data no. : 67
 Dis. / Ant. : 3m ANT9120D 1-18G Ant. pol. : HORIZONTAL
 Limit : FCCPART 15E PEAK NII
 Env. / Ins. : Temp:23.4';Humi:50%;Press:101.52kPa
 Engineer : JBR
 EUT : MULTIROOM WIFI PLAYER
 Power : AC 120V/60Hz
 M/N : LINK2
 Test Mode : IEEE 802.11ac 20 TX 5180MHz

	Freq. (MHz)	Ant. Factor (dB/m)	Cable Loss (dB)	Amp Factor (dB)	Reading (dBuV)	Emission Level (dBuV/m)	Limits (dBuV/m)	Margin (dB)	Remark
1	5150.00	32.13	3.50	34.64	41.22	42.21	68.20	25.99	Peak
2	5180.40	32.20	3.52	34.63	82.68	83.77	68.20	-15.57	Peak

Remarks: 1. Emission Level= Antenna Factor + Cable Loss - Amp Factor + Reading.
 2. Margin= Limit - Emission Level.
 3. The emission levels that are 20dB below the official limit are not reported.

EST Technology

Chilingxiang, Qishantou, Santun,
Houjie, Dongguan, Guangdong, China
Tel: +86-769-83081888
Fax: +86-769-83081878

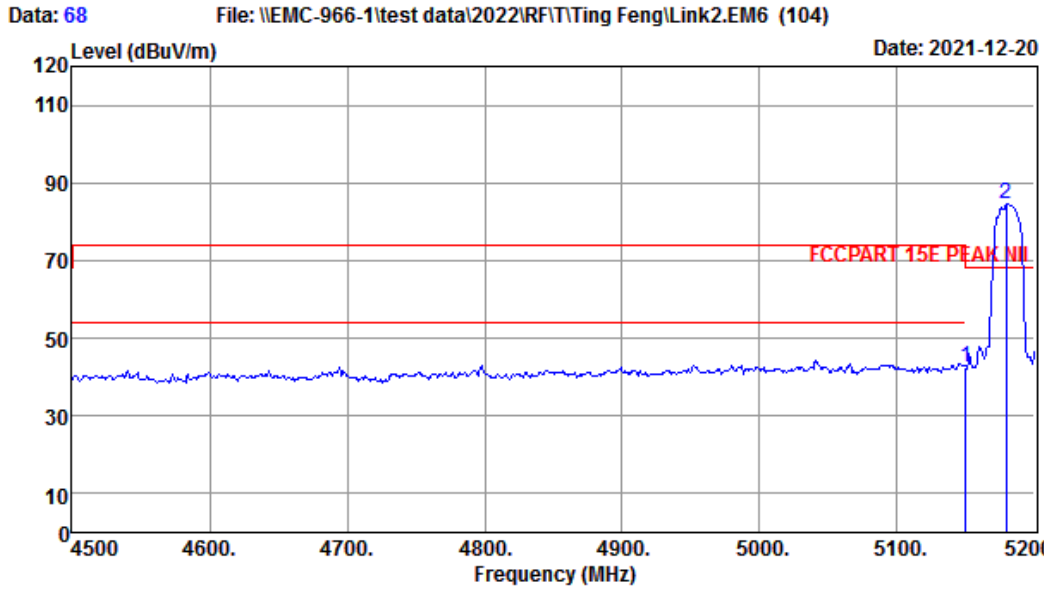

Site no. : 1# 966 Chamber Data no. : 68
 Dis. / Ant. : 3m ANT9120D 1-18G Ant. pol. : VERTICAL
 Limit : FCCPART 15E PEAK NII
 Env. / Ins. : Temp:23.4';Humi:50%;Press:101.52kPa
 Engineer : JBR
 EUT : MULTIROOM WIFI PLAYER
 Power : AC 120V/60Hz
 M/N : LINK2
 Test Mode : IEEE 802.11ac 20 TX 5180MHz

	Freq. (MHz)	Ant. Factor (dB/m)	Cable Loss (dB)	Amp Factor (dB)	Reading (dBuV)	Emission Level (dBuV/m)	Limits (dBuV/m)	Margin (dB)	Remark
1	5150.00	32.13	3.50	34.64	41.56	42.55	68.20	25.65	Peak
2	5179.00	32.20	3.52	34.63	83.60	84.69	68.20	-16.49	Peak

Remarks: 1. Emission Level= Antenna Factor + Cable Loss - Amp Factor + Reading.
 2. Margin= Limit - Emission Level.
 3. The emission levels that are 20dB below the official limit are not reported.

EST Technology

Chilingxiang, Qishantou, Santun,
Houjie, Dongguan, Guangdong, China
Tel: +86-769-83081888
Fax: +86-769-83081878

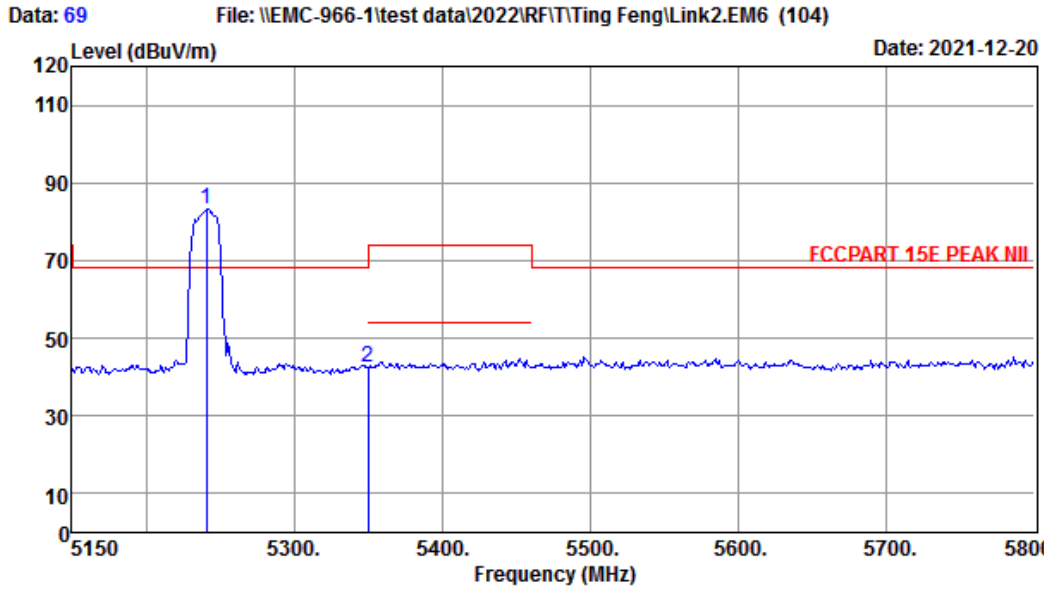

Site no. : 1# 966 Chamber Data no. : 69
 Dis. / Ant. : 3m ANT9120D 1-18G Ant. pol. : HORIZONTAL
 Limit : FCCPART 15E PEAK NII
 Env. / Ins. : Temp:23.4';Humi:50%;Press:101.52kPa
 Engineer : JBR
 EUT : MULTIROOM WIFI PLAYER
 Power : AC 120V/60Hz
 M/N : LINK2
 Test Mode : IEEE 802.11ac 20 TX 5240MHz

	Freq. (MHz)	Ant. Factor (dB/m)	Cable Loss (dB)	Amp Factor (dB)	Reading (dBuV)	Emission Level (dBuV/m)	Limits (dBuV/m)	Margin (dB)	Remark
1	5241.00	32.31	3.55	34.61	81.85	83.10	68.20	-14.90	Peak
2	5350.00	32.57	3.62	34.56	40.88	42.51	68.20	25.69	Peak

Remarks: 1. Emission Level= Antenna Factor + Cable Loss - Amp Factor + Reading.
 2. Margin= Limit - Emission Level.
 3. The emission levels that are 20dB below the official limit are not reported.

EST Technology

Chilingxiang, Qishantou, Santun,
Houjie, Dongguan, Guangdong, China
Tel: +86-769-83081888
Fax: +86-769-83081878

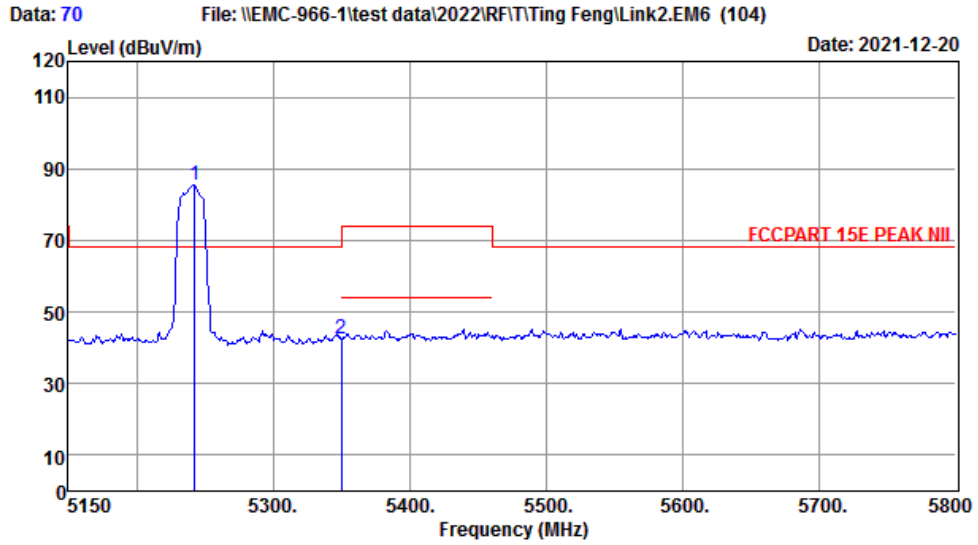

Site no. : 1# 966 Chamber Data no. : 70
 Dis. / Ant. : 3m ANT9120D 1-18G Ant. pol. : VERTICAL
 Limit : FCCPART 15E PEAK NII
 Env. / Ins. : Temp:23.4';Humi:50%;Press:101.52kPa
 Engineer : JBR
 EUT : MULTIROOM WIFI PLAYER
 Power : AC 120V/60Hz
 M/N : LINK2
 Test Mode : IEEE 802.11ac 20 TX 5240MHz

	Freq. (MHz)	Ant. Factor (dB/m)	Cable Loss (dB)	Amp Factor (dB)	Reading (dBuV)	Emission Level (dBuV/m)	Limits (dBuV/m)	Margin (dB)	Remark
1	5242.30	32.35	3.56	34.60	84.33	85.64	68.20	-17.44	Peak
2	5350.00	32.57	3.62	34.56	40.71	42.34	68.20	25.86	Peak

Remarks: 1. Emission Level= Antenna Factor + Cable Loss - Amp Factor + Reading.
 2. Margin= Limit - Emission Level.
 3. The emission levels that are 20dB below the official limit are not reported.

Note:

1. The amplitude of 18GHz to 40GHz spurious emission that is attenuated by more than 20dB below the permissible limit has no need to be reported.
2. All test mode had been pre-test, only Low/Middle/High Channel of the worst case modulation mode was reported



Band Edge

IEEE 802.11a 5745

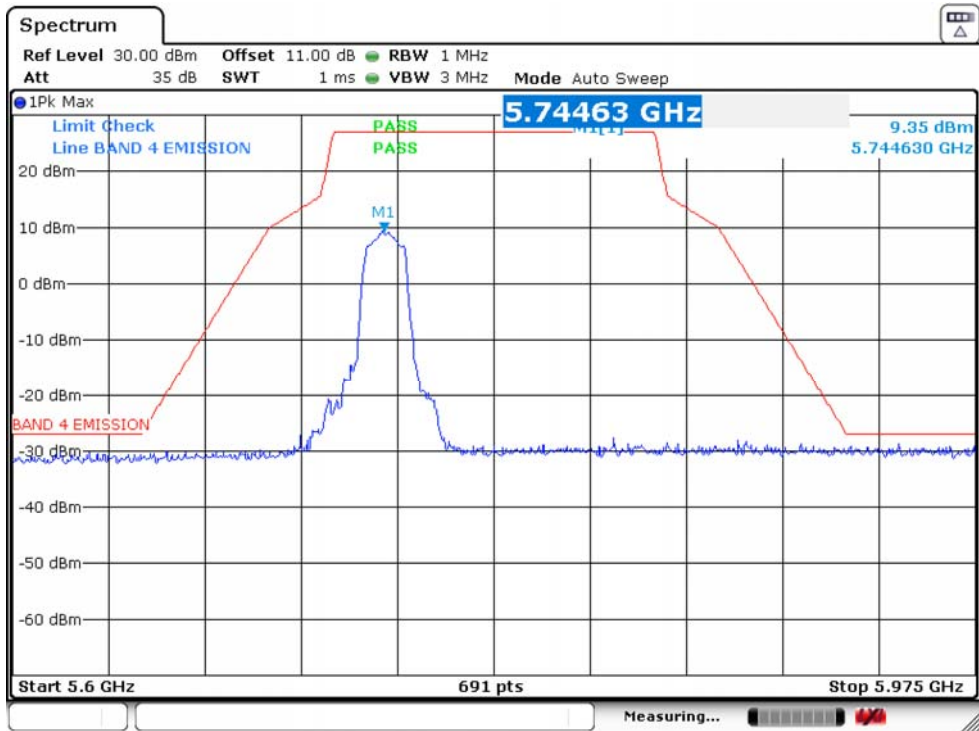

IEEE 802.11a 5785

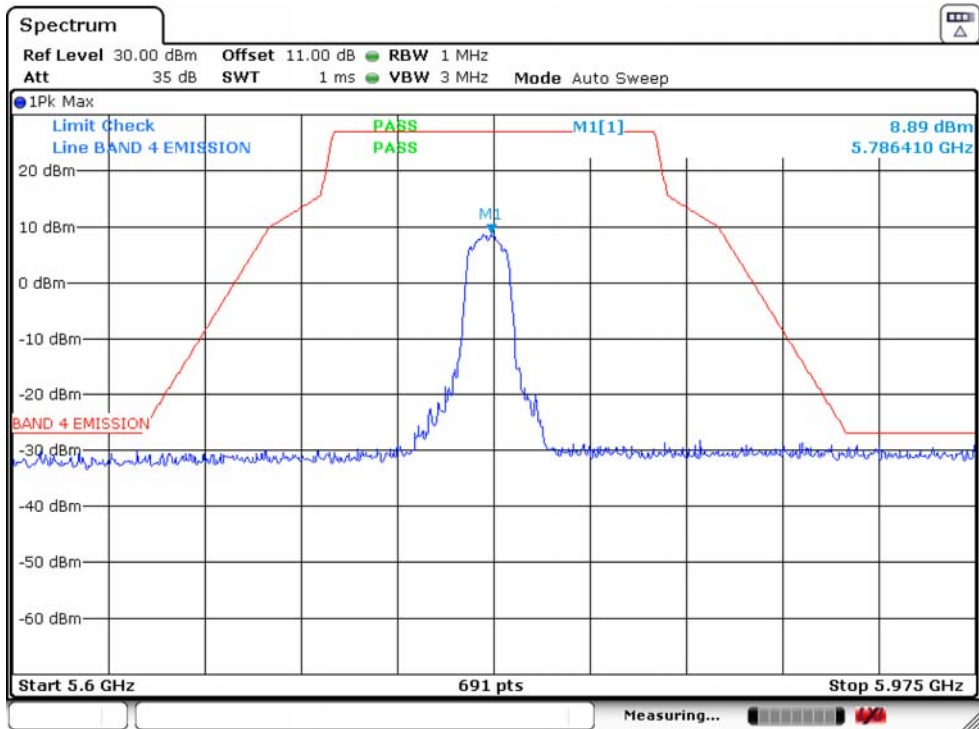

IEEE 802.11a 5825

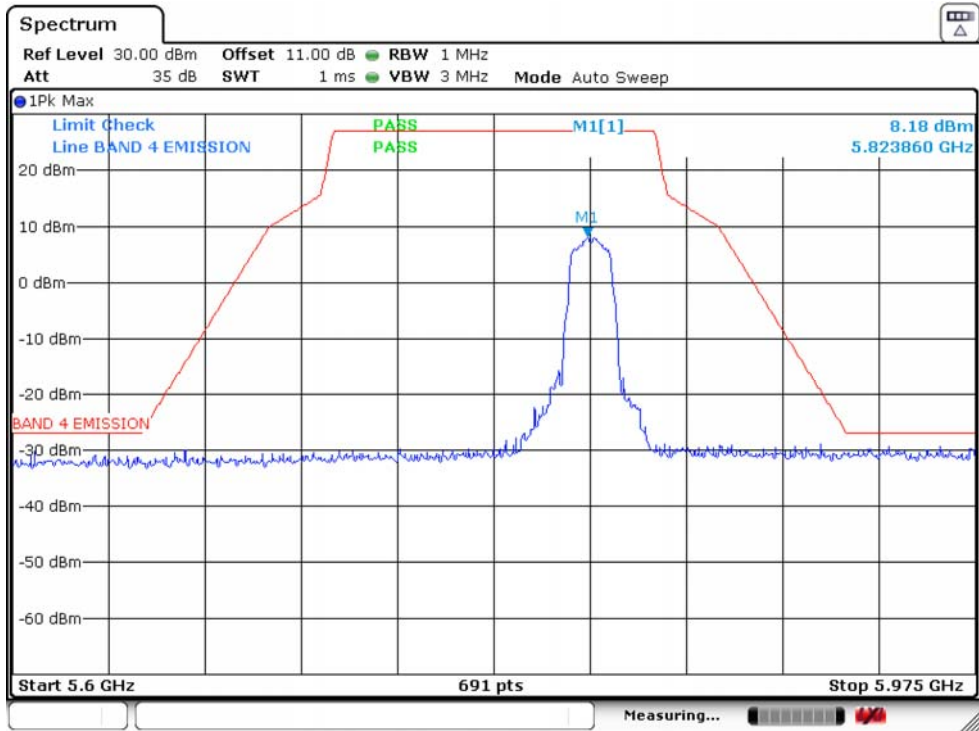

IEEE 802.11n HT20 5745

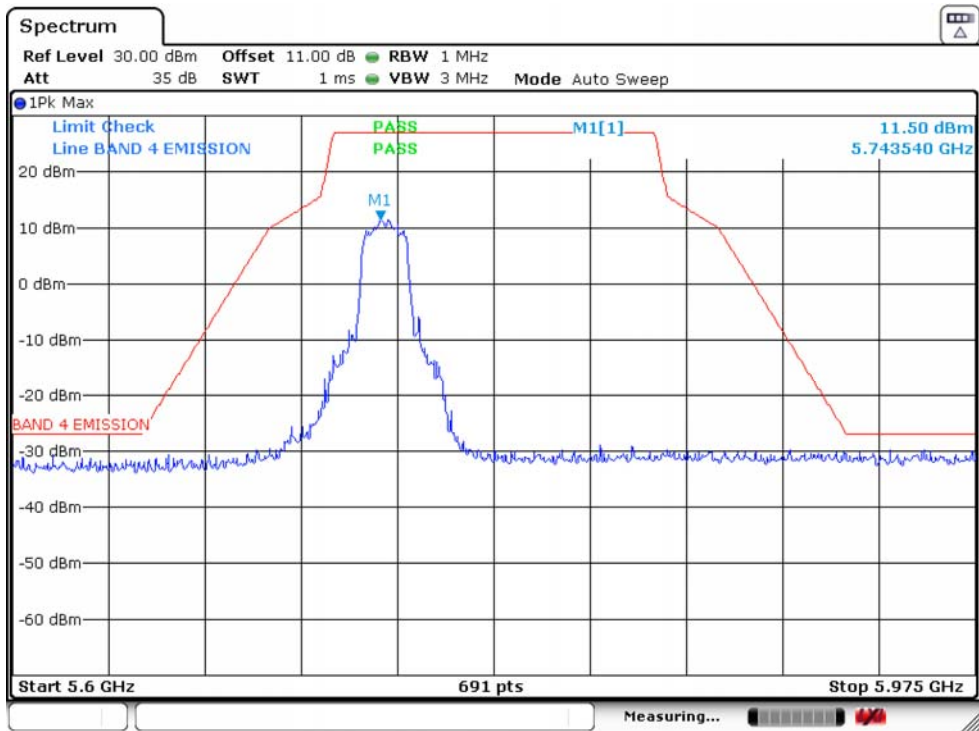

IEEE 802.11n HT20 5785

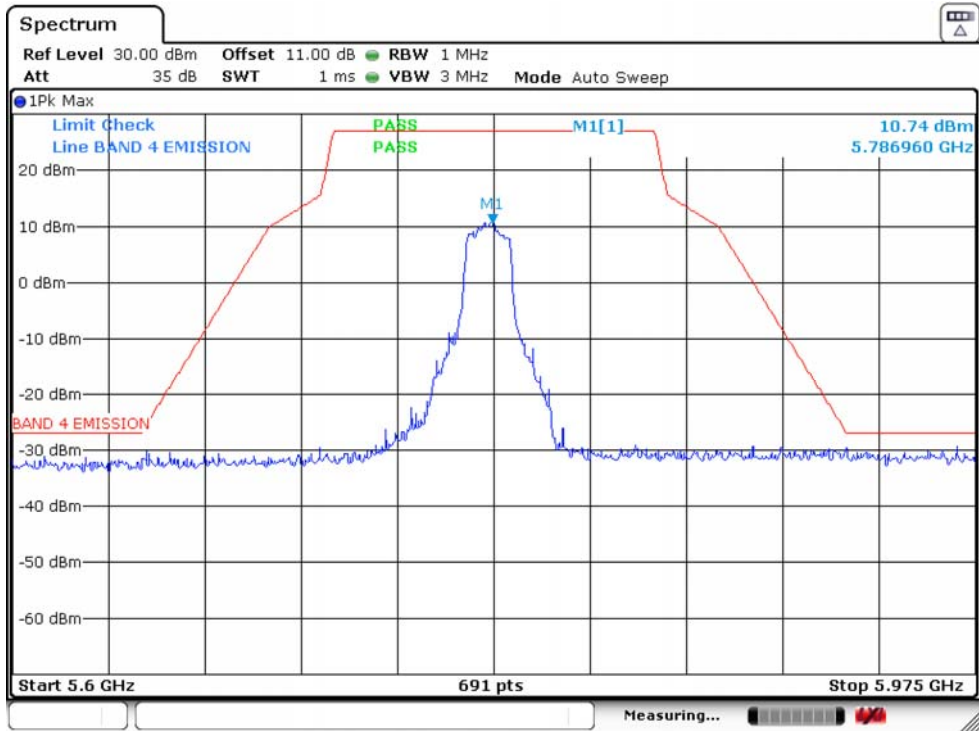

IEEE 802.11n HT20 5825

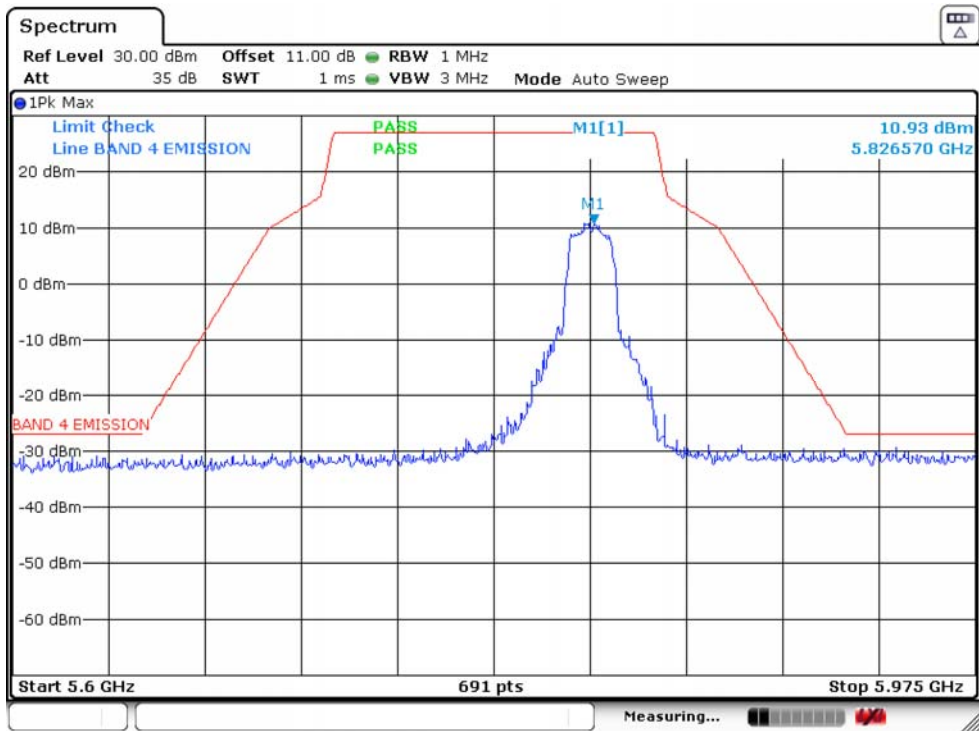

IEEE 802.11ac VHT20 5745

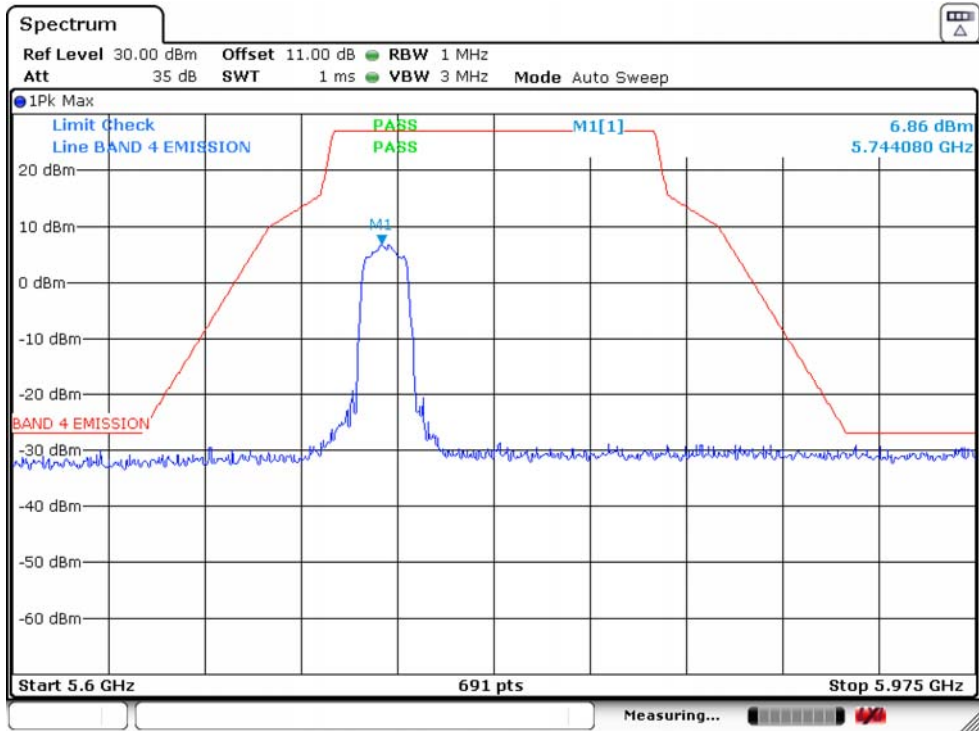

IEEE 802.11ac VHT20 5785

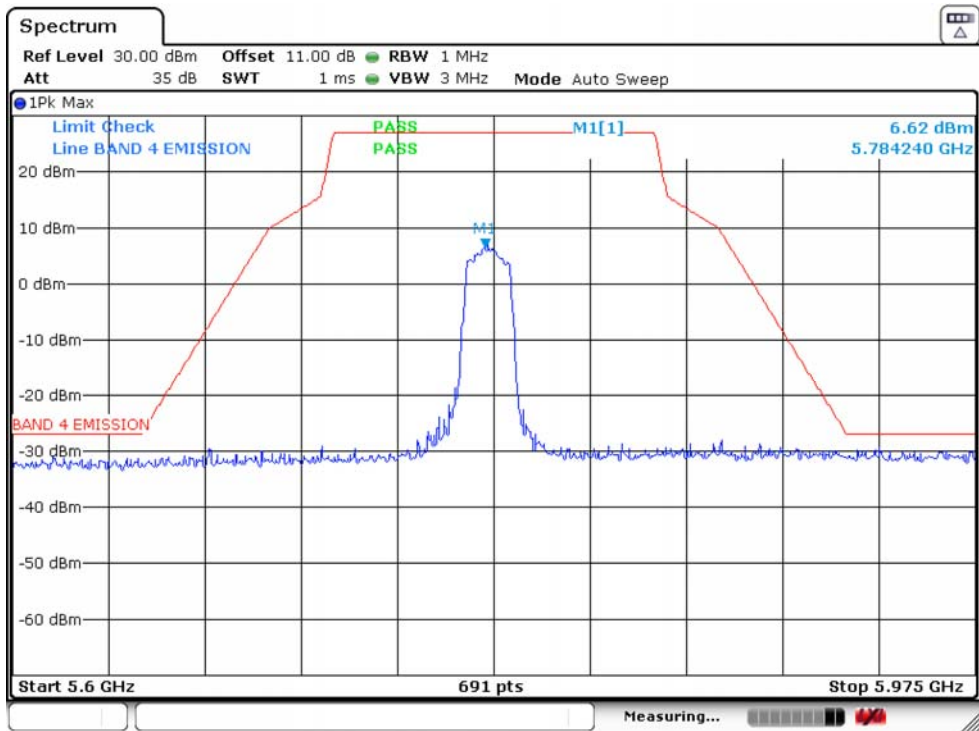

IEEE 802.11ac VHT20 5825

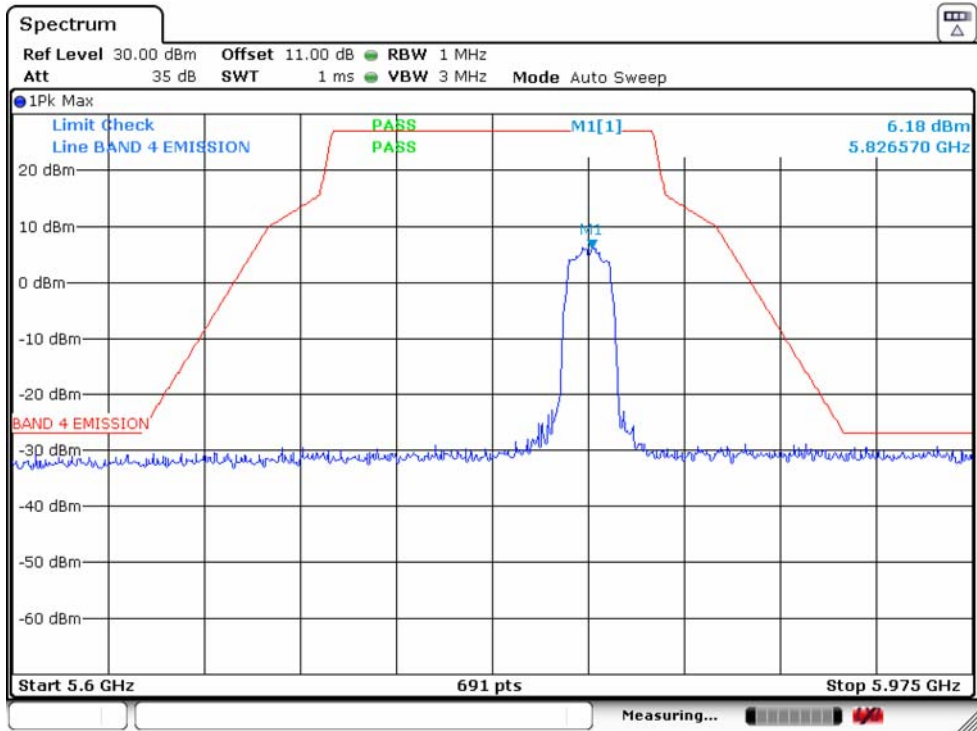

IEEE 802.11n HT40 5755

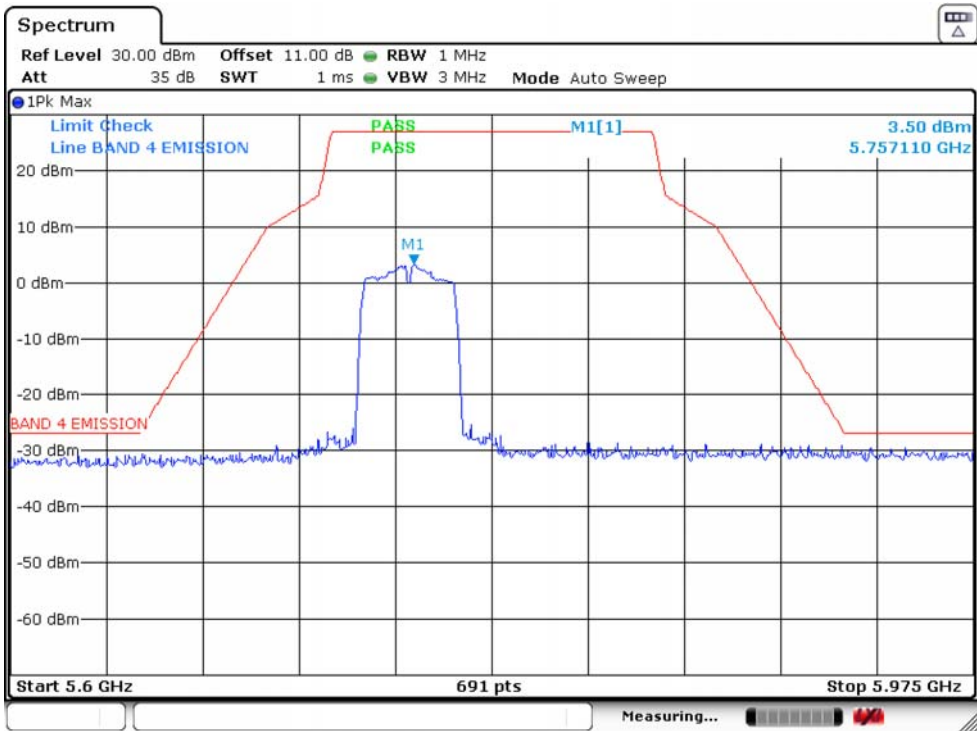

IEEE 802.11n HT40 5795

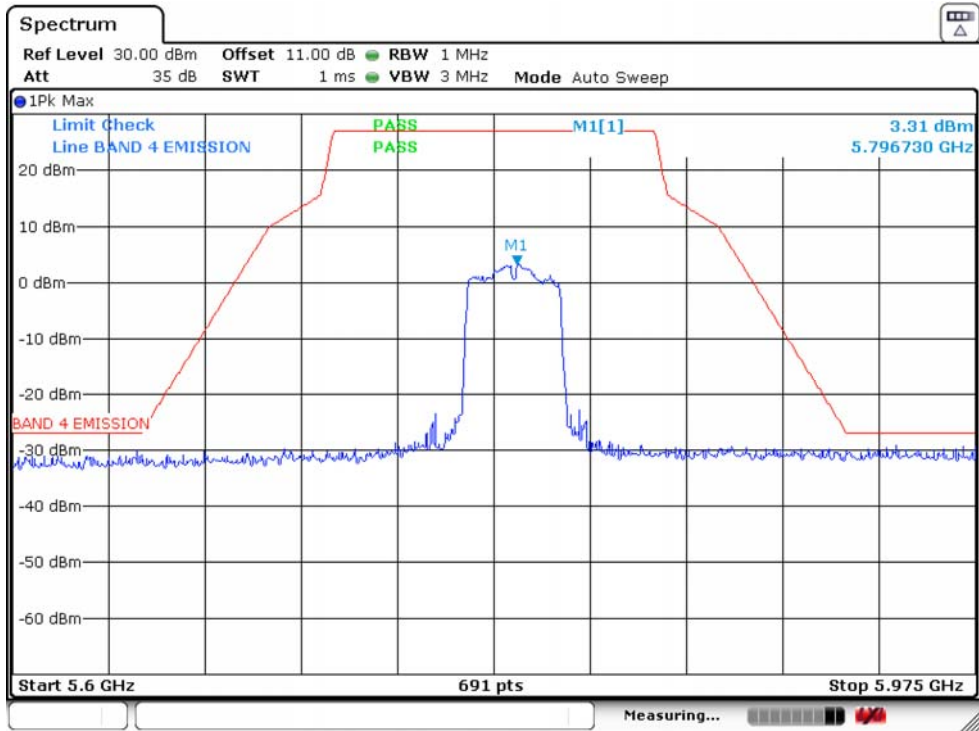

IEEE 802.11ac VHT40 5755

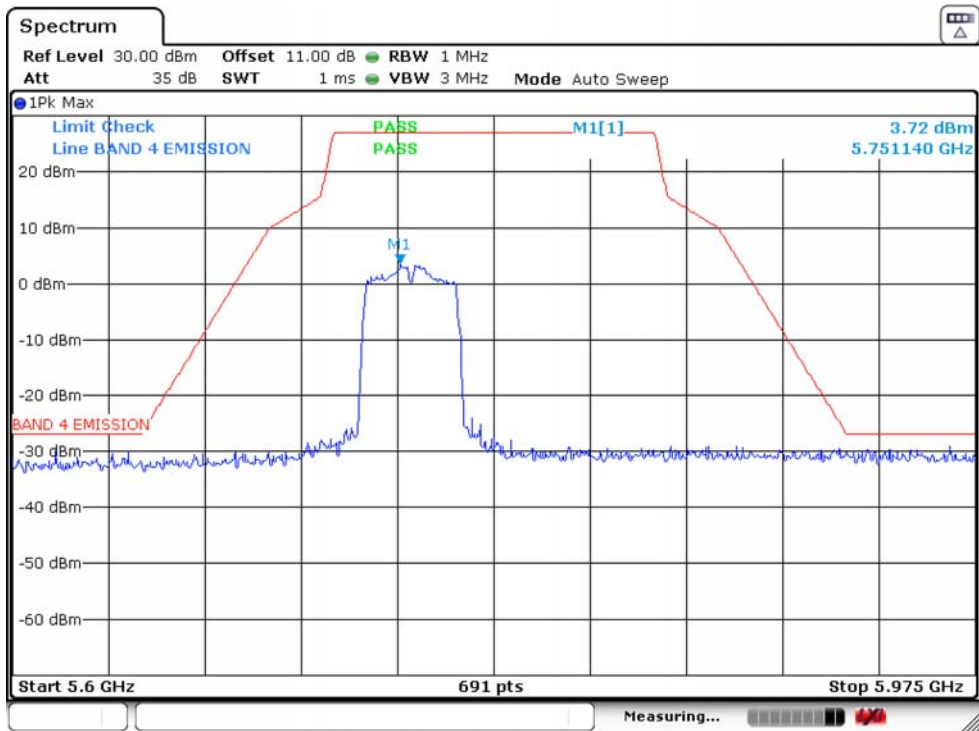

IEEE 802.11ac VHT40 5795

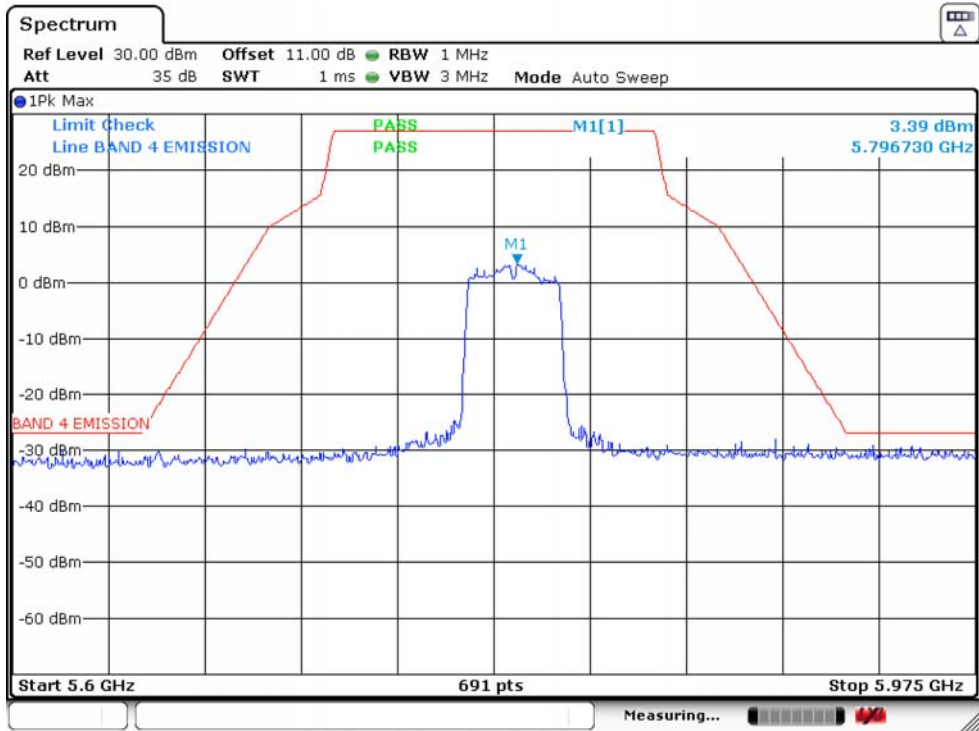

IEEE 802.11ac VHT80 5775

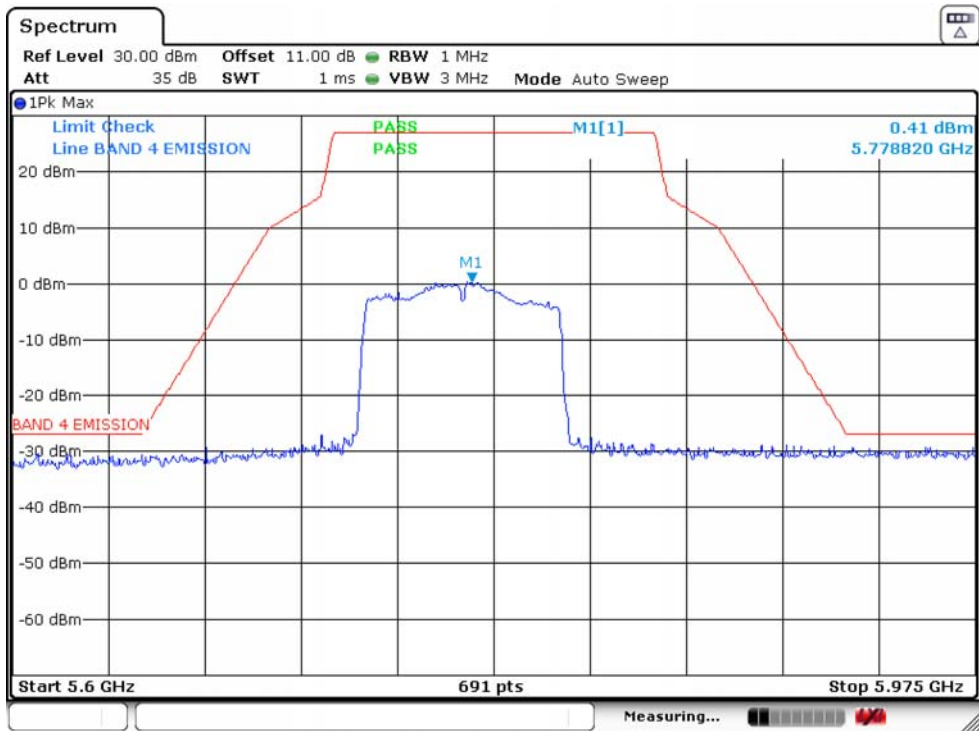

All modulations are tested, only worst case ANT 2 test data is reported.
 And The test data has a margin of more than 3dB, then the 5.8G band edge test data for MIMO mode are complies regulations.

18000MHz-40000MHz

Pass

Note: The amplitude of spurious emission that is attenuated by more than 20dB below the permissible limit has no need to be reported.

7. FREQUENCY STABILITY

7.1. Limit

Manufacturers of U-NII devices are responsible for ensuring frequency stability such that an emission is maintained within the band of operation under all conditions of normal operation as specified in the operational description.

7.2. Test Setup

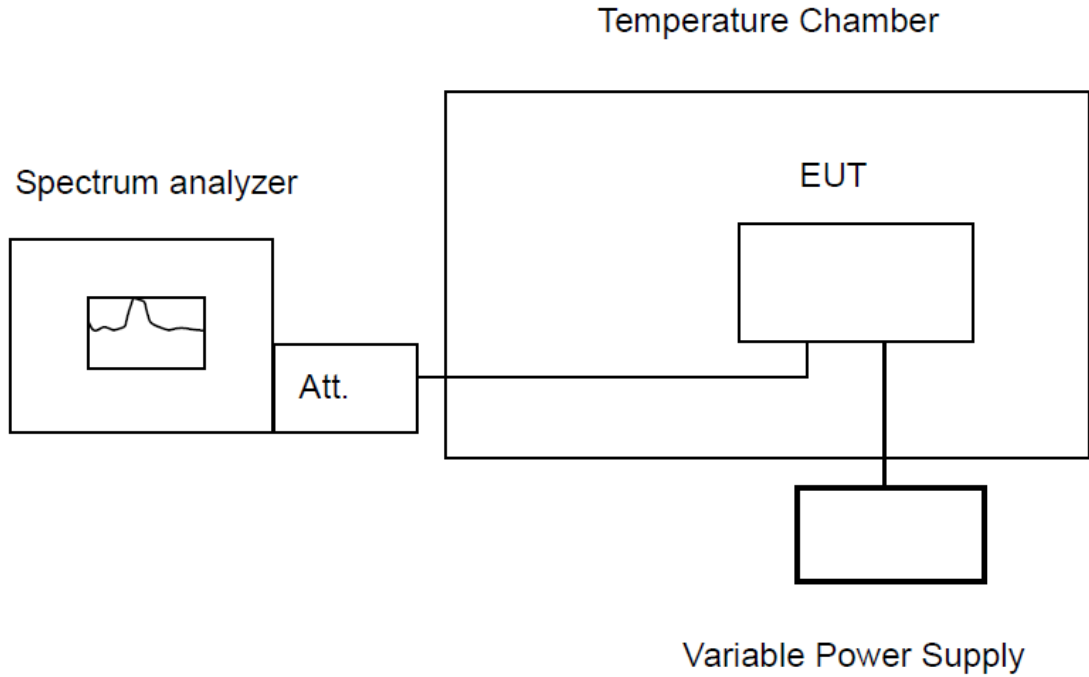

7.3. Spectrum Analyzer Setting

Spectrum Parameters	Setting
RBW	10KHz
VBW	10KHz
Span	200KHz
Sweep Time	Auto
Detector	PEAK
Trace Mode	Max Hold

7.4. Test Procedure

For measurement frequency stability under temperature variation :

- a. Supply the EUT with a nominal ac voltage or install a new or fully charged battery in the EUT.
- b. Turn the EUT OFF and place it inside the environmental temperature chamber.
- c. Connect EUT antenna terminal to the spectrum analyzer with RF cable.
- d. Spectrum analyzer setting parameters in accordance with section 7.3.
- e. Set the temperature control on the chamber to the Specified temperature and allow the oscillator heater and the chamber temperature to stabilize.
- f. Turn the EUT ON with the rated voltage, and the EUT transmit continuously with maximum output power.
- g. Record the operating frequency at startup, and at 2 minutes, 5 minutes, and 10 minutes after the EUT is energized.
- h. Repeat step d through step f to measured the temperature form -20°C to $+50^{\circ}\text{C}$ in 10°C steps.

For frequency stability under voltage variation:

- a. Supply the EUT with a nominal ac voltage or install a new or fully charged battery in the EUT.
- b. Turn the EUT OFF and place it inside the environmental temperature chamber.
- c. Connect EUT antenna terminal to the spectrum analyzer with RF cable.
- d. Spectrum analyzer setting parameters in accordance with section 7.3.
- e. Unless otherwise specified, set the temperature control on the chamber to the ambient room temperature ($+15^{\circ}\text{C}$ to $+25^{\circ}\text{C}$) and allow the oscillator heater and the chamber temperature to stabilize.
- f. Turn the EUT ON with the rated voltage, and the EUT transmit continuously with maximum output power.
- g. Record the operating frequency.
- h. Repeat step d through step f to measured the varied from 85% to 115% of the rated voltage.

7.5. Test Result

Frequency (MHz)	Voltage (V)	Temperature (°C)	Time (minutes)	Measurement Value (MHz)	Frequency Error (ppm)
5180	120	50	0	5179.979846	-3.89
			2	5179.980024	-3.86
			5	5179.979532	-3.95
			10	5179.979714	-3.92
	120	40	0	5179.979947	-3.87
			2	5179.980043	-3.85
			5	5179.979488	-3.96
			10	5179.980319	-3.80
	120	30	0	5179.980156	-3.83
			2	5179.980005	-3.86
			5	5179.979488	-3.96
			10	5179.980096	-3.84
	120	20	0	5179.980072	-3.85
			2	5179.980230	-3.82
			5	5179.980115	-3.84
			10	5179.979763	-3.91
	120	10	0	5179.980263	-3.81
			2	5179.980512	-3.76
			5	5179.979672	-3.92
			10	5179.979599	-3.94
	120	0	0	5179.980371	-3.79
			2	5179.980048	-3.85
			5	5179.979762	-3.91
			10	5179.980326	-3.80
	120	-10	0	5179.979771	-3.91
			2	5179.980010	-3.86
			5	5179.980182	-3.83
			10	5179.980158	-3.83
	120	-20	0	5179.980370	-3.79
			2	5179.980591	-3.75
			5	5179.980344	-3.79
			10	5179.980453	-3.77
120	20	/	5179.980283	-3.81	
102	20	/	5179.980047	-3.85	
138	20	/	5179.980158	-3.83	
MAX Frquency Error(ppm)					-3.75

Frequency (MHz)	Voltage (V)	Temperature (°C)	Time (minutes)	Measurement Value (MHz)	Frequency Error (ppm)
5745	120	50	0	5744.977297	-3.95
			2	5744.977273	-3.96
			5	5744.977180	-3.97
			10	5744.976833	-4.03
	120	40	0	5744.977127	-3.98
			2	5744.977302	-3.95
			5	5744.976476	-4.09
			10	5744.977053	-3.99
	120	30	0	5744.976761	-4.05
			2	5744.976882	-4.02
			5	5744.976981	-4.01
			10	5744.976666	-4.06
	120	20	0	5744.977130	-3.98
			2	5744.976938	-4.01
			5	5744.977337	-3.94
			10	5744.976620	-4.07
	120	10	0	5744.976851	-4.03
			2	5744.977173	-3.97
			5	5744.976926	-4.02
			10	5744.977163	-3.98
	120	0	0	5744.977213	-3.97
			2	5744.976757	-4.05
			5	5744.976549	-4.08
			10	5744.976924	-4.02
	120	-10	0	5744.976994	-4.00
			2	5744.976482	-4.09
			5	5744.977429	-3.93
			10	5744.976781	-4.04
	120	-20	0	5744.977097	-3.99
			2	5744.977103	-3.99
			5	5744.977216	-3.97
			10	5744.977096	-3.99
120	20	/	5744.977384	-3.94	
102	20	/	5744.977384	-3.94	
138	20	/	5744.977387	-3.94	
MAX Frquency Error(ppm)					-3.93

8. AC POWER LINE CONDUCTED EMISSIONS

8.1. Limit

Frequency	Maximum RF Line Voltage	
	Quasi-Peak Level dB(μV)	Average Level dB(μV)
150kHz ~ 500kHz	66 ~ 56*	56 ~ 46*
500kHz ~ 5MHz	56	46
5MHz ~ 30MHz	60	50

Notes:

1. * Decreasing linearly with logarithm of frequency.
2. The lower limit shall apply at the transition frequencies.

8.2. Test Setup

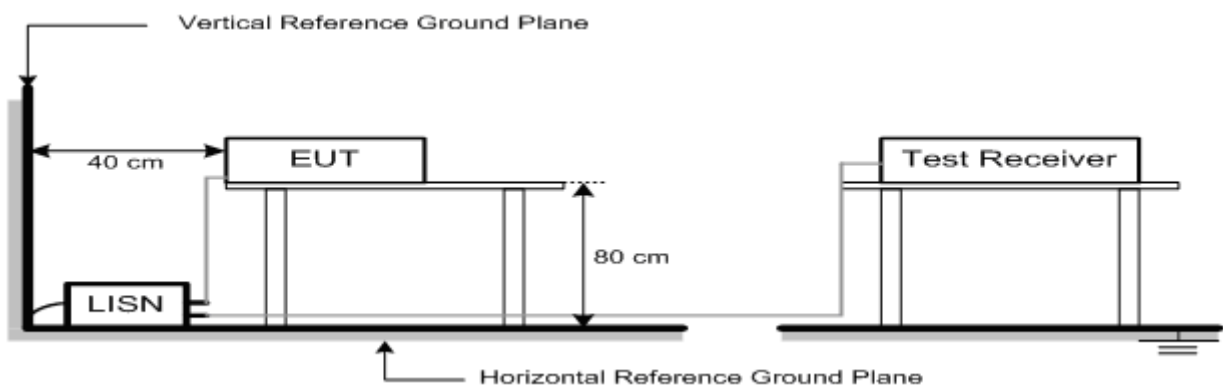

8.3. Spectrum Analyzer Setting

Spectrum Parameters	Setting
RBW	9KHz
VBW	9KHz
Start frequency	150KHz
Stop frequency	30MHz
Sweep Time	Auto
Detector	QP/AVG
Trace Mode	Max Hold

8.4. Test Procedure

- a. The EUT was placed on a non-metallic table, 80cm above the ground plane.
- b. The EUT Power connected to the power mains through a line impedance stabilization network.
- c. Provides a 50 ohm coupling impedance for the EUT (Please refer the block diagram of the test setup and photographs).
- d. Set the EUT transmit continuously with maximum output power.
- e. Spectrum analyzer setting parameters in accordance with section 8.3.
- f. The AC line are checked to find out the maximum conducted emission. In order to find the maximum emission levels, the relative positions of equipment and all of the interface cables shall be changed according to ANSI C63.10: 2013 on Conducted Emission Test.
- g. Record the results in the test report.

8.5. Test Result

EST Technology

Chilingxiang, Qishantou, Santun,
Houjie, Dongguan, Guangdong, China
Tel: +86-769-83081888
Fax: +86-769-83081878

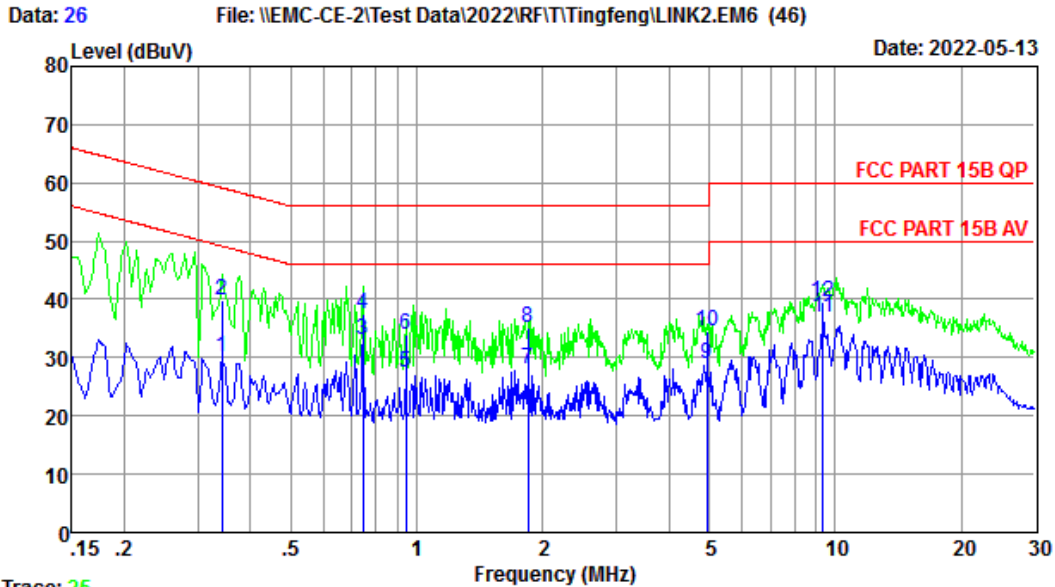

Trace: 25
 Site no : 2#CE Shield Room Data no. : 26
 Env. / Ins. : Temp:23.5°C Humi:56% Press:101.80kPa LINE Phase : NEUTRAL
 Limit : FCC PART 15B QP
 Engineer : ZSX
 EUT : MULTIROOM WIFI PLAYER
 Power : DC 12V From Adapter Input AC 240V/60Hz
 M/N : LINK2
 Test Mode : TX Mode

	Freq. (MHz)	LISN Factor (dB)	Cable Loss (dB)	Reading (dBuV)	Emission Level (dBuV)	Limits (dBuV)	Margin (dB)	Remark
1	0.3428	9.76	9.92	10.54	30.22	49.13	18.91	Average
2	0.3428	9.76	9.92	20.24	39.92	59.13	19.21	QP
3	0.7430	9.79	9.93	13.46	33.18	46.00	12.82	Average
4	0.7430	9.79	9.93	17.85	37.57	56.00	18.43	QP
5	0.9431	9.85	9.94	7.56	27.35	46.00	18.65	Average
6	0.9431	9.85	9.94	14.21	34.00	56.00	22.00	QP
7	1.8483	9.93	9.95	8.11	27.99	46.00	18.01	Average
8	1.8483	9.93	9.95	15.14	35.02	56.00	20.98	QP
9	4.9257	10.06	10.00	8.91	28.97	46.00	17.03	Average
10	4.9257	10.06	10.00	14.47	34.53	56.00	21.47	QP
11	9.3518	10.08	10.06	16.73	36.87	50.00	13.13	Average
12	9.3518	10.08	10.06	19.29	39.43	60.00	20.57	QP

Remarks: 1. Emission Level= LISN Factor + Cable Loss + Reading.
 2. Margin=Limit - Emission Level.
 3. If the average limit is met when using a quasi-peak detector, the EUT shall be deemed to meet both limits and measurement with average detector is unnecessary.

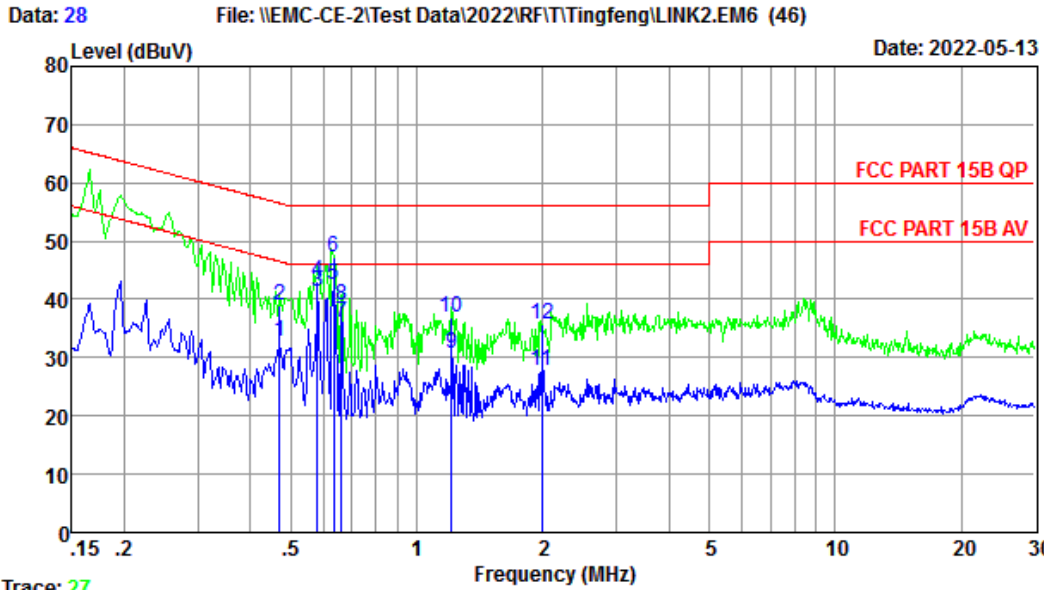

Trace: 27
 Site no : 2#CE Shield Room Data no. : 28
 Env. / Ins. : Temp:23.5°C Humi:56% Press:101.80kPa LINE Phase : LINE
 Limit : FCC PART 15B QP
 Engineer : ZSX
 EUT : MULTIROOM WIFI PLAYER
 Power : DC 12V From Adapter Input AC 240V/60Hz
 M/N : LINK2
 Test Mode : TX Mode

	Freq. (MHz)	LISN Factor (dB)	Cable Loss (dB)	Reading (dBuV)	Emission Level (dBuV)	Limits (dBuV)	Margin (dB)	Remark
1	0.4711	9.84	9.92	13.08	32.84	46.49	13.65	Average
2	0.4711	9.84	9.92	19.24	39.00	56.49	17.49	QP
3	0.5792	9.83	9.92	21.45	41.20	46.00	4.80	Average
4	0.5792	9.83	9.92	23.47	43.22	56.00	12.78	QP
5	0.6338	9.83	9.92	22.71	42.46	46.00	3.54	Average
6	0.6338	9.83	9.92	27.34	47.09	56.00	8.91	QP
7	0.6613	9.82	9.92	16.36	36.10	46.00	9.90	Average
8	0.6613	9.82	9.92	19.28	39.02	56.00	16.98	QP
9	1.2098	9.92	9.94	10.84	30.70	46.00	15.30	Average
10	1.2098	9.92	9.94	17.02	36.88	56.00	19.12	QP
11	1.9906	10.09	9.96	7.77	27.82	46.00	18.18	Average
12	1.9906	10.09	9.96	15.76	35.81	56.00	20.19	QP

Remarks: 1. Emission Level= LISN Factor + Cable Loss + Reading.
 2. Margin=Limit - Emission Level.
 3. If the average limit is met when using a quasi-peak detector,
 the EUT shall be deemed to meet both limits and measurement
 with average detector is unnecessary.

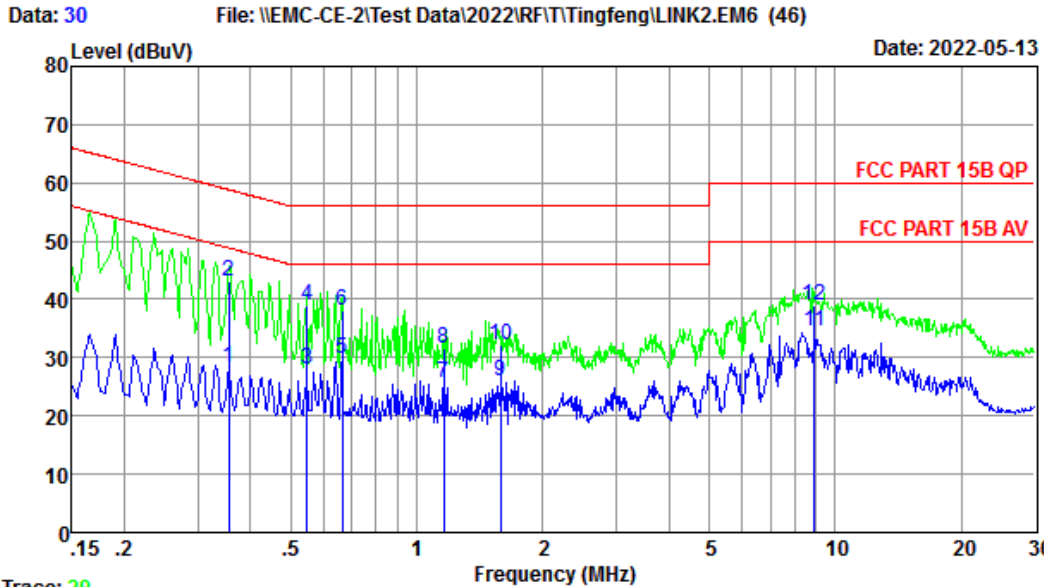

Trace: 29
 Site no : 2#CE Shield Room Data no. : 30
 Env. / Ins. : Temp:23.5°C Humi:56% Press:101.80kPa LINE Phase : LINE
 Limit : FCC PART 15B QP
 Engineer : ZSX
 EUT : MULTIROOM WIFI PLAYER
 Power : DC 12V From Adapter Input AC 120V/60Hz
 M/N : LINK2
 Test Mode : TX Mode

	Freq. (MHz)	LISN Factor (dB)	Cable Loss (dB)	Reading (dBuV)	Emission Level (dBuV)	Limits (dBuV)	Margin (dB)	Remark
1	0.3558	9.81	9.92	8.54	28.27	48.83	20.56	Average
2	0.3558	9.81	9.92	23.23	42.96	58.83	15.87	QP
3	0.5464	9.84	9.92	8.40	28.16	46.00	17.84	Average
4	0.5464	9.84	9.92	19.17	38.93	56.00	17.07	QP
5	0.6648	9.82	9.92	10.01	29.75	46.00	16.25	Average
6	0.6648	9.82	9.92	18.33	38.07	56.00	17.93	QP
7	1.1595	9.93	9.94	5.90	25.77	46.00	20.23	Average
8	1.1595	9.93	9.94	11.86	31.73	56.00	24.27	QP
9	1.5851	9.90	9.95	6.27	26.12	46.00	19.88	Average
10	1.5851	9.90	9.95	12.31	32.16	56.00	23.84	QP
11	8.9163	9.87	10.06	14.58	34.51	50.00	15.49	Average
12	8.9163	9.87	10.06	19.08	39.01	60.00	20.99	QP

Remarks: 1. Emission Level= LISN Factor + Cable Loss + Reading.
 2. Margin=Limit - Emission Level.
 3. If the average limit is met when using a quasi-peak detector, the EUT shall be deemed to meet both limits and measurement with average detector is unnecessary.

Data: 32 File: \\EMC-CE-2\Test Data\2022\RF\T\Tingfeng\LINK2.EM6 (46) Date: 2022-05-13

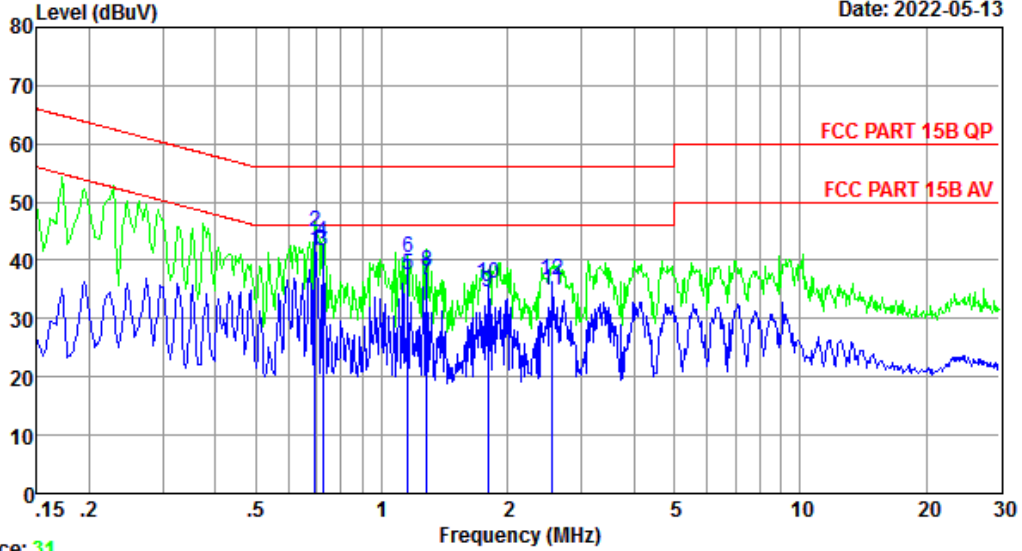

Trace: 31
 Site no : 2#CE Shield Room Data no. : 32
 Env. / Ins. : Temp:23.5°C Humi:56% Press:101.80kPa LINE Phase : NEUTRAL
 Limit : FCC PART 15B QP
 Engineer : ZSX
 EUT : MULTIROOM WIFI PLAYER
 Power : DC 12V From Adapter Input AC 120V/60Hz
 M/N : LINK2
 Test Mode : TX Mode

	Freq. (MHz)	LISN Factor (dB)	Cable Loss (dB)	Reading (dBuV)	Emission Level (dBuV)	Limits (dBuV)	Margin (dB)	Remark
1	0.6936	9.76	9.93	21.92	41.61	46.00	4.39	Average
2	0.6936	9.76	9.93	25.04	44.73	56.00	11.27	QP
3	0.7236	9.79	9.93	21.92	41.64	46.00	4.36	Average
4	0.7236	9.79	9.93	23.34	43.06	56.00	12.94	QP
5	1.1534	9.82	9.94	17.84	37.60	46.00	8.40	Average
6	1.1534	9.82	9.94	20.68	40.44	56.00	15.56	QP
7	1.2824	9.83	9.94	16.82	36.59	46.00	9.41	Average
8	1.2824	9.83	9.94	18.38	38.15	56.00	17.85	QP
9	1.7905	9.92	9.95	14.57	34.44	46.00	11.56	Average
10	1.7905	9.92	9.95	16.07	35.94	56.00	20.06	QP
11	2.5535	9.95	9.96	15.06	34.97	46.00	11.03	Average
12	2.5535	9.95	9.96	16.70	36.61	56.00	19.39	QP

Remarks: 1. Emission Level= LISN Factor + Cable Loss + Reading.
 2. Margin=Limit - Emission Level.
 3. If the average limit is met when using a quasi-peak detector, the EUT shall be deemed to meet both limits and measurement with average detector is unnecessary.

9. ANTENNA REQUIREMENTS

9.1. Limit

An intentional radiator shall be designed to ensure that no antenna other than that furnished by the responsible party shall be used with the device. The use of a permanently attached antenna or of an antenna that uses a unique coupling to the intentional radiator shall be considered sufficient to comply with the provisions of this section. The manufacturer may design the unit so that a broken antenna can be replaced by the user, but the use of a standard antenna jack or electrical connector is prohibited. This requirement does not apply to carrier current devices or to devices operated under the provisions of §§15.211, 15.213, 15.217, 15.219, 15.221, or §15.236. Further, this requirement does not apply to intentional radiators that must be professionally installed, such as perimeter protection systems and some field disturbance sensors, or to other intentional radiators which, in accordance with §15.31(d), must be measured at the installation site. However, the installer shall be responsible for ensuring that the proper antenna is employed so that the limits in this part are not exceeded.

9.2. Test Result

The antennas used for this product is integral antenna ,so compliance with antenna requirements.
(Please refer to the EUT photo for details)

10. TEST SETUP PHOTO

Conducted Test

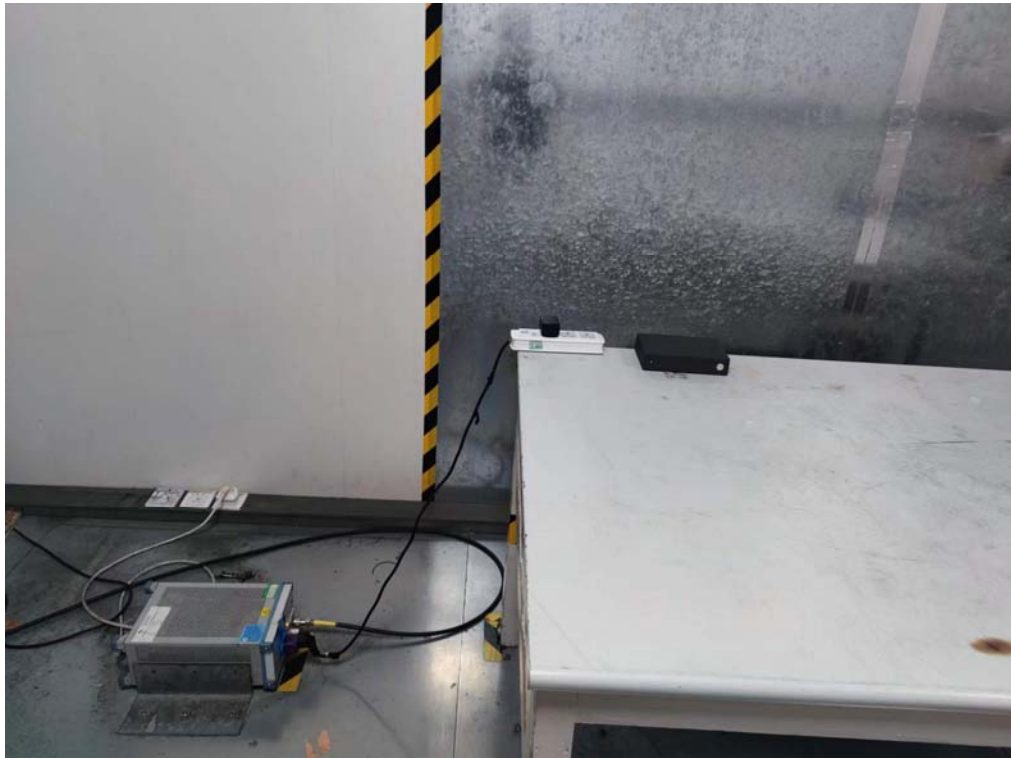

Radiated Test (Below 1GHz)

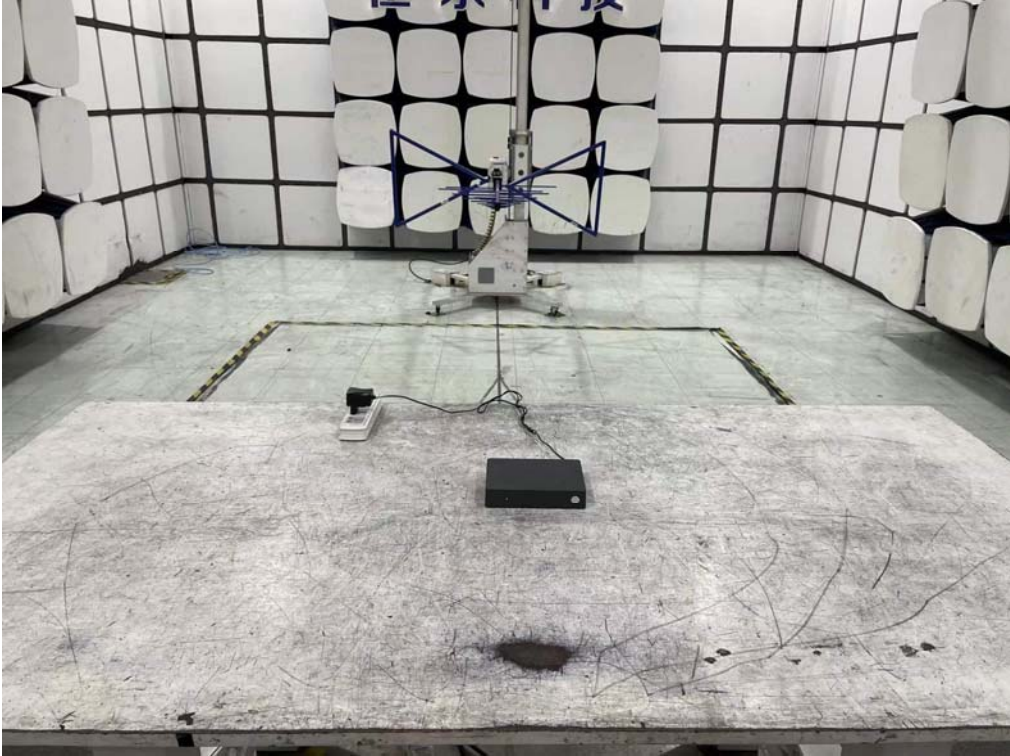

Radiated Test (Above 1GHz)



11. EUT PHOTO

External Photos
M/N: LINK2

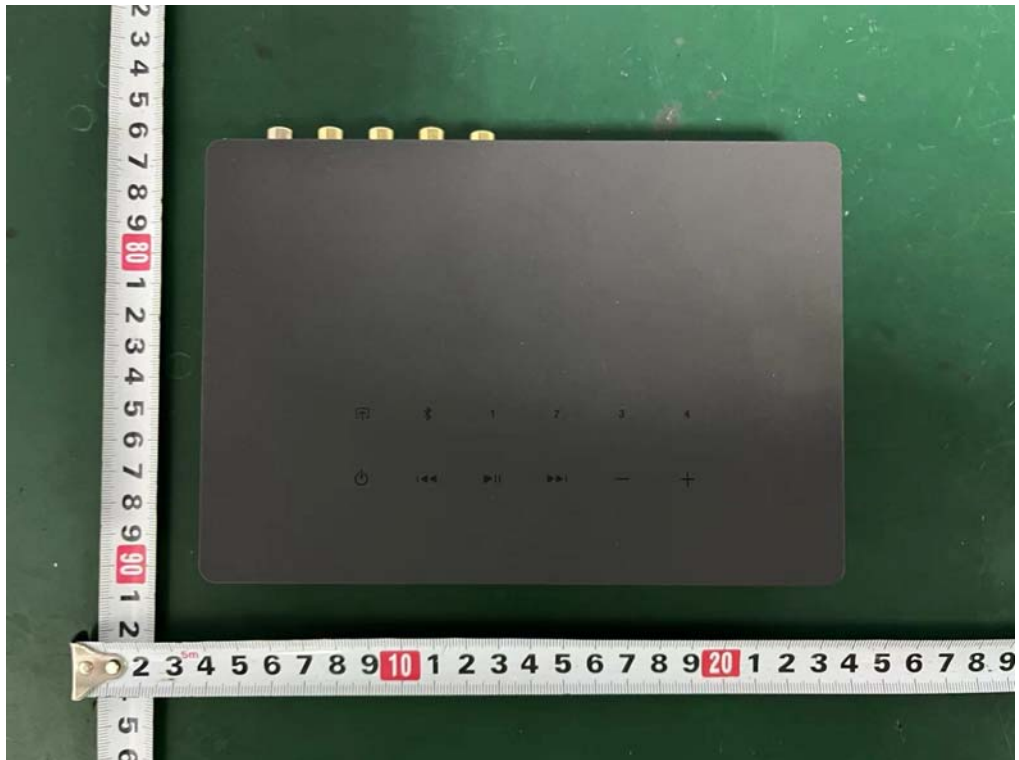

External Photos
M/N: LINK2



External Photos
M/N: LINK2

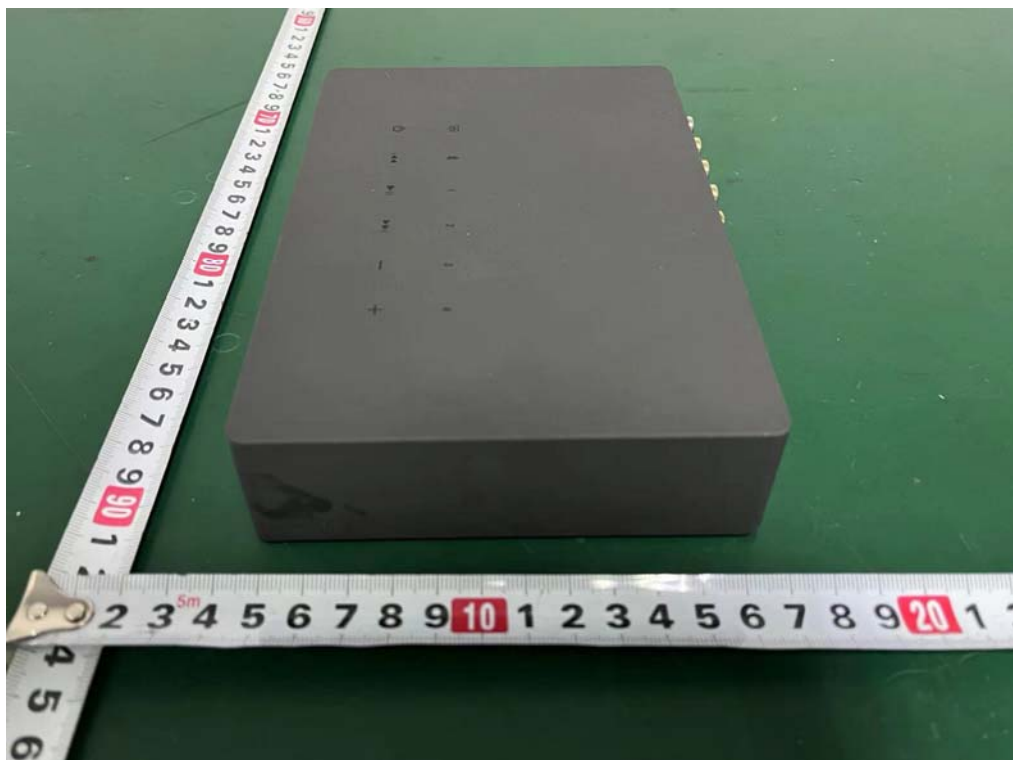

External Photos
M/N: LINK2



Power Supply



Power Supply



Internal Photos
M/N: LINK2

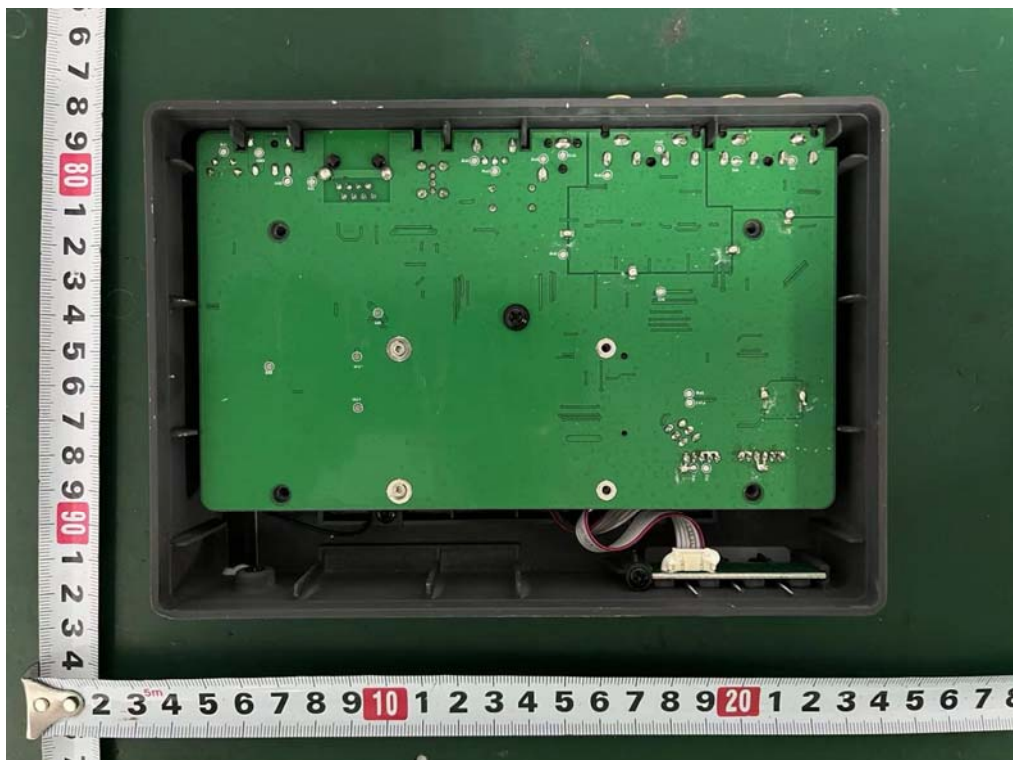
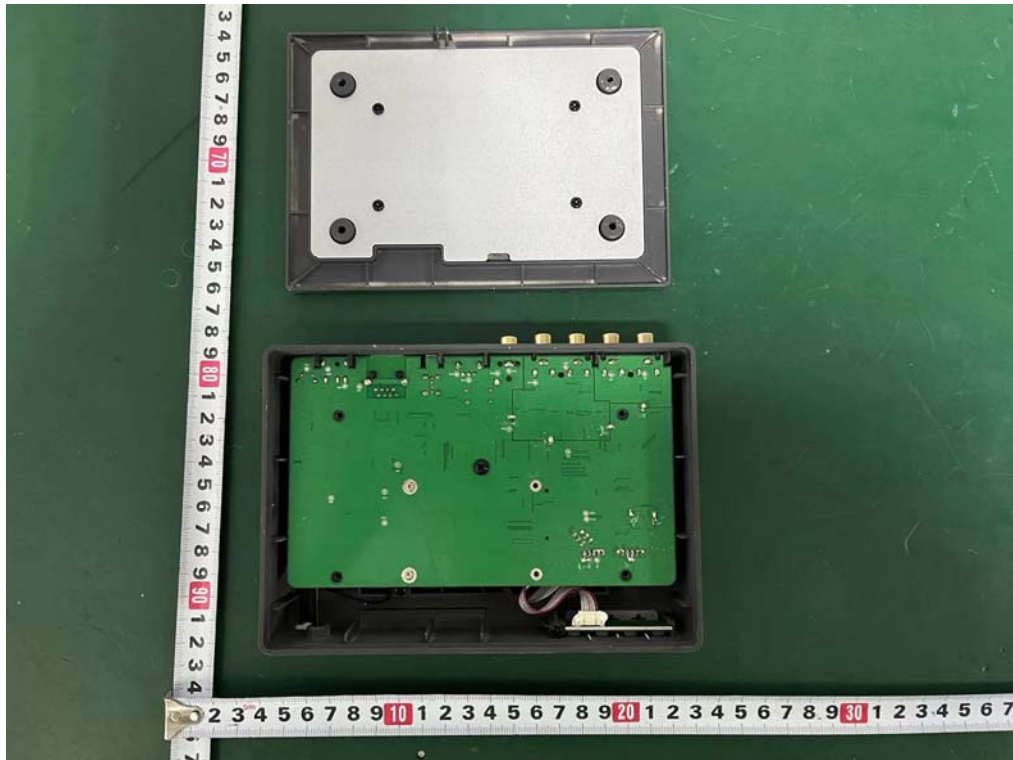

Internal Photos
M/N: LINK2

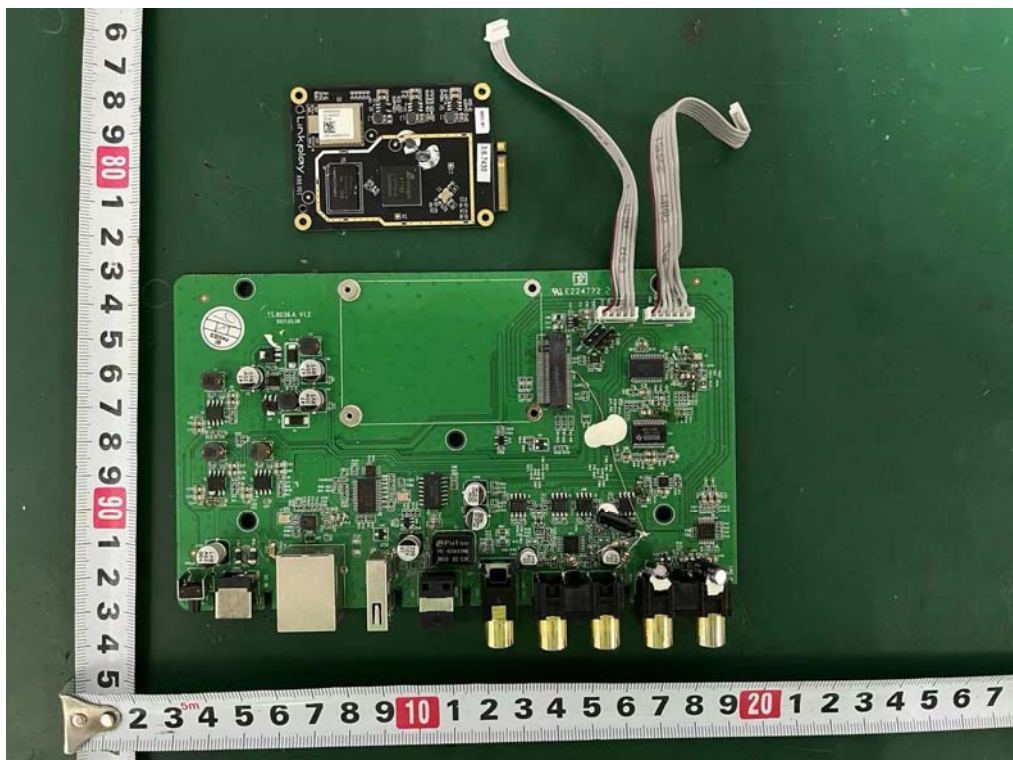
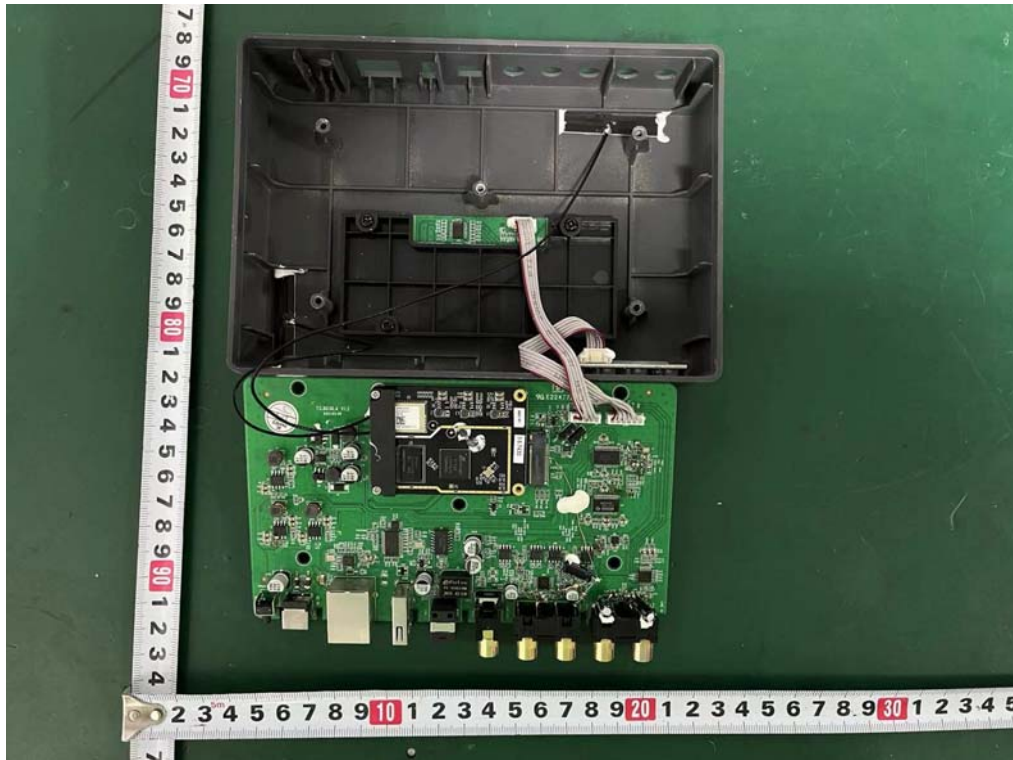

Internal Photos
M/N: LINK2

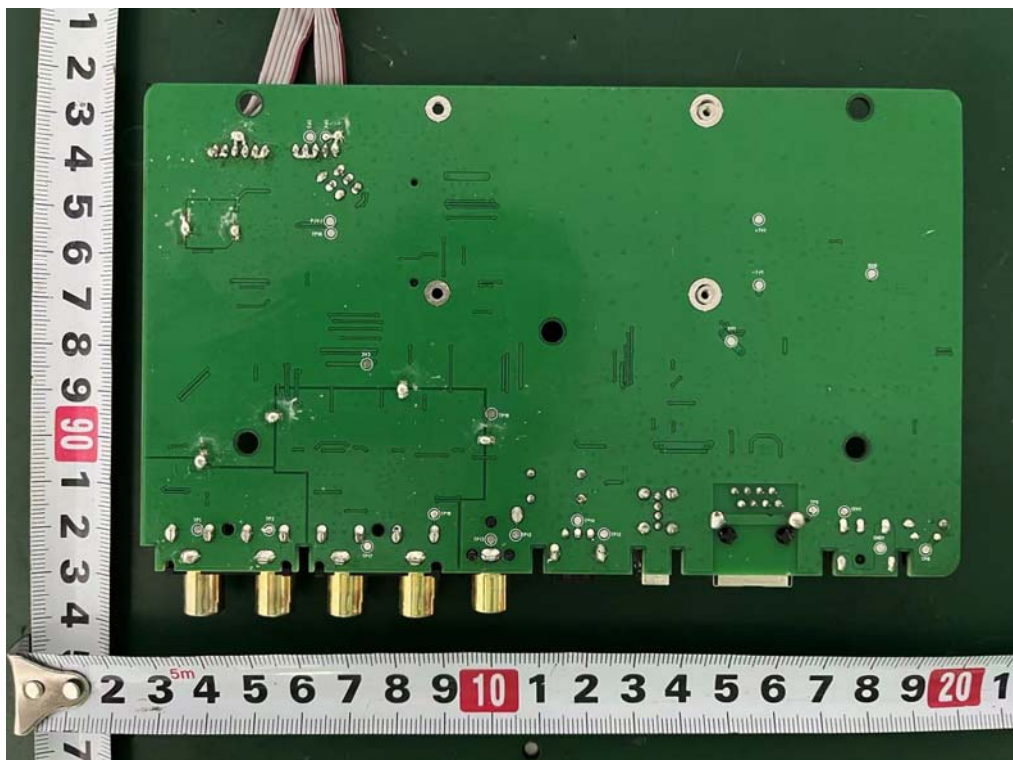
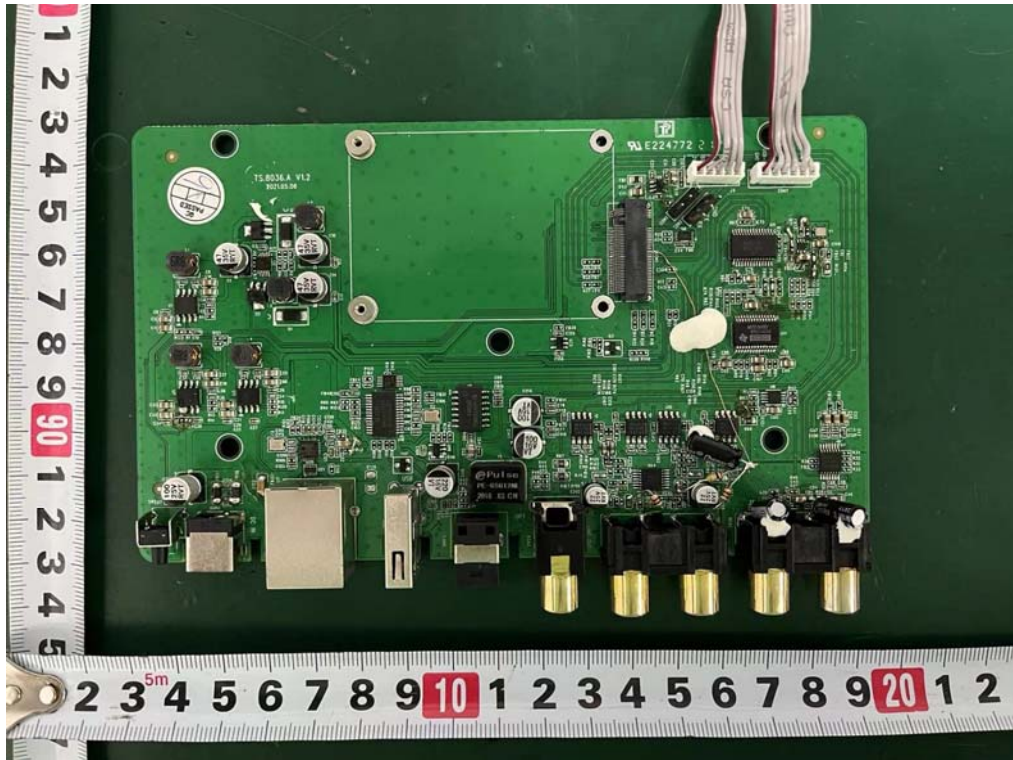

Internal Photos
M/N: LINK2

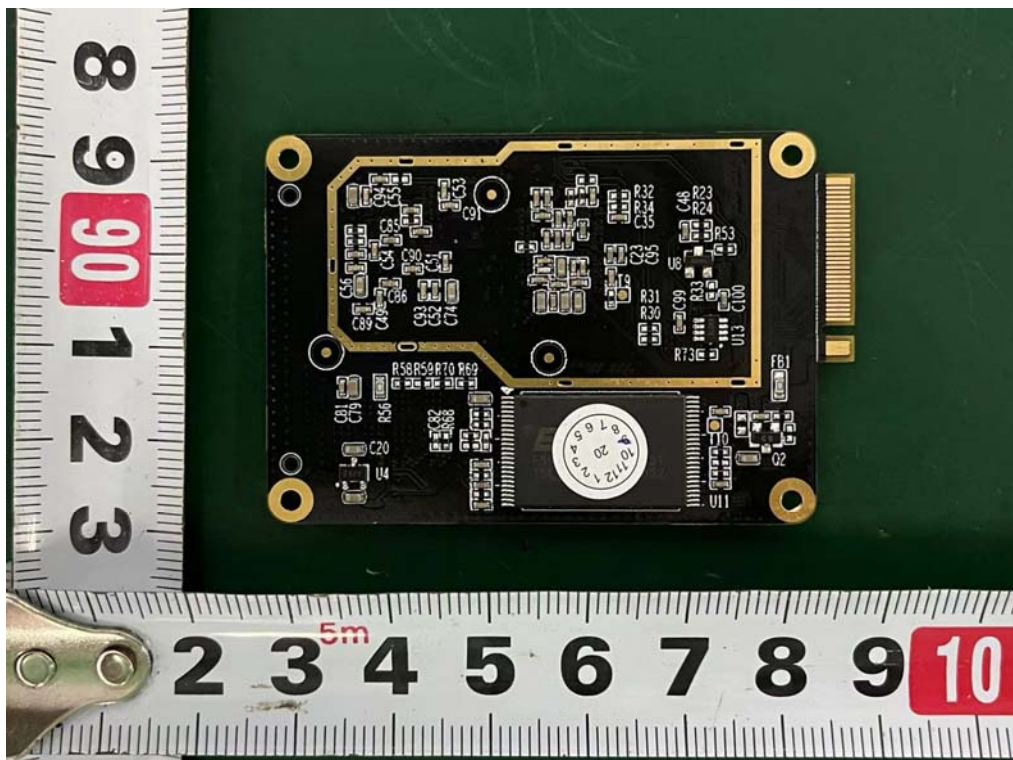
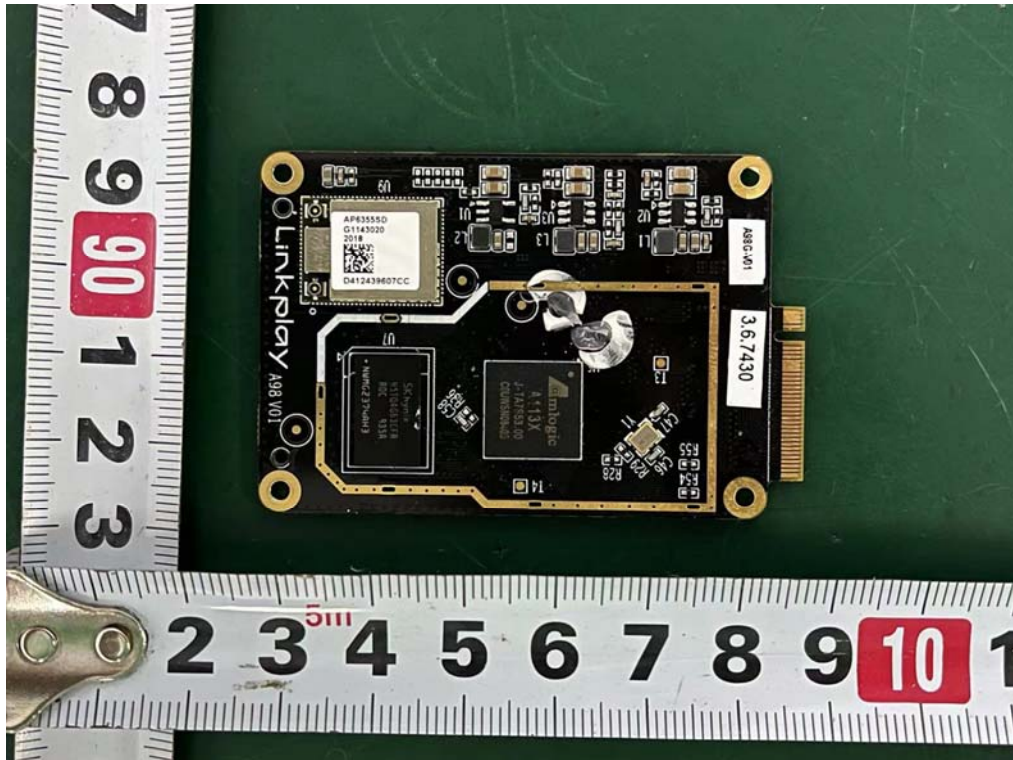

Internal Photos
M/N: LINK2

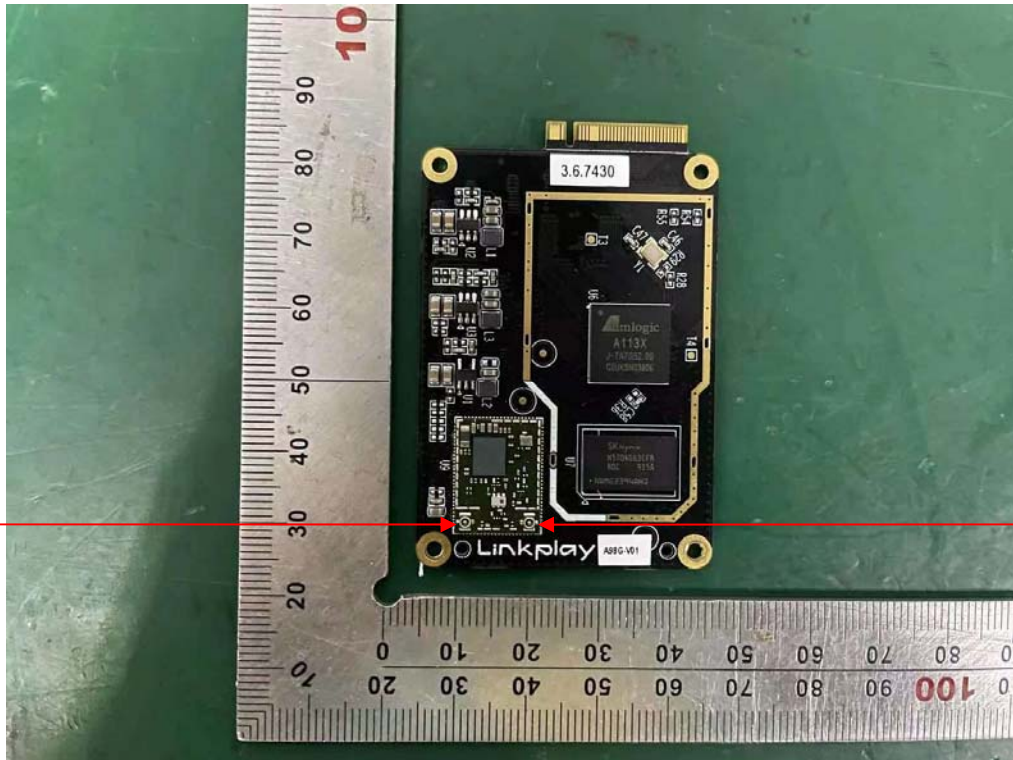

Wi-Fi 1/
Bluetooth
Antenna
Connector

Wi-Fi 2
Antenna
Connector

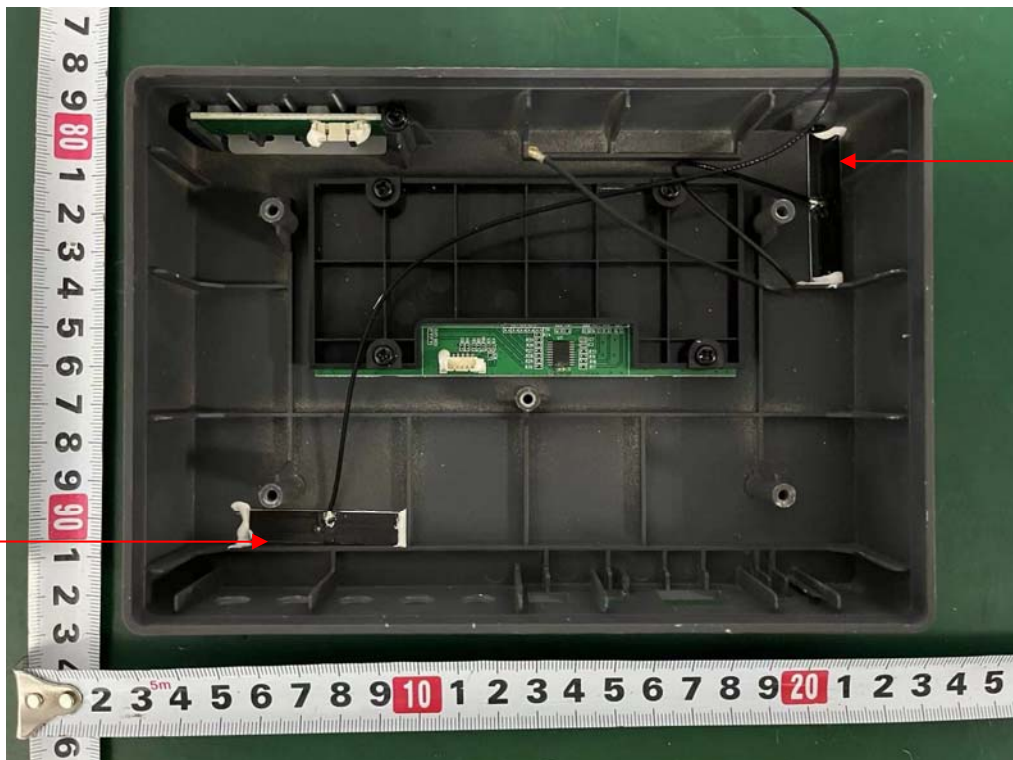

Wi-Fi 2
Antenn

Wi-Fi 1/
Bluetooth
Antenna

Internal Photos

M/N: LINK2

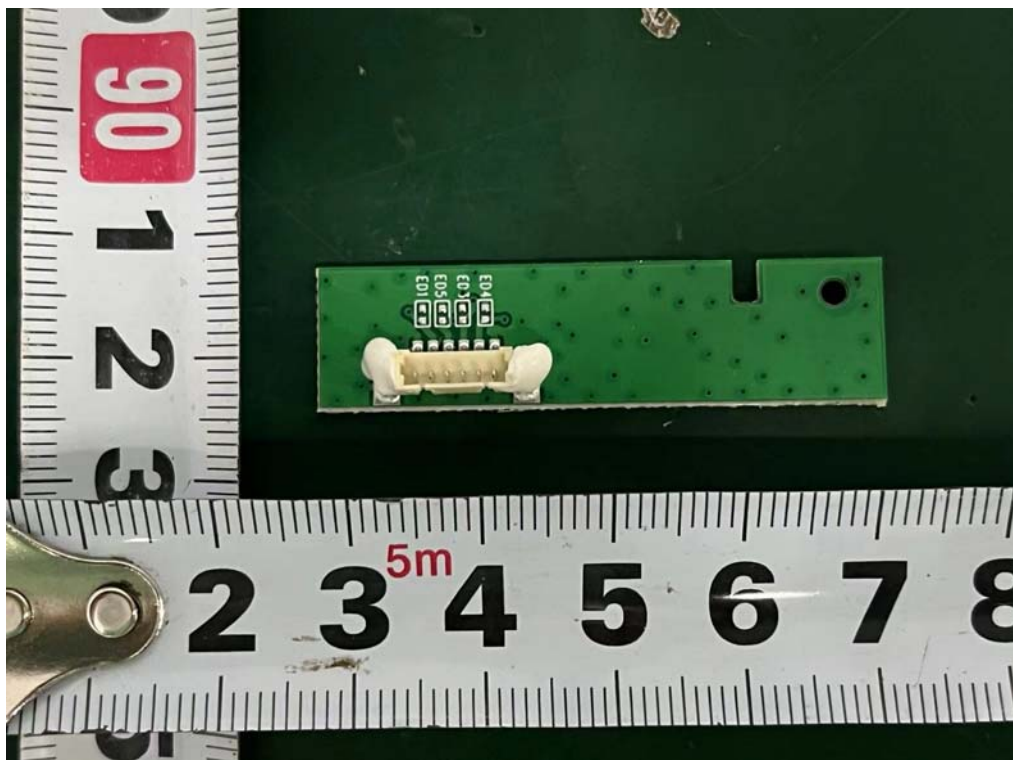
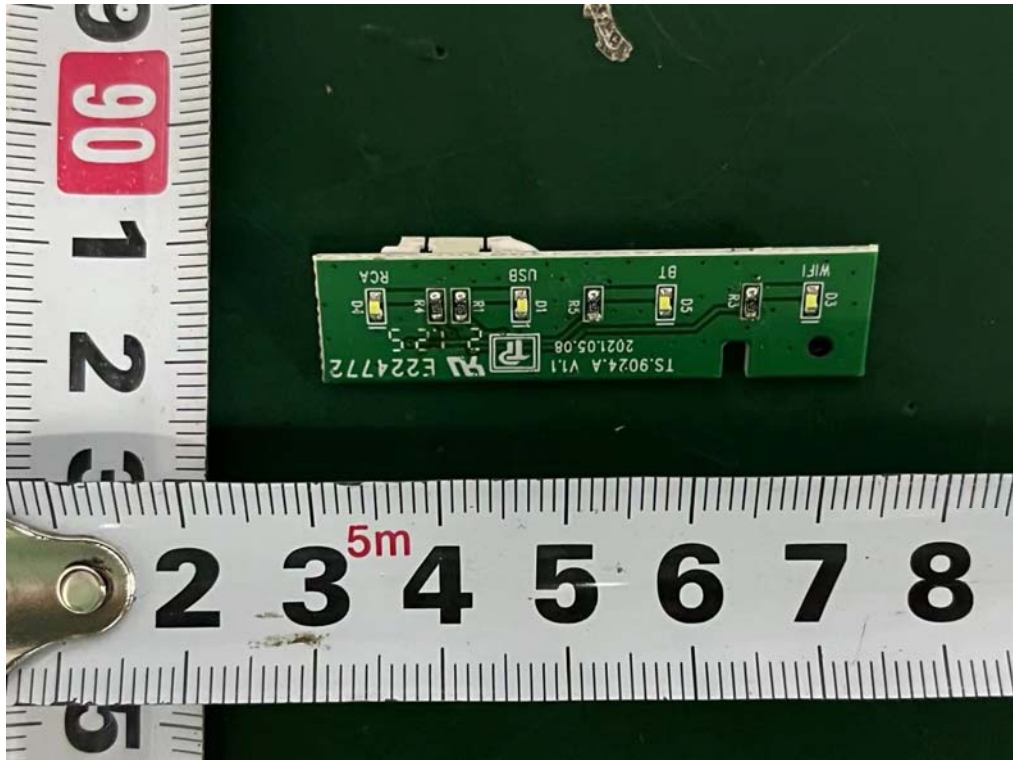

Internal Photos
M/N: LINK2

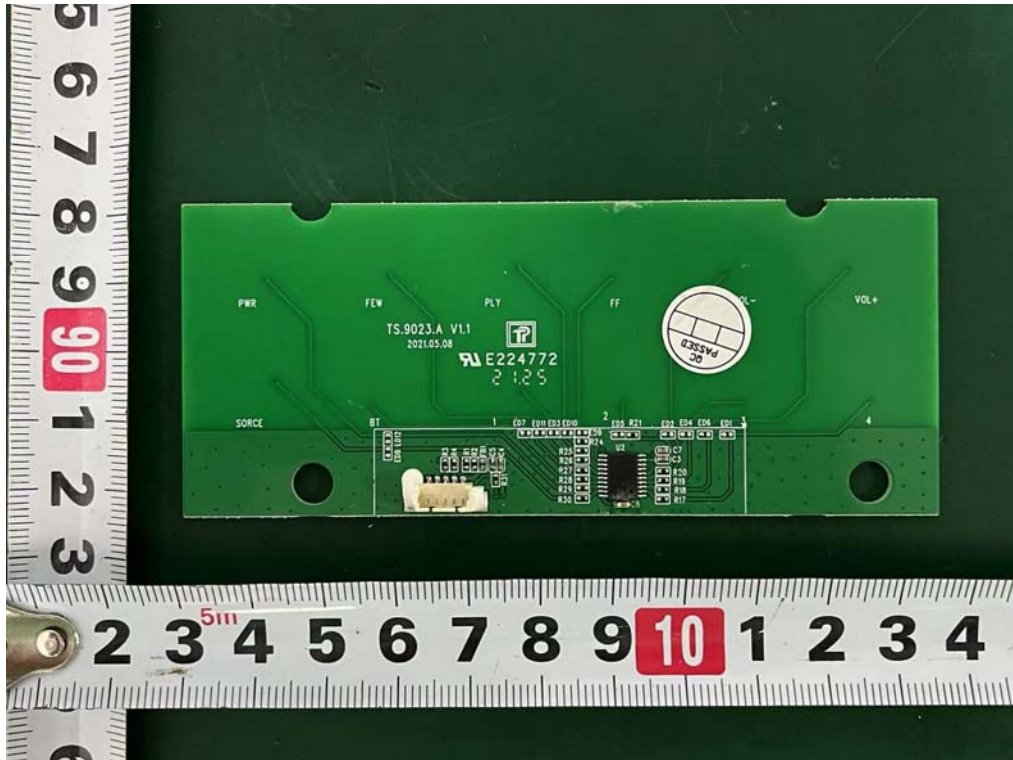

End of Test Report