



# OTA TEST REPORT

**Applicant** Sengled Co.,Ltd.  
**Product** Sengled Wifi Module  
**Model** WF866  
**Brand** Sengled  
**Report No.** Y2209A0971-T1  
**Issue Date** October 28, 2022

TA Technology (Shanghai) Co., Ltd. tested the above equipment in accordance with the requirements in **ANSI/IEEE Std 149-2008**. The test results show that the equipment tested is capable of demonstrating compliance with the requirements as documented in this report.

*Prepared by: Xu Ying*

*Approved by: Xu Kai*

---

**TA Technology (Shanghai) Co., Ltd.**

*Building 3, No.145, Jintang Rd, Pudong Shanghai, P.R.China*

*TEL: +86-021-50791141/2/3*

*FAX: +86-021-50791141/2/3-8000*



## TABLE OF CONTENTS

1.	Test Laboratory.....	3
1.1.	Notes of the Test Report .....	3
1.2.	Test facility .....	3
1.3.	Testing Location .....	3
1.4.	Laboratory Environment .....	4
2.	General Description of Equipment under Test .....	5
2.1.	Applicant and Manufacturer Information.....	5
2.2.	General information .....	5
2.3.	Test Date .....	5
2.4.	Receiving Date .....	5
2.5.	Applied Standards .....	6
3.	Test Conditions.....	7
3.1.	Test Configuration .....	7
3.2.	Test Measurement.....	7
4.	Test Results.....	8
4.1.	Gain and Efficiency.....	8
5.	Equipment List.....	9
	ANNEX A 3-D Pattern Plots.....	10
	<b>ANNEX B: The EUT Appearance and Test Configuration .....</b>	<b>11</b>
	<b>B.1 EUT Appearance .....</b>	<b>11</b>
	<b>B.2 Test Configuration .....</b>	<b>12</b>



## 1. Test Laboratory

### 1.1. Notes of the Test Report

This report shall not be reproduced in full or partial, without the written approval of **TA Technology (Shanghai) Co., Ltd.** The results documented in this report apply only to the tested sample, under the conditions and modes of operation as described herein. Measurement Uncertainties were not taken into account and are published for informational purposes only. This report is written to support regulatory compliance of the applicable standards stated above.

### 1.2. Test facility

#### A2LA (Certificate Number: 3857.01)

TA Technology (Shanghai) Co., Ltd. has been listed by American Association for Laboratory Accreditation to perform measurement.

### 1.3. Testing Location

Company: TA Technology (Shanghai) Co., Ltd.  
Address: Building 3, No.145, Jintang Rd, Pudong Shanghai, P.R.China  
City: Shanghai  
Post code: 201201  
Country: P. R. China  
Contact: Xu Kai  
Telephone: +86-021-50791141/2/3  
Fax: +86-021-50791141/2/3-8000  
Website: <http://www.ta-shanghai.com>  
E-mail: [xukai@ta-shanghai.com](mailto:xukai@ta-shanghai.com)



### 1.4. Laboratory Environment

Temperature	Min. =19°C, Max. = 25°C	
Relative humidity	Min. =40%, Max. =72%	
Shield effect	0.7-6GHz	> 100dB
Ground resistance	<0.5Ω	



## 2. General Description of Equipment under Test

### 2.1. Applicant and Manufacturer Information

<b>Applicant Name</b>	Sengled Co.,Ltd.
<b>Applicant address</b>	Room 103/02-B,Floor 1, Building 1, No. 498, Guoshoujing Road, Pilot Free Trade Zone Shanghai China
<b>Manufacturer Name</b>	Sengled Co.,Ltd.
<b>Manufacturer address</b>	Room 103/02-B,Floor 1, Building 1, No. 498, Guoshoujing Road, Pilot Free Trade Zone Shanghai China

### 2.2. General information

EUT Description	
Product Name:	Sengled Wifi Module
Model	WF866
SN:	001
HW Version:	V2
SW Version:	V1
Antenna Type:	PCB Antenna
Antenna Manufacturer:	Sengled Co.,Ltd.
Test Frequency:	2400MHz ~ 2480MHz
Note: The EUT is sent from the applicant to TA and the information of the EUT is declared by the applicant. All indications of Pass/Fail in this report are opinions expressed by TA Technology (Shanghai) Co., Ltd. based on interpretations and/or observations of test results. Measurement Uncertainties were not taken into account and are published for informational purposes only.	

### 2.3. Test Date

The test is performed from October 9, 2022.

### 2.4. Receiving Date

The sample was received on October 1, 2022.



## 2.5. Applied Standards

According to the specifications of the manufacturer, it must comply with the requirements of the following standards:

Test Method: **ANSI/IEEE Std 149-2008**



### 3. Test Conditions

#### 3.1. Test Configuration

Great-Circle-Cut method is used to measure the antenna 3D GAIN of EUT in OTA qualified anechoic chamber. Equipment Under Test (EUT) geometry centre vertical projection at the centre of platform, the distance from EUT to measurement antenna is 5m.

#### 3.2. Test Measurement

##### Spherical coordinate system

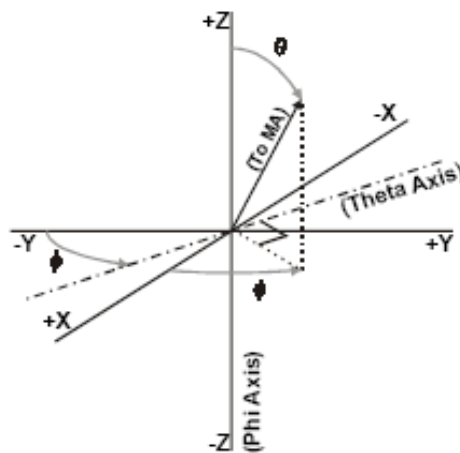
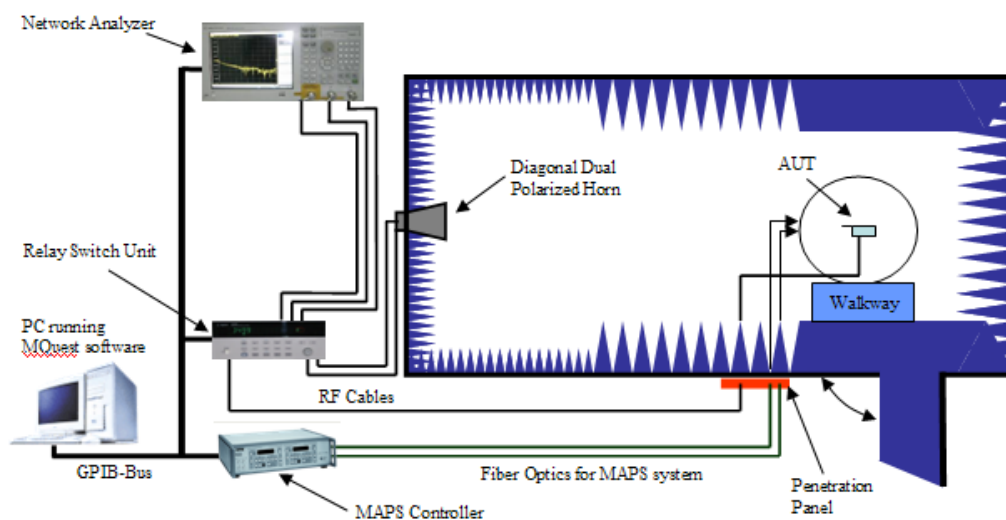

Figure 1 Test coordinate system

Note: Theta is from 0~180 degree. Phi is from 0~360. Rotate the EUT and record the Data, the step of rotation is 15 degree.

##### Test Setup





## 4. Test Results

### 4.1. Gain and Efficiency

Test Item	Test State	Frequency (MHz)	Efficiency (%)	Gain (dBi)	Note
3D Gain	FS	2400	25.42	0.22	/
		2402	26.36	0.03	
		2441	48.62	2.13	
		2480	62.53	3.36	





## 5. Equipment List

Type of Equipment	Manufacture	Model Number	S/N	Calibration Date	Expiration Time
Anechoic Chamber	ETS	AMS-8500	CT-001157-1219	2020-05-17	2025-05-16
Diagonal Dual Polarized Horn	ETS	ETS 3164-04	00062743	2020-04-14	2025-04-13
Network Analyzer	Keysight	E5071B	MY42404014	2022-05-14	2023-05-13
Test Software	ETS	EMQuest™	REV 1.0.9	--	--
EMCenter_Switch Control System	ETS	7006/7001	00059957/MY42001152	--	--

## ANNEX A 3-D Pattern Plots

Total

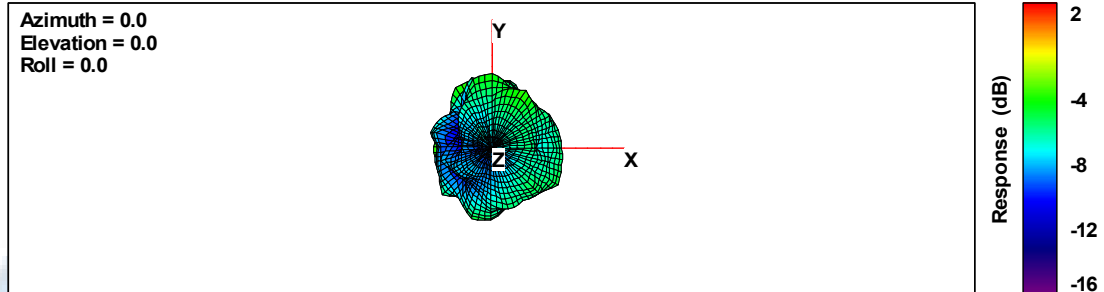

Total

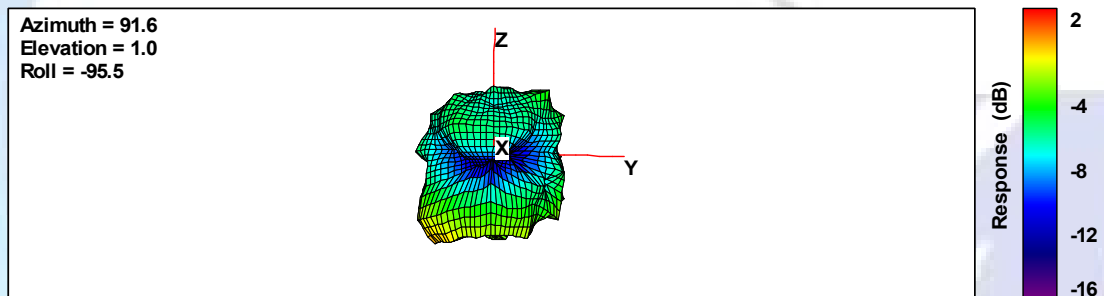

Total

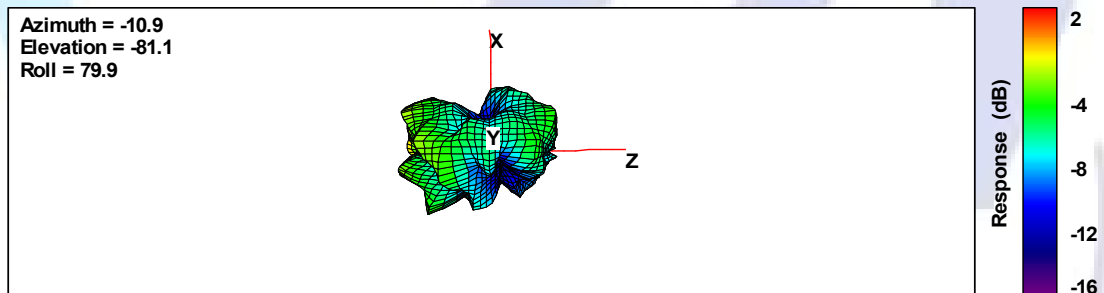

## ANNEX B: The EUT Appearance and Test Configuration

### B.1 EUT Appearance

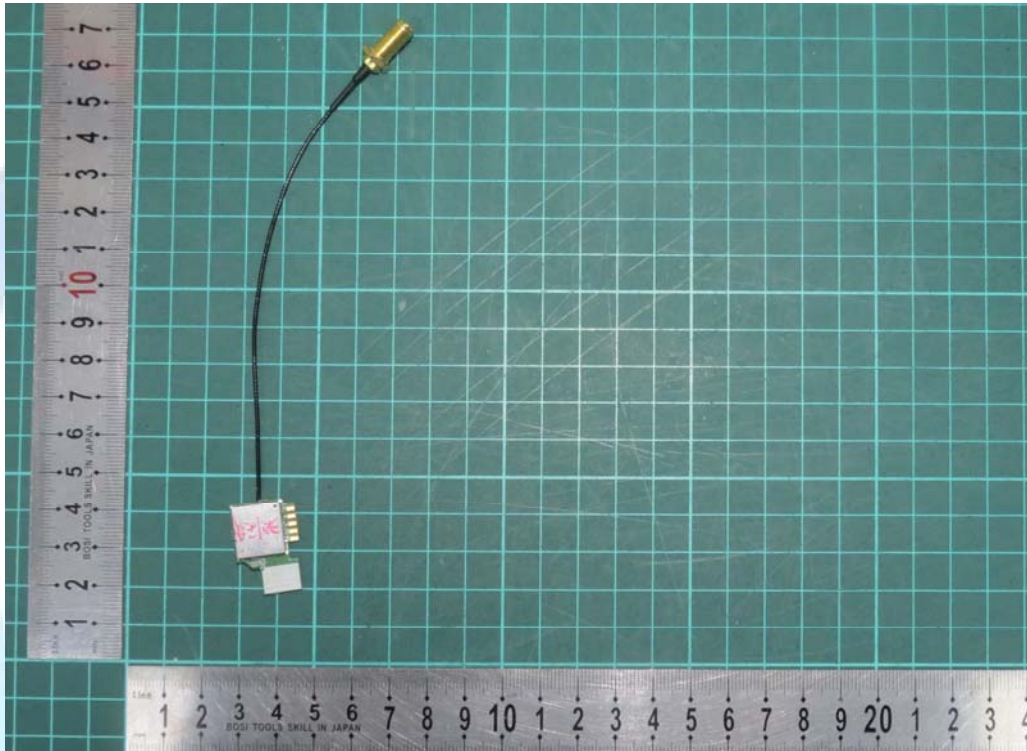

Picture 1 Constituents of EUT

## B.2 Test Configuration

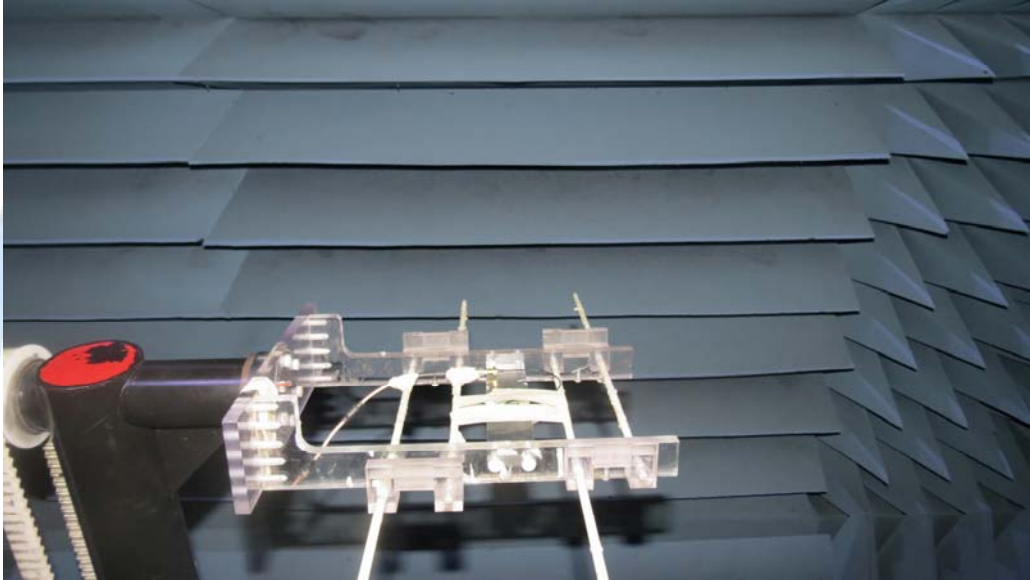

**Picture 2 Test Setup**

**\*\*\*\*\*END OF REPORT \*\*\*\*\***