

7.6.5. Test Result

Test Mode	Channel No.	Frequency (MHz)	Time of Occupancy (ms)	Limit (ms)	Result
DH1	39	2441	131.20	< 400	Pass
DH3	39	2441	265.60	< 400	Pass
DH5	39	2441	302.64	< 400	Pass

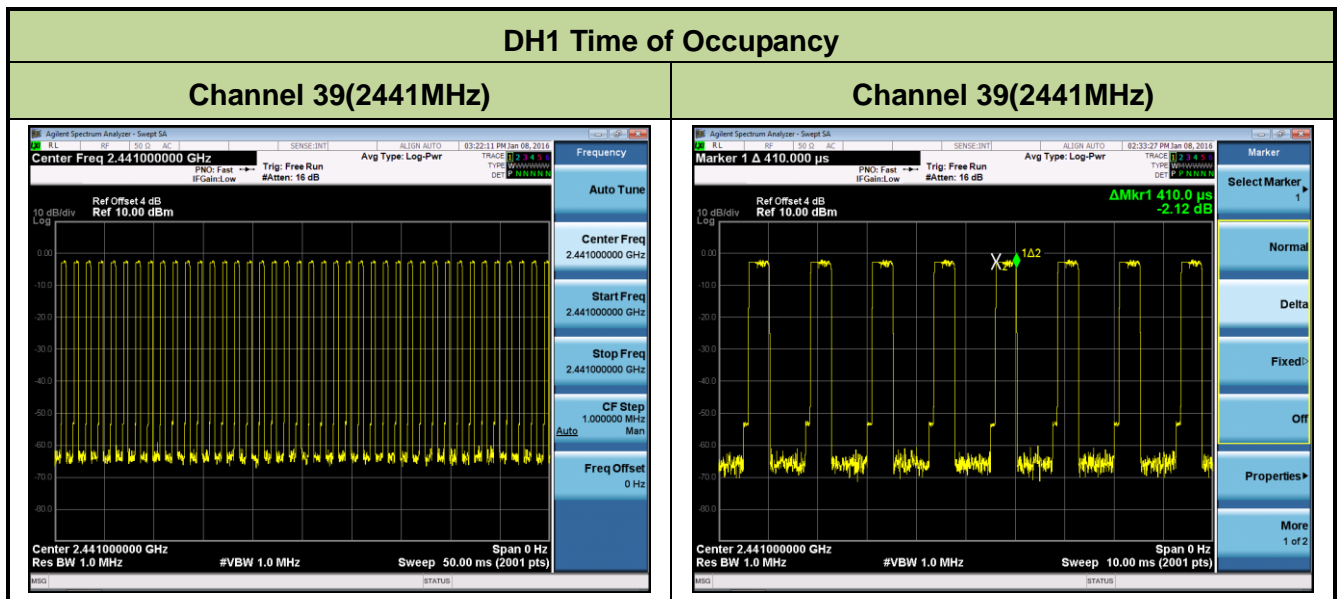

Note: Test Time Period: $0.4 * 79 = 31.6$ sec, Hopping Times Within 1sec: $40/50$ msec= 800 hops/sec.

The Maximum Occupancy Time within 31.6sec: $[(0.41\text{ms} * 800) / 79] * 31.6 = 131.20$ msec.

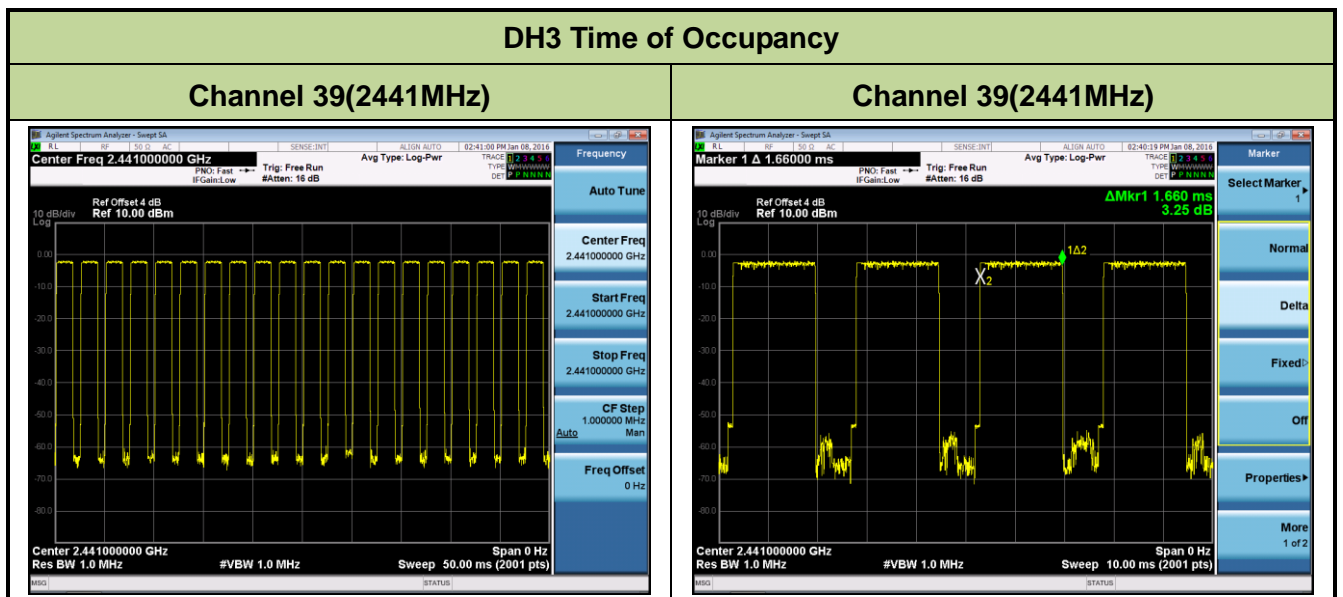

Note: Test Time Period: $0.4 * 79 = 31.6$ sec, Hopping Times Within 1sec: $20/50$ msec= 400 hops/sec.

The Maximum Occupancy Time within 31.6sec: $[(1.66\text{ms} * 400) / 79] * 31.6 = 265.60$ msec.

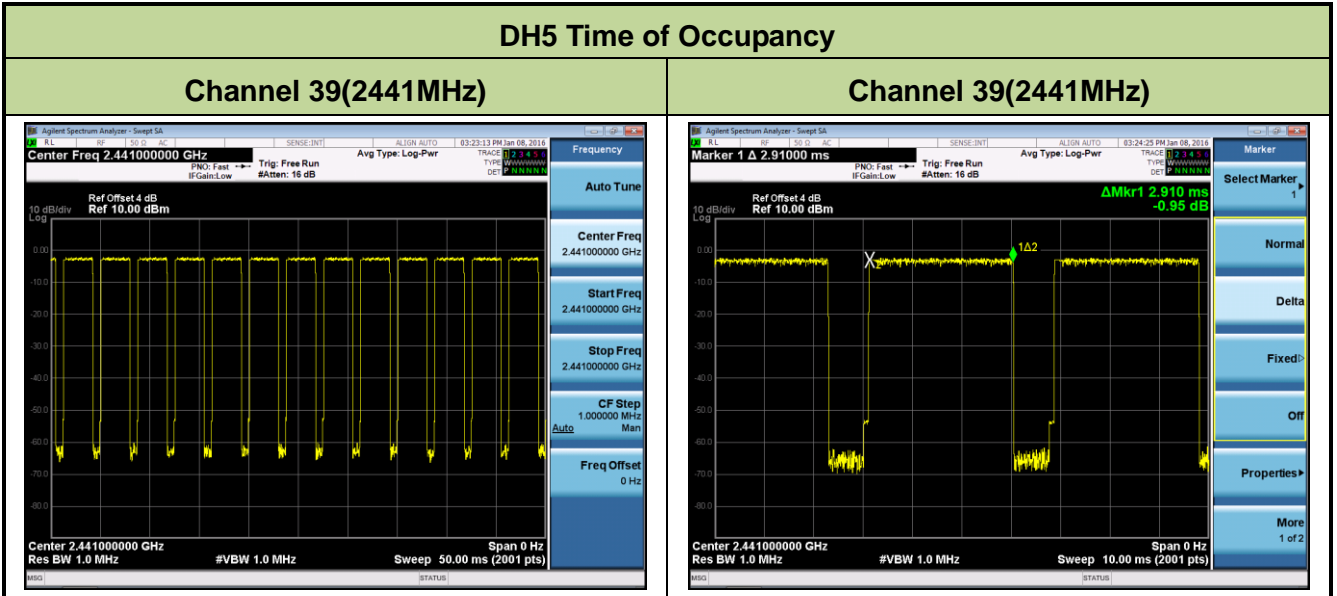

Note: Test Time Period: $0.4 * 79 = 31.6$ sec, Hopping Times Within 1sec: $13/50$ msec= 260 hops/sec.

The Maximum Occupancy Time within 31.6sec: $[(2.91\text{ms} * 260) / 79] * 31.6 = 302.64$ msec.

7.7. Band-edge Compliance Measurement

7.7.1. Test Limit

The maximum permissible emission level is 20dBc. Any emissions were lying outside of the emission bandwidth and in authorized band edges to a field strength limit specified in Section 15.209 of the Title 47 CFR.

7.7.2. Test Procedure Used

ANSI C63.10-2013 - Section 6.10.4

7.7.3. Test Setting

1. Span = wide enough to capture the peak level of the emission operating on the channel closest to the band edge, as well as any modulation products which fall outside of the authorized band of operation.
2. RBW \geq 1% of spectrum analyzer display span
3. VBW \geq RBW
4. Detector = peak
5. Sweep time = auto couple
6. Trace mode = max hold
7. Trace was allowed to stabilize

Allow the trace to stabilize. Set the marker on the emission at the band edge, or on the highest modulation product outside of the band, if this level is greater than that at the band edge. Enable the marker-delta function, then use the marker-to-peak function to move the marker to the peak of the in-band emission.

7.7.4. Test Setup

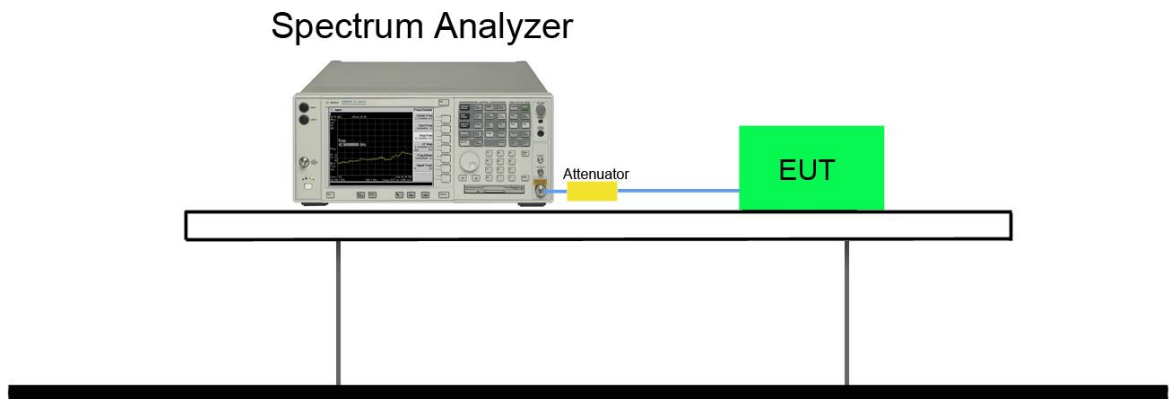

7.7.5. Test Result

Test Mode	Channel No.	Frequency (MHz)	Limit	Result
DH5	00	2402	20dBc	Pass
DH5	78	2480	20dBc	Pass
2DH5	00	2402	20dBc	Pass
2DH5	78	2480	20dBc	Pass
3DH5	00	2402	20dBc	Pass
3DH5	78	2480	20dBc	Pass

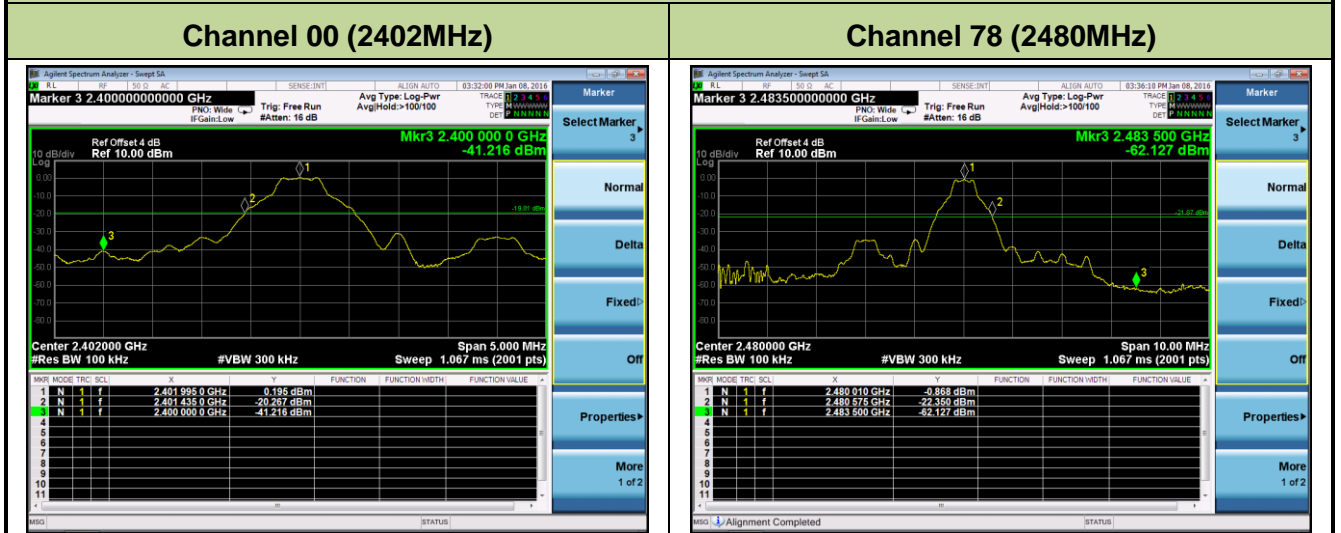
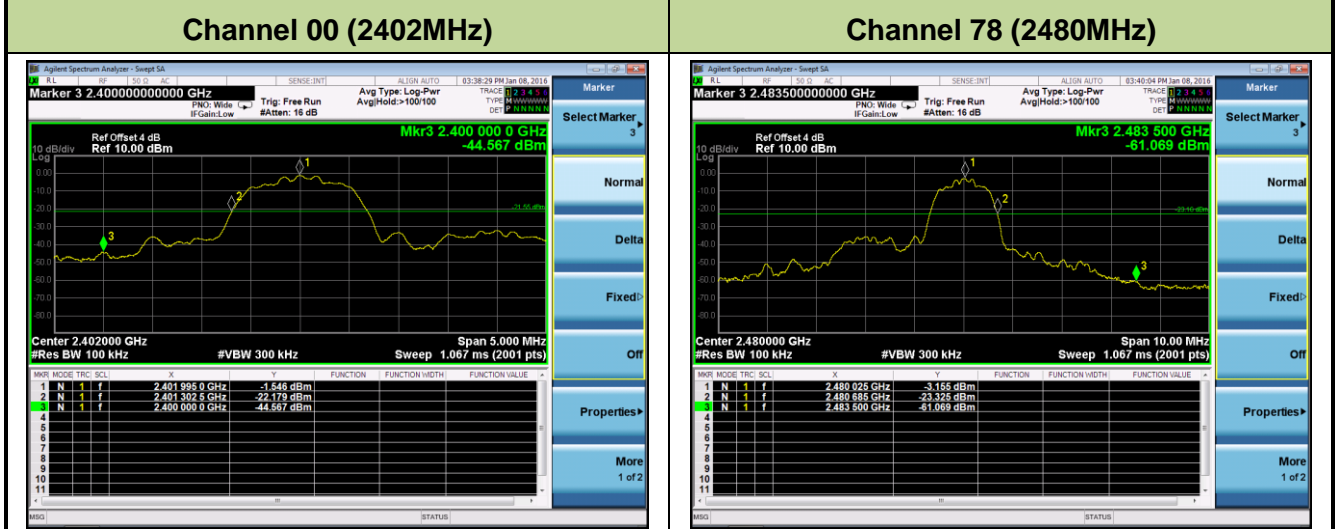
DH5 Band-edge Compliance

2DH5 Band-edge Compliance

3DH5 Band-edge Compliance

Channel 00 (2402MHz)



Channel 78 (2480MHz)



DH5 Band-edge for Hopping Mode

Channel 00 (2402MHz)

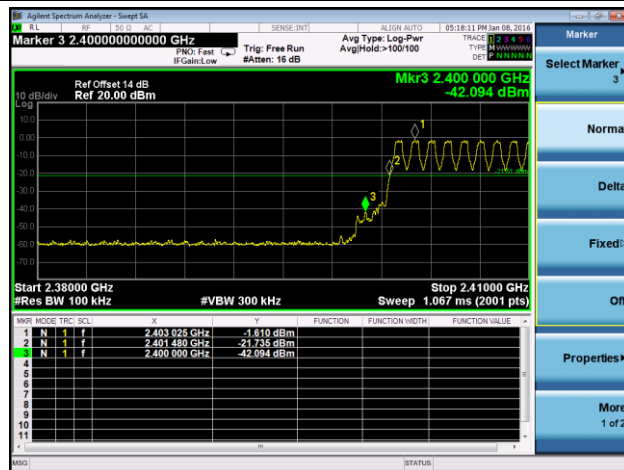

Channel 78 (2480MHz)

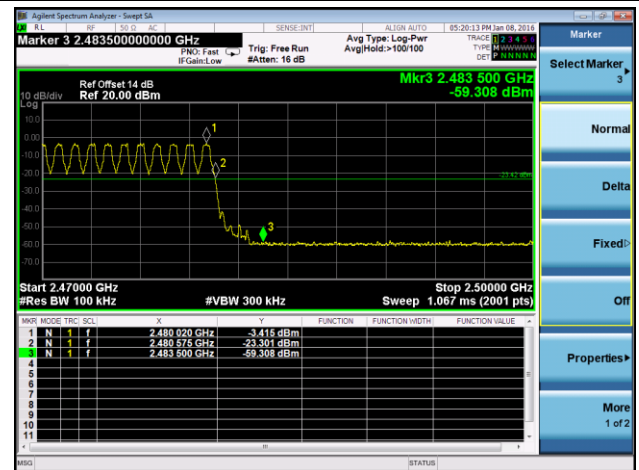

2DH5 Band-edge for Hopping Mode

Channel 00 (2402MHz)

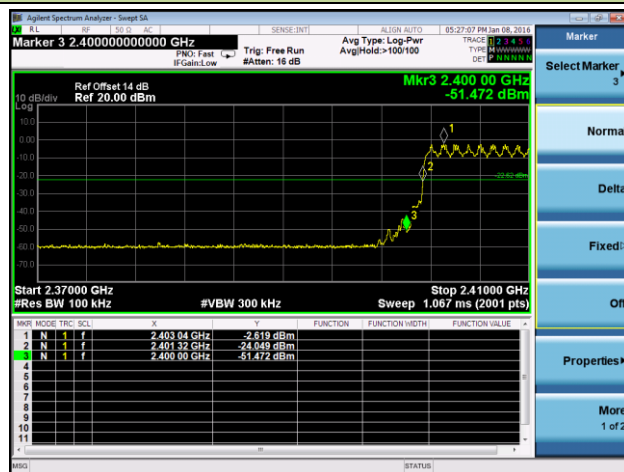

Channel 78 (2480MHz)

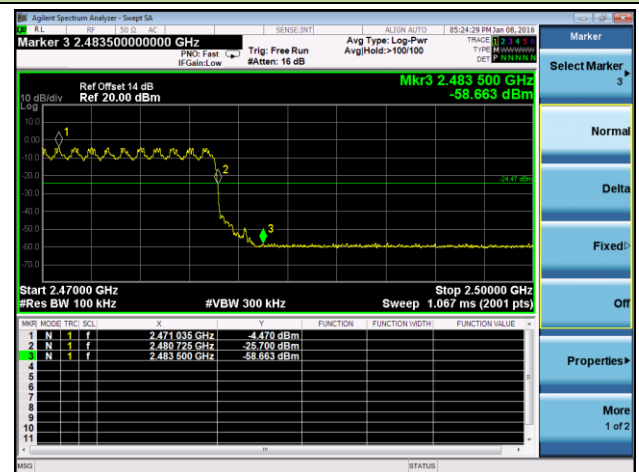

3DH5 Band-edge for Hopping Mode

Channel 00 (2402MHz)

Channel 78 (2480MHz)

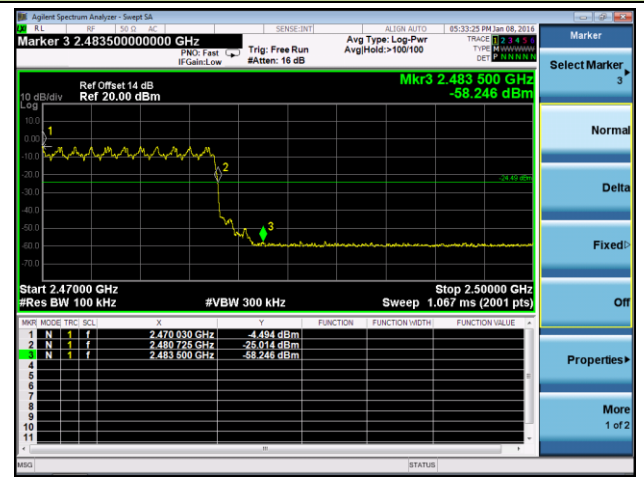
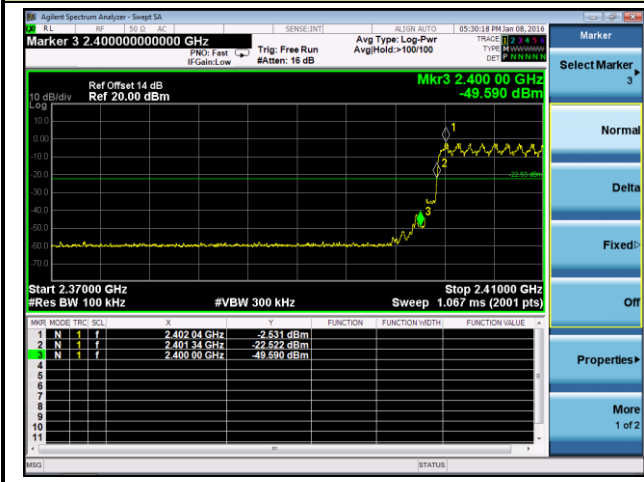

7.8. Conducted Spurious Emissions Measurement

7.8.1. Test Limit

In any 100 kHz bandwidth outside the frequency band in which the spread spectrum or digitally modulated intentional radiator is operating, the radio frequency power that is produced by the intentional radiator shall be at least 20 dB below that in the 100 kHz bandwidth within the band that contains the highest level of the desired power, based on either an RF conducted or a radiated measurement, provided the transmitter demonstrates compliance with the peak conducted or a radiated measurement, provided the transmitter demonstrates compliance with the peak conducted power limits. If the transmitter complies with the conducted power limits based on the use of RMS averaging over a time interval, the attenuation required under this paragraph shall be 30 dB instead of 20 dB.

7.8.2. Test Procedure Used

ANSI C63.10-2013 - Section 7.8.8

7.8.3. Test Setting

1. Span = wide enough to capture the peak level of the in-band emission and all spurious emissions (e.g., harmonics) from the lowest frequency generated in the EUT up through the 10th harmonic. Typically, several plots are required to cover this entire span.
2. RBW = 100 KHz
3. VBW \geq RBW
4. Detector = peak
5. Sweep time = auto couple
6. Trace mode = max hold
7. Trace was allowed to stabilize

Set the marker on the peak of any spurious emission recorded. The level displayed must comply with the limit specified in this section.

7.8.4. Test Setup

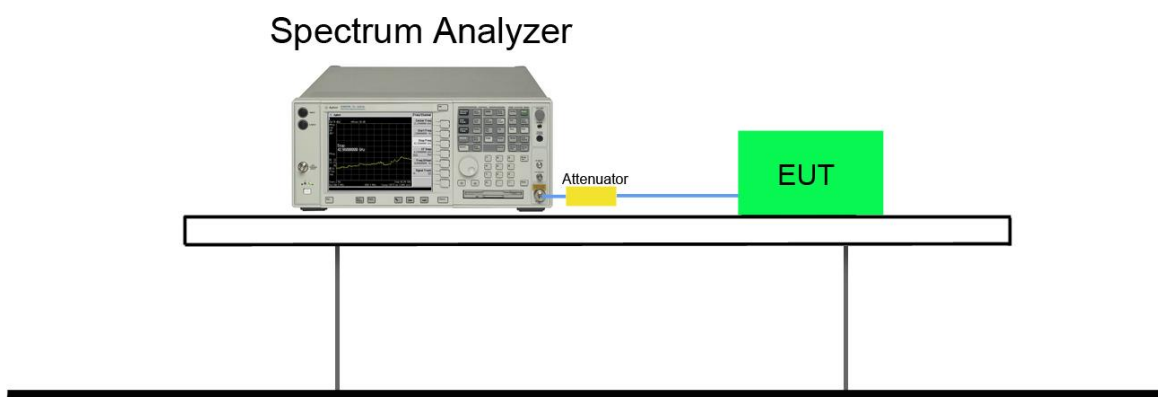

7.8.5. Test Result

Test Mode	Channel No.	Frequency (MHz)	Limit (MHz)	Result
DH5	00	2402	20dBc	Pass
DH5	39	2441	20dBc	Pass
DH5	78	2480	20dBc	Pass
2DH5	00	2402	20dBc	Pass
2DH5	39	2441	20dBc	Pass
2DH5	78	2480	20dBc	Pass
3DH5	00	2402	20dBc	Pass
3DH5	39	2441	20dBc	Pass
3DH5	78	2480	20dBc	Pass

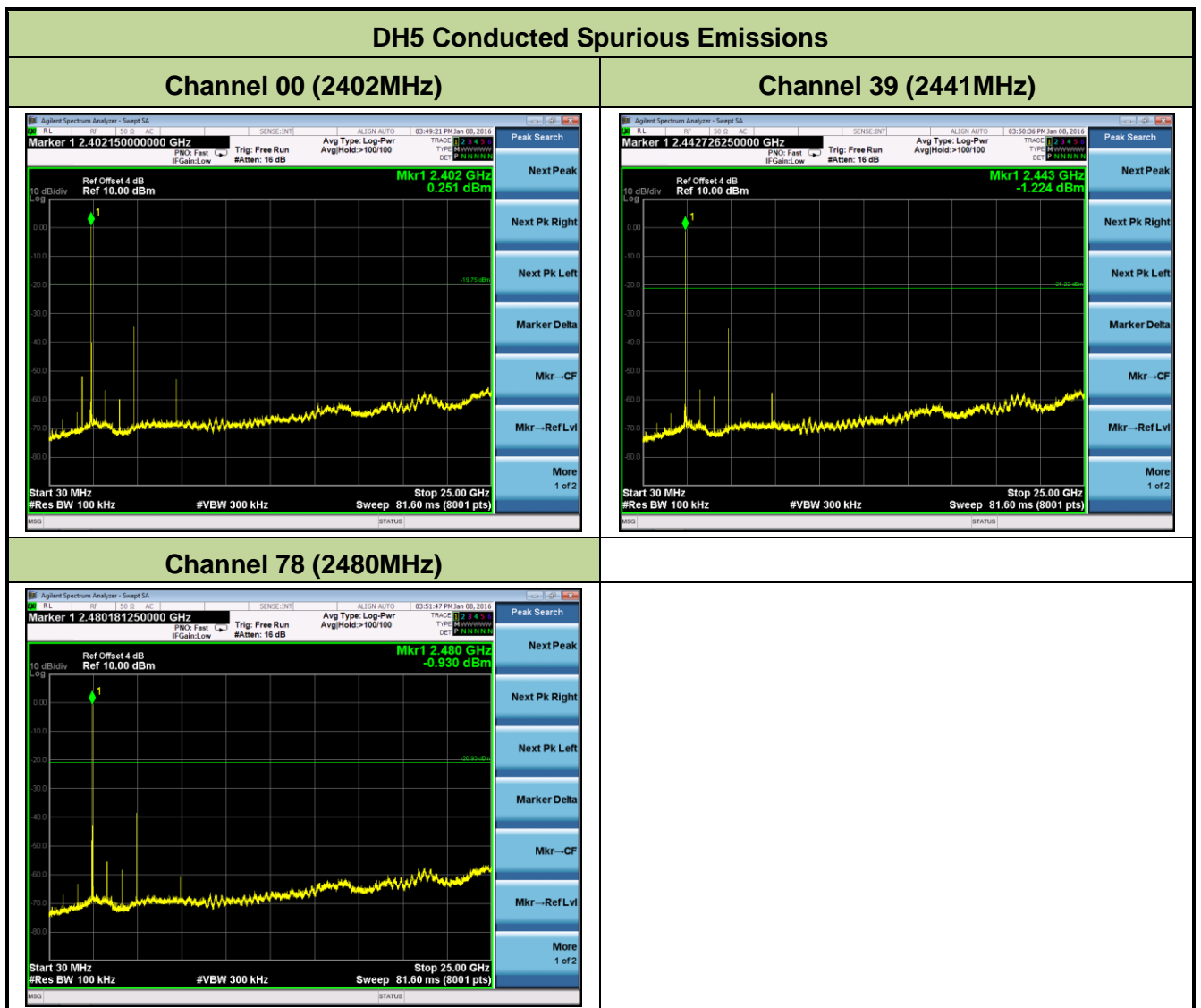

2DH5 Conducted Spurious Emissions

Channel 00 (2402MHz)



Channel 39 (2441MHz)

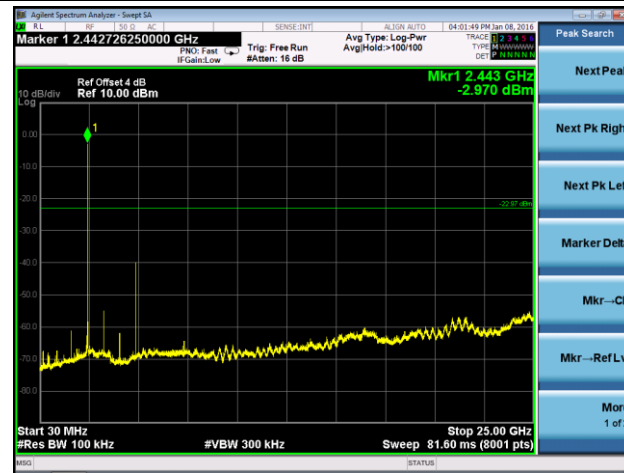

Channel 78 (2480MHz)

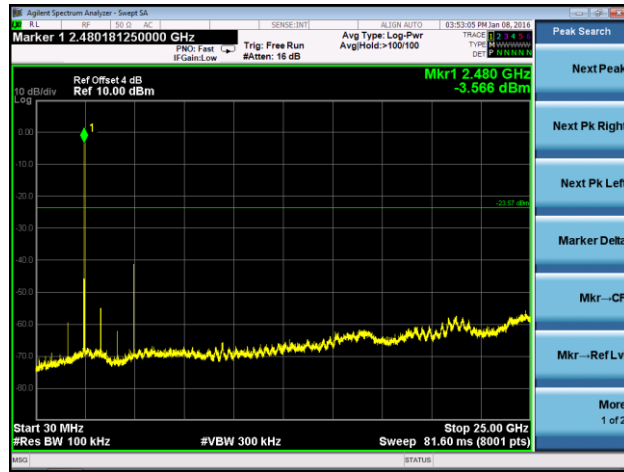

3DH5 Conducted Spurious Emissions

Channel 00 (2402MHz)

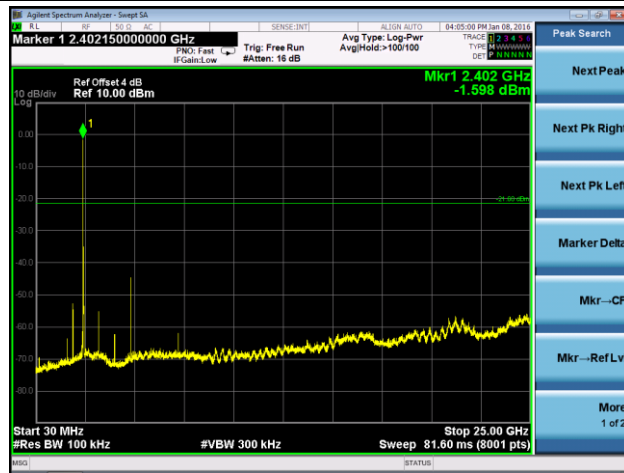

Channel 39 (2441MHz)

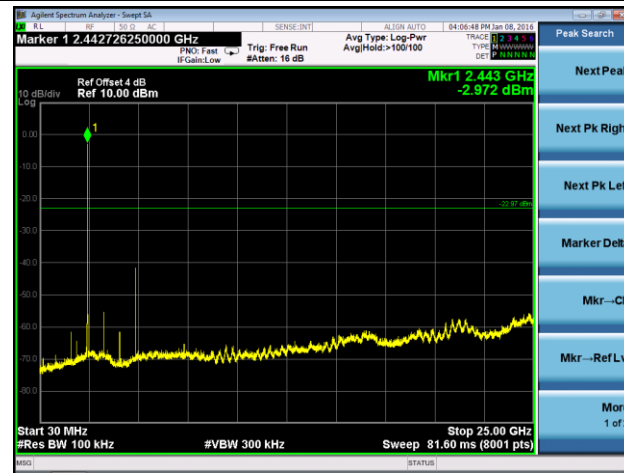

Channel 78 (2480MHz)



7.9. Radiated Spurious Emission Measurement

7.9.1. Test Limit

All out of band emissions appearing in a restricted band as specified in Section 15.205 of the Title 47 CFR must not exceed the limits shown in Table per Section 15.209.

FCC Part 15 Subpart C Paragraph 15.209		
Frequency [MHz]	Field Strength [V/m]	Measured Distance [Meters]
0.009 - 0.490	2400/F (kHz)	300
0.490 - 1.705	24000/F (kHz)	30
1.705 – 30	30	30
30 – 88	100	3
88 – 216	150	3
216 – 960	200	3
Above 960	500	3

7.9.2. Test Procedure Used

ANSI C63.10-2013 - Section 11.12.1

7.9.3. Test Setting

Peak Field Strength Measurements

1. Analyzer center frequency was set to the frequency of the radiated spurious emission of interest
2. RBW = as specified in Table 1
3. VBW = 3 * RBW
4. Detector = peak
5. Sweep time = auto couple
6. Trace mode = max hold
7. Trace was allowed to stabilize

Table 1 - RBW as a function of frequency

Frequency	RBW
9 ~ 150 kHz	200 ~ 300 Hz
0.15 ~ 30 MHz	9 ~ 10 kHz
30 ~ 1000 MHz	100 ~ 120 kHz
> 1000 MHz	1 MHz

Average Field Strength Measurements

1. Analyzer center frequency was set to the frequency of the radiated spurious emission of interest
2. RBW = 1MHz
3. VBW $\geq 1/T$
4. De As an alternative, the instrument may be set to linear detector mode. Ensure that video filtering is applied in linear voltage domain (rather than in a log or dB domain). Some instruments require linear display mode in order to accomplish this. Others have a setting for Average-VBW Type, which can be set to "Voltage" regardless of the display mode
5. Detector = Peak
6. Sweep time = auto
7. Trace mode = max hold
8. Allow max hold to run for at least 50 times (1/duty cycle) traces

7.9.4. Test Setup

9kHz ~ 30MHz Test Setup:

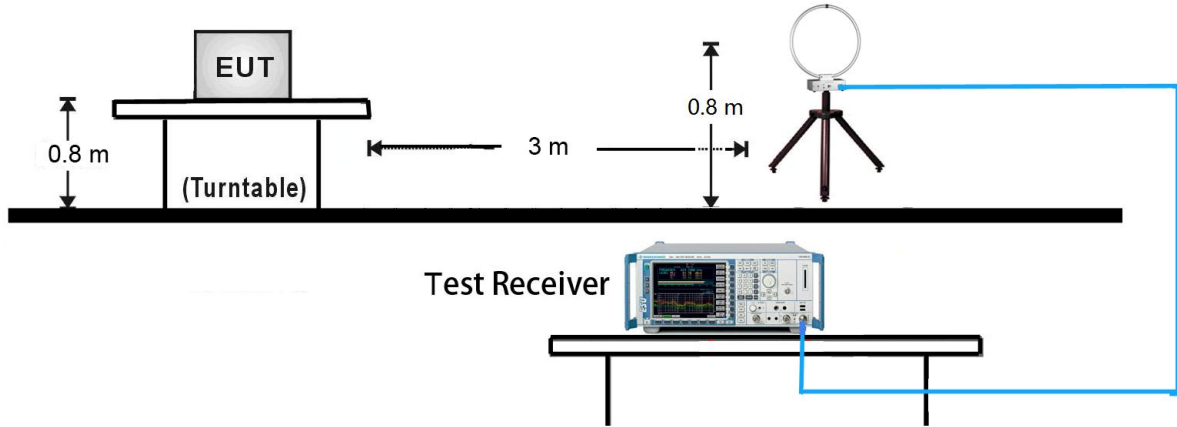

30MHz ~ 1GHz Test Setup:

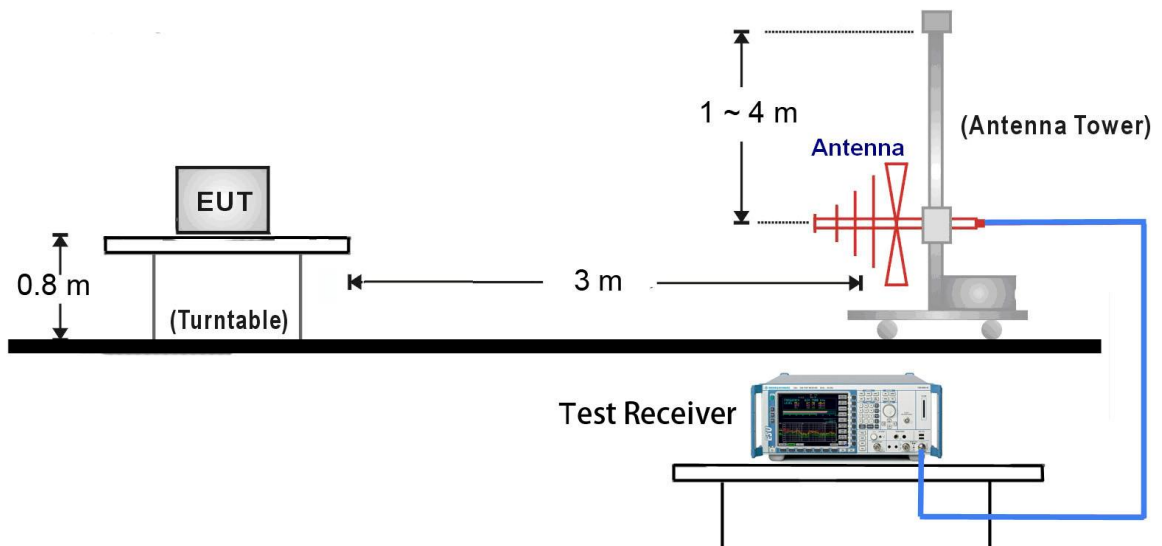

1GHz ~ 18GHz Test Setup:

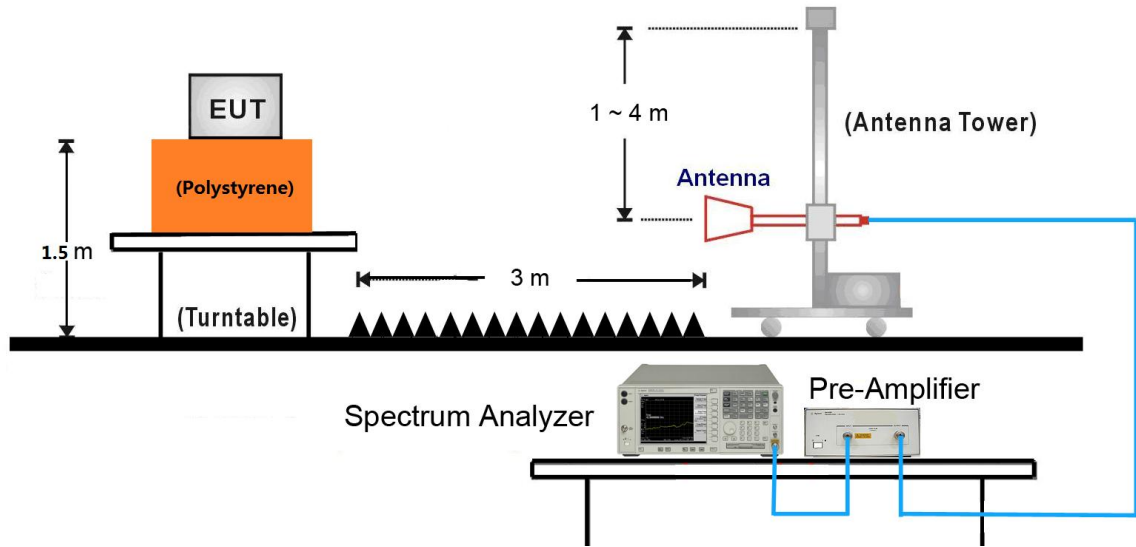

18GHz ~25GHz Test Setup:

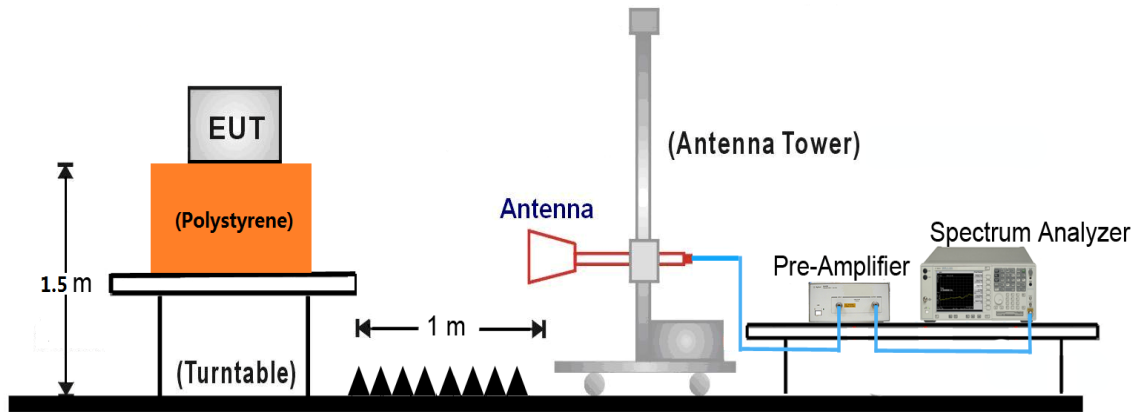

7.9.5. Test Result

Test Mode:	DH5	Test Site:	AC2
Test Channel:	00	Test Engineer:	Will Yan
Remark:	1. Average measurement was not performed if peak level lower than average limit. 2. Other frequency was 20dB below limit line within 1-18GHz, there is not show in the report.		

Mark	Frequency (MHz)	Reading Level (dBμV)	Factor (dB)	Measure Level (dBμV/m)	Limit (dBμV/m)	Margin (dB)	Detector	Polarization
	3779.5	39.4	-0.7	38.7	74.0	-35.3	Peak	Horizontal
	4808.0	46.2	2.7	48.9	74.0	-25.1	Peak	Horizontal
*	6550.5	35.6	7.4	43.0	77.8	-34.8	Peak	Horizontal
*	9840.0	35.2	13.5	48.7	77.8	-29.1	Peak	Horizontal
	3924.0	39.5	-0.7	38.8	74.0	-35.2	Peak	Vertical
	4799.5	46.0	2.8	48.8	74.0	-25.2	Peak	Vertical
*	6627.0	35.9	7.6	43.5	77.8	-34.3	Peak	Vertical
*	9840.0	35.2	13.5	48.7	77.8	-29.1	Peak	Vertical

Note 1: "*" is not in restricted band, its limit is 20dBc of the fundamental emission level (97.8dBμV/m) or 15.209 which is higher.

Note 2: Measure Level (dBμV/m) = Reading Level (dBμV) + Factor (dB)

Factor (dB) = Cable Loss (dB) + Antenna Factor (dB/m) - Pre_Amplifier Gain (dB)

Test Mode:	DH5	Test Site:	AC2
Test channel:	39	Test Engineer:	Will Yan
Remark:	1. Average measurement was not performed if peak level lower than average limit. 2. Other frequency was 20dB below limit line within 1-18GHz, there is not show in the report.		

Mark	Frequency (MHz)	Reading Level (dBμV)	Factor (dB)	Measure Level (dBμV/m)	Limit (dBμV/m)	Margin (dB)	Detector	Polarization
	3779.5	39.0	-0.7	38.3	74.0	-35.7	Peak	Horizontal
	4884.5	42.4	2.7	45.1	74.0	-28.9	Peak	Horizontal
*	6695.0	35.6	7.5	43.1	79.4	-36.3	Peak	Horizontal
*	9755.0	34.4	13.0	47.4	79.4	-32.0	Peak	Horizontal
	3805.0	39.6	-0.6	39.0	74.0	-35.0	Peak	Vertical
	4884.5	42.8	2.7	45.5	74.0	-28.5	Peak	Vertical
*	6380.5	36.7	6.3	43.0	79.4	-36.4	Peak	Vertical
*	9780.5	35.0	12.7	47.7	79.4	-31.7	Peak	Vertical

Note 1: "*" is not in restricted band, its limit is 20dBc of the fundamental emission level (99.4dBμV/m) or 15.209 which is higher.

Note 2: Measure Level (dBμV/m) = Reading Level (dBμV) + Factor (dB)

Factor (dB) = Cable Loss (dB) + Antenna Factor (dB/m) - Pre_Amplifier Gain (dB)

Test Mode:	DH5	Test Site:	AC2
Test channel:	78	Test Engineer:	Will Yan
Remark:	1. Average measurement was not performed if peak level lower than average limit. 2. Other frequency was 20dB below limit line within 1-18GHz, there is not show in the report.		

Mark	Frequency (MHz)	Reading Level (dBμV)	Factor (dB)	Measure Level (dBμV/m)	Limit (dBμV/m)	Margin (dB)	Detector	Polarization
	3847.5	39.2	-0.6	38.6	74.0	-35.4	Peak	Horizontal
	4961.0	45.0	2.7	47.7	74.0	-26.3	Peak	Horizontal
*	6491.0	35.5	7.3	42.8	75.6	-32.8	Peak	Horizontal
*	9831.5	34.1	13.2	47.3	75.6	-28.3	Peak	Horizontal
	3788.0	38.3	-0.6	37.7	74.0	-36.3	Peak	Vertical
	4961.0	45.0	2.7	47.7	74.0	-26.3	Peak	Vertical
*	6431.5	35.6	6.7	42.3	75.6	-33.3	Peak	Vertical
*	9763.5	34.8	12.8	47.6	75.6	-28.0	Peak	Vertical

Note 1: "*" is not in restricted band, its limit is 20dBc of the fundamental emission level (95.6dBμV/m) or 15.209 which is higher.

Note 2: Measure Level (dBμV/m) = Reading Level (dBμV) + Factor (dB)

Factor (dB) = Cable Loss (dB) + Antenna Factor (dB/m) - Pre_Amplifier Gain (dB)

Test Mode:	2DH5	Test Site:	AC2
Test channel:	00	Test Engineer:	Will Yan
Remark:	1. Average measurement was not performed if peak level lower than average limit. 2. Other frequency was 20dB below limit line within 1-18GHz, there is not show in the report.		

Mark	Frequency (MHz)	Reading Level (dBμV)	Factor (dB)	Measure Level (dBμV/m)	Limit (dBμV/m)	Margin (dB)	Detector	Polarization
	3941.0	38.6	-0.5	38.1	74.0	-35.9	Peak	Horizontal
	4808.0	40.2	2.7	42.9	74.0	-31.1	Peak	Horizontal
*	6491.0	34.9	7.3	42.2	76.1	-33.9	Peak	Horizontal
*	9755.0	34.6	13.0	47.6	76.1	-28.5	Peak	Horizontal
	3839.0	39.3	-0.6	38.7	74.0	-35.3	Peak	Vertical
	4808.0	40.5	2.7	43.2	74.0	-30.8	Peak	Vertical
*	6431.5	36.0	6.7	42.7	76.1	-33.4	Peak	Vertical
*	9840.0	34.4	13.5	47.9	76.1	-28.2	Peak	Vertical

Note 1: "*" is not in restricted band, its limit is 20dBc of the fundamental emission level (96.1dBμV/m) or 15.209 which is higher.

Note 2: Measure Level (dBμV/m) = Reading Level (dBμV) + Factor (dB)

Factor (dB) = Cable Loss (dB) + Antenna Factor (dB/m) - Pre_Amplifier Gain (dB)

Test Mode:	2DH5	Test Site:	AC2
Test channel:	39	Test Engineer:	Will Yan
Remark:	1. Average measurement was not performed if peak level lower than average limit. 2. Other frequency was 20dB below limit line within 1-18GHz, there is not show in the report.		

Mark	Frequency (MHz)	Reading Level (dB μ V)	Factor (dB)	Measure Level (dB μ V/m)	Limit (dB μ V/m)	Margin (dB)	Detector	Polarization
	3720.0	39.7	-0.8	38.9	74.0	-35.1	Peak	Horizontal
	4884.5	39.2	2.7	41.9	74.0	-32.1	Peak	Horizontal
*	6508.0	35.2	7.3	42.5	78.6	-36.1	Peak	Horizontal
*	9746.5	35.1	12.7	47.8	78.6	-30.8	Peak	Horizontal
	3728.5	39.4	-0.8	38.6	74.0	-35.4	Peak	Vertical
	4884.5	37.8	2.7	40.5	74.0	-33.5	Peak	Vertical
*	6406.0	35.9	6.6	42.5	78.6	-36.1	Peak	Vertical
*	9704.0	34.6	12.3	46.9	78.6	-31.7	Peak	Vertical

Note 1: "*" is not in restricted band, its limit is 20dBc of the fundamental emission level (98.6dB μ V/m) or 15.209 which is higher.

Note 2: Measure Level (dB μ V/m) = Reading Level (dB μ V) + Factor (dB)

Factor (dB) = Cable Loss (dB) + Antenna Factor (dB/m) - Pre_Amplifier Gain (dB)

Test Mode:	2DH5	Test Site:	AC2
Test channel:	78	Test Engineer:	Will Yan
Remark:	1. Average measurement was not performed if peak level lower than average limit. 2. Other frequency was 20dB below limit line within 1-18GHz, there is not show in the report.		

Mark	Frequency (MHz)	Reading Level (dBμV)	Factor (dB)	Measure Level (dBμV/m)	Limit (dBμV/m)	Margin (dB)	Detector	Polarization
	3779.5	38.8	-0.7	38.1	74.0	-35.9	Peak	Horizontal
	4961.0	40.3	2.7	43.0	74.0	-31.0	Peak	Horizontal
*	6550.5	36.0	7.4	43.4	73.5	-30.1	Peak	Horizontal
*	9772.0	35.0	12.6	47.6	73.5	-25.9	Peak	Horizontal
	3779.5	39.4	-0.7	38.7	74.0	-35.3	Peak	Vertical
	4961.0	43.0	2.7	45.7	74.0	-28.3	Peak	Vertical
*	6499.5	35.6	7.2	42.8	73.5	-30.7	Peak	Vertical
*	9831.5	33.8	13.2	47.0	73.5	-26.5	Peak	Vertical

Note 1: "*" is not in restricted band, its limit is 20dBc of the fundamental emission level (93.5dBμV/m) or 15.209 which is higher.

Note 2: Measure Level (dBμV/m) = Reading Level (dBμV) + Factor (dB)

Factor (dB) = Cable Loss (dB) + Antenna Factor (dB/m) - Pre_Amplifier Gain (dB)

Test Mode:	3DH5	Test Site:	AC2
Test channel:	00	Test Engineer:	Will Yan
Remark:	1. Average measurement was not performed if peak level lower than average limit. 2. Other frequency was 20dB below limit line within 1-18GHz, there is not show in the report.		

Mark	Frequency (MHz)	Reading Level (dBμV)	Factor (dB)	Measure Level (dBμV/m)	Limit (dBμV/m)	Margin (dB)	Detector	Polarization
	3941.0	39.8	-0.5	39.3	74.0	-34.7	Peak	Horizontal
	4808.0	40.6	2.7	43.3	74.0	-30.7	Peak	Horizontal
*	6482.5	35.4	7.2	42.6	76.0	-33.4	Peak	Horizontal
*	9763.5	34.9	12.8	47.7	76.0	-28.3	Peak	Horizontal
	3728.5	39.9	-0.8	39.1	74.0	-34.9	Peak	Vertical
	4799.5	38.7	2.8	41.5	74.0	-32.5	Peak	Vertical
*	6465.5	36.2	7.0	43.2	76.0	-32.8	Peak	Vertical
*	9763.5	34.2	12.8	47.0	76.0	-29.0	Peak	Vertical

Note 1: "*" is not in restricted band, its limit is 20dBc of the fundamental emission level (96.0dBμV/m) or 15.209 which is higher.

Note 2: Measure Level (dBμV/m) = Reading Level (dBμV) + Factor (dB)

Factor (dB) = Cable Loss (dB) + Antenna Factor (dB/m) - Pre_Amplifier Gain (dB)

Test Mode:	3DH5	Test Site:	AC2
Test channel:	39	Test Engineer:	Will Yan
Remark:	1. Average measurement was not performed if peak level lower than average limit. 2. Other frequency was 20dB below limit line within 1-18GHz, there is not show in the report.		

Mark	Frequency (MHz)	Reading Level (dBμV)	Factor (dB)	Measure Level (dBμV/m)	Limit (dBμV/m)	Margin (dB)	Detector	Polarization
	3796.5	38.8	-0.6	38.2	74.0	-35.8	Peak	Horizontal
	4884.5	38.1	2.7	40.8	74.0	-33.2	Peak	Horizontal
*	6491.0	35.4	7.3	42.7	79.9	-37.2	Peak	Horizontal
*	9780.5	35.0	12.7	47.7	79.9	-32.2	Peak	Horizontal
	3771.0	39.1	-0.8	38.3	74.0	-35.7	Peak	Vertical
	4884.5	37.6	2.7	40.3	74.0	-33.7	Peak	Vertical
*	6491.0	35.4	7.3	42.7	79.9	-37.2	Peak	Vertical
*	9763.5	35.1	12.8	47.9	79.9	-32.0	Peak	Vertical

Note 1: "*" is not in restricted band, its limit is 20dBc of the fundamental emission level (99.9dBμV/m) or 15.209 which is higher.

Note 2: Measure Level (dBμV/m) = Reading Level (dBμV) + Factor (dB)

Factor (dB) = Cable Loss (dB) + Antenna Factor (dB/m) - Pre_Amplifier Gain (dB)

Test Mode:	3DH5	Test Site:	AC2
Test channel:	78	Test Engineer:	Will Yan
Remark:	1. Average measurement was not performed if peak level lower than average limit. 2. Other frequency was 20dB below limit line within 1-18GHz, there is not show in the report.		

Mark	Frequency (MHz)	Reading Level (dBμV)	Factor (dB)	Measure Level (dBμV/m)	Limit (dBμV/m)	Margin (dB)	Detector	Polarization
	3856.0	38.9	-0.6	38.3	74.0	-35.7	Peak	Horizontal
	4961.0	41.7	2.7	44.4	74.0	-29.6	Peak	Horizontal
*	6423.0	36.8	6.7	43.5	73.9	-30.4	Peak	Horizontal
*	9755.0	34.6	13.0	47.6	73.9	-26.3	Peak	Horizontal
	3728.5	40.2	-0.8	39.4	74.0	-34.6	Peak	Vertical
	4961.0	42.7	2.7	45.4	74.0	-28.6	Peak	Vertical
*	6584.5	35.0	7.5	42.5	73.9	-31.4	Peak	Vertical
*	9772.0	35.2	12.6	47.8	73.9	-26.1	Peak	Vertical

Note 1: "*" is not in restricted band, its limit is 20dBc of the fundamental emission level (93.9dBμV/m) or 15.209 which is higher.

Note 2: Measure Level (dBμV/m) = Reading Level (dBμV) + Factor (dB)

Factor (dB) = Cable Loss (dB) + Antenna Factor (dB/m) - Pre_Amplifier Gain (dB)

The worst case of Radiated Emission 9KHz ~ 1GHz and 18GHz ~ 25GHz:

Site: AC2	Time: 2016/08/16 - 16:31
Limit: FCC_Part15.209_RE(3m)	Engineer: Jone Zhang
Probe: VULB9162_0.03-8GHz	Polarity: Horizontal
EUT: Solo Pro	Power: AC 120V/60Hz
Mode: Transmit at Channel 2480MHz by 2DH5	

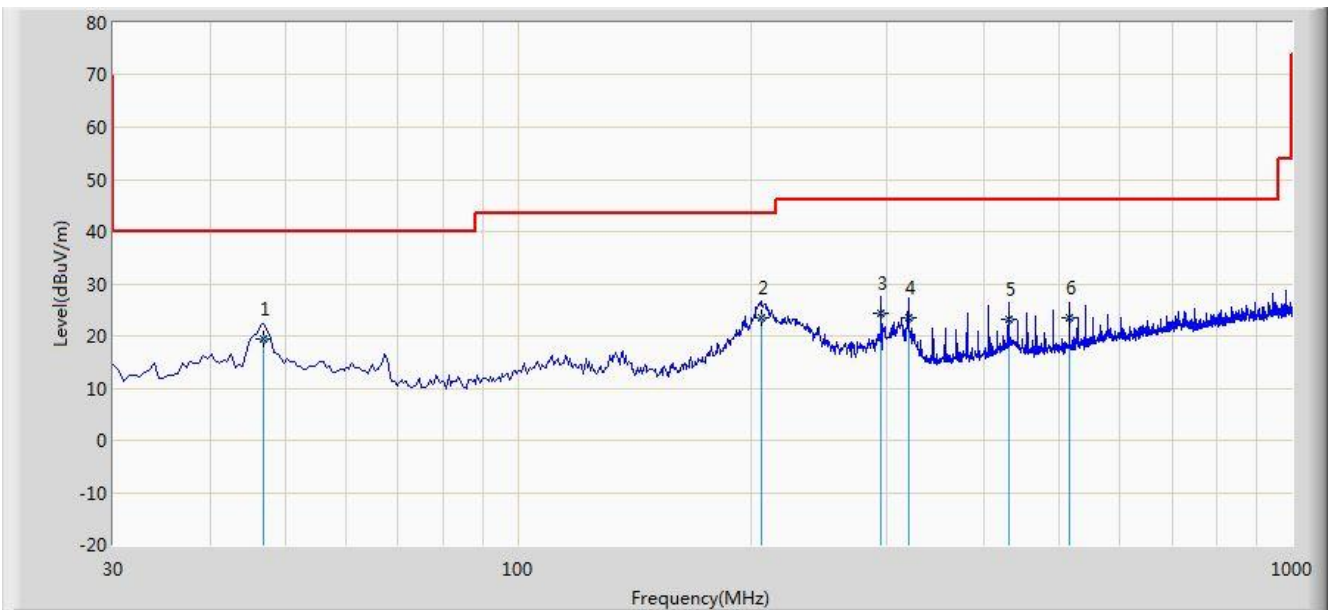

No	Mark	Frequency (MHz)	Measure Level (dBuV/m)	Reading Level (dBuV)	Over Limit (dB)	Limit (dBuV/m)	Factor (dB)	Type
1		46.975	19.347	4.367	-20.653	40.000	14.980	QP
2	*	206.055	23.384	11.003	-20.116	43.500	12.382	QP
3		294.810	24.462	10.002	-21.538	46.000	14.461	QP
4		319.545	23.535	8.458	-22.465	46.000	15.077	QP
5		430.220	23.164	6.024	-22.836	46.000	17.140	QP
6		515.970	23.402	4.841	-22.598	46.000	18.561	QP

Note: Measure Level (dB μ V/m) = Reading Level (dB μ V) + Factor (dB)

Factor (dB) = Cable Loss (dB) + Antenna Factor (dB/m)

Site: AC2	Time: 2016/08/16 - 16:36
Limit: FCC_Part15.209_RE(3m)	Engineer: Jone Zhang
Probe: VULB9162_0.03-8GHz	Polarity: Vertical
EUT: Solo Pro	Power: AC 120V/60Hz
Mode: Transmit at Channel 2480MHz by 2DH5	

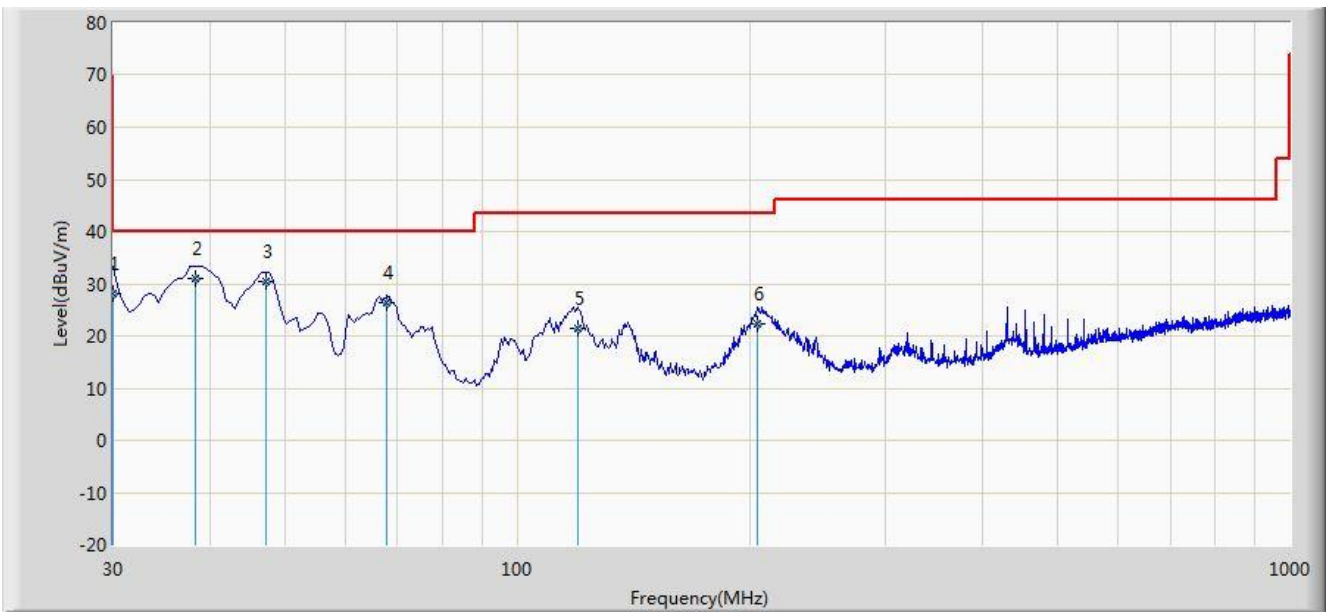

No	Mark	Frequency (MHz)	Measure Level (dBuV/m)	Reading Level (dBuV)	Over Limit (dB)	Limit (dBuV/m)	Factor (dB)	Type
1		30.000	28.167	16.100	-11.833	40.000	12.067	QP
2	*	38.410	31.141	17.600	-8.859	40.000	13.542	QP
3		47.395	30.471	15.500	-9.529	40.000	14.971	QP
4		67.825	26.407	14.800	-13.593	40.000	11.607	QP
5		119.725	21.372	10.046	-22.128	43.500	11.326	QP
6		204.900	22.366	10.003	-21.134	43.500	12.363	QP

Note: Measure Level (dB μ V/m) = Reading Level (dB μ V) + Factor (dB)

Factor (dB) = Cable Loss (dB) + Antenna Factor (dB/m)

Site: AC2	Time: 2016/08/22 - 18:06
Limit: FCC_Part15.209_RE(3m)	Engineer: Jone Zhang
Probe: FMZB1519_0.009-30MHz	Polarity: Face On
EUT: Solo Pro	Power: AC 120V/60Hz
Note: There is the ambient noise within frequency range 9kHz~30MHz.	

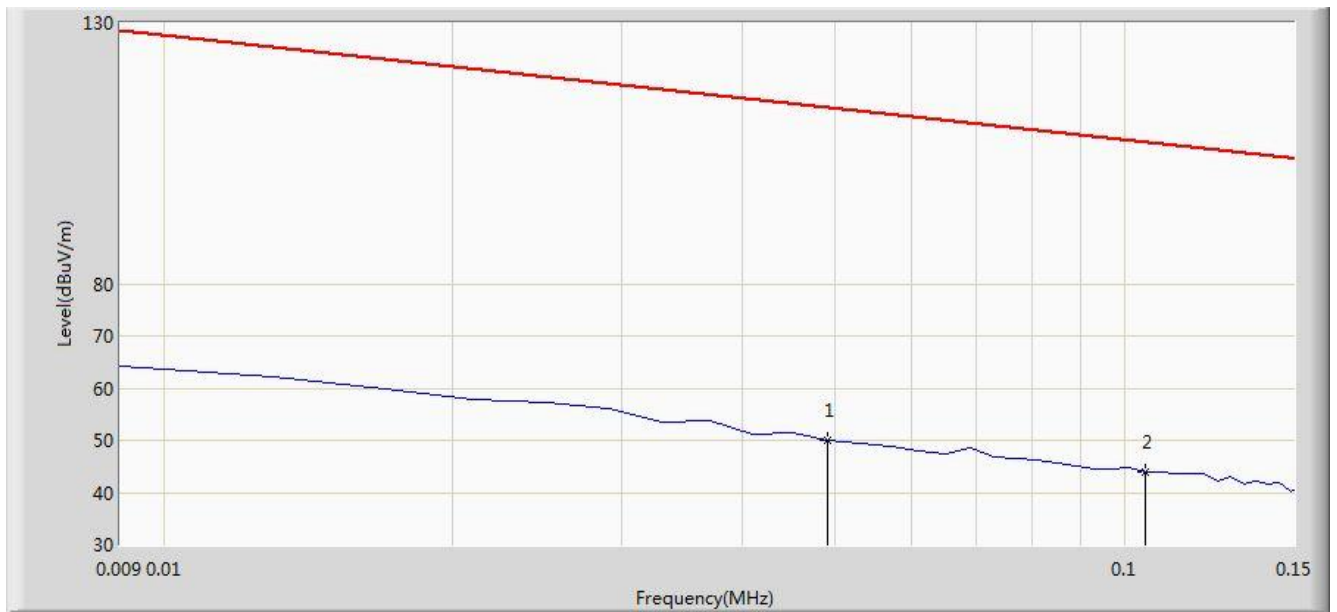

No	Flag	Mark	Frequency (MHz)	Measure Level (dBuV/m)	Reading Level (dBuV)	Over Limit (dB)	Limit (dBuV/m)	Factor (dB)	Type
1			0.049	50.112	29.552	-63.677	113.789	20.560	AV
2		*	0.105	44.043	23.845	-63.130	107.173	20.198	QP

Note: Measure Level (dB μ V/m) = Reading Level (dB μ V) + Factor (dB)

Factor (dB) = Cable Loss (dB) + Antenna Factor (dB/m)

Limit@3m = 20*Log((2400/49)uV/m) + 40*Log(300m/3m) = 113.800dB μ V/m (Average detector)

Site: AC2	Time: 2016/08/22 - 18:07
Limit: FCC_Part15.209_RE(3m)	Engineer: Jone Zhang
Probe: FMZB1519_0.009-30MHz	Polarity: Face On
EUT: Solo Pro	Power: AC 120V/60Hz
Note: There is the ambient noise within frequency range 9kHz~30MHz.	

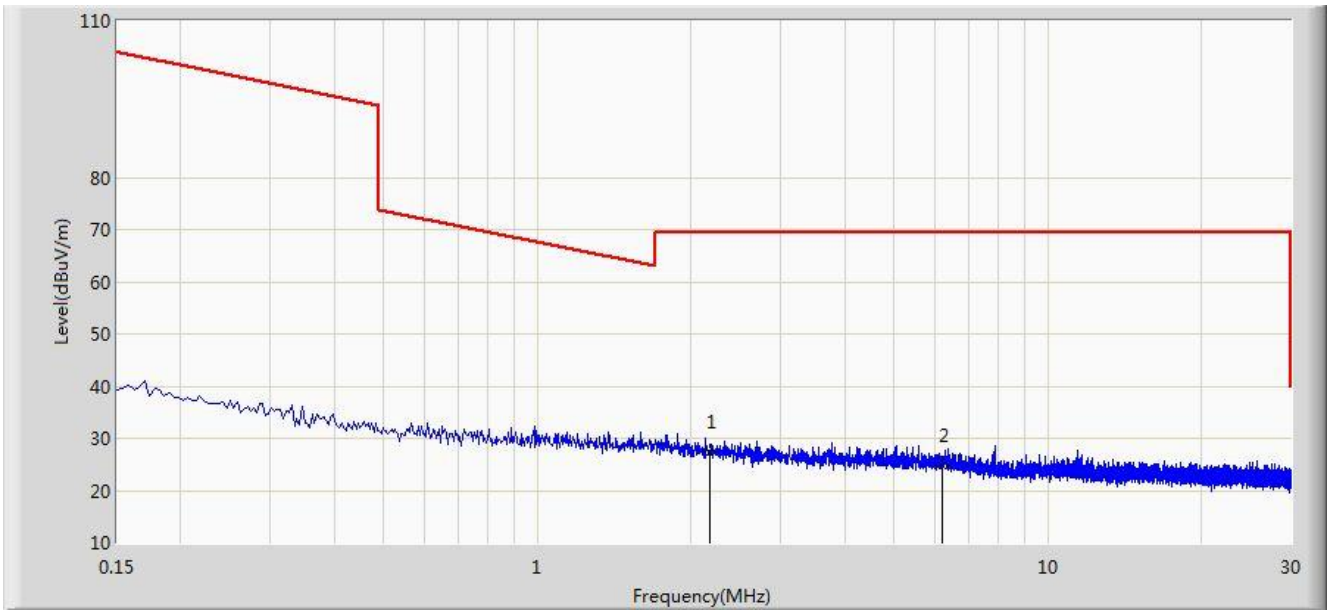

No	Flag	Mark	Frequency (MHz)	Measure Level (dBuV/m)	Reading Level (dBuV)	Over Limit (dB)	Limit (dBuV/m)	Factor (dB)	Type
1		*	2.175	27.371	6.960	-42.129	69.500	20.412	QP
2			6.216	24.786	4.701	-44.714	69.500	20.085	QP

Note: Measure Level (dBμV/m) = Reading Level (dBμV) + Factor (dB)

Factor (dB) = Cable Loss (dB) + Antenna Factor (dB/m)

Site: AC2	Time: 2016/08/22 - 20:25
Limit: FCC_Part15.209_RE(1m)	Engineer: Roy Cheng
Probe: BBHA9170_18-40GHz	Polarity: Horizontal
EUT: Solo Pro	Power: AC 120V/60Hz
Note: There is the ambient noise within frequency range 18GHz~25GHz.	

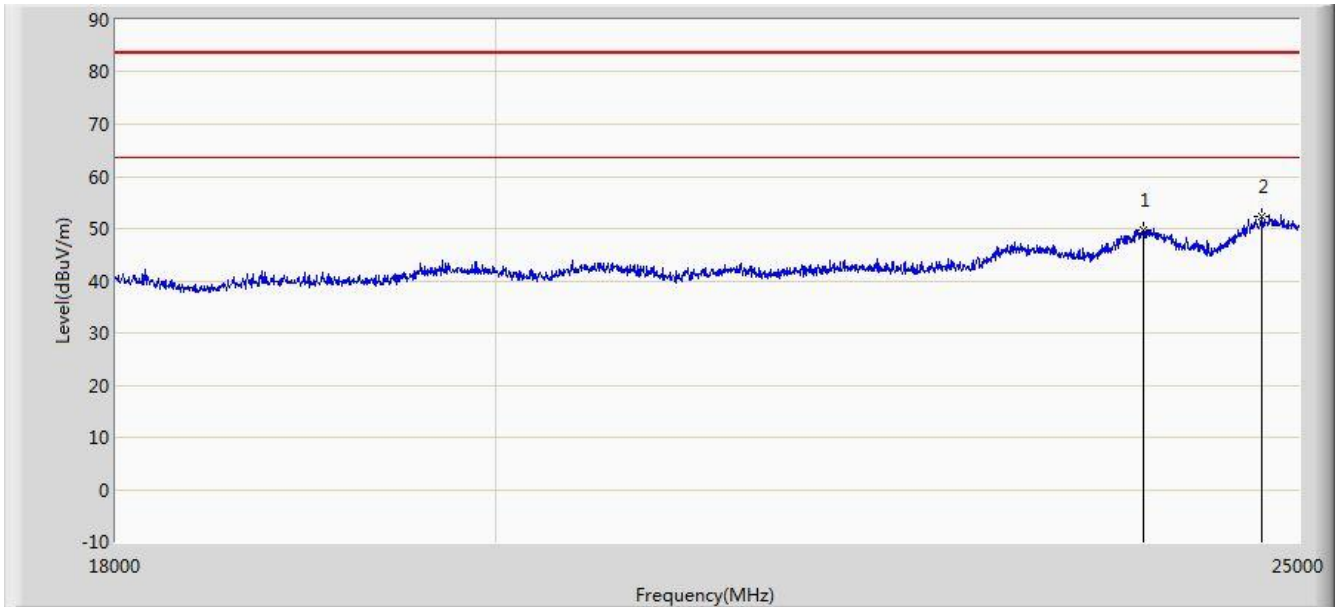

No	Flag	Mark	Frequency (MHz)	Measure Level (dBuV/m)	Reading Level (dBuV)	Over Limit (dB)	Limit (dBuV/m)	Factor (dB)	Type
1			23943.000	49.776	35.866	-33.724	83.500	13.910	PK
2		*	24741.000	52.375	37.681	-31.125	83.500	14.694	PK

Note: Measure Level (dB μ V/m) = Reading Level (dB μ V) + Factor (dB)

Factor (dB) = Cable Loss (dB) + Antenna Factor (dB/m) – Pre_Amplifier Gain (dB)

Site: AC2	Time: 2016/08/22 - 20:31
Limit: FCC_Part15.209_RE(1m)	Engineer: Roy Cheng
Probe: BBHA9170_18-40GHz	Polarity: Vertical
EUT: Solo Pro	Power: AC 120V/60Hz
Note: There is the ambient noise within frequency range 18GHz~25GHz.	

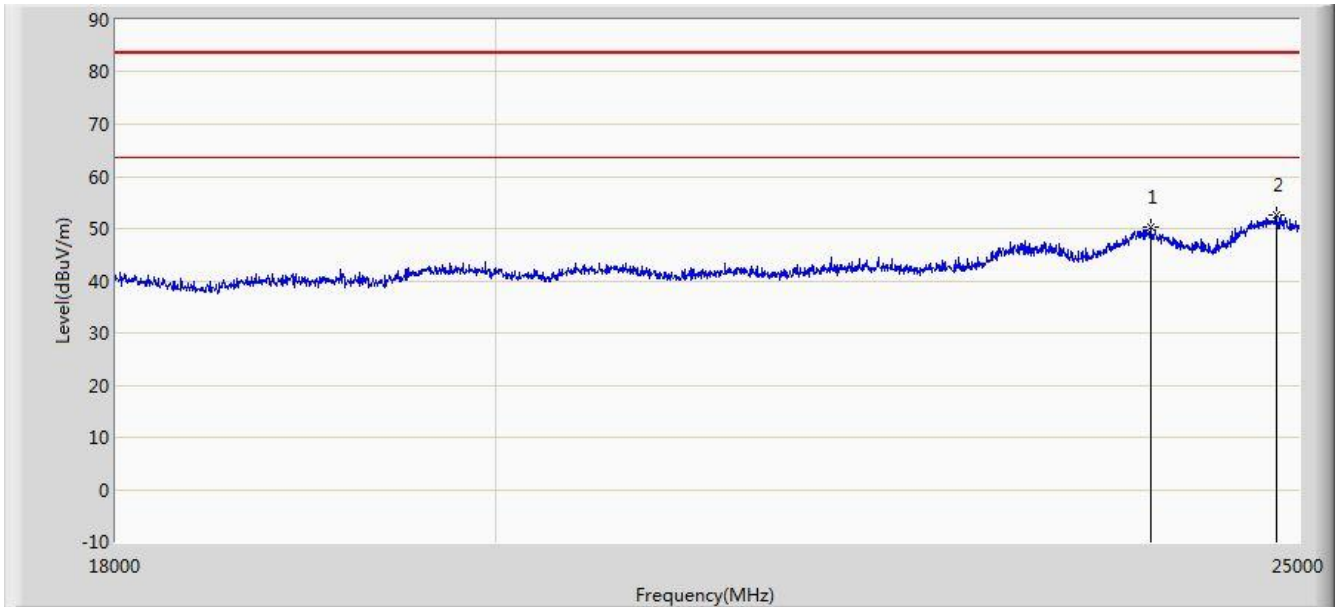

No	Flag	Mark	Frequency (MHz)	Measure Level (dBuV/m)	Reading Level (dBuV)	Over Limit (dB)	Limit (dBuV/m)	Factor (dB)	Type
1			23999.000	50.379	36.435	-33.121	83.500	13.944	PK
2		*	24846.000	52.503	37.735	-30.997	83.500	14.768	PK

Note: Measure Level (dB μ V/m) = Reading Level (dB μ V) + Factor (dB)

Factor (dB) = Cable Loss (dB) + Antenna Factor (dB/m) – Pre_Amplifier Gain (dB)

7.10. Radiated Restricted Band Edge Measurement

7.10.1. Test Result

Site: AC2	Time: 2016/08/16 - 19:13
Limit: FCC_Part15.209_RE(3m)	Engineer: Will Yan
Probe: BBHA9120D_1-18GHz	Polarity: Horizontal
EUT: Solo Pro	Power: AC 120V/60Hz
Test Mode: Transmit by DH5 at Channel 2402MHz	

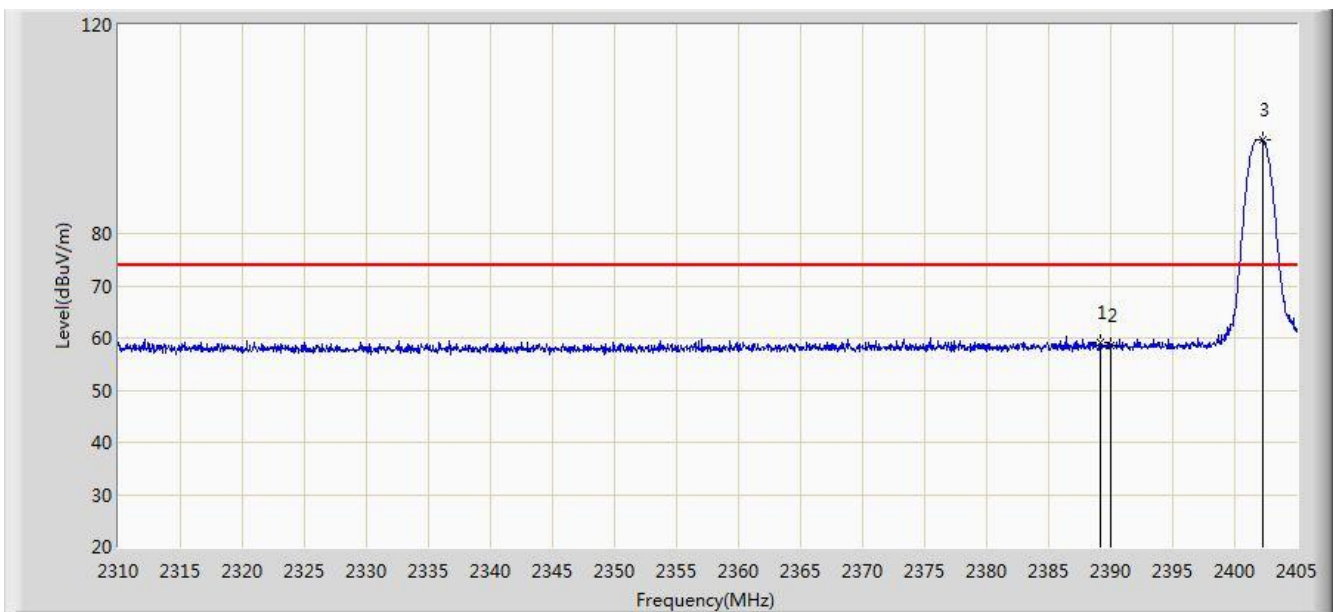

No	Flag	Mark	Frequency (MHz)	Measure Level (dBuV/m)	Reading Level (dBuV)	Over Limit (dB)	Limit (dBuV/m)	Factor (dB)	Type
1			2389.135	59.159	26.886	-14.841	74.000	32.273	PK
2			2390.000	58.600	26.322	-15.400	74.000	32.278	PK
3		*	2402.292	97.835	65.562	N/A	N/A	32.273	PK

Note: Measure Level (dB μ V/m) = Reading Level (dB μ V) + Factor (dB)

Factor (dB) = Cable Loss (dB) + Antenna Factor (dB/m)

Site: AC2	Time: 2016/08/16 - 19:16
Limit: FCC_Part15.209_RE(3m)	Engineer: Will Yan
Probe: BBHA9120D_1-18GHz	Polarity: Horizontal
EUT: Solo Pro	Power: AC 120V/60Hz
Test Mode: Transmit by DH5 at Channel 2402MHz	

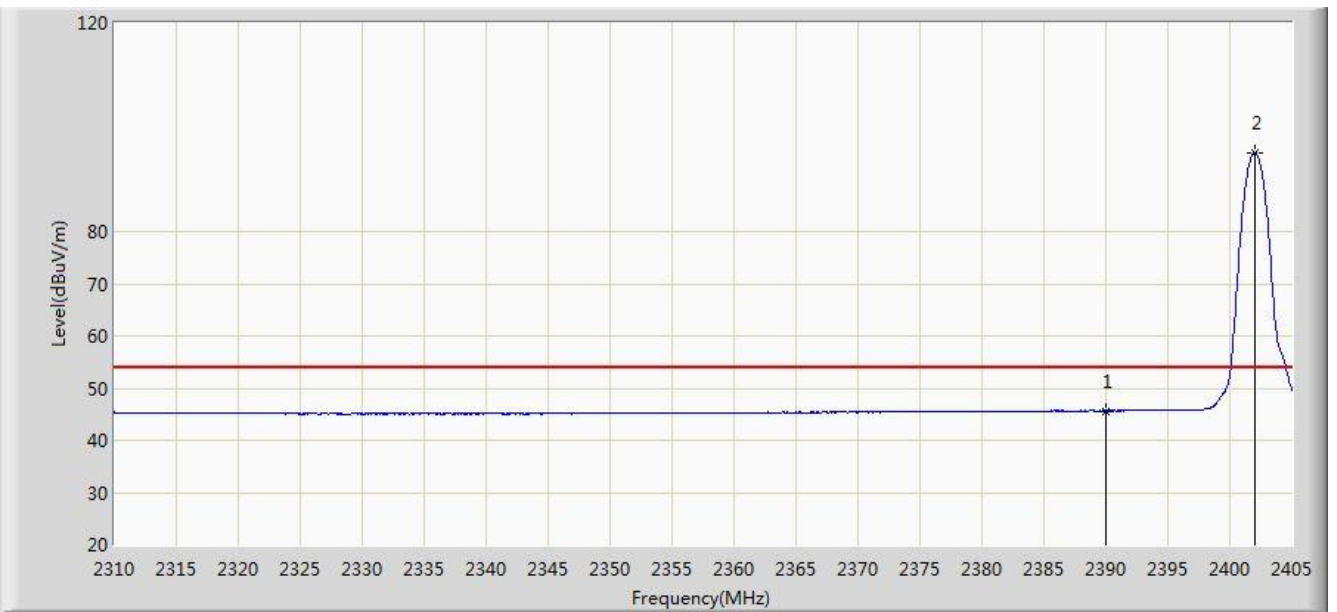

No	Flag	Mark	Frequency (MHz)	Measure Level (dBuV/m)	Reading Level (dBuV)	Over Limit (dB)	Limit (dBuV/m)	Factor (dB)	Type
1			2390.000	45.615	13.337	-8.385	54.000	32.278	AV
2		*	2402.008	95.117	62.843	N/A	N/A	32.274	AV

Note: Measure Level (dB μ V/m) = Reading Level (dB μ V) + Factor (dB)

Factor (dB) = Cable Loss (dB) + Antenna Factor (dB/m)

Site: AC2	Time: 2016/08/16 - 19:26
Limit: FCC_Part15.209_RE(3m)	Engineer: Will Yan
Probe: BBHA9120D_1-18GHz	Polarity: Vertical
EUT: Solo Pro	Power: AC 120V/60Hz
Test Mode: Transmit by DH5 at Channel 2402MHz	

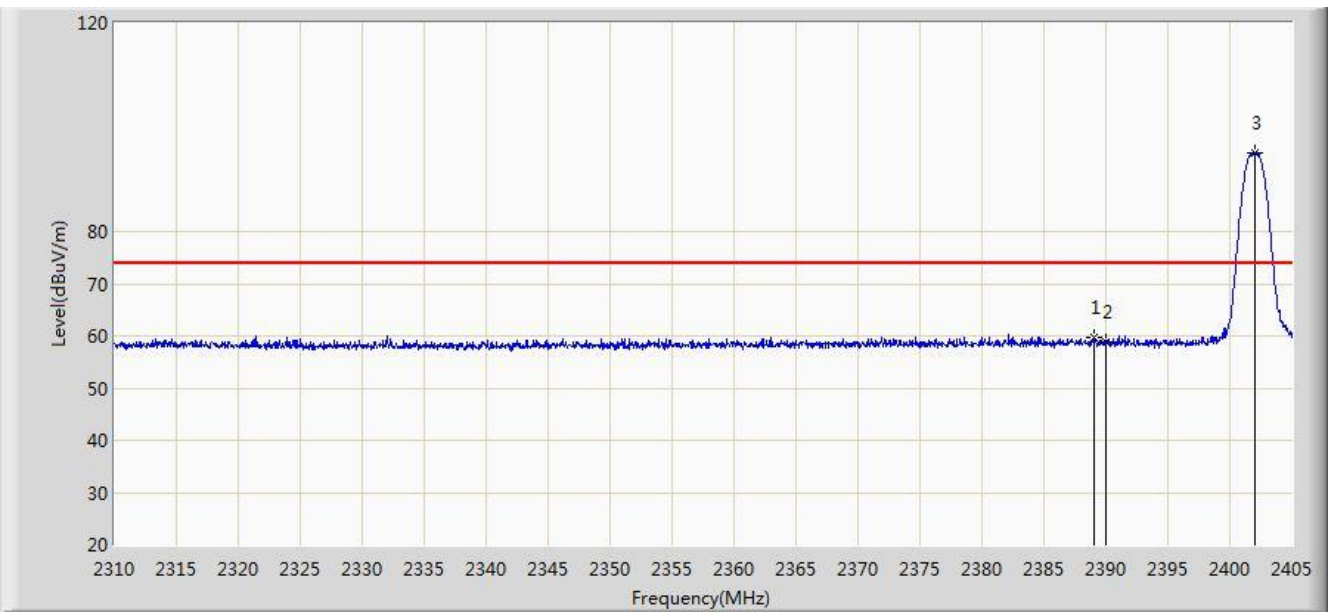

No	Flag	Mark	Frequency (MHz)	Measure Level (dBuV/m)	Reading Level (dBuV)	Over Limit (dB)	Limit (dBuV/m)	Factor (dB)	Type
1			2388.992	59.825	27.553	-14.175	74.000	32.272	PK
2			2390.000	58.943	26.665	-15.057	74.000	32.278	PK
3		*	2402.055	95.004	62.730	N/A	N/A	32.273	PK

Note: Measure Level (dB μ V/m) = Reading Level (dB μ V) + Factor (dB)

Factor (dB) = Cable Loss (dB) + Antenna Factor (dB/m)

Site: AC2	Time: 2016/08/16 - 19:30
Limit: FCC_Part15.209_RE(3m)	Engineer: Will Yan
Probe: BBHA9120D_1-18GHz	Polarity: Vertical
EUT: Solo Pro	Power: AC 120V/60Hz
Test Mode: Transmit by DH5 at Channel 2402MHz	

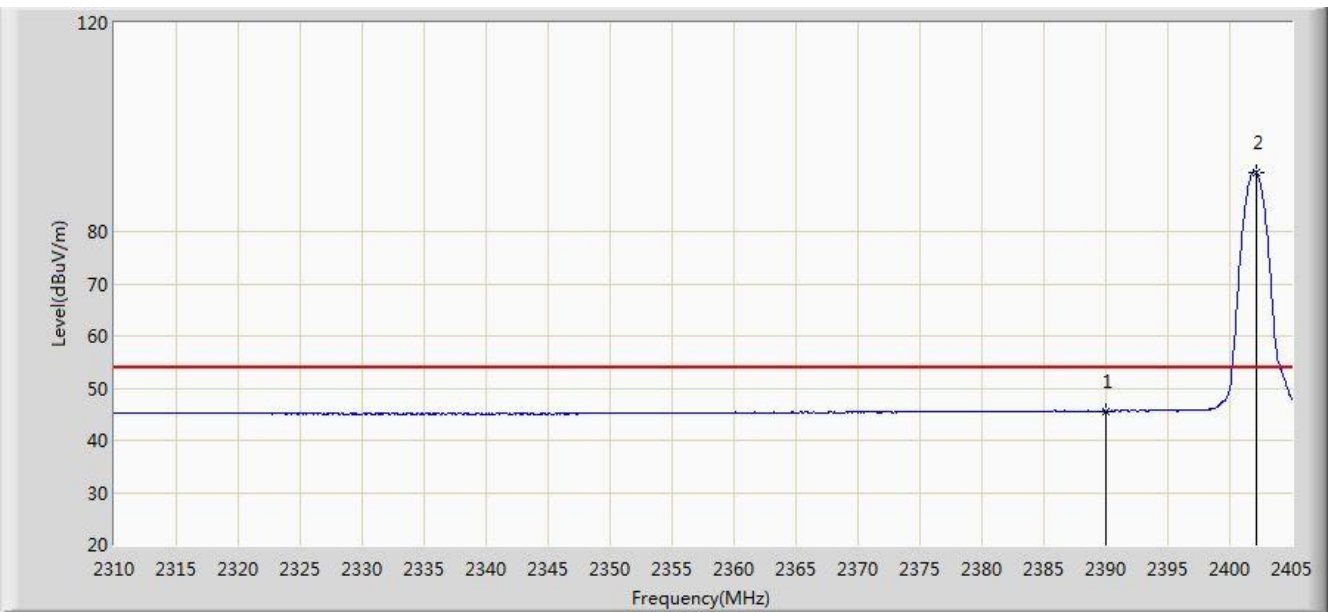

No	Flag	Mark	Frequency (MHz)	Measure Level (dBuV/m)	Reading Level (dBuV)	Over Limit (dB)	Limit (dBuV/m)	Factor (dB)	Type
1			2390.000	45.634	13.356	-8.366	54.000	32.278	AV
2		*	2402.150	91.356	59.083	N/A	N/A	32.273	AV

Note: Measure Level (dB μ V/m) = Reading Level (dB μ V) + Factor (dB)

Factor (dB) = Cable Loss (dB) + Antenna Factor (dB/m)

Site: AC2	Time: 2016/08/16 - 19:32
Limit: FCC_Part15.209_RE(3m)	Engineer: Will Yan
Probe: BBHA9120D_1-18GHz	Polarity: Horizontal
EUT: Solo Pro	Power: AC 120V/60Hz
Test Mode: Transmit by DH5 at Channel 2480MHz	

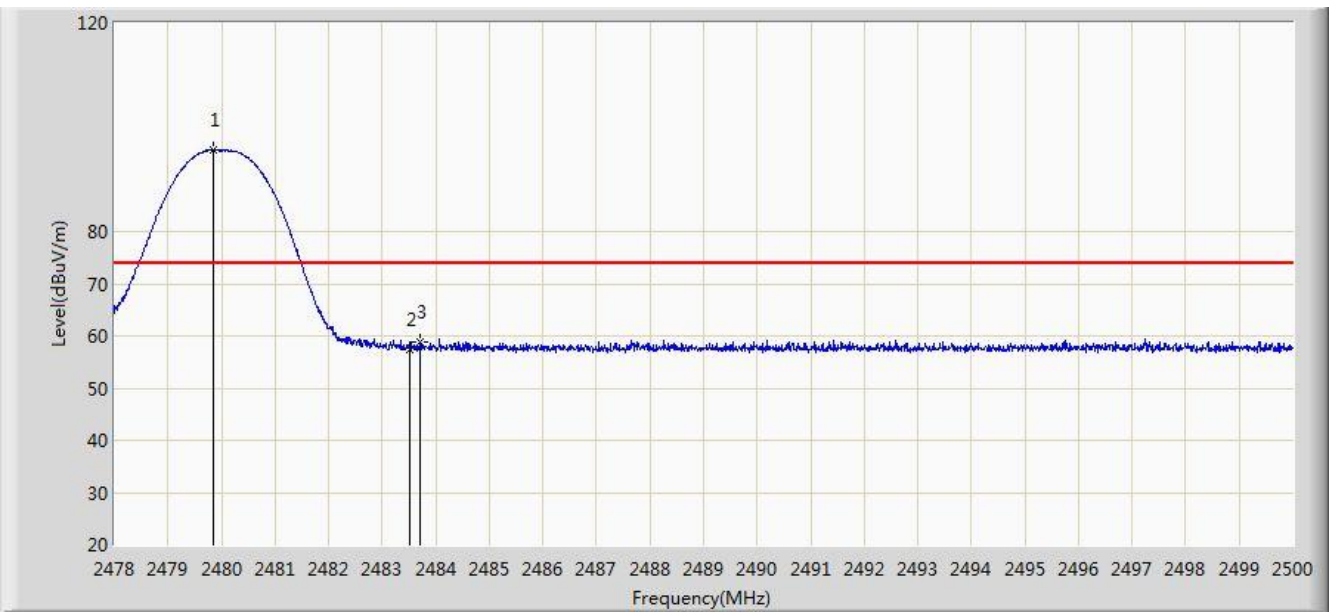

No	Flag	Mark	Frequency (MHz)	Measure Level (dBuV/m)	Reading Level (dBuV)	Over Limit (dB)	Limit (dBuV/m)	Factor (dB)	Type
1		*	2479.837	95.554	63.285	N/A	N/A	32.269	PK
2			2483.500	57.467	25.186	-16.533	74.000	32.282	PK
3			2483.698	58.963	26.681	-15.037	74.000	32.282	PK

Note: Measure Level (dB μ V/m) = Reading Level (dB μ V) + Factor (dB)

Factor (dB) = Cable Loss (dB) + Antenna Factor (dB/m)

Site: AC2	Time: 2016/08/16 - 19:49
Limit: FCC_Part15.209_RE(3m)	Engineer: Will Yan
Probe: BBHA9120D_1-18GHz	Polarity: Horizontal
EUT: Solo Pro	Power: AC 120V/60Hz
Test Mode: Transmit by DH5 at Channel 2480MHz	

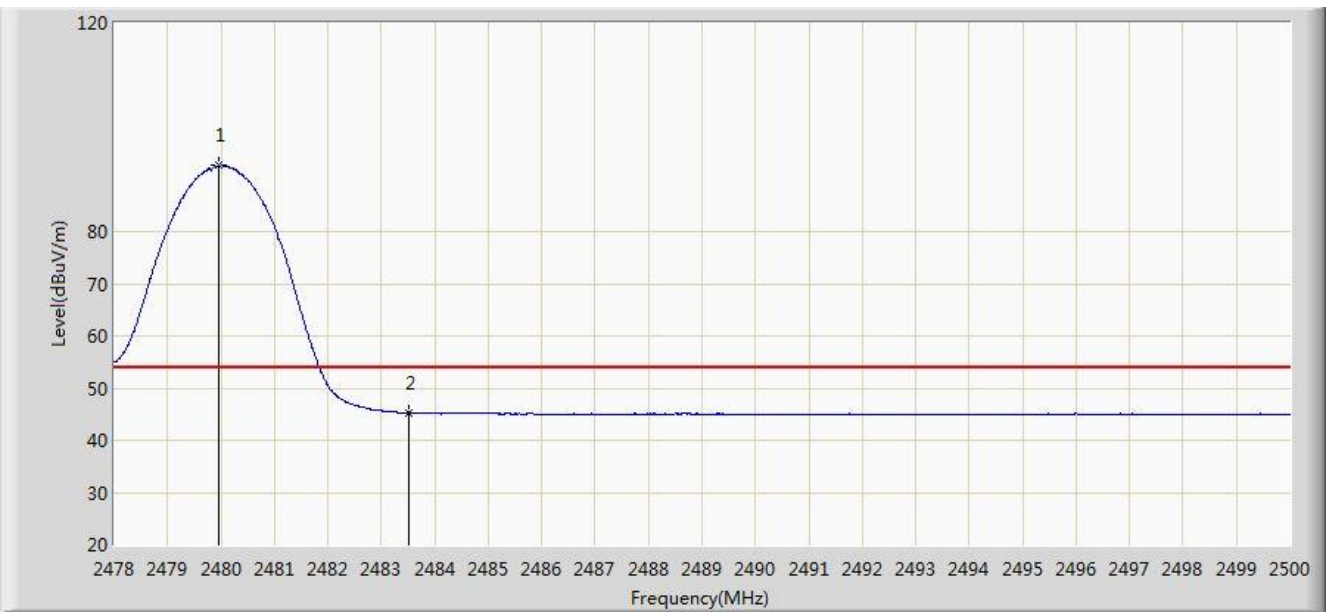

No	Flag	Mark	Frequency (MHz)	Measure Level (dBuV/m)	Reading Level (dBuV)	Over Limit (dB)	Limit (dBuV/m)	Factor (dB)	Type
1		*	2479.969	92.629	60.360	N/A	N/A	32.269	AV
2			2483.500	45.325	13.044	-8.675	54.000	32.282	AV

Note: Measure Level (dB μ V/m) = Reading Level (dB μ V) + Factor (dB)

Factor (dB) = Cable Loss (dB) + Antenna Factor (dB/m)

Site: AC2	Time: 2016/08/16 - 19:51
Limit: FCC_Part15.209_RE(3m)	Engineer: Will Yan
Probe: BBHA9120D_1-18GHz	Polarity: Vertical
EUT: Solo Pro	Power: AC 120V/60Hz
Test Mode: Transmit by DH5 at Channel 2480MHz	

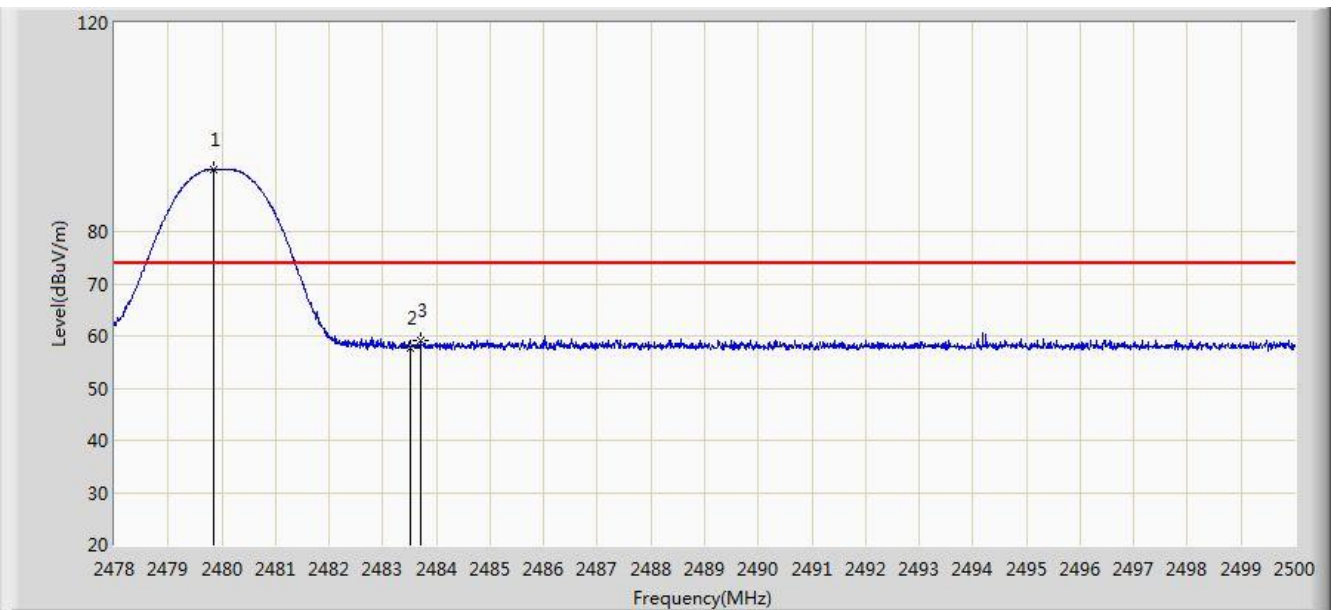

No	Flag	Mark	Frequency (MHz)	Measure Level (dBuV/m)	Reading Level (dBuV)	Over Limit (dB)	Limit (dBuV/m)	Factor (dB)	Type
1		*	2479.837	91.908	59.639	N/A	N/A	32.269	PK
2			2483.500	57.616	25.335	-16.384	74.000	32.282	PK
3			2483.709	59.077	26.795	-14.923	74.000	32.282	PK

Note: Measure Level (dB μ V/m) = Reading Level (dB μ V) + Factor (dB)

Factor (dB) = Cable Loss (dB) + Antenna Factor (dB/m)

Site: AC2	Time: 2016/08/16 - 19:55
Limit: FCC_Part15.209_RE(3m)	Engineer: Will Yan
Probe: BBHA9120D_1-18GHz	Polarity: Vertical
EUT: Solo Pro	Power: AC 120V/60Hz
Test Mode: Transmit by DH5 at Channel 2480MHz	

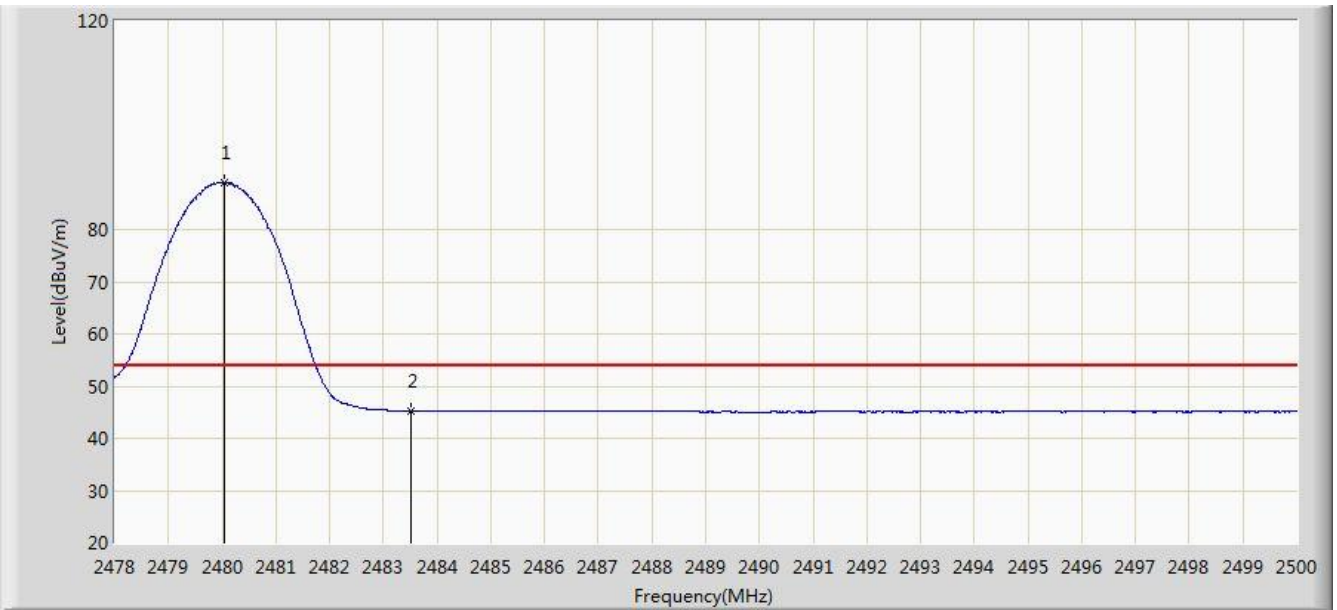

No	Flag	Mark	Frequency (MHz)	Measure Level (dBuV/m)	Reading Level (dBuV)	Over Limit (dB)	Limit (dBuV/m)	Factor (dB)	Type
1		*	2480.046	89.113	56.844	N/A	N/A	32.269	AV
2			2483.500	45.212	12.931	-8.788	54.000	32.282	AV

Note: Measure Level (dB μ V/m) = Reading Level (dB μ V) + Factor (dB)

Factor (dB) = Cable Loss (dB) + Antenna Factor (dB/m)

Site: AC2	Time: 2016/08/16 - 19:56
Limit: FCC_Part15.209_RE(3m)	Engineer: Will Yan
Probe: BBHA9120D_1-18GHz	Polarity: Horizontal
EUT: Solo Pro	Power: AC 120V/60Hz
Test Mode: Transmit by 2DH5 at Channel 2402MHz	

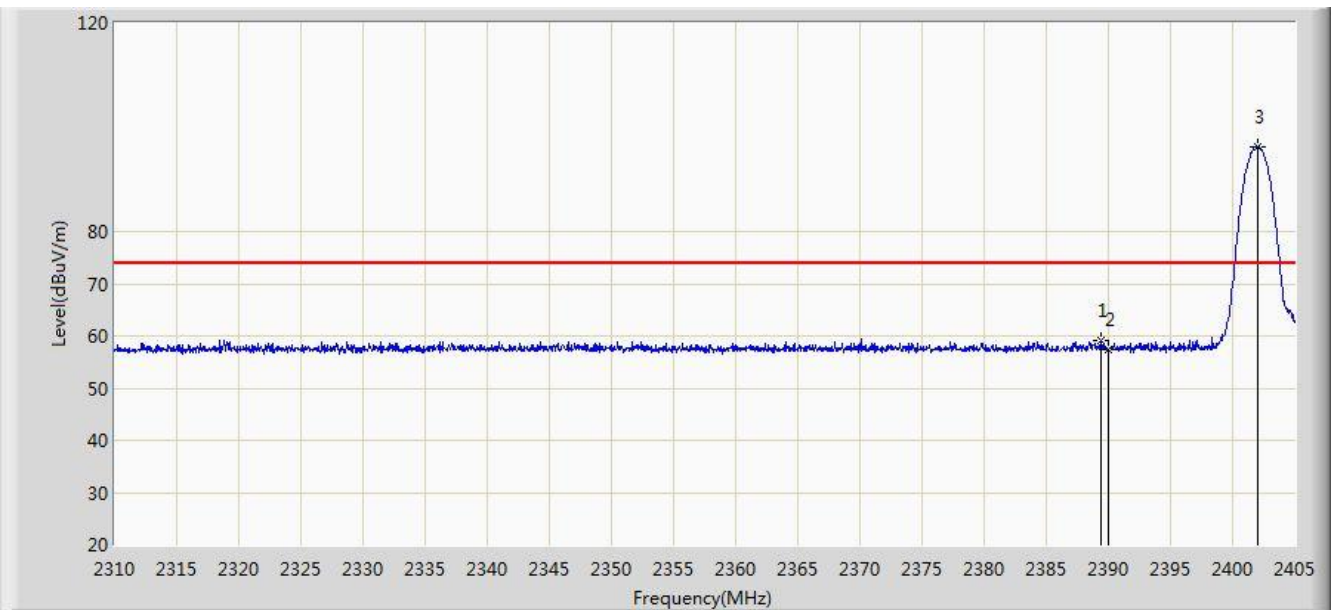

No	Flag	Mark	Frequency (MHz)	Measure Level (dBuV/m)	Reading Level (dBuV)	Over Limit (dB)	Limit (dBuV/m)	Factor (dB)	Type
1			2389.420	59.022	26.747	-14.978	74.000	32.275	PK
2			2390.000	57.342	25.064	-16.658	74.000	32.278	PK
3		*	2402.008	96.100	63.826	N/A	N/A	32.274	PK

Note: Measure Level (dB μ V/m) = Reading Level (dB μ V) + Factor (dB)

Factor (dB) = Cable Loss (dB) + Antenna Factor (dB/m)

Site: AC2	Time: 2016/08/16 - 20:02
Limit: FCC_Part15.209_RE(3m)	Engineer: Will Yan
Probe: BBHA9120D_1-18GHz	Polarity: Horizontal
EUT: Solo Pro	Power: AC 120V/60Hz
Test Mode: Transmit by 2DH5 at Channel 2402MHz	

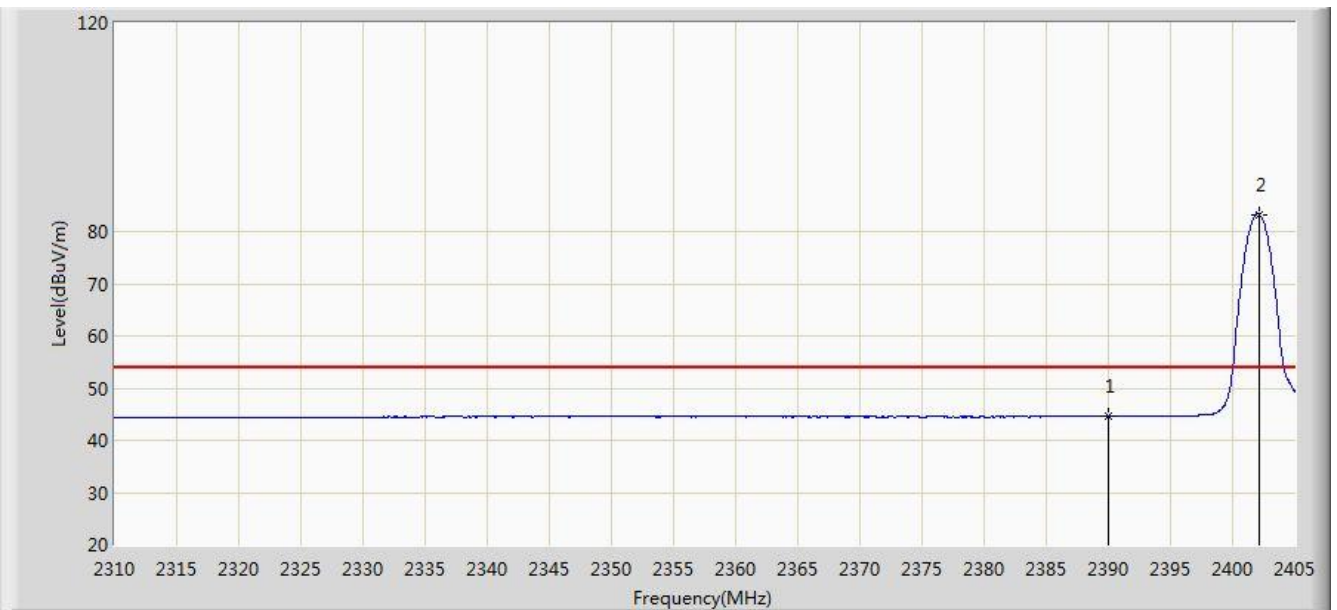

No	Flag	Mark	Frequency (MHz)	Measure Level (dBuV/m)	Reading Level (dBuV)	Over Limit (dB)	Limit (dBuV/m)	Factor (dB)	Type
1			2390.000	44.594	12.316	-9.406	54.000	32.278	AV
2		*	2402.150	83.298	51.025	N/A	N/A	32.273	AV

Note: Measure Level (dB μ V/m) = Reading Level (dB μ V) + Factor (dB)

Factor (dB) = Cable Loss (dB) + Antenna Factor (dB/m)

Site: AC2	Time: 2016/08/16 - 20:03
Limit: FCC_Part15.209_RE(3m)	Engineer: Will Yan
Probe: BBHA9120D_1-18GHz	Polarity: Vertical
EUT: Solo Pro	Power: AC 120V/60Hz
Test Mode: Transmit by 2DH5 at Channel 2402MHz	

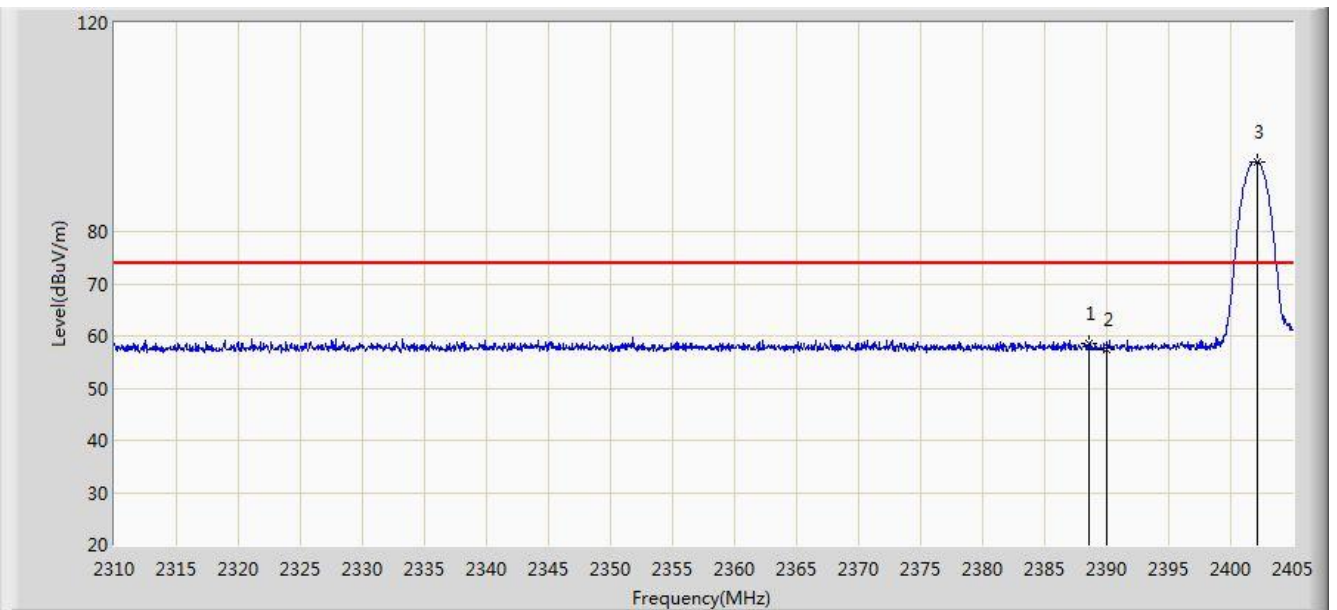

No	Flag	Mark	Frequency (MHz)	Measure Level (dBuV/m)	Reading Level (dBuV)	Over Limit (dB)	Limit (dBuV/m)	Factor (dB)	Type
1			2388.613	58.691	26.421	-15.309	74.000	32.270	PK
2			2390.000	57.479	25.201	-16.521	74.000	32.278	PK
3		*	2402.103	93.458	61.185	N/A	N/A	32.273	PK

Note: Measure Level (dB μ V/m) = Reading Level (dB μ V) + Factor (dB)

Factor (dB) = Cable Loss (dB) + Antenna Factor (dB/m)

Site: AC2	Time: 2016/08/16 - 20:08
Limit: FCC_Part15.209_RE(3m)	Engineer: Will Yan
Probe: BBHA9120D_1-18GHz	Polarity: Vertical
EUT: Solo Pro	Power: AC 120V/60Hz
Test Mode: Transmit by 2DH5 at Channel 2402MHz	

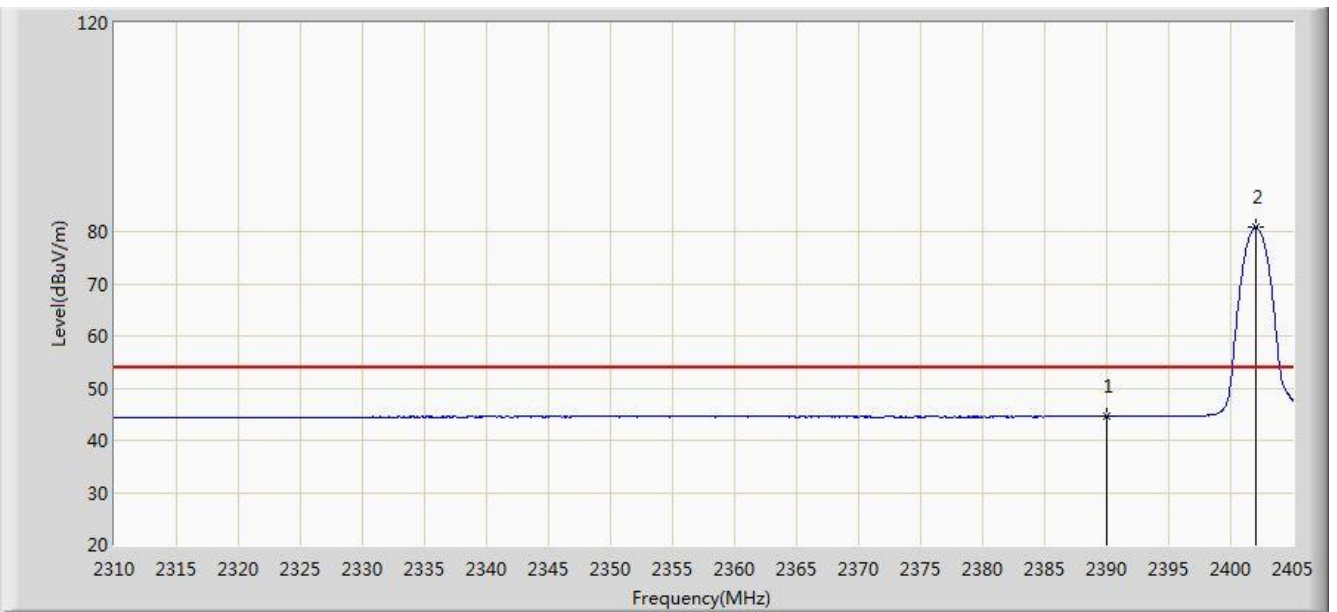

No	Flag	Mark	Frequency (MHz)	Measure Level (dBuV/m)	Reading Level (dBuV)	Over Limit (dB)	Limit (dBuV/m)	Factor (dB)	Type
1			2390.000	44.508	12.230	-9.492	54.000	32.278	AV
2		*	2402.008	80.814	48.540	N/A	N/A	32.274	AV

Note: Measure Level (dB μ V/m) = Reading Level (dB μ V) + Factor (dB)

Factor (dB) = Cable Loss (dB) + Antenna Factor (dB/m)

Site: AC2	Time: 2016/08/16 - 20:09
Limit: FCC_Part15.209_RE(3m)	Engineer: Will Yan
Probe: BBHA9120D_1-18GHz	Polarity: Horizontal
EUT: Solo Pro	Power: AC 120V/60Hz
Test Mode: Transmit by 2DH5 at Channel 2480MHz	

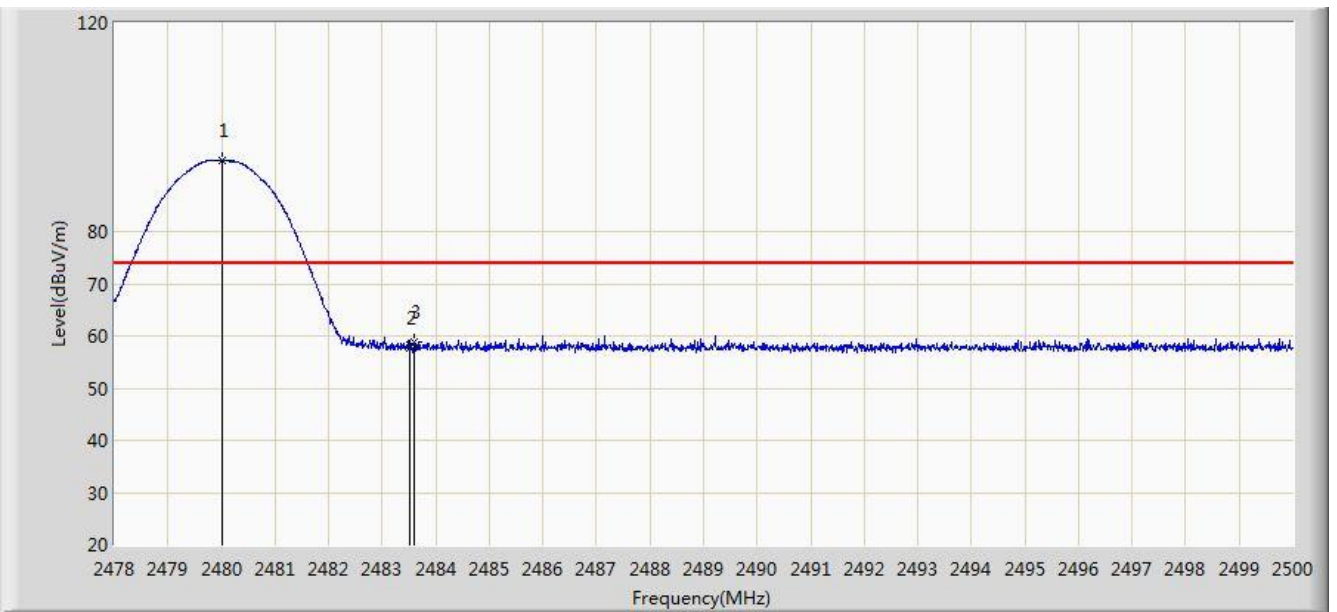

No	Flag	Mark	Frequency (MHz)	Measure Level (dBuV/m)	Reading Level (dBuV)	Over Limit (dB)	Limit (dBuV/m)	Factor (dB)	Type
1		*	2480.002	93.504	61.235	N/A	N/A	32.269	PK
2			2483.500	57.623	25.342	-16.377	74.000	32.282	PK
3			2483.610	58.769	26.487	-15.231	74.000	32.282	PK

Note: Measure Level (dB μ V/m) = Reading Level (dB μ V) + Factor (dB)

Factor (dB) = Cable Loss (dB) + Antenna Factor (dB/m)

Site: AC2	Time: 2016/08/16 - 20:11
Limit: FCC_Part15.209_RE(3m)	Engineer: Will Yan
Probe: BBHA9120D_1-18GHz	Polarity: Horizontal
EUT: Solo Pro	Power: AC 120V/60Hz
Test Mode: Transmit by 2DH5 at Channel 2480MHz	

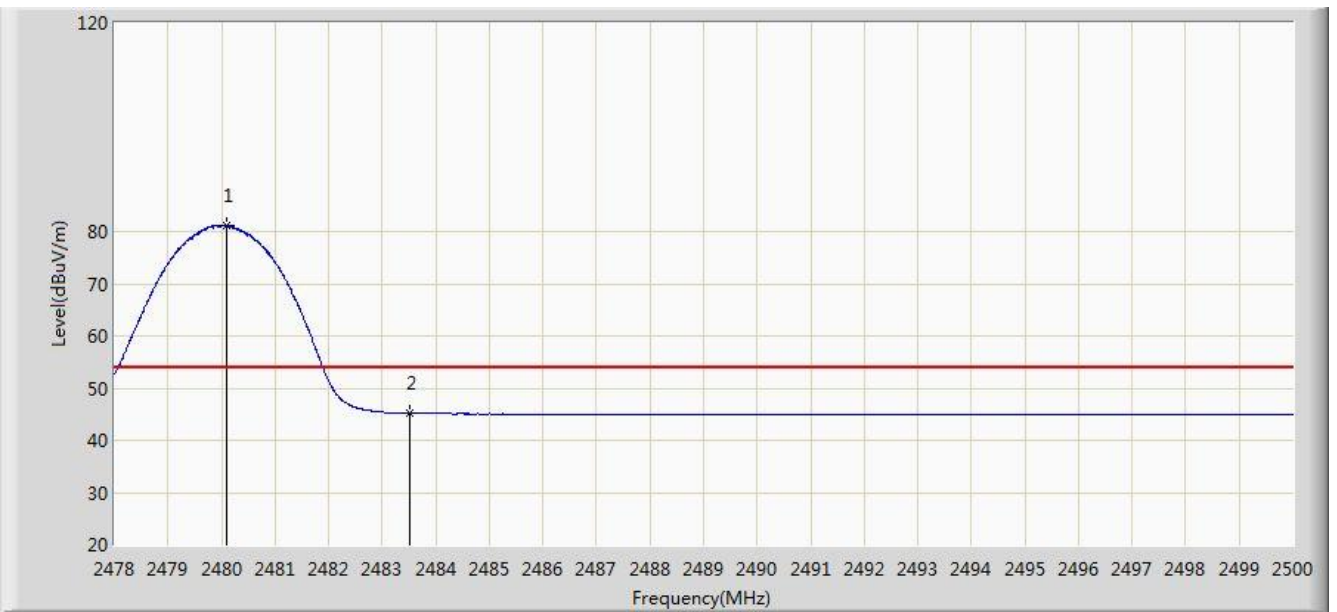

No	Flag	Mark	Frequency (MHz)	Measure Level (dBuV/m)	Reading Level (dBuV)	Over Limit (dB)	Limit (dBuV/m)	Factor (dB)	Type
1		*	2480.090	81.186	48.917	N/A	N/A	32.269	AV
2			2483.500	45.128	12.847	-8.872	54.000	32.282	AV

Note: Measure Level (dB μ V/m) = Reading Level (dB μ V) + Factor (dB)

Factor (dB) = Cable Loss (dB) + Antenna Factor (dB/m)

Site: AC2	Time: 2016/08/16 - 20:12
Limit: FCC_Part15.209_RE(3m)	Engineer: Will Yan
Probe: BBHA9120D_1-18GHz	Polarity: Vertical
EUT: Solo Pro	Power: AC 120V/60Hz
Test Mode: Transmit by 2DH5 at Channel 2480MHz	

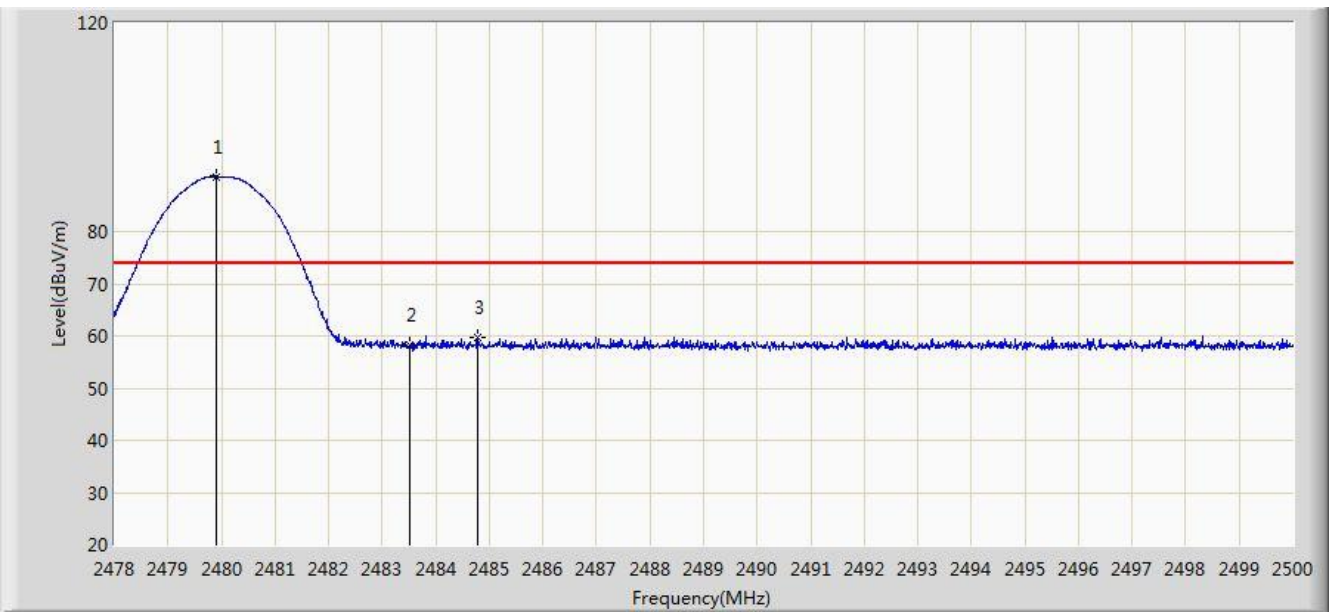

No	Flag	Mark	Frequency (MHz)	Measure Level (dBuV/m)	Reading Level (dBuV)	Over Limit (dB)	Limit (dBuV/m)	Factor (dB)	Type
1		*	2479.903	90.462	58.193	16.462	74.000	32.269	PK
2			2483.500	58.380	26.099	-15.620	74.000	32.282	PK
3			2484.776	59.749	27.463	-14.251	74.000	32.286	PK

Note: Measure Level (dB μ V/m) = Reading Level (dB μ V) + Factor (dB)

Factor (dB) = Cable Loss (dB) + Antenna Factor (dB/m)

Site: AC2	Time: 2016/08/16 - 20:15
Limit: FCC_Part15.209_RE(3m)	Engineer: Will Yan
Probe: BBHA9120D_1-18GHz	Polarity: Vertical
EUT: Solo Pro	Power: AC 120V/60Hz
Test Mode: Transmit by 2DH5 at Channel 2480MHz	

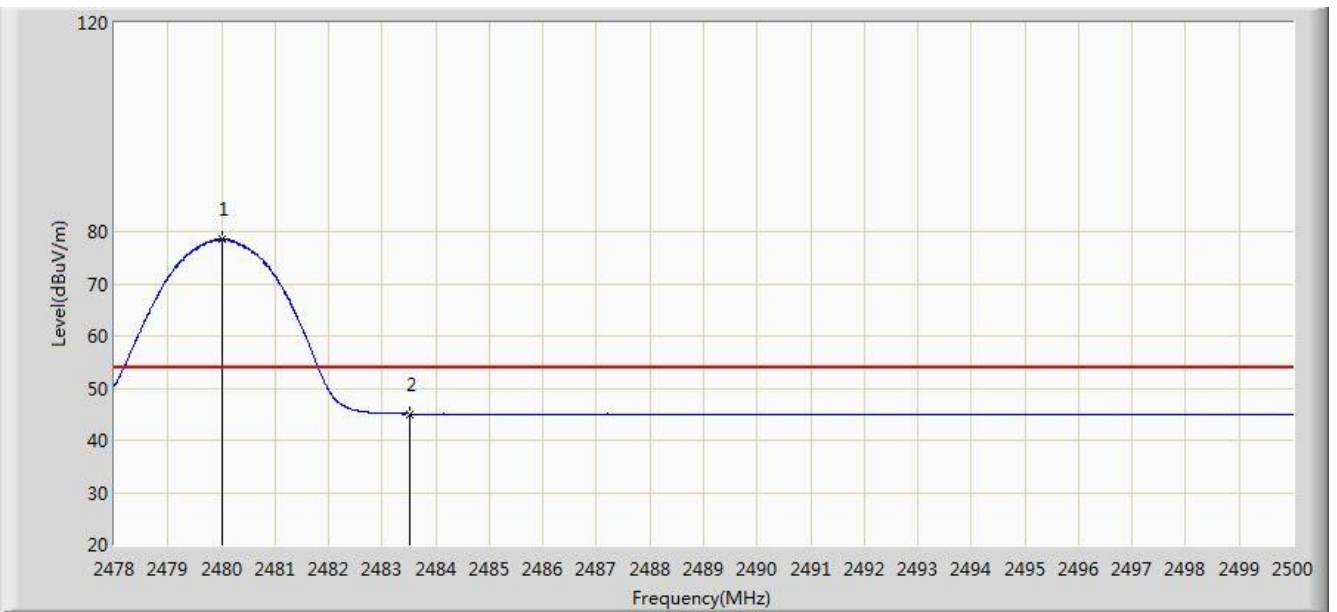

No	Flag	Mark	Frequency (MHz)	Measure Level (dBuV/m)	Reading Level (dBuV)	Over Limit (dB)	Limit (dBuV/m)	Factor (dB)	Type
1		*	2480.013	78.578	46.309	N/A	N/A	32.269	AV
2			2483.500	45.071	12.790	-8.929	54.000	32.282	AV

Note: Measure Level (dB μ V/m) = Reading Level (dB μ V) + Factor (dB)

Factor (dB) = Cable Loss (dB) + Antenna Factor (dB/m)

Site: AC2	Time: 2016/08/16 - 20:16
Limit: FCC_Part15.209_RE(3m)	Engineer: Will Yan
Probe: BBHA9120D_1-18GHz	Polarity: Horizontal
EUT: Solo Pro	Power: AC 120V/60Hz
Test Mode: Transmit by 3DH5 at Channel 2402MHz	

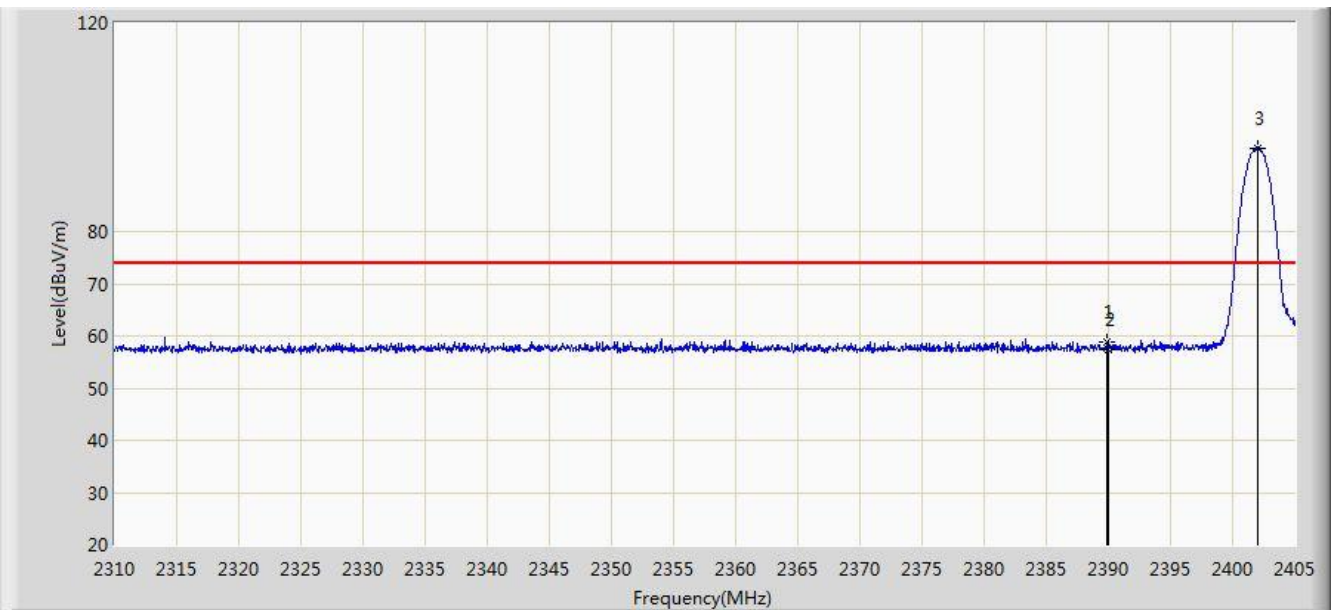

No	Flag	Mark	Frequency (MHz)	Measure Level (dBuV/m)	Reading Level (dBuV)	Over Limit (dB)	Limit (dBuV/m)	Factor (dB)	Type
1			2389.847	58.764	26.487	-15.236	74.000	32.277	PK
2			2390.000	57.423	25.145	-16.577	74.000	32.278	PK
3		*	2402.008	96.039	63.765	N/A	N/A	32.274	PK

Note: Measure Level (dB μ V/m) = Reading Level (dB μ V) + Factor (dB)

Factor (dB) = Cable Loss (dB) + Antenna Factor (dB/m)

Site: AC2	Time: 2016/08/16 - 20:20
Limit: FCC_Part15.209_RE(3m)	Engineer: Will Yan
Probe: BBHA9120D_1-18GHz	Polarity: Horizontal
EUT: Solo Pro	Power: AC 120V/60Hz
Test Mode: Transmit by 3DH5 at Channel 2402MHz	

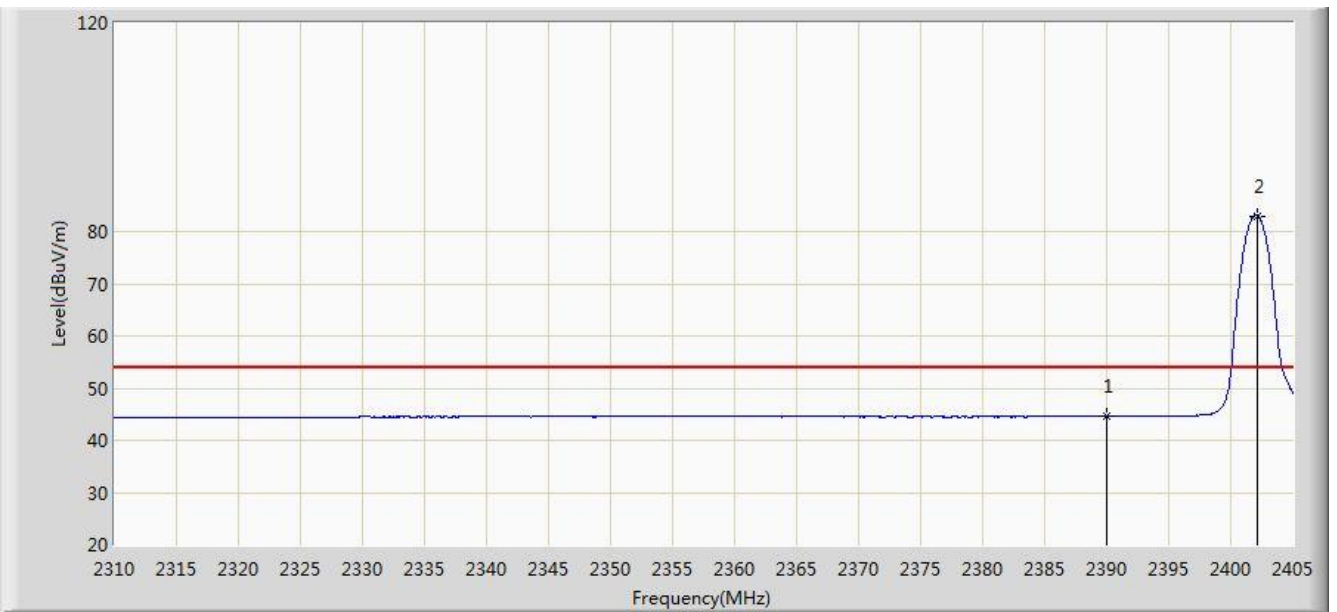

No	Flag	Mark	Frequency (MHz)	Measure Level (dBuV/m)	Reading Level (dBuV)	Over Limit (dB)	Limit (dBuV/m)	Factor (dB)	Type
1			2390.000	44.576	12.298	-9.424	54.000	32.278	AV
2		*	2402.150	83.020	50.747	29.020	54.000	32.273	AV

Note: Measure Level (dB μ V/m) = Reading Level (dB μ V) + Factor (dB)

Factor (dB) = Cable Loss (dB) + Antenna Factor (dB/m)

Site: AC2	Time: 2016/08/16 - 20:21
Limit: FCC_Part15.209_RE(3m)	Engineer: Will Yan
Probe: BBHA9120D_1-18GHz	Polarity: Vertical
EUT: Solo Pro	Power: AC 120V/60Hz
Test Mode: Transmit by 3DH5 at Channel 2402MHz	

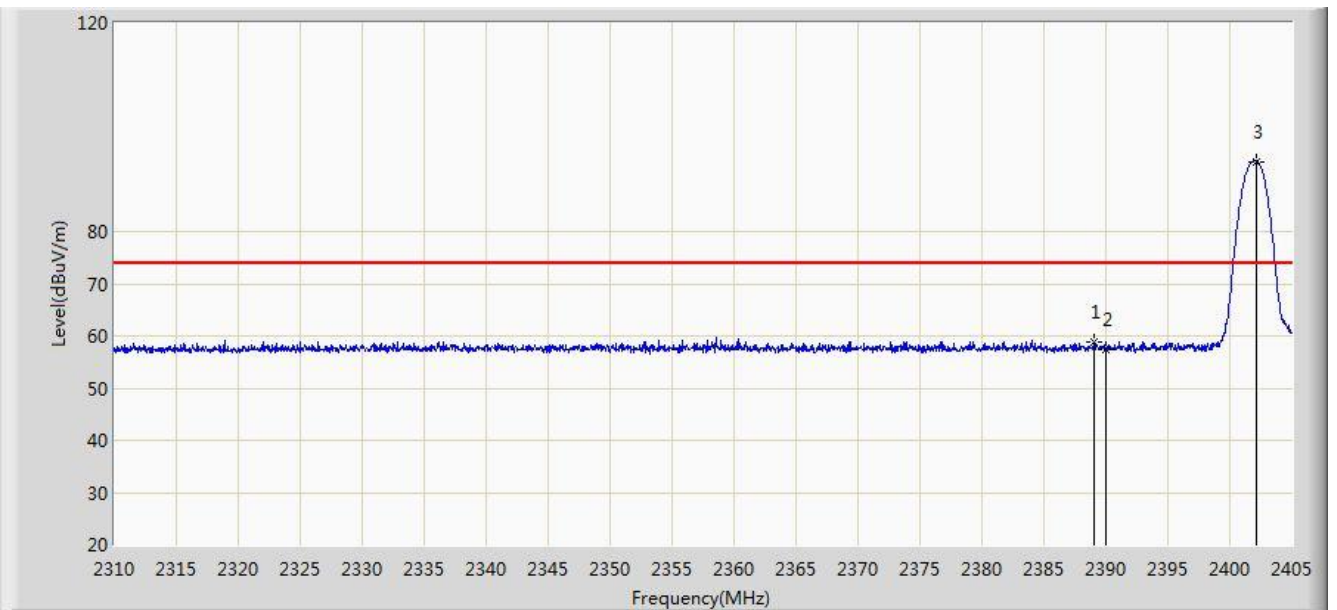

No	Flag	Mark	Frequency (MHz)	Measure Level (dBuV/m)	Reading Level (dBuV)	Over Limit (dB)	Limit (dBuV/m)	Factor (dB)	Type
1			2388.992	58.740	26.468	-15.260	74.000	32.272	PK
2			2390.000	57.458	25.180	-16.542	74.000	32.278	PK
3		*	2402.150	93.476	61.203	N/A	N/A	32.273	PK

Note: Measure Level (dB μ V/m) = Reading Level (dB μ V) + Factor (dB)

Factor (dB) = Cable Loss (dB) + Antenna Factor (dB/m)

Site: AC2	Time: 2016/08/16 - 20:24
Limit: FCC_Part15.209_RE(3m)	Engineer: Will Yan
Probe: BBHA9120D_1-18GHz	Polarity: Vertical
EUT: Solo Pro	Power: AC 120V/60Hz
Test Mode: Transmit by 3DH5 at Channel 2402MHz	

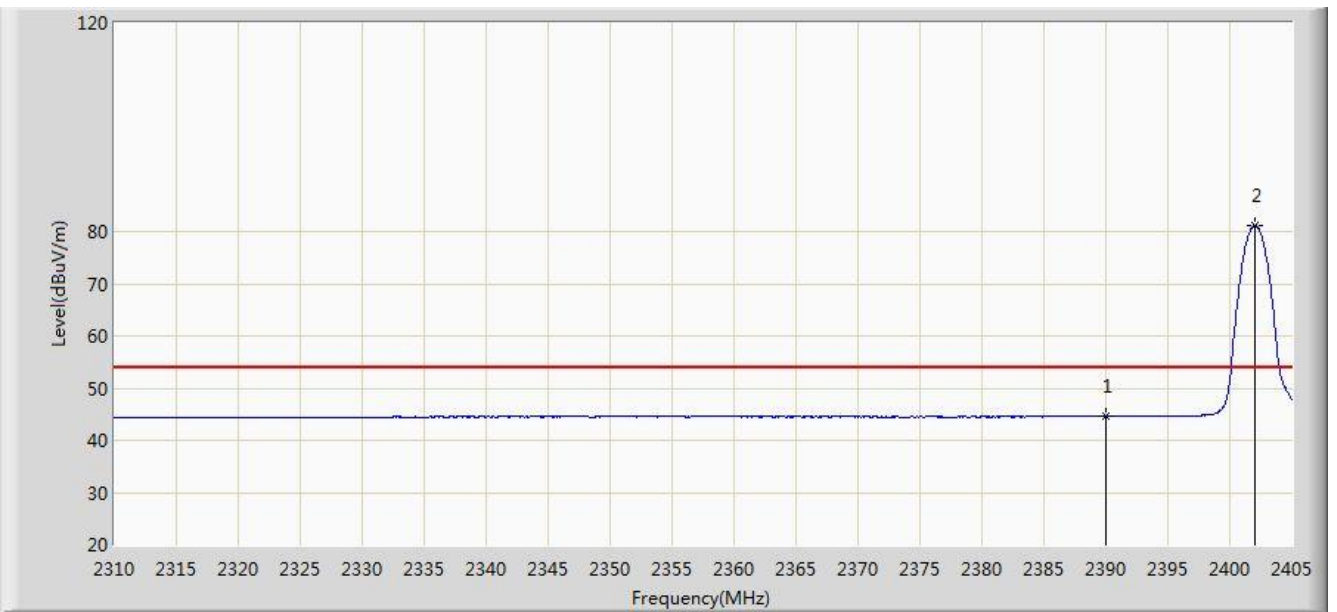

No	Flag	Mark	Frequency (MHz)	Measure Level (dBuV/m)	Reading Level (dBuV)	Over Limit (dB)	Limit (dBuV/m)	Factor (dB)	Type
1			2390.000	44.554	12.276	-9.446	54.000	32.278	AV
2		*	2402.008	81.081	48.807	N/A	N/A	32.274	AV

Note: Measure Level (dB μ V/m) = Reading Level (dB μ V) + Factor (dB)

Factor (dB) = Cable Loss (dB) + Antenna Factor (dB/m)

Site: AC2	Time: 2016/08/16 - 20:25
Limit: FCC_Part15.209_RE(3m)	Engineer: Will Yan
Probe: BBHA9120D_1-18GHz	Polarity: Horizontal
EUT: Solo Pro	Power: AC 120V/60Hz
Test Mode: Transmit by 3DH5 at Channel 2480MHz	

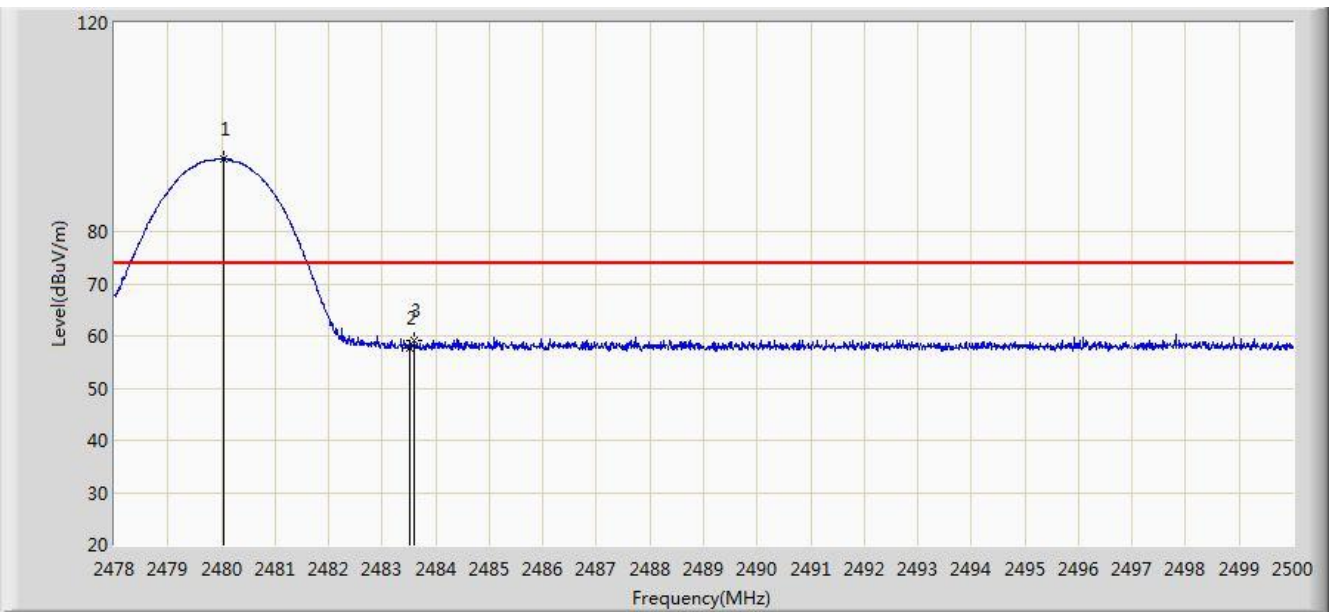

No	Flag	Mark	Frequency (MHz)	Measure Level (dBuV/m)	Reading Level (dBuV)	Over Limit (dB)	Limit (dBuV/m)	Factor (dB)	Type
1		*	2480.046	93.906	61.637	N/A	N/A	32.269	PK
2			2483.500	57.706	25.425	-16.294	74.000	32.282	PK
3			2483.610	59.101	26.819	-14.899	74.000	32.282	PK

Note: Measure Level (dB μ V/m) = Reading Level (dB μ V) + Factor (dB)

Factor (dB) = Cable Loss (dB) + Antenna Factor (dB/m)

Site: AC2	Time: 2016/08/16 - 20:28
Limit: FCC_Part15.209_RE(3m)	Engineer: Will Yan
Probe: BBHA9120D_1-18GHz	Polarity: Horizontal
EUT: Solo Pro	Power: AC 120V/60Hz
Test Mode: Transmit by 3DH5 at Channel 2480MHz	

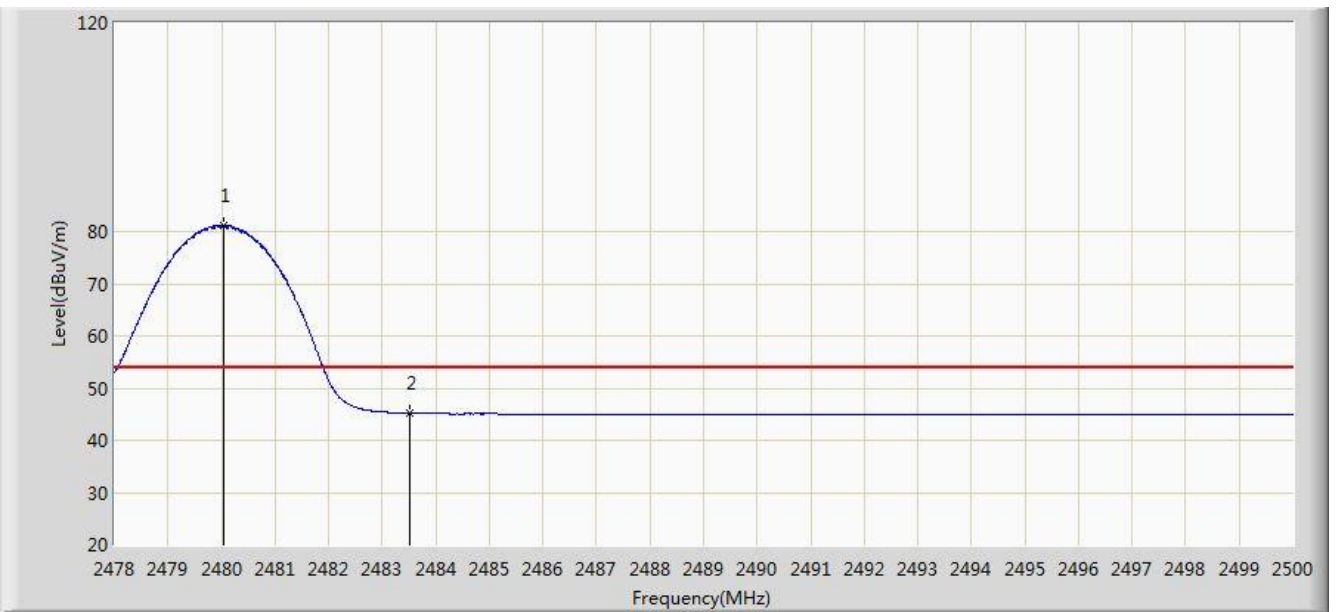

No	Flag	Mark	Frequency (MHz)	Measure Level (dBuV/m)	Reading Level (dBuV)	Over Limit (dB)	Limit (dBuV/m)	Factor (dB)	Type
1		*	2480.046	81.111	48.842	N/A	N/A	32.269	AV
2			2483.500	45.150	12.869	-8.850	54.000	32.282	AV

Note: Measure Level (dB μ V/m) = Reading Level (dB μ V) + Factor (dB)

Factor (dB) = Cable Loss (dB) + Antenna Factor (dB/m)

Site: AC2	Time: 2016/08/16 - 20:29
Limit: FCC_Part15.209_RE(3m)	Engineer: Will Yan
Probe: BBHA9120D_1-18GHz	Polarity: Vertical
EUT: Solo Pro	Power: AC 120V/60Hz
Test Mode: Transmit by 3DH5 at Channel 2480MHz	

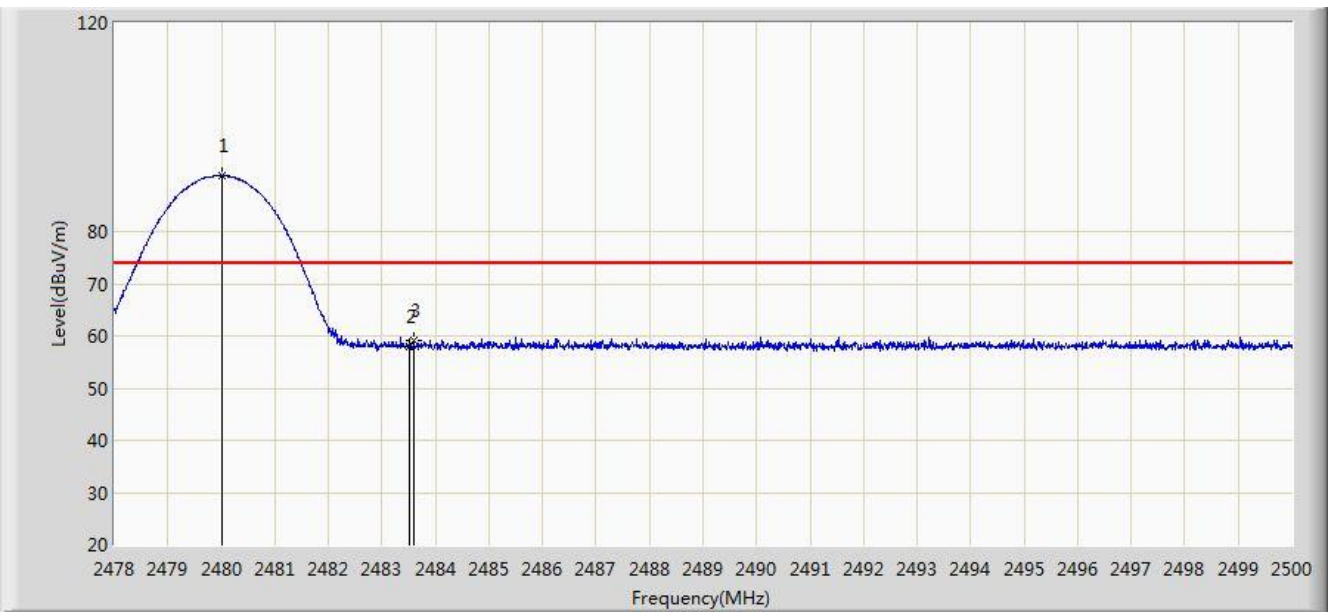

No	Flag	Mark	Frequency (MHz)	Measure Level (dBuV/m)	Reading Level (dBuV)	Over Limit (dB)	Limit (dBuV/m)	Factor (dB)	Type
1		*	2480.002	90.767	58.498	N/A	N/A	32.269	PK
2			2483.500	57.864	25.583	-16.136	74.000	32.282	PK
3			2483.599	59.208	26.926	-14.792	74.000	32.282	PK

Note: Measure Level (dB μ V/m) = Reading Level (dB μ V) + Factor (dB)

Factor (dB) = Cable Loss (dB) + Antenna Factor (dB/m)

Site: AC2	Time: 2016/08/16 - 20:31
Limit: FCC_Part15.209_RE(3m)	Engineer: Will Yan
Probe: BBHA9120D_1-18GHz	Polarity: Vertical
EUT: Solo Pro	Power: AC 120V/60Hz
Test Mode: Transmit by 3DH5 at Channel 2480MHz	

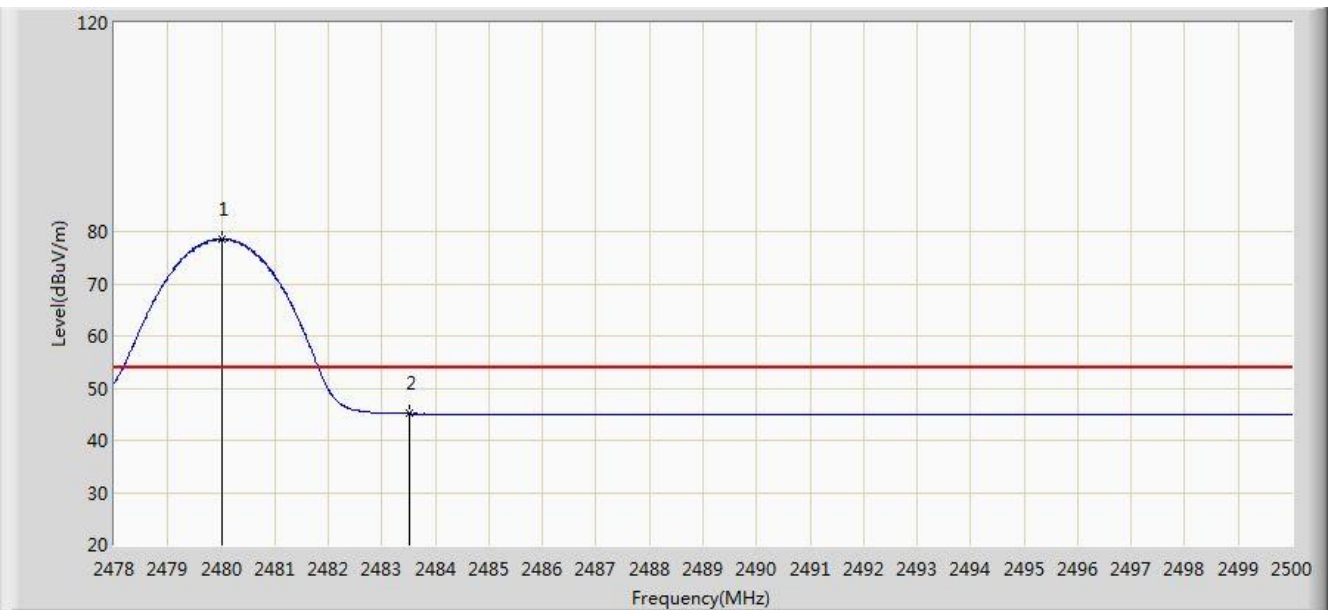

No	Flag	Mark	Frequency (MHz)	Measure Level (dBuV/m)	Reading Level (dBuV)	Over Limit (dB)	Limit (dBuV/m)	Factor (dB)	Type
1		*	2480.002	78.642	46.373	N/A	N/A	32.269	AV
2			2483.500	45.092	12.811	-8.908	54.000	32.282	AV

Note: Measure Level (dB μ V/m) = Reading Level (dB μ V) + Factor (dB)

Factor (dB) = Cable Loss (dB) + Antenna Factor (dB/m)

7.11. AC Conducted Emissions Measurement

7.11.1. Test Limit

FCC Part 15 Subpart C Paragraph 15.207 / RSS-Gen Limits		
Frequency (MHz)	QP (dB μ V)	Average (dB μ V)
0.15 - 0.50	66 - 56	56 - 46
0.50 - 5.0	56	46
5.0 - 30	60	50

Note 1: The lower limit shall apply at the transition frequencies.

Note 2: The limit decreases linearly with the logarithm of the frequency in the range 0.15MHz to 0.5MHz.

7.11.2. Test Setup

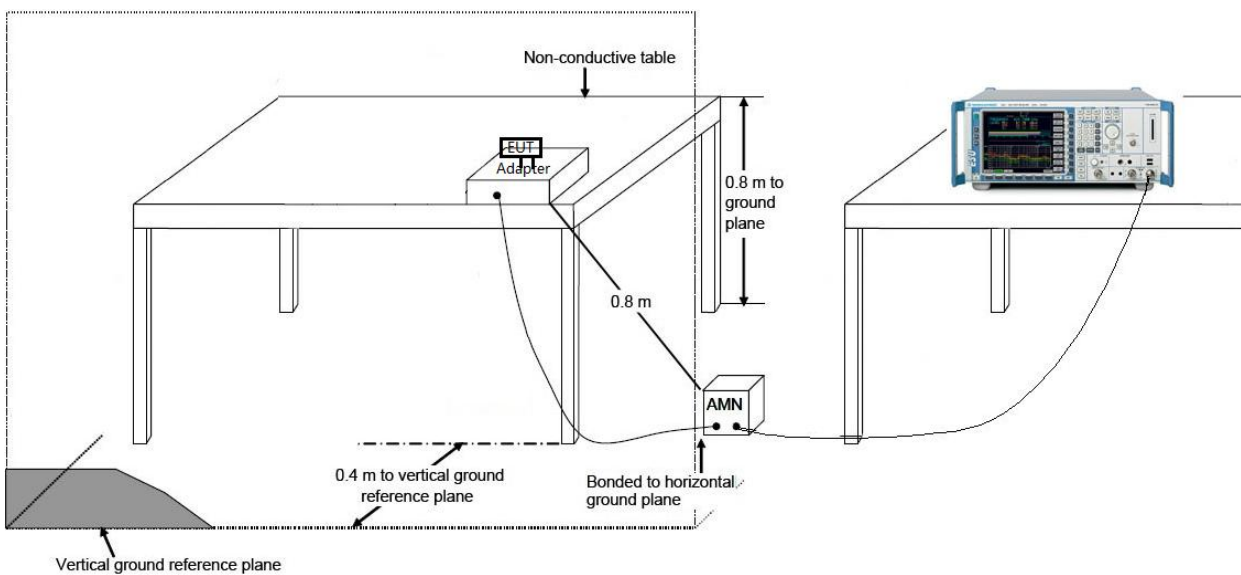

7.11.3. Test Result

Site: SR2	Time: 2016/08/20 - 18:45
Limit: FCC_Part15.207_CE_AC Power	Engineer: Vince Yu
Probe: ENV216_101683_Filter On	Polarity: Line
EUT: Solo Pro	Power: AC 120V/60Hz
Test Mode 1	

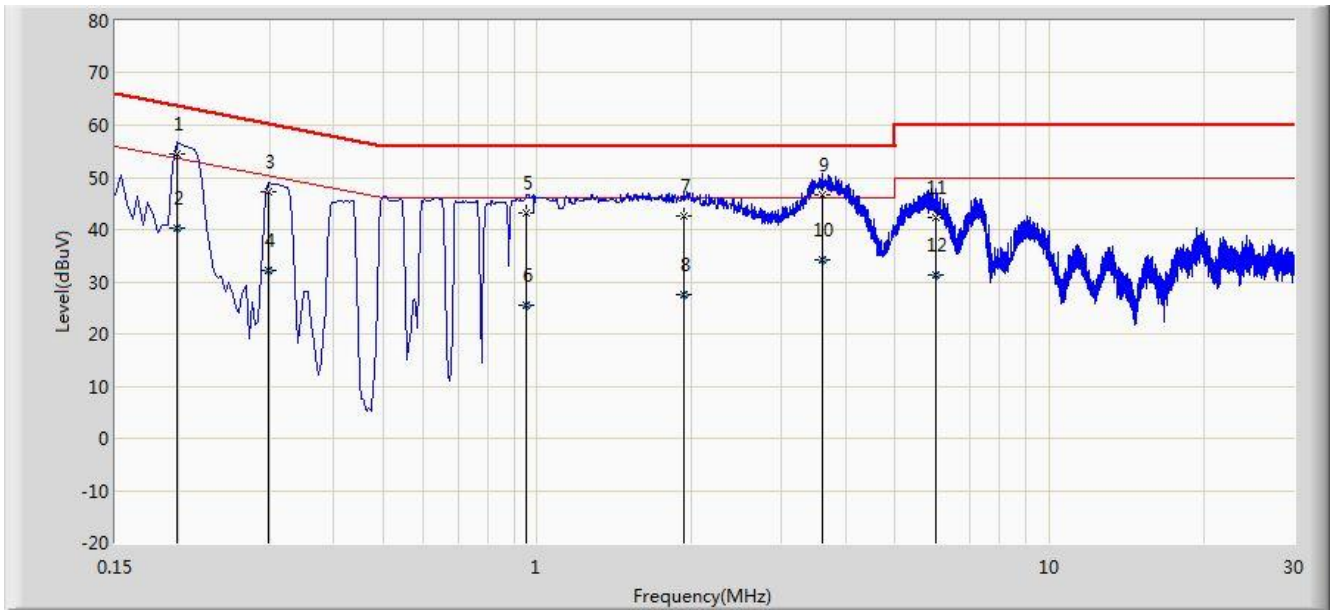

No	Flag	Mark	Frequency (MHz)	Measure Level (dBuV)	Reading Level (dBuV)	Over Limit (dB)	Limit (dBuV)	Factor (dB)	Type
1		*	0.198	54.490	44.485	-9.204	63.694	10.005	QP
2			0.198	40.257	30.253	-13.437	53.694	10.005	AV
3			0.298	47.107	37.104	-13.192	60.298	10.002	QP
4			0.298	32.063	22.061	-18.235	50.298	10.002	AV
5			0.954	43.106	33.174	-12.894	56.000	9.932	QP
6			0.954	25.639	15.707	-20.361	46.000	9.932	AV
7			1.930	42.664	32.790	-13.336	56.000	9.874	QP
8			1.930	27.674	17.800	-18.326	46.000	9.874	AV
9			3.602	46.567	36.649	-9.433	56.000	9.917	QP
10			3.602	34.110	24.192	-11.890	46.000	9.917	AV
11			6.002	42.254	32.132	-17.746	60.000	10.122	QP
12			6.002	31.368	21.246	-18.632	50.000	10.122	AV

Note: Measure Level (dBμV) = Reading Level (dBμV) + Factor (dB)

Factor (dB) = Cable Loss (dB) + LISN Factor (dB).

Site: SR2	Time: 2016/08/20 - 18:50
Limit: FCC_Part15.207_CE_AC Power	Engineer: Vince Yu
Probe: ENV216_101683_Filter On	Polarity: Neutral
EUT: Solo Pro	Power: AC 120V/60Hz
Test Mode 1	

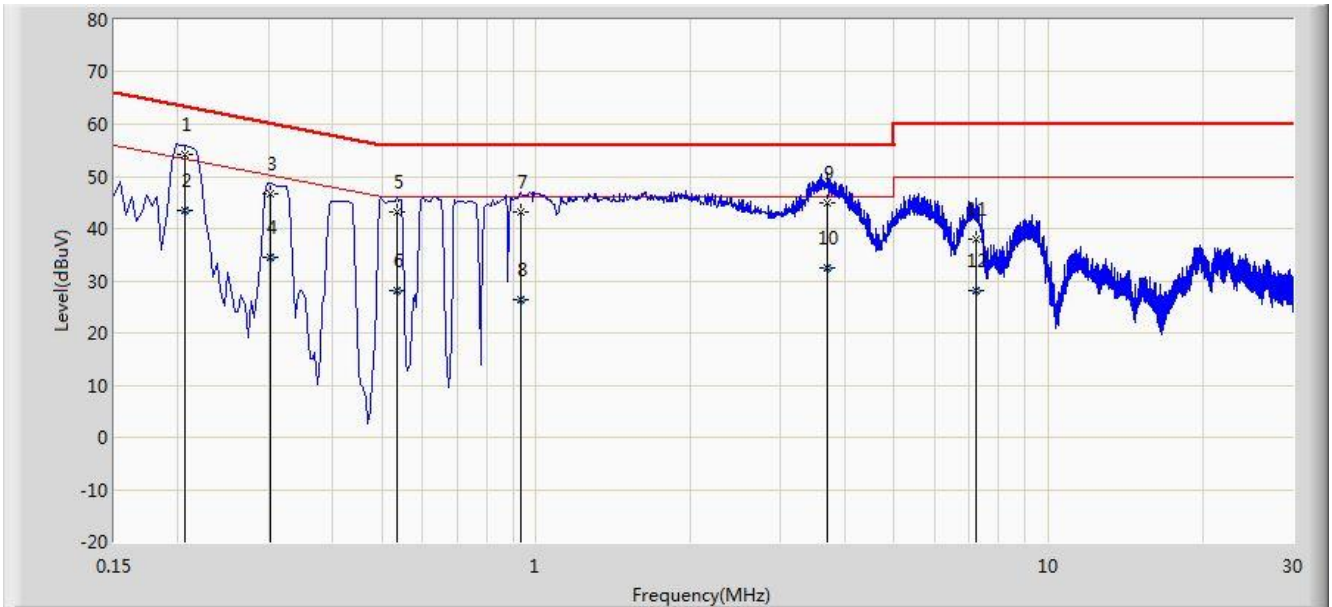

No	Flag	Mark	Frequency (MHz)	Measure Level (dBuV)	Reading Level (dBuV)	Over Limit (dB)	Limit (dBuV)	Factor (dB)	Type
1		*	0.206	54.086	44.084	-9.279	63.365	10.001	QP
2			0.206	43.357	33.356	-10.008	53.365	10.001	AV
3			0.302	46.771	36.731	-13.417	60.188	10.039	QP
4			0.302	34.458	24.419	-15.729	50.188	10.039	AV
5			0.534	43.132	32.965	-12.868	56.000	10.168	QP
6			0.534	28.189	18.021	-17.811	46.000	10.168	AV
7			0.934	43.187	33.241	-12.813	56.000	9.945	QP
8			0.934	26.465	16.519	-19.535	46.000	9.945	AV
9			3.710	44.999	35.047	-11.001	56.000	9.953	QP
10			3.710	32.472	22.519	-13.528	46.000	9.953	AV
11			7.218	38.048	27.872	-21.952	60.000	10.176	QP
12			7.218	28.009	17.833	-21.991	50.000	10.176	AV

Note: Measure Level (dBμV) = Reading Level (dBμV) + Factor (dB)

Factor (dB) = Cable Loss (dB) + LISN Factor (dB).

8. CONCLUSION

The data collected relate only the item(s) tested and show that the **Solo Pro FCC ID:**

2AGN8-P22N14 is in compliance with Part 15C of the FCC Rules.

————— The End —————