



# RF TEST REPORT

**Applicant** Sengled Co., Ltd.  
**FCC ID** 2AGN8-E21N11  
**Product** Sengled Smart LED  
**Brand** sengled  
**Model** E21-N11  
**Report No.** R2105A0392-R1V1  
**Issue Date** August 6, 2021

TA Technology (Shanghai) Co., Ltd. tested the above equipment in accordance with the requirements in **FCC CFR47 Part 15C (2020)**. The test results show that the equipment tested is capable of demonstrating compliance with the requirements as documented in this report.

Prepared by: Peng Tao

Approved by: Kai Xu

---

**TA Technology (Shanghai) Co., Ltd.**

No.145, Jintang Rd, Tangzhen Industry Park, Pudong Shanghai, China

TEL: +86-021-50791141/2/3

FAX: +86-021-50791141/2/3-8000



## TABLE OF CONTENT

1. Test Laboratory .....	5
1.1. Notes of the test report .....	5
1.2. Test facility .....	5
1.3. Testing Location.....	5
2. General Description of Equipment under Test .....	6
2.1. Applicant and Manufacturer Information .....	6
2.2. General information .....	6
3. Applied Standards.....	7
4. Test Configuration.....	8
5. Test Case Results.....	9
5.1. Maximum conducted output power.....	9
5.2. 6dB Bandwidth.....	13
5.3. Band Edge .....	17
5.4. Power Spectral Density .....	19
5.5. Spurious RF Conducted Emissions.....	22
5.6. Unwanted Emission .....	25
5.7. Conducted Emission.....	44
6. Main Test Instruments.....	47
ANNEX A: The EUT Appearance.....	48
ANNEX B: Test Setup Photos.....	49



Version	Revision description	Issue Date
Rev.0	Initial issue of report.	June 10, 2021
Rev.1	Update data in Page 10, Page 12, and Page 15. Delete channel 26.	August 6, 2021
Note: This revised report (Report No. R2105A0392-R1V1) supersedes and replaces the previously issued report (Report No. R2105A0392-R1). Please discard or destroy the previously issued report and dispose of it accordingly.		



## Summary of measurement results

Number	Test Case	Clause in FCC rules	Verdict
1	Maximum conducted output power	15.247(b)(3)	PASS
2	6 dB bandwidth	15.247(a)(2)	PASS
3	Maximum power spectral density	15.247(e)	PASS
4	Band Edge	15.247(d)	PASS
5	Spurious RF Conducted Emissions	15.247(d)	PASS
6	Unwanted Emissions	15.247(d),15.205,15.209	PASS
7	Conducted Emissions	15.207	PASS

Date of Testing: May 10, 2021 ~ May 27, 2021 And August 5, 2021

Date of Sample Received: May 7, 2021

Note: PASS: The EUT complies with the essential requirements in the standard.

FAIL: The EUT does not comply with the essential requirements in the standard.

All indications of Pass/Fail in this report are opinions expressed by TA Technology (Shanghai) Co., Ltd. based on interpretations and/or observations of test results. Measurement Uncertainties were not taken into account and are published for informational purposes only.



## 1. Test Laboratory

### 1.1. Notes of the test report

This report shall not be reproduced in full or partial, without the written approval of **TA technology (shanghai) co., Ltd.** The results documented in this report apply only to the tested sample, under the conditions and modes of operation as described herein. Measurement Uncertainties were not taken into account and are published for informational purposes only. This report is written to support regulatory compliance of the applicable standards stated above.

### 1.2. Test facility

#### **FCC (Designation number: CN1179, Test Firm Registration Number: 446626)**

TA Technology (Shanghai) Co., Ltd. has been listed on the US Federal Communications Commission list of test facilities recognized to perform electromagnetic emissions measurements.

#### **A2LA (Certificate Number: 3857.01)**

TA Technology (Shanghai) Co., Ltd. has been listed by American Association for Laboratory Accreditation to perform electromagnetic emission measurement.

### 1.3. Testing Location

Company: TA Technology (Shanghai) Co., Ltd.  
Address: No.145, Jintang Rd, Tangzhen Industry Park, Pudong  
City: Shanghai  
Post code: 201201  
Country: P. R. China  
Contact: Xu Kai  
Telephone: +86-021-50791141/2/3  
Fax: +86-021-50791141/2/3-8000  
Website: <http://www.ta-shanghai.com>  
E-mail: [xukai@ta-shanghai.com](mailto:xukai@ta-shanghai.com)

## 2. General Description of Equipment under Test

### 2.1. Applicant and Manufacturer Information

<b>Applicant</b>	Sengled Co., Ltd.
<b>Applicant address</b>	Room 103/02-B, Floor 1, Building 1, No.498, Guoshoujing Road, Pilot Free Trade Zone Shanghai ,P.R. China
<b>Manufacturer</b>	Sengled Co., Ltd.
<b>Manufacturer address</b>	Room 103/02-B, Floor 1, Building 1, No.498, Guoshoujing Road, Pilot Free Trade Zone Shanghai ,P.R. China

### 2.2. General information

EUT Description	
Model:	E21-N11
SN:	216D1000062
Hardware Version:	V1
Software Version:	V5
Power Supply:	AC adapter
Antenna Type:	PCB Antenna
Antenna Connector:	A permanently attached antenna (meet with the standard FCC Part 15.203 requirement)
Test Mode:	Zigbee
Modulation Type:	O-QPSK
Antenna Gain:	1 dBi
Max. Conducted Power	8.35 dBm
Operating Frequency Range(s)	2405 ~ 2475 MHz
Note: The EUT is sent from the applicant to TA and the information of the EUT is declared by the applicant.	



### **3. Applied Standards**

According to the specifications of the manufacturer, it must comply with the requirements of the following standards:

**Test standards:**

**FCC CFR47 Part 15C (2020) Radio Frequency Devices**

**ANSI C63.10 (2013)**

**Reference standard:**

**KDB 558074 D01 15.247 Meas Guidance v05r02**

## 4. Test Configuration

### Test Mode

The EUT was programmed to be in continuously transmitting mode and the transmit duty cycle is not less than 98%.

The EUT has been associated with peripherals and configuration operated in a manner tended to maximize its emission characteristics in a typical application.

The radiated emission was measured in the following position: EUT stand-up position (Z axis), lie-down position (X, Y axis). The worst emission was found in stand-up position (Z axis) and the worst case was recorded.

Mode	Channel	Frequency
Zigbee	11	2405MHz
	12	2410MHz
	13	2415MHz
	14	2420MHz
	15	2425MHz
	16	2430MHz
	17	2435MHz
	18	2440MHz
	19	2445MHz
	20	2450MHz
	21	2455MHz
	22	2460MHz
	23	2465MHz
	24	2470MHz
	25	2475MHz



## 5. Test Case Results

### 5.1. Maximum conducted output power

#### Ambient condition

Temperature	Relative humidity	Pressure
23°C ~25°C	45%~50%	101.5kPa

#### Methods of Measurement

During the process of the testing, The EUT was connected to Spectrum Analyzer with a known loss. The EUT is max power transmission with proper modulation. The Average detector is used. We use Maximum Average Conducted Output Power Level Method in KDB 558074 D01 for this test.

**ANSI C63.10 (2020)** Method AVGSA-I uses trace averaging with the Eut transmitting at full power throughout each sweep. The procedure for this method is as follows

- a) Set span to at least 1.5 times the OBW
- b) Set RBW=1% to 5% of the OBW, not to exceed 1 MHz
- c) Set  $vbw \geq [3 \times RBW]$
- d) Number of of points in sweep  $2[2 \times \text{span}/RBW]$ . (This gives bin-to-bin spacing  $s \text{ RBW} / 2$ , so that narrowband signals are not lost between frequency bins.)
- e) Sweep time=auto
- f) Detector=RMS (i.e, power averaging), if available. Otherwise, use sample detector mode
- g) If transmit duty cycle  $< 98\%$ , use a sweep trigger with the level set to enable triggering only on all power pulses. The transmitter shall operate at the maximum power control level for the entire duration of every sweep. If the Eut transmits continuously (i.e, with no OFF intervals) or at duty cycle  $\geq 98\%$ , and if each transmission is entirely at the maximum power control level, then the trigger shall be set to "free rn
- h) Trace average at least 100 traces in power averaging(rms )mode
- i) Compute power by integrating the spectrum across the OBW of the signal using the instrument's band power measurement function, with band limits set equal to the OBW band edges. If the instrument does not have a band power function, sum the spectrum levels (in power units) at intervals equal to the RBW extending across the entire OBW of the spectrum.

## Test Setup

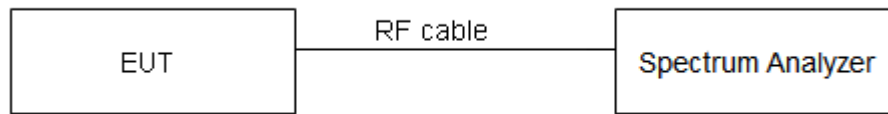

## Limits

Rule Part 15.247 (b) (3) specifies that " For systems using digital modulation in the 902–928 MHz, 2400–2483.5 MHz: 1 Watt."

Average Output Power	$\leq 1\text{W}$ (30dBm)
----------------------	--------------------------

## Measurement Uncertainty

The assessed measurement uncertainty to ensure 95% confidence level for the normal distribution is with the coverage factor  $k = 2$ ,  $U = 0.44$  dB.

**Test Results**

Band	T <sub>on</sub> (ms)	T <sub>(on+off)</sub> (ms)	Duty cycle	Duty cycle correction Factor(dB)
Zigbee	0.85	1.11	0.768	1.149

Note: when Duty cycle>0.98, Duty cycle correction Factor not required.

Network Standards	Carrier frequency (MHz)	Average Power Measured (dBm)	Average Power with duty factor (dBm)	Limit (dBm)	Conclusion
Zigbee	2405	6.98	8.13	30	PASS
	2425	6.99	8.14	30	PASS
	2440	7.20	8.35	30	PASS
	2445	6.91	8.06	30	PASS
	2450	7.07	8.22	30	PASS
	2475	6.85	8.00	30	PASS

Note: Average Power with duty factor = Average Power Measured +Duty cycle correction factor



Zigbee, Carrier frequency (MHz): 2405

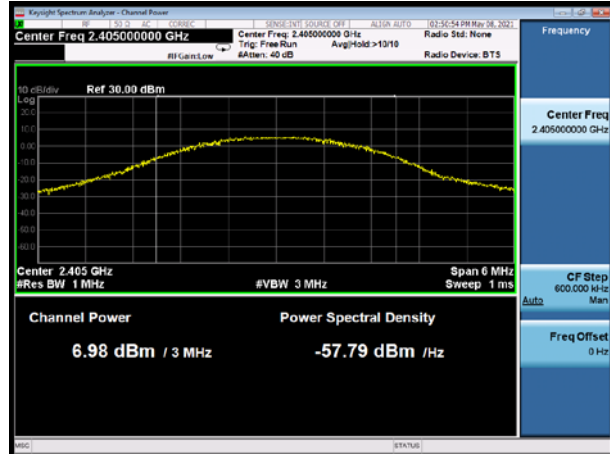

Zigbee, Carrier frequency (MHz): 2425

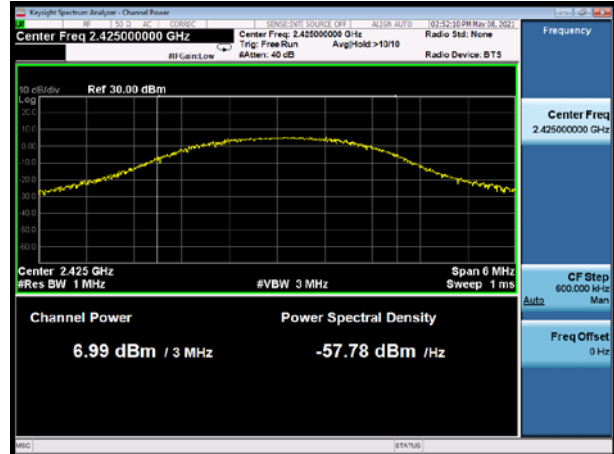

Zigbee, Carrier frequency (MHz): 2440

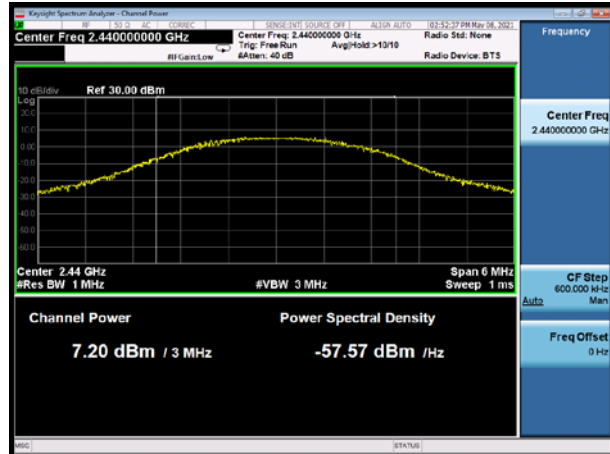

Zigbee, Carrier frequency (MHz): 2445

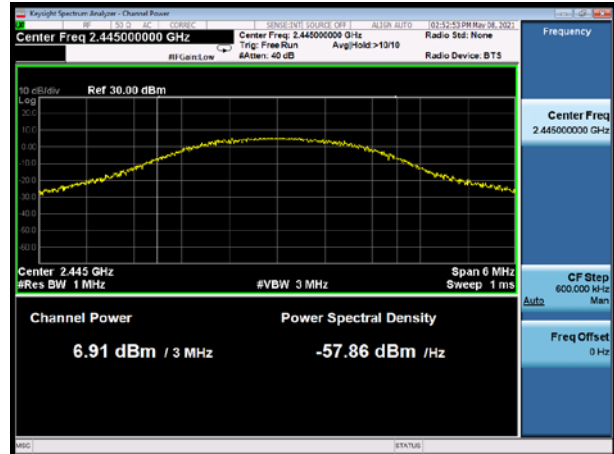

Zigbee, Carrier frequency (MHz): 2450

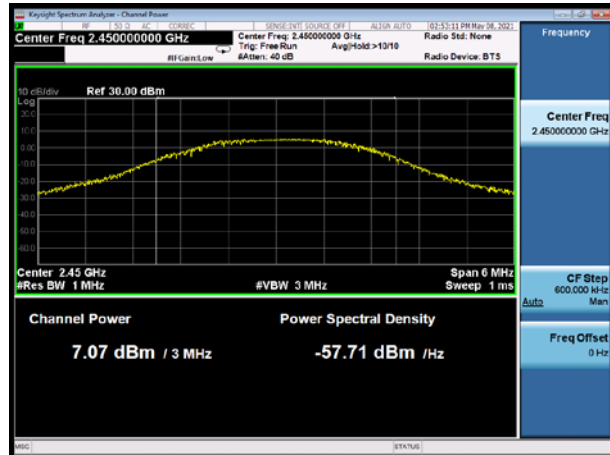

Zigbee, Carrier frequency (MHz): 2475

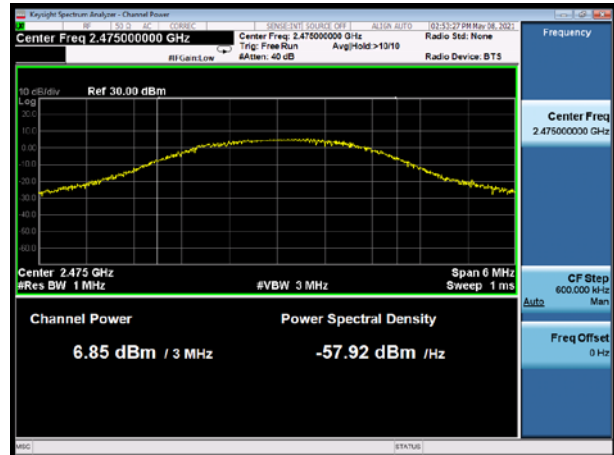

## 5.2. 6dB Bandwidth

### Ambient condition

Temperature	Relative humidity	Pressure
23°C ~25°C	45%~50%	101.5kPa

### Method of Measurement

The EUT was connected to the spectrum analyzer through an external attenuator (20dB) and a known loss cable. RBW is set to 100 kHz; VBW is set to 300 kHz on spectrum analyzer.

### Test Setup

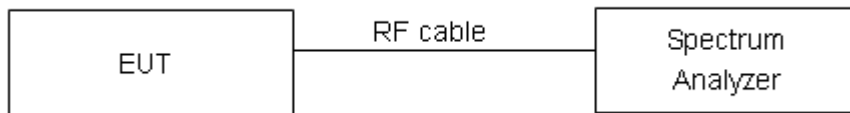

### Limits

Rule Part 15.247 (a) (2) specifies that “Systems using digital modulation techniques may operate in the 902–928 MHz, 2400–2483.5 MHz bands. The minimum 6 dB bandwidth shall be at least 500 kHz.”

minimum 6 dB bandwidth	≥ 500 kHz
------------------------	-----------

### Measurement Uncertainty

The assessed measurement uncertainty to ensure 95% confidence level for the normal distribution is with the coverage factor  $k = 2$ ,  $U = 936$  Hz.

**Test Results:**

Network Standards	Carrier frequency (MHz)	99% bandwidth (MHz)	Minimum 6 dB bandwidth (MHz)	Limit (kHz)	Conclusion
Zigbee	2405	2.3206	1.298	500	PASS
	2425	2.3306	1.198	500	PASS
	2440	2.3413	1.250	500	PASS
	2445	2.3158	1.227	500	PASS
	2450	2.3234	1.215	500	PASS
	2475	2.3222	1.190	500	PASS



99% bandwidth

Zigbee, Carrier frequency (MHz): 2405



Zigbee, Carrier frequency (MHz): 2425



Zigbee, Carrier frequency (MHz): 2440



Zigbee, Carrier frequency (MHz): 2445

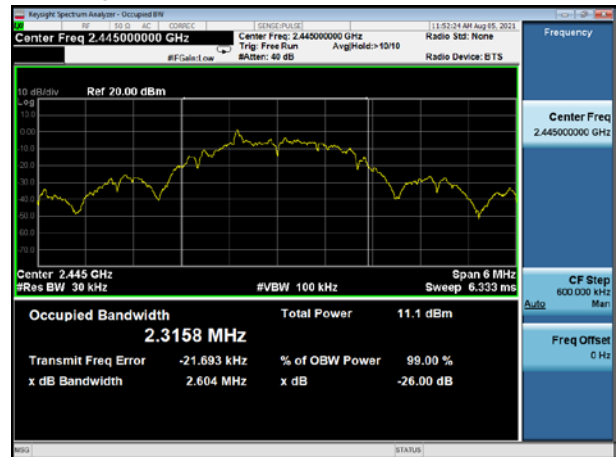

Zigbee, Carrier frequency (MHz): 2450

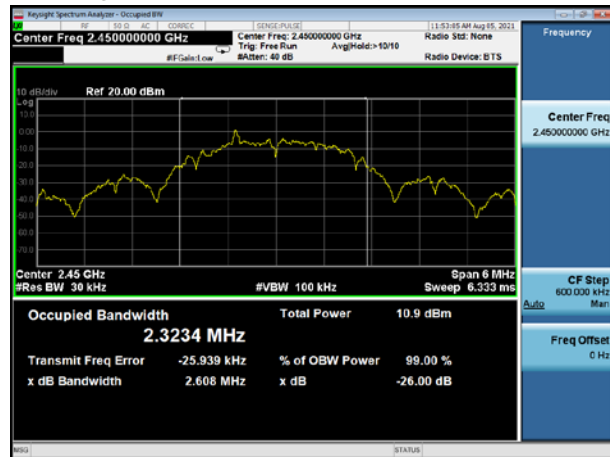

Zigbee, Carrier frequency (MHz): 2475





6 dB bandwidth

Zigbee, Carrier frequency (MHz): 2405

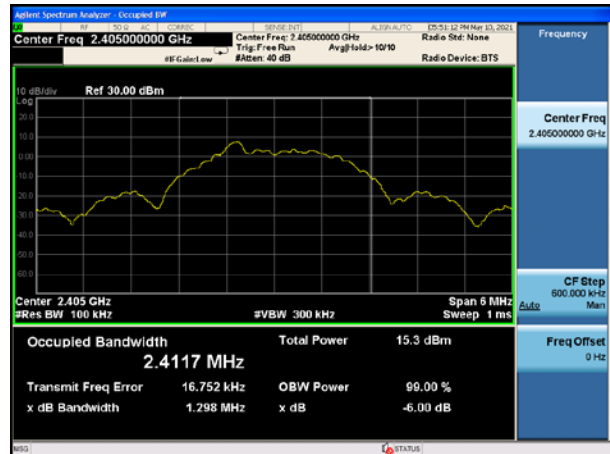

Zigbee, Carrier frequency (MHz): 2425

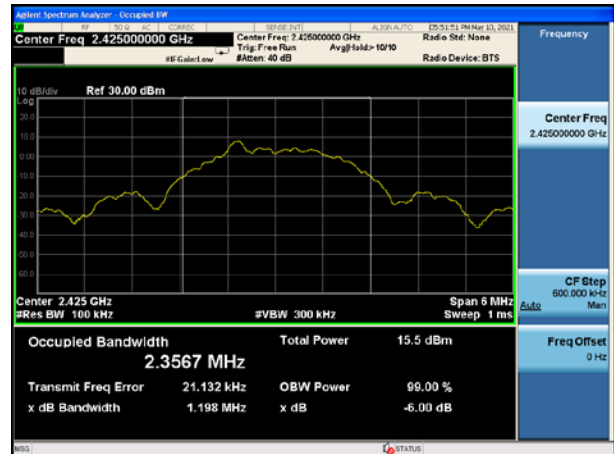

Zigbee, Carrier frequency (MHz): 2440

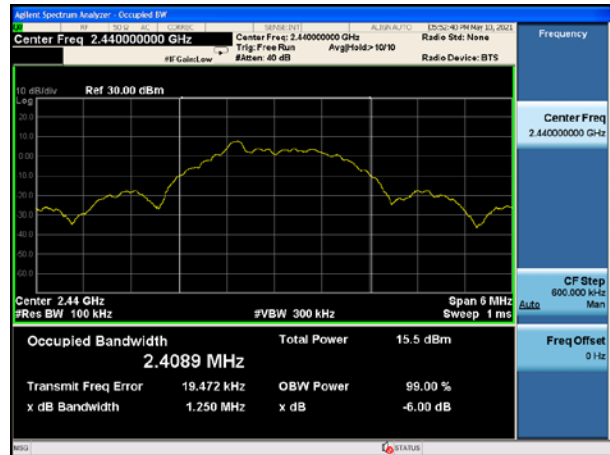

Zigbee, Carrier frequency (MHz): 2445

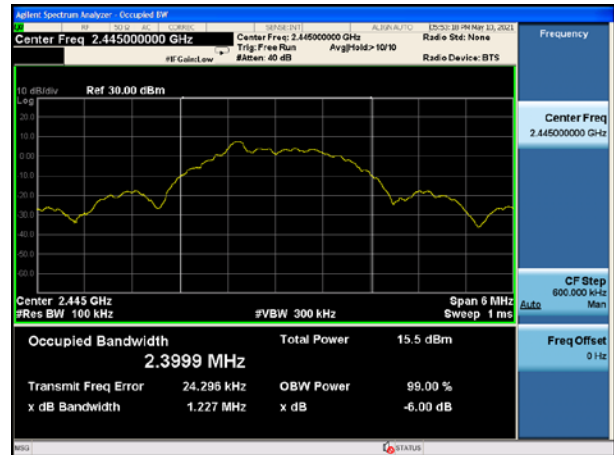

Zigbee, Carrier frequency (MHz): 2450

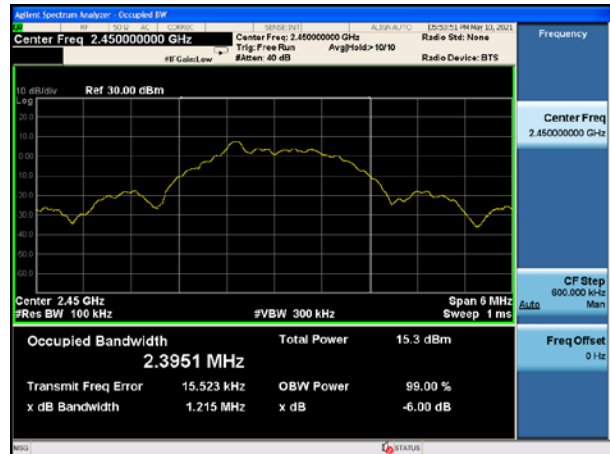

Zigbee, Carrier frequency (MHz): 2475

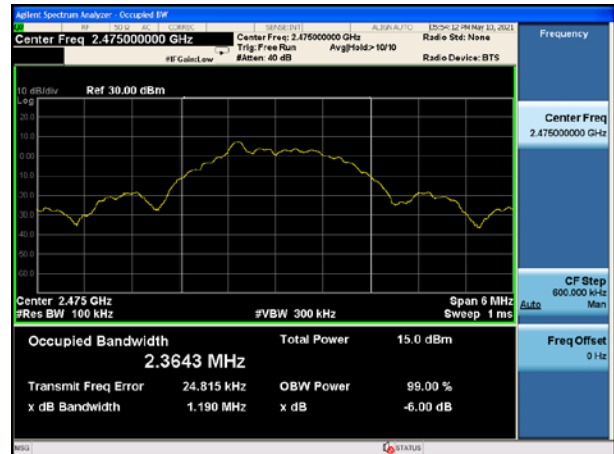



### 5.3. Band Edge

#### Ambient condition

Temperature	Relative humidity	Pressure
23°C ~25°C	45%~50%	101.5kPa

#### Method of Measurement

The EUT was connected to the spectrum analyzer through an external attenuator (20dB) and a known loss cable the band edge of the lowest and highest channels were measured. The peak detector is used and RBW is set to 100 kHz and VBW is set to 300 kHz on spectrum analyzer. Spectrum analyzer plots are included on the following pages.

#### Test Setup

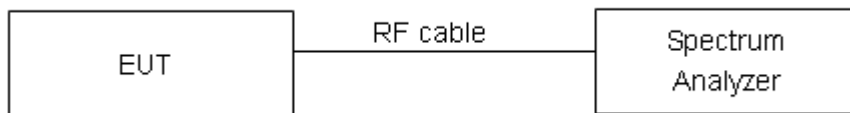

#### Limits

Rule Part 15.247(d) specifies that “In any 100 kHz bandwidth outside the frequency band in which the spread spectrum or digitally modulated intentional radiator is operating, the radio frequency power that is produced by the intentional radiator shall be at least 20 dB below that in the 100 kHz bandwidth within the band that contains the highest level of the desired power, based on either an RF conducted or a radiated measurement, provided the transmitter demonstrates compliance with the peak conducted power limits.” If the transmitter complies with the conducted power limits based on the use of RMS averaging over a time interval, as permitted under paragraph (b)(3) of this section, the attenuation required under this paragraph shall be 30 dB instead of 20 dB.”

#### Measurement Uncertainty

The assessed measurement uncertainty to ensure 95% confidence level for the normal distribution is with the coverage factor  $k = 1.96$ .

Frequency	Uncertainty
2GHz-3GHz	1.407 dB



Test Results: PASS

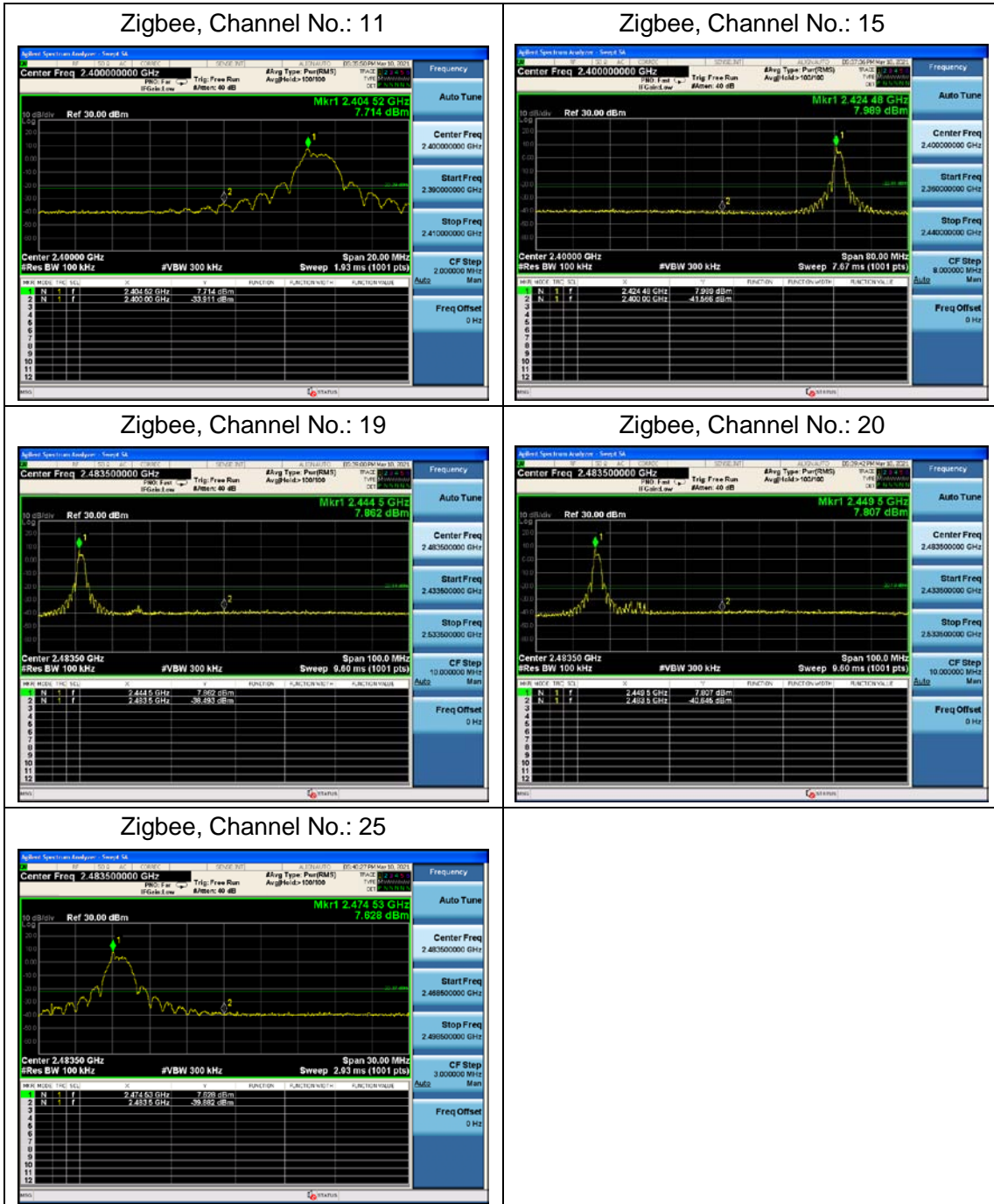

## 5.4. Power Spectral Density

### Ambient condition

Temperature	Relative humidity	Pressure
23°C ~25°C	45%~50%	101.5kPa

### Method of Measurement

The EUT was connected to the spectrum analyzer through an external attenuator (20dB) and a known loss cable.

RBW is set to 3 kHz and VBW is set to 10 kHz for Zigbee on spectrum analyzer.

Set the span to 1.5 times the DTS channel bandwidth. Sweep time = auto couple. Trace mode = max hold. The peak power spectral density is recorded.

### Test setup

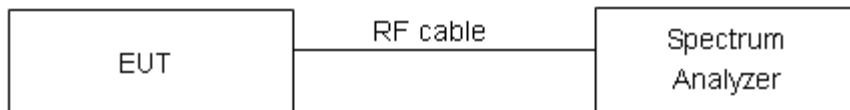

### Limits

Rule Part 15.247(e) specifies that " For digitally modulated systems, the power spectral density conducted from the intentional radiator to the antenna shall not be greater than 8 dBm in any 3 kHz band during any time interval of continuous transmission. "

Limits	$\leq 8 \text{ dBm} / 3\text{kHz}$
--------	------------------------------------

### Measurement Uncertainty

The assessed measurement uncertainty to ensure 95% confidence level for the normal distribution is with the coverage factor  $k = 2$ ,  $U = 0.75\text{dB}$ .

**Test Results:**

Network Standards	Channel Number	Read Value (dBm / 3kHz)	Power Spectral Density (dBm / 3kHz)	Limit (dBm / 3kHz)	Conclusion
Zigbee	11	-11.773	-10.62	8	PASS
	15	-11.914	-10.77	8	PASS
	18	-12.116	-10.97	8	PASS
	19	-11.502	-10.35	8	PASS
	20	-11.584	-10.44	8	PASS
	25	-11.221	-10.07	8	PASS

Note: Power Spectral Density =Read Value+Duty cycle correction factor



Zigbee, Channel No.: 11

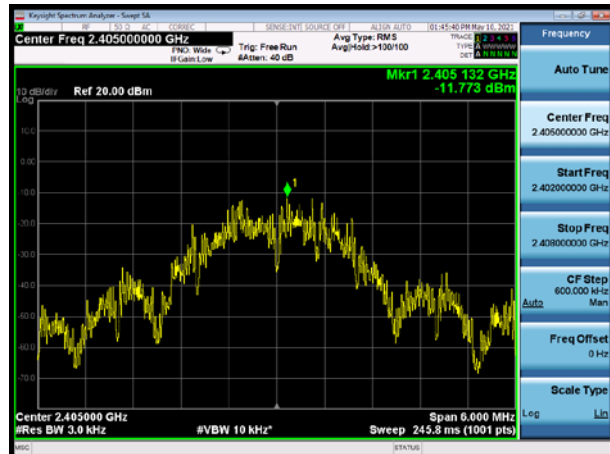

Zigbee, Channel No.: 15



Zigbee, Channel No.: 18



Zigbee, Channel No.: 19

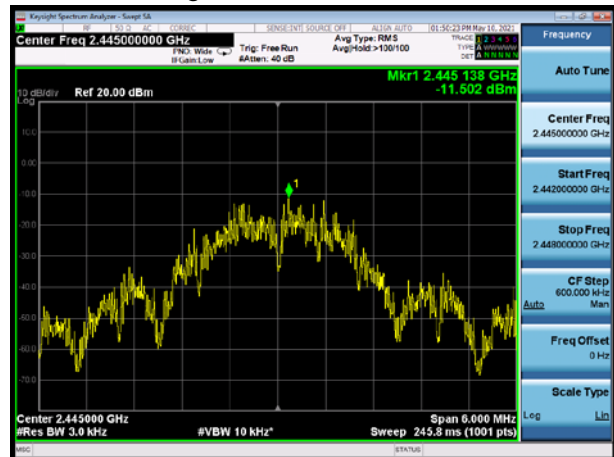

Zigbee, Channel No.: 20



Zigbee, Channel No.: 25



### 5.5. Spurious RF Conducted Emissions

#### Ambient condition

Temperature	Relative humidity	Pressure
23°C ~25°C	45%~50%	101.5kPa

#### Method of Measurement

The EUT was connected to the spectrum analyzer with a known loss. The spectrum analyzer scans from 30MHz to the 10th harmonic of the carrier. The peak detector is used. Set RBW to100kHz and VBW to 300 kHz, Sweep is set to ATUO.

The test is in transmitting mode.

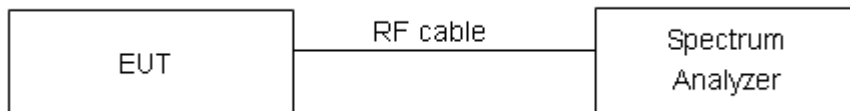

#### Limits

Rule Part 15.247(d) pacifies that “In any 100 kHz bandwidth outside the frequency band in which the spread spectrum or digitally modulated intentional radiator is operating, the radio frequency power that is produced by the intentional radiator shall be at least 20 dB below that in the 100 kHz bandwidth within the band that contains the highest level of the desired power, based on either an RF conducted or a radiated measurement, provided the transmitter demonstrates compliance with the peak conducted power limits. If the transmitter complies with the conducted power limits based on the use of RMS averaging over a time interval, as permitted under paragraph (b)(3) of this section, the attenuation required under this paragraph shall be 30 dB instead of 20 dB. ”

Network Standards	Carrier frequency (MHz)	Reference value (dBm)	Limit
Zigbee	2405	6.66	-23.34
	2425	7.36	-22.64
	2440	7.31	-22.69
	2445	6.22	-23.79
	2450	5.05	-24.95
	2475	7.39	-22.61

**Measurement Uncertainty**

The assessed measurement uncertainty to ensure 95% confidence level for the normal distribution is with the coverage factor  $k = 1.96$ .

Frequency	Uncertainty
100kHz-2GHz	0.684 dB
2GHz-26GHz	1.407 dB



**Test Results:**

The signal beyond the limit is carrier.

Zigbee CH11

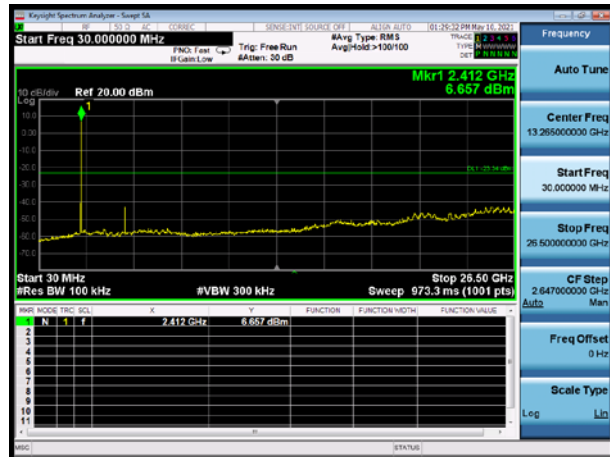

Zigbee CH15

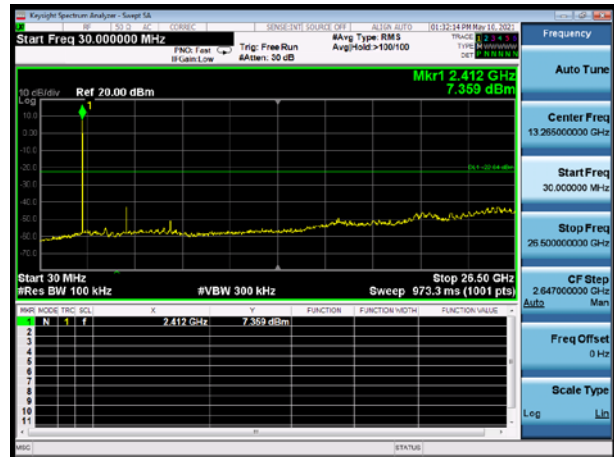

Zigbee CH18

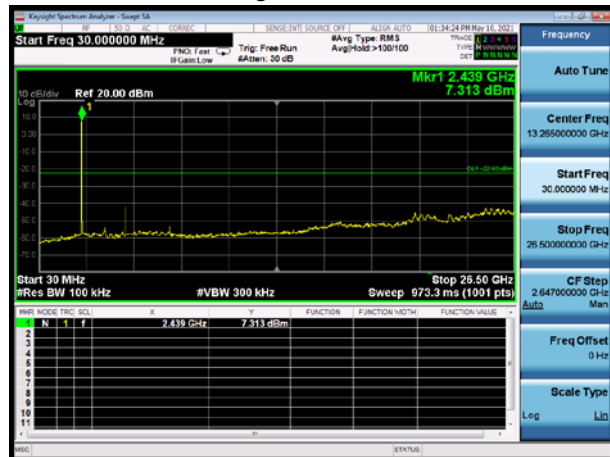

Zigbee CH19

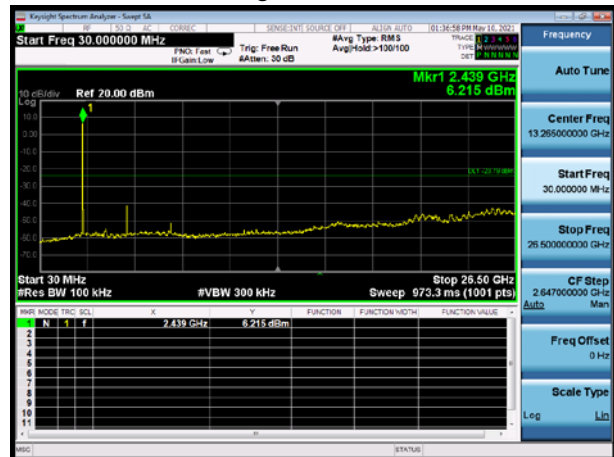

Zigbee CH20

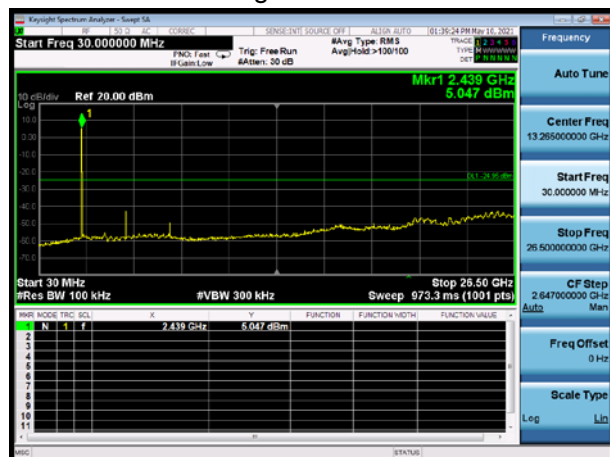

Zigbee CH25

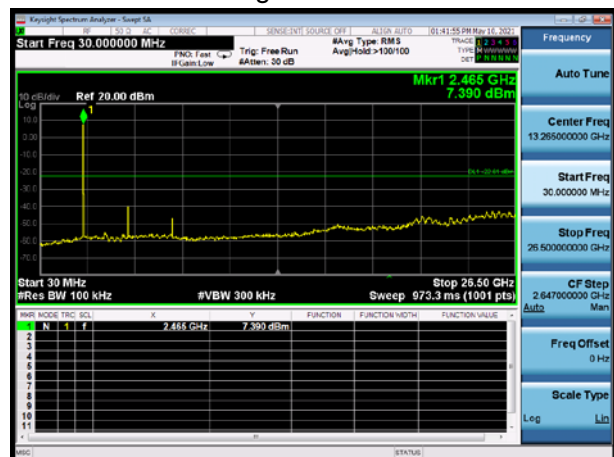



## 5.6. Unwanted Emission

### Ambient condition

Temperature	Relative humidity	Pressure
23°C ~25°C	45%~50%	102.5kPa

### Method of Measurement

The test set-up was made in accordance to the general provisions of ANSI C63.10-2020.

The Equipment Under Test (EUT) was set up on a non-conductive table in the semi-anechoic chamber. The test was performed at the distance of 3 m between the EUT and the receiving antenna.

The turntable shall be rotated from 0 to 360 degrees for detecting the maximum of radiated spurious signal level. The measurements shall be repeated with orthogonal polarization of the test antenna. The data of cable loss and antenna factor has been calibrated in full testing frequency range before the testing. Sweep the Restricted Band and the emissions less than 20 dB below the permissible value are reported.

The radiated emissions measurements were made in a typical installation configuration.

Sweep the whole frequency band through the range from 9 kHz to the 10th harmonic of the carrier, and the emissions less than 20 dB below the permissible value are reported.

This method refer to ANSI C63.10-2020.

The procedure for peak unwanted emissions measurements above 1000 MHz is as follows:

I) Peak emission levels are measured by setting the instrument as follows:

- 1) RBW = 1 MHz.
- 2) VBW  $\geq$  [3  $\times$  RBW]
- 3) Detector = peak.
- 4) Sweep time = auto.
- 5) Trace mode = max hold.
- 6) Allow sweeps to continue until the trace stabilizes. Note that if the transmission is not continuous, then the time required for the trace to stabilize will increase by a factor of approximately 1 / D, where D is the duty cycle.

II) Average emission levels are measured by setting the instrument as follows:

- a) RBW = 1 MHz.
- b) VBW  $\geq$  [3  $\times$  RBW].
- c) Detector = RMS (power averaging), if [span / (# of points in sweep)]  $\leq$  RBW / 2. Satisfying this condition can require increasing the number of points in the sweep or reducing the span. If the condition is not satisfied, then the detector mode shall be set to peak.
- d) Averaging type = power (i.e., rms) (As an alternative, the detector and averaging type may be set for linear voltage averaging. Some instruments require linear display mode to use linear voltage averaging. Log or dB averaging shall not be used.)



- e) Sweep time = auto.
- f) Perform a trace average of at least 100 traces if the transmission is continuous. If the transmission is not continuous, then the number of traces shall be increased by a factor of  $1 / D$ , where  $D$  is the duty cycle. For example, with 50% duty cycle, at least 200 traces shall be averaged. (If a specific emission is demonstrated to be continuous—i.e., 100% duty cycle—then rather than turning ON and OFF with the transmit cycle, at least 100 traces shall be averaged.)
- g) If tests are performed with the EUT transmitting at a duty cycle less than 98%, then a correction factor shall be added to the measurement results prior to comparing with the emission limit, to compute the emission level that would have been measured had the test been performed at 100% duty cycle. The correction factor is computed as follows:
- 1) If power averaging (rms) mode was used in the preceding step e), then the correction factor is  $[10 \log (1 / D)]$ , where  $D$  is the duty cycle. For example, if the transmit duty cycle was 50%, then 3 dB shall be added to the measured emission levels.
  - 2) If linear voltage averaging mode was used in the preceding step e), then the correction factor is  $[20 \log (1 / D)]$ , where  $D$  is the duty cycle. For example, if the transmit duty cycle was 50%, then 6 dB shall be added to the measured emission levels.
  - 3) If a specific emission is demonstrated to be continuous (100% duty cycle) rather than turning ON and OFF with the transmit cycle, then no duty cycle correction is required for that emission.

The test is in transmitting mode.

**Test setup**

**9KHz ~ 30MHz**

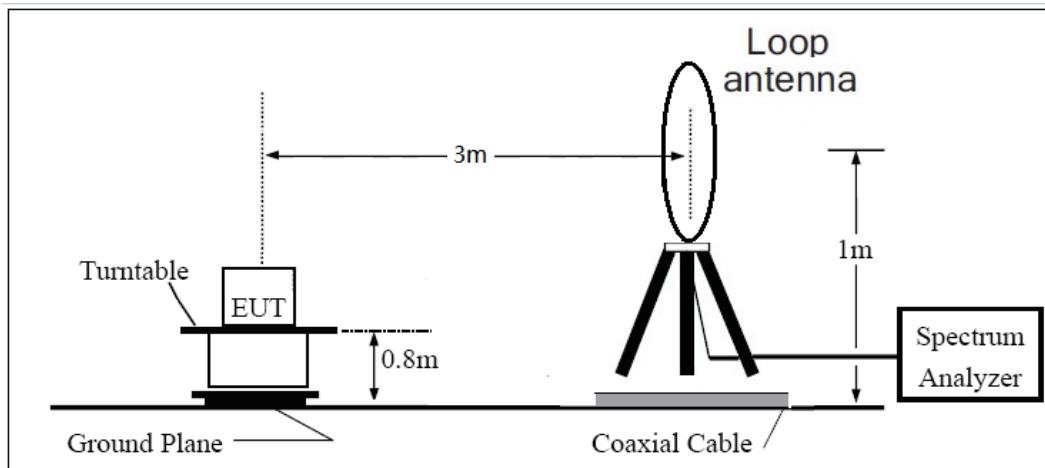

**30MHz ~ 1GHz**

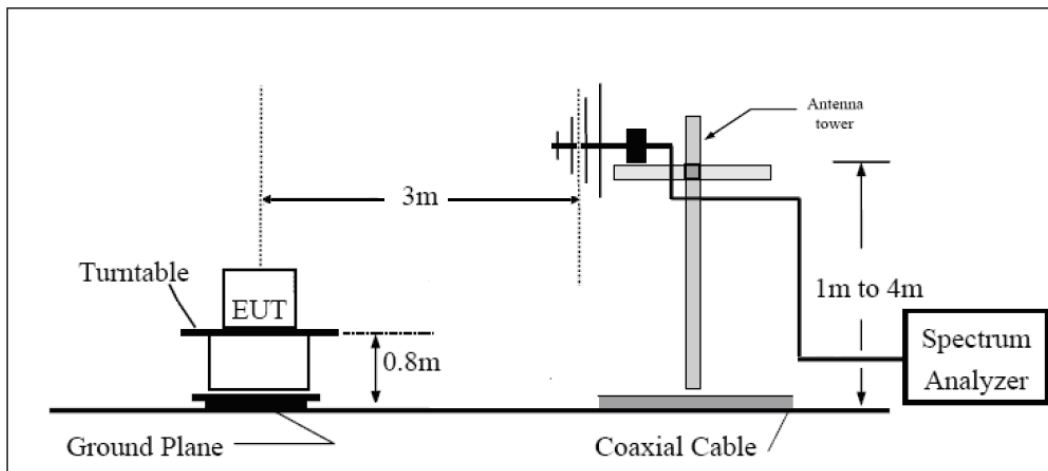

**Above 1GHz**

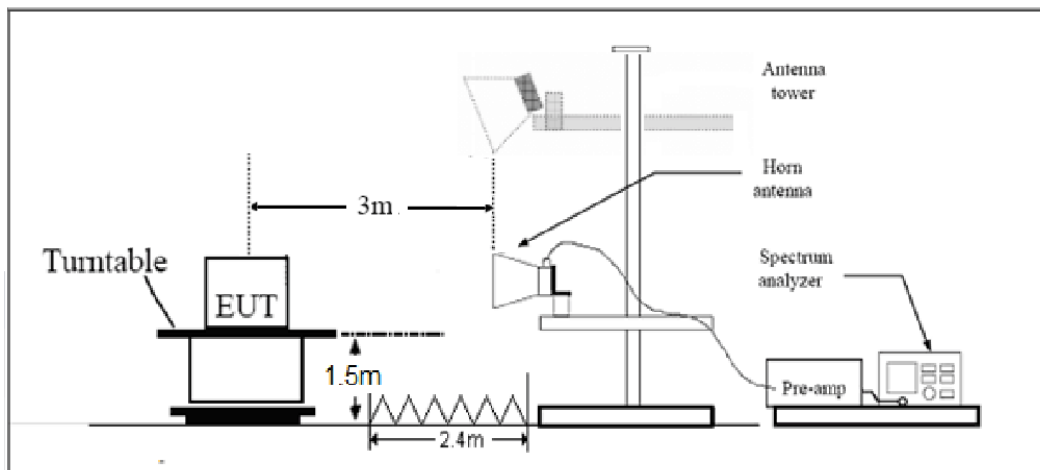

Note: Area side:2.4mX3.6m

**Limits**

Rule Part 15.247(d) specifies that "In addition, radiated emissions which fall in the restricted bands, as defined in § 15.205(a), must also comply with the radiated emission limits specified in § 15.209(a) (see § 15.205(c))."

Limit in restricted band

Frequency of emission (MHz)	Field strength(uV/m)	Field strength(dBuV/m)
0.009–0.490	2400/F(kHz)	/
0.490–1.705	24000/F(kHz)	/
1.705–30.0	30	/
30-88	100	40
88-216	150	43.5
216-960	200	46
Above960	500	54

## §15.35(b)

There is also a limit on the radio frequency emissions, as measured using instrumentation with a peak detector function, corresponding to 20 dB above the maximum permitted average limit.

Peak Limit=74 dBuV/m

Average Limit=54 dBuV/m

Spurious Radiated Emissions are permitted in any of the frequency bands listed below:

MHz	MHz	MHz	GHz
0.090 - 0.110	16.42 - 16.423	399.9 - 410	4.5 - 5.15
<sup>1</sup> 0.495 - 0.505	16.69475 - 16.69525	608 - 614	5.35 - 5.46
2.1735 - 2.1905	16.80425 - 16.80475	960 - 1240	7.25 - 7.75
4.125 - 4.128	25.5 - 25.67	1300 - 1427	8.025 - 8.5
4.17725 - 4.17775	37.5 - 38.25	1435 - 1626.5	9.0 - 9.2
4.20725 - 4.20775	73 - 74.6	1645.5 - 1646.5	9.3 - 9.5
6.215 - 6.218	74.8 - 75.2	1660 - 1710	10.6 - 12.7
6.26775 - 6.26825	108 - 121.94	1718.8 - 1722.2	13.25 - 13.4
6.31175 - 6.31225	123 - 138	2200 - 2300	14.47 - 14.5
8.291 - 8.294	149.9 - 150.05	2310 - 2390	15.35 - 16.2
8.362 - 8.366	156.52475 - 156.52525	2483.5 - 2500	17.7 - 21.4
8.37625 - 8.38675	156.7 - 156.9	2690 - 2900	22.01 - 23.12
8.41425 - 8.41475	162.0125 - 167.17	3260 - 3267	23.6 - 24.0
12.29 - 12.293	167.72 - 173.2	3332 - 3339	31.2 - 31.8
12.51975 - 12.52025	240 - 285	3345.8 - 3358	36.43 - 36.5
12.57675 - 12.57725	322 - 335.4	3600 - 4400	( <sup>2</sup> )
13.36 - 13.41			

### Measurement Uncertainty

The assessed measurement uncertainty to ensure 95% confidence level for the normal distribution is with the coverage factor  $k = 1.96$ .

Frequency	Uncertainty
9KHz-30MHz	3.55 dB
30MHz-200MHz	4.02 dB
200MHz-1GHz	3.28 dB
1-18GHz	3.70 dB
18-26.5GHz	5.78 dB

**Test result**

The signal beyond the limit is carrier.

Zigbee-Channel 11: Peak + Average

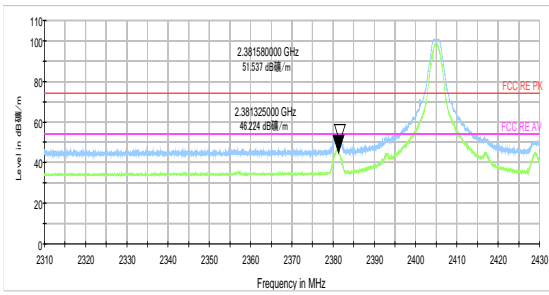

Zigbee-Channel 15: Peak + Average

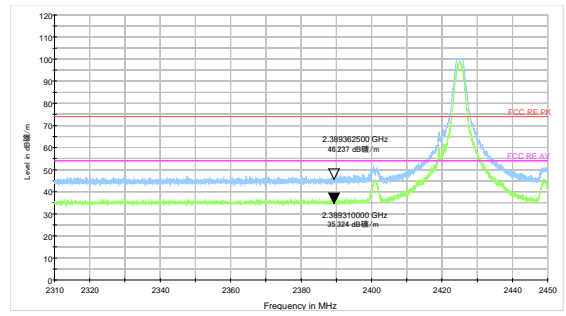

Zigbee-Channel 25: Peak + Average

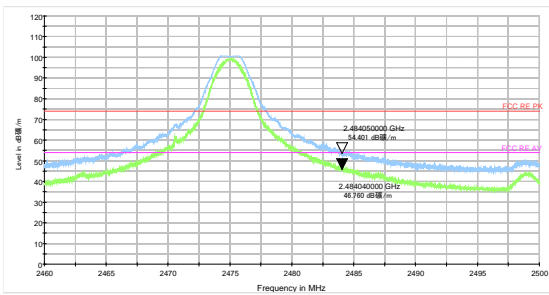

/

**Result of RE**

Sweep the whole frequency band through the range from 9kHz to the 10th harmonic of the carrier, the Emissions in the frequency band 9kHz-30MHz and 18GHz-26.5GHz are more than 20dB below the limit are not reported.

The following graphs display the maximum values of horizontal and vertical by software. For above 1GHz, Blue trace uses the peak detection, Green trace uses the average detection.

During the test, the Radiates Emission from 30MHz to 1GHz was performed in all modes with all channels, Zigbee, Channel 11 are selected as the worst condition. The test data of the worst-case condition was recorded in this report.

A font ( Level in dB $\mu$ V/ )in the test plot =(level in dB  $\mu$  V/m)

**Continuous TX mode:**

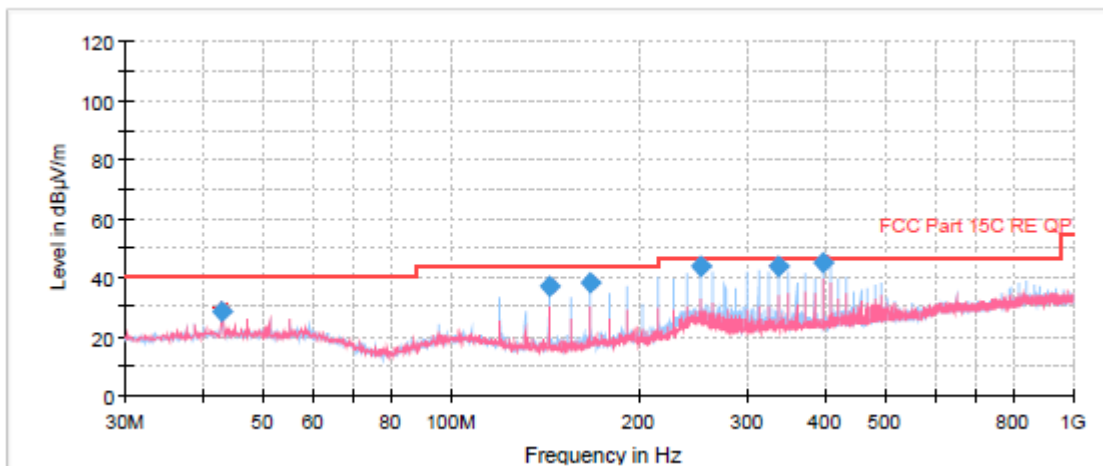

Radiates Emission from 30MHz to 1GHz

Frequency (MHz)	Quasi-Peak (dBuV/m)	Height (cm)	Polarization	Azimuth (deg)	Correct Factor (dB)	Margin (dB)	Limit (dBuV/m)
43.013750	28.39	180.0	V	251.0	14.1	11.61	40.00
144.015000	37.22	175.0	H	181.0	9.0	6.28	43.50
168.022500	38.06	225.0	H	0.0	10.0	5.44	43.50
252.008750	43.58	100.0	H	336.0	13.8	2.42	46.00
336.035000	43.92	100.0	H	198.0	16.1	2.08	46.00
396.053750	45.05	100.0	H	335.0	17.5	0.95	46.00

## Zigbee CH11

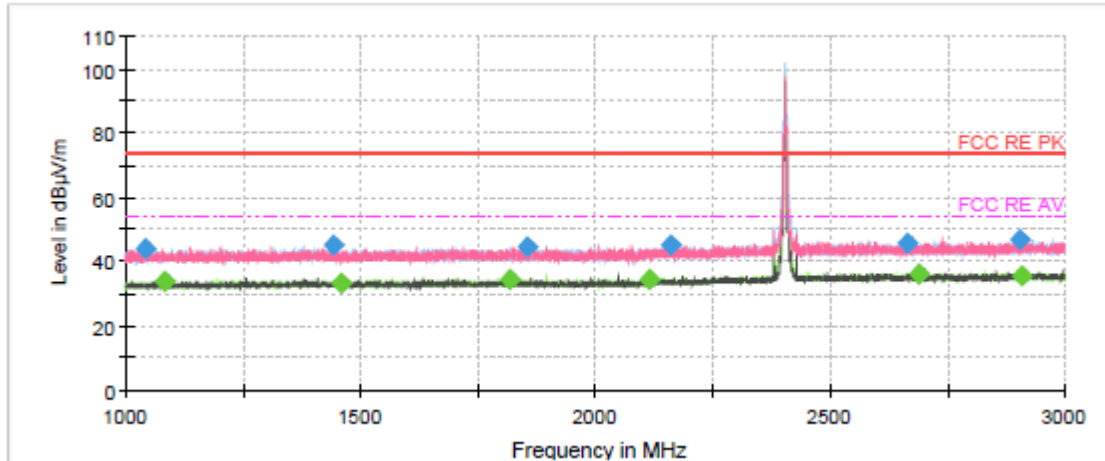

Note: The signal beyond the limit is carrier.  
Radiates Emission from 1GHz to 3GHz

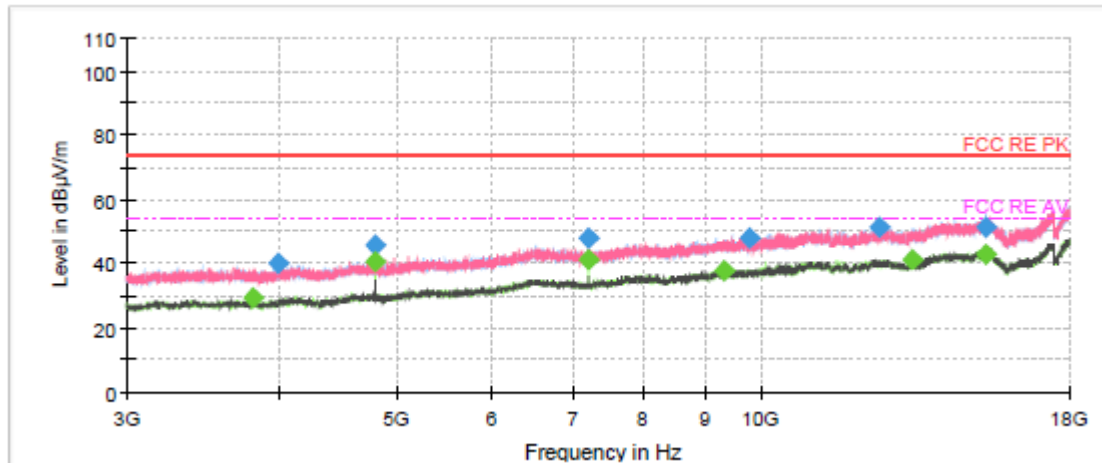

Radiates Emission from 3GHz to 18GHz





Frequency (MHz)	MaxPeak (dB $\mu$ V/m)	Average (dB $\mu$ V/m)	Limit (dB $\mu$ V/m)	Margin (dB)	Height (cm)	Pol	Azimuth (deg)	Corr. (dB/m)
1039.800000	44.16	---	74.00	29.84	100.0	V	80.0	-11.0
1080.800000	---	33.57	54.00	20.43	100.0	H	40.0	-10.7
1443.800000	45.14	---	74.00	28.86	100.0	V	28.0	-9.3
1458.000000	---	33.46	54.00	20.54	100.0	H	275.0	-9.4
1816.600000	---	34.64	54.00	19.36	200.0	H	0.0	-8.5
1855.866667	44.55	---	74.00	29.45	200.0	V	354.0	-8.4
2115.866667	---	34.41	54.00	19.59	200.0	H	93.0	-7.5
2159.133333	45.14	---	74.00	28.86	100.0	V	196.0	-7.5
2667.333333	45.60	---	74.00	28.40	200.0	V	358.0	-6.0
2690.333333	---	36.03	54.00	17.97	100.0	H	344.0	-6.1
2904.466667	46.64	---	74.00	27.36	100.0	V	106.0	-6.1
2910.933333	---	35.47	54.00	18.53	200.0	H	267.0	-6.1

**Remark: 1. Correction Factor = Antenna factor + Insertion loss (cable loss + amplifier gain)**

**2. Margin = Limit – Quasi-Peak**

Zigbee CH15

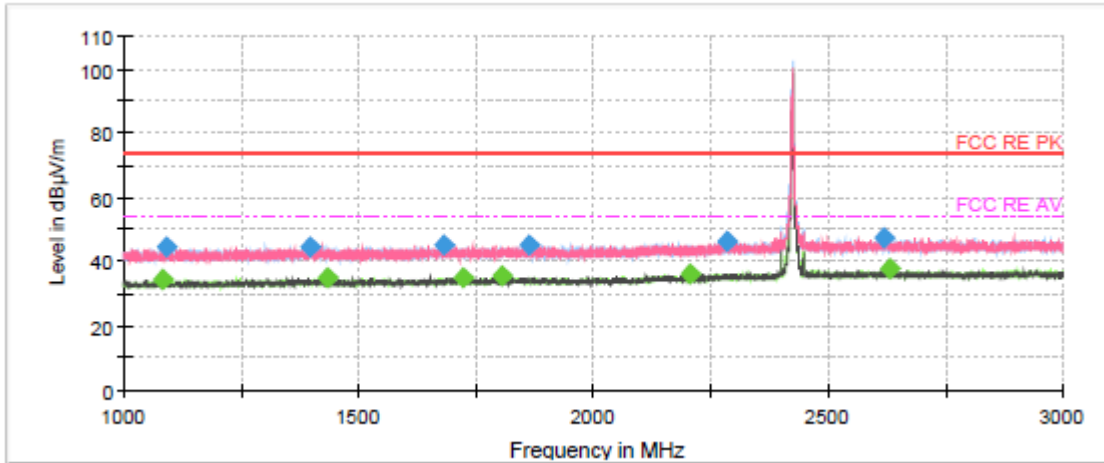

Note: The signal beyond the limit is carrier.  
Radiates Emission from 1GHz to 3GHz

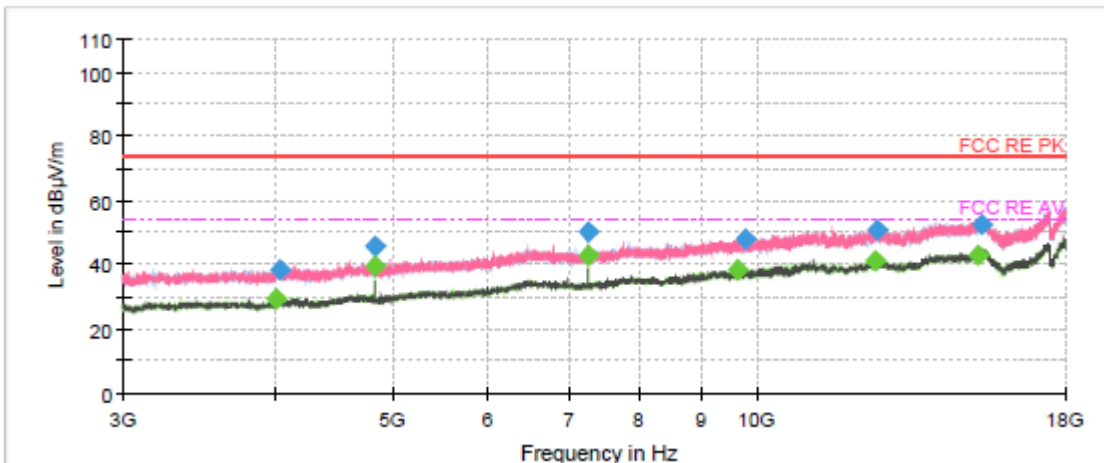

Radiates Emission from 3GHz to 18GHz



Frequency (MHz)	MaxPeak (dB $\mu$ V/m)	Average (dB $\mu$ V/m)	Limit (dB $\mu$ V/m)	Margin (dB)	Height (cm)	Pol	Azimuth (deg)	Corr. (dB/m)
1082.066667	---	34.38	54.00	19.62	100.0	H	1.0	-10.7
1091.000000	44.37	---	74.00	29.63	200.0	H	137.0	-10.7
1395.800000	44.79	---	74.00	29.21	200.0	H	266.0	-9.6
1435.866667	---	34.97	54.00	19.03	100.0	H	80.0	-9.3
1680.800000	45.39	---	74.00	28.61	100.0	H	0.0	-8.7
1723.666667	---	35.11	54.00	18.89	200.0	V	0.0	-8.6
1806.600000	---	35.77	54.00	18.23	100.0	H	304.0	-8.5
1862.600000	45.16	---	74.00	28.84	200.0	V	11.0	-8.4
2206.266667	---	35.88	54.00	18.12	200.0	V	355.0	-7.3
2283.200000	46.05	---	74.00	27.95	200.0	V	151.0	-7.0
2618.333333	47.18	---	74.00	26.82	100.0	H	217.0	-6.1
2631.400000	---	37.62	54.00	16.38	200.0	H	0.0	-6.1

**Remark: 1. Correction Factor = Antenna factor + Insertion loss (cable loss + amplifier gain)**

**2. Margin = Limit – Quasi-Peak**

## Zigbee CH18

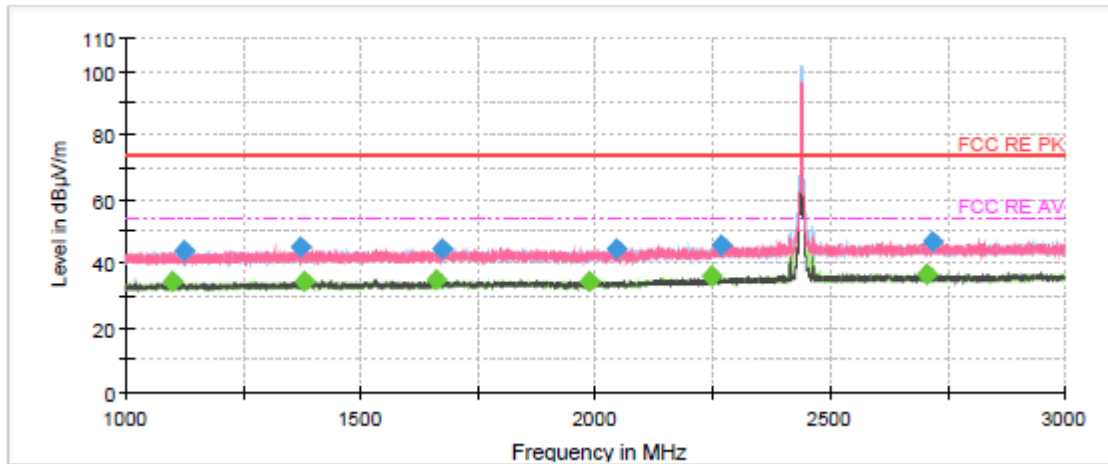

Note: The signal beyond the limit is carrier.  
Radiates Emission from 1GHz to 3GHz

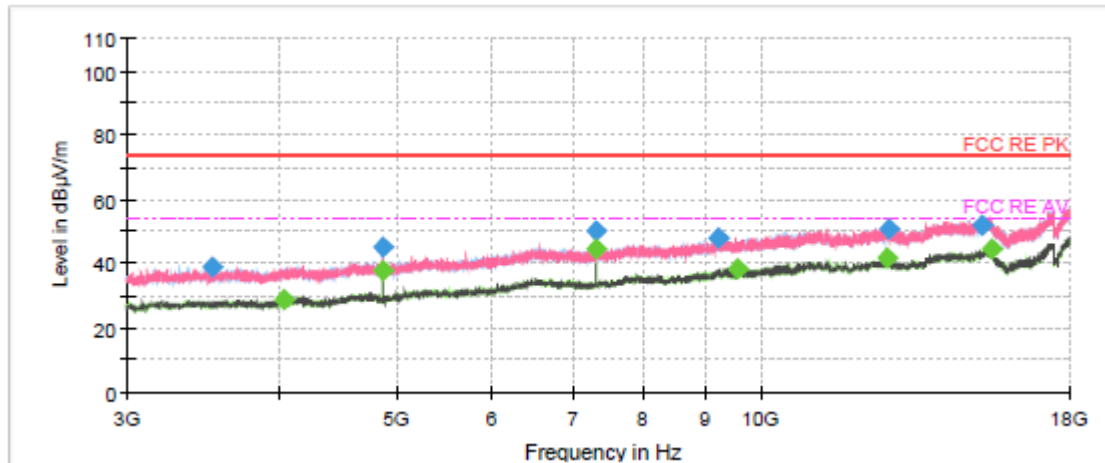

Radiates Emission from 3GHz to 18GHz



Frequency (MHz)	MaxPeak (dB $\mu$ V/m)	Average (dB $\mu$ V/m)	Limit (dB $\mu$ V/m)	Margin (dB)	Height (cm)	Pol	Azimuth (deg)	Corr. (dB/m)
1098.666667	---	34.16	54.00	19.84	200.0	V	358.0	-10.6
1124.466667	43.82	---	74.00	30.18	200.0	V	2.0	-10.6
1372.000000	45.26	---	74.00	28.74	100.0	V	241.0	-9.6
1379.533333	---	34.59	54.00	19.41	100.0	V	163.0	-9.6
1661.200000	---	34.70	54.00	19.30	200.0	V	358.0	-8.8
1672.266667	44.41	---	74.00	29.59	100.0	V	304.0	-8.8
1988.533333	---	34.38	54.00	19.62	100.0	H	5.0	-8.2
2047.000000	44.57	---	74.00	29.43	100.0	V	241.0	-8.0
2249.133333	---	35.95	54.00	18.05	200.0	V	42.0	-7.1
2268.400000	45.61	---	74.00	28.39	100.0	V	357.0	-7.0
2705.000000	---	36.58	54.00	17.42	200.0	V	292.0	-6.1
2718.466667	46.90	---	74.00	27.10	100.0	V	150.0	-6.1

**Remark: 1. Correction Factor = Antenna factor + Insertion loss (cable loss + amplifier gain)**

**2. Margin = Limit – Quasi-Peak**

Zigbee CH19

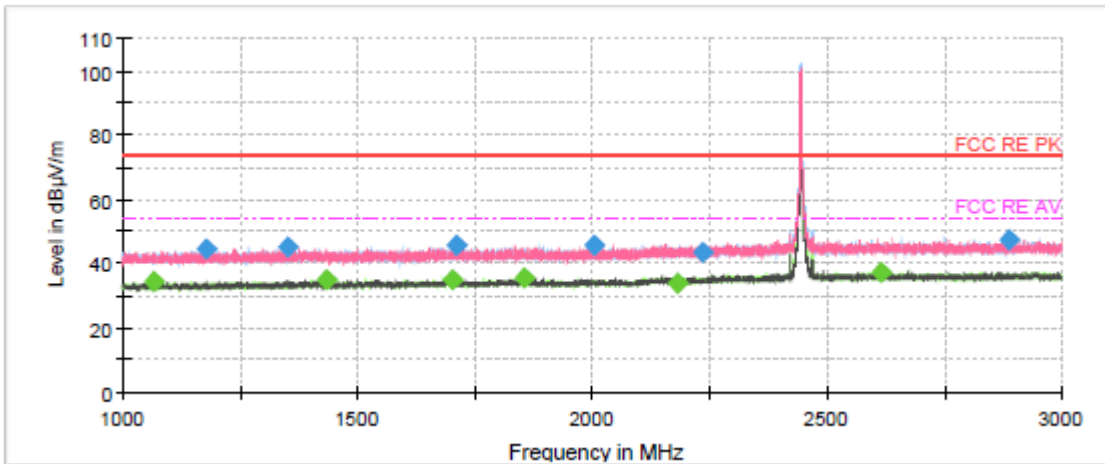

Note: The signal beyond the limit is carrier.  
Radiates Emission from 1GHz to 3GHz

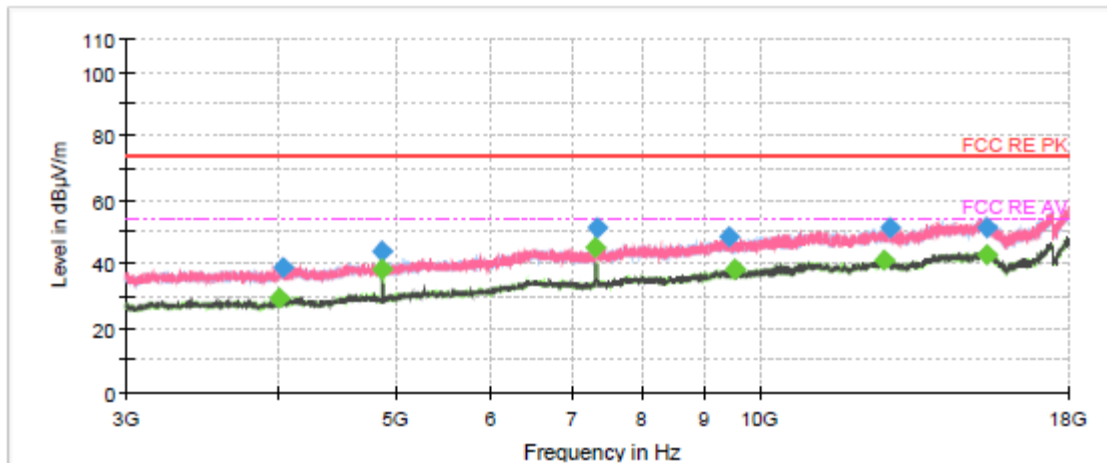

Radiates Emission from 3GHz to 18GHz



Frequency (MHz)	MaxPeak (dB $\mu$ V/m)	Average (dB $\mu$ V/m)	Limit (dB $\mu$ V/m)	Margin (dB)	Height (cm)	Pol	Azimuth (deg)	Corr. (dB/m)
1065.933333	---	34.41	54.00	19.59	100.0	H	328.0	-10.9
1177.466667	44.30	---	74.00	29.70	200.0	H	320.0	-10.4
1351.133333	44.89	---	74.00	29.11	100.0	V	5.0	-9.6
1434.266667	---	34.96	54.00	19.04	100.0	V	33.0	-9.3
1703.666667	---	35.25	54.00	18.75	100.0	V	252.0	-8.6
1711.000000	45.41	---	74.00	28.59	200.0	V	351.0	-8.6
1854.733333	---	35.48	54.00	18.52	200.0	H	265.0	-8.4
2003.666667	45.83	---	74.00	28.17	200.0	V	337.0	-8.2
2180.066667	---	33.67	54.00	20.33	200.0	H	292.0	-7.4
2235.600000	43.47	---	74.00	30.53	200.0	H	162.0	-7.2
2614.800000	---	37.48	54.00	16.52	200.0	V	173.0	-6.1
2886.866667	47.46	---	74.00	26.54	200.0	V	10.0	-6.0

**Remark: 1. Correction Factor = Antenna factor + Insertion loss (cable loss + amplifier gain)**

**2. Margin = Limit – Quasi-Peak**

Zigbee CH20

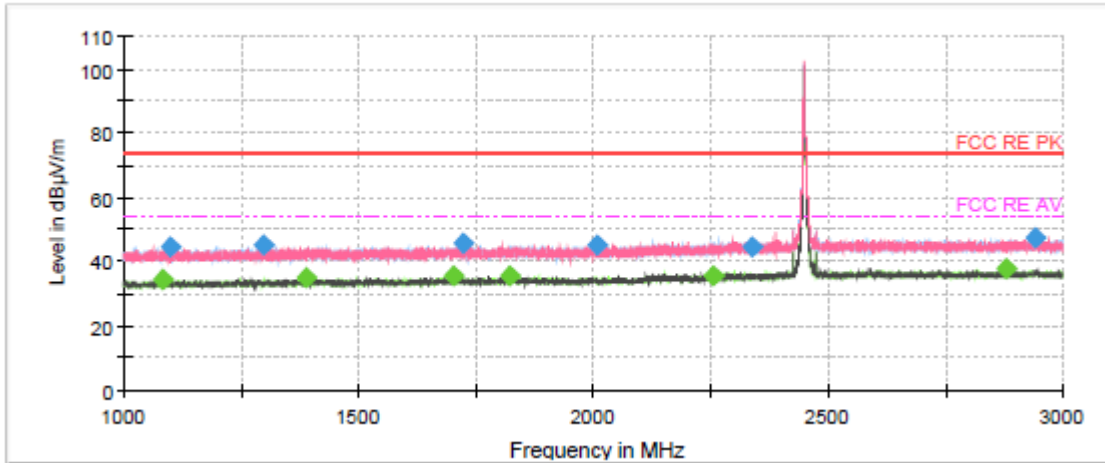

Note: The signal beyond the limit is carrier.  
Radiates Emission from 1GHz to 3GHz

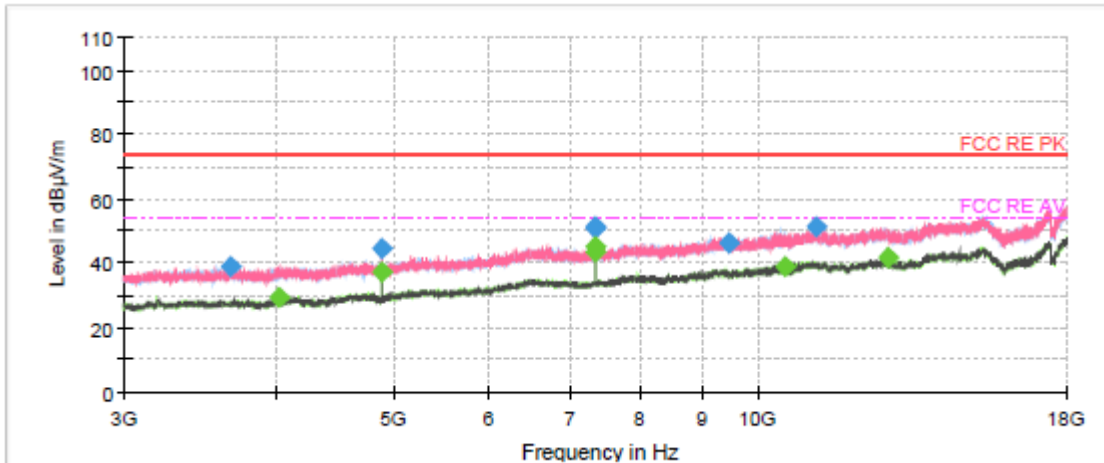

Radiates Emission from 3GHz to 18GHz





Frequency (MHz)	MaxPeak (dB $\mu$ V/m)	Average (dB $\mu$ V/m)	Limit (dB $\mu$ V/m)	Margin (dB)	Height (cm)	Pol	Azimuth (deg)	Corr. (dB/m)
1084.000000	---	34.36	54.00	19.64	100.0	H	357.0	-10.7
1100.466667	44.71	---	74.00	29.29	100.0	H	0.0	-10.6
1296.666667	44.87	---	74.00	29.13	100.0	V	215.0	-9.8
1389.400000	---	35.08	54.00	18.92	200.0	V	345.0	-9.6
1704.400000	---	35.35	54.00	18.65	100.0	V	295.0	-8.6
1724.200000	45.68	---	74.00	28.32	100.0	V	71.0	-8.6
1823.533333	---	35.56	54.00	18.44	200.0	V	355.0	-8.5
2006.466667	45.30	---	74.00	28.70	100.0	V	350.0	-8.2
2258.133333	---	35.48	54.00	18.52	100.0	H	328.0	-7.1
2336.933333	44.60	---	74.00	29.40	200.0	H	44.0	-6.9
2881.200000	---	37.72	54.00	16.28	100.0	H	338.0	-6.0
2940.866667	47.59	---	74.00	26.41	200.0	V	0.0	-5.9

**Remark: 1. Correction Factor = Antenna factor + Insertion loss (cable loss + amplifier gain)**

**2. Margin = Limit – Quasi-Peak**

Zigbee CH25

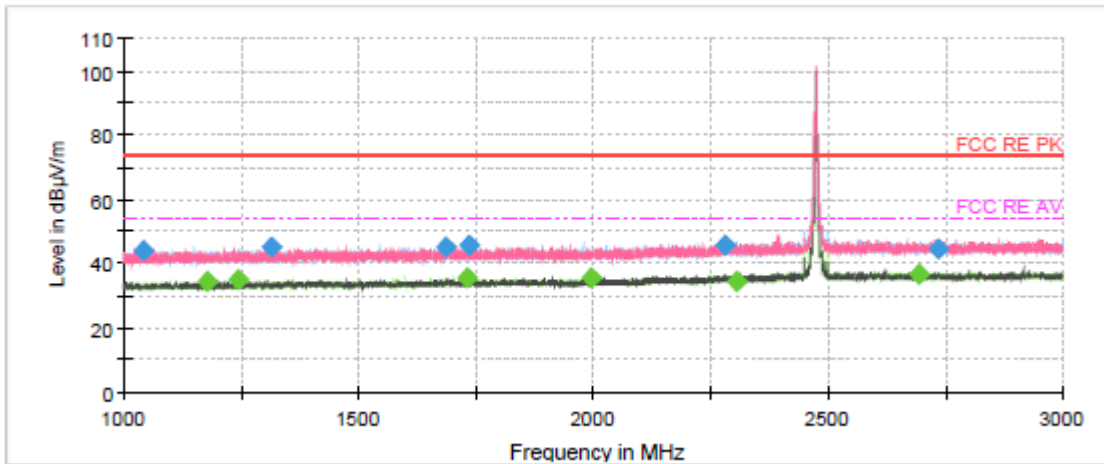

Note: The signal beyond the limit is carrier.  
Radiates Emission from 1GHz to 3GHz

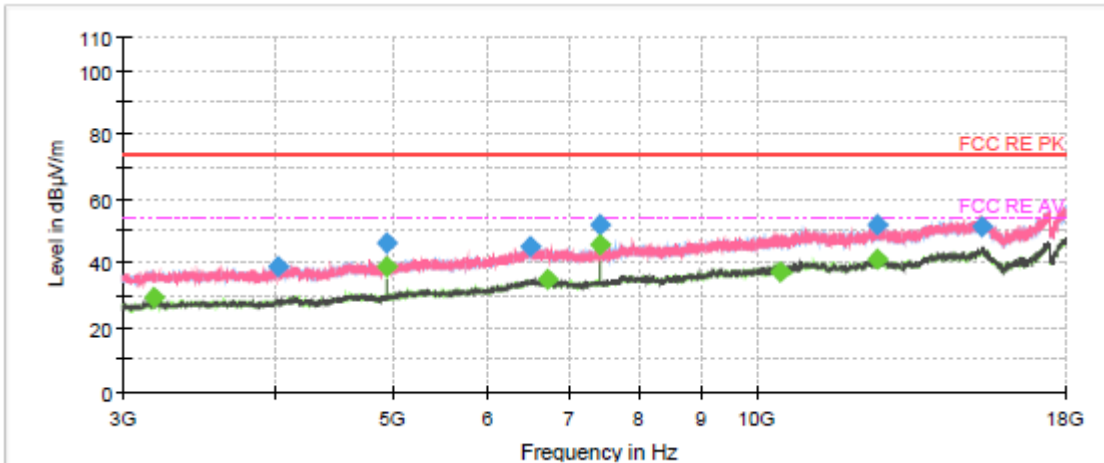

Radiates Emission from 3GHz to 18GHz



Frequency (MHz)	MaxPeak (dB $\mu$ V/m)	Average (dB $\mu$ V/m)	Limit (dB $\mu$ V/m)	Margin (dB)	Height (cm)	Pol	Azimuth (deg)	Corr. (dB/m)
1042.666667	44.05	---	74.00	29.95	100.0	V	78.0	-11.0
1179.466667	---	34.54	54.00	19.46	100.0	V	104.0	-10.4
1243.533333	---	34.86	54.00	19.14	200.0	H	76.0	-10.0
1313.200000	44.90	---	74.00	29.10	200.0	V	147.0	-9.7
1687.000000	45.28	---	74.00	28.72	100.0	H	350.0	-8.7
1731.933333	---	35.51	54.00	18.49	100.0	H	39.0	-8.6
1734.333333	45.91	---	74.00	28.09	200.0	H	223.0	-8.6
1996.666667	---	35.54	54.00	18.46	200.0	V	351.0	-8.2
2279.133333	45.53	---	74.00	28.47	200.0	H	62.0	-7.0
2305.000000	---	34.62	54.00	19.38	200.0	H	37.0	-6.9
2696.266667	---	36.53	54.00	17.47	100.0	H	326.0	-6.1
2736.733333	44.40	---	74.00	29.60	100.0	H	94.0	-6.1

**Remark: 1. Correction Factor = Antenna factor + Insertion loss (cable loss + amplifier gain)**

**2. Margin = Limit – Quasi-Peak**

### 5.7. Conducted Emission

#### Ambient condition

Temperature	Relative humidity	Pressure
23°C ~25°C	45%~50%	101.5kPa

#### Methods of Measurement

The EUT is placed on a non-metallic table of 80cm height above the horizontal metal reference ground plane. During the test, the EUT was operating in its typical mode. The test method is according to ANSI C63.10-2020. Connect the AC power line of the EUT to the L.I.S.N. Use EMI receiver to detect the average and Quasi-peak value. RBW is set to 9 kHz, VBW is set to 30kHz. The measurement result should include both L line and N line.

The test is in transmitting mode.

#### Test Setup

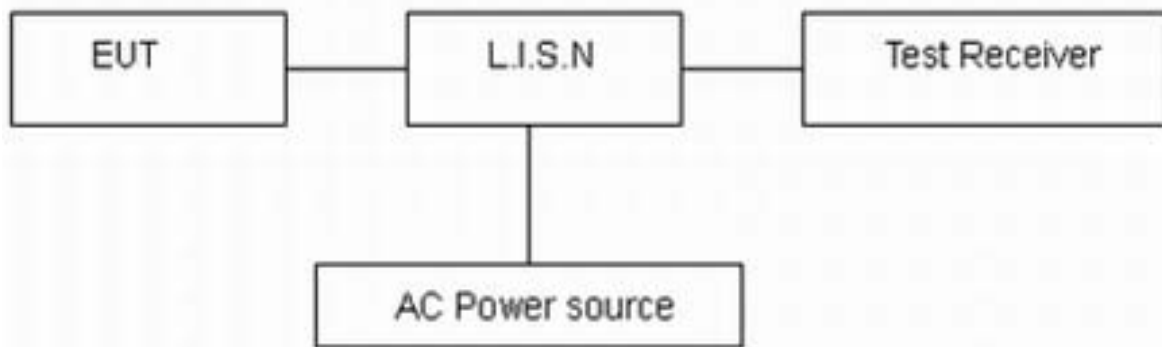

Note: AC Power source is used to change the voltage 110V/60Hz.

#### Limits

Frequency (MHz)	Conducted Limits(dBμV)	
	Quasi-peak	Average
0.15 - 0.5	66 to 56 *	56 to 46 *
0.5 - 5	56	46
5 - 30	60	50

\*: Decreases with the logarithm of the frequency.

#### Measurement Uncertainty

The assessed measurement uncertainty to ensure 95% confidence level for the normal distribution is with the coverage factor  $k = 1.96$ ,  $U = 2.69$  dB.

**Test Results:**

Following plots, Blue trace uses the peak detection and Green trace uses the average detection. During the test, the Conducted Emission was performed in all channels, Zigbee, Channel No.: 25 are selected as the worst condition. The test data of the worst-case condition was recorded in this report.

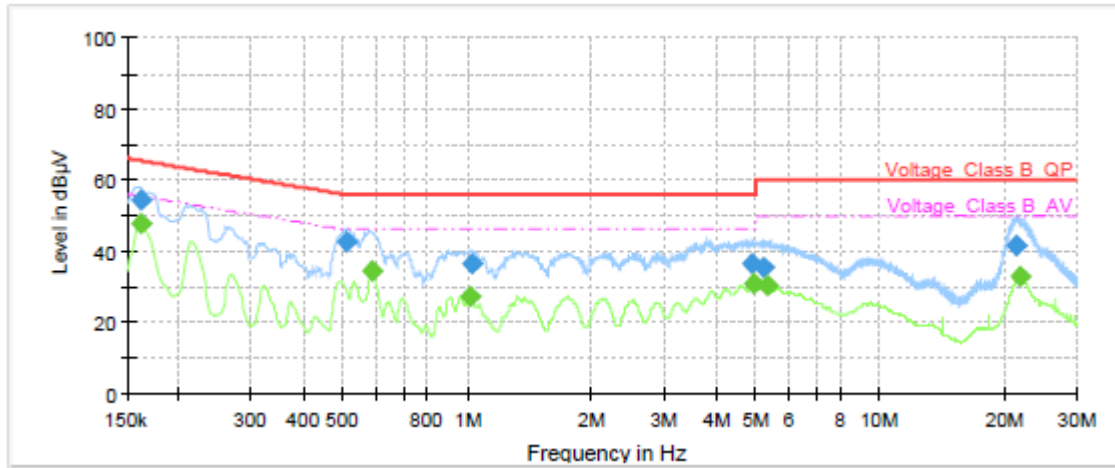

Frequency (MHz)	QuasiPeak (dBµV)	Average (dBµV)	Limit (dBµV)	Margin (dB)	Meas. Time (ms)	Bandwidth (kHz)	Line	Filter	Corr. (dB)
0.16	54.59	---	65.40	10.81	70.0	9.000	L1	ON	21
0.16	---	47.80	55.40	7.60	70.0	9.000	L1	ON	21
0.51	42.54	---	56.00	13.46	70.0	9.000	L1	ON	20
0.59	---	34.16	46.00	11.84	70.0	9.000	L1	ON	20
1.02	---	27.13	46.00	18.87	70.0	9.000	L1	ON	20
1.02	36.37	---	56.00	19.63	70.0	9.000	L1	ON	20
4.92	36.29	---	56.00	19.71	70.0	9.000	L1	ON	19
4.97	---	30.55	46.00	15.45	70.0	9.000	L1	ON	19
5.23	35.54	---	60.00	24.46	70.0	9.000	L1	ON	19
5.34	---	30.31	50.00	19.69	70.0	9.000	L1	ON	19
21.37	41.56	---	60.00	18.44	70.0	9.000	L1	ON	20
21.77	---	32.87	50.00	17.13	70.0	9.000	L1	ON	20

L line Conducted Emission from 150 KHz to 30 MHz

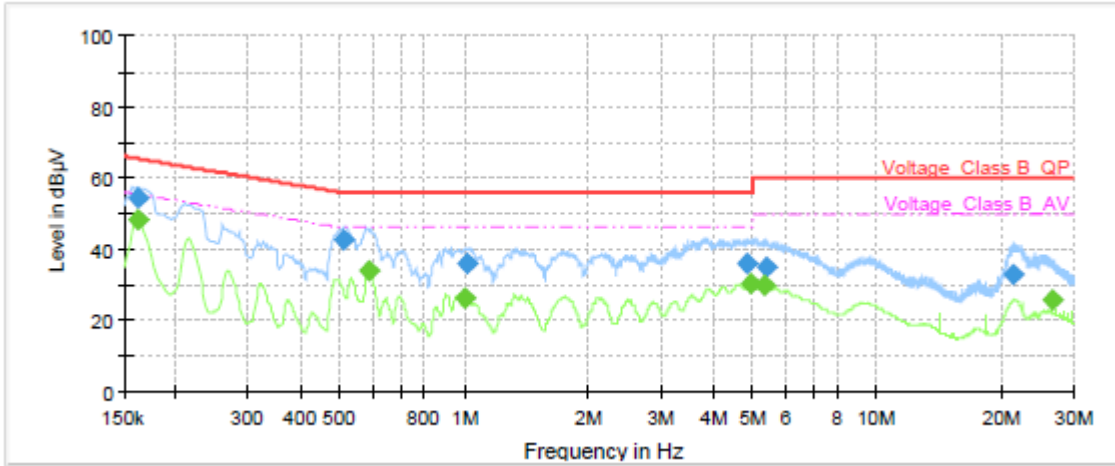

Frequency (MHz)	QuasiPeak (dBµV)	Average (dBµV)	Limit (dBµV)	Margin (dB)	Meas. Time (ms)	Bandwidth (kHz)	Line	Filter	Corr. (dB)
0.16	54.47	---	65.40	10.93	70.0	9.000	N	ON	21
0.16	---	48.43	55.40	6.97	70.0	9.000	N	ON	21
0.51	42.61	---	56.00	13.39	70.0	9.000	N	ON	20
0.59	---	33.77	46.00	12.23	70.0	9.000	N	ON	20
1.01	---	26.28	46.00	19.72	70.0	9.000	N	ON	20
1.02	35.93	---	56.00	20.07	70.0	9.000	N	ON	20
4.86	35.81	---	56.00	20.19	70.0	9.000	N	ON	19
4.97	---	30.48	46.00	15.52	70.0	9.000	N	ON	19
5.34	---	29.89	50.00	20.11	70.0	9.000	N	ON	19
5.42	34.99	---	60.00	25.01	70.0	9.000	N	ON	19
21.48	32.84	---	60.00	27.16	70.0	9.000	N	ON	20
26.62	---	25.64	50.00	24.36	70.0	9.000	N	ON	20

N line Conducted Emission from 150 KHz to 30 MHz



## 6. Main Test Instruments

Name	Manufacturer	Type	Serial Number	Calibration Date	Expiration Date
Spectrum Analyzer	R&S	FSV30	100815	2020-12-13	2021-12-12
EMI Test Receiver	R&S	ESCI	100948	2020-05-18	2021-05-17
				2021-05-15	2022-05-14
Loop Antenna	SCHWARZBECK	FMZB1519	1519-047	2020-04-02	2023-04-01
TRILOG Broadband Antenna	SCHWARZBECK	VULB 9163	391	2019-12-16	2021-12-15
Horn Antenna	R&S	HF907	102723	2018-08-11	2021-08-10
Horn Antenna	ETS-Lindgren	3160-09	00102644	2018-06-20	2023-06-19
EMI Test Receiver	R&S	ESR	101667	2020-05-18	2021-05-17
				2021-05-16	2022-05-15
LISN	R&S	ENV216	101171	2019-12-15	2021-12-14
Spectrum Analyzer	Agilent	N9010A	MY47191109	2020-05-18	2021-05-17
				2021-05-15	2022-05-14
20dB Attenuator	Star River Highlight	UCL-TS2S-20	18013001	2020-12-13	2021-12-12
RF Cable	Agilent	SMA 15cm	0001	2020-12-10	2021-06-09
				2021-06-09	2021-12-08
Software	R&S	EMC32	9.26.0	/	/

\*\*\*\*\*END OF REPORT \*\*\*\*\*



## **ANNEX A: The EUT Appearance**

The EUT Appearance are submitted separately.





## **ANNEX B: Test Setup Photos**

**The Test Setup Photos are submitted separately.**