



RF TEST REPORT

Applicant Sengled Co., Ltd.
FCC ID 2AGN8-E13N11
Product sengled element
Model E13-N11
Report No. R1801A0029-R1V1
Issue Date April 20, 2018

TA Technology (Shanghai) Co., Ltd. tested the above equipment in accordance with the requirements in **FCC CFR47 Part 15C (2018)**. The test results show that the equipment tested is capable of demonstrating compliance with the requirements as documented in this report.

Xianqing Li

Performed by: Xianqing Li

Kai Xu

Approved by: Kai Xu

TA Technology (Shanghai) Co., Ltd.

No.145, Jintang Rd, Tangzhen Industry Park, Pudong Shanghai, China

TEL: +86-021-50791141/2/3

FAX: +86-021-50791141/2/3-8000



TABLE OF CONTENT

1. Test Laboratory	4
1.1. Notes of the test report.....	4
1.2. Test facility	4
1.3. Testing Location.....	5
2. General Description of Equipment under Test.....	6
3. Applied Standards	7
4. Test Configuration	8
5. Test Case Results	9
5.1. Maximum conducted output power	9
5.2. 6dB Bandwidth	11
5.3. Band Edge	13
5.4. Power Spectral Density	15
5.5. Spurious RF Conducted Emissions.....	17
5.6. Radiated Emissions in the Restricted Band	19
5.7. Radiates Emission	23
5.8. Conducted Emission	33
6. Main Test Instruments.....	35
ANNEX A: EUT Appearance and Test Setup	36
A.1 EUT Appearance	36
A.2 Test Setup	37



Summary of measurement results

Number	Summary of measurements of results	Clause in FCC rules	Verdict
1	Maximum peak conducted output power	15.247(b)(3)	PASS
2	6 dB bandwidth	15.247(a)(2)	PASS
3	Maximum power spectral density	15.247(e)	PASS
4	Band Edge	15.247(d)	PASS
5	Spurious RF Conducted Emissions	15.247(d)	PASS
6	Radiated Emissions in restricted frequency bands	15.247(d),15.205,15.209	PASS
7	Radiated Emissions	15.247(d),15.205,15.209	PASS
8	Conducted Emissions	15.207	PASS
Date of Testing: January 16, 2018~ April 16, 2018			

1. Test Laboratory

1.1. Notes of the test report

This report shall not be reproduced in full or partial, without the written approval of **TA technology (shanghai) co., Ltd.** The results documented in this report apply only to the tested sample, under the conditions and modes of operation as described herein .Measurement Uncertainties were not taken into account and are published for informational purposes only. This report is written to support regulatory compliance of the applicable standards stated above.

1.2. Test facility

CNAS (accreditation number: L2264)

TA Technology (Shanghai) Co., Ltd. has obtained the accreditation of China National Accreditation Service for Conformity Assessment (CNAS).

FCC (Designation number: CN1179, Test Firm Registration Number: 446626)

TA Technology (Shanghai) Co., Ltd. has been listed on the US Federal Communications Commission list of test facilities recognized to perform electromagnetic emissions measurements.

IC (recognition number is 8510A)

TA Technology (Shanghai) Co., Ltd. has been listed by industry Canada to perform electromagnetic emission measurement.

VCCI (recognition number is C-4595, T-2154, R-4113, G-10766)

TA Technology (Shanghai) Co., Ltd. has been listed by industry Japan to perform electromagnetic emission measurement.

A2LA (Certificate Number: 3857.01)

TA Technology (Shanghai) Co., Ltd. has been listed by American Association for Laboratory Accreditation to perform electromagnetic emission measurement.



1.3. Testing Location

Company: TA Technology (Shanghai) Co., Ltd.
Address: No.145, Jintang Rd, Tangzhen Industry Park, Pudong
City: Shanghai
Post code: 201201
Country: P. R. China
Contact: Xu Kai
Telephone: +86-021-50791141/2/3
Fax: +86-021-50791141/2/3-8000
Website: <http://www.ta-shanghai.com>
E-mail: xukai@ta-shanghai.com

2. General Description of Equipment under Test

Client Information

Applicant	Sengled Co., Ltd.
Applicant address	Room 201/15, Building 1, No.498, Guoshoujing Road, Pilot Free Trade Zone, Shanghai City, P.R. China
Manufacturer	Sengled Co., Ltd.
Manufacturer address	Room 201/15, Building 1, No.498, Guoshoujing Road, Pilot Free Trade Zone, Shanghai City, P.R. China

General information

EUT Description	
Model:	E13-N11
IMEI:	/
Hardware Version:	V1.0
Software Version:	V1.0
Power Supply:	External power supply
Antenna Type:	Internal Antenna
Antenna Connector:	A permanently attached antenna (meet with the standard FCC Part 15.203 requirement)
Test Mode:	Zigbee
Modulation Type:	O-QPSK
Antenna Gain:	-0.79 dBi for 2405MHz -1.21 dBi for 2440MHz -2.76 dBi for 2480MHz
Max. Conducted Power	4.49 dBm
Operating Frequency Range(s)	2405 ~ 2480 MHz
Note: The information of the EUT is declared by the manufacturer.	



3. Applied Standards

According to the specifications of the manufacturer, it must comply with the requirements of the following standards:

Test standards

- **FCC CFR47 Part 15C (2018) Radio Frequency Devices**
- **ANSI C63.10 (2013)**
- **KDB 558074 D01 DTS Meas Guidance v04**

4. Test Configuration

Test Mode

The EUT was programmed to be in continuously transmitting mode and the transmit duty cycle is not less than 98%.

The EUT has been associated with peripherals and configuration operated in a manner tended to maximize its emission characteristics in a typical application.

The radiated emission was measured in the following position: EUT stand-up position (Z axis), lie-down position (X, Y axis). The worst emission was found in stand-up position (Z axis) and the worst case was recorded.

Mode	Channel	Frequency
Zigbee	11	2405MHz
	12	2410MHz
	13	2415MHz
	14	2420MHz
	15	2425MHz
	16	2430MHz
	17	2435MHz
	18	2440MHz
	19	2445MHz
	20	2450MHz
	21	2455MHz
	22	2460MHz
	23	2465MHz
	24	2470MHz
	25	2475MHz
	26	2480MHz

5. Test Case Results

5.1. Maximum conducted output power

Ambient condition

Temperature	Relative humidity	Pressure
23°C ~25°C	45%~50%	101.5kPa

Methods of Measurement

During the process of the testing, The EUT was connected to Spectrum Analyzer with a known loss. The EUT is max power transmission with proper modulation. The signal transmission is continuous.

Test Setup

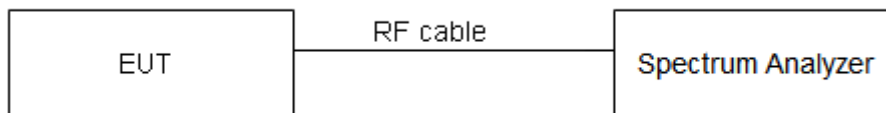

Limits

Rule Part 15.247 (b) (3) specifies that " For systems using digital modulation in the 902–928 MHz, 2400–2483.5 MHz: 1 Watt."

Average Output Power	≤ 1W (30dBm)
----------------------	--------------

Measurement Uncertainty

The assessed measurement uncertainty to ensure 95% confidence level for the normal distribution is with the coverage factor $k = 2$, $U = 0.44$ dB.

Test Results

Network Standards	Carrier frequency (MHz)	Output Power (dBm)	Limit (dBm)	Conclusion
Zigbee	2405	3.72	30	PASS
	2440	4.49	30	PASS
	2480	-17.1	30	PASS

Zigbee, Carrier frequency (MHz): 2405



Zigbee, Carrier frequency (MHz): 2440



Zigbee, Carrier frequency (MHz): 2480



5.2. 6dB Bandwidth

Ambient condition

Temperature	Relative humidity	Pressure
23°C ~25°C	45%~50%	101.5kPa

Method of Measurement

The EUT was connected to the spectrum analyzer through an external attenuator (20dB) and a known loss cable. RBW is set to 100 kHz; VBW is set to 300 kHz on spectrum analyzer.

Test Setup

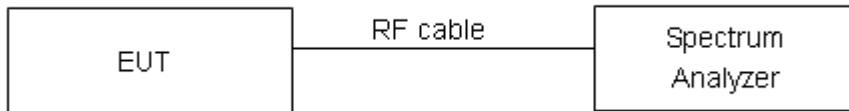

Limits

Rule Part 15.247 (a) (2) specifies that “Systems using digital modulation techniques may operate in the 902–928 MHz, 2400–2483.5 MHz bands. The minimum 6 dB bandwidth shall be at least 500 kHz.”

minimum 6 dB bandwidth	≥ 500 kHz
------------------------	-----------

Measurement Uncertainty

The assessed measurement uncertainty to ensure 95% confidence level for the normal distribution is with the coverage factor $k = 2$, $U = 936$ Hz.

Test Results:

Network Standards	Carrier frequency (MHz)	99% bandwidth (MHz)	Minimum 6 dB bandwidth (MHz)	Limit (kHz)	Conclusion
Zigbee	2405	2.3604	1.597	500	PASS
	2440	2.3839	1.625	500	PASS
	2480	2.3574	1.591	500	PASS

Zigbee, Carrier frequency (MHz): 2405



Zigbee, Carrier frequency (MHz): 2440



Zigbee, Carrier frequency (MHz): 2480



5.3. Band Edge

Ambient condition

Temperature	Relative humidity	Pressure
23°C ~25°C	45%~50%	101.5kPa

Method of Measurement

The EUT was connected to the spectrum analyzer through an external attenuator (20dB) and a known loss cable the band edge of the lowest and highest channels were measured. The peak detector is used and RBW is set to 100 kHz and VBW is set to 300 kHz on spectrum analyzer. Spectrum analyzer plots are included on the following pages.

Test Setup

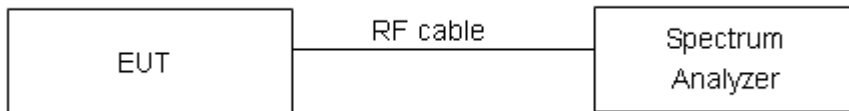

Limits

Rule Part 15.247(d) specifies that “In any 100 kHz bandwidth outside the frequency band in which the spread spectrum or digitally modulated intentional radiator is operating, the radio frequency power that is produced by the intentional radiator shall be at least 20 dB below that in the 100 kHz bandwidth within the band that contains the highest level of the desired power, based on either an RF conducted or a radiated measurement, provided the transmitter demonstrates compliance with the peak conducted power limits.” If the transmitter complies with the conducted power limits based on the use of RMS averaging over a time interval, as permitted under paragraph (b)(3) of this section, the attenuation required under this paragraph shall be 30 dB instead of 20 dB.”

Measurement Uncertainty

The assessed measurement uncertainty to ensure 95% confidence level for the normal distribution is with the coverage factor $k = 1.96$.

Frequency	Uncertainty
2GHz-3GHz	1.407 dB



Test Results: PASS

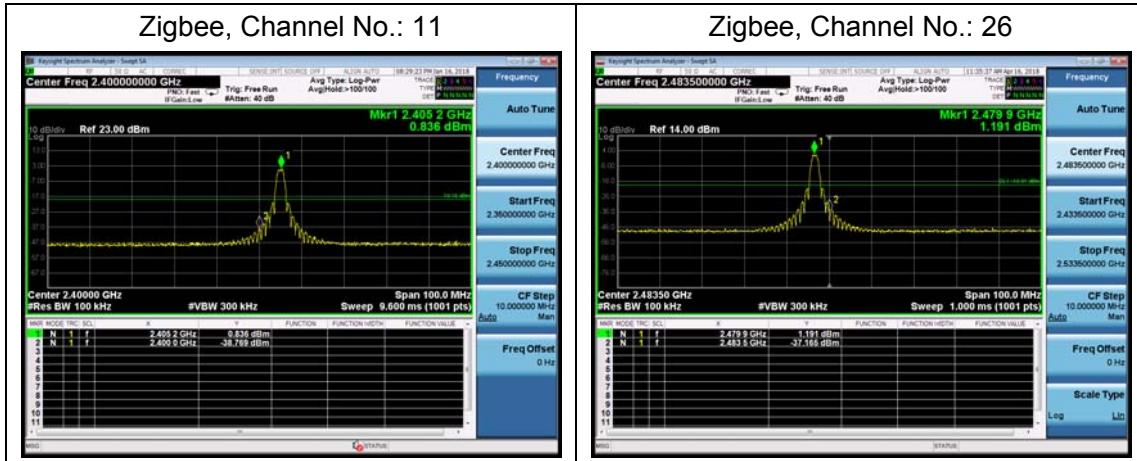

5.4. Power Spectral Density

Ambient condition

Temperature	Relative humidity	Pressure
23°C ~25°C	45%~50%	101.5kPa

Method of Measurement

During the process of the testing, The EUT was connected to Spectrum Analyzer with a known loss. The EUT is max power transmission with proper modulation. Method AVGPSD-2 in KDB558074 D01 was used for this test.

Test setup

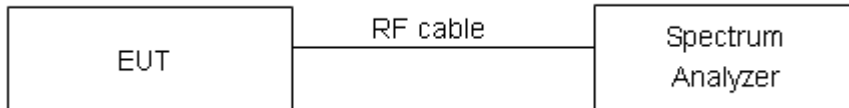

Limits

Rule Part 15.247(e) specifies that” For digitally modulated systems, the power spectral density conducted from the intentional radiator to the antenna shall not be greater than 8 dBm in any 3 kHz band during any time interval of continuous transmission. ”

Limits	≤ 8 dBm / 3kHz
--------	----------------

Measurement Uncertainty

The assessed measurement uncertainty to ensure 95% confidence level for the normal distribution is with the coverage factor $k = 2$, $U = 0.75\text{dB}$.



Test Results:

Network Standards	Channel Number	Power Spectral Density (dBm / 3kHz)	Limit (dBm / 3kHz)	Conclusion
Zigbee	11	-20.349	8	PASS
	18	-19.840	8	PASS
	26	-19.467	8	PASS

Zigbee, Channel No.: 11



Zigbee, Channel No.: 18



Zigbee, Channel No.: 26



5.5. Spurious RF Conducted Emissions

Ambient condition

Temperature	Relative humidity	Pressure
23°C ~25°C	45%~50%	101.5kPa

Method of Measurement

The EUT was connected to the spectrum analyzer with a known loss. The spectrum analyzer scans from 30MHz to the 10th harmonic of the carrier. The peak detector is used. Set RBW to 100kHz and VBW to 300 kHz, Sweep is set to ATUO.

The test is in transmitting mode.

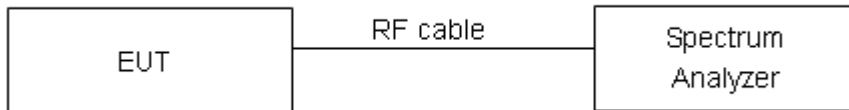

Limits

Rule Part 15.247(d) pacifies that “In any 100 kHz bandwidth outside the frequency band in which the spread spectrum intentional radiator is operating, the radio frequency power that is produced by the intentional radiator shall be at least 30 dB below that in the 100 kHz bandwidth within the band that contains the highest level of the desired power.” If the transmitter complies with the conducted power limits based on the use of RMS averaging over a time interval, as permitted under paragraph (b)(3) of this section, the attenuation required under this paragraph shall be 30 dB instead of 20 dB.”

Network Standards	Carrier frequency (MHz)	Reference value (dBm)	Limit
Zigbee	2405	0.92	-19.08
	2440	0.28	-19.73
	2480	0.33	-19.67

Measurement Uncertainty

The assessed measurement uncertainty to ensure 95% confidence level for the normal distribution is with the coverage factor $k = 1.96$.

Frequency	Uncertainty
100kHz-2GHz	0.684 dB
2GHz-26GHz	1.407 dB



Test Results:

The signal beyond the limit is carrier.

Zigbee, Channel No.: CH11

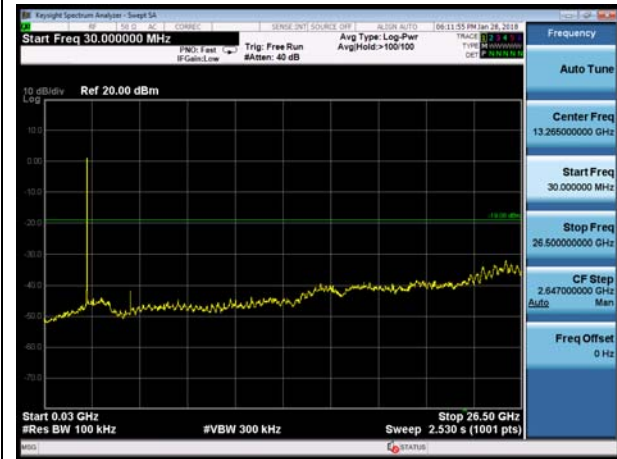

Zigbee, Channel No.: CH18



Zigbee, Channel No.: CH26



5.6. Radiated Emissions in the Restricted Band

Ambient condition

Temperature	Relative humidity	Pressure
23°C ~25°C	45%~50%	101.5kPa

Method of Measurement

The Equipment Under Test (EUT) was set up on a non-conductive table in the semi-anechoic chamber. The test was performed at the distance of 3 m between the EUT and the receiving antenna. The turntable shall be rotated from 0 to 360 degrees for detecting the maximum of radiated spurious signal level. The measurements shall be repeated with orthogonal polarization of the test antenna. RBW is set to 100kHz. The data of cable loss and antenna factor has been calibrated in full testing frequency range before the testing. Sweep the whole frequency band through the range from 9kHz to the 10th harmonic of the carrier, and the emissions less than 20 dB below the permissible value are reported.

This method refer to KDB 558074.

The procedure for peak unwanted emissions measurements above 1000 MHz is as follows:

I) Peak emission levels are measured by setting the instrument as follows:

- 1) RBW = 1 MHz.
- 2) VBW \geq [3 × RBW]
- 3) Detector = peak.
- 4) Sweep time = auto.
- 5) Trace mode = max hold.
- 6) Allow sweeps to continue until the trace stabilizes. Note that if the transmission is not continuous, then the time required for the trace to stabilize will increase by a factor of approximately 1 / D, where D is the duty cycle.

II) Average emission levels are measured by setting the instrument as follows:

- a) RBW = 1 MHz.
- b) VBW \geq [3 × RBW].
- c) Detector = RMS (power averaging), if [span / (# of points in sweep)] \leq RBW / 2. Satisfying this condition can require increasing the number of points in the sweep or reducing the span. If the condition is not satisfied, then the detector mode shall be set to peak.
- d) Averaging type = power (i.e., rms) (As an alternative, the detector and averaging type may be set for linear voltage averaging. Some instruments require linear display mode to use linear voltage averaging. Log or dB averaging shall not be used.)
- e) Sweep time = auto.
- f) Perform a trace average of at least 100 traces if the transmission is continuous. If the transmission is not continuous, then the number of traces shall be increased by a factor of 1 / D, where D is the duty cycle. For example, with 50% duty cycle, at least 200 traces shall be averaged. (If a specific emission is demonstrated to be continuous—i.e., 100% duty cycle—then rather than turning ON and

OFF with the transmit cycle, at least 100 traces shall be averaged.)

g) If tests are performed with the EUT transmitting at a duty cycle less than 98%, then a correction factor shall be added to the measurement results prior to comparing with the emission limit, to compute the emission level that would have been measured had the test been performed at 100% duty cycle. The correction factor is computed as follows:

1) If power averaging (rms) mode was used in the preceding step e), then the correction factor is $[10 \log (1 / D)]$, where D is the duty cycle. For example, if the transmit duty cycle was 50%, then 3 dB shall be added to the measured emission levels.

2) If linear voltage averaging mode was used in the preceding step e), then the correction factor is $[20 \log (1 / D)]$, where D is the duty cycle. For example, if the transmit duty cycle was 50%, then 6 dB shall be added to the measured emission levels.

3) If a specific emission is demonstrated to be continuous (100% duty cycle) rather than turning ON and OFF with the transmit cycle, then no duty cycle correction is required for that emission.

The field strength of spurious emission was measured in the following position: EUT stand-up position (Z axis), lie-down position (X, Y axis). The worst emission was found in stand-up position (Z axis) and the antenna is vertical.

The test is in transmitting mode.

Test setup

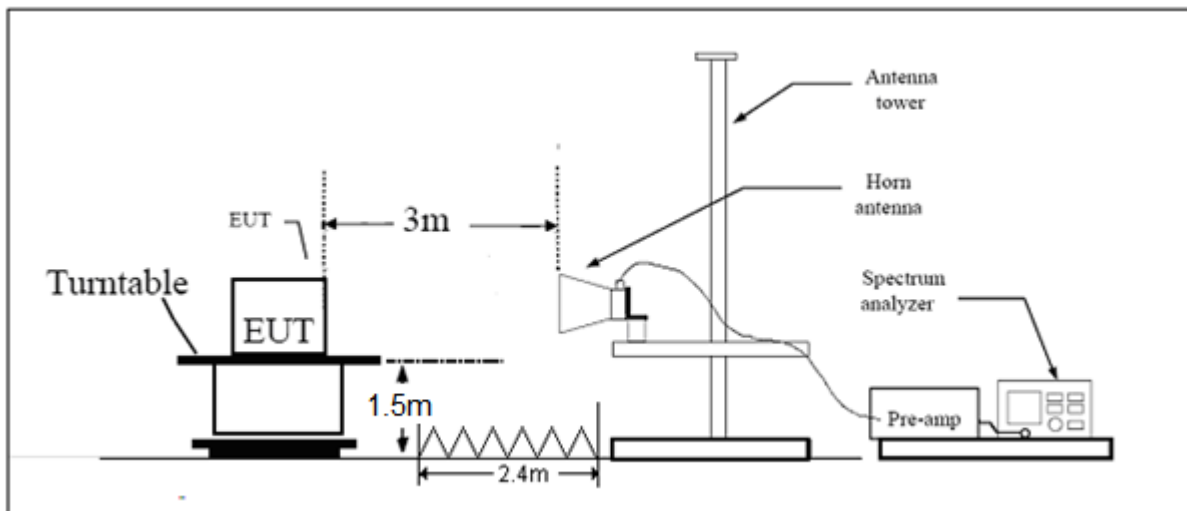

Note: Area side: 2.4mX3.6m

Limits

Spurious Radiated Emissions are permitted in any of the frequency bands listed below:



MHz	MHz	MHz	GHz
0.090 - 0.110	16.42 - 16.423	399.9 - 410	4.5 - 5.15
0.495 - 0.505	16.69475 - 16.69525	608 - 614	5.35 - 5.46
2.1735 - 2.1905	16.80425 - 16.80475	960 - 1240	7.25 - 7.75
4.125 - 4.128	25.5 - 25.67	1300 - 1427	8.025 - 8.5
4.17725 - 4.17775	37.5 - 38.25	1435 - 1626.5	9.0 - 9.2
4.20725 - 4.20775	73 - 74.6	1645.5 - 1646.5	9.3 - 9.5
6.215 - 6.218	74.8 - 75.2	1660 - 1710	10.6 - 12.7
6.26775 - 6.26825	108 - 121.94	1718.8 - 1722.2	13.25 - 13.4
6.31175 - 6.31225	123 - 138	2200 - 2300	14.47 - 14.5
8.291 - 8.294	149.9 - 150.05	2310 - 2390	15.35 - 16.2
8.362 - 8.366	156.52475 - 156.52525	2483.5 - 2500	17.7 - 21.4
8.37625 - 8.38675	156.7 - 156.9	2690 - 2900	22.01 - 23.12
8.41425 - 8.41475	162.0125 - 167.17	3260 - 3267	23.6 - 24.0
12.29 - 12.293	167.72 - 173.2	3332 - 3339	31.2 - 31.8
12.51975 - 12.52025	240 - 285	3345.8 - 3358	36.43 - 36.5
12.57675 - 12.57725	322 - 335.4	3600 - 4400	(²)
13.36 - 13.41			

Limit in restricted band

Frequency of emission (MHz)	Field strength(uV/m)	Field strength(dBuV/m)
30-88	100	40
88-216	150	43.5
216-960	200	46
Above960	500	54

§15.35(b)

There is also a limit on the radio frequency emissions, as measured using instrumentation with a peak detector function, corresponding to 20 dB above the maximum permitted average limit.

Peak Limit=74 dBuV/m

Average Limit=54 dBuV/m

Measurement Uncertainty

The assessed measurement uncertainty to ensure 95% confidence level for the normal distribution is with the coverage factor $k = 1.96$, $U = 3.55$ dB.

Test Results:

The signal beyond the limit is carrier.

Zigbee-Channel 11: Peak

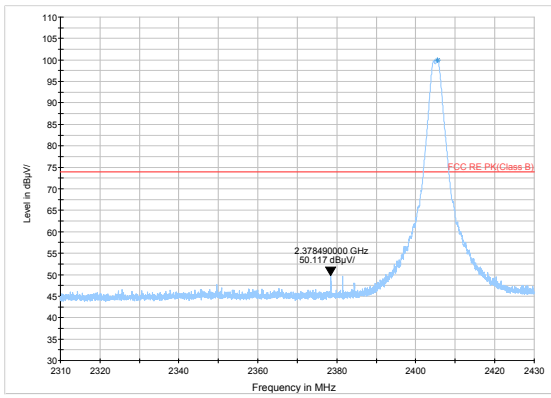

Zigbee-Channel 11: Average

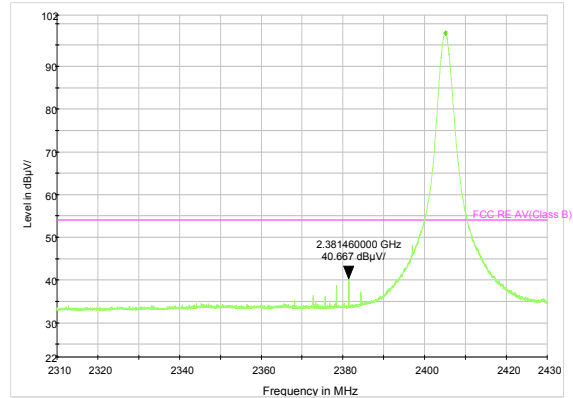

Zigbee-Channel 26: Peak

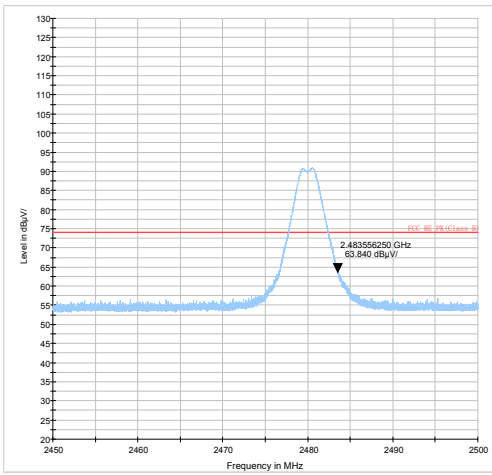

Zigbee-Channel 26: Average

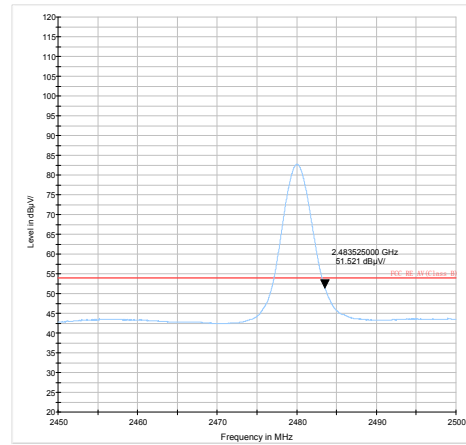

5.7. Radiates Emission

Ambient condition

Temperature	Relative humidity	Pressure
23°C ~25°C	45%~50%	102.5kPa

Method of Measurement

The test set-up was made in accordance to the general provisions of ANSI C63.10-2013. The Equipment Under Test (EUT) was set up on a non-conductive table in the semi-anechoic chamber. The test was performed at the distance of 3 m between the EUT and the receiving antenna. The radiated emissions measurements were made in a typical installation configuration.

Sweep the whole frequency band through the range from 9 kHz to the 10th harmonic of the carrier, and the emissions less than 20 dB below the permissible value are reported.

During the test, below 30MHz, the center of the loop shall be 1 meters; above 30MHz, the height of receive antenna shall be moved from 1 to 4 meters, and the antenna shall be performed under horizontal and vertical polarization. The turntable shall be rotated from 0 to 360 degrees for detecting the maximum of radiated spurious signal level. The measurements shall be repeated with orthogonal polarization of the test antenna. The data of cable loss and antenna factor has been calibrated in full testing frequency range before the testing.

Set the spectrum analyzer in the following:

Below 1GHz (detector: Peak and Quasi-Peak)

RBW=100 kHz / VBW=300 kHz / Sweep=AUTO

Above 1GHz (detector: Peak):

(a) PEAK: RBW=1MHz / VBW=3MHz/ Sweep=AUTO

(b) AVERAGE: RBW=1MHz / VBW=10Hz, when duty cycle is not less than 98%

VBW \geq 1/T when duty cycle is less than 98%, where T is transmit on time

Sweep=AUTO

The radiated emission was measured in the following position: EUT stand-up position (Z axis), lie-down position (X, Y axis). The worst emission was found in stand-up position (Z axis) and the worst case was recorded.

The test is in transmitting mode.

Test setup

9KHz~~~ 30MHz

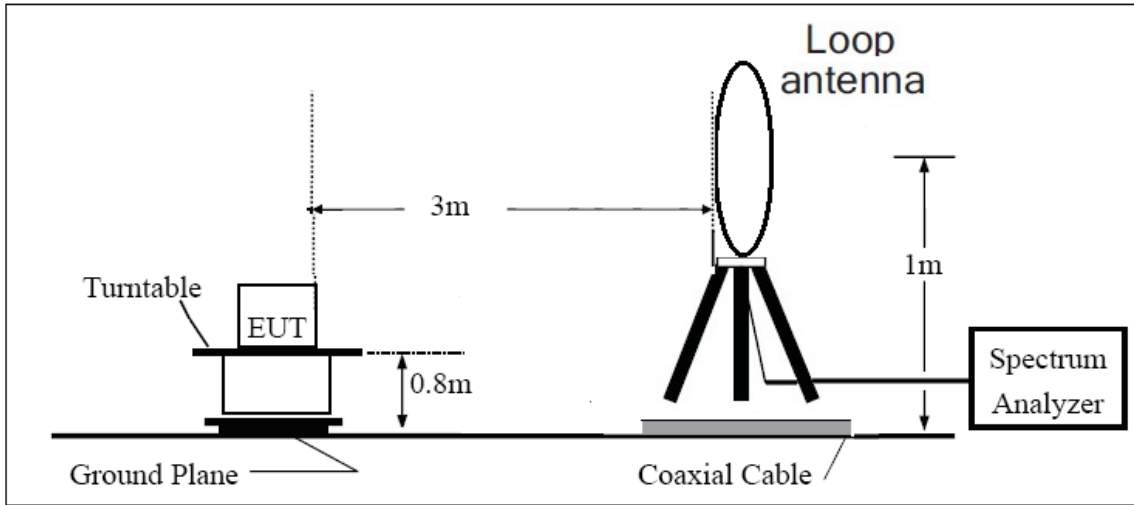

30MHz~~~ 1GHz

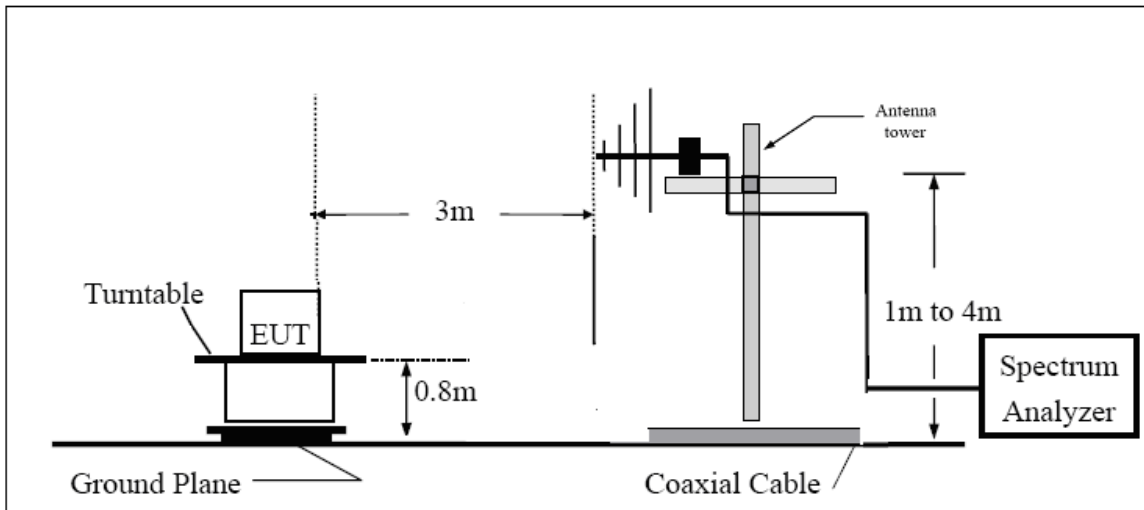

Above 1GHz

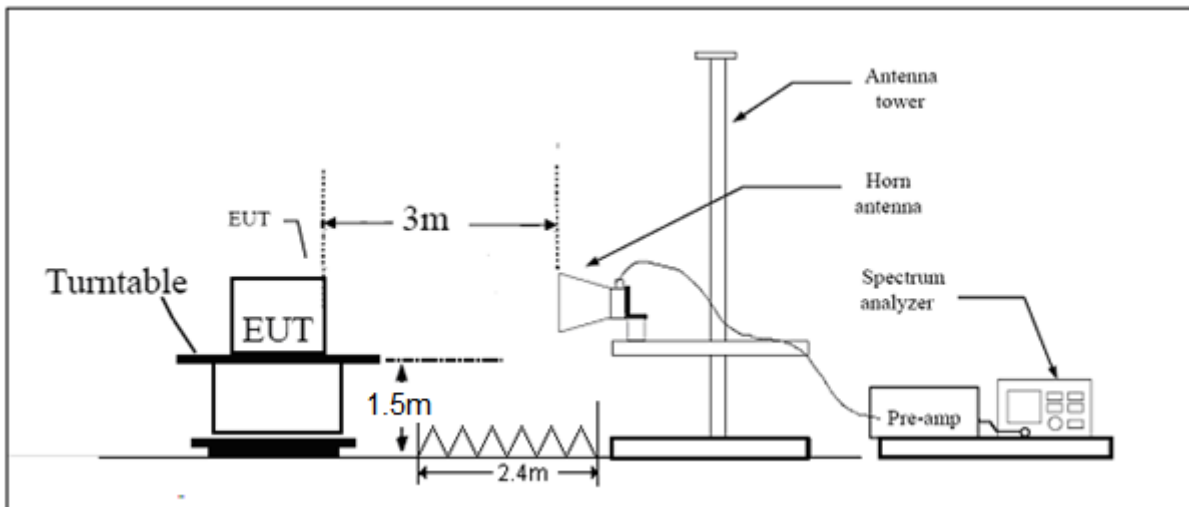

Note: Area side:2.4mX3.6m

Limits

Rule Part 15.247(d) specifies that “In addition, radiated emissions which fall in the restricted bands, as defined in § 15.205(a), must also comply with the radiated emission limits specified in § 15.209(a) (see § 15.205(c)).”

Limit in restricted band

Frequency of emission (MHz)	Field strength(uV/m)	Field strength(dBuV/m)
0.009–0.490	2400/F(kHz)	/
0.490–1.705	24000/F(kHz)	/
1.705–30.0	30	/
30-88	100	40
88-216	150	43.5
216-960	200	46
Above960	500	54

§15.35(b)

There is also a limit on the radio frequency emissions, as measured using instrumentation with a peak detector function, corresponding to 20 dB above the maximum permitted average limit.

Measurement Uncertainty

The assessed measurement uncertainty to ensure 95% confidence level for the normal distribution is with the coverage factor $k = 1.96$.

Frequency	Uncertainty
9KHz-30MHz	3.55 dB
30MHz-200MHz	4.19 dB
200MHz-1GHz	3.63 dB
Above 1GHz	3.68 dB

Test result

Sweep from 9 kHz to 30MHz, and the emissions more than 20 dB below the permissible value are not reported.

The following graphs display the maximum values of horizontal and vertical by software.

For above 1GHz, Blue trace uses the peak detection, Green trace uses the average detection.

During the test, the Radiates Emission from 30MHz to 1GHz was performed in all modes with all channels, **Zigbee CH11** are selected as the worst condition. The test data of the worst-case condition was recorded in this report.

Continuous TX mode:

RE 0.03-1GHz QP Class B

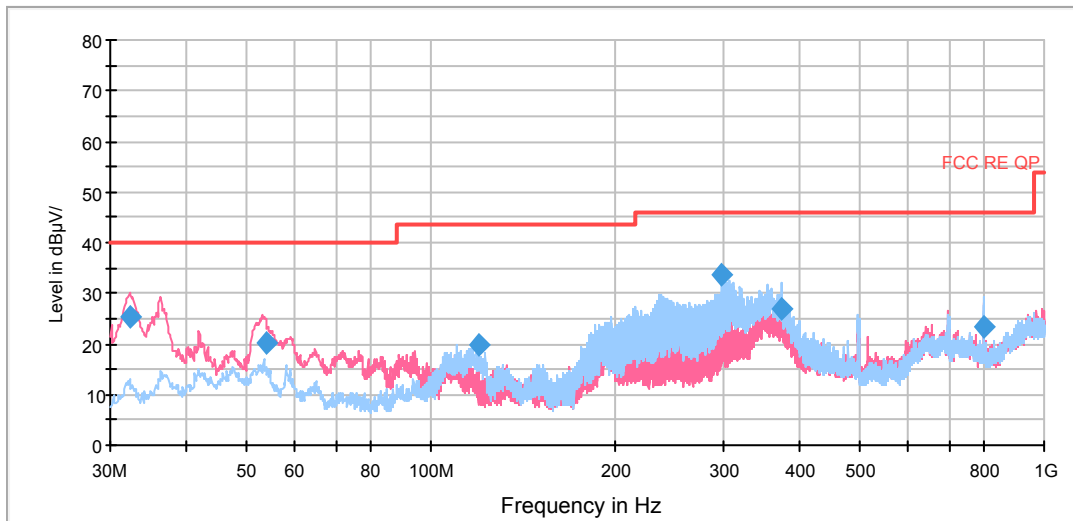

Radiates Emission from 30MHz to 1GHz



Zigbee CH11

RE 1G-3GHz PK+AV

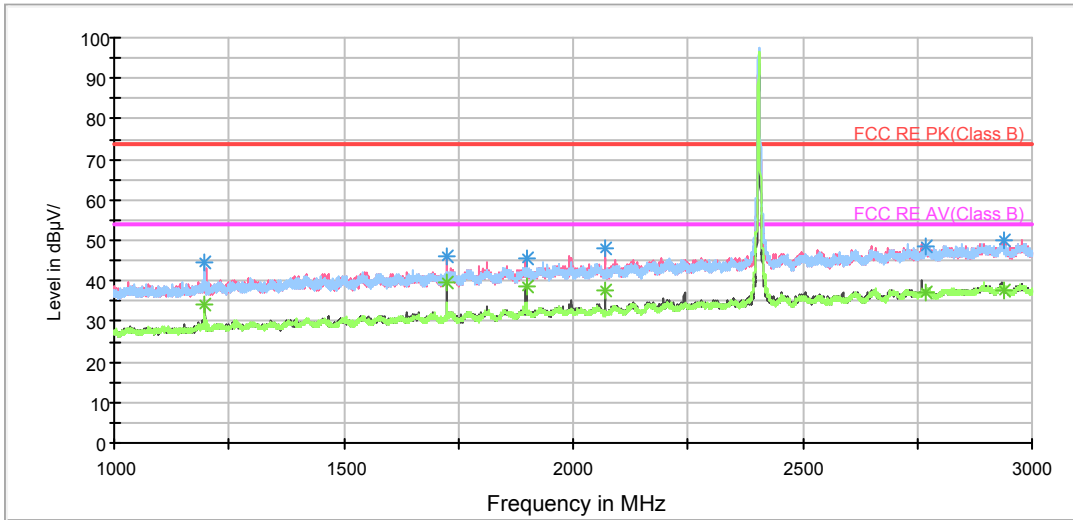

Note: The signal beyond the limit is carrier.
Radiates Emission from 1GHz to 3GHz

RE 3-18GHz PK+AV

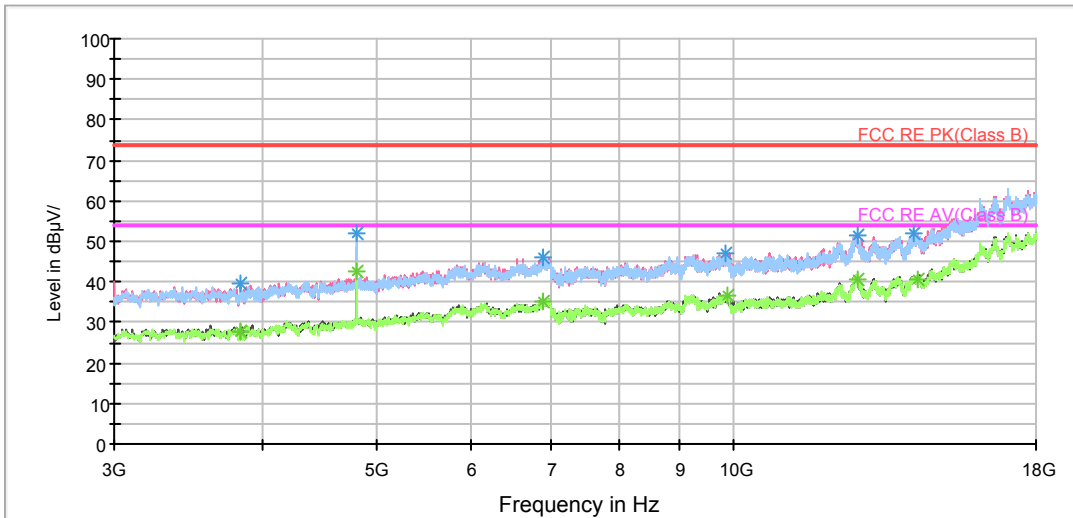

Radiates Emission from 3GHz to 18GHz

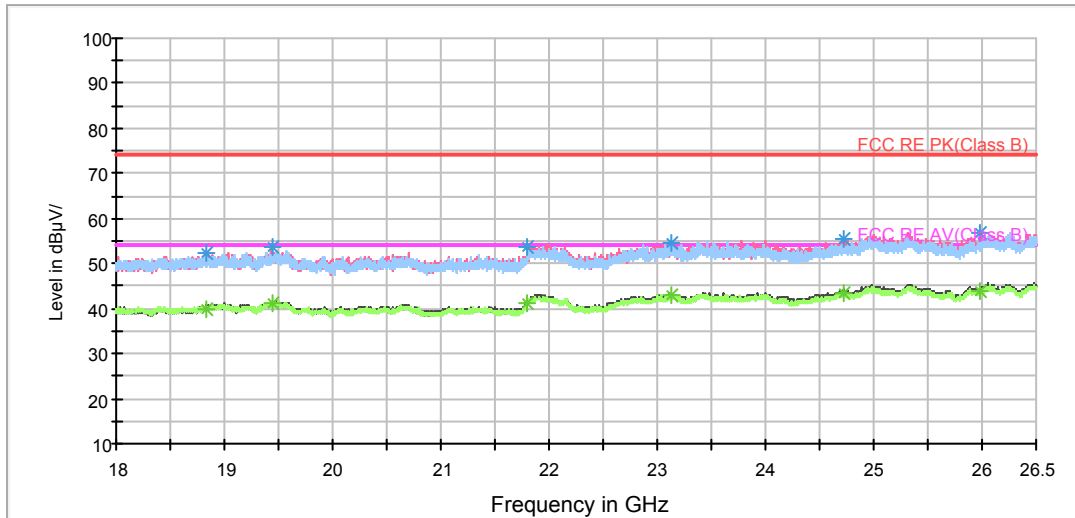

Radiates Emission from 18GHz to 26.5GHz

Frequency (MHz)	Peak (dBuV/m)	Height (cm)	Polarization	Azimuth (deg)	Reading value (dBuV/m)	Correct Factor (dB)	Margin (dB)	Limit (dBuV/m)
1197.500000	44.3	200.0	H	11.0	52.5	-8.2	29.7	74
1725.000000	45.9	200.0	V	317.0	50.9	-5.0	28.1	74
1897.500000	45.4	100.0	V	262.0	49.3	-3.9	28.6	74
2070.000000	48.2	100.0	V	80.0	51.3	-3.1	25.8	74
2769.500000	48.7	200.0	H	127.0	47.9	0.8	25.3	74
2938.750000	49.8	100.0	V	117.0	47.9	1.9	24.2	74

Remark: 1. Correction Factor = Antenna factor+ Insertion loss (cable loss + amplifier gain)

Frequency (MHz)	Average (dBuV/m)	Height (cm)	Polarization	Azimuth (deg)	Reading value (dBuV/m)	Correct Factor (dB)	Margin (dB)	Limit (dBuV/m)
1197.500000	34.4	200.0	H	11.0	42.6	-8.2	19.6	54
1725.000000	39.5	200.0	V	317.0	44.5	-5.0	14.5	54
1897.500000	38.5	100.0	V	262.0	42.4	-3.9	15.5	54
2070.000000	37.5	100.0	V	80.0	40.6	-3.1	16.5	54
2769.500000	36.9	200.0	H	127.0	36.1	0.8	17.1	54
2938.750000	37.7	100.0	V	117.0	35.8	1.9	16.3	54

Remark: 1. Correction Factor = Antenna factor+ Insertion loss (cable loss + amplifier gain)

Zigbee CH18

RE 1G-3GHz PK+AV

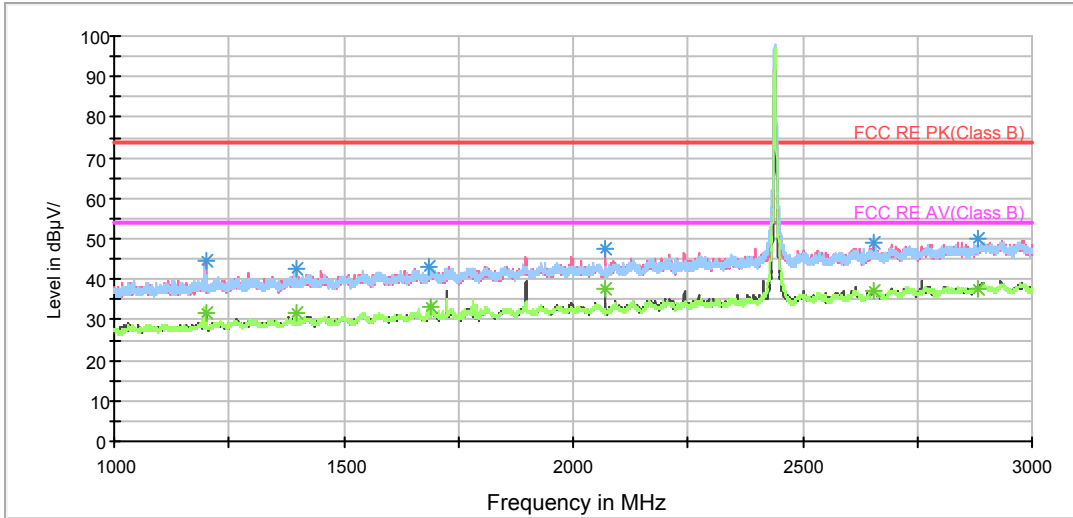

Note: The signal beyond the limit is carrier.
Radiates Emission from 1GHz to 3GHz

RE 3-18GHz PK+AV

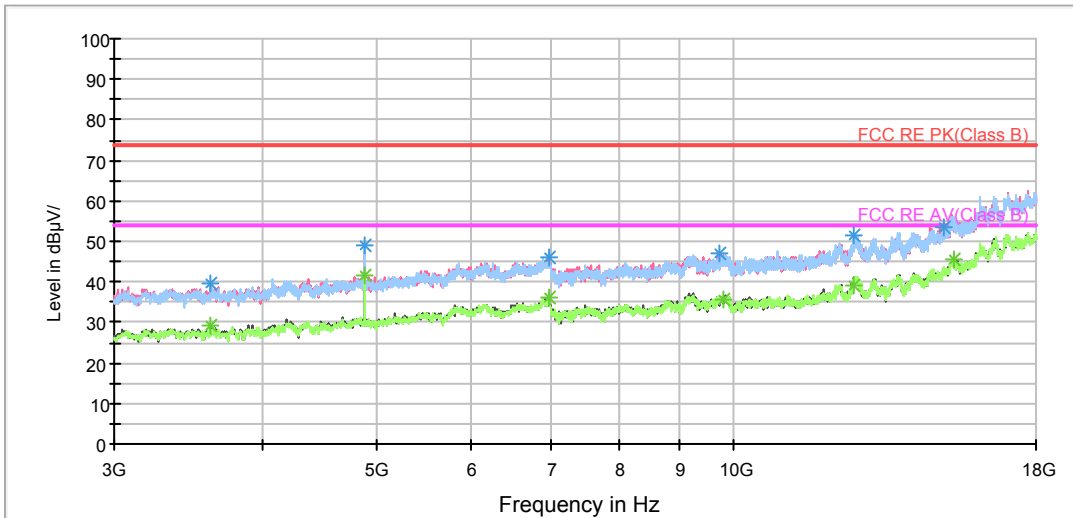

Radiates Emission from 3GHz to 18GHz

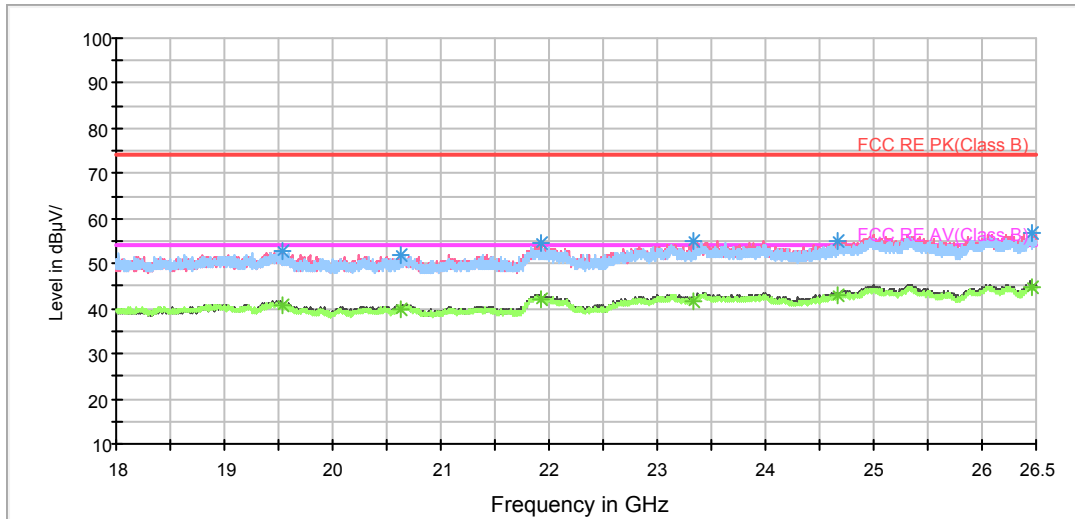

Radiates Emission from 18GHz to 26.5GHz

Frequency (MHz)	Peak (dBuV/m)	Height (cm)	Polarization	Azimuth (deg)	Reading value (dBuV/m)	Correct Factor (dB)	Margin (dB)	Limit (dBuV/m)
1200.000000	44.7	200.0	V	0.0	52.9	-8.2	29.3	74
1398.750000	42.5	200.0	H	309.0	49.6	-7.1	31.5	74
1686.250000	43.1	100.0	H	146.0	48.1	-5.0	30.9	74
2070.000000	47.4	100.0	V	98.0	50.5	-3.1	26.6	74
2653.250000	49.1	200.0	V	19.0	48.7	0.4	24.9	74
2882.750000	49.8	100.0	H	173.0	47.6	2.2	24.2	74

Remark: 1. Correction Factor = Antenna factor+ Insertion loss (cable loss + amplifier gain)

Frequency (MHz)	Average (dBuV/m)	Height (cm)	Polarization	Azimuth (deg)	Reading value (dBuV/m)	Correct Factor (dB)	Margin (dB)	Limit (dBuV/m)
1200.000000	31.7	200.0	V	0.0	39.9	-8.2	22.3	54
1399.000000	31.5	100.0	V	185.0	38.6	-7.1	22.5	54
1690.000000	33.0	100.0	H	0.0	38.0	-5.0	21.0	54
2070.000000	37.5	100.0	V	98.0	40.6	-3.1	16.5	54
2653.250000	37.3	200.0	V	19.0	36.9	0.4	16.7	54
2882.750000	37.5	100.0	H	173.0	35.3	2.2	16.5	54

Remark: 1. Correction Factor = Antenna factor+ Insertion loss (cable loss + amplifier gain)

Zigbee CH26

RE 1G-3GHz PK+AV

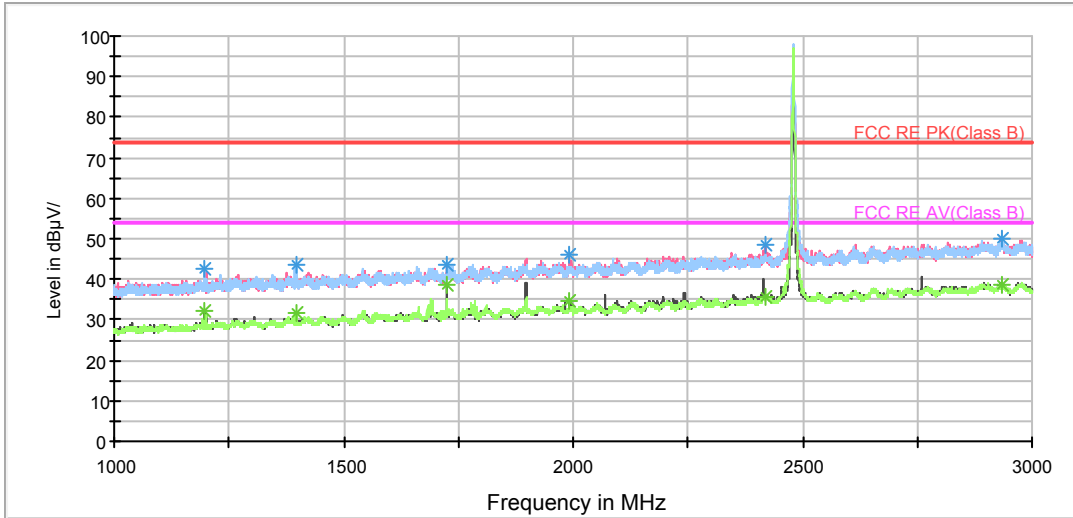

Note: The signal beyond the limit is carrier.
Radiates Emission from 1GHz to 3GHz

RE 3-18GHz PK+AV

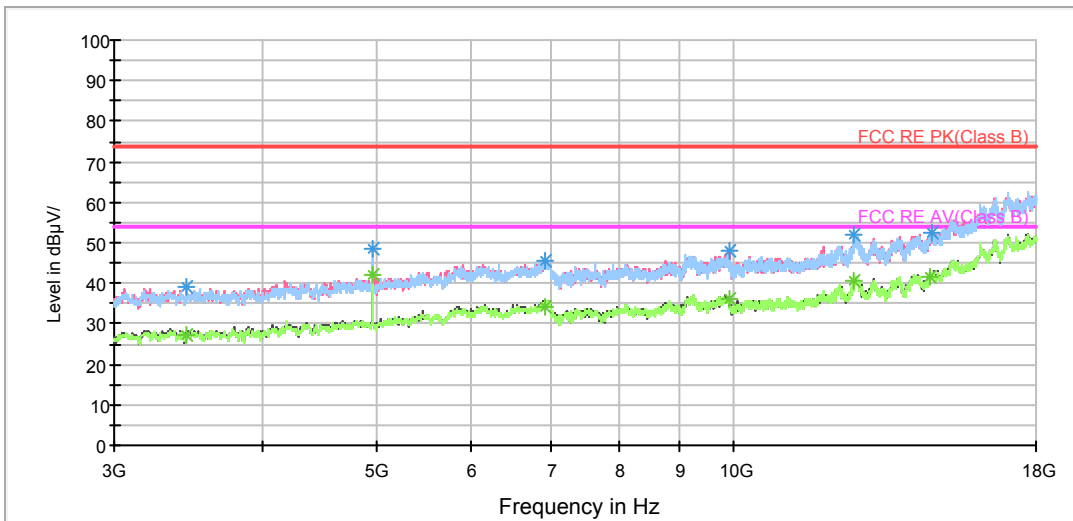

Radiates Emission from 3GHz to 18GHz

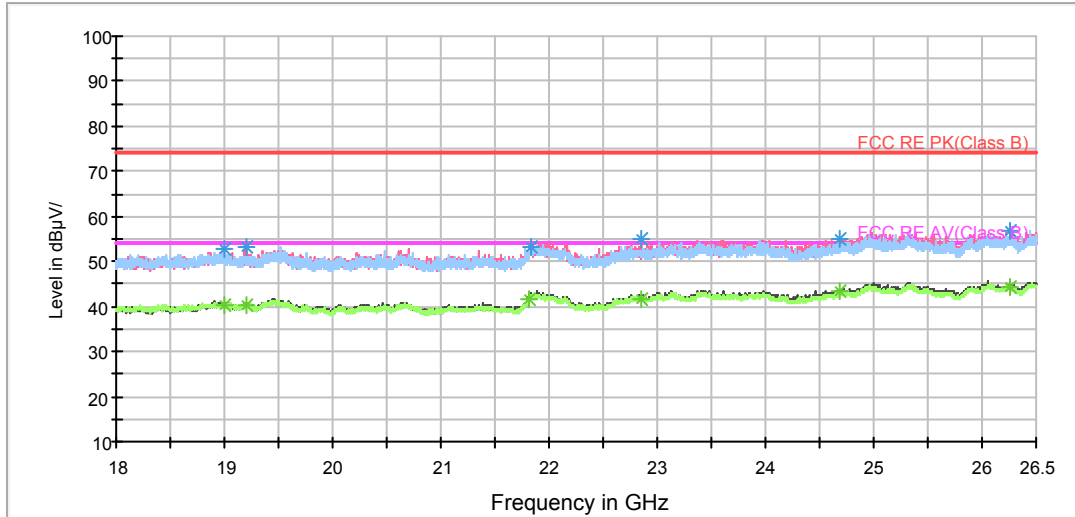

Radiates Emission from 18GHz to 26.5GHz

Frequency (MHz)	Peak (dBuV/m)	Height (cm)	Polarization	Azimuth (deg)	Reading value (dBuV/m)	Correct Factor (dB)	Margin (dB)	Limit (dBuV/m)
1197.250000	42.5	100.0	H	327.0	50.7	-8.2	31.5	74
1397.000000	43.6	100.0	H	103.0	50.7	-7.1	30.4	74
1724.750000	43.8	200.0	V	64.0	48.8	-5.0	30.2	74
1993.000000	45.9	200.0	V	356.0	49.2	-3.3	28.1	74
2419.250000	48.5	100.0	V	0.0	49.1	-0.6	25.5	74
2934.250000	50.1	200.0	H	207.0	48.3	1.8	23.9	74

Remark: 1. Correction Factor = Antenna factor+ Insertion loss (cable loss + amplifier gain)

Frequency (MHz)	Average (dBuV/m)	Height (cm)	Polarization	Azimuth (deg)	Reading value (dBuV/m)	Correct Factor (dB)	Margin (dB)	Limit (dBuV/m)
1198.000000	32.3	200.0	V	12.0	40.5	-8.2	21.7	54
1397.000000	31.7	100.0	H	103.0	38.8	-7.1	22.3	54
1725.000000	38.5	200.0	V	64.0	43.5	-5.0	15.5	54
1993.000000	34.5	200.0	V	356.0	37.8	-3.3	19.5	54
2419.250000	35.7	100.0	V	0.0	36.3	-0.6	18.3	54
2934.250000	38.4	200.0	H	207.0	36.6	1.8	15.6	54

Remark: 1. Correction Factor = Antenna factor+ Insertion loss (cable loss + amplifier gain)

5.8. Conducted Emission

Ambient condition

Temperature	Relative humidity	Pressure
23°C ~25°C	45%~50%	101.5kPa

Methods of Measurement

The EUT is placed on a non-metallic table of 80cm height above the horizontal metal reference ground plane. During the test, the EUT was operating in its typical mode. The test method is according to ANSI C63.10-2013. Connect the AC power line of the EUT to the L.I.S.N. Use EMI receiver to detect the average and Quasi-peak value. RBW is set to 9 kHz, VBW is set to 30kHz. The measurement result should include both L line and N line.

The test is in transmitting mode.

Test Setup

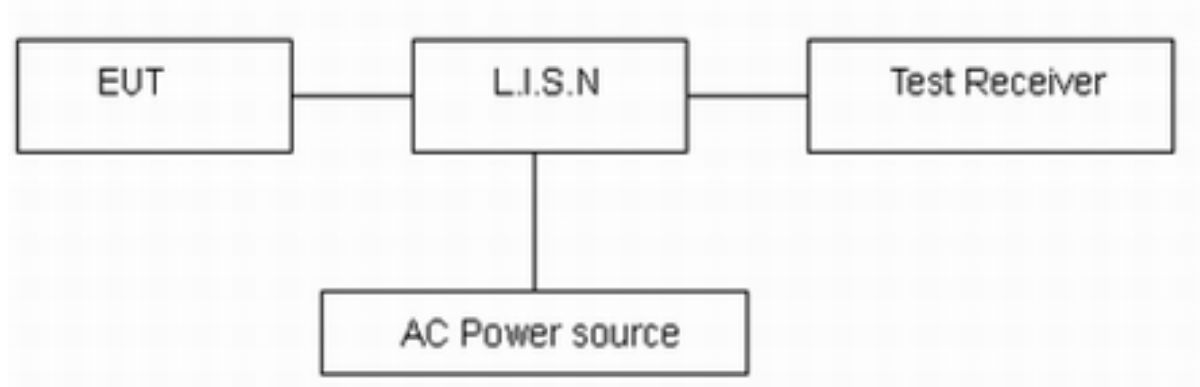

Note: AC Power source is used to change the voltage 110V/60Hz.

Limits

Frequency (MHz)	Conducted Limits(dBμV)	
	Quasi-peak	Average
0.15 - 0.5	66 to 56 *	56 to 46*
0.5 - 5	56	46
5 - 30	60	50

*: Decreases with the logarithm of the frequency.

Measurement Uncertainty

The assessed measurement uncertainty to ensure 95% confidence level for the normal distribution is with the coverage factor $k = 1.96$, $U = 2.69$ dB.

Test Results:

Following plots, Blue trace uses the peak detection; Green trace uses the average detection.

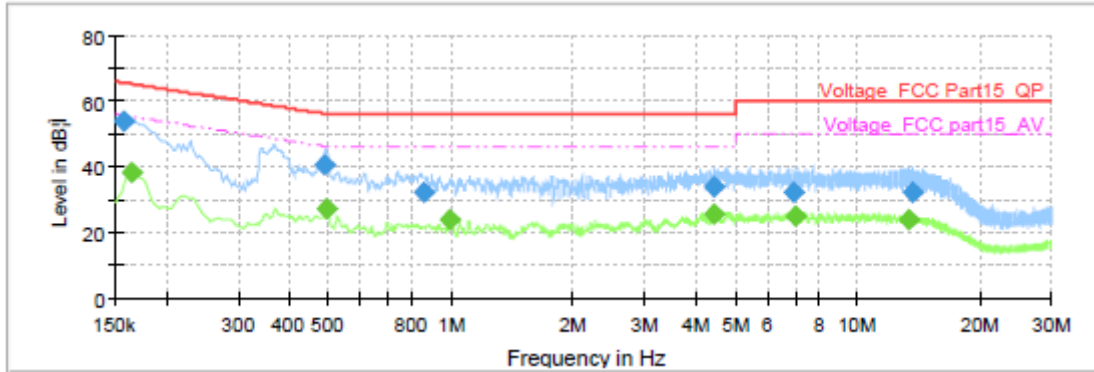

Frequency (MHz)	QuasiPeak (dB; i V)	Average (dB; i V)	Limit (dB; i V)	Margin (dB)	Meas. Time (ms)	Bandwidth (kHz)	Line	Filter	Corr. (dB)
0.156750	54.01	---	65.63	11.62	1000.0	9.000	L1	ON	19.6
0.163500	---	38.10	55.28	17.18	1000.0	9.000	L1	ON	19.6
0.489750	40.47	---	56.17	15.70	1000.0	9.000	L1	ON	19.6
0.496500	---	26.95	46.06	19.11	1000.0	9.000	L1	ON	19.6
0.854250	31.98	---	56.00	24.02	1000.0	9.000	L1	ON	19.6
0.991500	---	24.06	46.00	21.94	1000.0	9.000	L1	ON	19.6
4.425000	33.84	---	56.00	22.16	1000.0	9.000	L1	ON	19.7
4.449750	---	25.29	46.00	20.71	1000.0	9.000	L1	ON	19.7
6.987750	32.33	---	60.00	27.67	1000.0	9.000	L1	ON	19.7
7.068750	---	25.21	50.00	24.79	1000.0	9.000	L1	ON	19.7
13.285500	---	24.08	50.00	25.92	1000.0	9.000	L1	ON	19.9
13.629750	32.23	---	60.00	27.77	1000.0	9.000	L1	ON	20.0

L Line

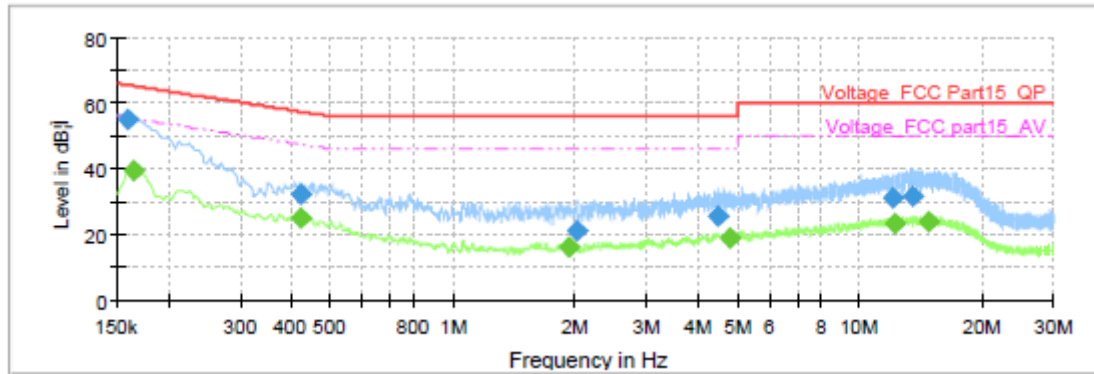

Frequency (MHz)	QuasiPeak (dB; i V)	Average (dB; i V)	Limit (dB; i V)	Margin (dB)	Meas. Time (ms)	Bandwidth (kHz)	Line	Filter	Corr. (dB)
0.159000	54.84	---	65.52	10.68	1000.0	9.000	N	ON	19.7
0.163500	---	39.32	55.28	15.96	1000.0	9.000	N	ON	19.7
0.422250	---	24.83	47.40	22.57	1000.0	9.000	N	ON	19.6
0.422250	32.17	---	57.40	25.23	1000.0	9.000	N	ON	19.6
1.932000	---	16.00	46.00	30.00	1000.0	9.000	N	ON	19.6
2.010750	20.88	---	56.00	35.12	1000.0	9.000	N	ON	19.6
4.465500	25.45	---	56.00	30.55	1000.0	9.000	N	ON	19.7
4.809750	---	19.13	46.00	26.87	1000.0	9.000	N	ON	19.7
12.090750	31.12	---	60.00	28.88	1000.0	9.000	N	ON	19.9
12.156000	---	23.43	50.00	26.57	1000.0	9.000	N	ON	19.9
13.452000	31.68	---	60.00	28.32	1000.0	9.000	N	ON	19.9
14.716500	---	23.99	50.00	26.01	1000.0	9.000	N	ON	19.9

N Line



6. Main Test Instruments

Name	Manufacturer	Type	Serial Number	Calibration Date	Expiration Date
Spectrum Analyzer	R&S	FSV30	100815	2017-12-17	2018-12-16
EMI Test Receiver	R&S	ESCI	100948	2017-05-20	2018-05-19
TRILOG Broadband Antenna	Schwarzbeck	VULB 9163	9163-201	2017-11-18	2020-11-17
Double Ridged Waveguide Horn Antenna	R&S	HF907	100126	2014-12-06	2019-12-05
Loop Antenna	SCHWARZBECK	FMZB1519	1519-047	2017-02-18	2020-02-17
Standard Gain Horn	ETS-Lindgren	3160-09	00102644	2015-01-30	2020-01-29
EMI Test Receiver	R&S	ESCS30	100138	2017-12-17	2018-12-16
LISN	R&S	ENV216	101171	2016-12-16	2019-12-15
Spectrum Analyzer	Agilent	N9010A	MY47191109	2017-05-20	2018-05-19
RF Cable	Agilent	SMA 15cm	0001	/	/

*****END OF REPORT *****

ANNEX A: EUT Appearance and Test Setup

A.1 EUT Appearance



Picture 1 EUT

A.2 Test Setup



30M Hz-1GHz

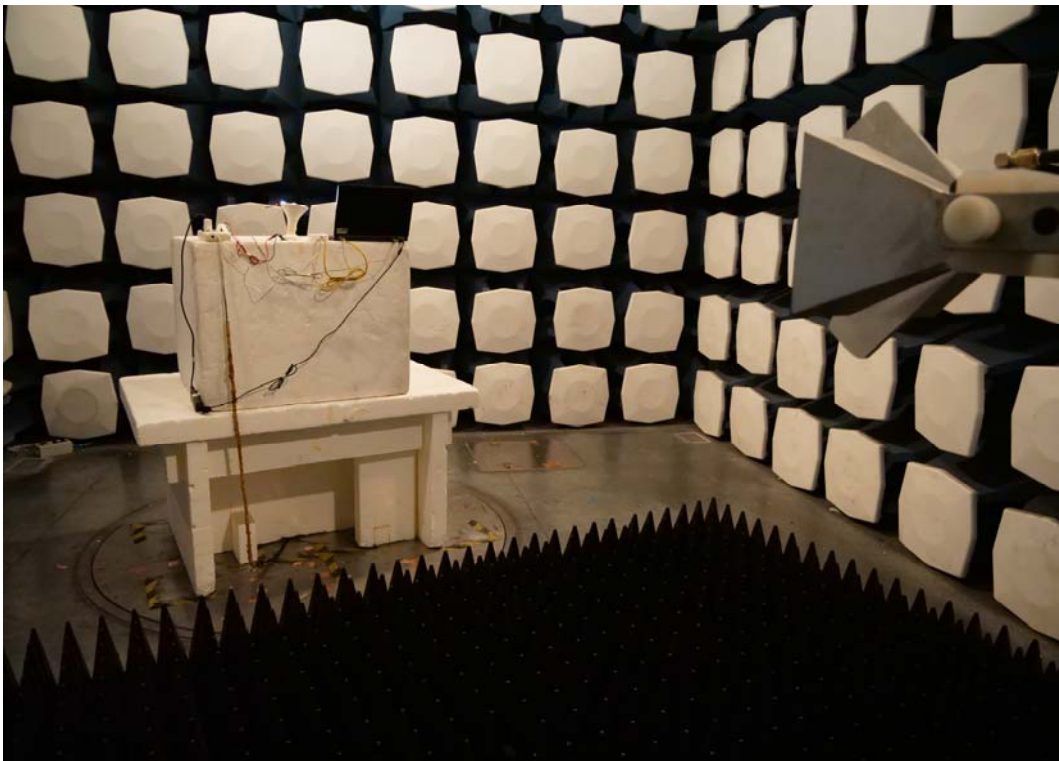

Above 1GHz

Picture 2 Radiated Emission Test Setup



Picture 3 Conducted Emission Test Setup