



# RF TEST REPORT

**Applicant** Sengled Co., Ltd.  
**FCC ID** 2AGN8-E12N1E  
**Product** sengled element  
**Brand** sengled  
**Model** E12-N1E  
**Report No.** R1808A0395-R1V2  
**Issue Date** September 21, 2018

TA Technology (Shanghai) Co., Ltd. tested the above equipment in accordance with the requirements in **FCC CFR47 Part 15C (2018)**. The test results show that the equipment tested is capable of demonstrating compliance with the requirements as documented in this report.

Performed by: Peng Tao

Approved by: Kai Xu

---

## TA Technology (Shanghai) Co., Ltd.

No.145, Jintang Rd, Tangzhen Industry Park, Pudong Shanghai, China

TEL: +86-021-50791141/2/3

FAX: +86-021-50791141/2/3-8000



# TABLE OF CONTENT

- 1. Test Laboratory ..... 4
  - 1.1. Notes of the test report..... 4
  - 1.2. Test facility ..... 4
  - 1.3. Testing Location..... 5
- 2. General Description of Equipment under Test..... 6
- 3. Applied Standards ..... 7
- 4. Test Configuration ..... 8
- 5. Test Case Results ..... 9
  - 5.1. Maximum conducted output power ..... 9
  - 5.2. 6dB Bandwidth ..... 11
  - 5.3. Band Edge ..... 13
  - 5.4. Power Spectral Density ..... 15
  - 5.5. Spurious RF Conducted Emissions..... 17
  - 5.6. Unwanted Emission ..... 19
  - 5.7. Conducted Emission ..... 31
- 6. Main Test Instruments ..... 33
- ANNEX A: EUT Appearance and Test Setup ..... 34
  - A.1 EUT Appearance ..... 34
  - A.2 Test Setup ..... 35



## Summary of measurement results

Number	Summary of measurements of results	Clause in FCC rules	Verdict
1	Maximum conducted output power	15.247(b)(3)	PASS
2	6 dB bandwidth	15.247(a)(2)	PASS
3	Maximum power spectral density	15.247(e)	PASS
4	Band Edge	15.247(d)	PASS
5	Spurious RF Conducted Emissions	15.247(d)	PASS
6	Unwanted Emissions	15.247(d),15.205,15.209	PASS
7	Conducted Emissions	15.207	PASS

Date of Testing: August 25, 2018 ~ September 12, 2018

## 1. Test Laboratory

### 1.1. Notes of the test report

This report shall not be reproduced in full or partial, without the written approval of **TA technology (shanghai) co., Ltd.** The results documented in this report apply only to the tested sample, under the conditions and modes of operation as described herein .Measurement Uncertainties were not taken into account and are published for informational purposes only. This report is written to support regulatory compliance of the applicable standards stated above.

### 1.2. Test facility

#### **CNAS (accreditation number: L2264)**

TA Technology (Shanghai) Co., Ltd. has obtained the accreditation of China National Accreditation Service for Conformity Assessment (CNAS).

#### **FCC (Designation number: CN1179, Test Firm Registration Number: 446626)**

TA Technology (Shanghai) Co., Ltd. has been listed on the US Federal Communications Commission list of test facilities recognized to perform electromagnetic emissions measurements.

#### **IC (recognition number is 8510A)**

TA Technology (Shanghai) Co., Ltd. has been listed by industry Canada to perform electromagnetic emission measurement.

#### **VCCI (recognition number is C-4595, T-2154, R-4113, G-10766)**

TA Technology (Shanghai) Co., Ltd. has been listed by industry Japan to perform electromagnetic emission measurement.

#### **A2LA (Certificate Number: 3857.01)**

TA Technology (Shanghai) Co., Ltd. has been listed by American Association for Laboratory Accreditation to perform electromagnetic emission measurement.



### 1.3. Testing Location

Company: TA Technology (Shanghai) Co., Ltd.  
Address: No.145, Jintang Rd, Tangzhen Industry Park, Pudong  
City: Shanghai  
Post code: 201201  
Country: P. R. China  
Contact: Xu Kai  
Telephone: +86-021-50791141/2/3  
Fax: +86-021-50791141/2/3-8000  
Website: <http://www.ta-shanghai.com>  
E-mail: [xukai@ta-shanghai.com](mailto:xukai@ta-shanghai.com)

## 2. General Description of Equipment under Test

### Client Information

<b>Applicant</b>	Sengled Co., Ltd.
<b>Applicant address</b>	Room 201/15, Building 1, No.498, Guoshoujing Road, Pilot Free Trade Zone, Shanghai City, P.R. China
<b>Manufacturer</b>	Sengled Co., Ltd.
<b>Manufacturer address</b>	Room 201/15, Building 1, No.498, Guoshoujing Road, Pilot Free Trade Zone, Shanghai City, P.R. China

### General information

EUT Description	
Model:	E12-N1E
IMEI:	/
Hardware Version:	V1
Software Version:	V0.0.20
Power Supply:	External Power Supply
Antenna Type:	PCB Antenna
Antenna Connector:	A permanently attached antenna (meet with the standard FCC Part 15.203 requirement)
Test Mode:	Zigbee
Modulation Type:	Zigbee: O-QPSK
Antenna Gain:	2.00 dBi
Max. Conducted Power	7.05 dBm
Operating Frequency Range(s)	2405 ~ 2480 MHz
Note: The information of the EUT is declared by the manufacturer.	



### **3. Applied Standards**

According to the specifications of the manufacturer, it must comply with the requirements of the following standards:

**FCC CFR47 Part 15C (2018) Radio Frequency Devices**

**ANSI C63.10 (2013)**

**KDB 558074 D01 DTS Meas Guidance v05**

## 4. Test Configuration

### Test Mode

The EUT was programmed to be in continuously transmitting mode and the transmit duty cycle is not less than 98%.

The EUT has been associated with peripherals and configuration operated in a manner tended to maximize its emission characteristics in a typical application.

The radiated emission was measured in the following position: EUT stand-up position (Z axis), lie-down position (X, Y axis). The worst emission was found in stand-up position (Z axis) and the worst case was recorded.

Mode	Channel	Frequency
Zigbee	11	2405MHz
	12	2410MHz
	13	2415MHz
	14	2420MHz
	15	2425MHz
	16	2430MHz
	17	2435MHz
	18	2440MHz
	19	2445MHz
	20	2450MHz
	21	2455MHz
	22	2460MHz
	23	2465MHz
	24	2470MHz
	25	2475MHz
	26	2480MHz



## 5. Test Case Results

### 5.1. Maximum conducted output power

#### Ambient condition

Temperature	Relative humidity	Pressure
23°C ~25°C	45%~50%	101.5kPa

#### Methods of Measurement

During the process of the testing, The EUT was connected to Spectrum Analyzer with a known loss. The EUT is max power transmission with proper modulation. The Average detector is used. We use Maximum Average Conducted Output Power Level Method in KDB 558074 D01 for this test.

#### Test Setup

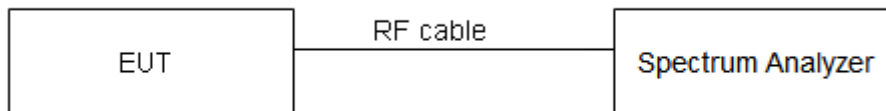

#### Limits

Rule Part 15.247 (b) (3) specifies that " For systems using digital modulation in the 902–928 MHz, 2400–2483.5 MHz: 1 Watt."

Average Output Power	$\leq 1W$ (30dBm)
----------------------	-------------------

#### Measurement Uncertainty

The assessed measurement uncertainty to ensure 95% confidence level for the normal distribution is with the coverage factor  $k = 2$ ,  $U = 0.44$  dB.

**Test Results**

Network Standards	Carrier frequency (MHz)	Read Value (dBm)	Output Power (dBm)	Limit (dBm)	Conclusion
Zigbee	2405	6.67	6.67	30	PASS
	2440	7.05	7.05	30	PASS
	2480	6.94	6.94	30	PASS

## 5.2. 6dB Bandwidth

### Ambient condition

Temperature	Relative humidity	Pressure
23°C ~25°C	45%~50%	101.5kPa

### Method of Measurement

The EUT was connected to the spectrum analyzer through an external attenuator (20dB) and a known loss cable. RBW is set to 100 kHz; VBW is set to 300 kHz on spectrum analyzer.

### Test Setup

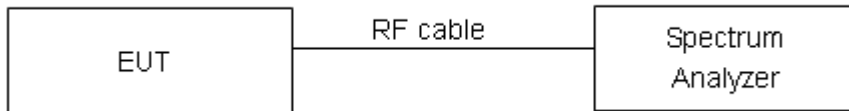

### Limits

Rule Part 15.247 (a) (2) specifies that “Systems using digital modulation techniques may operate in the 902–928 MHz, 2400–2483.5 MHz bands. The minimum 6 dB bandwidth shall be at least 500 kHz.”

minimum 6 dB bandwidth	≥ 500 kHz
------------------------	-----------

### Measurement Uncertainty

The assessed measurement uncertainty to ensure 95% confidence level for the normal distribution is with the coverage factor  $k = 2$ ,  $U = 936$  Hz.

**Test Results:**

Network Standards	Carrier frequency (MHz)	99% bandwidth (MHz)	Minimum 6 dB bandwidth (MHz)	Limit (kHz)	Conclusion
Zigbee	2405	2.4138	1.618	500	PASS
	2440	2.4263	1.573	500	PASS
	2480	2.4090	1.578	500	PASS

Zigbee, Carrier frequency (MHz): 2405

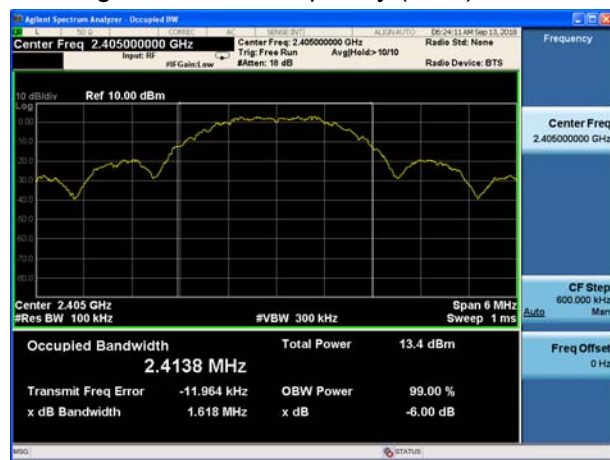

Zigbee, Carrier frequency (MHz): 2440



Zigbee, Carrier frequency (MHz): 2480



### 5.3. Band Edge

#### Ambient condition

Temperature	Relative humidity	Pressure
23°C ~25°C	45%~50%	101.5kPa

#### Method of Measurement

The EUT was connected to the spectrum analyzer through an external attenuator (20dB) and a known loss cable the band edge of the lowest and highest channels were measured. The peak detector is used and RBW is set to 100 kHz and VBW is set to 300 kHz on spectrum analyzer. Spectrum analyzer plots are included on the following pages.

#### Test Setup

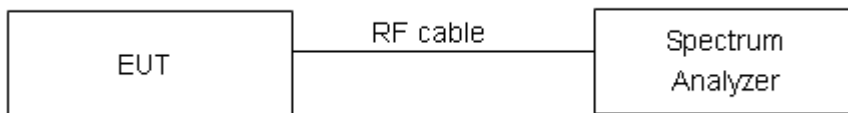

#### Limits

Rule Part 15.247(d) specifies that “In any 100 kHz bandwidth outside the frequency band in which the spread spectrum or digitally modulated intentional radiator is operating, the radio frequency power that is produced by the intentional radiator shall be at least 20 dB below that in the 100 kHz bandwidth within the band that contains the highest level of the desired power, based on either an RF conducted or a radiated measurement, provided the transmitter demonstrates compliance with the peak conducted power limits.” If the transmitter complies with the conducted power limits based on the use of RMS averaging over a time interval, as permitted under paragraph (b)(3) of this section, the attenuation required under this paragraph shall be 30 dB instead of 20 dB.”

#### Measurement Uncertainty

The assessed measurement uncertainty to ensure 95% confidence level for the normal distribution is with the coverage factor  $k = 1.96$ .

Frequency	Uncertainty
2GHz-3GHz	1.407 dB



Test Results: PASS

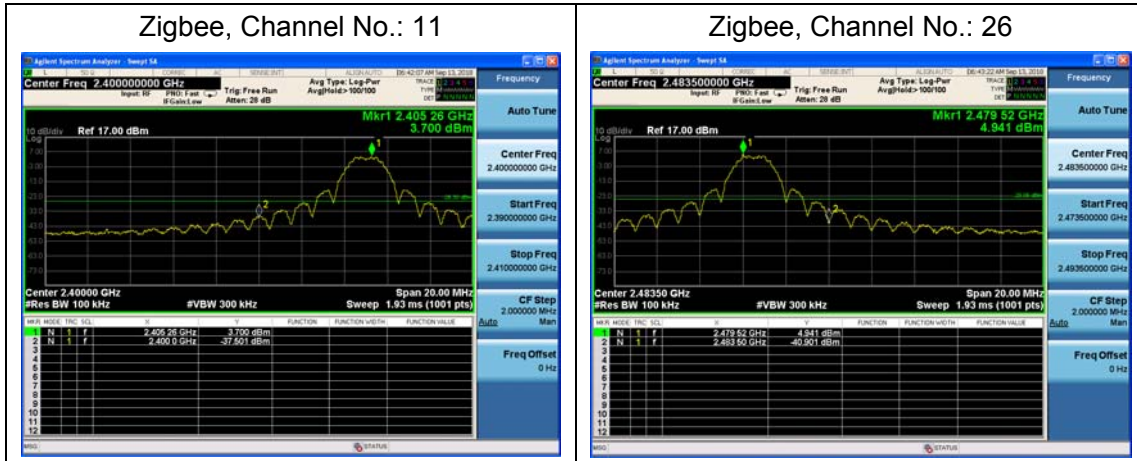

### 5.4. Power Spectral Density

#### Ambient condition

Temperature	Relative humidity	Pressure
23°C ~25°C	45%~50%	101.5kPa

#### Method of Measurement

The EUT was connected to the spectrum analyzer through an external attenuator (20dB) and a known loss cable.

RBW is set to 3 kHz and VBW is set to 10 kHz for Zigbee on spectrum analyzer.

Set the span to 1.5 times the DTS channel bandwidth. Sweep time = auto couple. Trace mode = max hold. The peak power spectral density is recorded.

#### Test setup

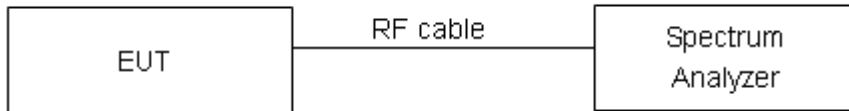

#### Limits

Rule Part 15.247(e) specifies that” For digitally modulated systems, the power spectral density conducted from the intentional radiator to the antenna shall not be greater than 8 dBm in any 3 kHz band during any time interval of continuous transmission. ”

Limits	≤ 8 dBm / 3kHz
--------	----------------

#### Measurement Uncertainty

The assessed measurement uncertainty to ensure 95% confidence level for the normal distribution is with the coverage factor  $k = 2$ ,  $U = 0.75\text{dB}$ .



**Test Results:**

Network Standards	Channel Number	Read Value (dBm / 3kHz)	Power Spectral Density (dBm / 3kHz)	Limit (dBm / 3kHz)	Conclusion
Zigbee	11	-17.85	-17.85	8	PASS
	18	-17.19	-17.19	8	PASS
	26	-17.24	-17.24	8	PASS

Zigbee, Channel No.: 11



Zigbee, Channel No.: 18



Zigbee, Channel No.: 26





### 5.5. Spurious RF Conducted Emissions

#### Ambient condition

Temperature	Relative humidity	Pressure
23°C ~25°C	45%~50%	101.5kPa

#### Method of Measurement

The EUT was connected to the spectrum analyzer with a known loss. The spectrum analyzer scans from 30MHz to the 10th harmonic of the carrier. The peak detector is used. Set RBW to 100kHz and VBW to 300 kHz, Sweep is set to ATUO.

The test is in transmitting mode.

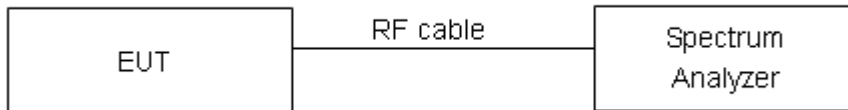

#### Limits

Rule Part 15.247(d) pacifies that “In any 100 kHz bandwidth outside the frequency band in which the spread spectrum intentional radiator is operating, the radio frequency power that is produced by the intentional radiator shall be at least 30 dB below that in the 100 kHz bandwidth within the band that contains the highest level of the desired power.” If the transmitter complies with the conducted power limits based on the use of RMS averaging over a time interval, as permitted under paragraph (b)(3) of this section, the attenuation required under this paragraph shall be 30 dB instead of 20 dB.”

Network Standards	Carrier frequency (MHz)	Reference value (dBm)	Limit
Zigbee	2405	-8.35	-28.35
	2440	-7.84	-27.84
	2480	-7.99	-27.99

#### Measurement Uncertainty

The assessed measurement uncertainty to ensure 95% confidence level for the normal distribution is with the coverage factor  $k = 1.96$ .

Frequency	Uncertainty
100kHz-2GHz	0.684 dB
2GHz-26GHz	1.407 dB



Test Results:

The signal beyond the limit is carrier.

Zigbee CH11

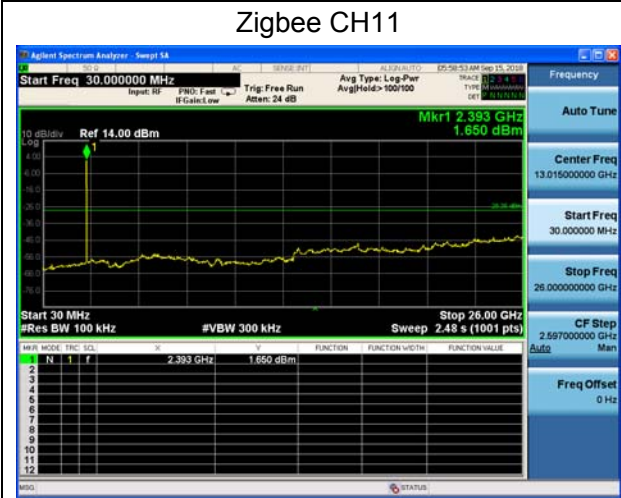

Zigbee CH18

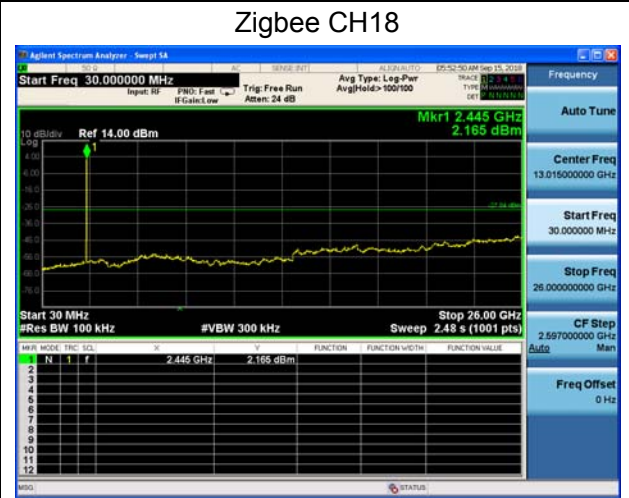

Zigbee CH26

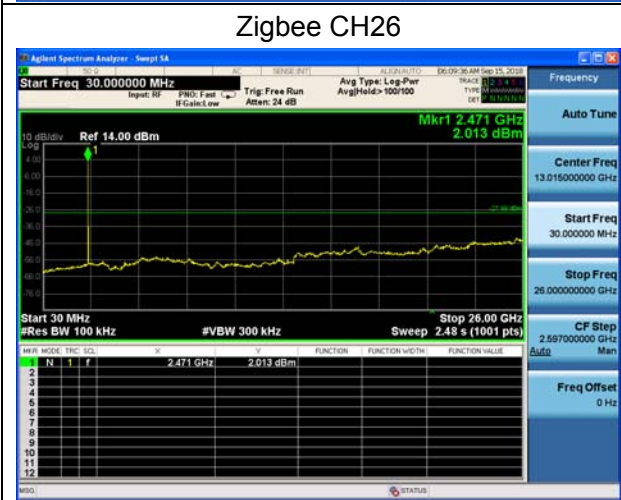

## 5.6. Unwanted Emission

### Ambient condition

Temperature	Relative humidity	Pressure
23°C ~25°C	45%~50%	101.5kPa

### Method of Measurement

The test set-up was made in accordance to the general provisions of ANSI C63.10-2013. The Equipment Under Test (EUT) was set up on a non-conductive table in the semi-anechoic chamber. The test was performed at the distance of 3 m between the EUT and the receiving antenna.

The turntable shall be rotated from 0 to 360 degrees for detecting the maximum of radiated spurious signal level. The measurements shall be repeated with orthogonal polarization of the test antenna. RBW is set to 100kHz. The data of cable loss and antenna factor has been calibrated in full testing frequency range before the testing. Sweep the whole frequency band through the range from 9kHz to the 10th harmonic of the carrier, and the emissions less than 20 dB below the permissible value are reported.

The radiated emissions measurements were made in a typical installation configuration. Sweep the whole frequency band through the range from 9 kHz to the 10th harmonic of the carrier, and the emissions less than 20 dB below the permissible value are reported.

Set the spectrum analyzer in the following:

- (a) PEAK: RBW=VBW=3MHz / Sweep=AUTO
- (b) AVERAGE: RBW=1MHz / VBW=3MHz / Sweep=AUTO

This setting method can refer to ANSI C63.10-2013.

During the test, below 30MHz, the center of the loop shall be 1 meters; above 30MHz, the height of receive antenna shall be moved from 1 to 4 meters, and the antenna shall be performed under horizontal and vertical polarization.

The data of cable loss and antenna factor has been calibrated in full testing frequency range before the testing.

Set the spectrum analyzer in the following:

Below 1GHz (detector: Peak and Quasi-Peak)  
RBW=100 kHz / VBW=300 kHz / Sweep=AUTO

Above 1GHz (detector: Peak):

- (a) PEAK: RBW=1MHz VBW=3MHz/ Sweep=AUTO
- (b) AVERAGE: RBW=1MHz / VBW=3MHz / Sweep=AUTO

The radiated emission was measured in the following position: EUT stand-up position (Z axis), lie-down position (X, Y axis). The worst emission was found in stand-up position (Z axis) and the worst case was recorded.

The test is in transmitting mode.

**Test setup**

**9KHz~~~ 30MHz**

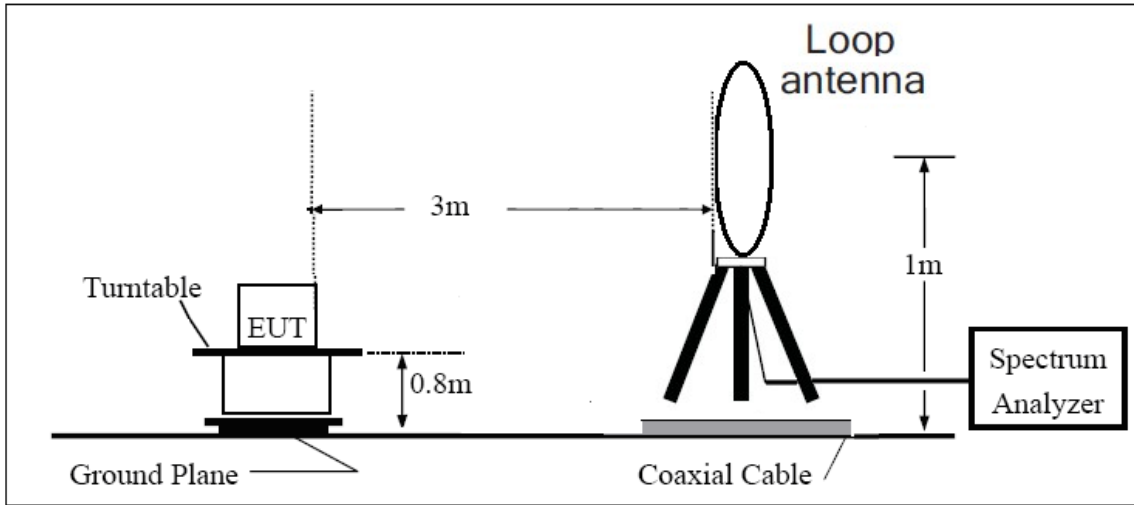

**30MHz~~~ 1GHz**

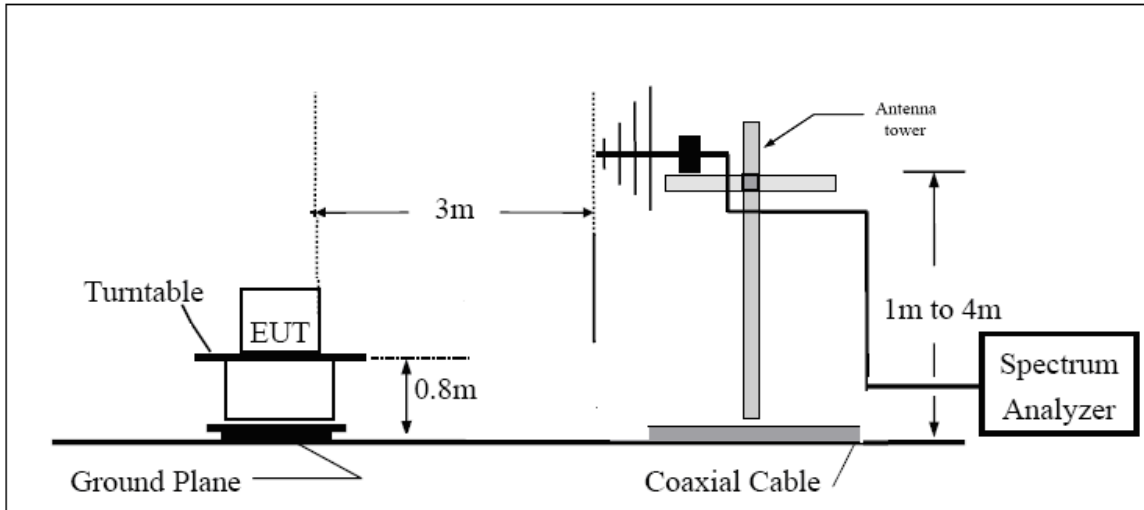

**Above 1GHz**

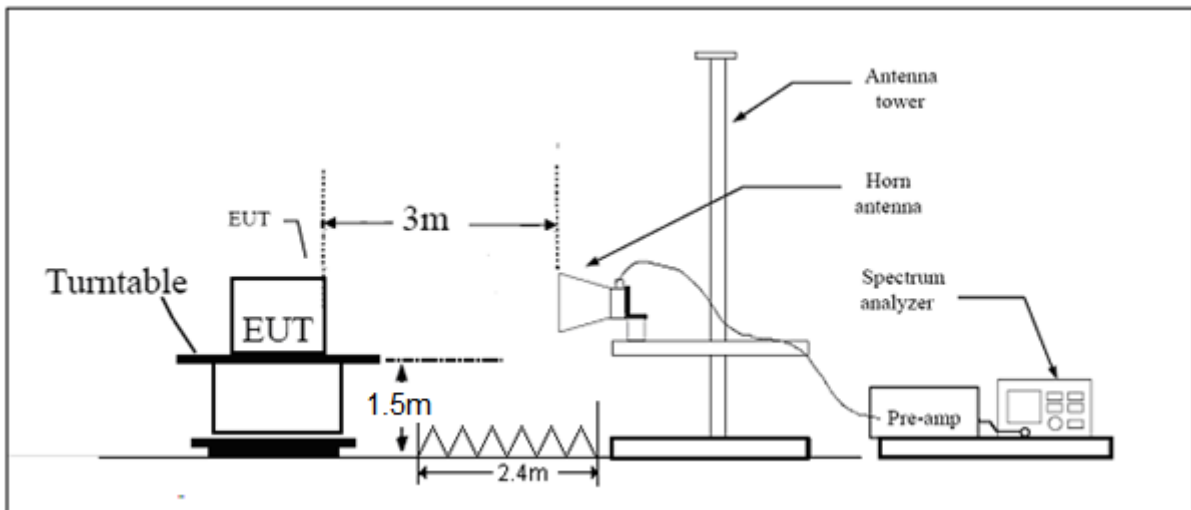

Note: Area side:2.4mX3.6m

**Limits**

Rule Part 15.247(d) specifies that “In addition, radiated emissions which fall in the restricted bands, as defined in § 15.205(a), must also comply with the radiated emission limits specified in § 15.209(a) (see § 15.205(c)).”

Limit in restricted band

Frequency of emission (MHz)	Field strength(uV/m)	Field strength(dBuV/m)
0.009–0.490	2400/F(kHz)	/
0.490–1.705	24000/F(kHz)	/
1.705–30.0	30	/
30-88	100	40
88-216	150	43.5
216-960	200	46
Above960	500	54

§15.35(b)

There is also a limit on the radio frequency emissions, as measured using instrumentation with a peak detector function, corresponding to 20 dB above the maximum permitted average limit.

Peak Limit=74 dBuV/m

Average Limit=54 dBuV/m

Spurious Radiated Emissions are permitted in any of the frequency bands listed below:

MHz	MHz	MHz	GHz
0.090 - 0.110	16.42 - 16.423	399.9 - 410	4.5 - 5.15
<sup>1</sup> 0.495 - 0.505	16.69475 - 16.69525	608 - 614	5.35 - 5.46
2.1735 - 2.1905	16.80425 - 16.80475	960 - 1240	7.25 - 7.75
4.125 - 4.128	25.5 - 25.67	1300 - 1427	8.025 - 8.5
4.17725 - 4.17775	37.5 - 38.25	1435 - 1626.5	9.0 - 9.2
4.20725 - 4.20775	73 - 74.6	1645.5 - 1646.5	9.3 - 9.5
6.215 - 6.218	74.8 - 75.2	1660 - 1710	10.6 - 12.7
6.26775 - 6.26825	108 - 121.94	1718.8 - 1722.2	13.25 - 13.4
6.31175 - 6.31225	123 - 138	2200 - 2300	14.47 - 14.5
8.291 - 8.294	149.9 - 150.05	2310 - 2390	15.35 - 16.2
8.362 - 8.366	156.52475 - 156.52525	2483.5 - 2500	17.7 - 21.4
8.37625 - 8.38675	156.7 - 156.9	2690 - 2900	22.01 - 23.12
8.41425 - 8.41475	162.0125 - 167.17	3260 - 3267	23.6 - 24.0
12.29 - 12.293	167.72 - 173.2	3332 - 3339	31.2 - 31.8
12.51975 - 12.52025	240 - 285	3345.8 - 3358	36.43 - 36.5
12.57675 - 12.57725	322 - 335.4	3600 - 4400	( <sup>2</sup> )
13.36 - 13.41			

### Measurement Uncertainty

The assessed measurement uncertainty to ensure 95% confidence level for the normal distribution is with the coverage factor  $k = 1.96$ .

Frequency	Uncertainty
9KHz-30MHz	3.55 dB
30MHz-200MHz	4.19 dB
200MHz-1GHz	3.63 dB
Above 1GHz	3.68 dB

**Test Results:**

The signal beyond the limit is carrier.

Zigbee-Channel 11: Peak

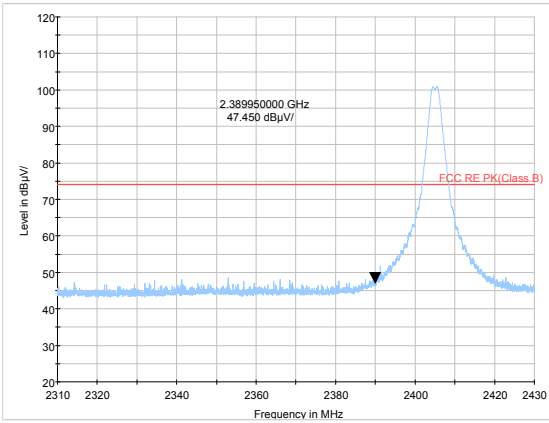

Zigbee-Channel 11: Average

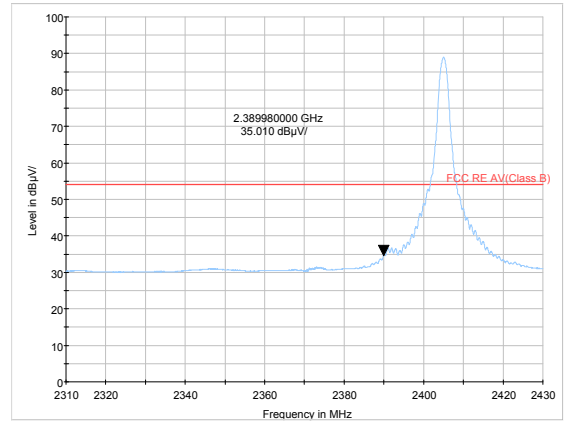

Zigbee-Channel 26: Peak

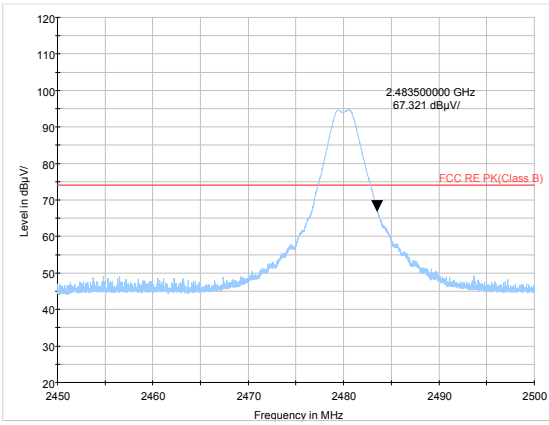

Zigbee-Channel 26: Average

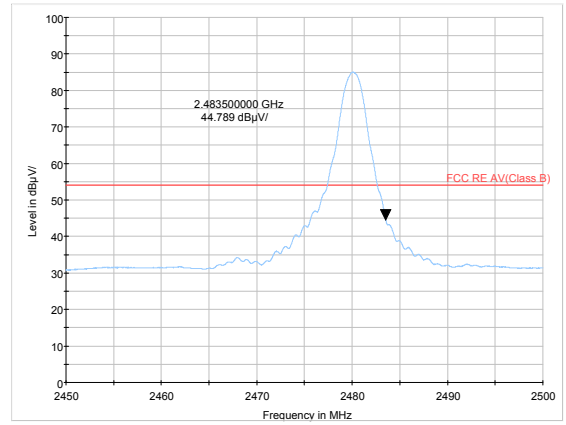

**Result of RE**

**Test result**

Sweep the whole frequency band through the range from 9kHz to the 10th harmonic of the carrier, the Emissions in the frequency band 9kHz-30MHz and 18GHz-26.5GHz are more than 20dB below the limit are not reported.

The following graphs display the maximum values of horizontal and vertical by software. For above 1GHz, Blue trace uses the peak detection, Green trace uses the average detection.

During the test, the Radiates Emission from 30MHz to 1GHz was performed in all modes with all channels, Zigbee, Channel 11 are selected as the worst condition. The test data of the worst-case condition was recorded in this report.

**Continuous TX mode:**

RE 30M-1GHz QP

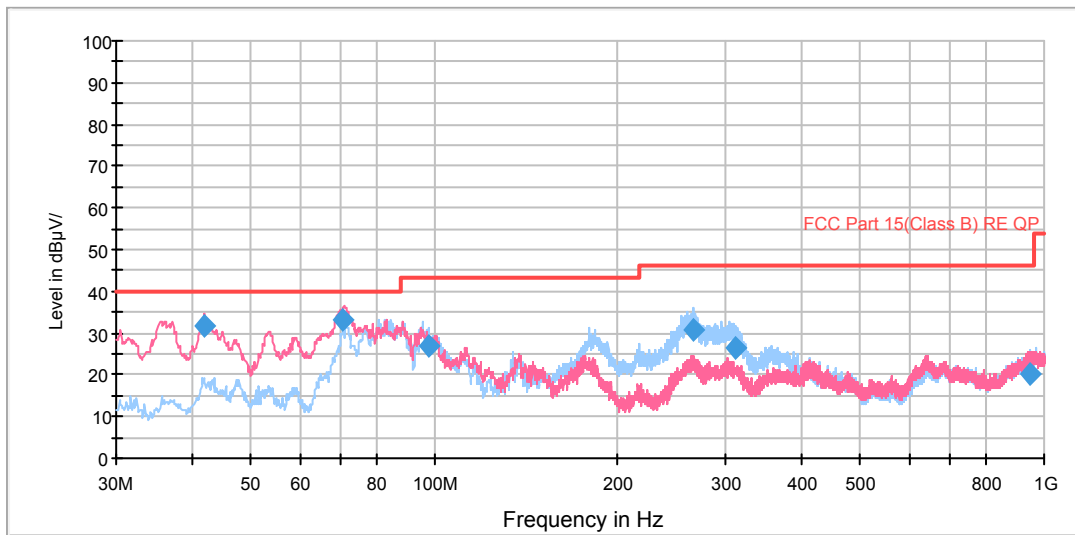

Radiates Emission from 30MHz to 1GHz

Frequency (MHz)	Quasi-Peak (dBuV/m)	Reading value (dBuV/m)	Height (cm)	Polarization	Azimuth (deg)	Correct Factor (dB)	Margin (dB)	Limit (dBuV/m)
41.987206	31.6	49.7	100.0	V	111.0	-18.1	8.4	40.0
70.845044	33.2	59.9	220.0	V	99.0	-26.7	6.8	40.0
97.780091	26.7	50.5	225.0	H	317.0	-23.8	16.8	43.5
265.160000	30.7	55.0	100.0	H	214.0	-24.3	15.3	46.0
312.011000	26.5	48.7	100.0	H	214.0	-22.2	19.5	46.0
948.133000	20.0	30.6	195.0	H	22.0	-10.6	26.0	46.0

- Remark:**
1. Quasi-Peak = Reading value + Correction factor
  2. Correction Factor = Antenna factor+ Insertion loss(cable loss+amplifier gain)
  3. Margin = Limit – Quasi-Peak



Zigbee CH11

RE 1G-3GHz PK+AV

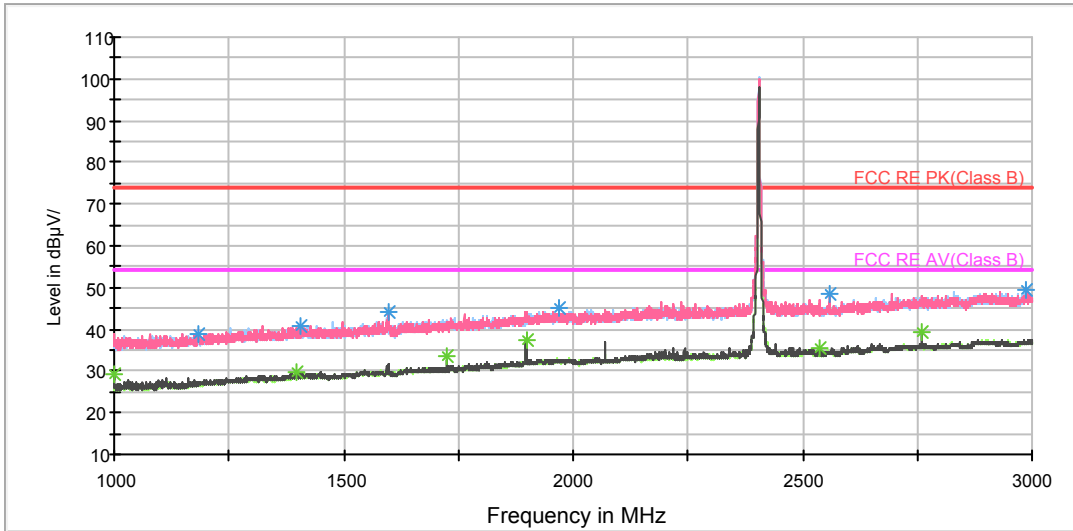

Note: The signal beyond the limit is carrier.  
Radiates Emission from 1GHz to 3GHz

RE 3-18GHz PK+AV

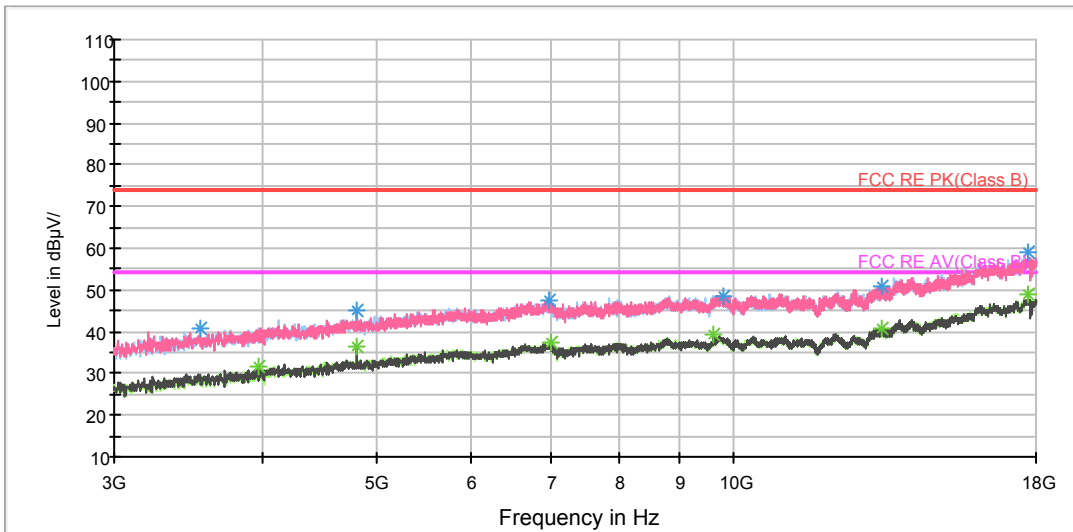

Radiates Emission from 3GHz to 18GHz



Frequency (MHz)	Peak (dBuV/m)	Height (cm)	Polarization	Azimuth (deg)	Reading value (dBuV/m)	Correct Factor (dB)	Margin (dB)	Limit (dBuV/m)
1183.250000	39.1	200.0	V	321.0	47.9	-8.8	34.9	74
1405.750000	41.0	200.0	H	16.0	48.7	-7.7	33.0	74
1597.500000	44.0	200.0	V	0.0	50.7	-6.7	30.0	74
1967.750000	45.1	100.0	H	320.0	48.2	-3.1	28.9	74
2560.250000	48.5	200.0	V	196.0	49.7	-1.2	25.5	74
2988.750000	49.6	200.0	V	344.0	48.2	1.4	24.4	74

Remark: 1. Correction Factor = Antenna factor+ Insertion loss (cable loss + amplifier gain)

Frequency (MHz)	Average (dBuV/m)	Height (cm)	Polarization	Azimuth (deg)	Reading value (dBuV/m)	Correct Factor (dB)	Margin (dB)	Limit (dBuV/m)
1000.750000	29.2	200.0	V	148.0	39.4	-10.2	24.8	54
1397.250000	29.9	200.0	V	179.0	37.6	-7.7	24.1	54
1725.250000	33.8	200.0	H	166.0	38.9	-5.1	20.2	54
1897.500000	37.3	200.0	V	130.0	40.9	-3.6	16.7	54
2538.000000	35.4	200.0	V	184.0	36.4	-1.0	18.6	54
2760.250000	39.5	100.0	V	114.0	39.4	0.1	14.5	54

Remark: 1. Correction Factor = Antenna factor+ Insertion loss (cable loss + amplifier gain)

Zigbee CH18

RE 1G-3GHz PK+AV

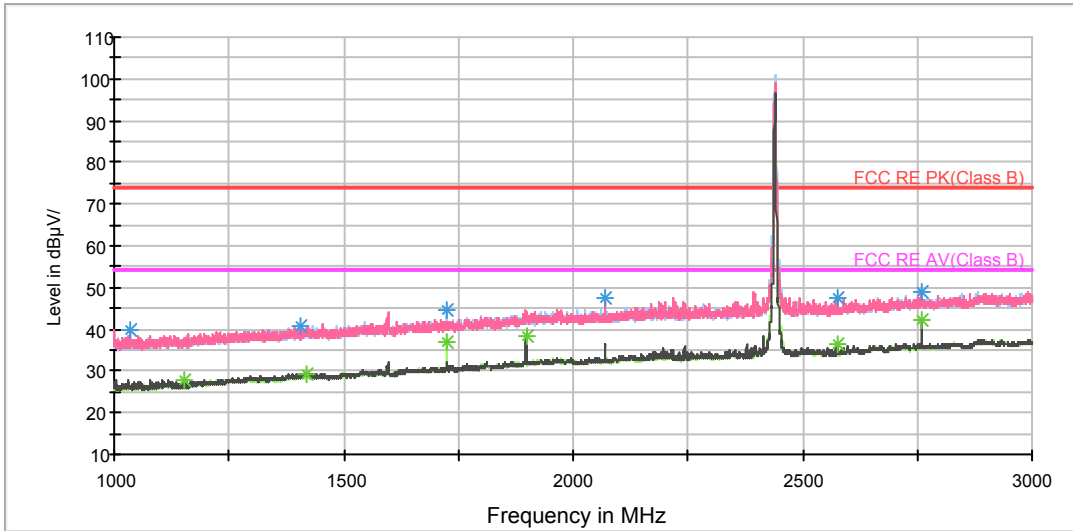

Note: The signal beyond the limit is carrier.  
Radiates Emission from 1GHz to 3GHz

RE 3-18GHz PK+AV

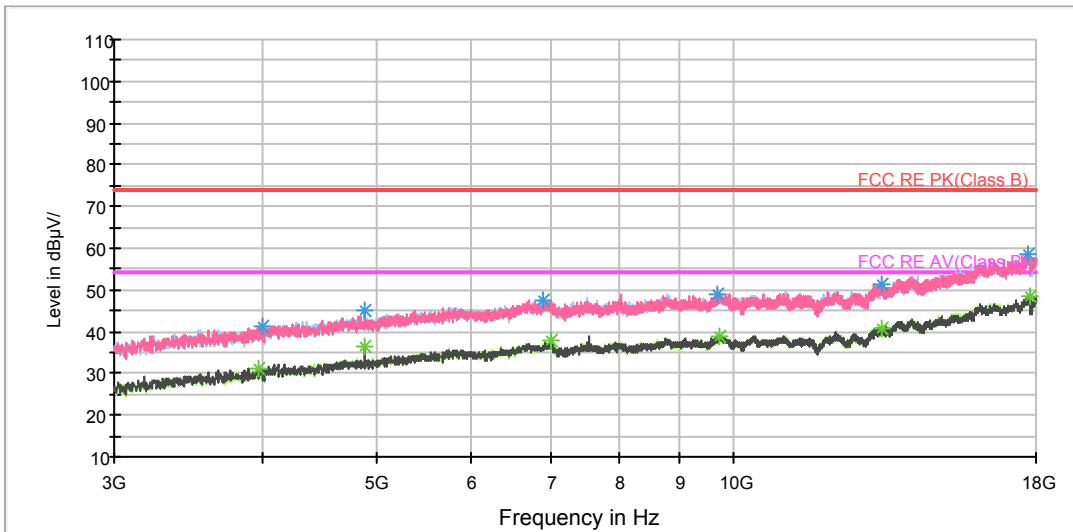

Radiates Emission from 3GHz to 18GHz



Frequency (MHz)	Peak (dBuV/m)	Height (cm)	Polarization	Azimuth (deg)	Reading value (dBuV/m)	Correct Factor (dB)	Margin (dB)	Limit (dBuV/m)
1035.000000	39.7	100.0	V	198.0	49.7	-10.0	34.3	74
1406.500000	40.7	100.0	H	349.0	48.4	-7.7	33.3	74
1724.500000	44.7	200.0	H	153.0	49.8	-5.1	29.3	74
2069.500000	47.4	200.0	V	313.0	50.2	-2.8	26.6	74
2575.000000	47.4	200.0	V	186.0	48.7	-1.3	26.6	74
2760.500000	49.2	100.0	V	135.0	49.1	0.1	24.8	74

Remark: 1. Correction Factor = Antenna factor+ Insertion loss (cable loss + amplifier gain)

Frequency (MHz)	Average (dBuV/m)	Height (cm)	Polarization	Azimuth (deg)	Reading value (dBuV/m)	Correct Factor (dB)	Margin (dB)	Limit (dBuV/m)
1152.000000	27.8	100.0	V	0.0	37.1	-9.3	26.2	54
1418.750000	29.4	100.0	V	347.0	36.9	-7.5	24.6	54
1724.750000	37.1	200.0	H	153.0	42.2	-5.1	16.9	54
1897.500000	38.1	200.0	V	250.0	41.7	-3.6	15.9	54
2575.250000	36.5	200.0	V	186.0	37.8	-1.3	17.5	54
2760.250000	42.4	200.0	V	144.0	42.3	0.1	11.6	54

Remark: 1. Correction Factor = Antenna factor+ Insertion loss (cable loss + amplifier gain)

Zigbee CH26

RE 1G-3GHz PK+AV

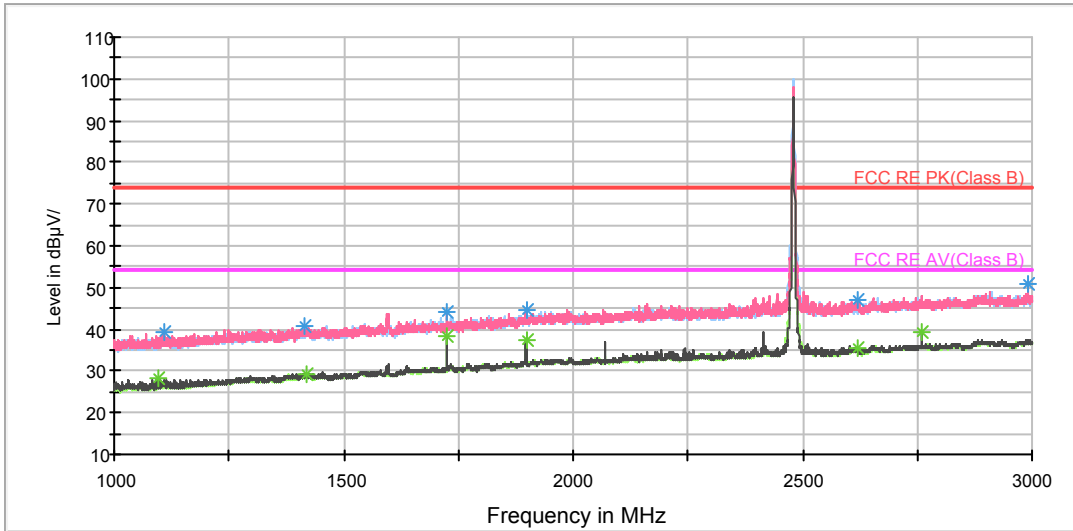

Note: The signal beyond the limit is carrier.  
Radiates Emission from 1GHz to 3GHz

RE 3-18GHz PK+AV

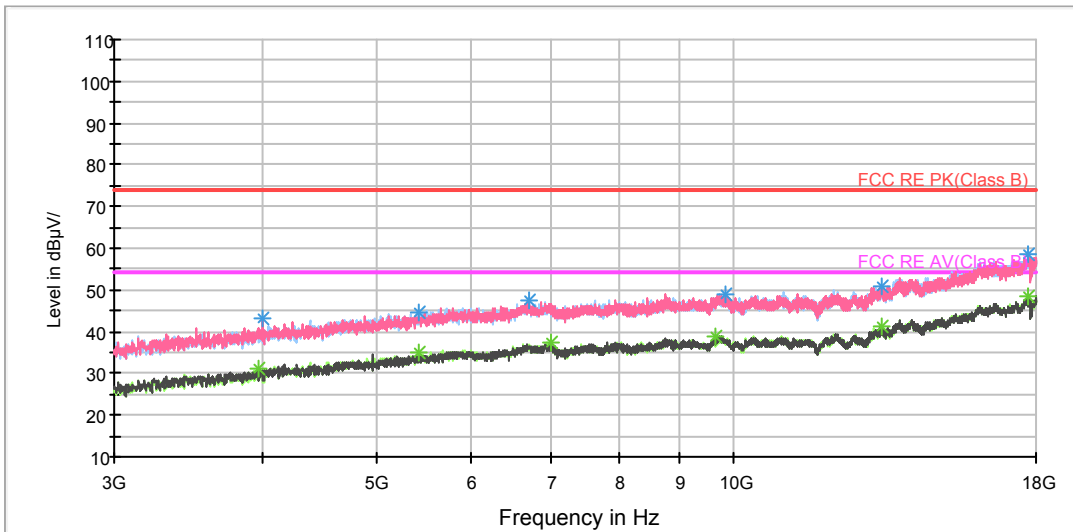

Radiates Emission from 3GHz to 18GHz



Frequency (MHz)	Peak (dBuV/m)	Height (cm)	Polarization	Azimuth (deg)	Reading value (dBuV/m)	Correct Factor (dB)	Margin (dB)	Limit (dBuV/m)
1110.000000	39.2	100.0	V	90.0	48.8	-9.6	34.8	74
1415.000000	40.7	100.0	H	206.0	48.3	-7.6	33.3	74
1724.750000	44.1	200.0	V	159.0	49.2	-5.1	29.9	74
1897.500000	44.7	200.0	V	120.0	48.3	-3.6	29.3	74
2618.750000	47.0	100.0	V	38.0	47.7	-0.7	27.0	74
2991.750000	50.8	100.0	V	21.0	49.4	1.4	23.2	74

Remark: 1. Correction Factor = Antenna factor+ Insertion loss (cable loss + amplifier gain)

Frequency (MHz)	Average (dBuV/m)	Height (cm)	Polarization	Azimuth (deg)	Reading value (dBuV/m)	Correct Factor (dB)	Margin (dB)	Limit (dBuV/m)
1095.500000	28.0	100.0	V	96.0	37.8	-9.8	26.0	54
1419.000000	29.4	100.0	V	189.0	36.9	-7.5	24.6	54
1724.750000	38.5	200.0	V	159.0	43.6	-5.1	15.5	54
1897.500000	37.6	200.0	V	120.0	41.2	-3.6	16.4	54
2619.000000	35.6	100.0	H	0.0	36.3	-0.7	18.4	54
2760.000000	39.5	100.0	V	138.0	39.4	0.1	14.5	54

Remark: 1. Correction Factor = Antenna factor+ Insertion loss (cable loss + amplifier gain)

### 5.7. Conducted Emission

#### Ambient condition

Temperature	Relative humidity	Pressure
23°C ~25°C	45%~50%	101.5kPa

#### Methods of Measurement

The EUT is placed on a non-metallic table of 80cm height above the horizontal metal reference ground plane. During the test, the EUT was operating in its typical mode. The test method is according to ANSI C63.10-2013. Connect the AC power line of the EUT to the L.I.S.N. Use EMI receiver to detect the average and Quasi-peak value. RBW is set to 9 kHz, VBW is set to 30kHz. The measurement result should include both L line and N line.

The test is in transmitting mode.

#### Test Setup

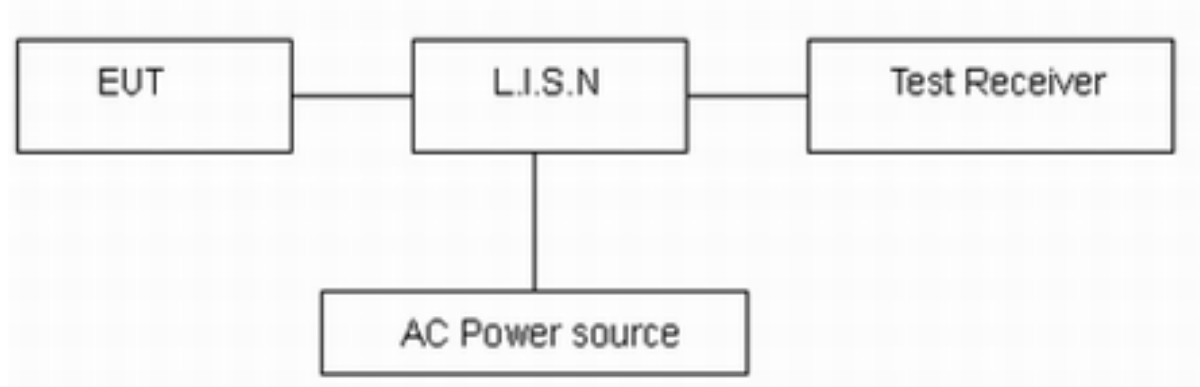

Note: AC Power source is used to change the voltage 110V/60Hz.

#### Limits

Frequency (MHz)	Conducted Limits(dBμV)	
	Quasi-peak	Average
0.15 - 0.5	66 to 56 *	56 to 46*
0.5 - 5	56	46
5 - 30	60	50

\*: Decreases with the logarithm of the frequency.

#### Measurement Uncertainty

The assessed measurement uncertainty to ensure 95% confidence level for the normal distribution is with the coverage factor  $k = 1.96$ ,  $U = 2.69$  dB.



**Test Results:**

Following plots, Blue trace uses the peak detection and Green trace uses the average detection. During the test, the Conducted Emission was performed in all channels, Zigbee, Channel No.: 11 are selected as the worst condition. The test data of the worst-case condition was recorded in this report.

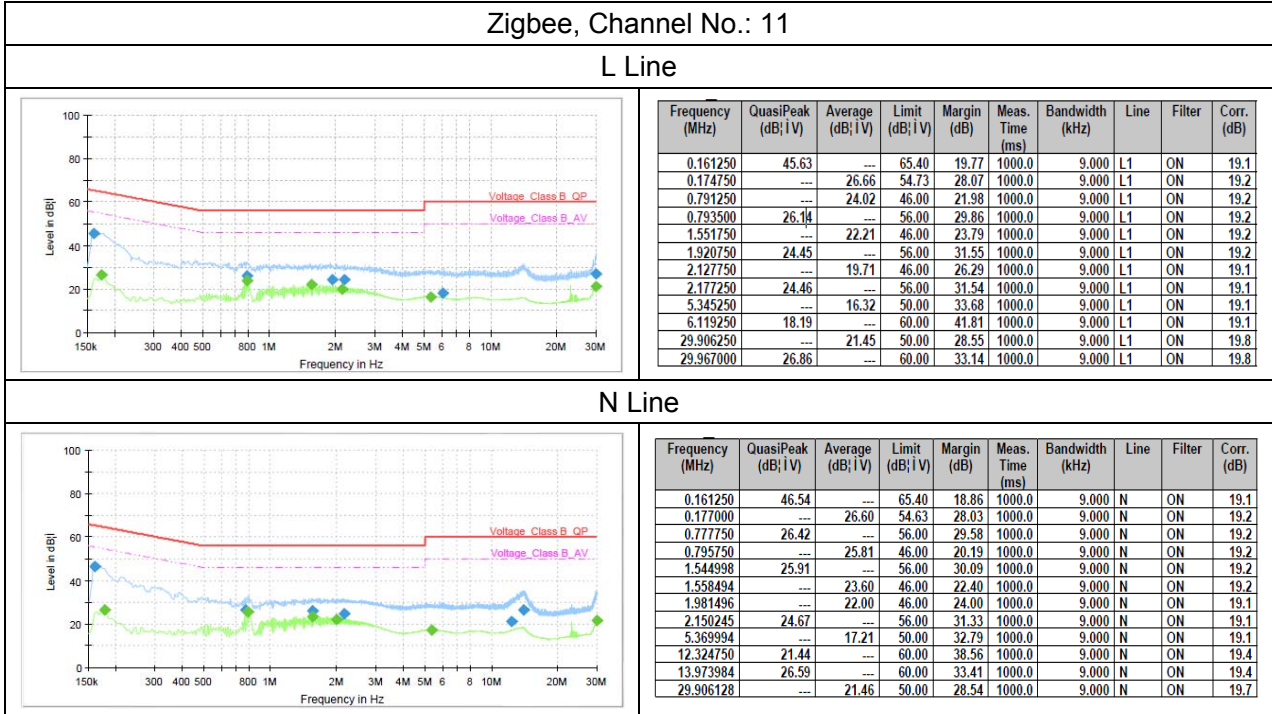





## 6. Main Test Instruments

Name	Manufacturer	Type	Serial Number	Calibration Date	Expiration Date
Spectrum Analyzer	R&S	FSV30	100815	2017-12-17	2018-12-16
EMI Test Receiver	R&S	ESCI	100948	2018-05-20	2019-05-19
Loop Antenna	SCHWARZBECK	FMZB1519	1519-047	2017-09-26	2019-09-25
TRILOG Broadband Antenna	Schwarzbeck	VULB 9163	9163-201	2017-11-18	2019-11-17
Double Ridged Waveguide Horn Antenna	R&S	HF907	100126	2018-07-07	2020-07-06
Standard Gain Horn	ETS-Lindgren	3160-09	00102643	2018-06-20	2020-06-19
EMI Test Receiver	R&S	ESR	101667	2018-05-20	2019-05-19
LISN	R&S	ENV216	101171	2016-12-16	2019-12-15
Spectrum Analyzer	Agilent	N9010A	MY47191109	2018-05-20	2019-05-19
RF Cable	Agilent	SMA 15cm	0001	/	/
Software	R&S	EMC32	9.26.0	/	/

\*\*\*\*\*END OF REPORT \*\*\*\*\*

## ANNEX A: EUT Appearance and Test Setup

### A.1 EUT Appearance

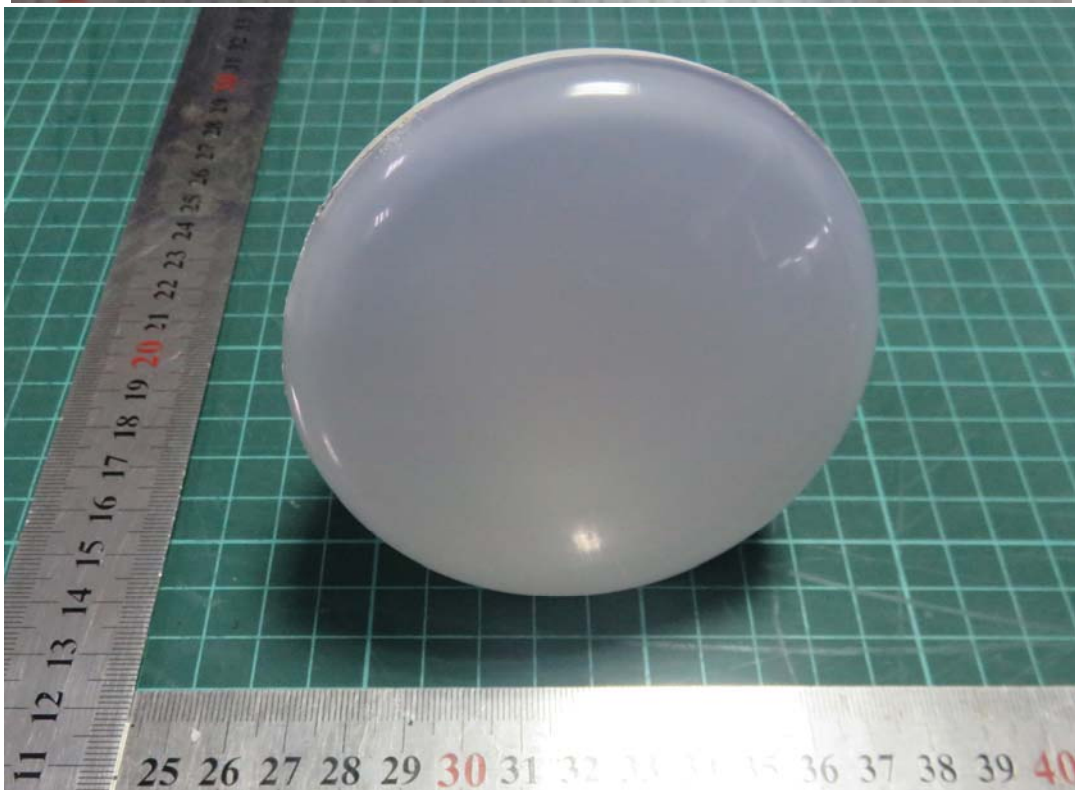

Picture 1 EUT

## A.2 Test Setup

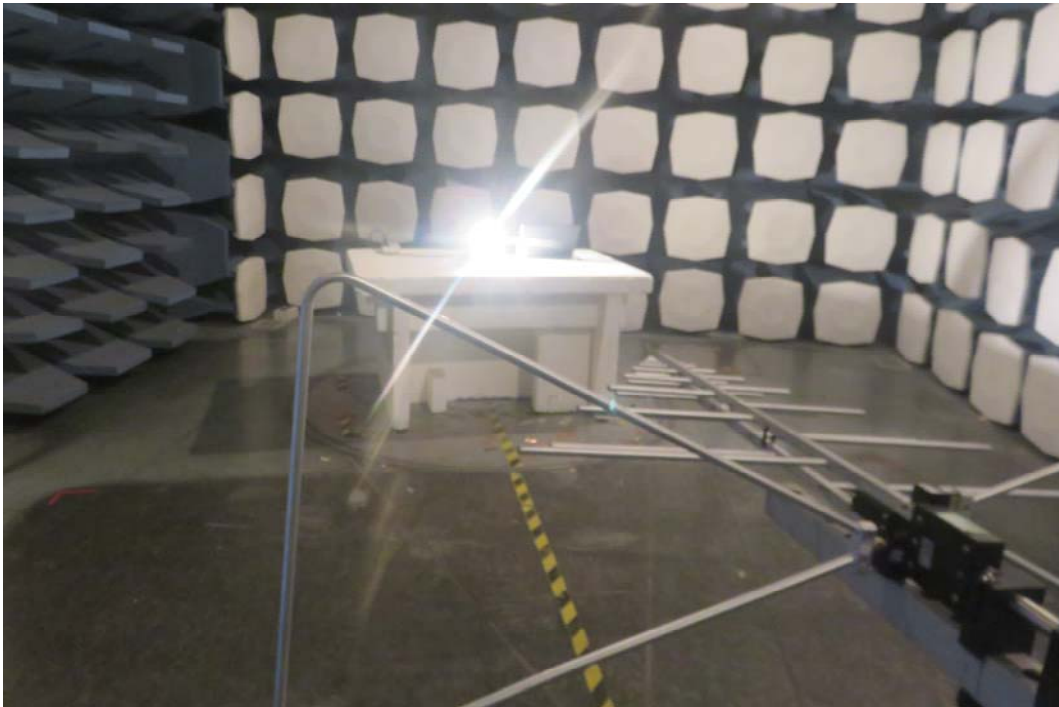

30M Hz-1GHz

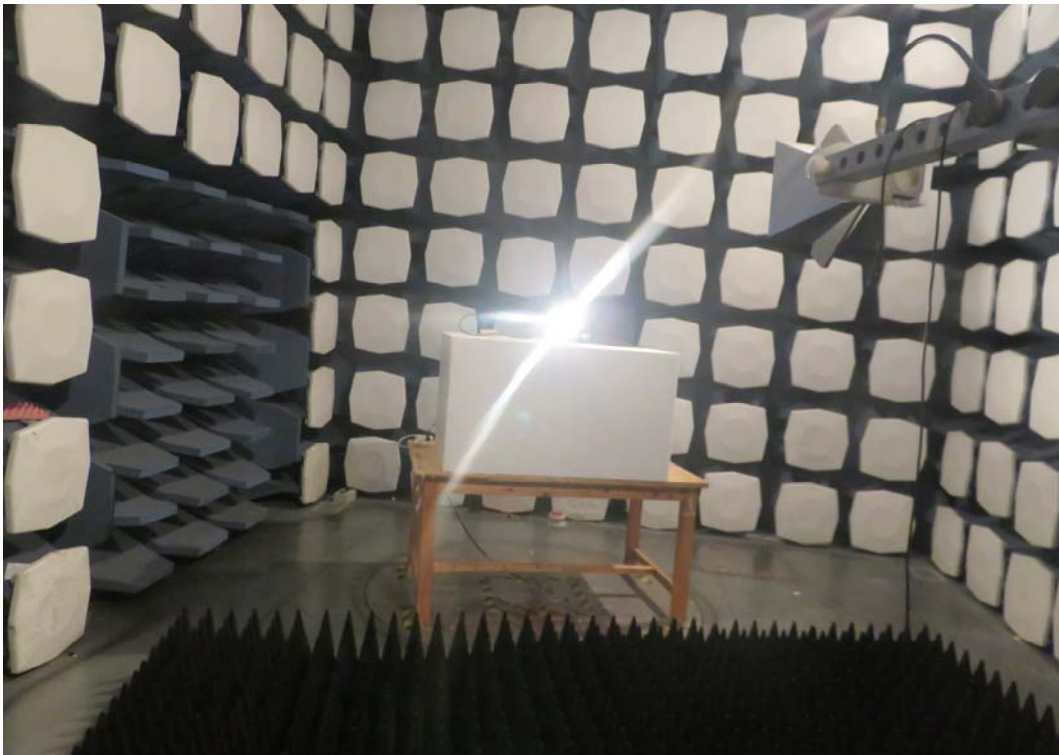

Above 1GHz

**Picture 2 Radiated Emission Test Setup**



**Picture 3 Conducted Emission Test Setup**