



Shenzhen CTA Testing Technology Co., Ltd.

Room 106, Building 1, Yibaolai Industrial Park, Qiaotou Community, Fuhai Street, Bao'an District, Shenzhen, China

FCC PART 15 SUBPART C TEST REPORT

FCC PART 15.247

Report Reference No.....: CTA22051800201

FCC ID..... : 2AGN7-NEO-A

Compiled by

(position+printed name+signature)..: File administrators Kevin Liu

Kevin Liu

Supervised by

(position+printed name+signature)..: Project Engineer Kevin Liu

Kevin Liu

Approved by

(position+printed name+signature)..: RF Manager Eric Wang

Eric Wang



Date of issue.....: May 18, 2022

Testing Laboratory Name: Shenzhen CTA Testing Technology Co., Ltd.

Address: Room 106, Building 1, Yibaolai Industrial Park, Qiaotou Community, Fuhai Street, Bao'an District, Shenzhen, China

Applicant's name.....: Shenzhen Zidoo Technology Co., Ltd.

Address: Room 1301,1302,1303,1307, Chentian R&D Building, No. 50 Baotian First Road, Chentian Community, Xixiang Street, Baoan District, Shenzhen, China

Test specification

Standard: FCC Part 15.247

Shenzhen CTA Testing Technology Co., Ltd. All rights reserved.

This publication may be reproduced in whole or in part for non-commercial purposes as long as the Shenzhen CTA Testing Technology Co., Ltd. is acknowledged as copyright owner and source of the material. Shenzhen CTA Testing Technology Co., Ltd. takes no responsibility for and will not assume liability for damages resulting from the reader's interpretation of the reproduced material due to its placement and context.

Test item description: 4K UHD Hi-end Media Player

Trade Mark: ZIDOO

Manufacturer: Shenzhen Zidoo Technology Co., Ltd.

Model/Type reference.....: NEO α

Listed Models: N/A

Modulation Type.....: CCK/DSSS, OFDM

Operation Frequency.....: From 2412 - 2462MHz

Hardware Version: α_1619

Software Version: V6.7.01

Rating: 100-240V~, 50/60Hz, Max 0.4A

Result.....: **PASS**

Shenzhen CTA Testing Technology Co., Ltd.

Room 106, Building 1, Yibaolai Industrial Park, Qiaotou Community, Fuhai Street, Bao'an District, Shenzhen, China
Tel:+86-755 2322 5875 E-mail:cta@cta-test.cn Web:http://www.cta-test.cn

TEST REPORT

Equipment under Test : 4K UHD Hi-end Media Player

Model /Type : NEO α

Listed Models : N/A

Applicant : **Shenzhen Zidoo Technology Co., Ltd.**

Address : Room 1301,1302,1303,1307, Chentian R&D Building, No. 50 Baotian First Road, Chentian Community, Xixiang Street, Baoan District, Shenzhen, China

Manufacturer : **Shenzhen Zidoo Technology Co., Ltd.**

Address : Room 1301,1302,1303,1307, Chentian R&D Building, No. 50 Baotian First Road, Chentian Community, Xixiang Street, Baoan District, Shenzhen, China

Test Result:**PASS**

The test report merely corresponds to the test sample.
It is not permitted to copy extracts of these test result without the written permission of the test laboratory.

Contents

1	<u>TEST STANDARDS</u>	4
2	<u>SUMMARY</u>	5
2.1	General Remarks	5
2.2	Product Description	5
2.3	Equipment Under Test	5
2.4	Short description of the Equipment under Test (EUT)	5
2.5	EUT operation mode	5
2.6	Block Diagram of Test Setup	6
2.7	Special Accessories	6
2.8	Related Submittal(s) / Grant (s)	6
2.9	Modifications	6
3	<u>TEST ENVIRONMENT</u>	7
3.1	Address of the test laboratory	7
3.2	Test Facility	7
3.3	Environmental conditions	7
3.4	Summary of measurement results	8
3.5	Statement of the measurement uncertainty	8
3.6	Equipments Used during the Test	9
4	<u>TEST CONDITIONS AND RESULTS</u>	10
4.1	AC Power Conducted Emission	10
4.2	Radiated Emission	13
4.3	Maximum Conducted Output Power	20
4.4	Power Spectral Density	21
4.5	6dB Bandwidth	26
4.6	Out-of-band Emissions	31
4.7	Antenna Requirement	47
5	<u>TEST SETUP PHOTOS OF THE EUT</u>	48
6	<u>PHOTOS OF THE EUT</u>	49

1 TEST STANDARDS

The tests were performed according to following standards:

[FCC Rules Part 15.247](#): Frequency Hopping, Direct Spread Spectrum and Hybrid Systems that are in operation within the bands of 902-928 MHz, 2400-2483.5 MHz, and 5725-5850 MHz.

[ANSI C63.10-2013](#): American National Standard for Testing Unlicensed Wireless Devices

[KDB558074 D01 V05r02](#): Guidance for Compliance Measurements on Digital Transmission Systems (DTS) ,Frequency Hopping Spread Spectrum System(HFSS), and Hybrid System Devices Operating Under §15.247 of The FCC rules.

[KDB662911 D01 v02r01](#):Emissions Testing of Transmitters with Multiple Outputs in the Same Band.

2 SUMMARY

2.1 General Remarks

Date of receipt of test sample	:	Apr. 25, 2022
Testing commenced on	:	Apr. 26, 2022
Testing concluded on	:	May 11, 2022

2.2 Product Description

Product Name:	4K UHD Hi-end Media Player
Model/Type reference:	NEO α
Power supply:	100-240V~ ,50/60Hz, Max 0.4A
Testing sample ID:	CTA220518002-1# (Engineer sample) CTA220518002-2# (Normal sample)
WIFI	
Supported type:	802.11b/802.11g/802.11n(H20)/802.11n(H40)
Modulation:	802.11b: DSSS 802.11g/802.11n(H20)/802.11n(H40): OFDM
Operation frequency:	802.11b/802.11g/802.11n(H20): 2412MHz~2462MHz 802.11n(H40): 2422MHz~2452MHz
Channel number:	802.11b/802.11g/802.11n(H20): 11 802.11n(H40): 7
Channel separation:	5MHz
Antenna type:	External antenna 2*2
Antenna gain:	3.0dBi

Note:Antenna gain is provide by the manufacturer.

2.3 Equipment Under Test

Power supply system utilised

Power supply voltage	:	<input type="radio"/> 230V / 50 Hz	<input type="radio"/> 120V / 60Hz
		<input type="radio"/> 12 V DC	<input type="radio"/> 24 V DC
		<input checked="" type="radio"/> Other (specified in blank below)	

100-240V~ ,50/60Hz

2.4 Short description of the Equipment under Test (EUT)

This is a 4K UHD Hi-end Media Player.

For more details, refer to the user's manual of the EUT.

2.5 EUT operation mode

The application provider specific test software(WLAN Test) to control sample in continuous TX and RX (Duty Cycle >98%) for testing meet KDB558074 test requirement.

IEEE 802.11b/g/n: Thirteen channels are provided to the EUT.

Channel	Frequency(MHz)	Channel	Frequency(MHz)
1	2412	8	2447
2	2417	9	2452
3	2422	10	2457
4	2427	11	2462
5	2432		
6	2437		

Shenzhen CTA Testing Technology Co., Ltd.

Room 106, Building 1, Yibaolai Industrial Park, Qiaotou Community, Fuhai Street, Bao'an District, Shenzhen, China
Tel:+86-755 2322 5875 E-mail:cta@cta-test.cn Web:http://www.cta-test.cn

7	2442		
---	------	--	--

2.6 Block Diagram of Test Setup

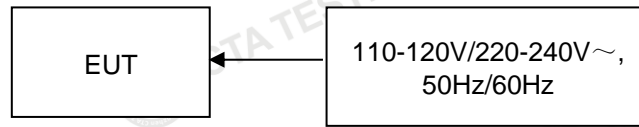

2.7 Special Accessories

Follow auxiliary equipment(s) test with EUT that provided by the manufacturer or laboratory is listed as follow:

Description	Manufacturer	Model	Technical Parameters	Certificate	Provided by
/	/	/	/	/	/
/	/	/	/	/	/
/	/	/	/	/	/
/	/	/	/	/	/
/	/	/	/	/	/

2.8 Related Submittal(s) / Grant (s)

This submittal(s) (test report) is intended for the device filing to comply with Section 15.247 of the FCC Part 15, Subpart C Rules.

2.9 Modifications

No modifications were implemented to meet testing criteria.

3 TEST ENVIRONMENT

3.1 Address of the test laboratory

Shenzhen CTA Testing Technology Co., Ltd.

Room 106, Building 1, Yibaolai Industrial Park, Qiaotou Community, Fuhai Street, Bao'an District, Shenzhen, China

3.2 Test Facility

The test facility is recognized, certified, or accredited by the following organizations:

FCC-Registration No.: 517856 Designation Number: CN1318

Shenzhen CTA Testing Technology Co., Ltd. has been listed on the US Federal Communications Commission list of test facilities recognized to perform electromagnetic emissions measurements.

A2LA-Lab Cert. No.: 6534.01

Shenzhen CTA Testing Technology Co., Ltd. has been listed by American Association for Laboratory Accreditation to perform electromagnetic emission measurement.

The 3m-Semi anechoic test site fulfils CISPR 16-1-4 according to ANSI C63.10 and CISPR 16-1-4:2010.

3.3 Environmental conditions

During the measurement the environmental conditions were within the listed ranges:

Radiated Emission:

Temperature:	24 ° C
Humidity:	46 %
Atmospheric pressure:	950-1050mbar

AC Power Conducted Emission:

Temperature:	25 ° C
Humidity:	47 %
Atmospheric pressure:	950-1050mbar

Conducted testing:

Temperature:	24 ° C
Humidity:	46 %
Atmospheric pressure:	950-1050mbar

3.4 Summary of measurement results

Test Specification clause	Test case	Test Sample	Test Mode	Test Channel	Recorded In Report		Test result
§15.247(e)	Power spectral density	CTA2205180 02-1#	802.11b 802.11g 802.11n(HT)20 802.11n(HT)40	Lowest Middle Highest	802.11b 802.11g 802.11n(HT)20 802.11n(HT)40	Lowest Middle Highest	complies
§15.247(a)(2)	Spectrum bandwidth – 6 dB bandwidth	CTA2205180 02-1#	802.11b 802.11g 802.11n(HT)20 802.11n(HT)40	Lowest Middle Highest	802.11b 802.11g 802.11n(HT)20 802.11n(HT)40	Lowest Middle Highest	complies
§15.247(b)(3)	Maximum Conducted output power	CTA2205180 02-1#	8802.11b 802.11g 802.11n(HT)20 802.11n(HT)40	Lowest Middle Highest	802.11b 802.11g 802.11n(HT)20 802.11n(HT)40	Lowest Middle Highest	complies
§15.247(d)	Band edge compliance conducted	CTA2205180 02-1#	802.11b 802.11g 802.11n(HT)20 802.11n(HT)40	Lowest Highest	802.11b 802.11g 802.11n(HT)20 802.11n(HT)40	Lowest Highest	complies
§15.205	Band edge compliance radiated	CTA2205180 02-1#	802.11b 802.11g 802.11n(HT)20 802.11n(HT)40	Lowest Highest	802.11n(HT)40	Lowest Highest	complies
§15.247(d)	TX spurious emissions conducted	CTA2205180 02-1#	802.11b 802.11g 802.11n(HT)20 802.11n(HT)40	Lowest Middle Highest	802.11b 802.11g 802.11n(HT)20 802.11n(HT)40	Lowest Middle Highest	complies
§15.209(a)	TX spurious emissions Radiated above 1GHz	CTA2205180 02-1#	802.11b 802.11g 802.11n(HT)20 802.11n(HT)40	Lowest Middle Highest	802.11b	Lowest Middle Highest	complies
§15.209(a)	TX spurious Emissions radiated Below 1GHz	CTA2205180 02-2#	802.11b 802.11g 802.11n(HT)20 802.11n(HT)40	Lowest Middle Highest	802.11b	Lowest	complies
§15.107(a) §15.207	Conducted Emissions < 30 MHz	CTA2205180 02-2#	802.11b 802.11g 802.11n(HT)20 802.11n(HT)40	Lowest Middle Highest	802.11b	Lowest	complies

Remark:

1. The measurement uncertainty is not included in the test result.
2. We tested all test mode and recorded worst case in report

3.5 Statement of the measurement uncertainty

The data and results referenced in this document are true and accurate. The reader is cautioned that there may be errors within the calibration limits of the equipment and facilities. The measurement uncertainty was calculated for all measurements listed in this test report acc. to TR-100028-01 "Electromagnetic compatibility and Radio spectrum Matters (ERM);Uncertainties in the measurement of mobile radio equipment characteristics; Part 1" and TR-100028-02 "Electromagnetic compatibility and Radio spectrum Matters (ERM);Uncertainties in the measurement of mobile radio equipment characteristics; Part 2 " and is documented in the Shenzhen CTA Testing Technology Co., Ltd. quality system acc. to DIN EN ISO/IEC 17025. Furthermore, component and process variability of devices similar to that tested may result in additional deviation. The manufacturer has the sole responsibility of continued compliance of the device.

Hereafter the best measurement capability for Shenzhen CTA Testing Technology Co., Ltd. :

Test	Range	Measurement Uncertainty	Notes
Radiated Emission	30~1000MHz	4.06 dB	(1)
Radiated Emission	1~18GHz	5.14 dB	(1)
Radiated Emission	18-40GHz	5.38 dB	(1)
Conducted Disturbance	0.15~30MHz	2.14 dB	(1)

- (1) This uncertainty represents an expanded uncertainty expressed at approximately the 95% confidence level using a coverage factor of k=2.

Shenzhen CTA Testing Technology Co., Ltd.

Room 106, Building 1, Yibaolai Industrial Park, Qiaotou Community, Fuhai Street, Bao'an District, Shenzhen, China
Tel:+86-755 2322 5875 E-mail:cta@cta-test.cn Web:http://www.cta-test.cn

3.6 Equipments Used during the Test

Test Equipment	Manufacturer	Model No.	Equipment No.	Calibration Date	Calibration Due Date
LISN	R&S	ENV216	CTA-308	2021/08/06	2022/08/05
LISN	R&S	ENV216	CTA-314	2021/08/06	2022/08/05
EMI Test Receiver	R&S	ESPI	CTA-307	2021/08/06	2022/08/05
EMI Test Receiver	R&S	ESCI	CTA-306	2021/08/06	2022/08/05
Spectrum Analyzer	Agilent	N9020A	CTA-301	2021/08/06	2022/08/05
Spectrum Analyzer	R&S	FSP	CTA-337	2021/08/06	2022/08/05
Vector Signal generator	Agilent	N5182A	CTA-305	2021/08/06	2022/08/05
Analog Signal Generator	R&S	SML03	CTA-304	2021/08/06	2022/08/05
Universal Radio Communication	CMW500	R&S	CTA-302	2021/08/06	2022/08/05
Temperature and humidity meter	Chigo	ZG-7020	CTA-326	2021/08/06	2022/08/05
Ultra-Broadband Antenna	Schwarzbeck	VULB9163	CTA-310	2021/08/07	2022/08/06
Horn Antenna	Schwarzbeck	BBHA 9120D	CTA-309	2021/08/07	2022/08/06
Loop Antenna	Zhinan	ZN30900C	CTA-311	2021/08/07	2022/08/06
Horn Antenna	Beijing Hangwei Dayang	OBH100400	CTA-336	2021/08/06	2022/08/05
Amplifier	Schwarzbeck	BBV 9745	CTA-312	2021/08/06	2022/08/05
Amplifier	Taiwan chengyi	EMC051845B	CTA-313	2021/08/06	2022/08/05
Directional coupler	NARDA	4226-10	CTA-303	2021/08/06	2022/08/05
High-Pass Filter	XingBo	XBLBQ-GTA18	CTA-402	2021/08/06	2022/08/05
High-Pass Filter	XingBo	XBLBQ-GTA27	CTA-403	2021/08/06	2022/08/05
Automated filter bank	Tonscend	JS0806-F	CTA-404	2021/08/06	2022/08/05
Power Sensor	Agilent	U2021XA	CTA-405	2021/08/06	2022/08/05
Amplifier	Schwarzbeck	BBV9719	CTA-406	2021/08/06	2022/08/05

4 TEST CONDITIONS AND RESULTS

4.1 AC Power Conducted Emission

TEST CONFIGURATION

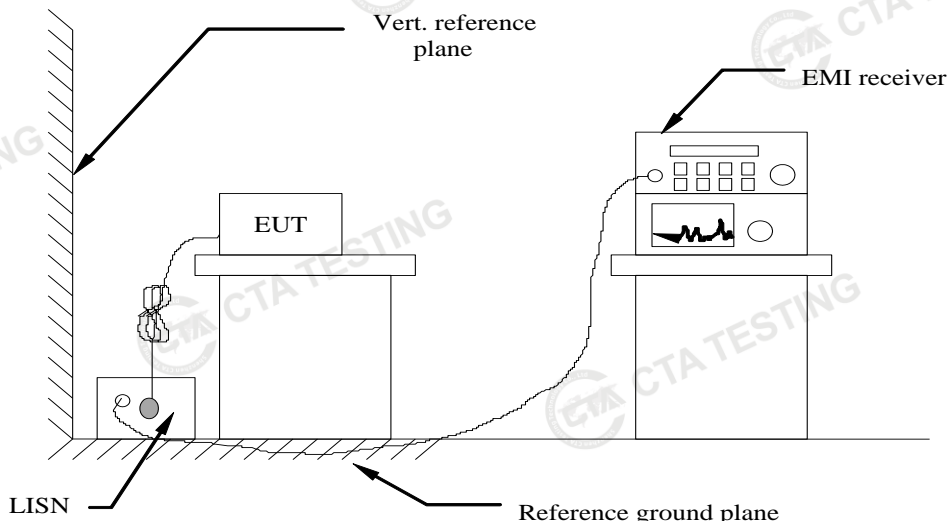

TEST PROCEDURE

- 1 The equipment was set up as per the test configuration to simulate typical actual usage per the user's manual. The EUT is a tabletop system, a wooden table with a height of 0.8 meters is used and is placed on the ground plane as per ANSI C63.10-2013.
- 2 Support equipment, if needed, was placed as per ANSI C63.10-2013
- 3 All I/O cables were positioned to simulate typical actual usage as per ANSI C63.10-2013
- 4 The EUT received DC 12V power from adapter, the adapter received AC120V/60Hz and AC 240V/60Hz power through a Line Impedance Stabilization Network (LISN) which supplied power source and was grounded to the ground plane.
- 5 All support equipments received AC power from a second LISN, if any.
- 6 The EUT test program was started. Emissions were measured on each current carrying line of the EUT using a spectrum Analyzer / Receiver connected to the LISN powering the EUT. The LISN has two monitoring points: Line 1 (Hot Side) and Line 2 (Neutral Side). Two scans were taken: one with Line 1 connected to Analyzer / Receiver and Line 2 connected to a 50 ohm load; the second scan had Line 1 connected to a 50 ohm load and Line 2 connected to the Analyzer / Receiver.
- 7 Analyzer / Receiver scanned from 150 KHz to 30MHz for emissions in each of the test modes.
- 8 During the above scans, the emissions were maximized by cable manipulation.

AC Power Conducted Emission Limit

For intentional device, according to § 15.207(a) AC Power Conducted Emission Limits is as following :

Frequency range (MHz)	Limit (dBuV)	
	Quasi-peak	Average
0.15-0.5	66 to 56*	56 to 46*
0.5-5	56	46
5-30	60	50

* Decreases with the logarithm of the frequency.

TEST RESULTS

Remark:

- All modes of 802.11b/g/n were tested at Low, Middle, and High channel; only the worst result of 802.11b CH01 was reported as below:
- Both 120 VAC, 50/60 Hz and 240 VAC, 50/60 Hz power supply have been tested, only the worst result of 120 VAC, 60 Hz was reported as below:

Power supply:	AC 120V/60Hz	Polarization	L
---------------	--------------	--------------	---

Test Graph

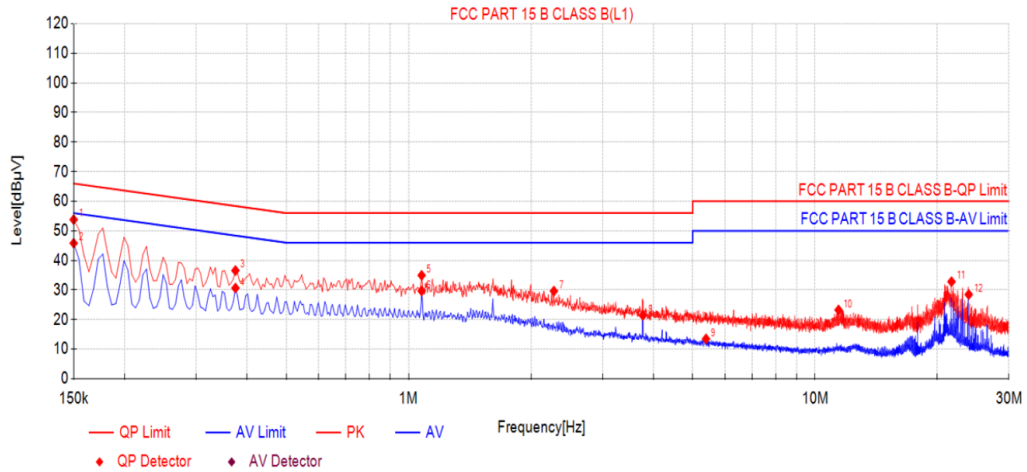

Suspected List									
NO.	Freq. [MHz]	Reading [dBµV]	Level [dBµV]	Factor [dB]	Limit [dBµV]	Margin [dB]	Detector	Type	Verdict
1	0.15	43.29	53.79	10.50	66.00	12.21	PK	L1	PASS
2	0.15	35.32	45.82	10.50	56.00	10.18	AV	L1	PASS
3	0.375	26.08	36.58	10.50	58.39	21.81	PK	L1	PASS
4	0.375	20.16	30.66	10.50	48.39	17.73	AV	L1	PASS
5	1.077	24.45	34.95	10.50	56.00	21.05	PK	L1	PASS
6	1.077	19.19	29.69	10.50	46.00	16.31	AV	L1	PASS
7	2.2785	19.15	29.65	10.50	56.00	26.35	PK	L1	PASS
8	3.7725	10.89	21.39	10.50	46.00	24.61	AV	L1	PASS
9	5.3925	2.97	13.47	10.50	50.00	36.53	AV	L1	PASS
10	11.427	12.73	23.23	10.50	60.00	36.77	PK	L1	PASS
11	21.6645	22.31	32.81	10.50	60.00	27.19	PK	L1	PASS
12	23.892	17.97	28.47	10.50	50.00	21.53	AV	L1	PASS

- Note:1).Level (dBµV)= Reading (dBµV)+ Factor (dB)
 2). Factor (dB)=insertion loss of LISN (dB) + Cable loss (dB)
 3). Margin(dB) = Limit (dBµV) - Level (dBµV)

Power supply:	AC 120V/60Hz	Polarization	N
---------------	--------------	--------------	---

Test Graph

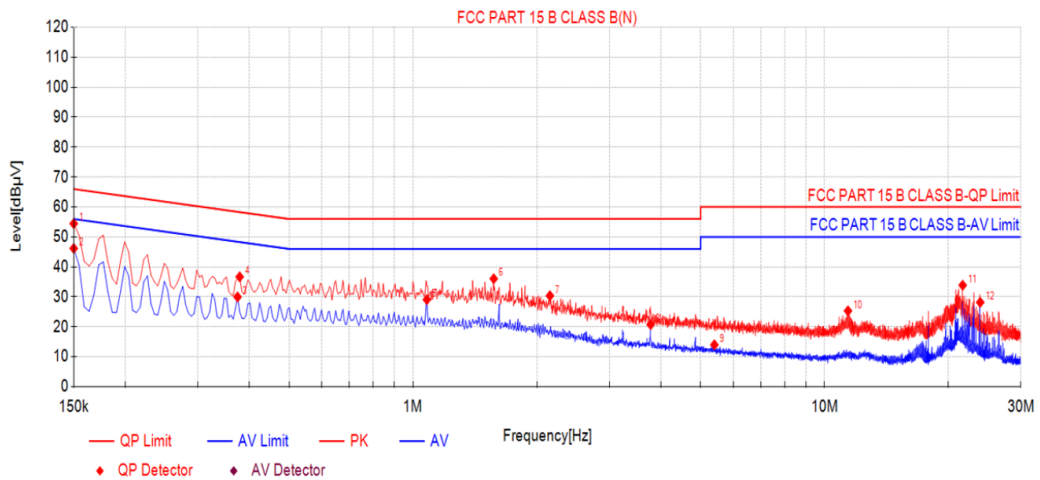

Suspected List									
NO.	Freq. [MHz]	Reading [dBµV]	Level [dBµV]	Factor [dB]	Limit [dBµV]	Margin [dB]	Detector	Type	Verdict
1	0.15	43.95	54.45	10.50	66.00	11.55	PK	N	PASS
2	0.15	35.67	46.17	10.50	56.00	9.83	AV	N	PASS
3	0.375	19.48	29.98	10.50	48.39	18.41	AV	N	PASS
4	0.3795	26.18	36.68	10.50	58.29	21.61	PK	N	PASS
5	1.0815	18.57	29.07	10.50	46.00	16.93	AV	N	PASS
6	1.572	25.55	36.05	10.50	56.00	19.95	PK	N	PASS
7	2.1525	19.86	30.36	10.50	56.00	25.64	PK	N	PASS
8	3.7815	10.21	20.71	10.50	46.00	25.29	AV	N	PASS
9	5.4015	3.49	13.99	10.50	50.00	36.01	AV	N	PASS
10	11.4045	14.81	25.31	10.50	60.00	34.69	PK	N	PASS
11	21.6645	23.38	33.88	10.50	60.00	26.12	PK	N	PASS
12	23.8965	17.66	28.16	10.50	50.00	21.84	AV	N	PASS

- Note:1).Level (dBµV)= Reading (dBµV)+ Factor (dB)
 2). Factor (dB)=insertion loss of LISN (dB) + Cable loss (dB)
 3). Margin(dB) = Limit (dBµV) - Level (dBµV)

4.2 Radiated Emission

TEST CONFIGURATION

Frequency range 9 KHz – 30MHz

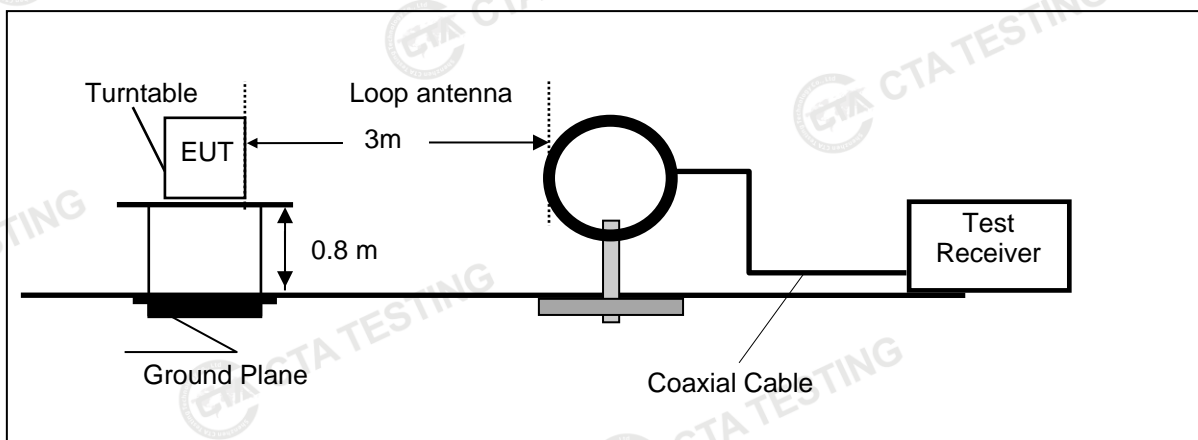

Frequency range 30MHz – 1000MHz

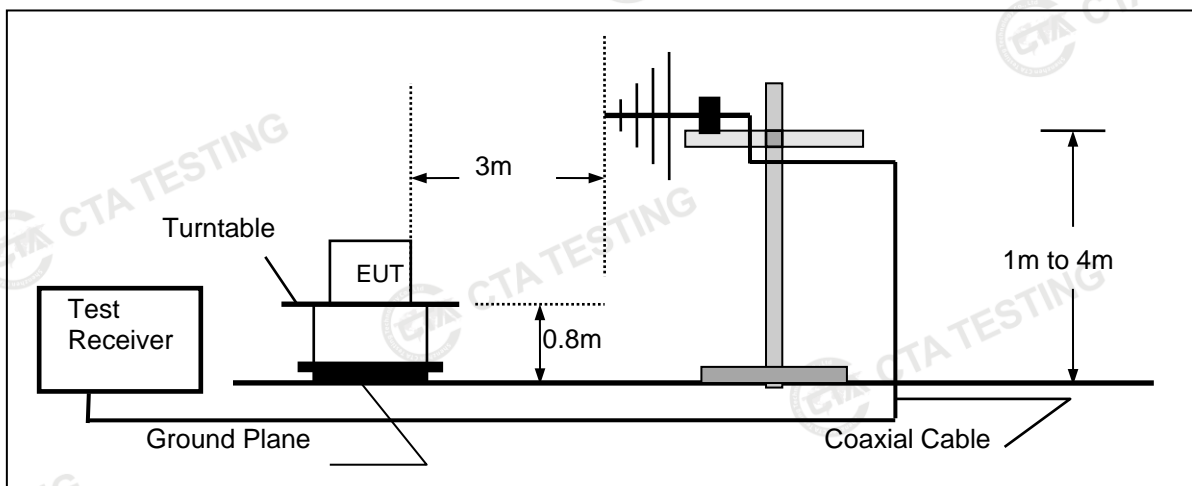

Frequency range above 1GHz-25GHz

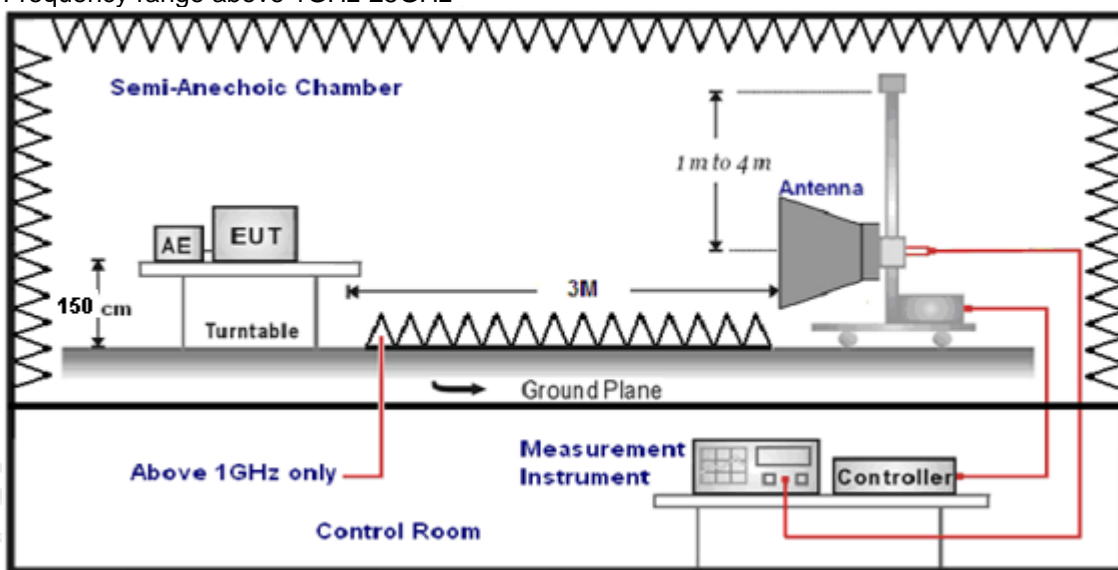

TEST PROCEDURE

- The EUT was placed on a turn table which is 0.8m above ground plane when testing frequency range 9 KHz –1GHz;the EUT was placed on a turn table which is 1.5m above ground plane when testing frequency range 1GHz – 25GHz.
- Maximum procedure was performed by raising the receiving antenna from 1m to 4m and rotating the turn table from 0° to 360° to acquire the highest emissions from EUT.
- And also, each emission was to be maximized by changing the polarization of receiving antenna both horizontal and vertical.
- Repeat above procedures until all frequency measurements have been completed.
- Radiated emission test frequency band from 9KHz to 25GHz.
- The distance between test antenna and EUT as following table states:

Test Frequency range	Test Antenna Type	Test Distance
9KHz-30MHz	Active Loop Antenna	3
30MHz-1GHz	Ultra-Broadband Antenna	3
1GHz-18GHz	Double Ridged Horn Antenna	3
18GHz-25GHz	Horn Antenna	1

- Setting test receiver/spectrum as following table states:

Test Frequency range	Test Receiver/Spectrum Setting	Detector
9KHz-150KHz	RBW=200Hz/VBW=3KHz,Sweep time=Auto	QP
150KHz-30MHz	RBW=9KHz/VBW=100KHz,Sweep time=Auto	QP
30MHz-1GHz	RBW=120KHz/VBW=1000KHz,Sweep time=Auto	QP
1GHz-40GHz	Peak Value: RBW=1MHz/VBW=3MHz, Sweep time=Auto Average Value: RBW=1MHz/VBW=10Hz, Sweep time=Auto	Peak

Field Strength Calculation

The field strength is calculated by adding the Antenna Factor and Cable Factor and subtracting the Amplifier Gain and Duty Cycle Correction Factor(if any) from the measured reading. The basic equation with a sample calculation is as follows:

$$FS = RA + AF + CL - AG$$

Where FS = Field Strength	CL = Cable Attenuation Factor (Cable Loss)
RA = Reading Amplitude	AG = Amplifier Gain
AF = Antenna Factor	

$$\text{Transd}=AF +CL-AG$$

RADIATION LIMIT

For intentional device, according to § 15.209(a), the general requirement of field strength of radiated emission from intentional radiators at a distance of 3 meters shall not exceed the following table. According to § 15.247(d), in any 100kHz bandwidth outside the frequency band in which the EUT is operating, the radio frequency power that is produced by the intentional radiator shall be at least 20dB below that in the100kHz bandwidth within the band that contains the highest level of desired power.

The pre-test have done for the EUT in three axes and found the worst emission at position shown in test setup photos.

Frequency (MHz)	Distance (Meters)	Radiated (dBµV/m)	Radiated (µV/m)
0.009-0.49	3	20log(2400/F(KHz))+40log(300/3)	2400/F(KHz)
0.49-1.705	3	20log(24000/F(KHz))+ 40log(30/3)	24000/F(KHz)
1.705-30	3	20log(30)+ 40log(30/3)	30
30-88	3	40.0	100
88-216	3	43.5	150
216-960	3	46.0	200
Above 960	3	54.0	500

Shenzhen CTA Testing Technology Co., Ltd.

Room 106, Building 1, Yibaolai Industrial Park, Qiaotou Community, Fuhai Street, Bao'an District, Shenzhen, China
Tel:+86-755 2322 5875 E-mail:cta@cta-test.cn Web:http://www.cta-test.cn

TEST RESULTS

Remark:

1. All three channels (lowest/middle/highest) of each mode were measured below 1GHz and recorded worst case at 802.11b low channel(Ant1).
2. All three channels (lowest/middle/highest) of each mode were measured above1GHz and recorded worst case at 802.11b mode(Ant1).
3. Radiated emission test from 9 KHz to 10th harmonic of fundamental was verified, and no emission found except system noise floor in 9 KHz to 30MHz and not recorded in this report.

For 30MHz-1GHz

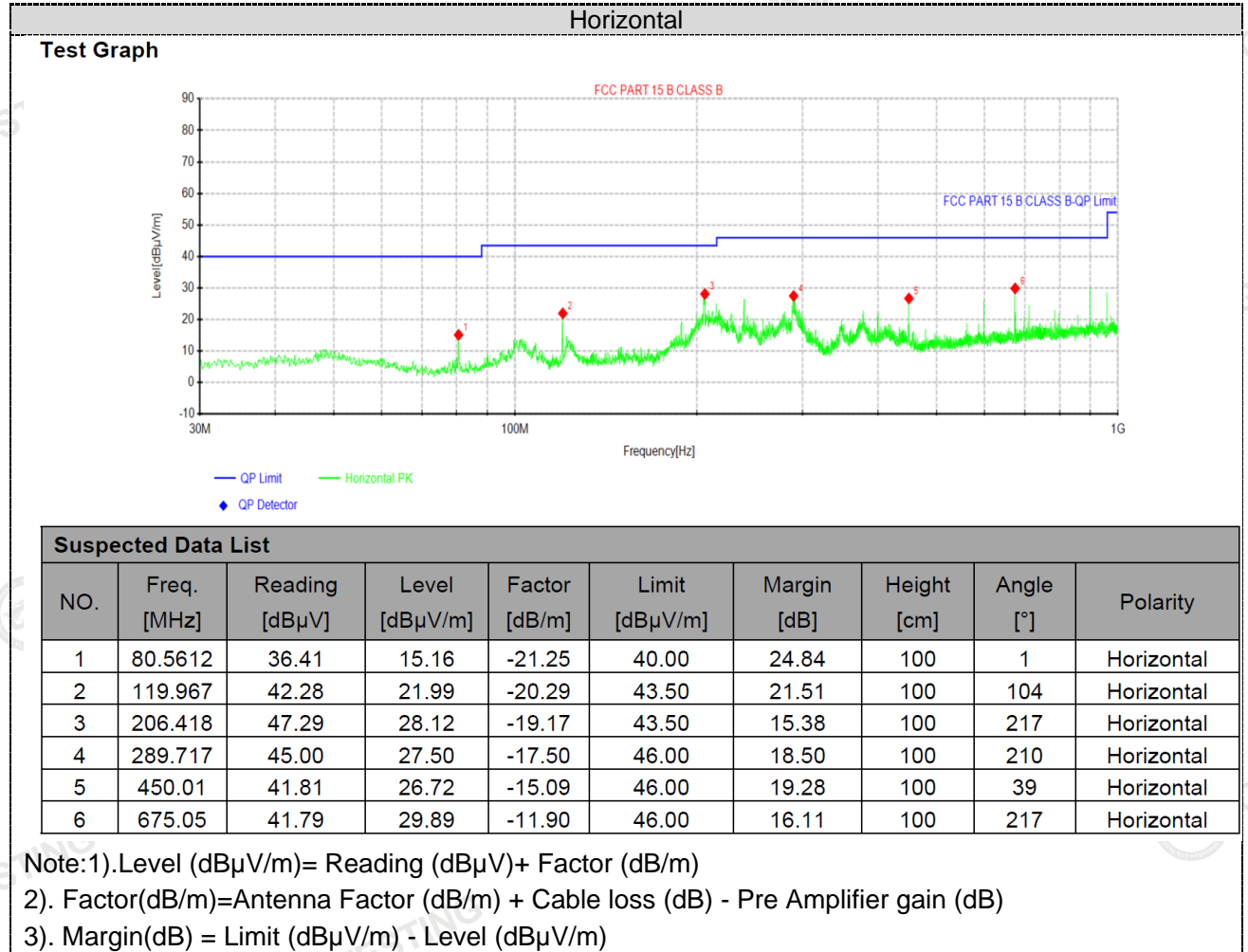

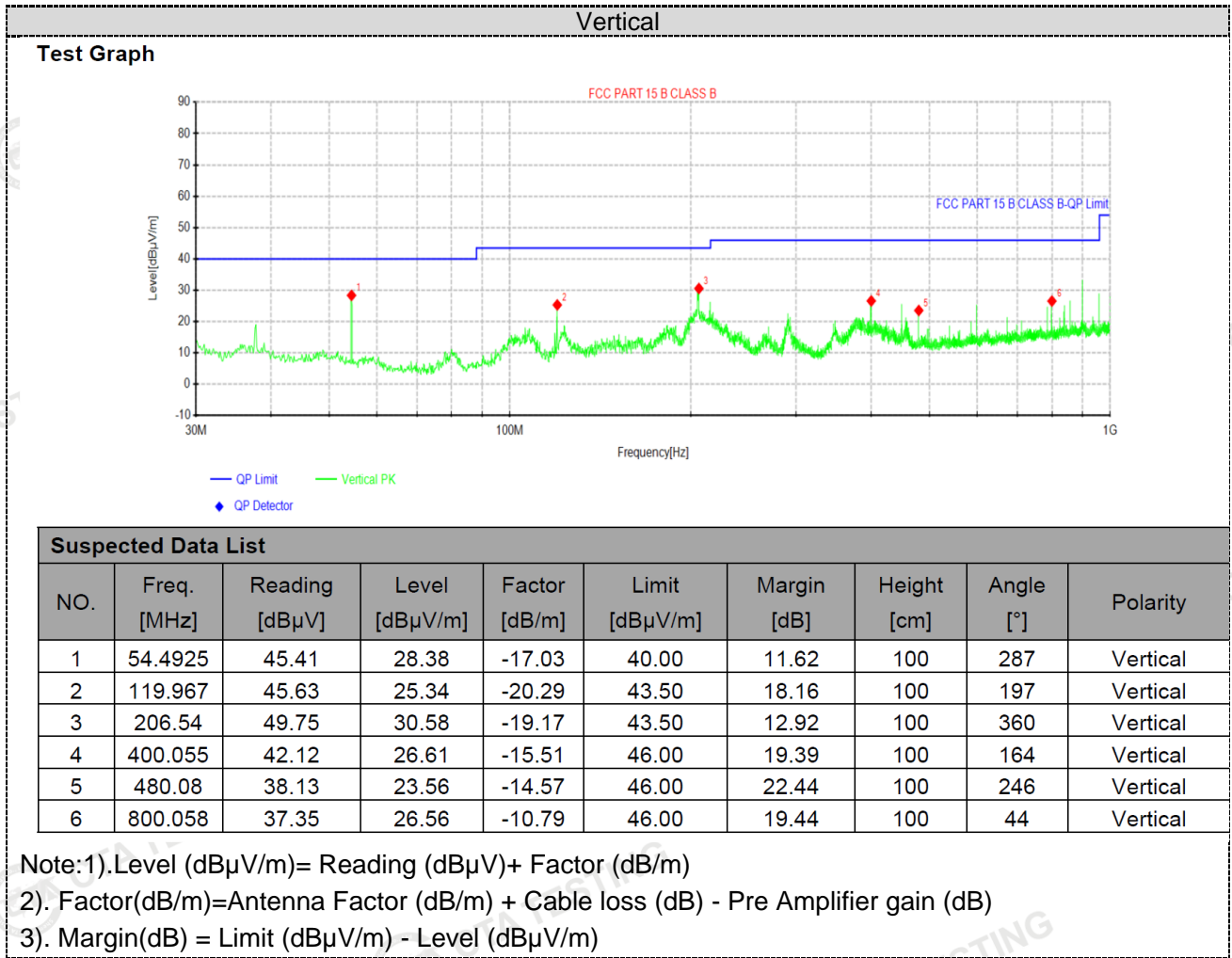

For 1GHz to 25GHz

Note: 802.11b/802.11g/802.11n (H20)/802.11n (H40) all have been tested, only worse case 802.11b mode(Ant1) was reported as below:

Frequency(MHz):			2412		Polarity:			HORIZONTAL	
Frequency (MHz)	Emission Level (dBuV/m)		Limit (dBuV/m)	Margin (dB)	Raw Value (dBuV)	Antenna Factor (dB/m)	Cable Factor (dB)	Pre-amplifier (dB)	Correction Factor (dB/m)
4824.00	45.98	PK	74	28.02	50.34	32.40	5.11	41.87	-4.36
4824.00	--	AV	54	--	--	--	--	--	--
7236.00	50.08	PK	74	23.92	50.71	36.58	6.43	43.64	-0.63
7236.00	--	AV	54	--	--	--	--	--	--

Frequency(MHz):			2412		Polarity:			VERTICAL	
Frequency (MHz)	Emission Level (dBuV/m)		Limit (dBuV/m)	Margin (dB)	Raw Value (dBuV)	Antenna Factor (dB/m)	Cable Factor (dB)	Pre-amplifier (dB)	Correction Factor (dB/m)
4824.00	46.58	PK	74	27.42	50.94	32.40	5.11	41.87	-4.36
4824.00	--	AV	54	--	--	--	--	--	--
7236.00	51.28	PK	74	22.72	51.91	36.58	6.43	43.64	-0.63
7236.00	--	AV	54	--	--	--	--	--	--

Frequency(MHz):			2437		Polarity:			HORIZONTAL	
Frequency (MHz)	Emission Level (dBuV/m)		Limit (dBuV/m)	Margin (dB)	Raw Value (dBuV)	Antenna Factor (dB/m)	Cable Factor (dB)	Pre-amplifier (dB)	Correction Factor (dB/m)
4874.00	45.94	PK	74	28.06	49.89	32.56	5.34	41.85	-3.95
4874.00	--	AV	54	--	--	--	--	--	--
7311.00	49.92	PK	74	24.08	50.28	36.54	6.81	43.71	-0.36
7311.00	--	AV	54	--	--	--	--	--	--

Frequency(MHz):			2437		Polarity:			VERTICAL	
Frequency (MHz)	Emission Level (dBuV/m)		Limit (dBuV/m)	Margin (dB)	Raw Value (dBuV)	Antenna Factor (dB/m)	Cable Factor (dB)	Pre-amplifier (dB)	Correction Factor (dB/m)
4874.00	47.34	PK	74	26.66	51.29	32.56	5.34	41.85	-3.95
4874.00	--	AV	54	--	--	--	--	--	--
7311.00	51.42	PK	74	22.58	51.78	36.54	6.81	43.71	-0.36
7311.00	--	AV	54	--	--	--	--	--	--

Frequency(MHz):			2462		Polarity:			HORIZONTAL	
Frequency (MHz)	Emission Level (dBuV/m)		Limit (dBuV/m)	Margin (dB)	Raw Value (dBuV)	Antenna Factor (dB/m)	Cable Factor (dB)	Pre-amplifier (dB)	Correction Factor (dB/m)
4924.00	47.28	PK	74	26.72	50.74	32.73	5.64	41.83	-3.46
4924.00	--	AV	54	--	--	--	--	--	--
7386.00	51.50	PK	74	22.50	51.56	36.50	7.23	43.79	-0.06
7386.00	--	AV	54	--	--	--	--	--	--

Frequency(MHz):			2462		Polarity:			VERTICAL	
Frequency (MHz)	Emission Level (dBuV/m)		Limit (dBuV/m)	Margin (dB)	Raw Value (dBuV)	Antenna Factor (dB/m)	Cable Factor (dB)	Pre-amplifier (dB)	Correction Factor (dB/m)
4924.00	47.78	PK	74	26.22	51.24	32.73	5.64	41.83	-3.46
4924.00	--	AV	54	--	--	--	--	--	--
7386.00	53.00	PK	74	21.00	53.06	36.50	7.23	43.79	-0.06
7386.00	--	AV	54	--	--	--	--	--	--

REMARKS:

1. Emission level (dBuV/m) =Raw Value (dBuV)+Correction Factor (dB/m)
2. Correction Factor (dB/m) = Antenna Factor (dB/m)+Cable Factor (dB)-Pre-amplifier Factor
3. Margin value = Limit value- Emission level.
4. -- Mean the PK detector measured value is below average limit.
5. The other emission levels were very low against the limit.
6. RBW1MHz VBW3MHz Peak detector is for PK value; RBW 1MHz VBW10Hz Peak detector is for AV value.

Results of Band Edges Test (Radiated)

Note: 802.11b/802.11g/802.11n (H20) /802.11n (H40) all have been tested, only worse case 802.11n (H40) (Ant1) was reported as below:

Frequency(MHz):			2422		Polarity:			HORIZONTAL	
Frequency (MHz)	Emission Level (dBuV/m)		Limit (dBuV/m)	Margin (dB)	Raw Value (dBuV)	Antenna Factor (dB/m)	Cable Factor (dB)	Pre-amplifier (dB)	Correction Factor (dB/m)
2390.00	63.05	PK	74.00	10.95	73.47	27.42	4.31	42.15	-10.42
2390.00	51.11	AV	54.00	2.89	61.53	27.42	4.31	42.15	-10.42

Frequency(MHz):			2422		Polarity:			VERTICAL	
Frequency (MHz)	Emission Level (dBuV/m)		Limit (dBuV/m)	Margin (dB)	Raw Value (dBuV)	Antenna Factor (dB/m)	Cable Factor (dB)	Pre-amplifier (dB)	Correction Factor (dB/m)
2390.00	65.35	PK	74.00	8.65	75.77	27.42	4.31	42.15	-10.42
2390.00	52.21	AV	54.00	1.79	62.63	27.42	4.31	42.15	-10.42

Frequency(MHz):			2452		Polarity:			HORIZONTAL	
Frequency (MHz)	Emission Level (dBuV/m)		Limit (dBuV/m)	Margin (dB)	Raw Value (dBuV)	Antenna Factor (dB/m)	Cable Factor (dB)	Pre-amplifier (dB)	Correction Factor (dB/m)
2483.50	62.88	PK	74.00	11.12	72.99	27.70	4.47	42.28	-10.11
2483.50	50.15	AV	54.00	3.85	60.26	27.70	4.47	42.28	-10.11

Frequency(MHz):			2452		Polarity:			VERTICAL	
Frequency (MHz)	Emission Level (dBuV/m)		Limit (dBuV/m)	Margin (dB)	Raw Value (dBuV)	Antenna Factor (dB/m)	Cable Factor (dB)	Pre-amplifier (dB)	Correction Factor (dB/m)
2483.50	65.38	PK	74.00	8.62	75.49	27.70	4.47	42.28	-10.11
2483.50	52.05	AV	54.00	1.95	62.16	27.70	4.47	42.28	-10.11

REMARKS:

1. Emission level (dBuV/m) =Raw Value (dBuV)+Correction Factor (dB/m)
2. Correction Factor (dB/m) = Antenna Factor (dB/m)+Cable Factor (dB)-Pre-amplifier Factor
3. Margin value = Limit value- Emission level.
4. -- Mean the PK detector measured value is below average limit.
5. The other emission levels were very low against the limit.
6. RBW1MHz VBW3MHz Peak detector is for PK value; RBW 1MHz VBW10Hz Peak detector is for AV value.

4.3 Maximum Conducted Output Power

Limit

The Maximum Peak Output Power Measurement is 30dBm.

Test Procedure

Remove the antenna from the EUT and then connect a low loss RF cable from the antenna port to the power sensor.

Test Configuration

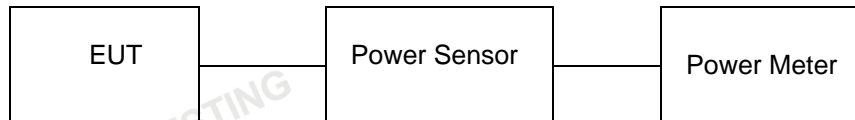

Test Results

WIFI

Type	Channel	Output power Ant1 (dBm)	Output power Ant2 (dBm)	Output power Total (dBm)	Limit (dBm)	Result
802.11b	01	22.49	20.66	/	30.00	Pass
	06	22.21	20.47	/		
	11	23.30	20.33	/		
802.11g	01	22.78	19.83	/	30.00	Pass
	06	21.65	19.18	/		
	11	21.86	18.99	/		
802.11n(HT20) MIMO	01	22.48	19.93	24.40	30.00	Pass
	06	22.39	19.50	24.19		
	11	21.71	19.29	23.68		
802.11n(HT40) MIMO	03	22.51	19.92	24.42	30.00	Pass
	06	21.56	19.23	23.56		
	09	21.62	18.11	23.22		

Note: 1.The test results including the cable lose.

4.4 Power Spectral Density

Limit

For digitally modulated systems, the power spectral density conducted from the intentional radiator to the antenna shall not be greater than 8 dBm in any 3 kHz band during any time interval of continuous transmission.

Test Procedure

1. Use this procedure when the maximum peak conducted output power in the fundamental emission is used to demonstrate compliance.
2. Set the RBW \geq 3 kHz.
3. Set the VBW \geq 3 \times RBW.
4. Set the span to 1.5 times the DTS channel bandwidth.
5. Detector = peak.
6. Sweep time = auto couple.
7. Trace mode = max hold.
8. Allow trace to fully stabilize.
9. Use the peak marker function to determine the maximum power level.
10. If measured value exceeds limit, reduce RBW (no less than 3 kHz) and repeat.
11. The resulting peak PSD level must be 8dBm.

Test Configuration

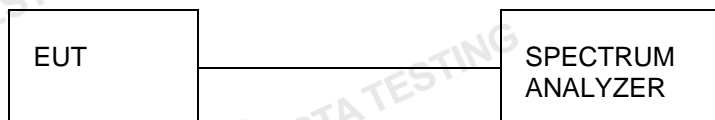

Test Results

WIFI						
Type	Channel	Power Spectral Density Ant1 (dBm/3KHz)	Power Spectral Density Ant2 (dBm/3KHz)	Power Spectral Density Total (dBm/3KHz)	Limit (dBm/3KHz)	Result
802.11b	01	-10.48	-12.29	/	8.00	Pass
	06	-10.36	-12.52	/		
	11	-9.65	-12.66	/		
802.11g	01	-12.33	-15.10	/	8.00	Pass
	06	-13.13	-15.71	/		
	11	-13.08	-16.00	/		
802.11n(HT20) MIMO	01	-12.31	-14.59	-10.29	8.00	Pass
	06	-12.36	-15.00	-10.47		
	11	-12.60	-15.18	-10.69		
802.11n(HT40) MIMO	03	-14.11	-14.88	-11.47	8.00	Pass
	06	-13.46	-16.92	-11.84		
	09	-14.06	-16.77	-12.20		

Test plot as follows:

802.11b

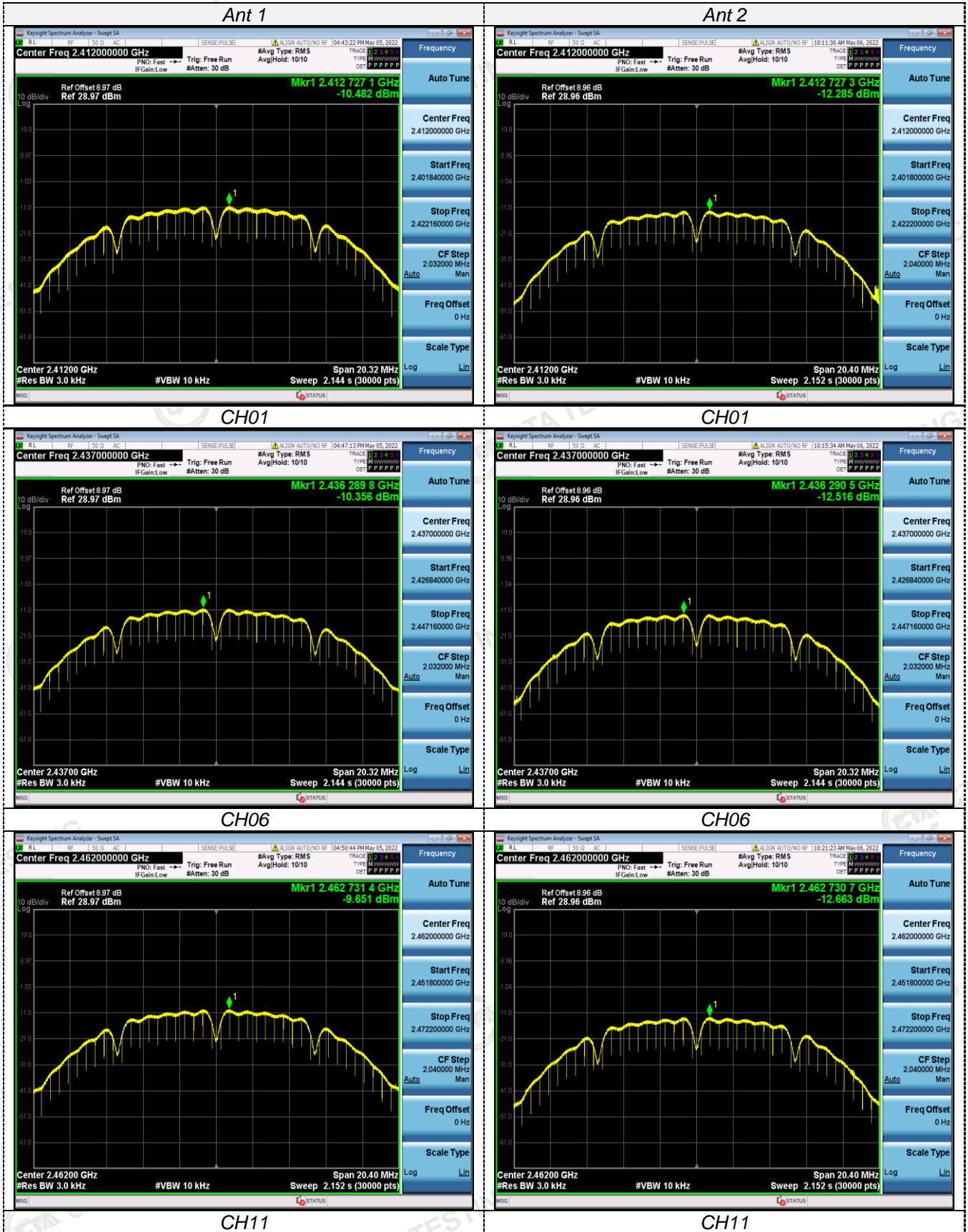

802.11g

Ant 1

Ant 2

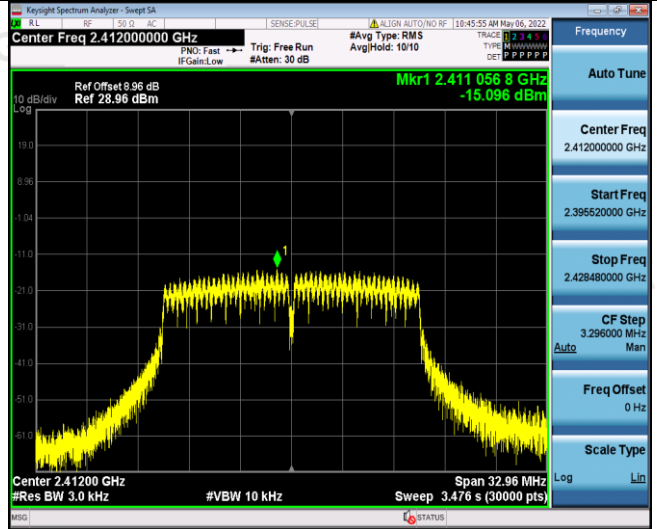
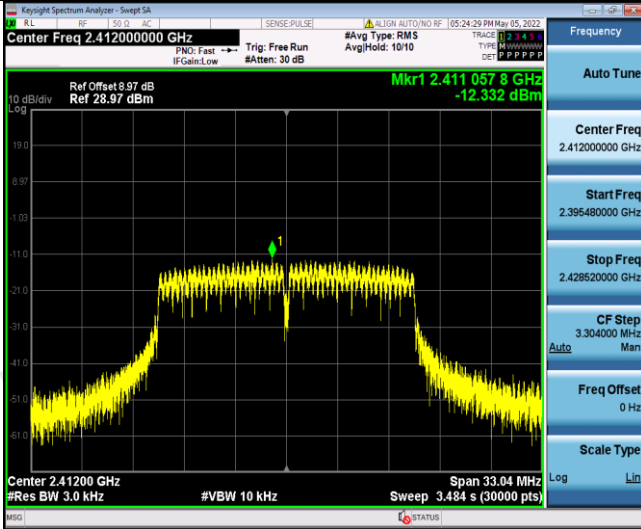

CH01

CH01

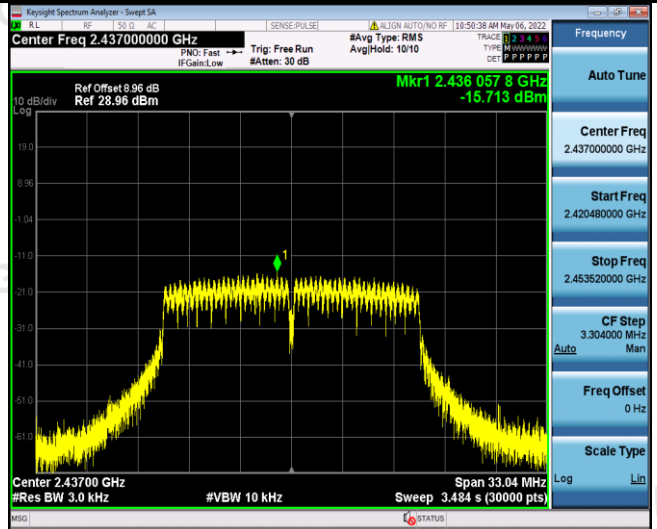
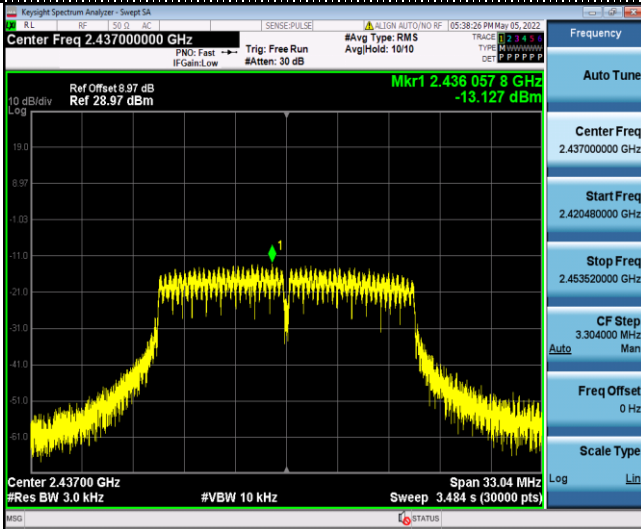

CH06

CH06

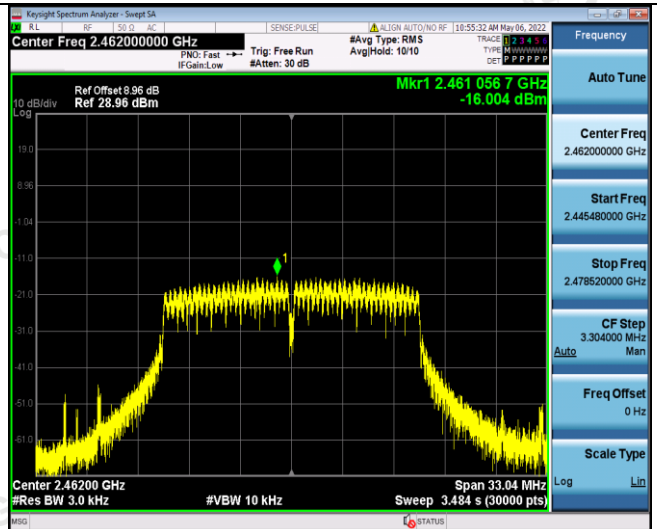
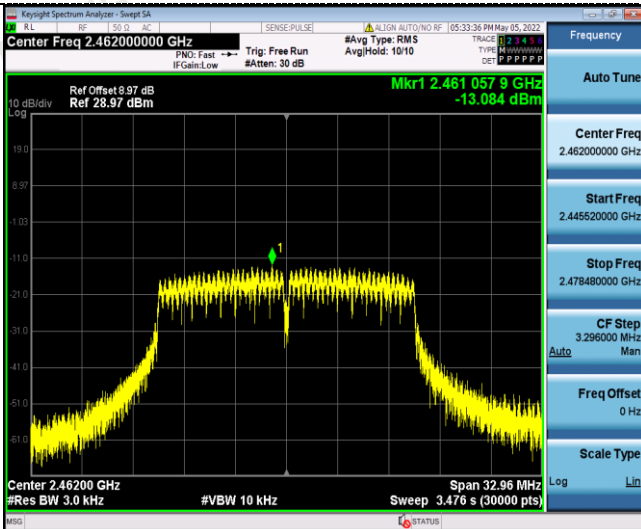

CH11

CH11

802.11n(HT20)

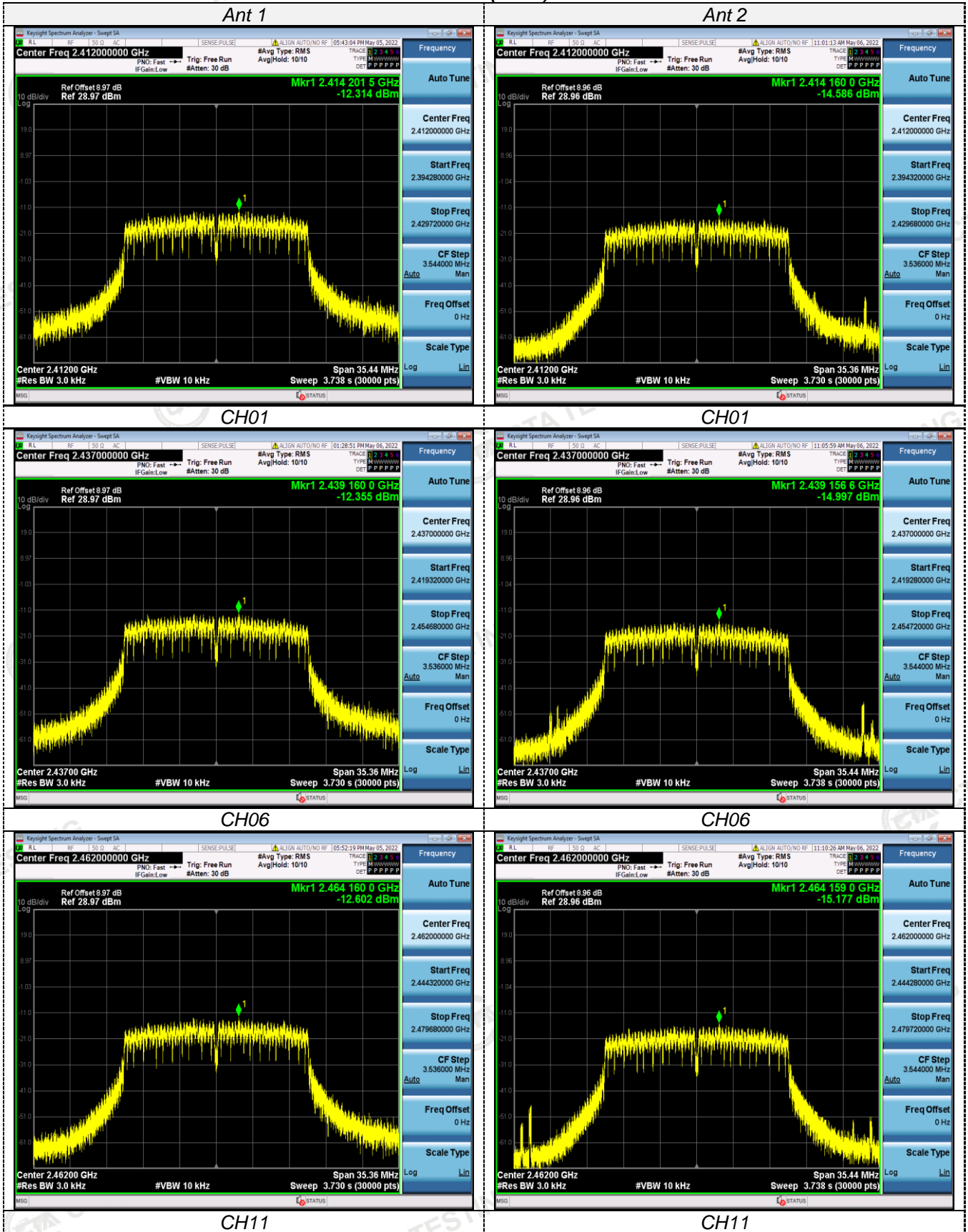

802.11n(HT40)

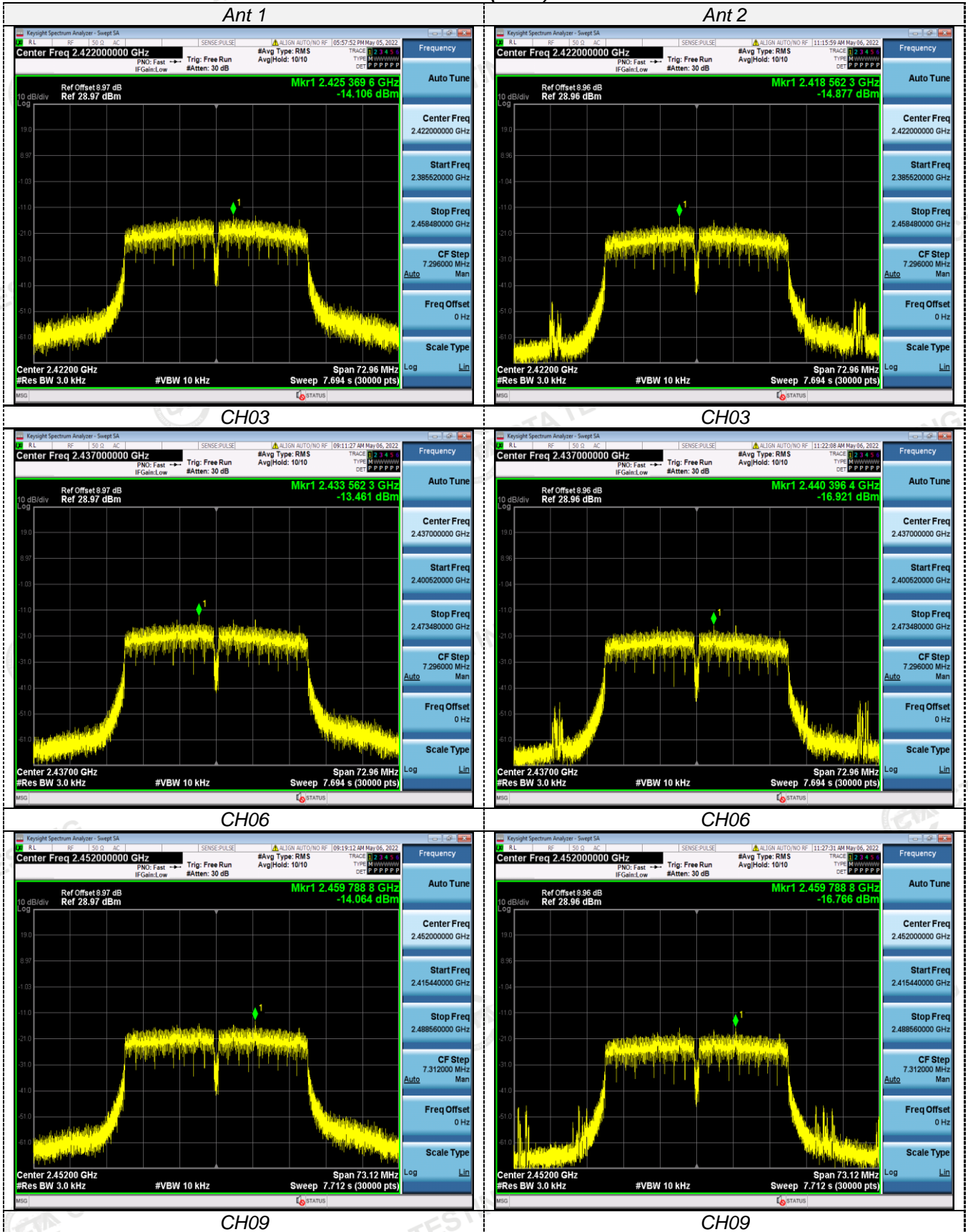

4.5 6dB Bandwidth

Limit

For digital modulation systems, the minimum 6 dB bandwidth shall be at least 500 kHz

Test Procedure

The transmitter output was connected to the spectrum analyzer through an attenuator. The bandwidth of the fundamental frequency was measured by spectrum analyzer with 100 KHz RBW and 300 KHz VBW. The 6dB bandwidth is defined as the total spectrum the power of which is higher than peak power minus 6dB.

Test Configuration



Test Results

WIFI

Type	Channel	6dB Bandwidth Ant1 (MHz)	6dB Bandwidth Ant2 (MHz)	Limit (KHz)	Result
802.11b	01	10.16	10.20	≥500	Pass
	06	10.16	10.16		
	11	10.20	10.20		
802.11g	01	16.52	16.48	≥500	Pass
	06	16.52	16.52		
	11	16.48	16.52		
802.11n(HT20)	01	17.72	17.68	≥500	Pass
	06	17.68	17.72		
	11	17.68	17.72		
802.11n(HT40)	03	36.48	36.48	≥500	Pass
	06	36.48	36.48		
	09	36.56	36.56		

Test plot as follows: