



SPORTON International Inc.

No. 52, Hwa Ya 1st Rd., Hwa Ya Technology Park, Kwei-Shan Hsiang, Tao Yuan Hsien, Taiwan, R.O.C.

Ph: 886-3-327-3456 / FAX: 886-3-327-0973 / www.sporton.com.tw

FCC RADIO TEST REPORT

Applicant's company	Tembo Systems, Inc.
Applicant Address	2933 Bunker Hill lane, Suite 100, Santa Clara, CA 95054 U.S.A
FCC ID	2AGMRTRM9995G
Manufacturer's company	Tembo Systems, Inc.
Manufacturer Address	2933 Bunker Hill lane, Suite 100, Santa Clara, CA 95054 U.S.A

Product Name	802.11ac WiFi Radio Module
Model No.	TRM9995G
Test Rule Part(s)	47 CFR FCC Part 15 Subpart E § 15.407
Test Freq. Range	5150 ~ 5250 MHz / 5725 ~ 5850 MHz
Received Date	May 27, 2016
Final Test Date	Aug. 19, 2016
Submission Type	Original Equipment

Statement

Test result included is for the IEEE 802.11n and IEEE 802.11a/ac of the product.

The test result in this report refers exclusively to the presented test model / sample.

Without written approval of SPORTON International Inc., the test report shall not be reproduced except in full.

The measurements and test results shown in this test report were made in accordance with the procedures and found in compliance with the limit given in **ANSI C63.10-2013,**

47 CFR FCC Part 15 Subpart E, KDB789033 D02 v01r03, KDB662911 D01 v02r01, KDB644545 D03 v01, ET Docket No. 13-49; FCC 16-24.

The test equipment used to perform the test is calibrated and traceable to NML/ROC.



Table of Contents

1. VERIFICATION OF COMPLIANCE	1
2. SUMMARY OF THE TEST RESULT	2
3. GENERAL INFORMATION	3
3.1. Product Details	3
3.2. Accessories	8
3.3. Table for Filed Antenna	9
3.4. Table for Carrier Frequencies	11
3.5. Table for Test Modes	12
3.6. Table for Testing Locations.....	18
3.7. Table for Supporting Units	18
3.8. Table for Parameters of Test Software Setting	21
3.9. EUT Operation during Test.....	25
3.10. Duty Cycle.....	25
3.11. Test Configurations.....	26
4. TEST RESULT	30
4.1. AC Power Line Conducted Emissions Measurement	30
4.2. 26dB Bandwidth and 99% Occupied Bandwidth Measurement	34
4.3. 6dB Spectrum Bandwidth Measurement	69
4.4. Maximum Conducted Output Power Measurement.....	83
4.5. Power Spectral Density Measurement.....	93
4.6. Radiated Emissions Measurement.....	119
4.7. Band Edge Emissions Measurement.....	187
4.8. Frequency Stability Measurement.....	249
4.9. Antenna Requirements	257
5. LIST OF MEASURING EQUIPMENTS	258
6. MEASUREMENT UNCERTAINTY	260
APPENDIX A. TEST PHOTOS	A1 ~ A5
APPENDIX B. MAXIMUM E.I.R.P. AT ANY ELEVATION ANGLE ABOVE 30 DEGREES	B1 ~ B3



History of This Test Report

REPORT NO.	VERSION	DESCRIPTION	ISSUED DATE
FR650411	Rev. 01	Initial issue of report	Sep. 13, 2016



1. VERIFICATION OF COMPLIANCE

Product Name : 802.11ac WiFi Radio Module
Model No. : TRM9995G
Applicant : Tembo Systems, Inc.
Test Rule Part(s) : 47 CFR FCC Part 15 Subpart E § 15.407

Sporton International as requested by the applicant to evaluate the EMC performance of the product sample received on May 27, 2016 would like to declare that the tested sample has been evaluated and found to be in compliance with the tested rule parts. The data recorded as well as the test configuration specified is true and accurate for showing the sample's EMC nature.

A handwritten signature in blue ink, appearing to read "Sam Chen", written over a horizontal line.

Sam Chen

SPORTON INTERNATIONAL INC.

2. SUMMARY OF THE TEST RESULT

Applied Standard: 47 CFR FCC Part 15 Subpart E			
Part	Rule Section	Description of Test	Result
4.1	15.207	AC Power Line Conducted Emissions	Complies
4.2	15.407(a)	26dB Spectrum Bandwidth and 99% Occupied Bandwidth	Complies
4.3	15.407(e)	6dB Spectrum Bandwidth	Complies
4.4	15.407(a)	Maximum Conducted Output Power	Complies
4.5	15.407(a)	Power Spectral Density	Complies
4.6	15.407(b)	Radiated Emissions	Complies
4.7	15.407(b)	Band Edge Emissions	Complies
4.8	15.407(g)	Frequency Stability	Complies
4.9	15.203	Antenna Requirements	Complies

Note:

<OMNI Antenna>

The EUT is a limited module which only limited to the host (model: AP1004WRe series).

The EUT was installed to the host (model: AP1004WRe series) to perform all the tests.

<Directional Antenna>

The EUT is a limited module which only limited to the host (model: AP1004NRe series).

The EUT was installed to the host (model: AP1004NRe series) to perform all the tests.

3. GENERAL INFORMATION

3.1. Product Details

Items	Description
Product Type	IEEE 802.11a/n/ac: WLAN (4TX, 4RX)
Radio Type	Intentional Transceiver
Power Type	From host system
Modulation	IEEE 802.11a: OFDM IEEE 802.11n/ac: see the below table
Data Modulation	IEEE 802.11a/n: OFDM (BPSK / QPSK / 16QAM / 64QAM) IEEE 802.11ac: OFDM (BPSK / QPSK / 16QAM / 64QAM / 256QAM)
Data Rate (Mbps)	IEEE 802.11a: OFDM (6/9/12/18/24/36/48/54) IEEE 802.11n/ac: see the below table
Frequency Range	5150 ~ 5250 MHz / 5725 ~ 5850 MHz
Channel Number	9 for 20MHz bandwidth ; 4 for 40MHz bandwidth 2 for 80MHz bandwidth

Channel Bandwidth (99%)	<p>For OMNI antenna:</p> <p>For indoor / outdoor use</p> <p><For Non-Beamforming Mode></p> <p>Band 1:</p> <p>IEEE 802.11a: 21.71 MHz</p> <p>IEEE 802.11ac MCS0/Nss1 (VHT20): 21.97 MHz</p> <p>IEEE 802.11ac MCS0/Nss1 (VHT40): 47.90 MHz</p> <p>IEEE 802.11ac MCS0/Nss1 (VHT80): 76.41 MHz</p> <p>Band 4:</p> <p>IEEE 802.11a: 33.08 MHz</p> <p>IEEE 802.11ac MCS0/Nss1 (VHT20): 33.26 MHz</p> <p>IEEE 802.11ac MCS0/Nss1 (VHT40): 63.24 MHz</p> <p>IEEE 802.11ac MCS0/Nss1 (VHT80): 76.99 MHz</p> <p><For Beamforming Mode></p> <p>Band 1:</p> <p>IEEE 802.11ac MCS0/Nss1 (VHT20): 18.76 MHz</p> <p>IEEE 802.11ac MCS0/Nss1 (VHT40): 47.03 MHz</p> <p>IEEE 802.11ac MCS0/Nss1 (VHT80): 79.31 MHz</p> <p>Band 4:</p> <p>IEEE 802.11ac MCS0/Nss1 (VHT20): 18.23 MHz</p> <p>IEEE 802.11ac MCS0/Nss1 (VHT40): 38.06 MHz</p> <p>IEEE 802.11ac MCS0/Nss1 (VHT80): 77.28 MHz</p> <p>For Directional antenna:</p> <p>For indoor / outdoor use</p> <p><For Non-Beamforming Mode></p> <p>Band 1:</p> <p>IEEE 802.11a: 16.15MHz</p> <p>IEEE 802.11ac MCS0/Nss1 (VHT20): 16.93 MHz</p> <p>IEEE 802.11ac MCS0/Nss1 (VHT40): 36.32 MHz</p> <p>IEEE 802.11ac MCS0/Nss1 (VHT80): 76.12 MHz</p> <p>Band 4:</p> <p>IEEE 802.11a: 16.41 MHz</p> <p>IEEE 802.11ac MCS0/Nss1 (VHT20): 17.37 MHz</p> <p>IEEE 802.11ac MCS0/Nss1 (VHT40): 35.89 MHz</p> <p>IEEE 802.11ac MCS0/Nss1 (VHT80): 75.54 MHz</p>
-------------------------	--

	<p><For Beamforming Mode></p> <p>Band 1:</p> <p>IEEE 802.11ac MCS0/Nss1 (VHT20): 17.97 MHz</p> <p>IEEE 802.11ac MCS0/Nss1 (VHT40): 36.90 MHz</p> <p>IEEE 802.11ac MCS0/Nss1 (VHT80): 76.70 MHz</p> <p>Band 4:</p> <p>IEEE 802.11ac MCS0/Nss1 (VHT20): 17.97 MHz</p> <p>IEEE 802.11ac MCS0/Nss1 (VHT40): 37.05 MHz</p> <p>IEEE 802.11ac MCS0/Nss1 (VHT80): 76.41 MHz</p>
<p>Maximum Conducted Output Power</p>	<p>For OMNI antenna:</p> <p>For indoor use</p> <p><For Non-Beamforming Mode></p> <p>Band 1:</p> <p>IEEE 802.11a: 27.05 dBm</p> <p>IEEE 802.11ac MCS0/Nss1 (VHT20): 26.74 dBm</p> <p>IEEE 802.11ac MCS0/Nss1 (VHT40): 27.08 dBm</p> <p>IEEE 802.11ac MCS0/Nss1 (VHT80): 24.34 dBm</p> <p>Band 4:</p> <p>IEEE 802.11a: 28.47 dBm</p> <p>IEEE 802.11ac MCS0/Nss1 (VHT20): 28.80 dBm</p> <p>IEEE 802.11ac MCS0/Nss1 (VHT40): 28.14 dBm</p> <p>IEEE 802.11ac MCS0/Nss1 (VHT80): 27.37 dBm</p> <p><For Beamforming Mode></p> <p>Band 1:</p> <p>IEEE 802.11ac MCS0/Nss1 (VHT20): 24.84 dBm</p> <p>IEEE 802.11ac MCS0/Nss1 (VHT40): 24.98 dBm</p> <p>IEEE 802.11ac MCS0/Nss1 (VHT80): 24.55 dBm</p> <p>Band 4:</p> <p>IEEE 802.11ac MCS0/Nss1 (VHT20): 25.12 dBm</p> <p>IEEE 802.11ac MCS0/Nss1 (VHT40): 25.26 dBm</p> <p>IEEE 802.11ac MCS0/Nss1 (VHT80): 24.35 dBm</p> <p>For Outdoor use</p> <p><For Non-Beamforming Mode></p> <p>Band 1:</p> <p>IEEE 802.11a: 27.05 dBm</p> <p>IEEE 802.11ac MCS0/Nss1 (VHT20): 26.74 dBm</p> <p>IEEE 802.11ac MCS0/Nss1 (VHT40): 27.08 dBm</p> <p>IEEE 802.11ac MCS0/Nss1 (VHT80): 24.34 dBm</p>

	<p><For Beamforming Mode></p> <p>Band 1:</p> <p>IEEE 802.11ac MCS0/Nss1 (VHT20): 23.83 dBm IEEE 802.11ac MCS0/Nss1 (VHT40): 23.83 dBm IEEE 802.11ac MCS0/Nss1 (VHT80): 23.53 dBm</p> <p>For Directional antenna:</p> <p>For indoor use</p> <p><For Non-Beamforming Mode></p> <p>Band 1:</p> <p>IEEE 802.11a: 22.97 dBm IEEE 802.11ac MCS0/Nss1 (VHT20): 22.89 dBm IEEE 802.11ac MCS0/Nss1 (VHT40): 22.98 dBm IEEE 802.11ac MCS0/Nss1 (VHT80): 21.81 dBm</p> <p>Band 4:</p> <p>IEEE 802.11a: 22.88 dBm IEEE 802.11ac MCS0/Nss1 (VHT20): 22.73 dBm IEEE 802.11ac MCS0/Nss1 (VHT40): 22.99 dBm IEEE 802.11ac MCS0/Nss1 (VHT80): 22.91 dBm</p> <p><For Beamforming Mode></p> <p>Band 1:</p> <p>IEEE 802.11ac MCS0/Nss1 (VHT20): 21.67 dBm IEEE 802.11ac MCS0/Nss1 (VHT40): 21.62 dBm IEEE 802.11ac MCS0/Nss1 (VHT80): 21.31 dBm</p> <p>Band 4:</p> <p>IEEE 802.11ac MCS0/Nss1 (VHT20): 21.98 dBm IEEE 802.11ac MCS0/Nss1 (VHT40): 21.98 dBm IEEE 802.11ac MCS0/Nss1 (VHT80): 21.77 dBm</p> <p>For Outdoor use</p> <p><For Non-Beamforming Mode></p> <p>Band 1:</p> <p>IEEE 802.11a: 21.97 dBm IEEE 802.11ac MCS0/Nss1 (VHT20): 21.88 dBm IEEE 802.11ac MCS0/Nss1 (VHT40): 21.97 dBm IEEE 802.11ac MCS0/Nss1 (VHT80): 21.81 dBm</p> <p><For Beamforming Mode></p> <p>Band 1:</p> <p>IEEE 802.11ac MCS0/Nss1 (VHT20): 20.69 dBm IEEE 802.11ac MCS0/Nss1 (VHT40): 20.65 dBm</p>
--	--

	IEEE 802.11ac MCS0/Nss1 (VHT80): 20.46 dBm
Carrier Frequencies	Please refer to section 3.4
Antenna	Please refer to section 3.3

Items	Description		
Communication Mode	<input checked="" type="checkbox"/>	IP Based (Load Based)	<input type="checkbox"/> Frame Based
Beamforming Function	<input checked="" type="checkbox"/>	With beamforming for 802.11n/ac	<input type="checkbox"/> Without beamforming
Operate Condition	<input checked="" type="checkbox"/>	Indoor	<input checked="" type="checkbox"/> Outdoor

Antenna and Bandwidth

Antenna	Four (TX)		
	20 MHz	40 MHz	80 MHz
IEEE 802.11a	V	X	X
IEEE 802.11n	V	V	X
IEEE 802.11ac	V	V	V

IEEE 11n/ac Spec.

Protocol	Number of Transmit Chains (NTX)	Data Rate / MCS
802.11n (HT20)	4	MCS 0-31
802.11n (HT40)	4	MCS 0-31
802.11ac (VHT20)	4	MCS 0-9/Nss1-4
802.11ac (VHT40)	4	MCS 0-9/Nss1-4
802.11ac (VHT80)	4	MCS 0-9/Nss1-4

Note 1: IEEE Std. 802.11n modulation consists of HT20 and HT40 (HT: High Throughput).
Then EUT supports HT20 and HT40.

Note 2: IEEE Std. 802.11ac modulation consists of VHT20, VHT40, VHT80 and VHT160 (VHT: Very High Throughput). Then EUT supports VHT20, VHT40 and VHT80.

Note 3: Modulation modes consist of below configuration:
HT20/HT40: IEEE 802.11n, VHT20/VHT40/VHT80: IEEE 802.11ac

3.2. Accessories

N/A

3.3. Table for Filed Antenna

Ant. Set	Brand Holder	Band	Model Name	Antenna Type	Connector	Gain (dBi)	TX Function	Host System Model
1	Tembo Systems Inc.	Band 1, 2 and Band 4	PCA-000007-XXX-X/ PCA-000005-XXX-X	OMNI Antenna	I-PEX	Note	4TX/4RX	AP1004WR e series
		Band 3	PCA-000006-000-X/ PCB-000015-XXX-X					
2	Tembo Systems Inc.	Band 1 and Band 2	PCA-000009-XXX-X	Directional Antenna	I-PEX	Note	4TX/4RX	AP1004NR e series
		Band 3	PCB-000011-XXX-X					
		Band 4	PCA-000010-XXX-X					

Note:

Ant. Set	Band	Gain (dBi)	Cable loss	True Gain (dBi)	Array Gain (dBi)
1	Band 1	5.06	9.90	-4.84	4
	Band 2	4.55	9.90	-5.35	4
	Band 3	4.82	1.35	3.47	4
	Band 4	5.03	10.9	-5.87	4

Ant. Set	Band	Tested Antenna Gain (dBi)	Cable loss (dB)	Tested net antenna gain (dBi)	Certified Net Antenna Gain (dBi)	Array Gain (dBi)
2	Band 1	13.6	1.6	12	13	1
	Band 2	13.6	1.6	12	13	1
	Band 3	15.3	1.6	13.7	14	1
	Band 4	13.6	1.6	12	13	1

Note: The EUT has two sets of antennas.

For IEEE 802.11a/n/ac mode <4TX/4RX>:

Chain 1, Chain 2, Chain 3 and Chain 4 will transmit/receive the same signal simultaneously.

Chain 1, Chain 2, Chain 3 and Chain 4 can be used as transmitting/receiving antennas.

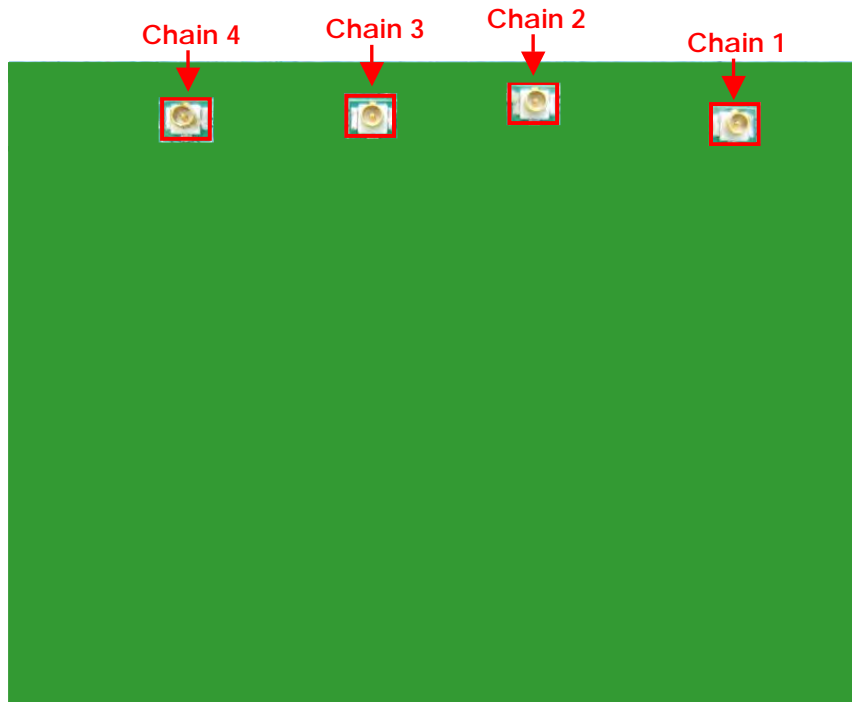

3.4. Table for Carrier Frequencies

There are three bandwidth systems.

For 20MHz bandwidth systems, use Channel 36, 40, 44, 48, 149, 153, 157, 161, 165.

For 40MHz bandwidth systems, use Channel 38, 46, 151, 159.

For 80MHz bandwidth systems, use Channel 42, 155.

Frequency Band	Channel No.	Frequency	Channel No.	Frequency
5150~5250 MHz Band 1	36	5180 MHz	44	5220 MHz
	38	5190 MHz	46	5230 MHz
	40	5200 MHz	48	5240 MHz
	42	5210 MHz	-	-
5725~5850 MHz Band 4	149	5745 MHz	157	5785 MHz
	151	5755 MHz	159	5795 MHz
	153	5765 MHz	161	5805 MHz
	155	5775 MHz	165	5825 MHz

3.5. Table for Test Modes

Preliminary tests were performed in different data rate to find the worst radiated emission. The data rate shown in the table below is the worst-case rate with respect to the specific test item. Investigation has been done on all the possible configurations for searching the worst cases. The following table is a list of the test modes shown in this test report.

Test Items	Mode	Data Rate	Channel	Chain		
AC Power Conducted Emission	Normal Link	-	-	-		
Max. Conducted Output Power	<For Non-Beamforming Mode>					
	11a/BPSK	Band 1&4	6Mbps	36/40/48 /149/157/165	1+2+3+4	
	11ac VHT20	Band 1&4	MCS0/Nss1	36/40/48 /149/157/165	1+2+3+4	
	11ac VHT40	Band 1&4	MCS0/Nss1	38/46/151/159	1+2+3+4	
	11ac VHT80	Band 1&4	MCS0/Nss1	42/155	1+2+3+4	
	<For Beamforming Mode>					
	11ac VHT20	Band 1&4	MCS0/Nss1	36/40/48 /149/157/165	1+2+3+4	
	11ac VHT40	Band 1&4	MCS0/Nss1	38/46/151/159	1+2+3+4	
	11ac VHT80	Band 1&4	MCS0/Nss1	42/155	1+2+3+4	
	Power Spectral Density	<For Non-Beamforming Mode>				
		11a/BPSK	Band 1&4	6Mbps	36/40/48 /149/157/165	1+2+3+4
		11ac VHT20	Band 1&4	MCS0/Nss1	36/40/48 /149/157/165	1+2+3+4
11ac VHT40		Band 1&4	MCS0/Nss1	38/46/151/159	1+2+3+4	
11ac VHT80		Band 1&4	MCS0/Nss1	42/155	1+2+3+4	
<For Beamforming Mode>						
11ac VHT20		Band 1&4	MCS0/Nss1	36/40/48 /149/157/165	1+2+3+4	



	11ac VHT40	Band 1&4	MCS0/Nss1	38/46/151/159	1+2+3+4
	11ac VHT80	Band 1&4	MCS0/Nss1	42/155	1+2+3+4

26dB Spectrum Bandwidth & 99% Occupied Bandwidth Measurement	<For Non-Beamforming Mode>				
	11a/BPSK	Band 1&4	6Mbps	36/40/48 /149/157/165	1+2+3+4
	11ac VHT20	Band 1&4	MCS0/Nss1	36/40/48 /149/157/165	1+2+3+4
	11ac VHT40	Band 1&4	MCS0/Nss1	38/46/151/159	1+2+3+4
	11ac VHT80	Band 1&4	MCS0/Nss1	42/155	1+2+3+4
	<For Beamforming Mode>				
	11ac VHT20	Band 1&4	MCS0/Nss1	36/40/48 /149/157/165	1+2+3+4
	11ac VHT40	Band 1&4	MCS0/Nss1	38/46/151/159	1+2+3+4
	11ac VHT80	Band 1&4	MCS0/Nss1	42/155	1+2+3+4
	6dB Spectrum Bandwidth Measurement	<For Non-Beamforming Mode>			
11a/BPSK		Band 4	6Mbps	149/157/165	1+2+3+4
11ac VHT20		Band 4	MCS0/Nss1	149/157/165	1+2+3+4
11ac VHT40		Band 4	MCS0/Nss1	151/159	1+2+3+4
11ac VHT80		Band 4	MCS0/Nss1	155	1+2+3+4
<For Beamforming Mode>					
11ac VHT20		Band 4	MCS0/Nss1	149/157/165	1+2+3+4
11ac VHT40		Band 4	MCS0/Nss1	151/159	1+2+3+4
11ac VHT80		Band 4	MCS0/Nss1	155	1+2+3+4
Radiated Emission Below 1GHz		Normal Link		-	-
Radiated Emission Above 1GHz	<For Non-Beamforming Mode>				
	11a/BPSK	Band 1&4	6Mbps	36/40/48 /149/157/165	1+2+3+4

	11ac VHT20	Band 1&4	MCS0/Nss1	36/40/48 /149/157/165	1+2+3+4
	11ac VHT40	Band 1&4	MCS0/Nss1	38/46/151/159	1+2+3+4
	11ac VHT80	Band 1&4	MCS0/Nss1	42/155	1+2+3+4
<For Beamforming Mode>					
	11ac VHT20	Band 1&4	MCS0/Nss1	36/40/48 /149/157/165	1+2+3+4
	11ac VHT40	Band 1&4	MCS0/Nss1	38/46/151/159	1+2+3+4
	11ac VHT80	Band 1&4	MCS0/Nss1	42/155	1+2+3+4

Band Edge Emission	<For Non-Beamforming Mode>				
	11a/BPSK	Band 1&4	6Mbps	36/40/48 /149/157/165	1+2+3+4
	11ac VHT20	Band 1&4	MCS0/Nss1	36/40/48 /149/157/165	1+2+3+4
	11ac VHT40	Band 1&4	MCS0/Nss1	38/46/151/159	1+2+3+4
	11ac VHT80	Band 1&4	MCS0/Nss1	42/155	1+2+3+4
	<For Beamforming Mode>				
	11ac VHT20	Band 1&4	MCS0/Nss1	36/40/48 /149/157/165	1+2+3+4
	11ac VHT40	Band 1&4	MCS0/Nss1	38/46/151/159	1+2+3+4
	11ac VHT80	Band 1&4	MCS0/Nss1	42/155	1+2+3+4
	Frequency Stability	20 MHz	Band 1&4	-	40/157
40 MHz		Band 1&4	-	38/151	1
80 MHz		Band 1&4	-	42/155	1

Note 1: VHT20/VHT40 covers HT20/HT40, due to same modulation. The power setting for 802.11n HT20 and HT40 are the same or lower than 802.11ac VHT20 and VHT40.

Note 2: The EUT supports AP mode and Repeater mode, but the Repeater mode doesn't supports DFS band.

Note 3: For outdoor use, only Maximum Conducted Output Power Measurement was tested for Band 1.

Other tests (26dB Bandwidth and 99% Occupied Bandwidth Measurement, 6dB Spectrum Bandwidth Measurement, Power Spectral Density Measurement, Radiated Emission Above 1GHz and Band Edge Emission) follow the results of indoor use.

Note 4: There are two modes of EUT, one is beamforming mode, and the other is non-beamforming mode for 802.11n/ac. All test results were recorded in this report.

The following test modes were performed for all tests:

Conducted Emissions	
Test Mode	Description
1	AP Mode with Ant.1
2	Repeater Mode with Ant.1
3	AP Mode with Ant.2
4	Repeater Mode with Ant.2
Mode 4 generated the worst test result, so it was recorded in this report.	

Radiated Emissions (Below 1GHz)	
Test Mode	Description
1	EUT Y axis - AP Mode with Ant.1
2	EUT X axis - AP Mode with Ant.1
Mode 1 has been evaluated to be the worst case between Mode 1-2, thus measurement for Mode 3 will follow this same test mode.	
3	EUT Y axis - Repeater Mode with Ant.1
4	EUT Y axis - AP Mode with Ant.2
5	EUT X axis - AP Mode with Ant.2
Mode 4 has been evaluated to be the worst case between Mode 4-5, thus measurement for Mode 6 will follow this same test mode.	
6	EUT Y axis - Repeater Mode with Ant.2
Mode 1 generated the worst test result, so it was recorded in this report.	

Radiated Emissions (Above 1GHz)	
Test Mode	Description
The EUT was performed at X axis and Y axis position for Radiated emission above 1GHz test, and the worst case was found at Y axis for Omni antenna and X axis for Directional antenna. So the measurement will follow this same test configuration.	
1	EUT Y axis + Ant.1
2	EUT X axis + Ant.2

3.6. Table for Testing Locations

Test Site Location					
Address:	No.8, Lane 724, Bo-ai St., Jhubei City, Hsinchu County 302, Taiwan, R.O.C.				
TEL:	886-3-656-9065				
FAX:	886-3-656-9085				
Test Site No.	Site Category	Location	FCC Designation No.	IC File No.	VCCI Reg. No
03CH01-CB	SAC	Hsin Chu	TW0006	IC 4086D	-
CO01-CB	Conduction	Hsin Chu	TW0006	IC 4086D	-
TH01-CB	OVEN Room	Hsin Chu	-	-	-

Open Area Test Site (OATS); Semi Anechoic Chamber (SAC).

3.7. Table for Supporting Units

For Test Site No: CO01-CB

Support Unit	Brand	Model	FCC ID
NB*5	DELL	E6430	DoC
PoE*2	ZyXEL	PoE12-HP	N/A
AP Router	Planex	GW-AP54SGX	KA220030603014-1
Host system	N/A	AP1004NRe series	DoC

For Test Site No: 03CH01-CB (Below 1GHz)

Support Unit	Brand	Model	FCC ID
NB*5	DELL	E4300	DoC
PoE*2	ZyXEL	PoE12-HP	N/A
Host system	N/A	AP1004WRe series	DoC
AP Router	Planex	GW-AP54SGX	KA220030603014-1

For OMNI antenna:

For Test Site No: 03CH01-CB <Above 1GHz>

<For Non-Beamforming Mode>

Support Unit	Brand	Model	FCC ID
NB*5	DELL	E4300	DoC
PoE*2	ZyXEL	PoE12-HP	N/A
Host system	N/A	AP1004WRe series	DoC

<For Beamforming Mode>

Support Unit	Brand	Model	FCC ID
NB*5	DELL	E4300	DoC
PoE*2	ZyXEL	PoE12-HP	N/A
Host system	N/A	AP1004WRe series	DoC
RX Device	N/A	AP1004NRe series, AP1004WRe series	DoC

For Directional antenna:

For Test Site No: 03CH01-CB <Above 1GHz>

<For Non-Beamforming Mode>

Support Unit	Brand	Model	FCC ID
NB*5	DELL	E4300	DoC
PoE*2	ZyXEL	PoE12-HP	N/A
Host system	N/A	AP1004NRe series	DoC

<For Beamforming Mode>

Support Unit	Brand	Model	FCC ID
NB*5	DELL	E4300	DoC
PoE*2	ZyXEL	PoE12-HP	N/A
Host system	N/A	AP1004NRe series	DoC
RX Device	N/A	AP1004NRe series, AP1004WRe series	DoC

For Test Site No: TH01-CB

For OMNI antenna:

Support Unit	Brand	Model	FCC ID
NB	DELL	E4300	DoC
Host system	N/A	AP1004WRe series	DoC
PoE*2	ZyXEL	PoE12-HP	N/A

For Directional antenna:

Support Unit	Brand	Model	FCC ID
NB	DELL	E4300	DoC
Host system	N/A	AP1004NRe series	DoC
PoE*2	ZyXEL	PoE12-HP	N/A

3.8. Table for Parameters of Test Software Setting

During testing, Channel and Power Controlling Software provided by the customer was used to control the operating channel as well as the output power level. The RF output power selection is for the setting of RF output power expected by the customer and is going to be fixed on the firmware of the final end product.

For OMNI antenna:

<For Non-Beamforming Mode> Band 1 / Band 4 Indoor, Outdoor use

Test Software Version	QCARCT					
Mode	Test Frequency (MHz)					
	NCB: 20MHz					
	5180 MHz	5200 MHz	5240 MHz	5745 MHz	5785 MHz	5825 MHz
802.11a	20.5	21.5	22	25	25	25
802.11ac MCS0/Nss1 VHT20	21	22	21.5	25	25	25
Mode	NCB: 40MHz					
802.11ac MCS0/Nss1 VHT40	5190 MHz		5230 MHz		5755 MHz	
	19.5		21		25	
802.11ac MCS0/Nss1 VHT80	5210 MHz			5775 MHz		
	19			22		

<For Beamforming Mode> Band 1 / Band 4 Indoor, Outdoor use

Test Software Version	QCARCT					
Mode	Test Frequency (MHz)					
	NCB: 20MHz					
	5180 MHz	5200 MHz	5240 MHz	5745 MHz	5785 MHz	5825 MHz
802.11ac MCS0/Nss1 VHT20	26	26	26	26	26	26
Mode	NCB: 40MHz					
802.11ac MCS0/Nss1 VHT40	5190 MHz		5230 MHz		5755 MHz	
	26		26		26	
802.11ac MCS0/Nss1 VHT80	5210 MHz			5775 MHz		
	26			26		

<For Non-Beamforming Mode> Band 1 Outdoor use

Test Software Version	QCARCT		
Mode	Test Frequency (MHz)		
	NCB: 20MHz		
	5180 MHz	5200 MHz	5240 MHz
802.11a	20.5	21.5	22
802.11ac MCS0/Nss1 VHT20	21	22	21.5
Mode	NCB: 40MHz		
802.11ac MCS0/Nss1 VHT40	5190 MHz		5230 MHz
	19.5		21
Mode	NCB: 80MHz		
802.11ac MCS0/Nss1 VHT80	5210 MHz		
	19		

<For Beamforming Mode> Band 1 Outdoor use

Test Software Version	QCARCT		
Mode	Test Frequency (MHz)		
	NCB: 20MHz		
	5180 MHz	5200 MHz	5240 MHz
802.11ac MCS0/Nss1 VHT20	25	25	25
Mode	NCB: 40MHz		
802.11ac MCS0/Nss1 VHT40	5190 MHz		5230 MHz
	25		25
Mode	NCB: 80MHz		
802.11ac MCS0/Nss1 VHT80	5210 MHz		
	26		

For Directional antenna:

<For Non-Beamforming Mode> Band 1 / Band 4 Indoor, Outdoor use

Test Software Version	QCARCT					
Mode	Test Frequency (MHz)					
	NCB: 20MHz					
	5180 MHz	5200 MHz	5240 MHz	5745 MHz	5785 MHz	5825 MHz
802.11a	17	17	17	17.5	17.5	18
802.11ac MCS0/Nss1 VHT20	17	17	16.5	17.5	17.5	18
Mode	NCB: 40MHz					
802.11ac MCS0/Nss1 VHT40	5190 MHz		5230 MHz		5755 MHz	
	15.5		16		16.5	
17.5		17				
Mode	NCB: 80MHz					
802.11ac MCS0/Nss1 VHT80	5210 MHz			5775 MHz		
	15.5			17.5		

<For Beamforming Mode> Band 1 / Band 4 Indoor, Outdoor use

Test Software Version	QCARCT					
Mode	Test Frequency (MHz)					
	NCB: 20MHz					
	5180 MHz	5200 MHz	5240 MHz	5745 MHz	5785 MHz	5825 MHz
802.11ac MCS0/Nss1 VHT20	22	22	22	22	23	23
Mode	NCB: 40MHz					
802.11ac MCS0/Nss1 VHT40	5190 MHz		5230 MHz		5755 MHz	
	21.5		21.5		22	
21.5		21.5		22		
Mode	NCB: 80MHz					
802.11ac MCS0/Nss1 VHT80	5210 MHz			5775 MHz		
	21.5			22		

<For Non-Beamforming Mode> Band 1 Outdoor use

Test Software Version	QCARCT		
Mode	Test Frequency (MHz)		
	NCB: 20MHz		
	5180 MHz	5200 MHz	5240 MHz
802.11a	16	16	16
802.11ac MCS0/Nss1 VHT20	16	16	15.5
Mode	NCB: 40MHz		
802.11ac MCS0/Nss1 VHT40	5190 MHz		5230 MHz
	14.5		15
Mode	NCB: 80MHz		
802.11ac MCS0/Nss1 VHT80	5210 MHz		
	15.5		

<For Beamforming Mode> Band 1 Outdoor use

Test Software Version	QCARCT		
Mode	Test Frequency (MHz)		
	NCB: 20MHz		
	5180 MHz	5200 MHz	5240 MHz
802.11ac MCS0/Nss1 VHT20	21	21	21
Mode	NCB: 40MHz		
802.11ac MCS0/Nss1 VHT40	5190 MHz		5230 MHz
	20.5		20.5
Mode	NCB: 80MHz		
802.11ac MCS0/Nss1 VHT80	5210 MHz		
	20.5		

3.9. EUT Operation during Test

<For Non-Beamforming Mode>

The EUT was programmed to be in continuously transmitting mode.

<For Beamforming Mode>

For Conducted Mode:

The EUT was programmed to be in continuously transmitting mode.

For Radiated Mode:

During the test, the following programs under WIN XP were executed.

The program was executed as follows:

1. During the test, the EUT operation to normal function.
2. Executed command fixed test channel under Telnet.
3. Executed "Lantest.exe " to link with the remote workstation to receive and transmit packet by RX Device and transmit duty cycle no less 98%

3.10. Duty Cycle

<For Non-Beamforming Mode>

Mode	On Time (ms)	On+Off Time (ms)	Duty Cycle (%)	Duty Factor (dB)	1/T Minimum VBW (kHz)
802.11a	2.060	2.130	96.71%	0.15	0.49
802.11ac MCS0/Nss1 VHT20	5.022	5.084	98.78%	0.05	0.01
802.11ac MCS0/Nss1 VHT40	2.060	2.140	96.26%	0.17	0.49
802.11ac MCS0/Nss1 VHT80	1.156	1.224	94.44%	0.25	0.87

<For Beamforming Mode>

Mode	On Time (ms)	On+Off Time (ms)	Duty Cycle (%)	Duty Factor (dB)	1/T Minimum VBW (kHz)
802.11ac MCS0/Nss1 VHT20	1.752	1.920	91.25%	0.40	0.57
802.11ac MCS0/Nss1 VHT40	1.664	1.856	89.66%	0.47	0.60
802.11ac MCS0/Nss1 VHT80	1.952	2.104	92.78%	0.33	0.51

3.11. Test Configurations

3.11.1. AC Power Line Conduction Emissions Test Configuration

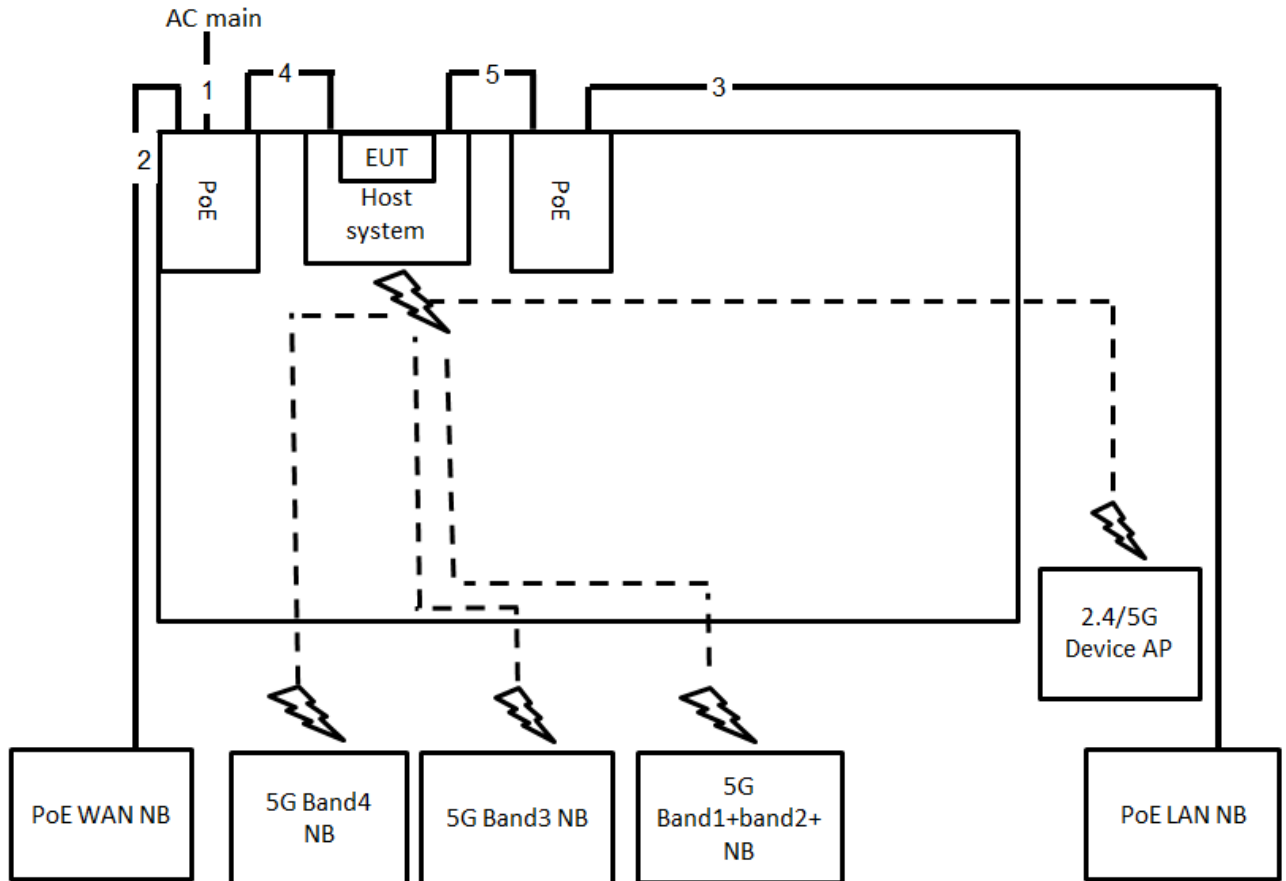

Item	Connection	Shielded	Length
1	Power cable	No	1.5m
2	RJ-45 cable	No	10m
3	RJ-45 cable	No	10m
4	RJ-45 cable*3	No	1.5m
5	RJ-45 cable	No	1.5m

3.11.2. Radiation Emissions Test Configuration

Test Configuration: 30MHz ~1GHz

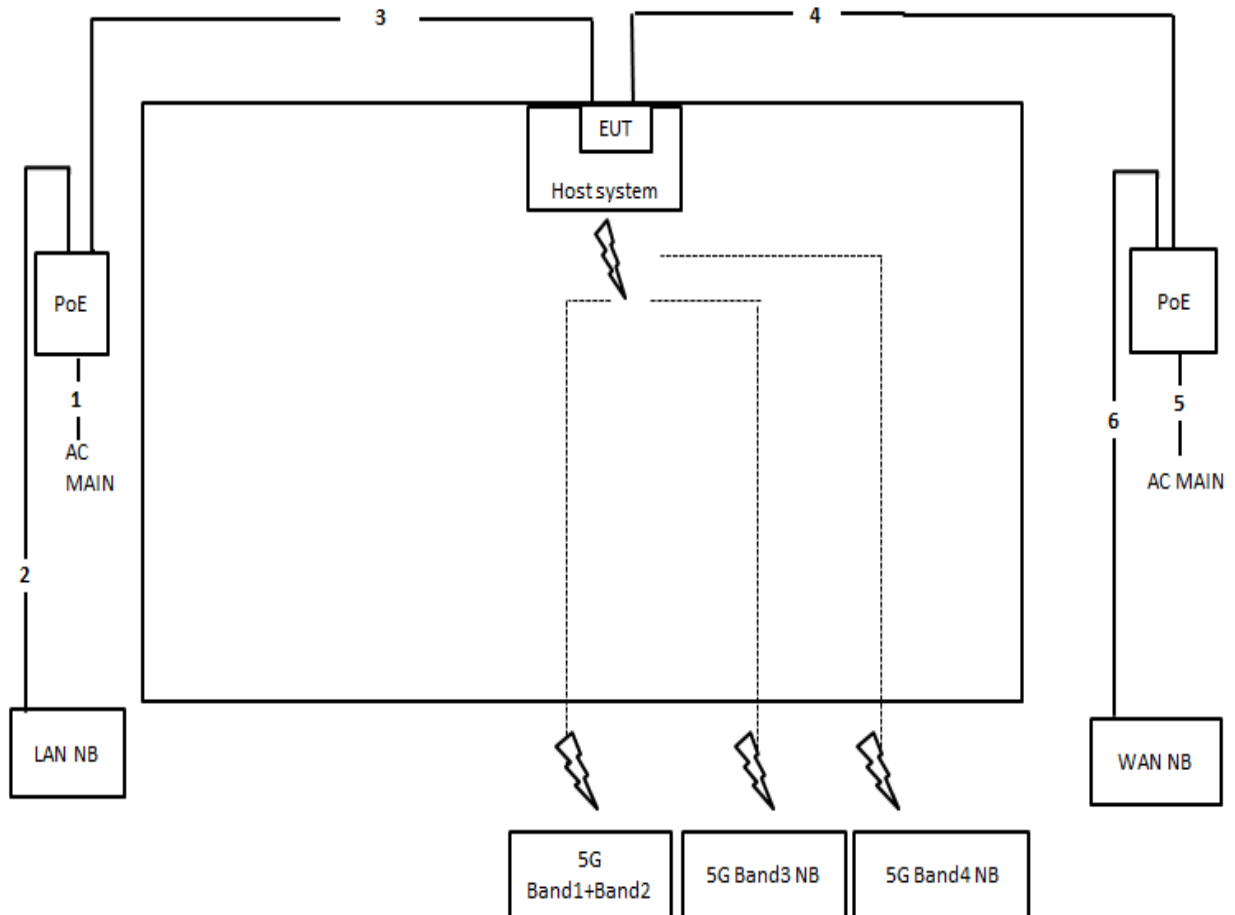

Item	Connection	Shielded	Length
1	Power cable	No	1.5m
2	RJ-45 cable	No	1.5m
3	RJ-45 cable	No	10m
4	RJ-45 cable	No	10m
5	Power cable	No	1.5m
6	RJ-45 cable	No	1.5m

<For Non-Beamforming Mode>

Test Configuration: above 1GHz

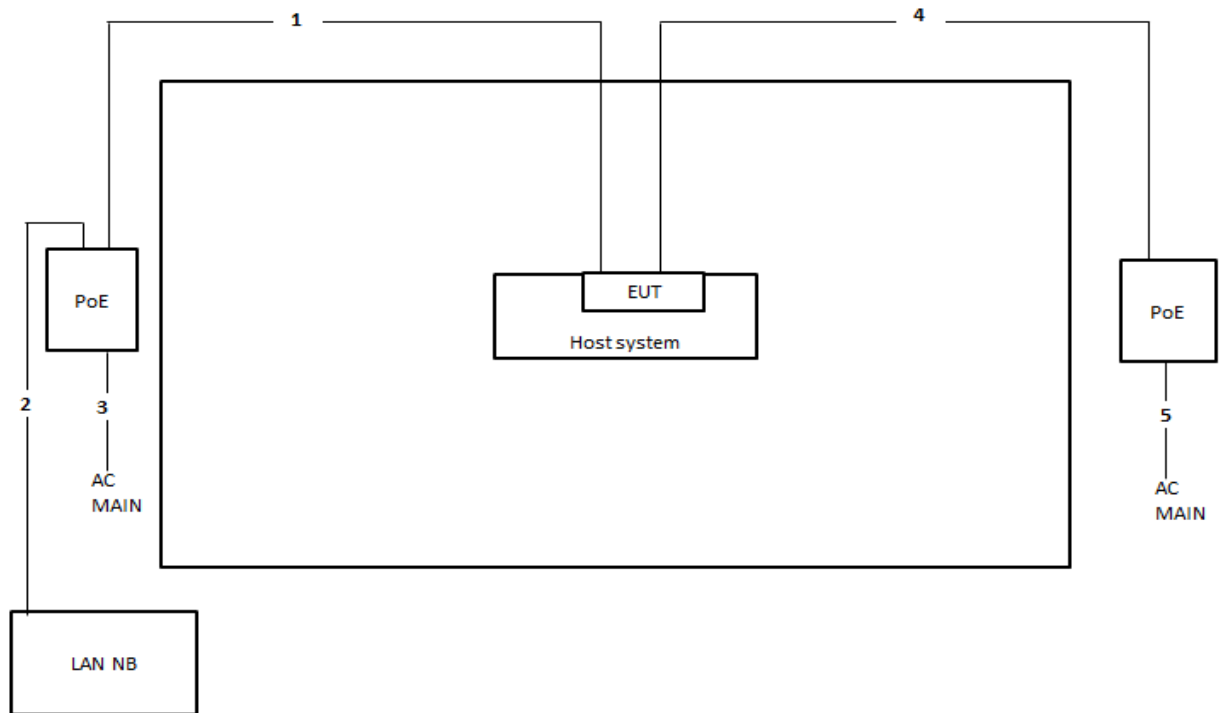

Item	Connection	Shielded	Length
1	RJ-45 cable	No	10m
2	RJ-45 cable	No	1.5m
3	Power cable	No	1.5m
4	RJ-45 cable	No	10m
5	Power cable	No	1.5m

<For Beamforming Mode>

Test Configuration: above 1GHz

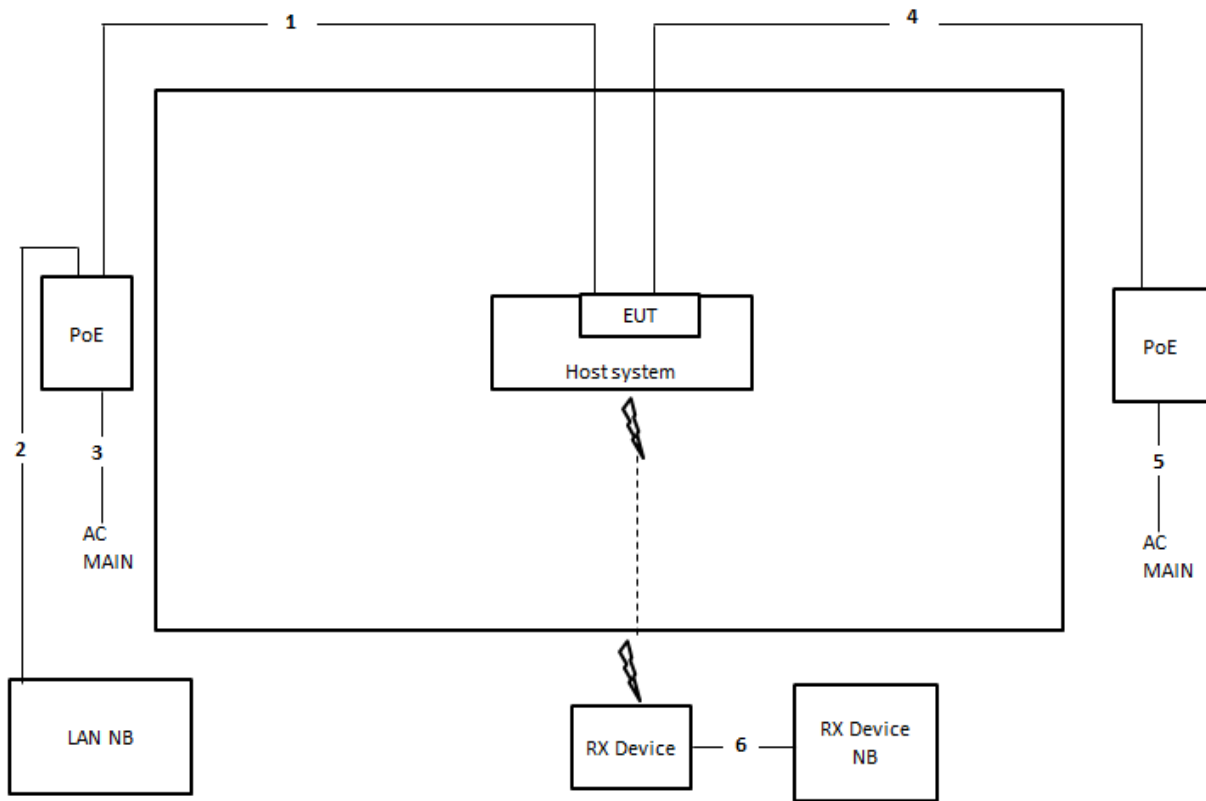

Item	Connection	Shielded	Length
1	RJ-45 cable	No	10m
2	RJ-45 cable	No	1.5m
3	Power cable	No	1.5m
4	RJ-45 cable	No	10m
5	Power cable	No	1.5m
6	RJ-45 cable	No	1.5m

4. TEST RESULT

4.1. AC Power Line Conducted Emissions Measurement

4.1.1. Limit

For this product that is designed to connect to the AC power line, the radio frequency voltage that is conducted back onto the AC power line on any frequency or frequencies within the band 150 kHz to 30 MHz shall not exceed below limits table.

Frequency (MHz)	QP Limit (dBuV)	AV Limit (dBuV)
0.15~0.5	66~56	56~46
0.5~5	56	46
5~30	60	50

4.1.2. Measuring Instruments and Setting

Please refer to section 5 of equipments list in this report. The following table is the setting of the receiver.

Receiver Parameters	Setting
Attenuation	10 dB
Start Frequency	0.15 MHz
Stop Frequency	30 MHz
IF Bandwidth	9 kHz

4.1.3. Test Procedures

1. Configure the EUT according to ANSI C63.10. The EUT or host of EUT has to be placed 0.4 meter far from the conducting wall of the shielding room and at least 80 centimeters from any other grounded conducting surface.
2. Connect EUT or host of EUT to the power mains through a line impedance stabilization network (LISN).
3. All the support units are connected to the other LISNs. The LISN should provide 50uH/50ohms coupling impedance.
4. The frequency range from 150 kHz to 30 MHz was searched.
5. Set the test-receiver system to Peak Detect Function and Specified Bandwidth with Maximum Hold Mode.
6. The measurement has to be done between each power line and ground at the power terminal.

4.1.4. Test Setup Layout

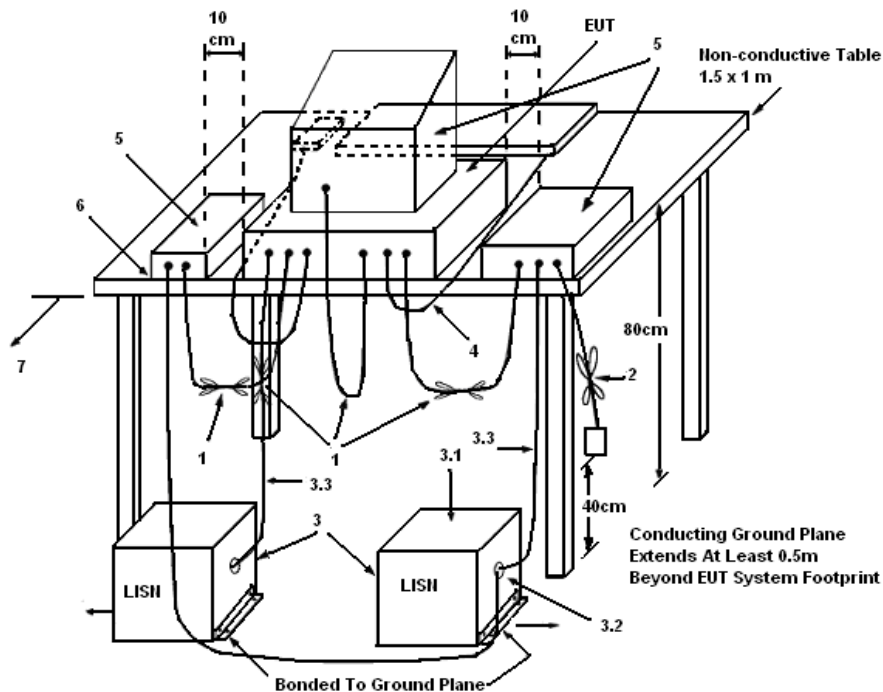

LEGEND:

- (1) Interconnecting cables that hang closer than 40 cm to the ground plane shall be folded back and forth in the center forming a bundle 30 to 40 cm long.
- (2) I/O cables that are not connected to a peripheral shall be bundled in the center. The end of the cable may be terminated, if required, using the correct terminating impedance. The overall length shall not exceed 1 m.
- (3) EUT connected to one LISN. Unused LISN measuring port connectors shall be terminated in 50 Ω . LISN can be placed on top of, or immediately beneath, reference ground plane.
 - (3.1) All other equipment powered from additional LISN(s).
 - (3.2) Multiple outlet strip can be used for multiple power cords of non-EUT equipment.
 - (3.3) LISN at least 80 cm from nearest part of EUT chassis.
- (4) Cables of hand-operated devices, such as keyboards, mice, etc., shall be placed as for normal use.
- (5) Non-EUT components of EUT system being tested.
- (6) Rear of EUT, including peripherals, shall all be aligned and flush with rear of tabletop.
- (7) Rear of tabletop shall be 40 cm removed from a vertical conducting plane that is bonded to the ground plane.

4.1.5. Test Deviation

There is no deviation with the original standard.

4.1.6. EUT Operation during Test

The EUT was placed on the test table and programmed in normal function.

4.1.7. Results of AC Power Line Conducted Emissions Measurement

Temperature	23°C	Humidity	60%
Test Engineer	Kane Liu	Phase	Line
Configuration	Normal Link	Test Mode	Mode 4

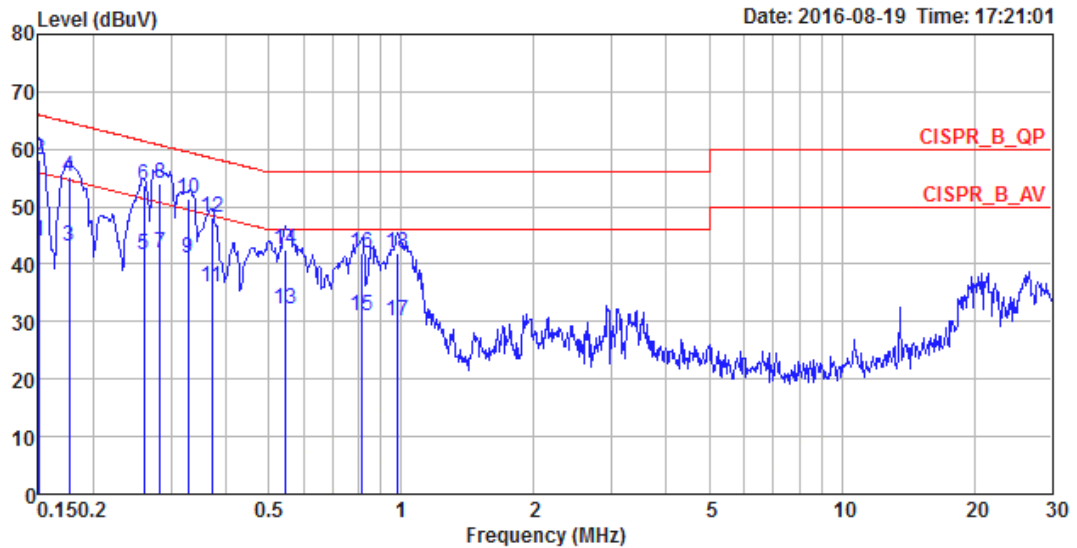

	Freq	Level	Over Limit	Limit Line	Read Level	LISN Factor	Cable Loss	Pol/Phase	Remark
	MHz	dBuV	dB	dBuV	dBuV	dB	dB		
1	0.1508	43.88	-12.08	55.96	33.70	10.02	0.16	LINE	Average
2	0.1508	58.30	-7.66	65.96	48.12	10.02	0.16	LINE	QP
3	0.1758	43.11	-11.57	54.68	33.01	9.92	0.18	LINE	Average
4	0.1758	55.19	-9.49	64.68	45.09	9.92	0.18	LINE	QP
5	0.2603	41.58	-9.84	51.42	31.54	9.92	0.12	LINE	Average
6	0.2603	53.61	-7.81	61.42	43.57	9.92	0.12	LINE	QP
7	0.2833	41.78	-8.94	50.72	31.76	9.92	0.10	LINE	Average
8	0.2833	54.02	-6.70	60.72	44.00	9.92	0.10	LINE	QP
9	0.3286	40.99	-8.50	49.49	31.01	9.92	0.06	LINE	Average
10	0.3286	51.47	-8.02	59.49	41.49	9.92	0.06	LINE	QP
11	0.3712	36.05	-12.42	48.47	26.10	9.92	0.03	LINE	Average
12	0.3712	48.03	-10.44	58.47	38.08	9.92	0.03	LINE	QP
13	0.5464	32.03	-13.97	46.00	21.84	9.93	0.26	LINE	Average
14	0.5464	42.45	-13.55	56.00	32.26	9.93	0.26	LINE	QP
15	0.8131	30.89	-15.11	46.00	20.39	9.93	0.57	LINE	Average
16	0.8131	41.89	-14.11	56.00	31.39	9.93	0.57	LINE	QP
17	0.9839	30.00	-16.00	46.00	19.33	9.94	0.73	LINE	Average
18	0.9839	41.78	-14.22	56.00	31.11	9.94	0.73	LINE	QP

Temperature	23°C	Humidity	60%
Test Engineer	Kane Liu	Phase	Neutral
Configuration	Normal Link	Test Mode	Mode 4

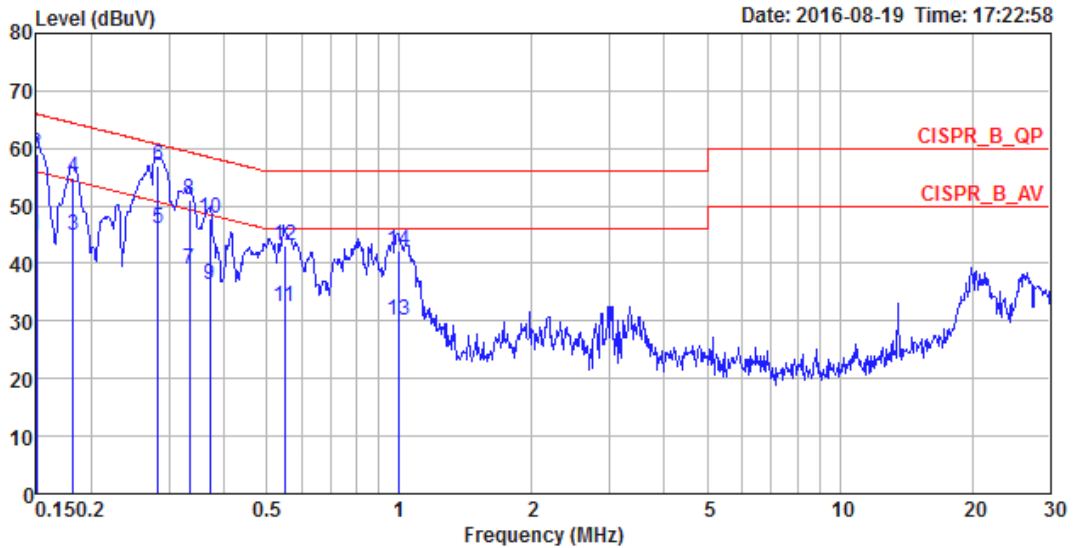

	Freq	Level	Over Limit	Limit Line	Read Level	LISN Factor	Cable Loss	Pol/Phase	Remark
	MHz	dBuV	dB	dBuV	dBuV	dB	dB		
1	0.1500	44.77	-11.23	56.00	34.59	10.02	0.16	NEUTRAL	Average
2	0.1500	59.09	-6.91	66.00	48.91	10.02	0.16	NEUTRAL	QP
3	0.1815	44.78	-9.64	54.42	34.68	9.92	0.18	NEUTRAL	Average
4	0.1815	54.89	-9.53	64.42	44.79	9.92	0.18	NEUTRAL	QP
5	0.2833	45.97	-4.75	50.72	35.95	9.92	0.10	NEUTRAL	Average
6	0.2833	57.00	-3.72	60.72	46.98	9.92	0.10	NEUTRAL	QP
7	0.3338	39.07	-10.28	49.35	29.09	9.92	0.06	NEUTRAL	Average
8	0.3338	51.19	-8.16	59.35	41.21	9.92	0.06	NEUTRAL	QP
9	0.3712	36.17	-12.30	48.47	26.22	9.92	0.03	NEUTRAL	Average
10	0.3712	47.93	-10.54	58.47	37.98	9.92	0.03	NEUTRAL	QP
11	0.5493	32.43	-13.57	46.00	22.24	9.93	0.26	NEUTRAL	Average
12	0.5493	43.18	-12.82	56.00	32.99	9.93	0.26	NEUTRAL	QP
13	0.9944	30.19	-15.81	46.00	19.52	9.94	0.73	NEUTRAL	Average
14	0.9944	42.34	-13.66	56.00	31.67	9.94	0.73	NEUTRAL	QP

Note:

Level = Read Level + LISN Factor + Cable Loss.

4.2. 26dB Bandwidth and 99% Occupied Bandwidth Measurement

4.2.1. Limit

No restriction limits.

4.2.2. Measuring Instruments and Setting

Please refer to section 5 of equipments list in this report. The following table is the setting of the spectrum analyzer.

26dB Bandwidth	
Spectrum Parameters	Setting
Attenuation	Auto
Span Frequency	> 26dB Bandwidth
RBW	Approximately 1% of the emission bandwidth
VBW	VBW > RBW
Detector	Peak
Trace	Max Hold
Sweep Time	Auto
99% Occupied Bandwidth	
Spectrum Parameters	Setting
Span	1.5 times to 5.0 times the OBW
RBW	1 % to 5 % of the OBW
VBW	$\geq 3 \times \text{RBW}$
Detector	Peak
Trace	Max Hold

4.2.3. Test Procedures

For Radiated 26dB Bandwidth and 99% Occupied Bandwidth Measurement:

1. The transmitter was radiated to the spectrum analyzer in peak hold mode.
2. Measure the maximum width of the emission that is 26 dB down from the peak of the emission. Compare this with the RBW setting of the analyzer. Readjust RBW and repeat measurement as needed until the RBW/EBW ratio is approximately 1%.

4.2.4. Test Setup Layout

For Radiated 26dB Bandwidth and 99% Occupied Bandwidth Measurement:

This test setup layout is the same as that shown in section 4.6.4.

4.2.5. Test Deviation

There is no deviation with the original standard.

4.2.6. EUT Operation during Test

The EUT was programmed to be in continuously transmitting mode.

4.2.7. Test Result of 26dB Bandwidth and 99% Occupied Bandwidth

For OMNI antenna:

<For Non-Beamforming Mode> Band 1 / Band 4 Indoor, Outdoor use

Temperature	25°C	Humidity	60%
Test Engineer	Akina Chiu		

Mode	Frequency	26dB Bandwidth (MHz)	99% Occupied Bandwidth (MHz)
802.11a	5180 MHz	17.39	15.54
	5200 MHz	34.09	16.41
	5240 MHz	34.09	21.71
	5745 MHz	42.61	33.08
	5785 MHz	35.74	29.35
	5825 MHz	37.39	31.52
802.11ac MCS0/Nss1 VHT20	5180 MHz	18.26	16.41
	5200 MHz	34.70	21.97
	5240 MHz	32.96	17.19
	5745 MHz	47.30	32.74
	5785 MHz	42.00	30.48
	5825 MHz	40.78	33.26
802.11ac MCS0/Nss1 VHT40	5190 MHz	45.07	36.76
	5230 MHz	81.59	47.90
	5755 MHz	83.77	60.49
	5795 MHz	88.70	63.24
802.11ac MCS0/Nss1 VHT80	5210 MHz	81.74	76.41
	5775 MHz	122.90	76.99

26dB Bandwidth and 99% Occupied Bandwidth Plot on Configuration IEEE 802.11a / Chain 1 + Chain 2 + Chain 3+ Chain 4 / 5180 MHz

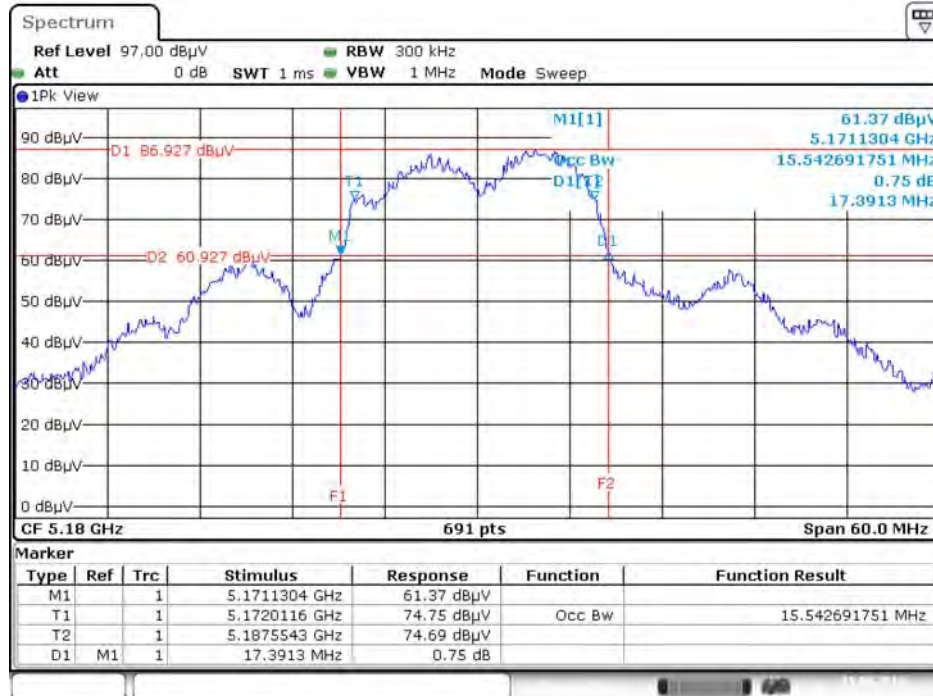

Date: 15.AUG.2016 17:26:30

26dB Bandwidth and 99% Occupied Bandwidth Plot on Configuration IEEE 802.11a / Chain 1 + Chain 2 + Chain 3+ Chain 4 / 5200 MHz

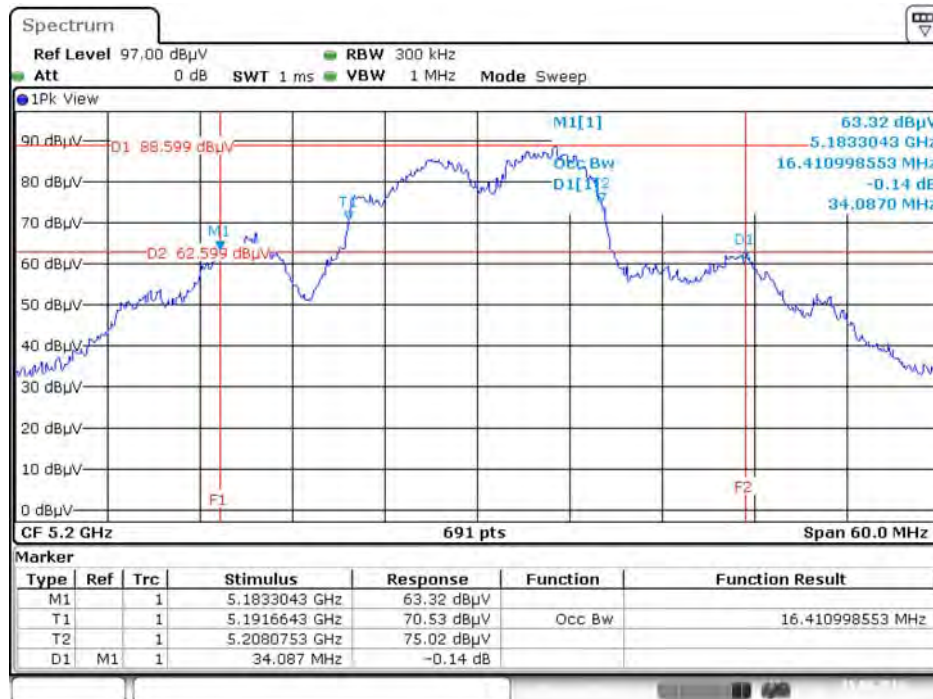

Date: 15.AUG.2016 17:27:05

26dB Bandwidth and 99% Occupied Bandwidth Plot on Configuration IEEE 802.11a / Chain 1 + Chain 2 + Chain 3+ Chain 4 / 5240 MHz

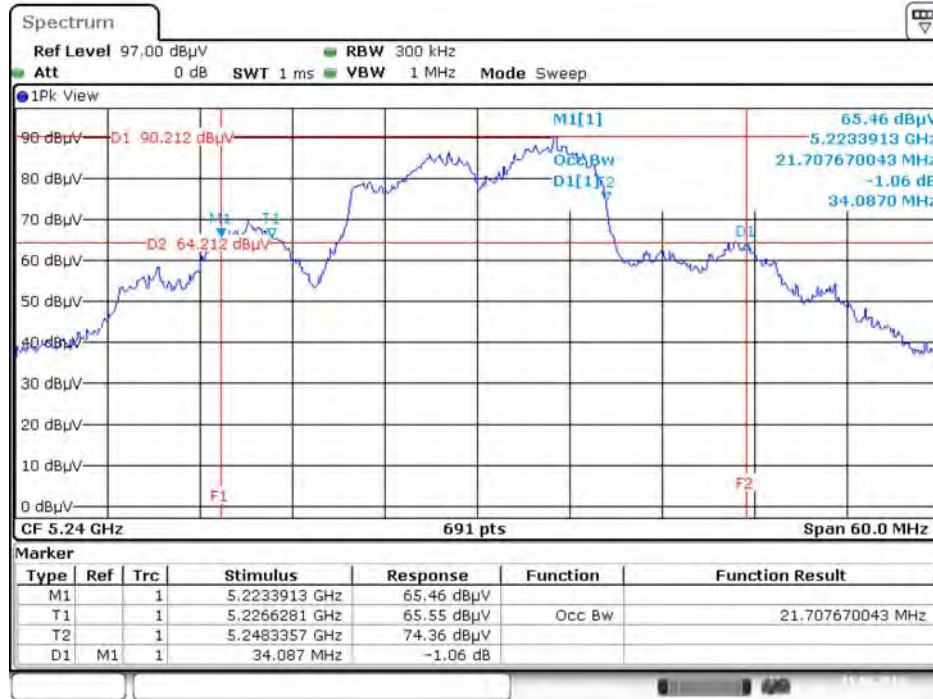

Date: 15.AUG.2016 17:27:41

26dB Bandwidth and 99% Occupied Bandwidth Plot on Configuration IEEE 802.11a / Chain 1 + Chain 2 + Chain 3+ Chain 4 / 5745 MHz

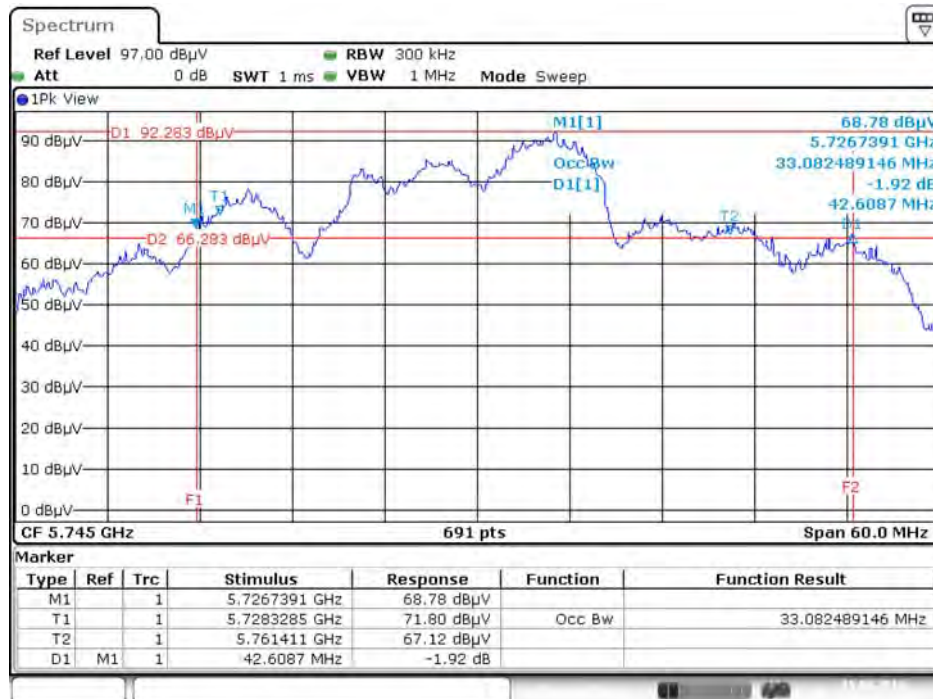

Date: 15.AUG.2016 19:14:48

26dB Bandwidth and 99% Occupied Bandwidth Plot on Configuration IEEE 802.11a / Chain 1 + Chain 2 + Chain 3+ Chain 4 / 5785 MHz

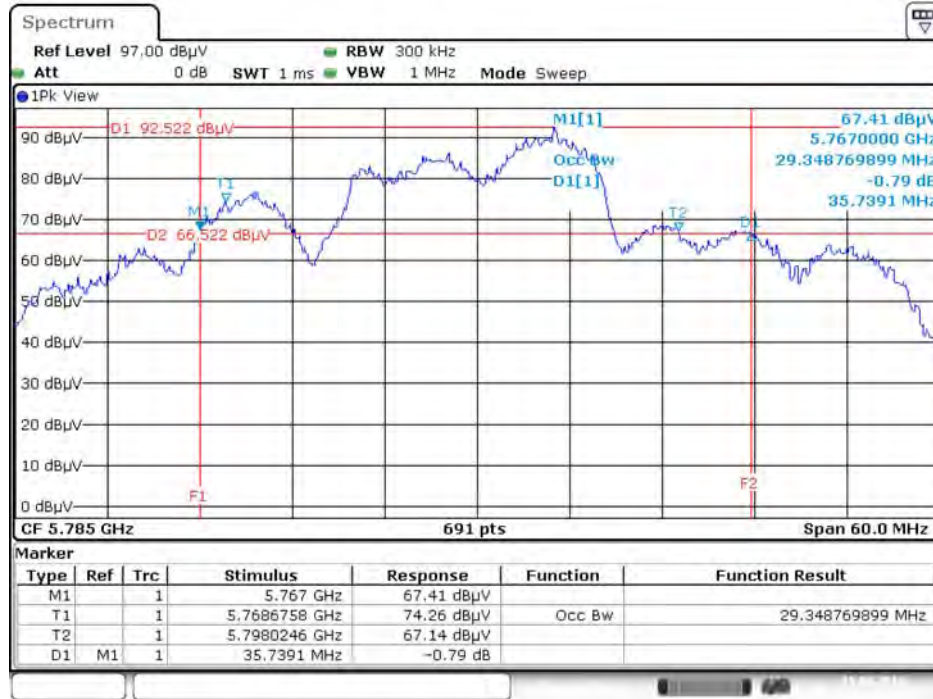

Date: 15.AUG.2016 19:15:56

26dB Bandwidth and 99% Occupied Bandwidth Plot on Configuration IEEE 802.11a / Chain 1 + Chain 2 + Chain 3+ Chain 4 / 5825 MHz

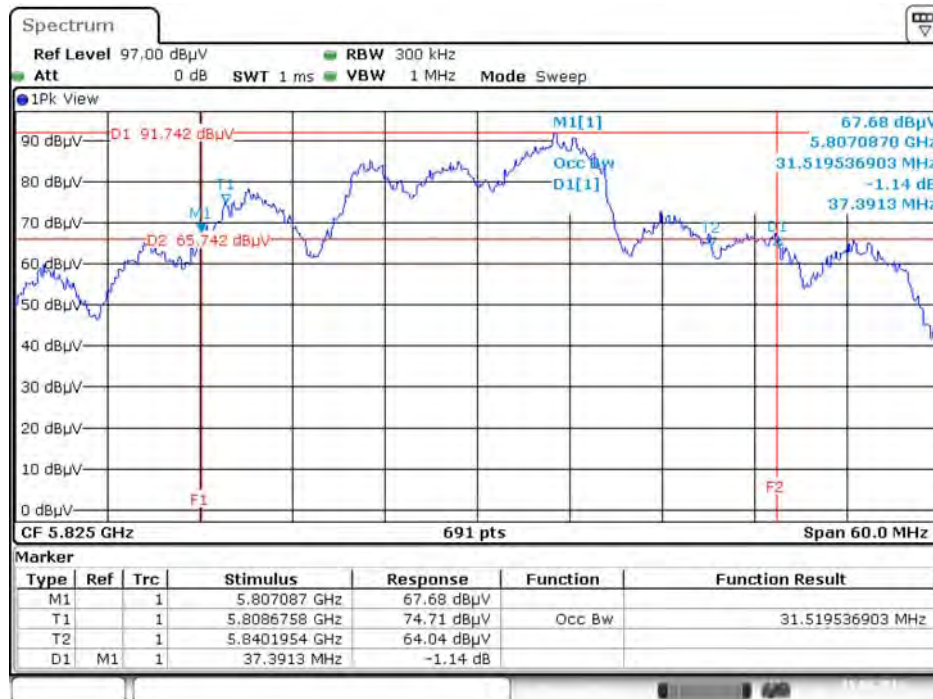

Date: 15.AUG.2016 19:16:27

26dB Bandwidth and 99% Occupied Bandwidth Plot on Configuration IEEE 802.11ac MCS0/Nss1 VHT20 / Chain 1 + Chain 2 + Chain 3+ Chain 4 / 5180 MHz

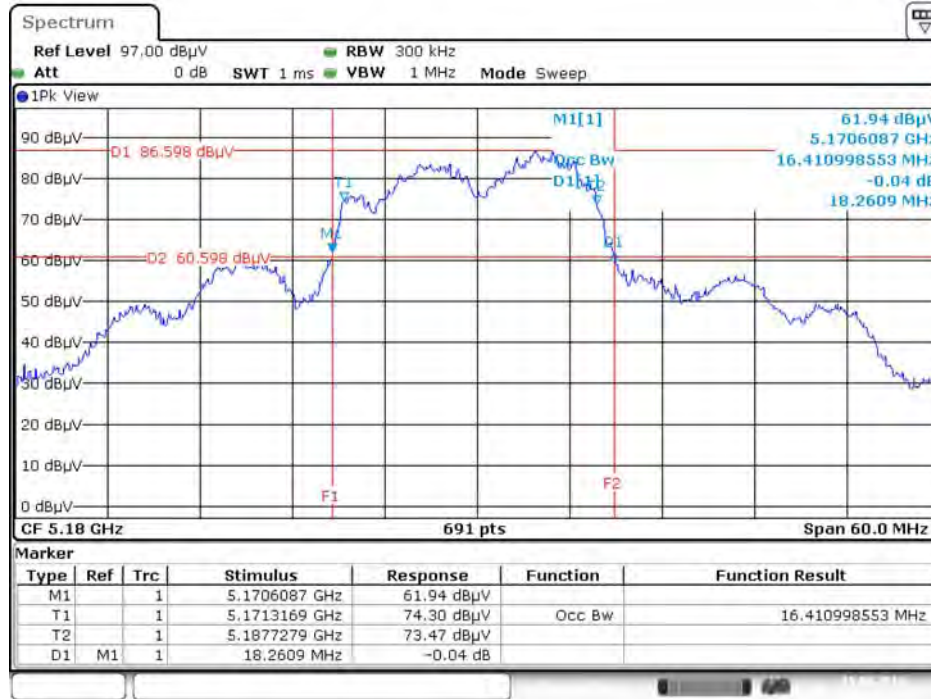

Date: 15.AUG.2016 17:30:35

26dB Bandwidth and 99% Occupied Bandwidth Plot on Configuration IEEE 802.11ac MCS0/Nss1 VHT20 / Chain 1 + Chain 2 + Chain 3+ Chain 4 / 5200 MHz

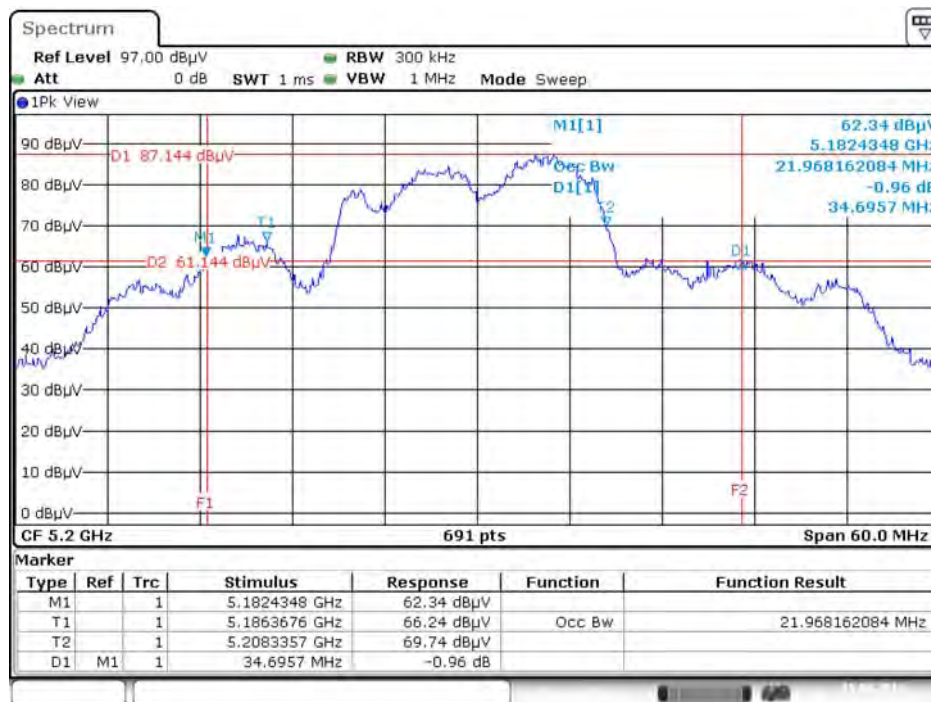

Date: 15.AUG.2016 17:30:03

26dB Bandwidth and 99% Occupied Bandwidth Plot on Configuration IEEE 802.11ac MCS0/Nss1 VHT20 / Chain 1 + Chain 2 + Chain 3+ Chain 4 / 5240 MHz

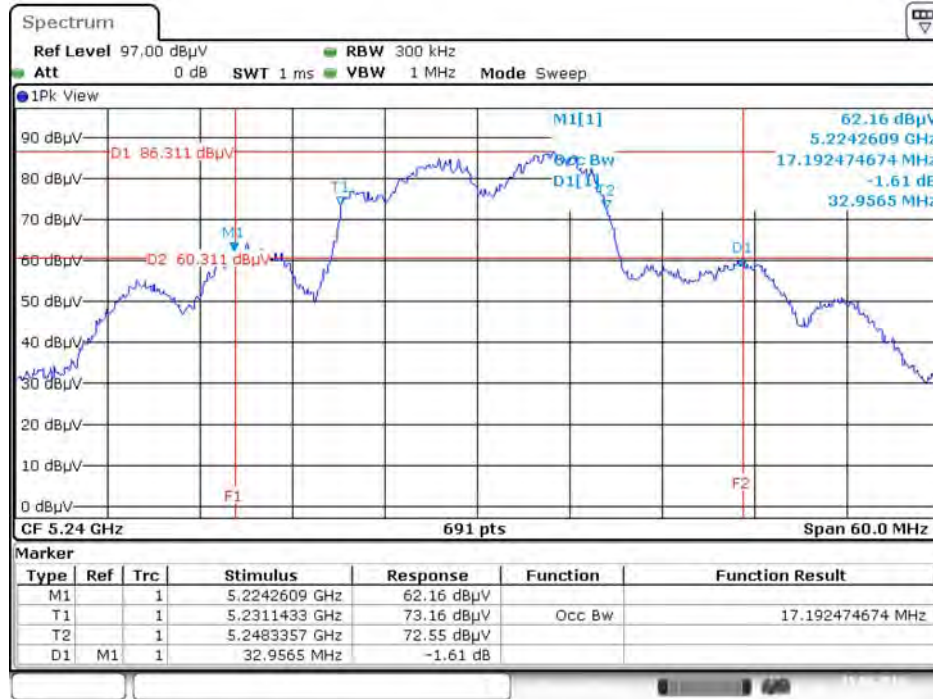

Date: 15.AUG.2016 17:29:14

26dB Bandwidth and 99% Occupied Bandwidth Plot on Configuration IEEE 802.11ac MCS0/Nss1 VHT20 / Chain 1 + Chain 2 + Chain 3+ Chain 4 / 5745 MHz

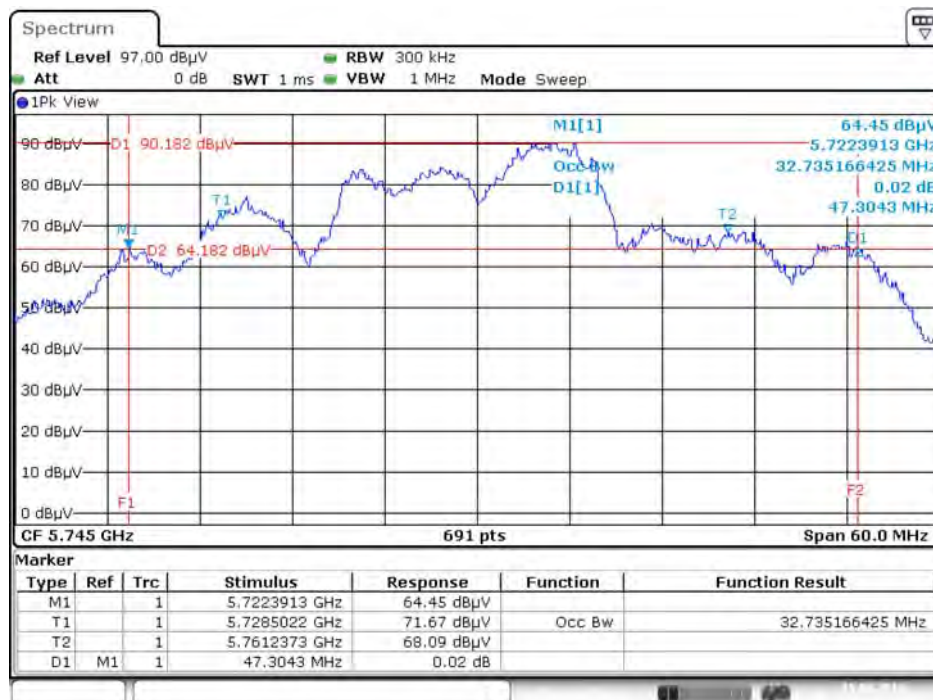

Date: 15.AUG.2016 19:18:14

26dB Bandwidth and 99% Occupied Bandwidth Plot on Configuration IEEE 802.11ac MCS0/Nss1 VHT20 / Chain 1 + Chain 2 + Chain 3+ Chain 4 / 5785 MHz

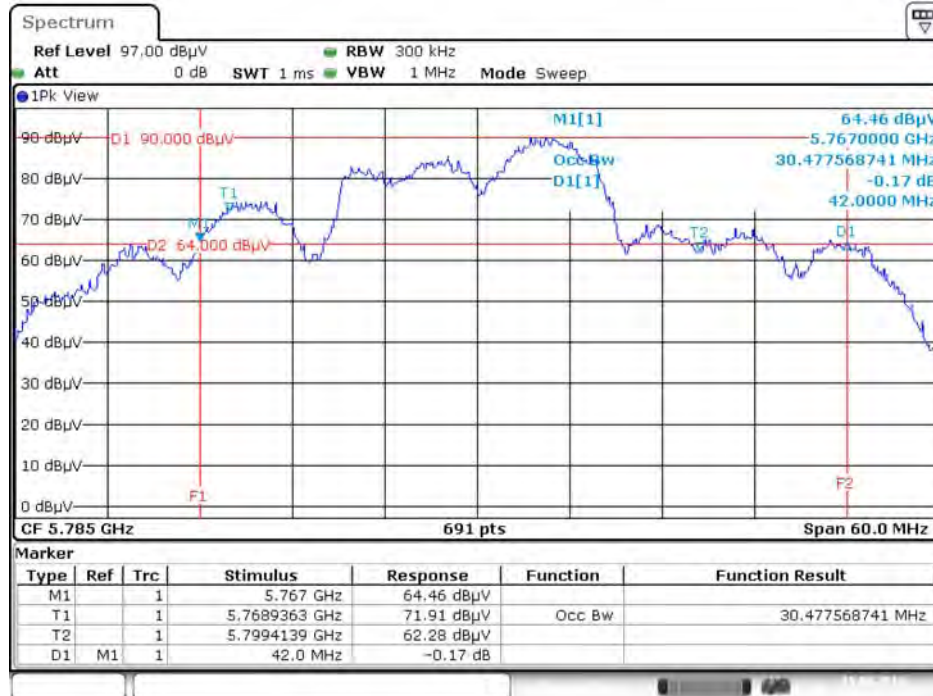

Date: 15.AUG.2016 19:17:44

26dB Bandwidth and 99% Occupied Bandwidth Plot on Configuration IEEE 802.11ac MCS0/Nss1 VHT20 / Chain 1 + Chain 2 + Chain 3+ Chain 4 / 5825 MHz

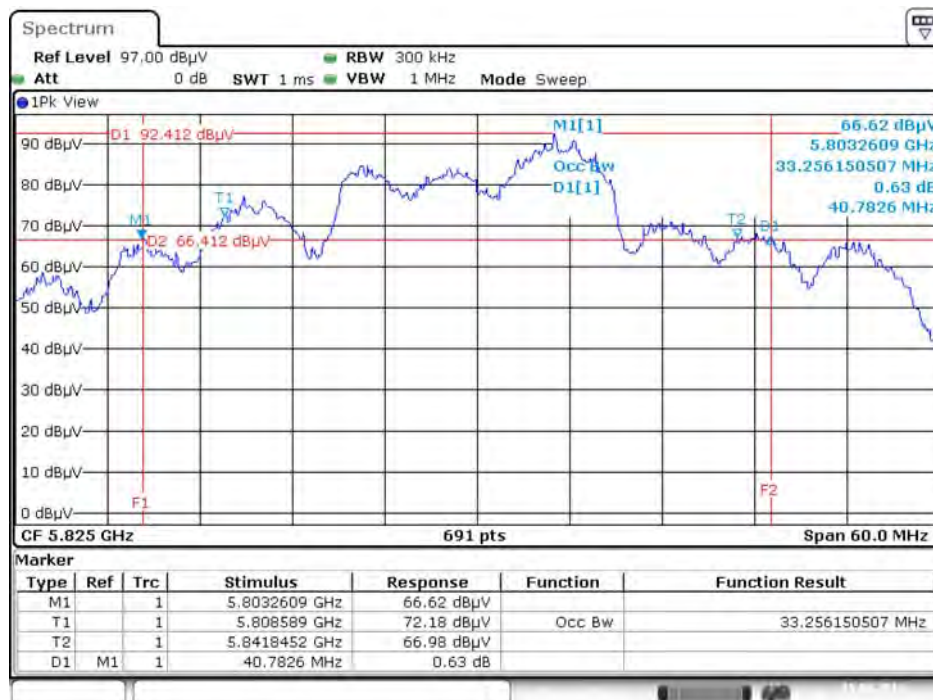

Date: 15.AUG.2016 19:17:11

26dB Bandwidth and 99% Occupied Bandwidth Plot on Configuration IEEE 802.11ac MCS0/Nss1 VHT40 / Chain 1 + Chain 2 + Chain 3+ Chain 4 / 5190 MHz

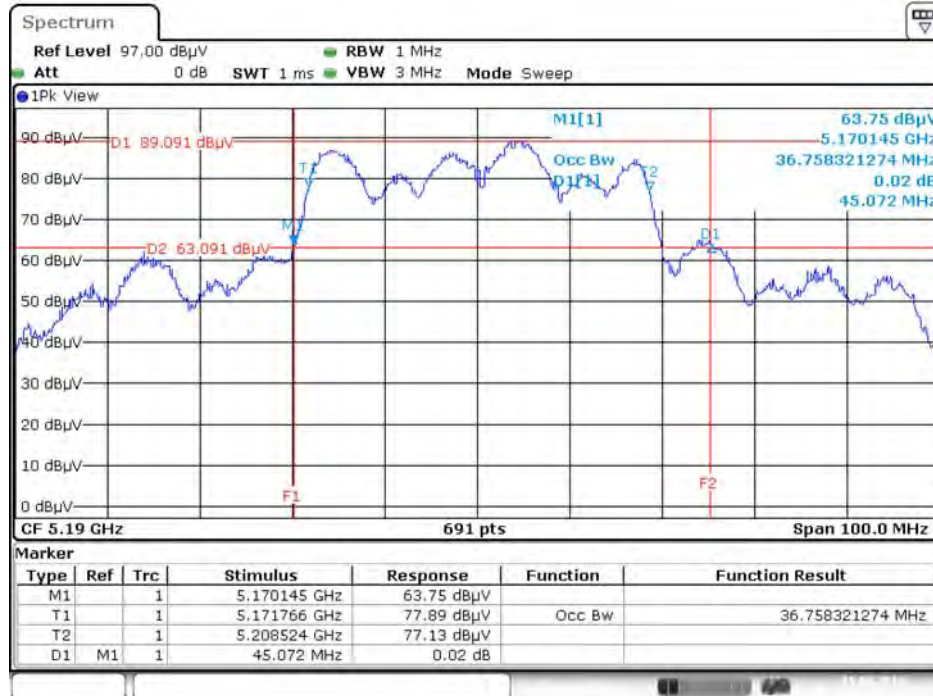

Date: 15.AUG.2016 17:31:31

26dB Bandwidth and 99% Occupied Bandwidth Plot on Configuration IEEE 802.11ac MCS0/Nss1 VHT40 / Chain 1 + Chain 2 + Chain 3+ Chain 4 / 5230 MHz

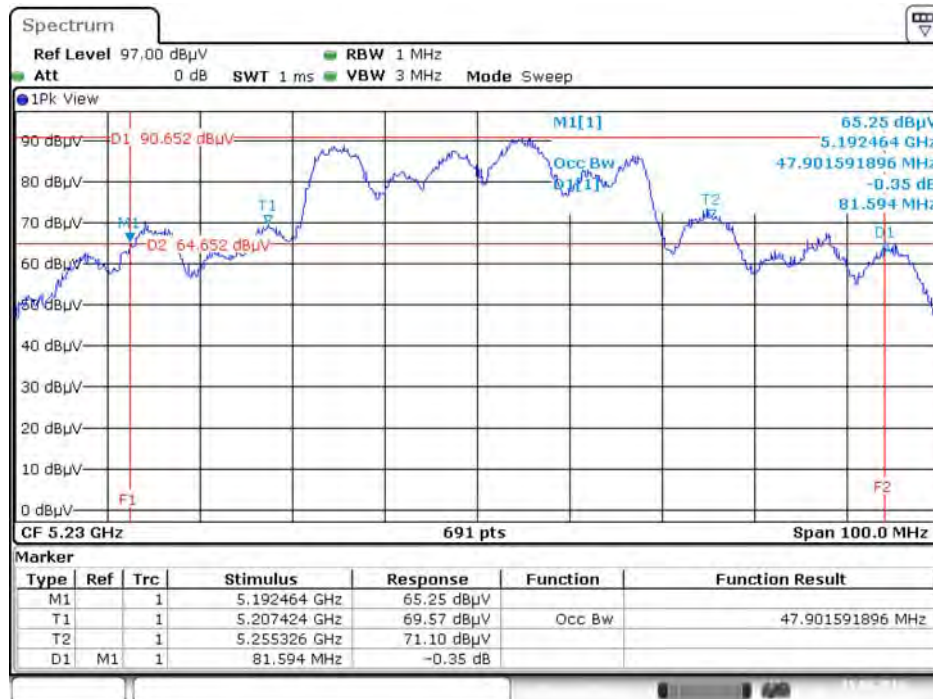

Date: 15.AUG.2016 17:32:03

26dB Bandwidth and 99% Occupied Bandwidth Plot on Configuration IEEE 802.11ac MCS0/Nss1 VHT40 / Chain 1 + Chain 2 + Chain 3+ Chain 4 / 5755 MHz



Date: 15.AUG.2016 19:19:18

26dB Bandwidth and 99% Occupied Bandwidth Plot on Configuration IEEE 802.11ac MCS0/Nss1 VHT40 / Chain 1 + Chain 2 + Chain 3+ Chain 4 / 5795 MHz

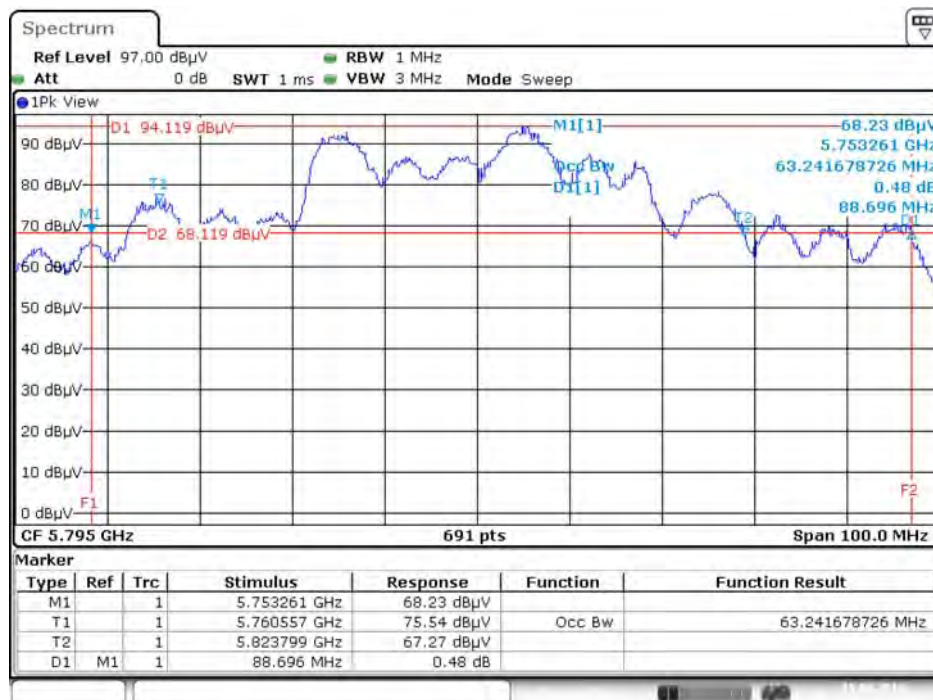

Date: 15.AUG.2016 19:20:03

26dB Bandwidth and 99% Occupied Bandwidth Plot on Configuration IEEE 802.11ac MCS0/Nss1 VHT80 / Chain 1 + Chain 2 + Chain 3+ Chain 4 / 5210 MHz

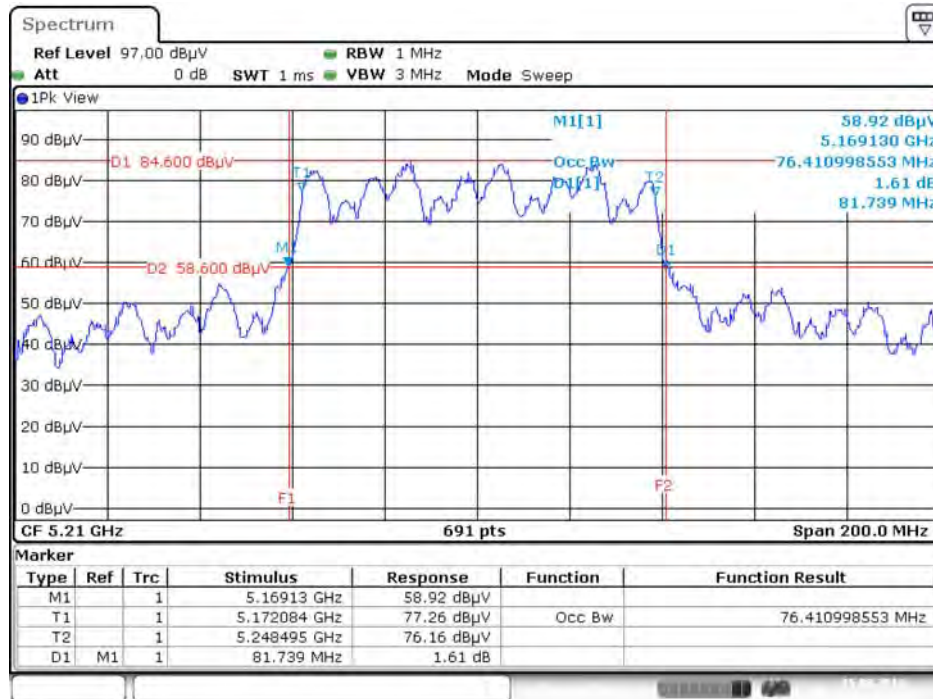

Date: 15.AUG.2016 17:33:14

26dB Bandwidth and 99% Occupied Bandwidth Plot on Configuration IEEE 802.11ac MCS0/Nss1 VHT80 / Chain 1 + Chain 2 + Chain 3+ Chain 4 / 5775 MHz

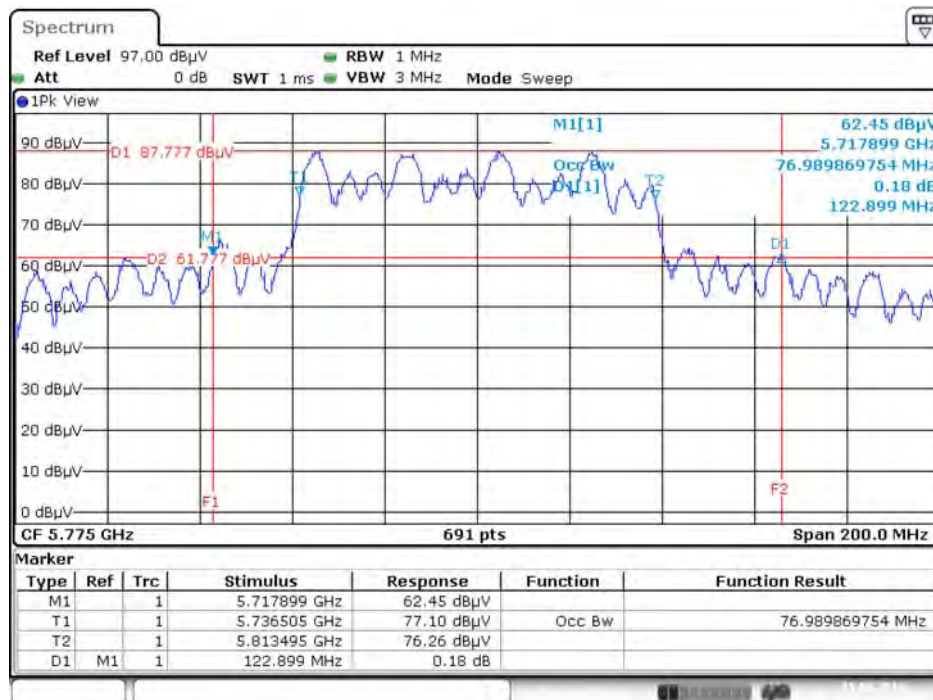

Date: 15.AUG.2016 19:22:40

<For Beamforming Mode> Band 1 / Band 4 Indoor, Outdoor use

Temperature	25°C	Humidity	60%
Test Engineer	Akina Chiu		

Mode	Frequency	26dB Bandwidth (MHz)	99% Occupied Bandwidth (MHz)
802.11ac MCS0/Nss1 VHT20	5180 MHz	31.04	18.67
	5200 MHz	29.22	18.76
	5240 MHz	24.52	18.67
	5745 MHz	23.39	18.23
	5785 MHz	22.87	18.23
	5825 MHz	24.17	18.23
802.11ac MCS0/Nss1 VHT40	5190 MHz	76.09	46.02
	5230 MHz	75.80	47.03
	5755 MHz	62.90	37.63
	5795 MHz	63.77	38.06
802.11ac MCS0/Nss1 VHT80	5210 MHz	181.16	79.31
	5775 MHz	138.26	77.28

26dB Bandwidth and 99% Occupied Bandwidth Plot on Configuration IEEE 802.11ac MCS0/Nss1
VHT20 / Chain 1 + Chain 2 + Chain 3+ Chain 4 / 5180 MHz

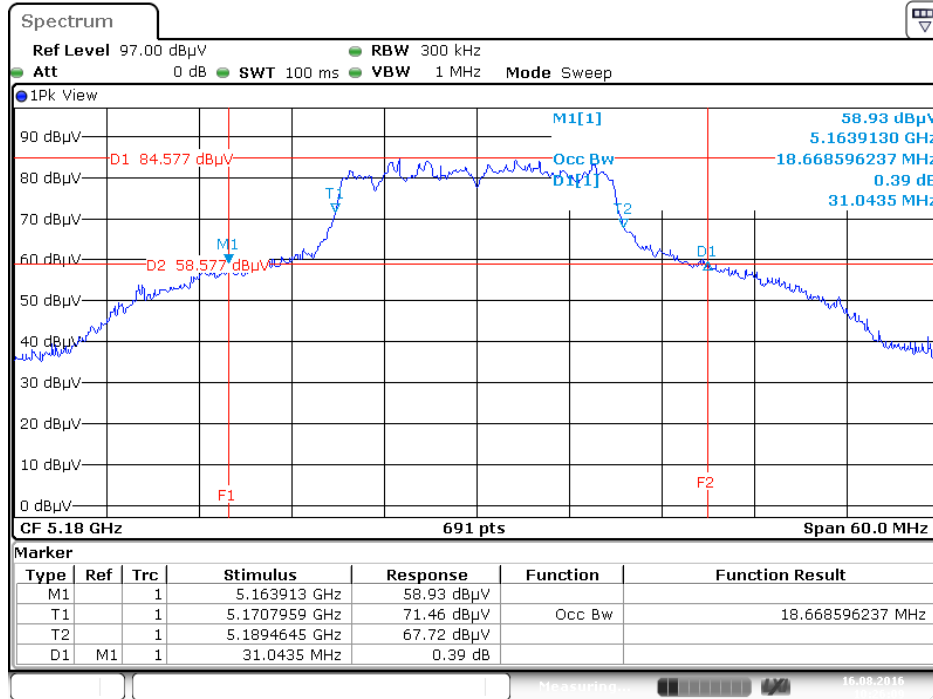

Date: 16.AUG.2016 10:26:09

26dB Bandwidth and 99% Occupied Bandwidth Plot on Configuration IEEE 802.11ac MCS0/Nss1
VHT20 / Chain 1 + Chain 2 + Chain 3+ Chain 4 / 5200 MHz

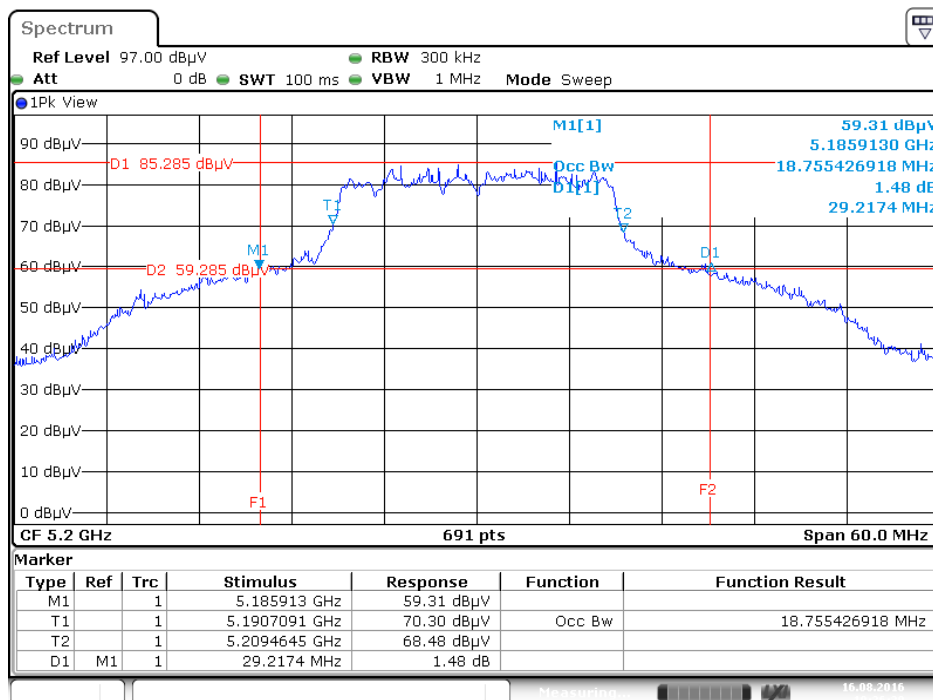

Date: 16.AUG.2016 10:26:31

26dB Bandwidth and 99% Occupied Bandwidth Plot on Configuration IEEE 802.11ac MCS0/Nss1 VHT20 / Chain 1 + Chain 2 + Chain 3+ Chain 4 / 5240 MHz

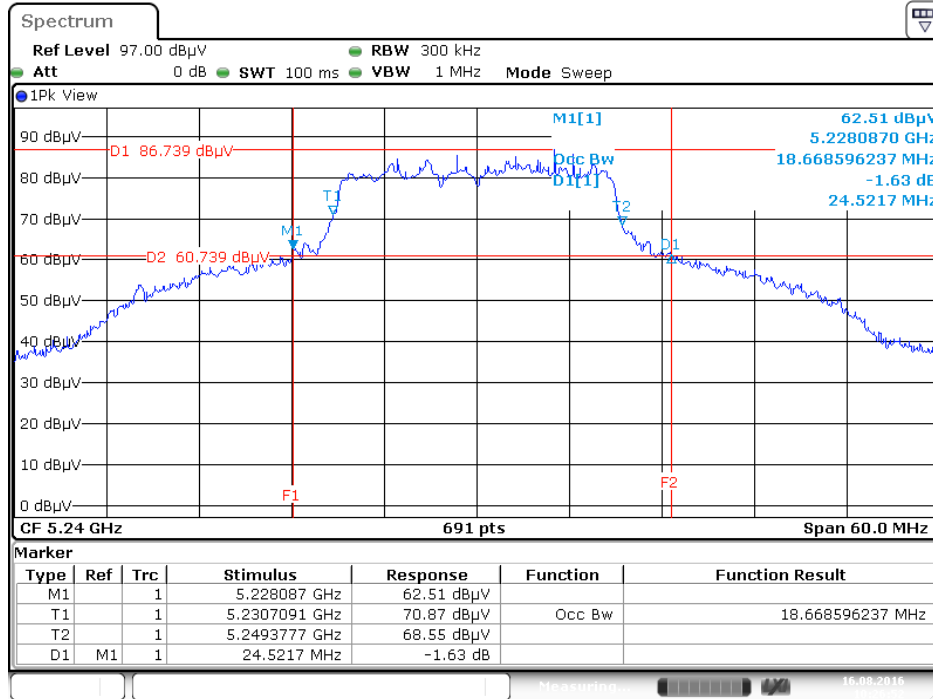

Date: 16.AUG.2016 10:26:52

26dB Bandwidth and 99% Occupied Bandwidth Plot on Configuration IEEE 802.11ac MCS0/Nss1 VHT20 / Chain 1 + Chain 2 + Chain 3+ Chain 4 / 5745 MHz

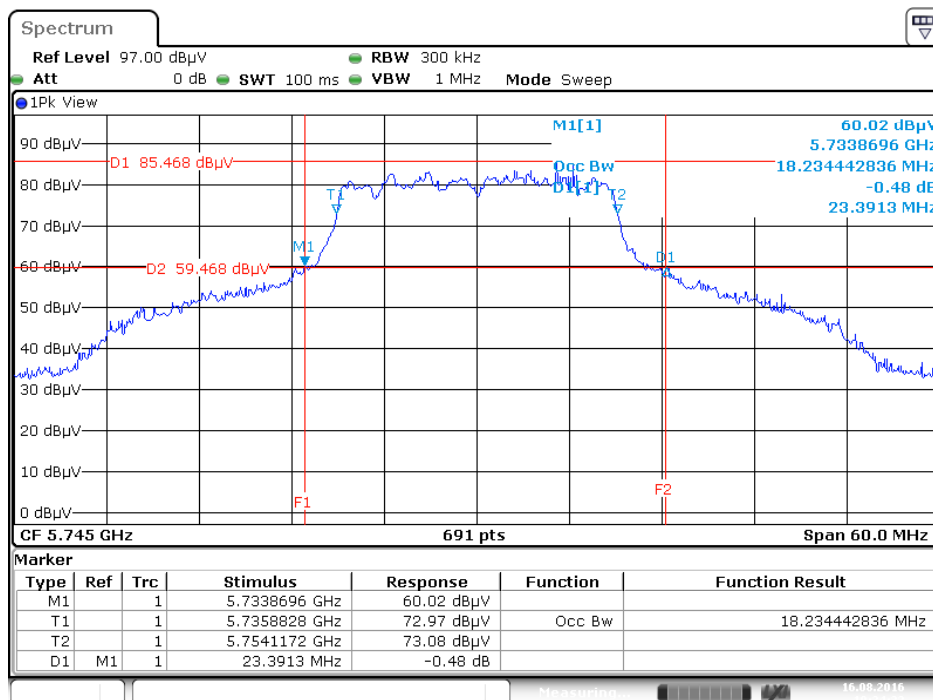

Date: 16.AUG.2016 10:24:33

26dB Bandwidth and 99% Occupied Bandwidth Plot on Configuration IEEE 802.11ac MCS0/Nss1 VHT20 / Chain 1 + Chain 2 + Chain 3+ Chain 4 / 5785 MHz

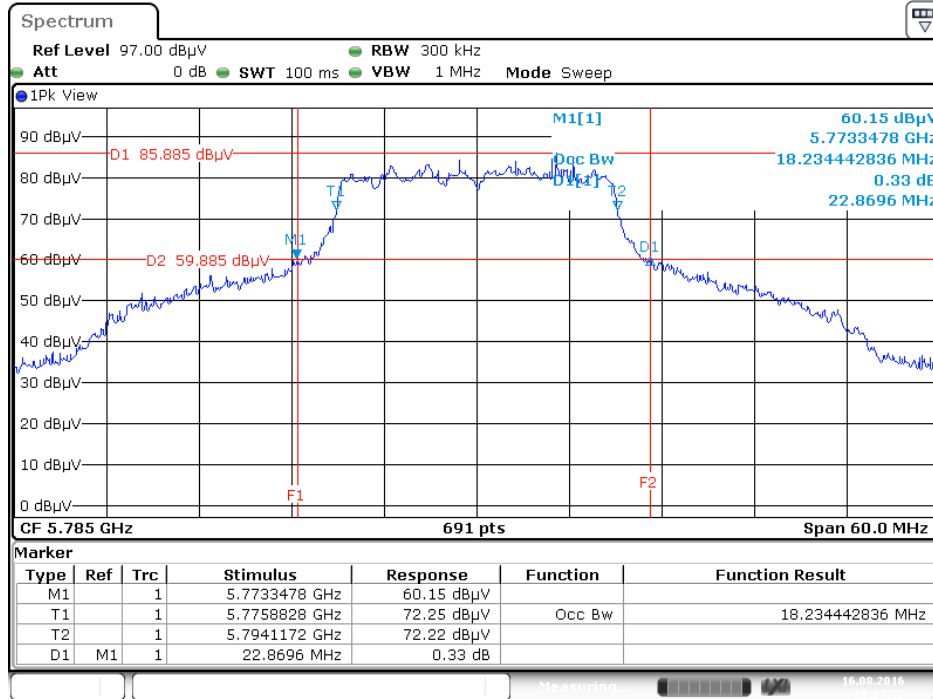

Date: 16.AUG.2016 10:23:58

26dB Bandwidth and 99% Occupied Bandwidth Plot on Configuration IEEE 802.11ac MCS0/Nss1 VHT20 / Chain 1 + Chain 2 + Chain 3+ Chain 4 / 5825 MHz

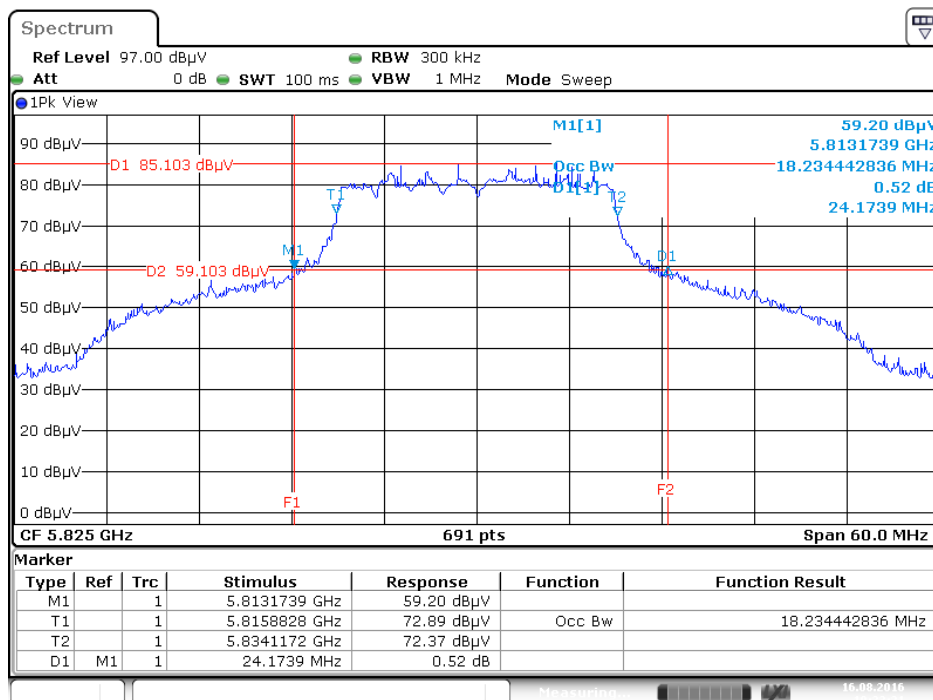

Date: 16.AUG.2016 10:23:21

26dB Bandwidth and 99% Occupied Bandwidth Plot on Configuration IEEE 802.11ac MCS0/Nss1 VHT40 / Chain 1 + Chain 2 + Chain 3+ Chain 4 / 5190 MHz

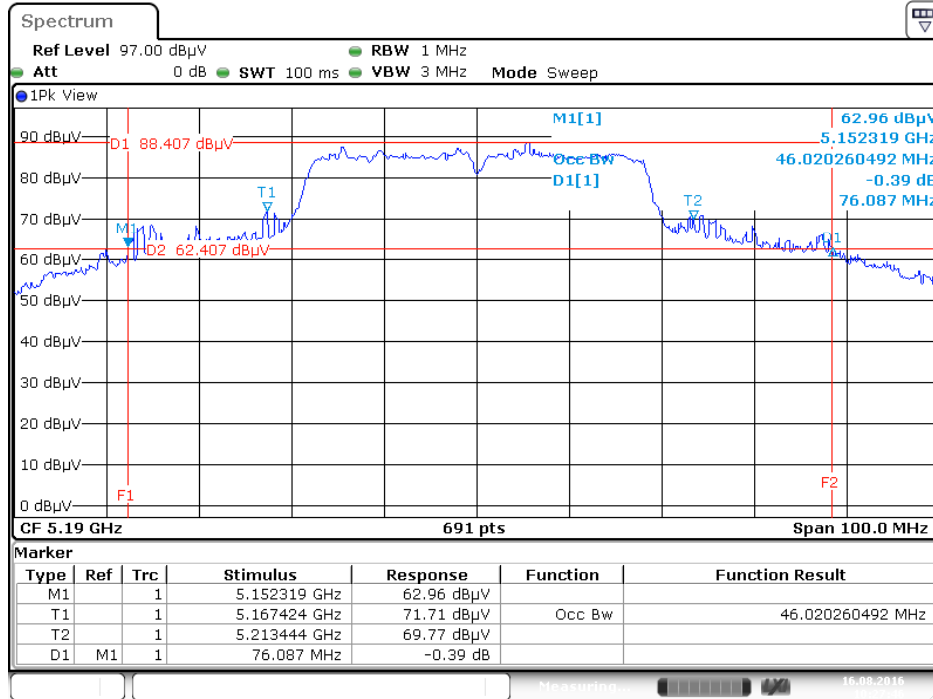

Date: 16.AUG.2016 10:27:47

26dB Bandwidth and 99% Occupied Bandwidth Plot on Configuration IEEE 802.11ac MCS0/Nss1 VHT40 / Chain 1 + Chain 2 + Chain 3+ Chain 4 / 5230 MHz

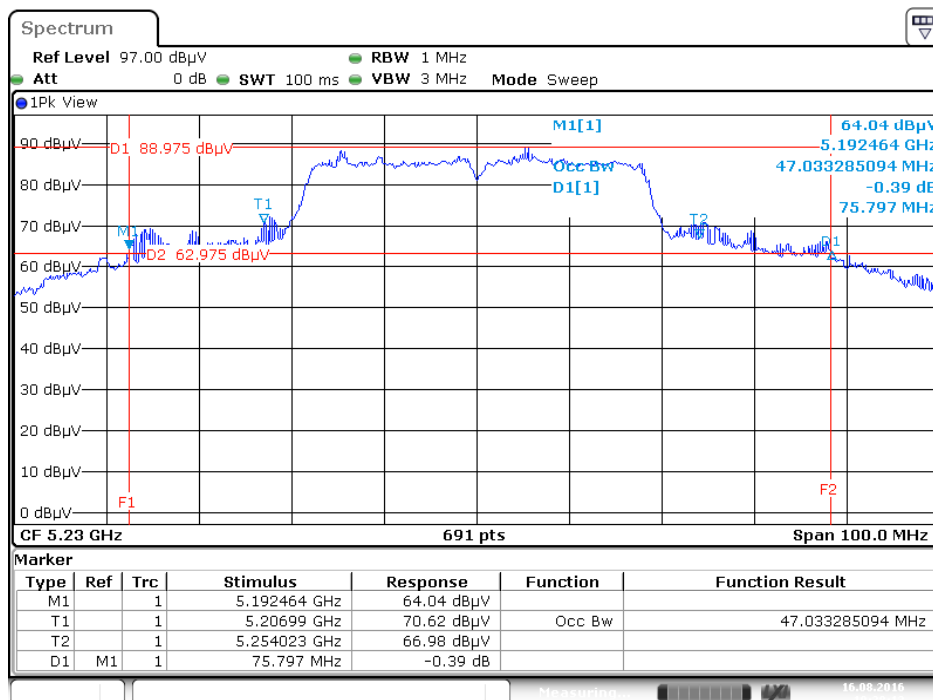

Date: 16.AUG.2016 10:28:14

26dB Bandwidth and 99% Occupied Bandwidth Plot on Configuration IEEE 802.11ac MCS0/Nss1 VHT40 / Chain 1 + Chain 2 + Chain 3+ Chain 4 / 5755 MHz

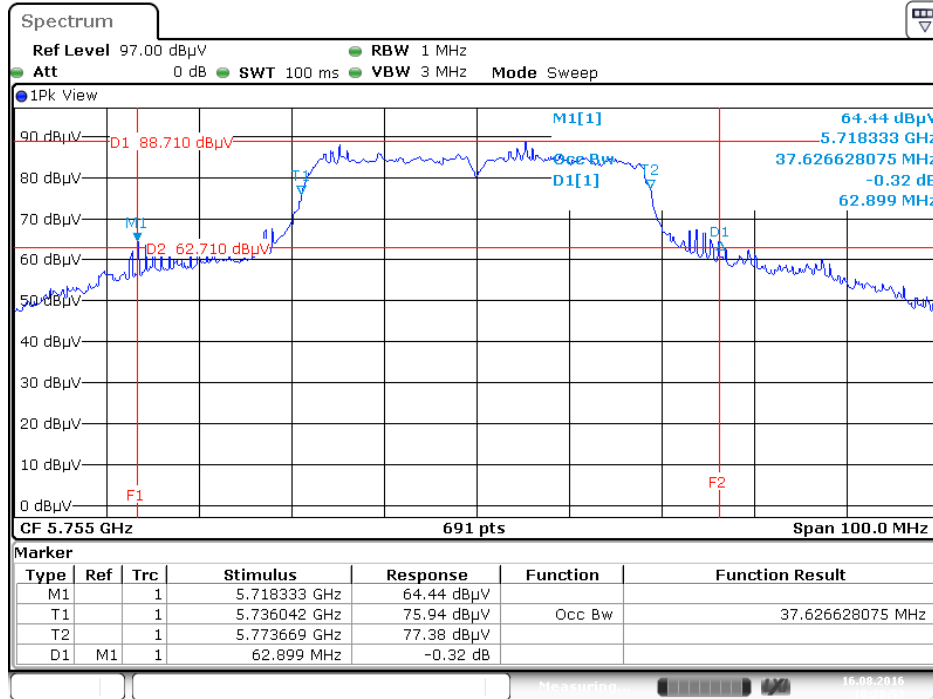

Date: 16.AUG.2016 10:28:54

26dB Bandwidth and 99% Occupied Bandwidth Plot on Configuration IEEE 802.11ac MCS0/Nss1 VHT40 / Chain 1 + Chain 2 + Chain 3+ Chain 4 / 5795 MHz

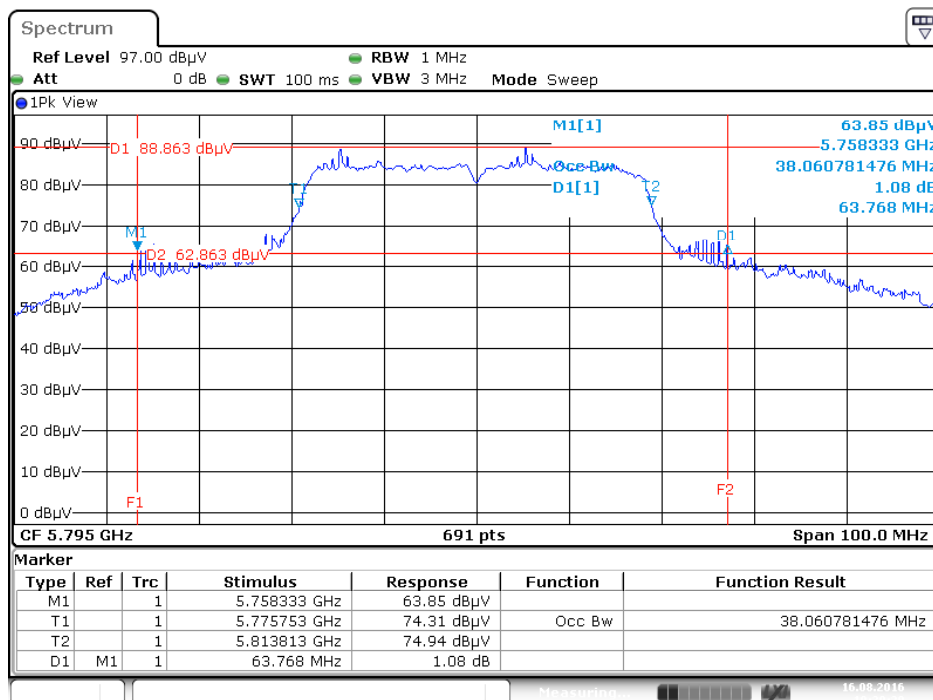

Date: 16.AUG.2016 10:29:29

26dB Bandwidth and 99% Occupied Bandwidth Plot on Configuration IEEE 802.11ac MCS0/Nss1
VHT80 / Chain 1 + Chain 2 + Chain 3+ Chain 4 / 5210 MHz

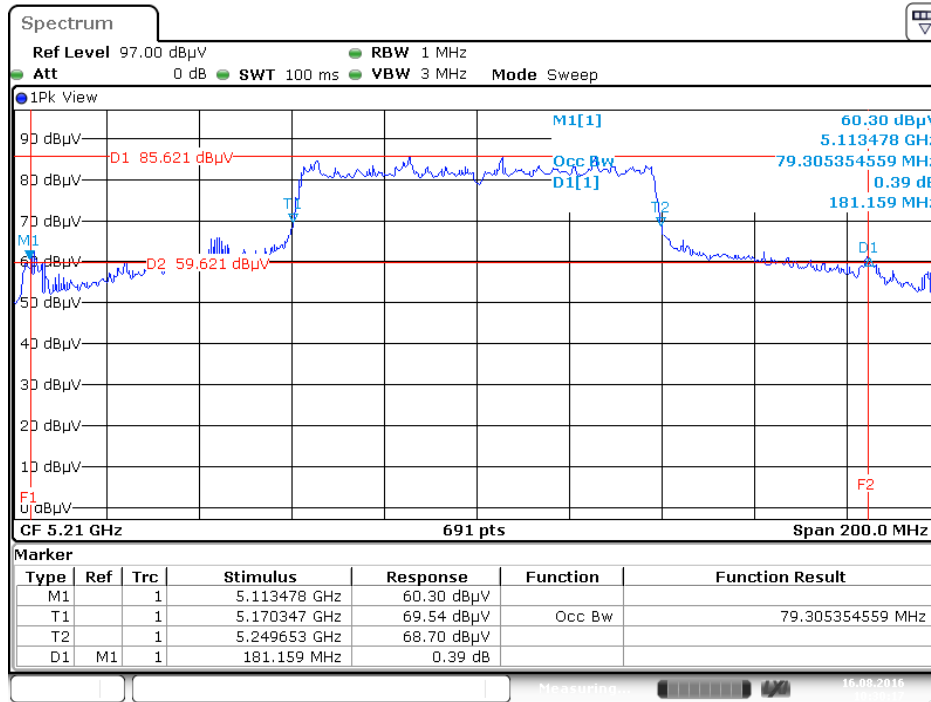

Date: 16.AUG.2016 10:30:18

26dB Bandwidth and 99% Occupied Bandwidth Plot on Configuration IEEE 802.11ac MCS0/Nss1
VHT80 / Chain 1 + Chain 2 + Chain 3+ Chain 4 / 5775 MHz

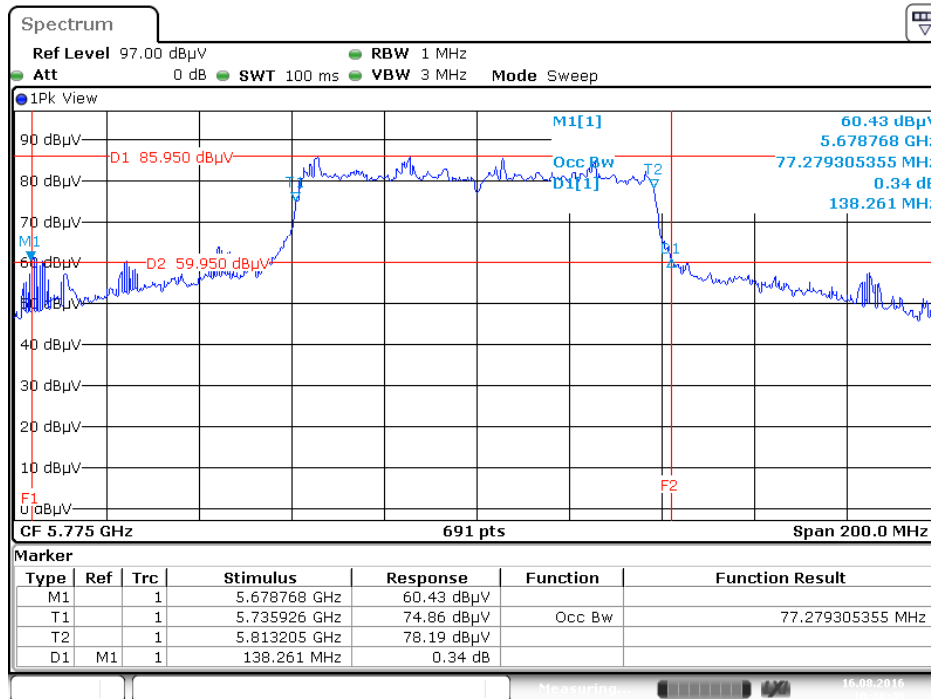

Date: 16.AUG.2016 10:30:49

For Directional antenna:

<For Non-Beamforming Mode> Band 1 / Band 4 Indoor, Outdoor use

Temperature	25°C	Humidity	60%
Test Engineer	Akina Chiu		

Mode	Frequency	26dB Bandwidth (MHz)	99% Occupied Bandwidth (MHz)
802.11a	5180 MHz	17.48	15.63
	5200 MHz	17.39	15.89
	5240 MHz	17.91	16.15
	5745 MHz	18.00	16.32
	5785 MHz	18.00	16.32
	5825 MHz	18.17	16.41
802.11ac MCS0/Nss1 VHT20	5180 MHz	18.17	16.32
	5200 MHz	18.44	16.67
	5240 MHz	18.52	16.93
	5745 MHz	18.61	17.02
	5785 MHz	18.78	17.11
	5825 MHz	18.96	17.37
802.11ac MCS0/Nss1 VHT40	5190 MHz	39.42	36.18
	5230 MHz	39.28	36.32
	5755 MHz	39.13	35.89
	5795 MHz	38.99	35.60
802.11ac MCS0/Nss1 VHT80	5210 MHz	82.03	76.12
	5775 MHz	80.87	75.54

26dB Bandwidth and 99% Occupied Bandwidth Plot on Configuration IEEE 802.11a / Chain 1 + Chain 2 + Chain 3+ Chain 4 / 5180 MHz

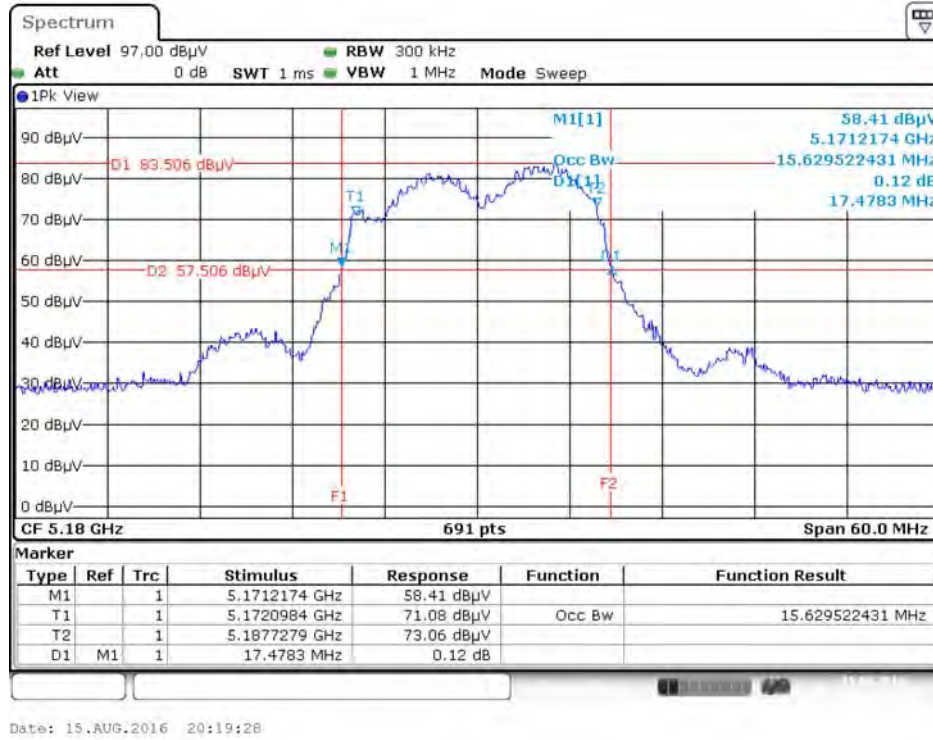

26dB Bandwidth and 99% Occupied Bandwidth Plot on Configuration IEEE 802.11a / Chain 1 + Chain 2 + Chain 3+ Chain 4 / 5200 MHz

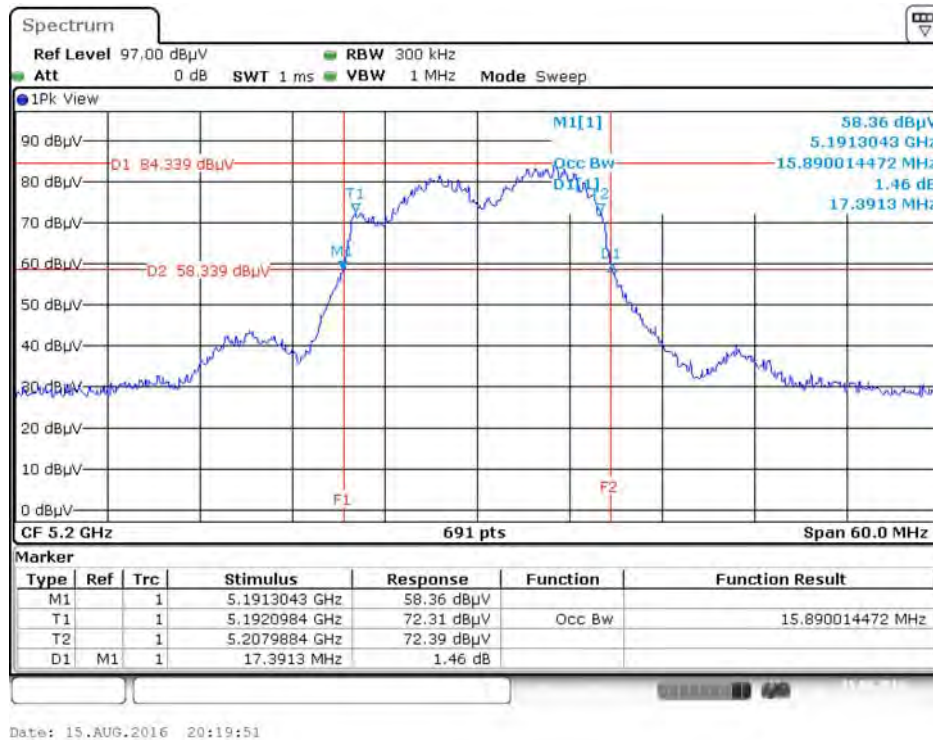

26dB Bandwidth and 99% Occupied Bandwidth Plot on Configuration IEEE 802.11a / Chain 1 + Chain 2 + Chain 3+ Chain 4 / 5240 MHz

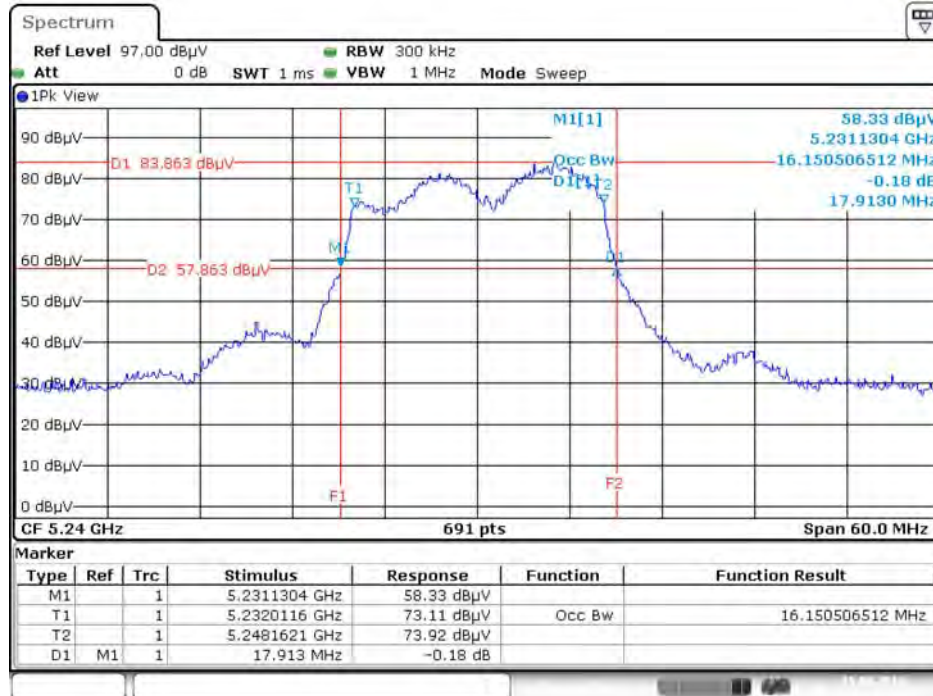

Date: 15.AUG.2016 20:20:12

26dB Bandwidth and 99% Occupied Bandwidth Plot on Configuration IEEE 802.11a / Chain 1 + Chain 2 + Chain 3+ Chain 4 / 5745 MHz

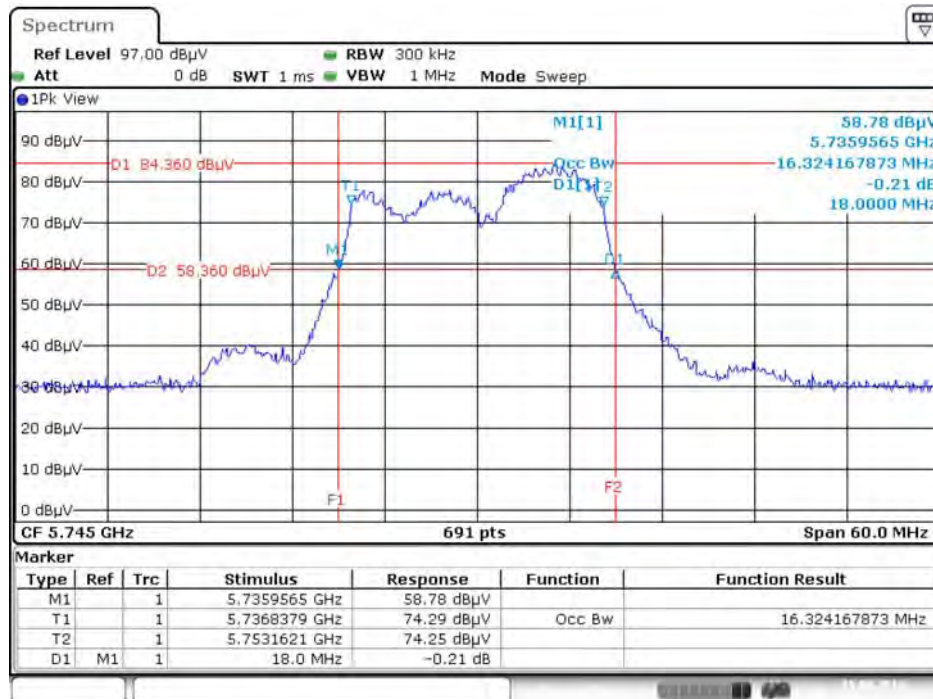

Date: 15.AUG.2016 20:19:00

26dB Bandwidth and 99% Occupied Bandwidth Plot on Configuration IEEE 802.11a / Chain 1 + Chain 2 + Chain 3+ Chain 4 / 5785 MHz

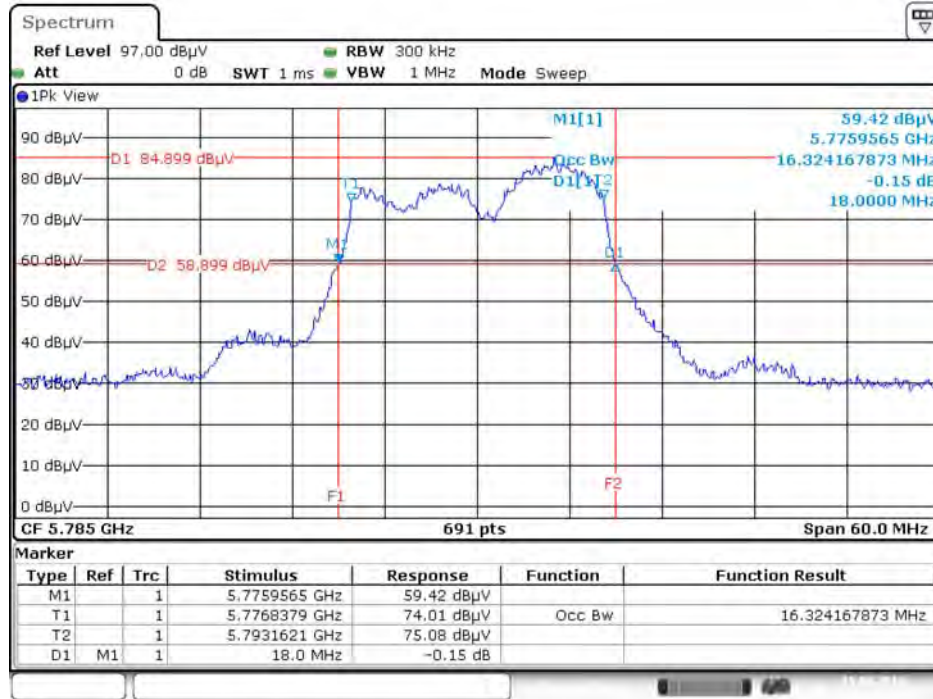

Date: 15.AUG.2016 20:18:32

26dB Bandwidth and 99% Occupied Bandwidth Plot on Configuration IEEE 802.11a / Chain 1 + Chain 2 + Chain 3+ Chain 4 / 5825 MHz

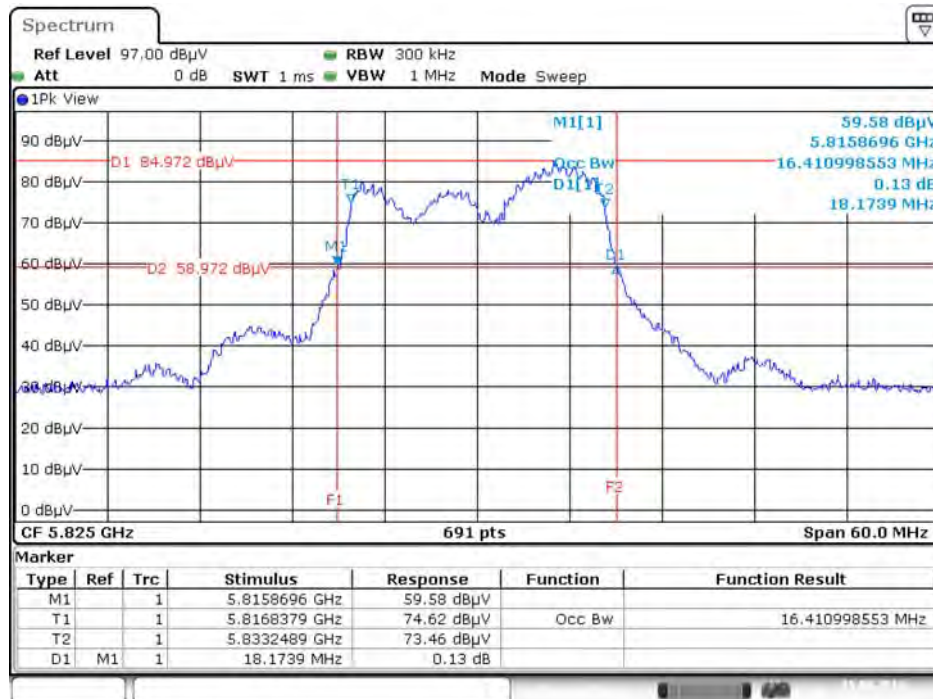

Date: 15.AUG.2016 20:18:03

26dB Bandwidth and 99% Occupied Bandwidth Plot on Configuration IEEE 802.11ac MCS0/Nss1 VHT20 / Chain 1 + Chain 2 + Chain 3+ Chain 4 / 5180 MHz

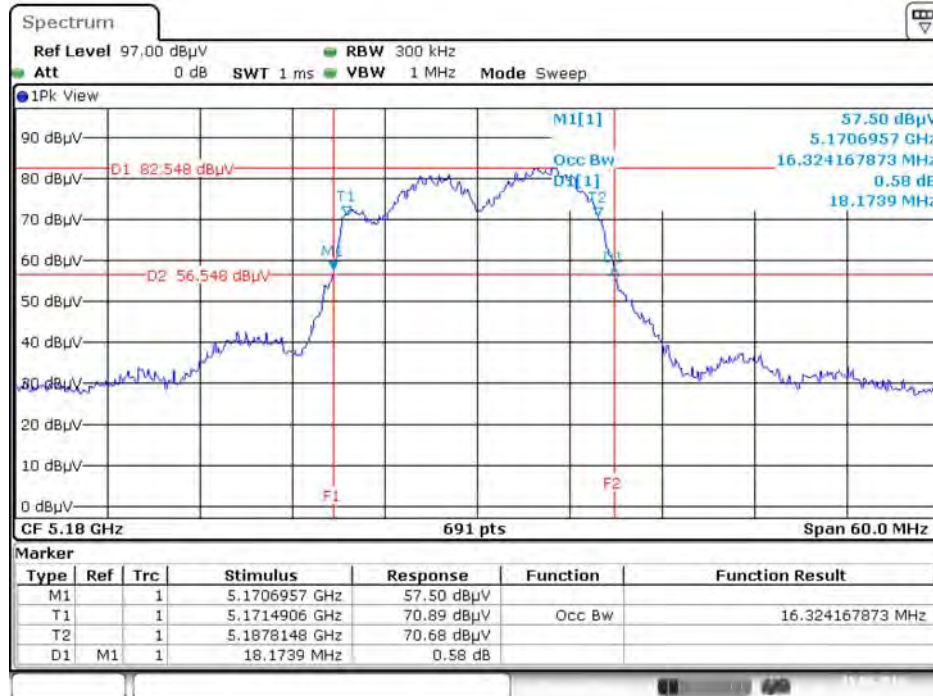

Date: 15.AUG.2016 20:15:06

26dB Bandwidth and 99% Occupied Bandwidth Plot on Configuration IEEE 802.11ac MCS0/Nss1 VHT20 / Chain 1 + Chain 2 + Chain 3+ Chain 4 / 5200 MHz

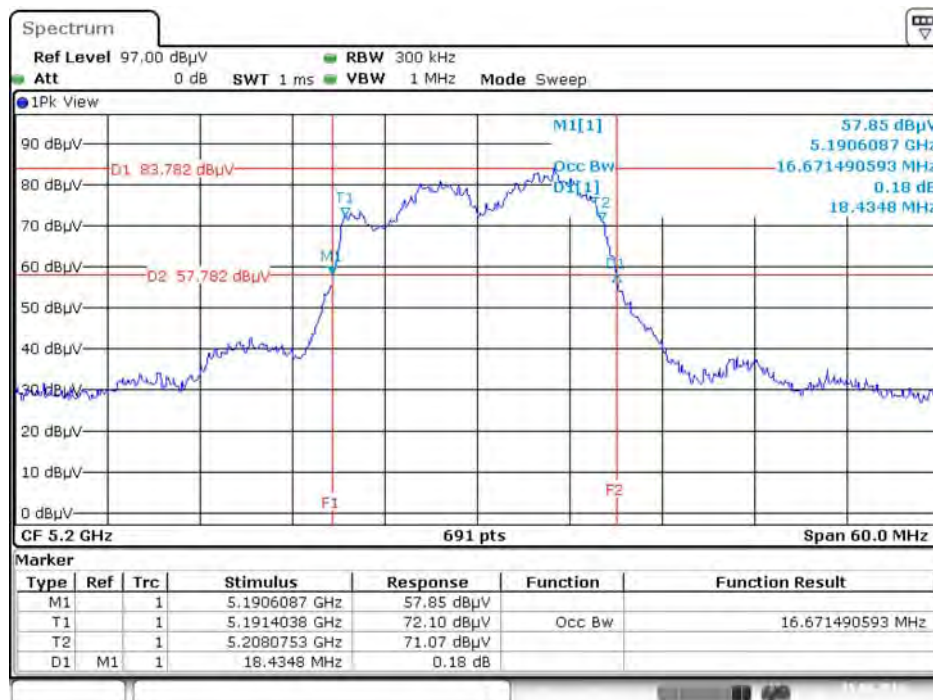

Date: 15.AUG.2016 20:15:32

26dB Bandwidth and 99% Occupied Bandwidth Plot on Configuration IEEE 802.11ac MCS0/Nss1 VHT20 / Chain 1 + Chain 2 + Chain 3+ Chain 4 / 5240 MHz

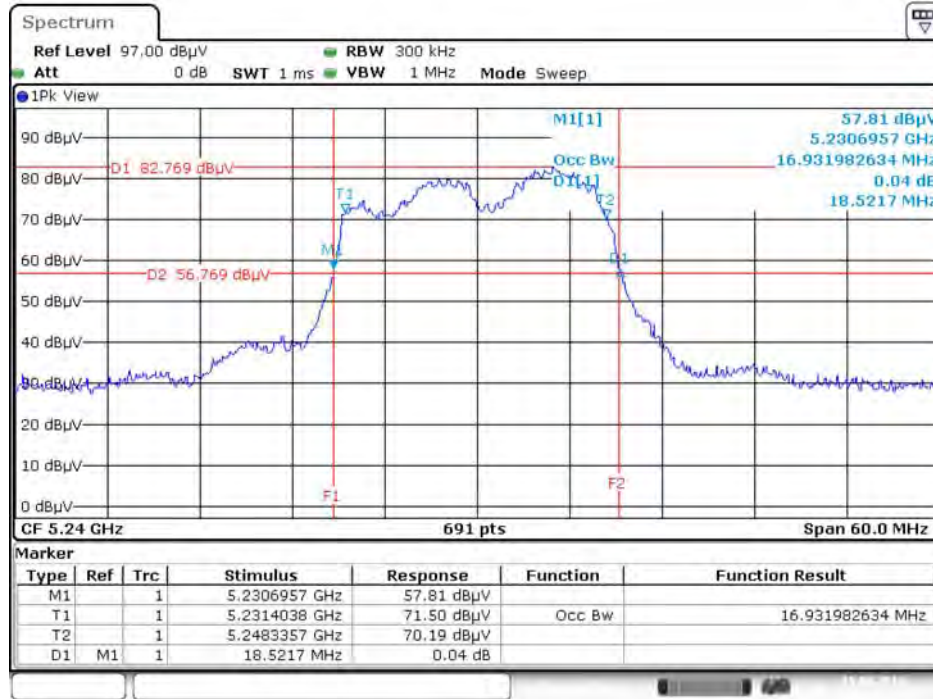

Date: 15.AUG.2016 20:16:00

26dB Bandwidth and 99% Occupied Bandwidth Plot on Configuration IEEE 802.11ac MCS0/Nss1 VHT20 / Chain 1 + Chain 2 + Chain 3+ Chain 4 / 5745 MHz

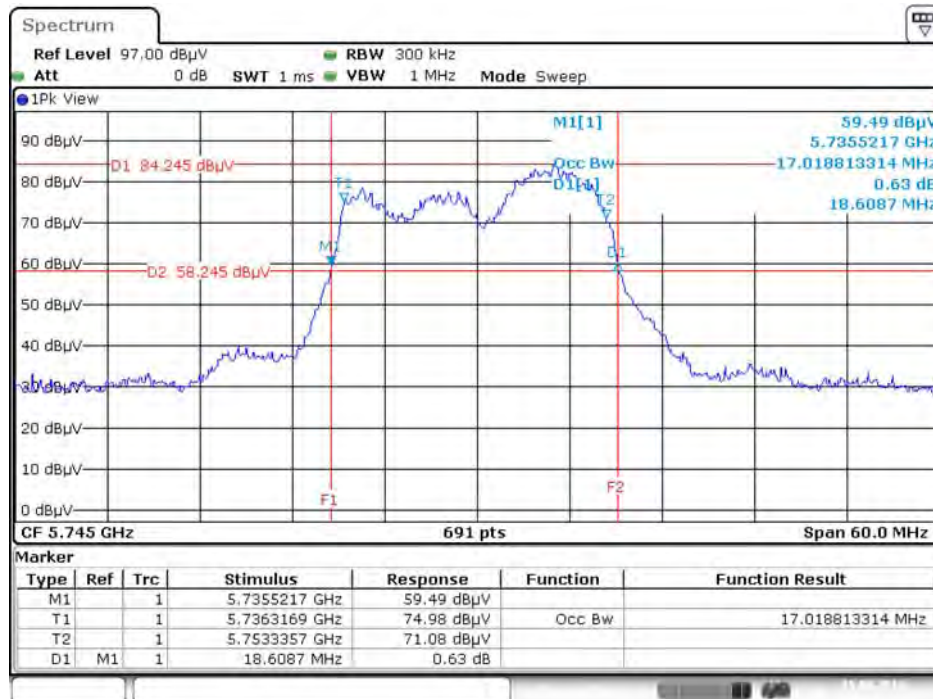

Date: 15.AUG.2016 20:16:41

26dB Bandwidth and 99% Occupied Bandwidth Plot on Configuration IEEE 802.11ac MCS0/Nss1 VHT20 / Chain 1 + Chain 2 + Chain 3+ Chain 4 / 5785 MHz

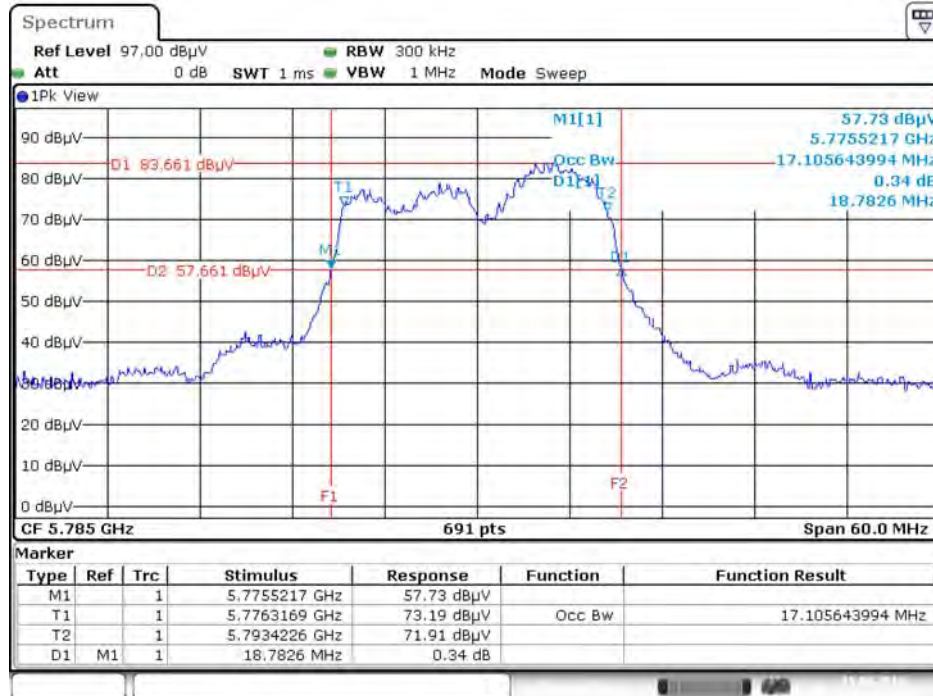

26dB Bandwidth and 99% Occupied Bandwidth Plot on Configuration IEEE 802.11ac MCS0/Nss1 VHT20 / Chain 1 + Chain 2 + Chain 3+ Chain 4 / 5825 MHz

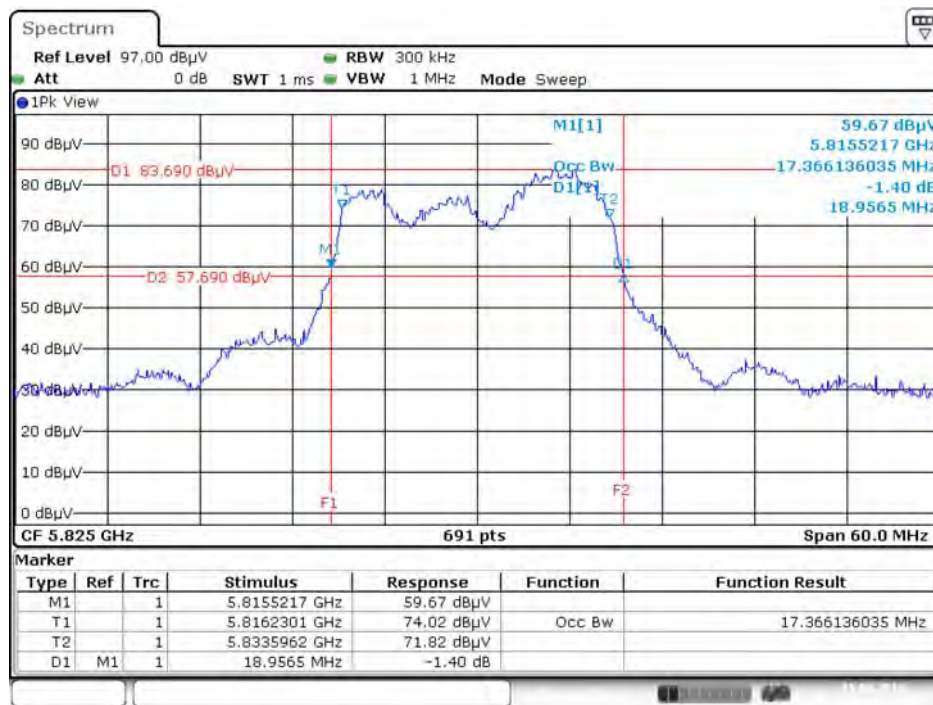

26dB Bandwidth and 99% Occupied Bandwidth Plot on Configuration IEEE 802.11ac MCS0/Nss1 VHT40 / Chain 1 + Chain 2 + Chain 3+ Chain 4 / 5190 MHz

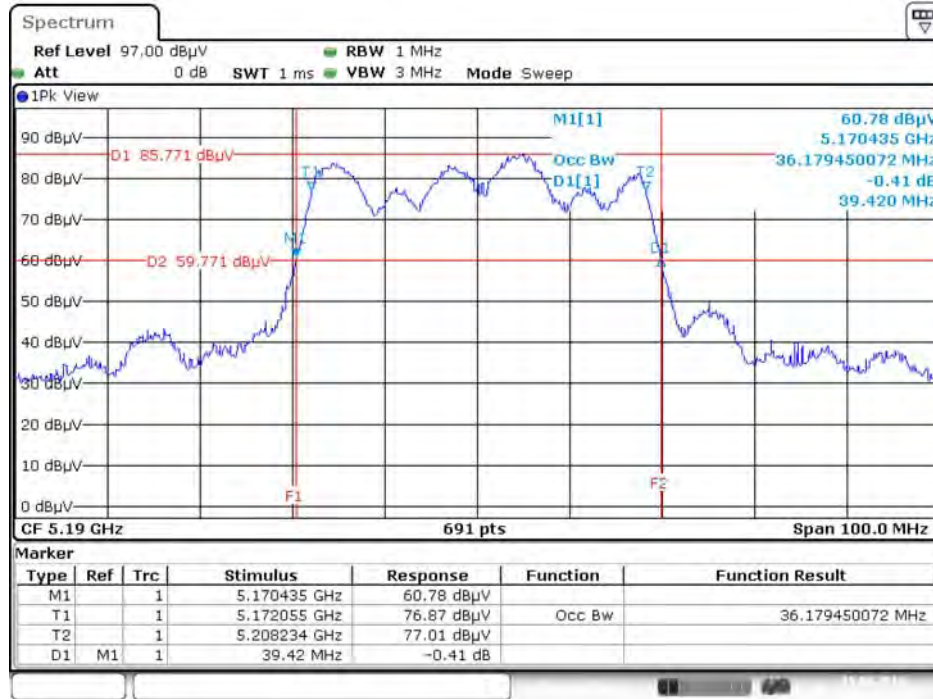

Date: 15.AUG.2016 20:12:49

26dB Bandwidth and 99% Occupied Bandwidth Plot on Configuration IEEE 802.11ac MCS0/Nss1 VHT40 / Chain 1 + Chain 2 + Chain 3+ Chain 4 / 5230 MHz

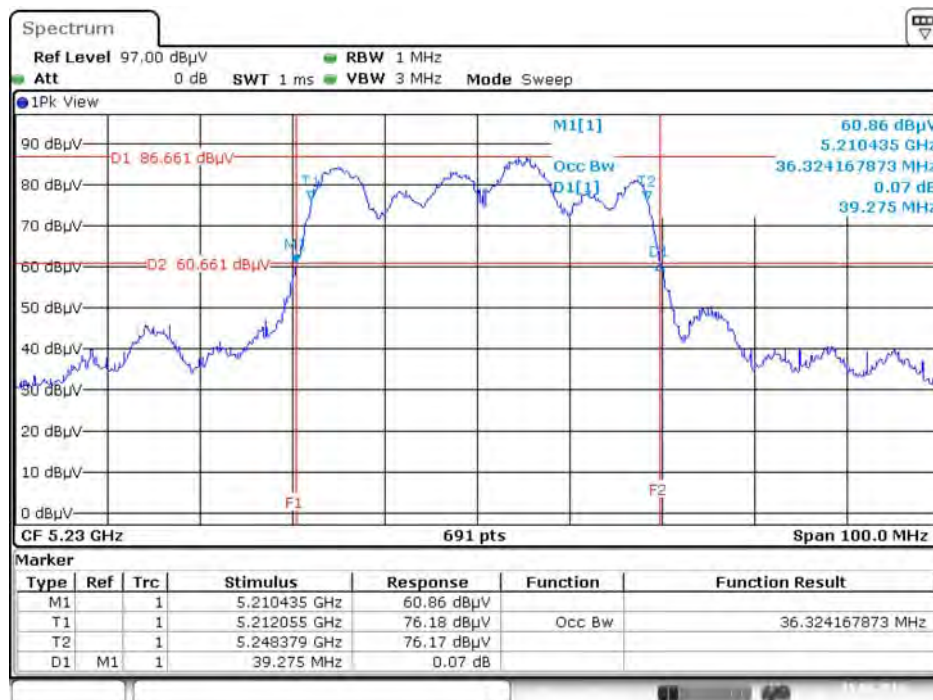

Date: 15.AUG.2016 20:13:22

26dB Bandwidth and 99% Occupied Bandwidth Plot on Configuration IEEE 802.11ac MCS0/Nss1 VHT40 / Chain 1 + Chain 2 + Chain 3+ Chain 4 / 5755 MHz

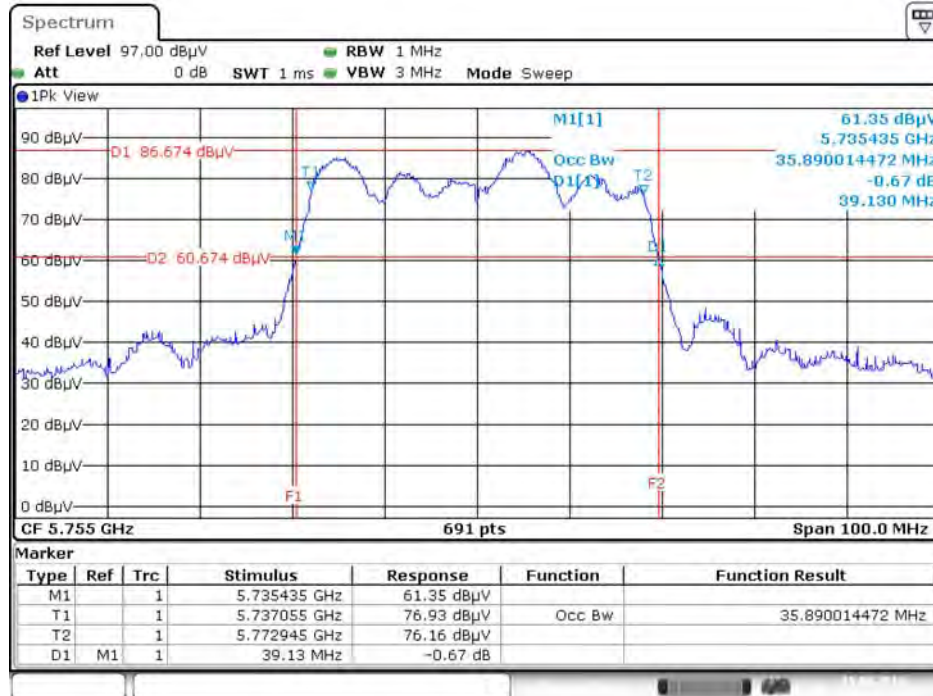

Date: 15.AUG.2016 20:13:54

26dB Bandwidth and 99% Occupied Bandwidth Plot on Configuration IEEE 802.11ac MCS0/Nss1 VHT40 / Chain 1 + Chain 2 + Chain 3+ Chain 4 / 5795 MHz

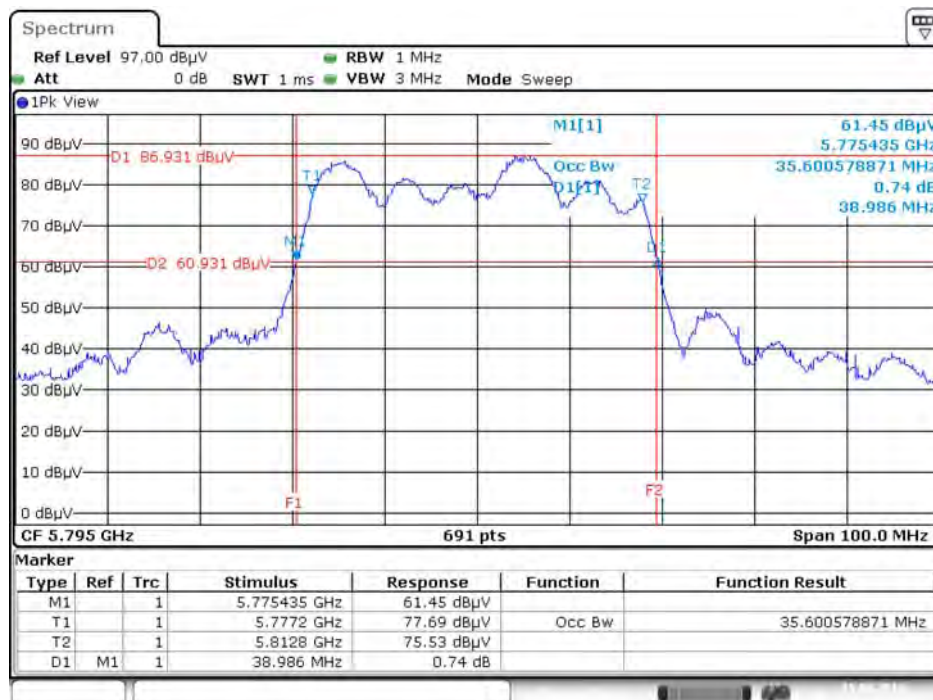

Date: 15.AUG.2016 20:14:22

26dB Bandwidth and 99% Occupied Bandwidth Plot on Configuration IEEE 802.11ac MCS0/Nss1 VHT80 / Chain 1 + Chain 2 + Chain 3+ Chain 4 / 5210 MHz

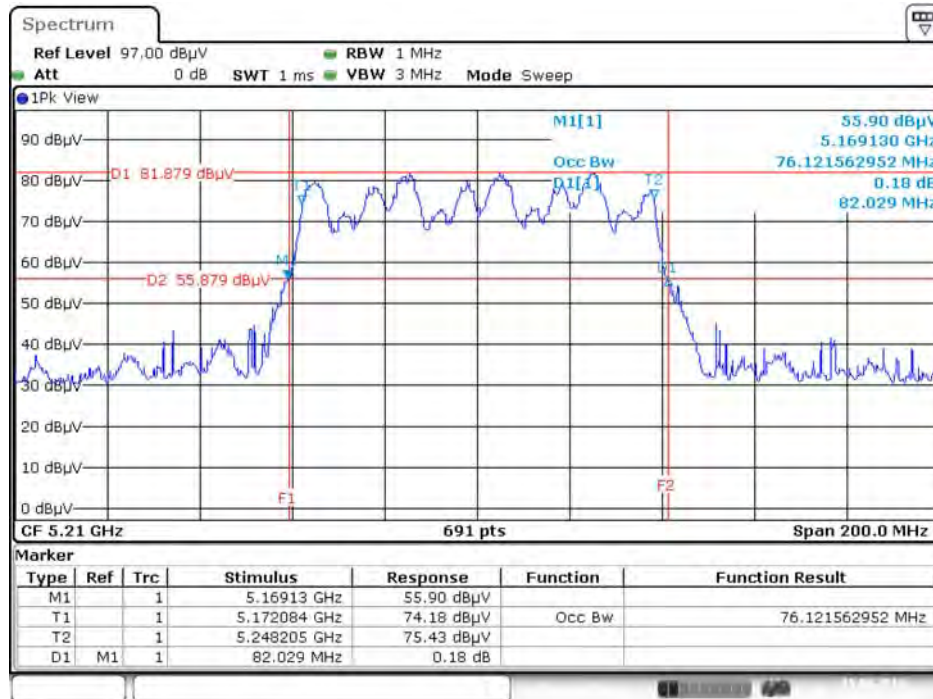

Date: 15.AUG.2016 19:53:17

26dB Bandwidth and 99% Occupied Bandwidth Plot on Configuration IEEE 802.11ac MCS0/Nss1 VHT80 / Chain 1 + Chain 2 + Chain 3+ Chain 4 / 5775 MHz

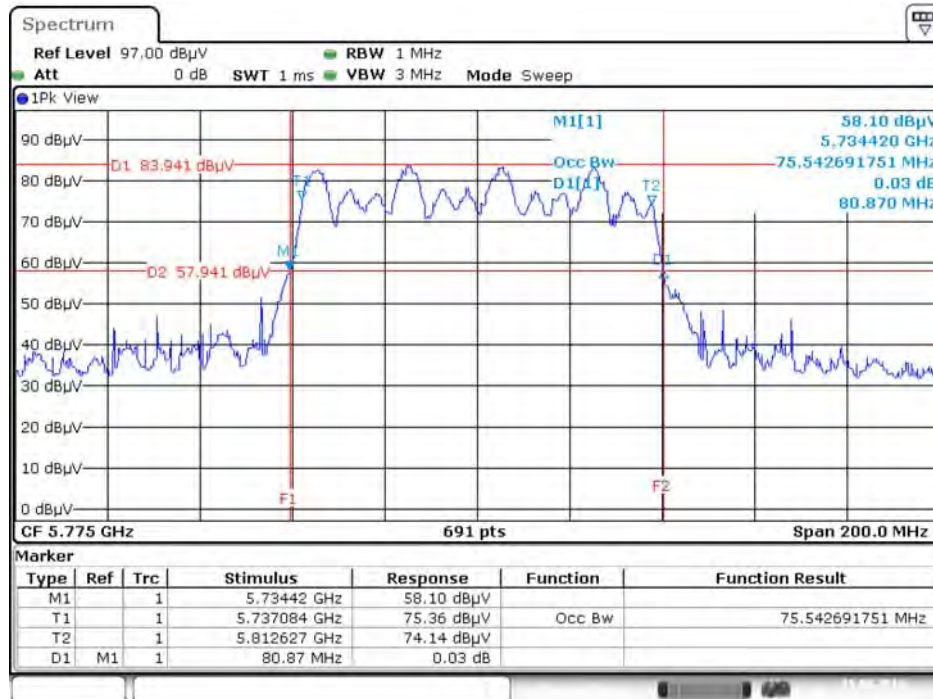

Date: 15.AUG.2016 19:51:52

<For Beamforming Mode> Band 1 / Band 4 Indoor, Outdoor use

Temperature	25°C	Humidity	60%
Test Engineer	Akina Chiu		

Mode	Frequency	26dB Bandwidth (MHz)	99% Occupied Bandwidth (MHz)
802.11ac MCS0/Nss1 VHT20	5180 MHz	21.91	17.97
	5200 MHz	21.13	17.97
	5240 MHz	21.74	17.97
	5745 MHz	20.96	17.97
	5785 MHz	21.30	17.97
	5825 MHz	21.65	17.97
802.11ac MCS0/Nss1 VHT40	5190 MHz	45.94	36.76
	5230 MHz	44.06	36.90
	5755 MHz	43.33	37.05
	5795 MHz	42.90	37.05
802.11ac MCS0/Nss1 VHT80	5210 MHz	98.84	76.70
	5775 MHz	86.09	76.41

26dB Bandwidth and 99% Occupied Bandwidth Plot on Configuration IEEE 802.11ac MCS0/Nss1 VHT20 / Chain 1 + Chain 2 + Chain 3+ Chain 4 / 5180 MHz

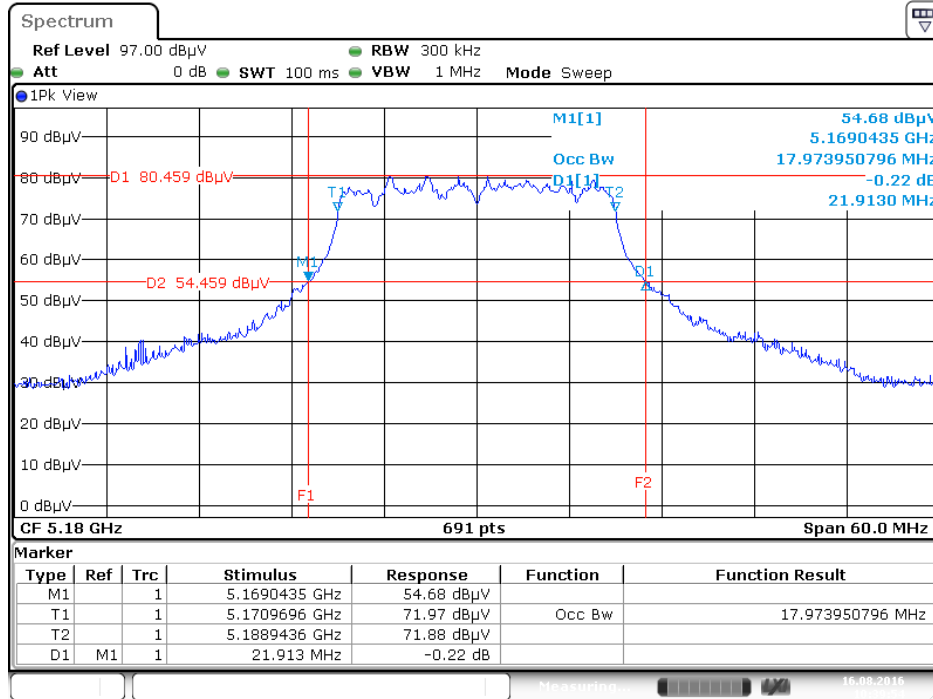

Date: 16.AUG.2016 10:39:55

26dB Bandwidth and 99% Occupied Bandwidth Plot on Configuration IEEE 802.11ac MCS0/Nss1 VHT20 / Chain 1 + Chain 2 + Chain 3+ Chain 4 / 5200 MHz

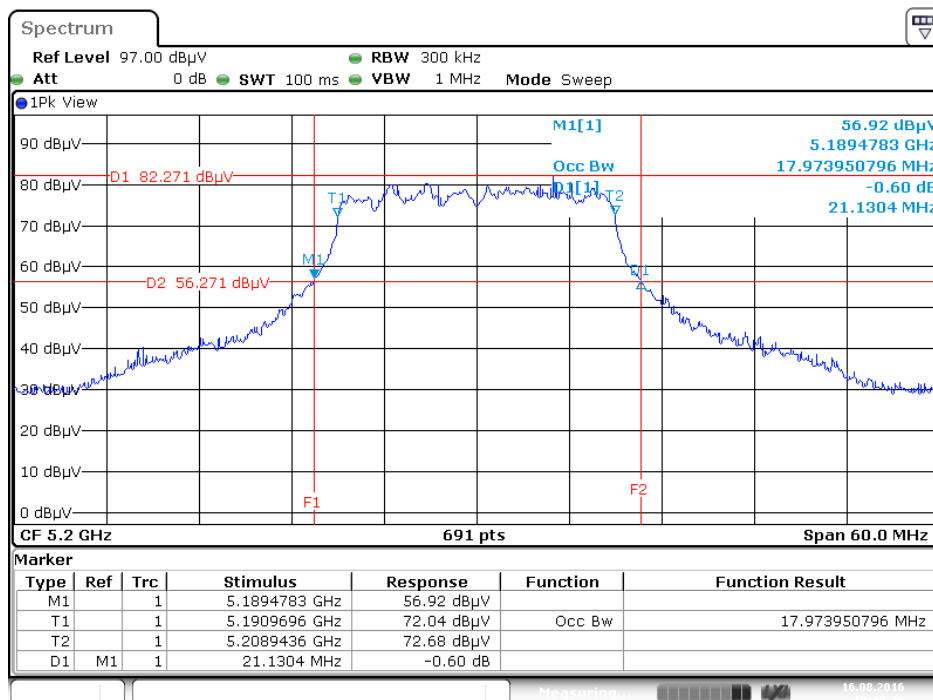

Date: 16.AUG.2016 10:40:21

26dB Bandwidth and 99% Occupied Bandwidth Plot on Configuration IEEE 802.11ac MCS0/Nss1 VHT20 / Chain 1 + Chain 2 + Chain 3+ Chain 4 / 5240 MHz

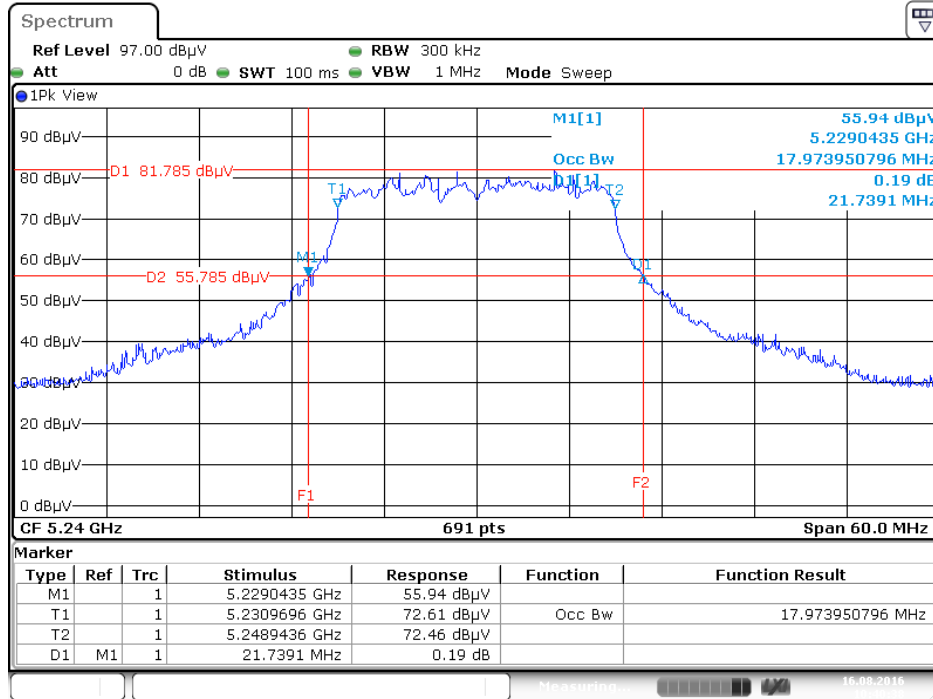

Date: 16.AUG.2016 10:40:38

26dB Bandwidth and 99% Occupied Bandwidth Plot on Configuration IEEE 802.11ac MCS0/Nss1 VHT20 / Chain 1 + Chain 2 + Chain 3+ Chain 4 / 5745 MHz

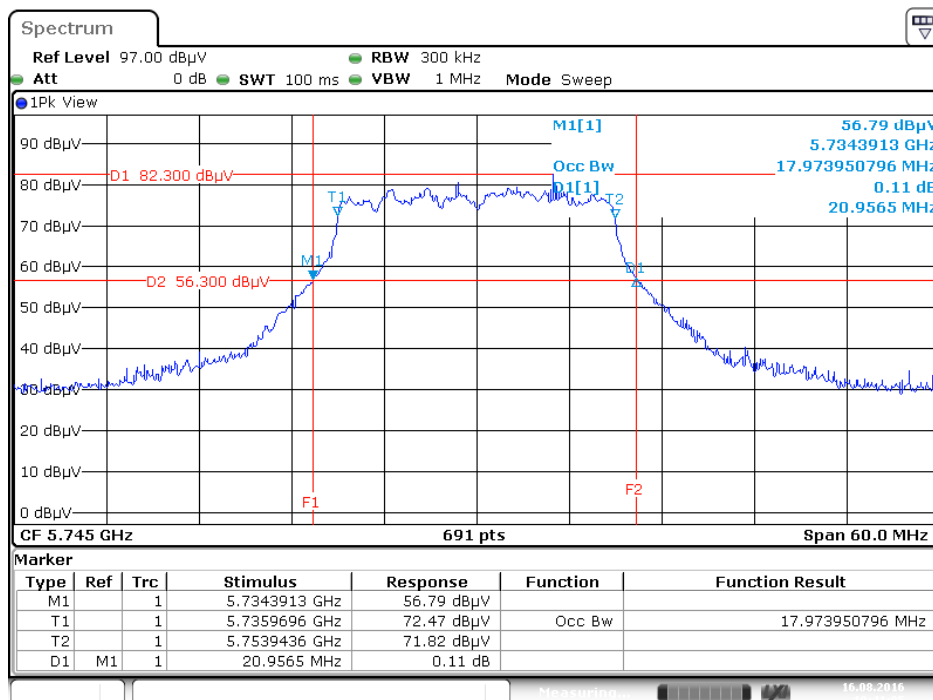

Date: 16.AUG.2016 10:41:06

26dB Bandwidth and 99% Occupied Bandwidth Plot on Configuration IEEE 802.11ac MCS0/Nss1 VHT20 / Chain 1 + Chain 2 + Chain 3+ Chain 4 / 5785 MHz

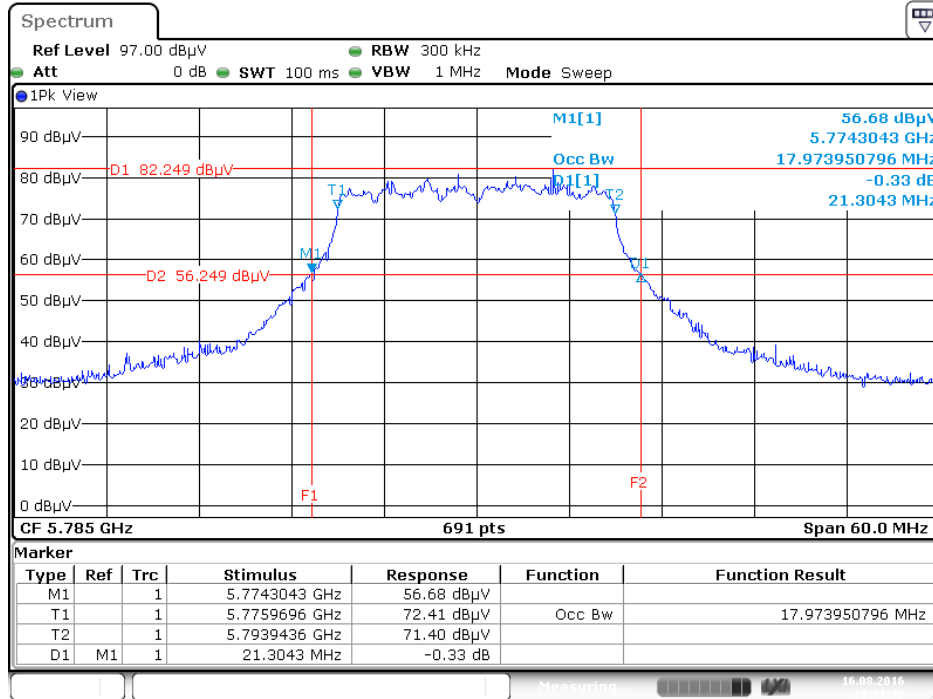

Date: 16.AUG.2016 10:41:32

26dB Bandwidth and 99% Occupied Bandwidth Plot on Configuration IEEE 802.11ac MCS0/Nss1 VHT20 / Chain 1 + Chain 2 + Chain 3+ Chain 4 / 5825 MHz

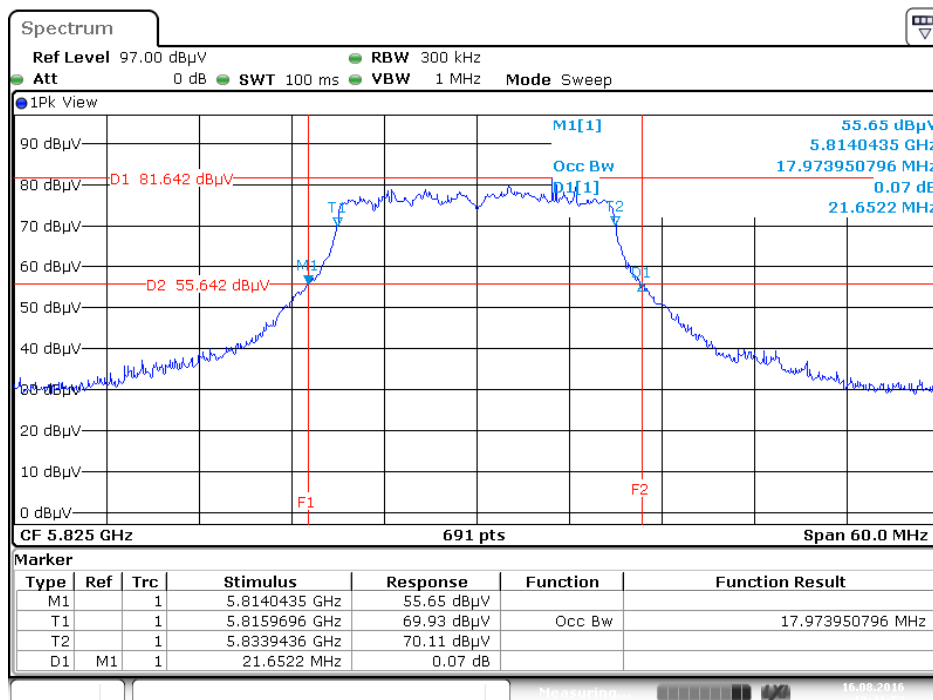

Date: 16.AUG.2016 10:41:53

26dB Bandwidth and 99% Occupied Bandwidth Plot on Configuration IEEE 802.11ac MCS0/Nss1 VHT40 / Chain 1 + Chain 2 + Chain 3+ Chain 4 / 5190 MHz

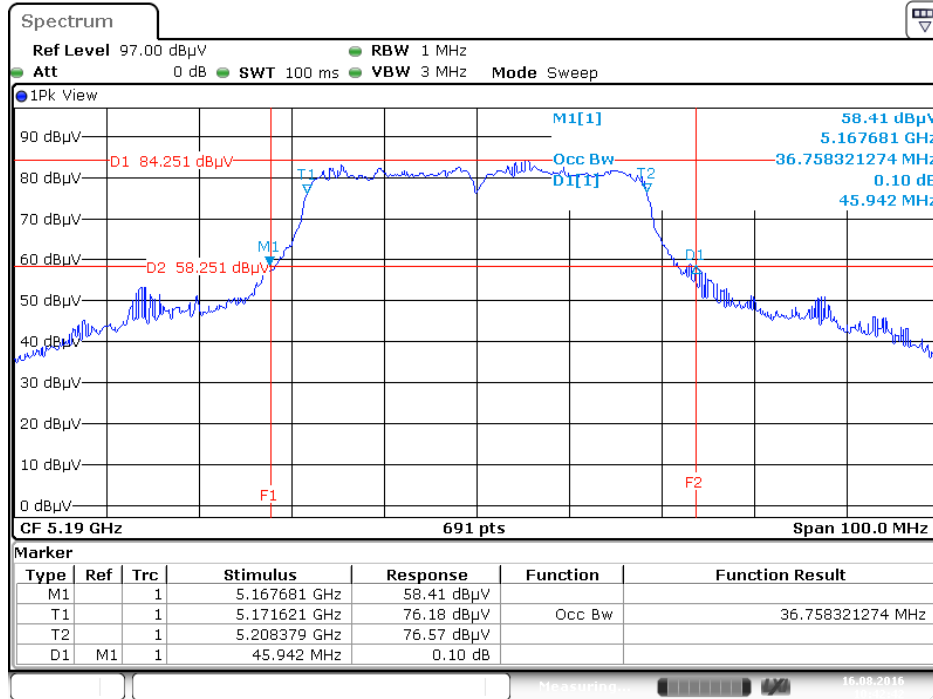

26dB Bandwidth and 99% Occupied Bandwidth Plot on Configuration IEEE 802.11ac MCS0/Nss1 VHT40 / Chain 1 + Chain 2 + Chain 3+ Chain 4 / 5230 MHz

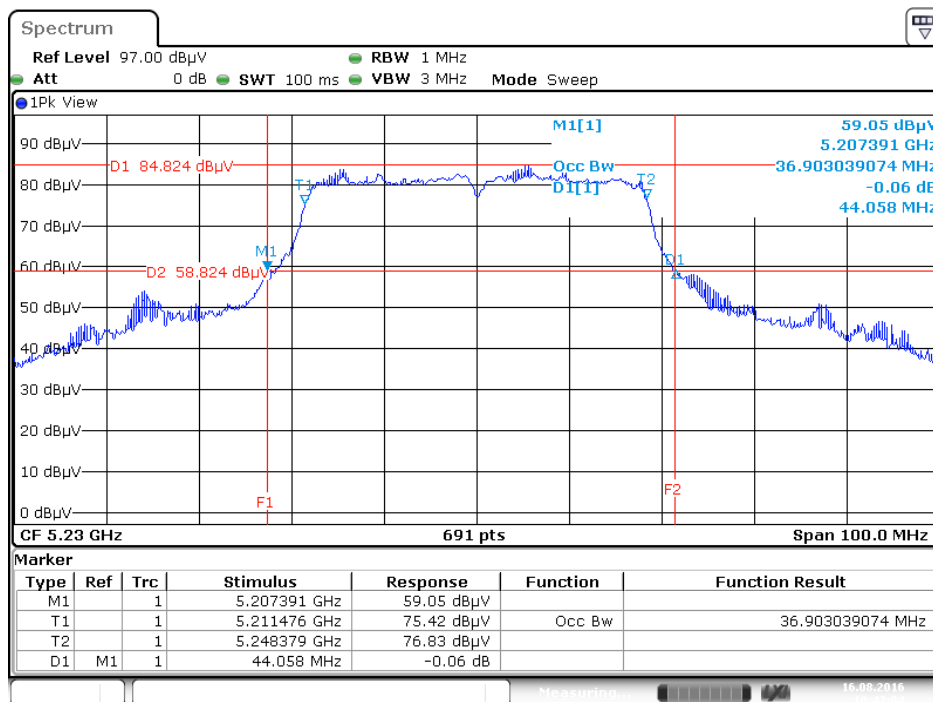

26dB Bandwidth and 99% Occupied Bandwidth Plot on Configuration IEEE 802.11ac MCS0/Nss1 VHT40 / Chain 1 + Chain 2 + Chain 3+ Chain 4 / 5755 MHz

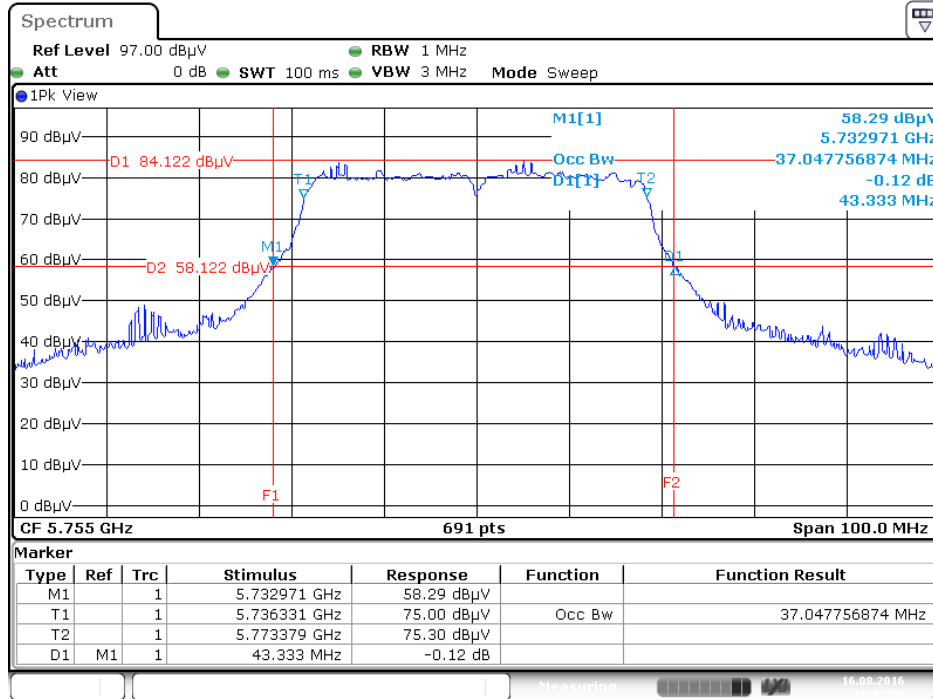

Date: 16.AUG.2016 10:43:32

26dB Bandwidth and 99% Occupied Bandwidth Plot on Configuration IEEE 802.11ac MCS0/Nss1 VHT40 / Chain 1 + Chain 2 + Chain 3+ Chain 4 / 5795 MHz

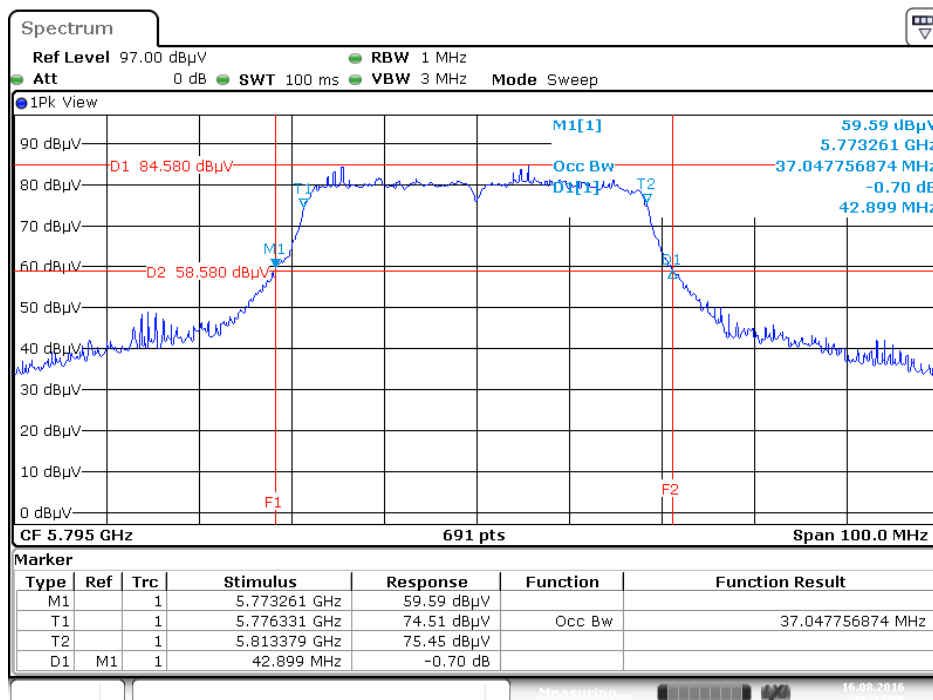

Date: 16.AUG.2016 10:43:56

26dB Bandwidth and 99% Occupied Bandwidth Plot on Configuration IEEE 802.11ac MCS0/Nss1 VHT80 / Chain 1 + Chain 2 + Chain 3+ Chain 4 / 5210 MHz

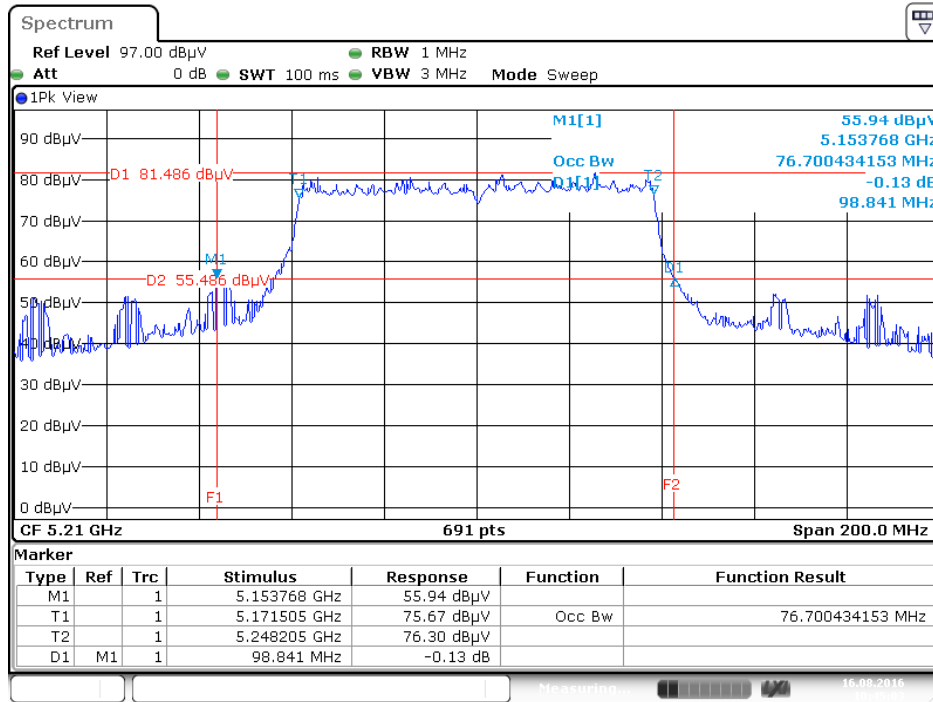

Date: 16.AUG.2016 10:45:04

26dB Bandwidth and 99% Occupied Bandwidth Plot on Configuration IEEE 802.11ac MCS0/Nss1 VHT80 / Chain 1 + Chain 2 + Chain 3+ Chain 4 / 5775 MHz

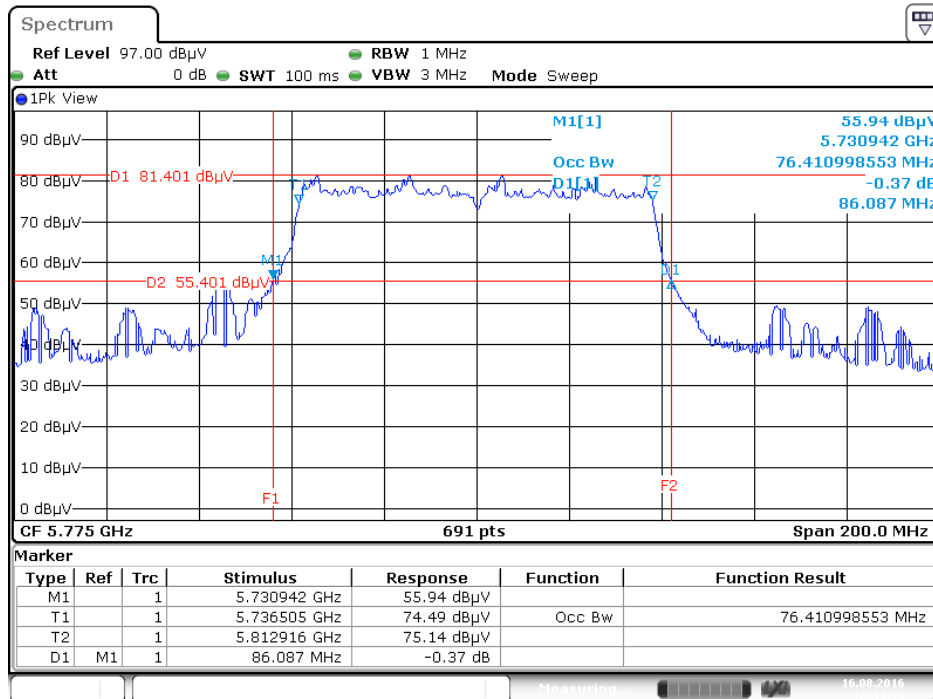

Date: 16.AUG.2016 10:44:40

4.3. 6dB Spectrum Bandwidth Measurement

4.3.1. Limit

For digital modulation systems, the minimum 6dB bandwidth shall be at least 500 kHz.

4.3.2. Measuring Instruments and Setting

Please refer to section 5 of equipments list in this report. The following table is the setting of spectrum analyzer.

6dB Spectrum Bandwidth	
Spectrum Parameters	Setting
Attenuation	Auto
Span Frequency	> 6dB Bandwidth
RBW	100kHz
VBW	$\geq 3 \times \text{RBW}$
Detector	Peak
Trace	Max Hold
Sweep Time	Auto

4.3.3. Test Procedures

For Radiated 6dB Bandwidth Measurement:

1. The transmitter was radiated to the spectrum analyzer in peak hold mode.
2. Test was performed in accordance with KDB789033 D02 v01r03 for Compliance Testing of Unlicensed National Information Infrastructure (U-NII) Devices - section (C) Emission Bandwidth.
3. Multiple antenna system was performed in accordance with KDB662911 D01 v02r01 Emissions Testing of Transmitters with Multiple Outputs in the Same Band.
4. Measured the spectrum width with power higher than 6dB below carrier.

4.3.4. Test Setup Layout

For Radiated 6dB Bandwidth Measurement:

This test setup layout is the same as that shown in section 4.6.4.

4.3.5. Test Deviation

There is no deviation with the original standard.

4.3.6. EUT Operation during Test

The EUT was programmed to be in continuously transmitting mode.

4.3.7. Test Result of 6dB Spectrum Bandwidth

For OMNI antenna:

<For Non-Beamforming Mode> Band 4 Indoor, Outdoor use

Temperature	25°C	Humidity	60%
Test Engineer	Akina Chiu		

Mode	Frequency	6dB Bandwidth (MHz)	Min. Limit (kHz)	Test Result
802.11a	5745 MHz	4.41	500	Complies
	5785 MHz	13.80	500	Complies
	5825 MHz	15.30	500	Complies
802.11ac MCS0/Nss1 VHT20	5745 MHz	4.75	500	Complies
	5785 MHz	4.17	500	Complies
	5825 MHz	10.32	500	Complies
802.11ac MCS0/Nss1 VHT40	5755 MHz	22.61	500	Complies
	5795 MHz	23.19	500	Complies
802.11ac MCS0/Nss1 VHT80	5775 MHz	61.45	500	Complies

Note: All the test values were listed in the report.

For plots, only the channel with worse result was shown.

6 dB Bandwidth Plot on Configuration IEEE 802.11a / Chain 1 + Chain 2 + Chain 3 +Chain 4 / 5745 MHz

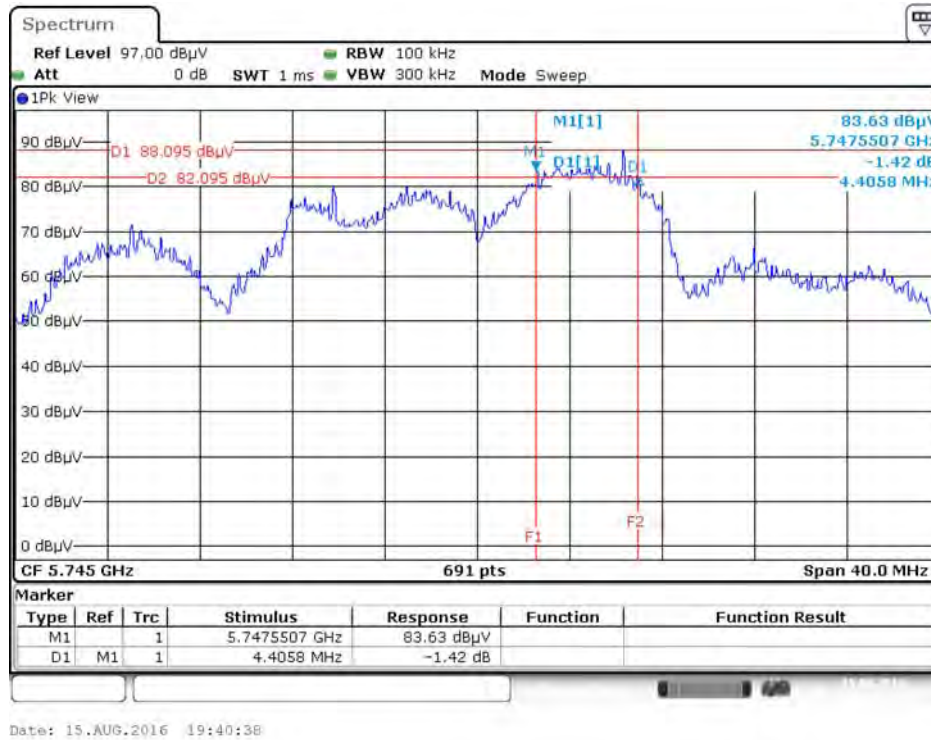

6 dB Bandwidth Plot on Configuration IEEE 802.11ac MCS0/Nss1 VHT20 / Chain 1 + Chain 2 + Chain 3 +Chain 4 / 5745 MHz

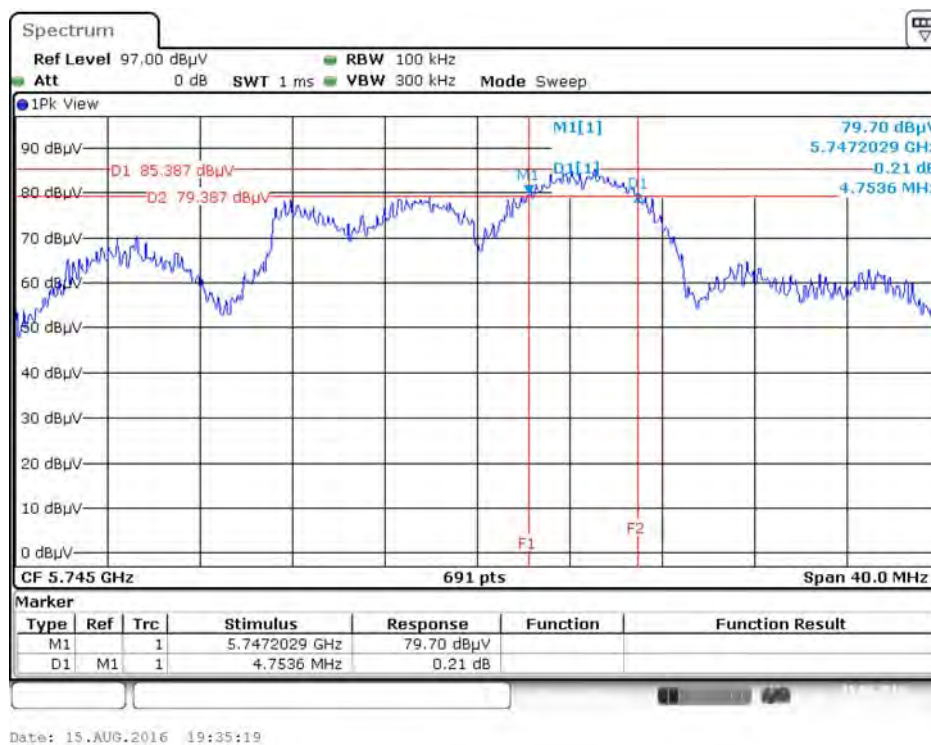

6 dB Bandwidth Plot on Configuration IEEE 802.11ac MCS0/Nss1 VHT40 / Chain 1 + Chain 2 + Chain 3 +Chain 4 / 5755MHz

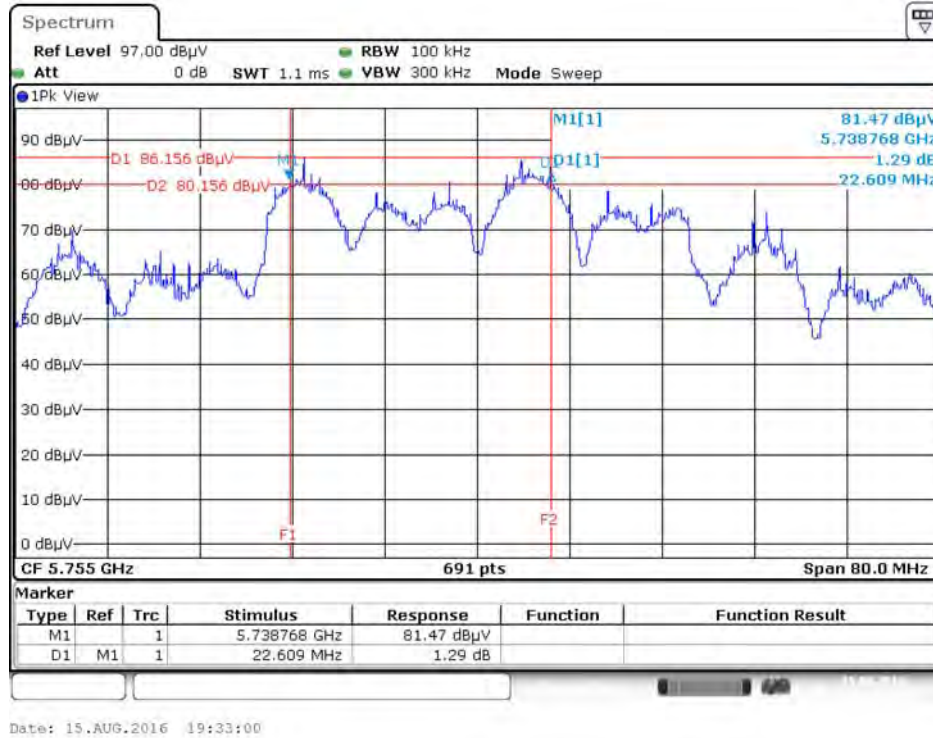

6 dB Bandwidth Plot on Configuration IEEE 802.11ac MCS0/Nss1 VHT80 / Chain 1 + Chain 2 + Chain 3 +Chain 4 / 5775 MHz

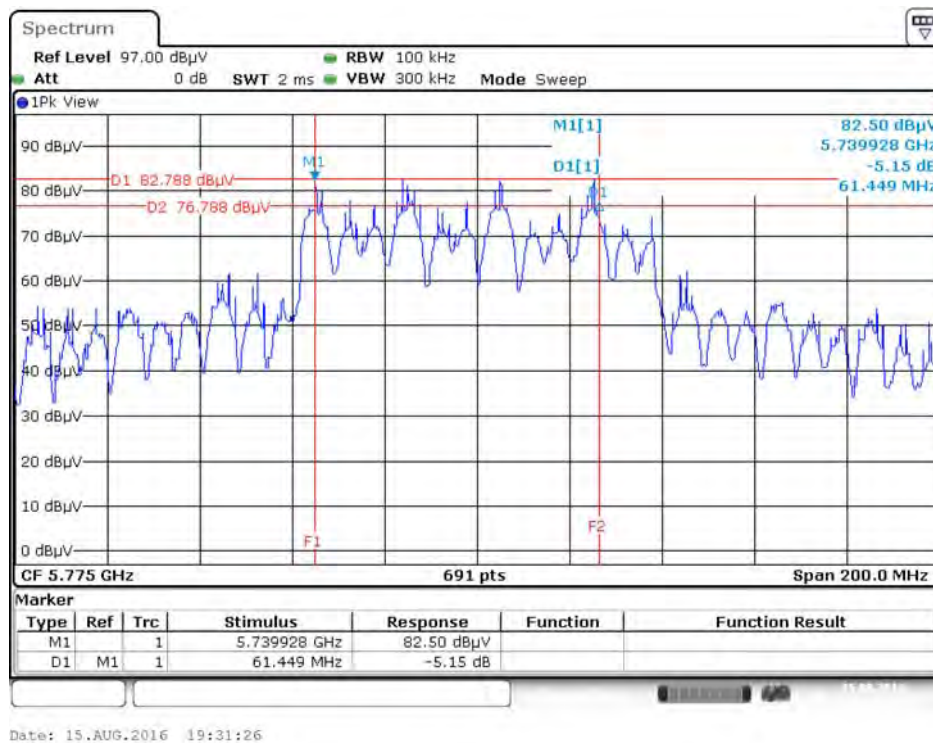

<For Beamforming Mode> Band 4 Indoor, Outdoor use

Temperature	25°C	Humidity	60%
Test Engineer	Akina Chiu		

Mode	Frequency	6dB Bandwidth (MHz)	Min. Limit (kHz)	Test Result
802.11ac MCS0/Nss1 VHT20	5745 MHz	12.52	500	Complies
	5785 MHz	14.38	500	Complies
	5825 MHz	12.58	500	Complies
802.11ac MCS0/Nss1 VHT40	5755 MHz	28.87	500	Complies
	5795 MHz	30.03	500	Complies
802.11ac MCS0/Nss1 VHT80	5775 MHz	63.77	500	Complies

Note: All the test values were listed in the report.

For plots, only the channel with worse result was shown.

6 dB Bandwidth Plot on Configuration IEEE 802.11ac MCS0/Nss1 VHT20 / Chain 1 + Chain 2 + Chain 3 +Chain 4 / 5745 MHz

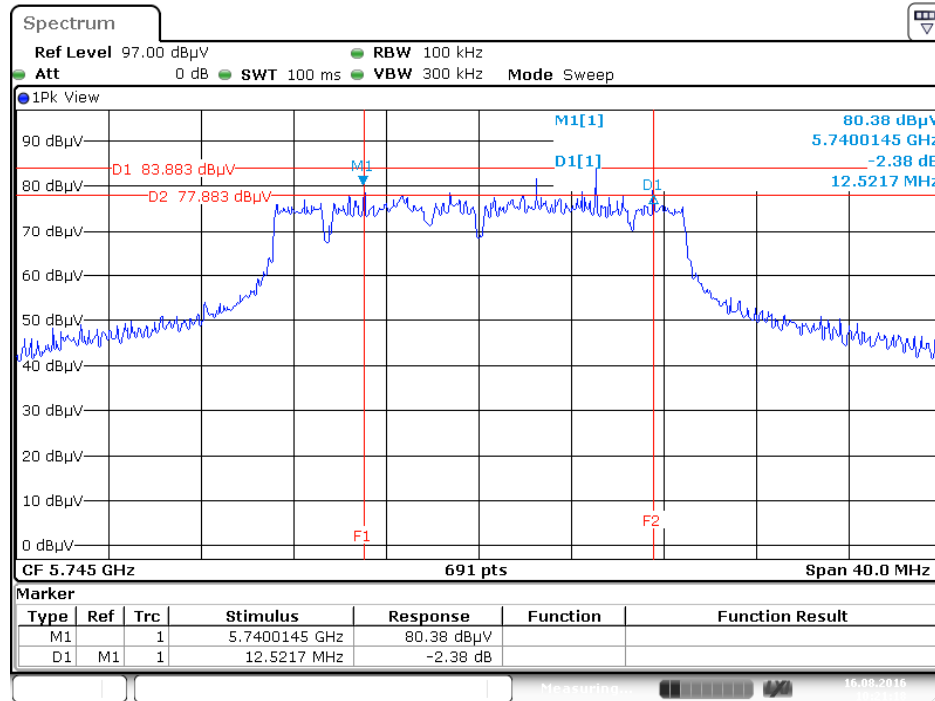

Date: 16.AUG.2016 10:21:18

6 dB Bandwidth Plot on Configuration IEEE 802.11ac MCS0/Nss1 VHT40 / Chain 1 + Chain 2 + Chain 3 +Chain 4 / 5755MHz

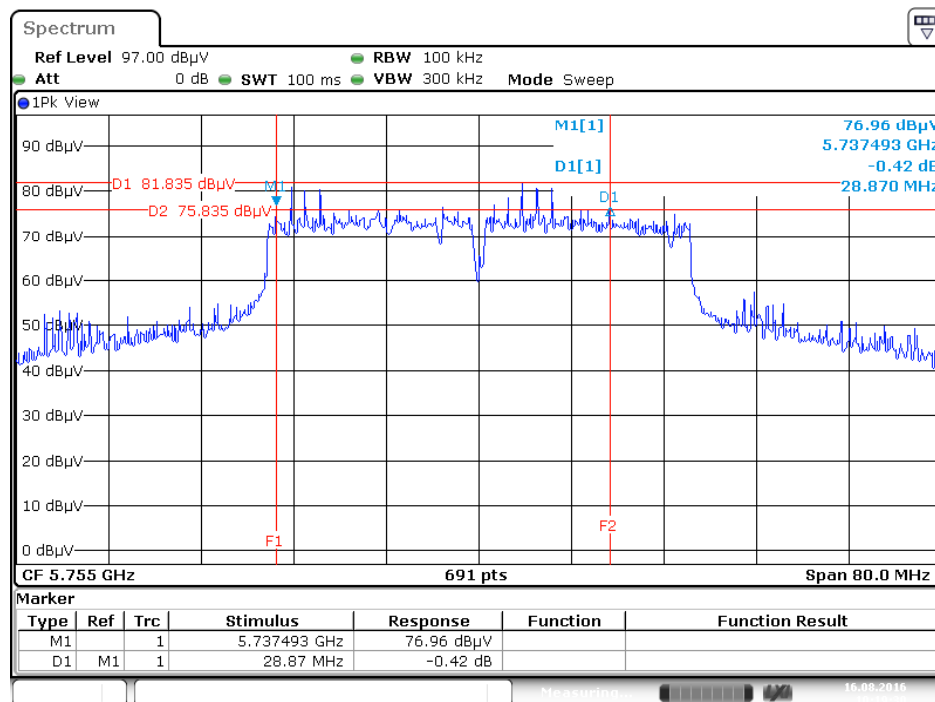

Date: 16.AUG.2016 10:19:31

6 dB Bandwidth Plot on Configuration IEEE 802.11ac MCS0/Nss1 VHT80 / Chain 1 + Chain 2 + Chain 3 +Chain 4 / 5775 MHz

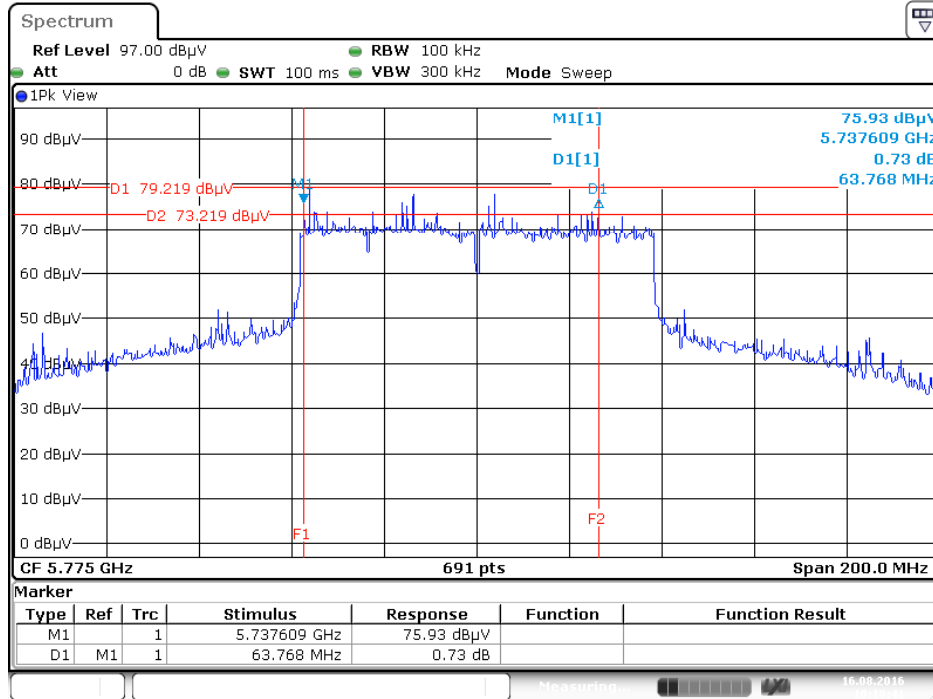

Date: 16.AUG.2016 10:18:42

For Directional antenna:

<For Non-Beamforming Mode> Band 4 Indoor, Outdoor use

Temperature	25°C	Humidity	60%
Test Engineer	Akina Chiu		

Mode	Frequency	6dB Bandwidth (MHz)	Min. Limit (kHz)	Test Result
802.11a	5745 MHz	2.96	500	Complies
	5785 MHz	2.49	500	Complies
	5825 MHz	15.13	500	Complies
802.11ac MCS0/Nss1 VHT20	5745 MHz	3.25	500	Complies
	5785 MHz	15.07	500	Complies
	5825 MHz	15.07	500	Complies
802.11ac MCS0/Nss1 VHT40	5755 MHz	22.49	500	Complies
	5795 MHz	27.59	500	Complies
802.11ac MCS0/Nss1 VHT80	5775 MHz	60.87	500	Complies

Note: All the test values were listed in the report.

For plots, only the channel with worse result was shown.

6 dB Bandwidth Plot on Configuration IEEE 802.11a / Chain 1 + Chain 2 + Chain 3 +Chain 4 / 5745 MHz

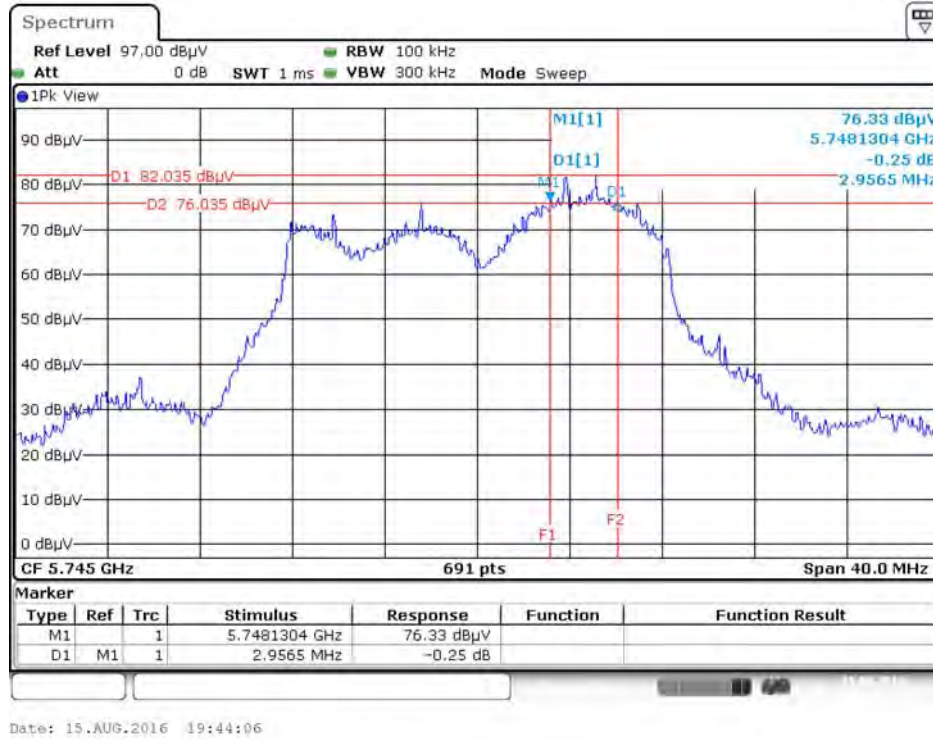

6 dB Bandwidth Plot on Configuration IEEE 802.11ac MCS0/Nss1 VHT20 / Chain 1 + Chain 2 + Chain 3 +Chain 4 / 5745 MHz

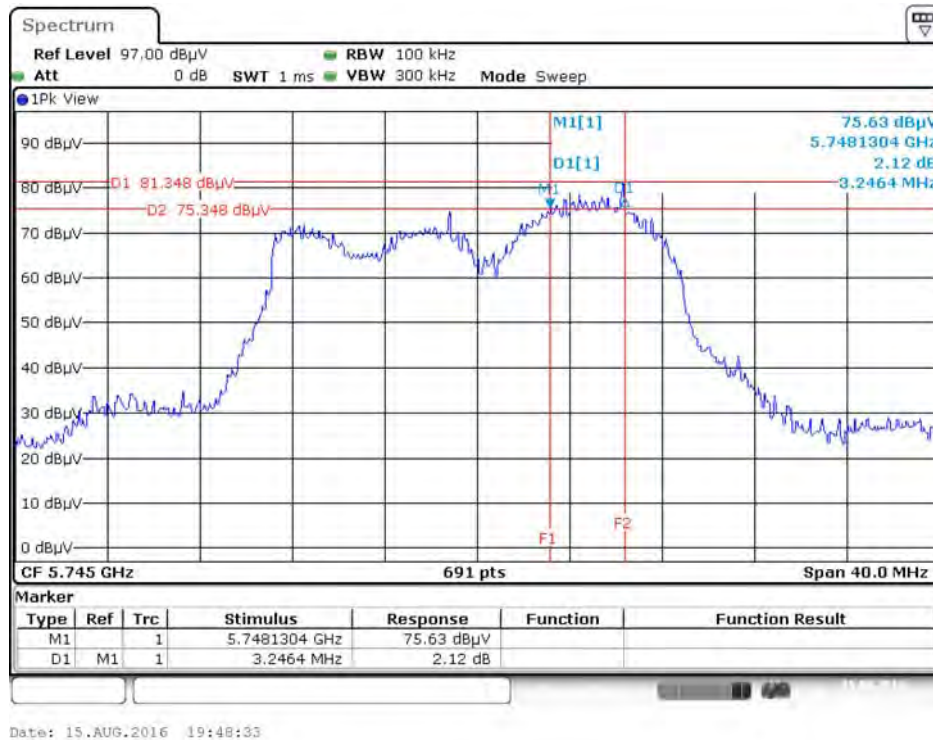

6 dB Bandwidth Plot on Configuration IEEE 802.11ac MCS0/Nss1 VHT40 / Chain 1 + Chain 2 + Chain 3 +Chain 4 / 5755MHz

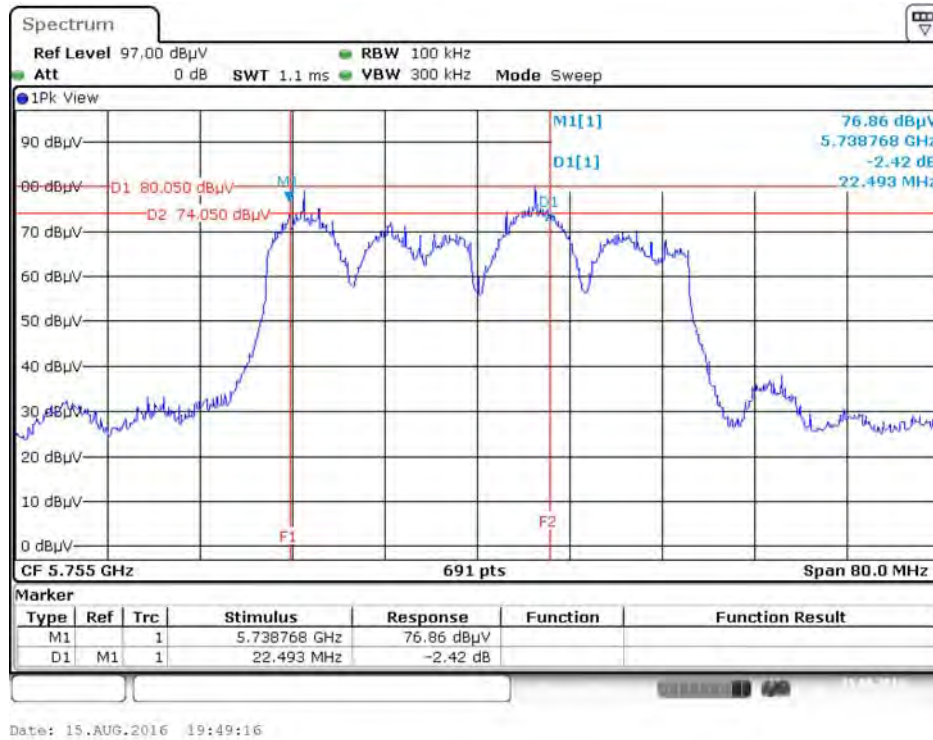

6 dB Bandwidth Plot on Configuration IEEE 802.11ac MCS0/Nss1 VHT80 / Chain 1 + Chain 2 + Chain 3 +Chain 4 / 5775 MHz

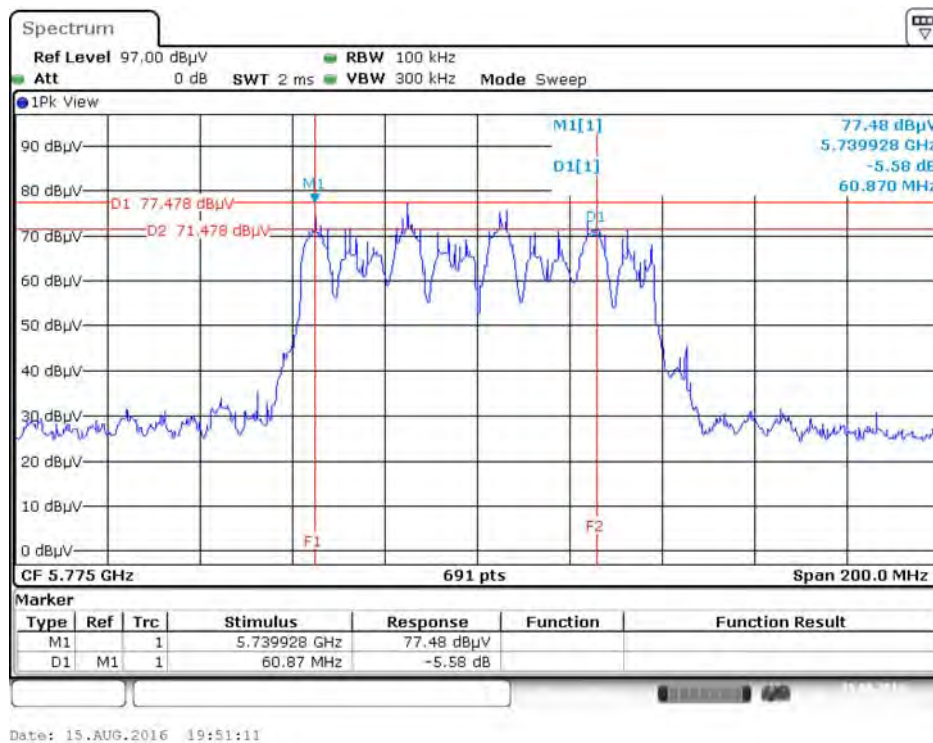

<For Beamforming Mode> Band 4 Indoor, Outdoor use

Temperature	25°C	Humidity	60%
Test Engineer	Akina Chiu		

Mode	Frequency	6dB Bandwidth (MHz)	Min. Limit (kHz)	Test Result
802.11ac MCS0/Nss1 VHT20	5745 MHz	13.80	500	Complies
	5785 MHz	11.94	500	Complies
	5825 MHz	17.62	500	Complies
802.11ac MCS0/Nss1 VHT40	5755 MHz	28.87	500	Complies
	5795 MHz	33.51	500	Complies
802.11ac MCS0/Nss1 VHT80	5775 MHz	68.99	500	Complies

Note: All the test values were listed in the report.

For plots, only the channel with worse result was shown.

6 dB Bandwidth Plot on Configuration IEEE 802.11ac MCS0/Nss1 VHT20 / Chain 1 + Chain 2 + Chain 3 +Chain 4 / 5785MHz

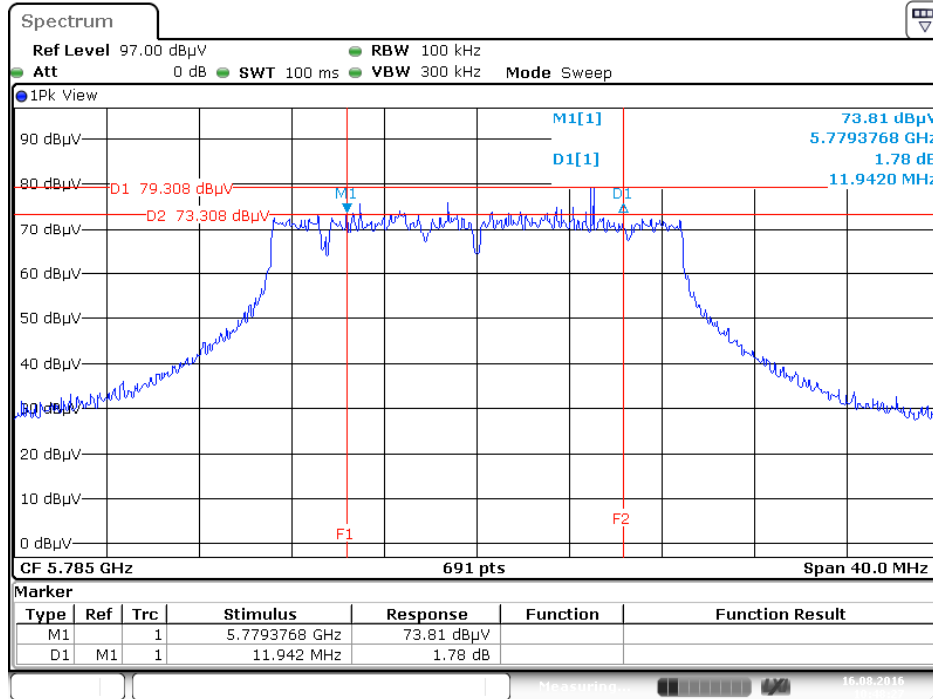

Date: 16.AUG.2016 10:48:27

6 dB Bandwidth Plot on Configuration IEEE 802.11ac MCS0/Nss1 VHT40 / Chain 1 + Chain 2 + Chain 3 +Chain 4 / 5755MHz

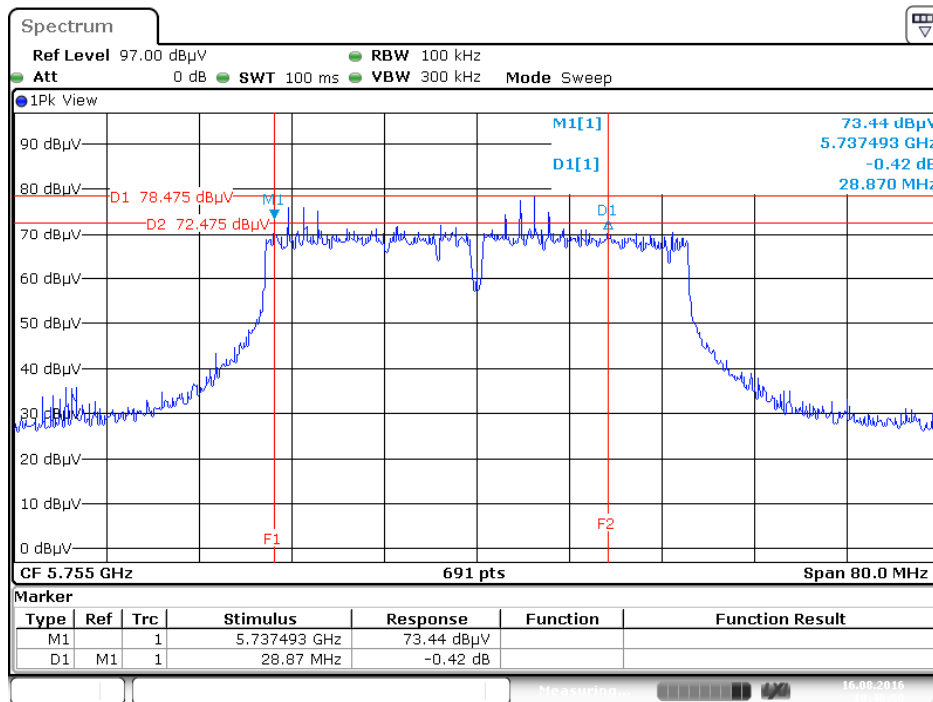

Date: 16.AUG.2016 10:46:51

6 dB Bandwidth Plot on Configuration IEEE 802.11ac MCS0/Nss1 VHT80 / Chain 1 + Chain 2 + Chain 3 +Chain 4 / 5775 MHz

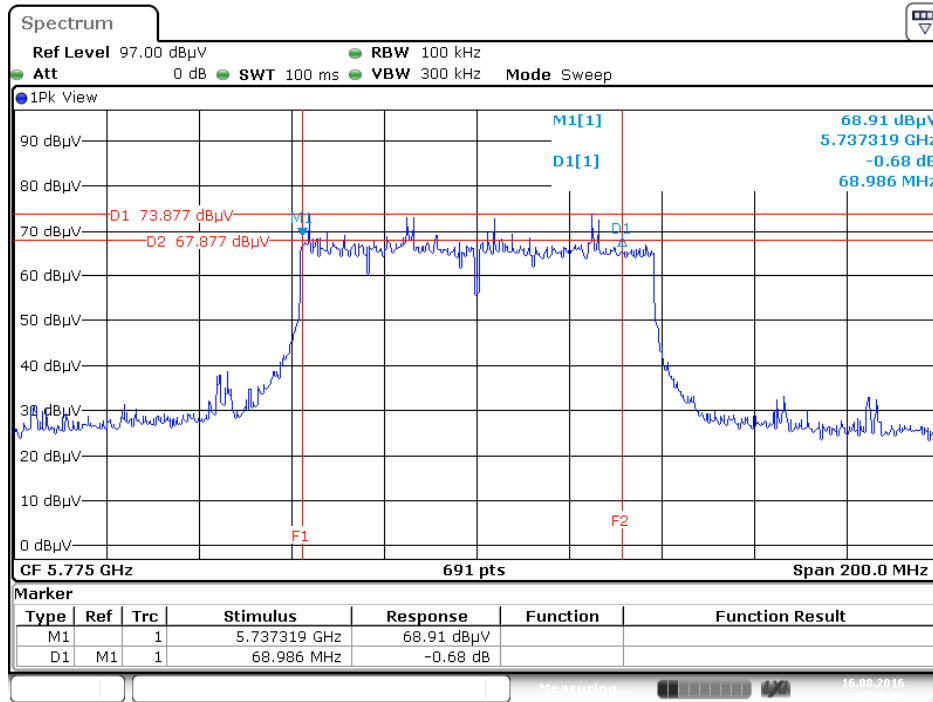

4.4. Maximum Conducted Output Power Measurement

4.4.1. Limit

Frequency Band	Limit
<input checked="" type="checkbox"/> 5.15~5.25 GHz	
Operating Mode	
<input checked="" type="checkbox"/> Outdoor access point	<p>The maximum conducted output power over the frequency band of operation shall not exceed 1 W (30dBm) provided the maximum antenna gain does not exceed 6 dBi. If transmitting antennas of directional gain greater than 6 dBi are used, both the maximum conducted output power and the maximum power spectral density shall be reduced by the amount in dB that the directional gain of the antenna exceeds 6 dBi. The maximum e.i.r.p. at any elevation angle above 30 degrees as measured from the horizon must not exceed 125 mW (21 dBm).</p>
<input checked="" type="checkbox"/> Indoor access point	<p>The maximum conducted output power over the frequency band of operation shall not exceed 1 W (30dBm) provided the maximum antenna gain does not exceed 6 dBi. If transmitting antennas of directional gain greater than 6 dBi are used, both the maximum conducted output power and the maximum power spectral density shall be reduced by the amount in dB that the directional gain of the antenna exceeds 6 dBi.</p>
<input type="checkbox"/> Fixed point-to-point access points	<p>The maximum conducted output power over the frequency band of operation shall not exceed 1 W (30dBm). Fixed point-to-point U-NII devices may employ antennas with directional gain up to 23 dBi without any corresponding reduction in the maximum conducted output power or maximum power spectral density. For fixed point-to-point transmitters that employ a directional antenna gain greater than 23 dBi, a 1 dB reduction in maximum conducted output power and maximum power spectral density is required for each 1 dB of antenna gain in excess of 23 dBi.</p>
<input type="checkbox"/> Client devices	<p>The maximum conducted output power over the frequency band of operation shall not exceed 250 mW (24dBm) provided the maximum antenna gain does not exceed 6 dBi. If transmitting antennas of directional gain greater than 6 dBi are used, both the maximum conducted output power and the maximum power spectral density shall be reduced by the amount in dB that the directional gain of the antenna exceeds 6 dBi.</p>

☒	5.725~5.85 GHz	The maximum conducted output power over the frequency band of operation shall not exceed 1 W (30dBm). If transmitting antennas of directional gain greater than 6 dBi are used, both the maximum conducted output power and the maximum power spectral density shall be reduced by the amount in dB that the directional gain of the antenna exceeds 6 dBi. However, fixed point-to-point U-NII devices operating in this band may employ transmitting antennas with directional gain greater than 6 dBi without any corresponding reduction in transmitter conducted power.
---	----------------	--

4.4.2. Measuring Instruments and Setting

Please refer to section 5 of equipments list in this report. The following table is the setting of the power meter.

Power Meter Parameter	Setting
Detector	AVERAGE

4.4.3. Test Procedures

1. The transmitter output (antenna port) was connected to the power meter.
2. Test was performed in accordance with KDB789033 D02 v01r03 for Compliance Testing of Unlicensed National Information Infrastructure (U-NII) Devices - section (E) Maximum conducted output power =>3. Measurement using a Power Meter (PM) =>b) Method PM-G (Measurement using a gated RF average power meter).
3. Multiple antenna systems was performed in accordance with KDB662911 D01 v02r01 Emissions Testing of Transmitters with Multiple Outputs in the Same Band.
4. When measuring maximum conducted output power with multiple antenna systems, add every result of the values by mathematic formula.

4.4.4. Test Setup Layout

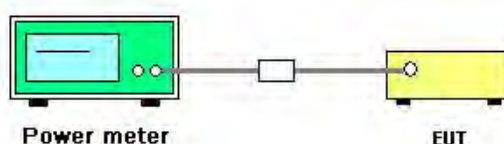

4.4.5. Test Deviation

There is no deviation with the original standard.

4.4.6. EUT Operation during Test

The EUT was programmed to be in continuously transmitting mode.

4.4.7. Test Result of Maximum Conducted Output Power

For OMNI antenna:

<For Non-Beamforming Mode> Band 1 / Band 4 Indoor, Outdoor use

Temperature	25°C	Humidity	60%
Test Engineer	Akina Chiu	Test Date	Jun. 15, 2016~Jul. 27, 2016

Mode	Frequency	Conducted Power (dBm)					Max. Limit (dBm)	Result
		Chain 1	Chain 2	Chain 3	Chain 4	Total		
802.11a	5180 MHz	20.15	19.64	19.05	19.87	25.72	30.00	Complies
	5200 MHz	20.81	20.14	19.72	20.63	26.37	30.00	Complies
	5240 MHz	21.43	20.75	20.63	21.27	27.05	30.00	Complies
	5745 MHz	22.92	21.55	22.83	22.37	28.47	30.00	Complies
	5785 MHz	22.44	21.56	22.62	22.01	28.20	30.00	Complies
	5825 MHz	22.04	20.83	21.98	21.96	27.75	30.00	Complies
802.11ac MCS0/Nss1 VHT20	5180 MHz	20.06	19.43	19.17	19.92	25.68	30.00	Complies
	5200 MHz	21.38	20.35	20.11	20.94	26.74	30.00	Complies
	5240 MHz	21.06	20.02	20.12	20.63	26.50	30.00	Complies
	5745 MHz	23.25	21.81	23.20	22.71	28.80	30.00	Complies
	5785 MHz	22.63	20.87	22.86	22.39	28.27	30.00	Complies
	5825 MHz	22.42	20.51	22.26	22.17	27.92	30.00	Complies
802.11ac MCS0/Nss1 VHT40	5190 MHz	19.81	19.15	19.01	19.59	25.42	30.00	Complies
	5230 MHz	21.59	20.64	20.66	21.28	27.08	30.00	Complies
	5755 MHz	22.48	21.25	22.56	22.08	28.14	30.00	Complies
	5795 MHz	22.32	20.62	22.35	22.09	27.92	30.00	Complies
802.11ac MCS0/Nss1 VHT80	5210 MHz	18.63	18.01	18.15	18.45	24.34	30.00	Complies
	5775 MHz	21.89	20.82	21.96	20.57	27.37	30.00	Complies

Note: Band 1 Ant. Gain = -4.84dBi < 6dBi, so Power Limit 30dBm

Note: Band 4 Ant. Gain = -5.87dBi < 6dBi, so Power Limit 30dBm

<For Beamforming Mode> Band 1 / Band 4 Indoor, Outdoor use

Temperature	25°C	Humidity	60%
Test Engineer	Akina Chiu	Test Date	Jun. 15, 2016~Jul. 27, 2016

Mode	Frequency	Conducted Power (dBm)					Max. Limit (dBm)	Result
		Chain 1	Chain 2	Chain 3	Chain 4	Total		
802.11ac MCS0/Nss1 VHT20	5180 MHz	18.48	18.87	18.92	18.55	24.73	30.00	Complies
	5200 MHz	18.26	18.85	19.08	19.04	24.84	30.00	Complies
	5240 MHz	18.34	19.11	19.05	18.68	24.83	30.00	Complies
	5745 MHz	19.05	19.27	19.02	19.02	25.11	30.00	Complies
	5785 MHz	19.21	19.13	19.27	18.76	25.12	30.00	Complies
	5825 MHz	18.45	18.21	18.15	18.06	24.24	30.00	Complies
802.11ac MCS0/Nss1 VHT40	5190 MHz	18.37	18.64	19.03	19.17	24.83	30.00	Complies
	5230 MHz	18.76	18.93	19.42	18.71	24.98	30.00	Complies
	5755 MHz	19.52	19.56	19.23	18.59	25.26	30.00	Complies
	5795 MHz	19.56	19.03	19.22	18.71	25.16	30.00	Complies
802.11ac MCS0/Nss1 VHT80	5210 MHz	18.50	18.47	18.59	18.54	24.55	30.00	Complies
	5775 MHz	18.67	18.22	18.39	18.01	24.35	30.00	Complies

Note: Band 1 directional gain= -0.84dBi<6dBi, so Power Limit 30dBm

Note: Band 4 directional gain=-1.87dBi<6dBi, so Power Limit 30dBm

<For Non-Beamforming Mode> Band 1 Outdoor use

Temperature	25°C	Humidity	60%
Test Engineer	Akina Chiu	Test Date	Jun. 15, 2016~Jul. 27, 2016

Mode	Frequency	Conducted Power (dBm)					Max. Limit (dBm)	Result
		Chain 1	Chain 2	Chain 3	Chain 4	Total		
802.11a	5180 MHz	20.15	19.64	19.05	19.87	25.72	30.00	Complies
	5200 MHz	20.81	20.14	19.72	20.63	26.37	30.00	Complies
	5240 MHz	21.43	20.75	20.63	21.27	27.05	30.00	Complies
802.11ac MCS0/Nss1 VHT20	5180 MHz	20.06	19.43	19.17	19.92	25.68	30.00	Complies
	5200 MHz	21.38	20.35	20.11	20.94	26.74	30.00	Complies
	5240 MHz	21.06	20.02	20.12	20.63	26.50	30.00	Complies
802.11ac MCS0/Nss1	5190 MHz	19.81	19.15	19.01	19.59	25.42	30.00	Complies
	5230 MHz	21.59	20.64	20.66	21.28	27.08	30.00	Complies
802.11ac MCS0/Nss1 VHT80	5210 MHz	18.63	18.01	18.15	18.45	24.34	30.00	Complies

Note: Band 1 Ant. Gain=-4.84dBi<6dBi, so Power Limit 30dBm

Note: Band 4 Ant. Gain=-5.87dBi<6dBi, so Power Limit 30dBm

<For Beamforming Mode> Band 1 Outdoor use

Temperature	25°C	Humidity	60%
Test Engineer	Akina Chiu	Test Date	Jun. 15, 2016~Jul. 27, 2016

Mode	Frequency	Conducted Power (dBm)					Max. Limit (dBm)	Result
		Chain 1	Chain 2	Chain 3	Chain 4	Total		
802.11ac	5180 MHz	17.45	17.91	17.90	17.58	23.74	30.00	Complies
MCS0/Nss1	5200 MHz	17.31	17.79	18.06	18.05	23.83	30.00	Complies
VHT20	5240 MHz	17.36	18.14	18.06	17.65	23.83	30.00	Complies
VHT40	5190 MHz	17.38	17.61	18.01	18.15	23.82	30.00	Complies
802.11ac	5230 MHz	17.53	17.79	18.29	17.58	23.83	30.00	Complies
MCS0/Nss1	5210 MHz	17.15	17.74	17.78	17.32	23.53	30.00	Complies
802.11ac	VHT80							

Note: Band 1 directional gain= -0.84dBi<6dBi, so Power Limit 30dBm

Note: Band 4 directional gain=-1.87dBi<6dBi, so Power Limit 30dBm

For Directional antenna:

<For Non-Beamforming Mode> Band 1 / Band 4 Indoor, Outdoor use

Temperature	25°C	Humidity	60%
Test Engineer	Akina Chiu	Test Date	Jun. 15, 2016~Jul. 27, 2016

Mode	Frequency	Conducted Power (dBm)					Max. Limit (dBm)	Result
		Chain 1	Chain 2	Chain 3	Chain 4	Total		
802.11a	5180 MHz	16.90	16.83	16.68	17.04	22.89	23.00	Complies
	5200 MHz	16.56	16.81	16.58	16.97	22.75	23.00	Complies
	5240 MHz	16.87	16.86	16.89	17.16	22.97	23.00	Complies
	5745 MHz	17.14	16.59	16.73	16.95	22.88	23.00	Complies
	5785 MHz	16.88	16.55	16.28	16.96	22.70	23.00	Complies
	5825 MHz	16.94	16.49	16.43	16.79	22.69	23.00	Complies
802.11ac MCS0/Nss1 VHT20	5180 MHz	16.96	16.94	16.65	16.91	22.89	23.00	Complies
	5200 MHz	16.71	17.12	16.63	16.83	22.85	23.00	Complies
	5240 MHz	16.49	16.65	16.91	16.87	22.75	23.00	Complies
	5745 MHz	16.88	16.62	16.41	16.92	22.73	23.00	Complies
	5785 MHz	16.85	16.46	16.46	16.77	22.66	23.00	Complies
	5825 MHz	16.94	16.61	16.47	16.66	22.69	23.00	Complies
802.11ac MCS0/Nss1 VHT40	5190 MHz	16.63	17.03	16.41	16.51	22.67	23.00	Complies
	5230 MHz	16.75	17.11	16.87	17.08	22.98	23.00	Complies
	5755 MHz	16.86	16.65	16.48	16.88	22.74	23.00	Complies
	5795 MHz	17.10	16.98	16.88	16.93	22.99	23.00	Complies
802.11ac MCS0/Nss1 VHT80	5210 MHz	15.96	15.56	15.72	15.92	21.81	23.00	Complies
	5775 MHz	16.93	16.92	16.69	17.02	22.91	23.00	Complies

Note: Ant. Gain =13dBi, so Power Limit =30-(13-6)=23dBm

<For Beamforming Mode> Band 1 / Band 4 Indoor, Outdoor use

Temperature	25°C	Humidity	60%
Test Engineer	Akina Chiu	Test Date	Jun. 15, 2016~Jul. 27, 2016

Mode	Frequency	Conducted Power (dBm)					Max. Limit (dBm)	Result
		Chain 1	Chain 2	Chain 3	Chain 4	Total		
802.11ac MCS0/Nss1 VHT20	5180 MHz	15.32	15.81	15.49	15.76	21.62	22.00	Complies
	5200 MHz	15.35	15.88	15.61	15.75	21.67	22.00	Complies
	5240 MHz	15.21	15.45	15.95	15.38	21.53	22.00	Complies
	5745 MHz	15.98	15.42	15.64	15.27	21.61	22.00	Complies
	5785 MHz	16.46	16.14	15.69	15.48	21.98	22.00	Complies
	5825 MHz	15.77	15.53	15.91	15.19	21.63	22.00	Complies
802.11ac MCS0/Nss1 VHT40	5190 MHz	15.14	15.85	15.69	15.52	21.58	22.00	Complies
	5230 MHz	15.11	15.67	15.83	15.76	21.62	22.00	Complies
	5755 MHz	16.36	15.83	16.08	15.53	21.98	22.00	Complies
	5795 MHz	15.62	15.52	15.47	15.35	21.51	22.00	Complies
802.11ac MCS0/Nss1 VHT80	5210 MHz	15.07	15.49	15.22	15.38	21.31	22.00	Complies
	5775 MHz	15.98	15.88	15.95	15.13	21.77	22.00	Complies

Note: Directional gain =14dBi, so Power Limit =30-(14-6)=22dBm

<For Non-Beamforming Mode> Band 1 Outdoor use

Temperature	25°C	Humidity	60%
Test Engineer	Akina Chiu	Test Date	Jun. 15, 2016~Jul. 27, 2016

Mode	Frequency	Conducted Power (dBm)					Max. Limit (dBm)	Result
		Chain 1	Chain 2	Chain 3	Chain 4	Total		
802.11a	5180 MHz	15.89	15.78	15.67	16.08	21.88	23.00	Complies
	5200 MHz	15.58	15.83	15.61	15.86	21.74	23.00	Complies
	5240 MHz	15.89	15.89	15.84	16.18	21.97	23.00	Complies
802.11ac MCS0/Nss1 VHT20	5180 MHz	15.97	15.91	15.68	15.89	21.88	23.00	Complies
	5200 MHz	15.79	16.08	15.69	15.84	21.87	23.00	Complies
	5240 MHz	15.89	15.71	15.81	15.85	21.84	23.00	Complies
802.11ac MCS0/Nss1 VHT40	5190 MHz	15.68	16.07	15.48	15.49	21.71	23.00	Complies
	5230 MHz	15.76	16.09	15.88	16.07	21.97	23.00	Complies
802.11ac MCS0/Nss1 VHT80	5210 MHz	15.96	15.56	15.72	15.92	21.81	23.00	Complies

Note: Ant. Gain = 13dBi, so Power Limit = 30-(13-6)=23dBm

<For Beamforming Mode> Band 1 Outdoor use

Temperature	25°C	Humidity	60%
Test Engineer	Akina Chiu	Test Date	Jun. 15, 2016~Jul. 27, 2016

Mode	Frequency	Conducted Power (dBm)					Max. Limit (dBm)	Result
		Chain 1	Chain 2	Chain 3	Chain 4	Total		
802.11ac MCS0/Nss1 VHT20	5180 MHz	14.38	14.79	14.51	14.81	20.65	22.00	Complies
	5200 MHz	14.36	14.86	14.65	14.81	20.69	22.00	Complies
	5240 MHz	14.25	14.51	15.01	14.36	20.56	22.00	Complies
802.11ac MCS0/Nss1 VHT40	5190 MHz	14.11	14.91	14.58	14.63	20.59	22.00	Complies
	5230 MHz	14.15	14.72	14.79	14.81	20.65	22.00	Complies
802.11ac MCS0/Nss1 VHT80	5210 MHz	14.31	14.78	14.28	14.38	20.46	22.00	Complies

Note: Directional gain =14dBi, so Power Limit =30-(14-6)=22dBm

4.5. Power Spectral Density Measurement

4.5.1. Limit

The following table is power spectral density limits and decrease power density limit rule refer to section 4.4.1.

Frequency Band		Limit
<input checked="" type="checkbox"/>	5.15~5.25 GHz	
	Operating Mode	
<input checked="" type="checkbox"/>	Outdoor access point	17 dBm/MHz
<input checked="" type="checkbox"/>	Indoor access point	17 dBm/MHz
<input type="checkbox"/>	Fixed point-to-point access points	17 dBm/MHz
<input type="checkbox"/>	Client devices	11 dBm/MHz
<input checked="" type="checkbox"/>	5.725~5.85 GHz	30 dBm/500kHz

4.5.2. Measuring Instruments and Setting

Please refer to section 5 of equipments list in this report. The following table is the setting of the spectrum analyzer.

Spectrum Parameter	Setting
Attenuation	Auto
Span Frequency	Encompass the entire emissions bandwidth (EBW) of the signal
RBW	1000 kHz
VBW	3000 kHz
Detector	RMS
Trace	AVERAGE
Sweep Time	Auto
Trace Average	100 times
Note: If measurement bandwidth of Maximum PSD is specified in 500 kHz, add $10\log(500\text{kHz}/\text{RBW})$ to the measured result, whereas RBW (< 500 kHz) is the reduced resolution bandwidth of the spectrum analyzer set during measurement.	

4.5.3. Test Procedures

1. The transmitter output (antenna port) was connected RF switch to the spectrum analyzer.
2. Test was performed in accordance with KDB789033 D02 v01r03 for Compliance Testing of Unlicensed National Information Infrastructure (U-NII) Devices - section (F) Maximum Power Spectral Density (PSD).
3. Multiple antenna systems was performed in accordance KDB662911 D01 v02r01 in-Band Power Spectral Density (PSD) Measurements and sum the spectra across the outputs.
4. For 5.725~5.85 GHz, the measured result of PSD level must add $10\log(500\text{kHz}/\text{RBW})$ and the final result should ≤ 30 dBm.

4.5.4. Test Setup Layout

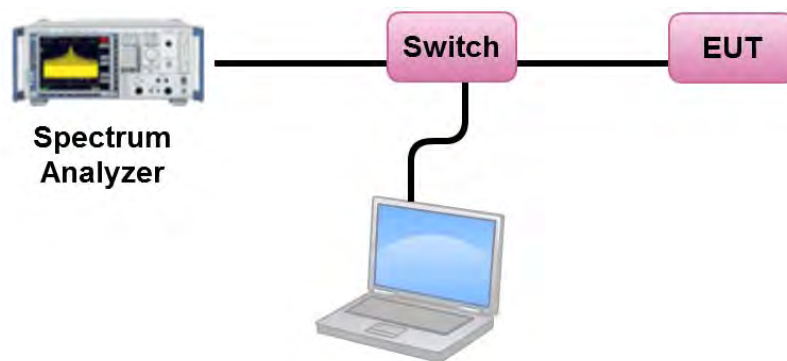

4.5.5. Test Deviation

There is no deviation with the original standard.

4.5.6. EUT Operation during Test

The EUT was programmed to be in continuously transmitting mode.

4.5.7. Test Result of Power Spectral Density

For OMNI antenna:

<For Non-Beamforming Mode> Band 1 / Band 4 Indoor, Outdoor use

Temperature	25°C	Humidity	60%
Test Engineer	Akina Chiu	Test Date	Jun. 15, 2016~Jul. 27, 2016

Configuration IEEE 802.11a / Chain 1 + Chain 2 + Chain 3 + Chain 4

Channel	Frequency	Power Density (dBm/MHz)	Max. Limit (dBm/MHz)	Result
36	5180 MHz	12.56	17.00	Complies
40	5200 MHz	13.31	17.00	Complies
48	5240 MHz	13.96	17.00	Complies

Note: Directional gain = -4.84dBi <6dBi, so the limit doesn't reduce.

Channel	Frequency	Power Density (dBm/MHz)	10log(500kHz/RBW) Factor (dB)	Power Density (dBm/500kHz)	Power Density Limit (dBm/500kHz)	Result
149	5745 MHz	15.14	-3.01	12.13	30.00	Complies
157	5785 MHz	15.04	-3.01	12.03	30.00	Complies
165	5825 MHz	14.50	-3.01	11.49	30.00	Complies

Note: Directional gain = -5.87dBi <6dBi, so the limit doesn't reduce.

Configuration IEEE 802.11ac MCS0/Nss1 VHT20 / Chain 1 + Chain 2 + Chain 3 + Chain 4

Channel	Frequency	Power Density (dBm/MHz)	Max. Limit (dBm/MHz)	Result
36	5180 MHz	12.50	17.00	Complies
40	5200 MHz	13.71	17.00	Complies
48	5240 MHz	13.43	17.00	Complies

Note: Directional gain = -4.84dBi < 6dBi, so the limit doesn't reduce.

Channel	Frequency	Power Density (dBm/MHz)	10log(500kHz/RBW) Factor (dB)	Power Density (dBm/500kHz)	Power Density Limit (dBm/500kHz)	Result
149	5745 MHz	15.59	-3.01	12.58	30.00	Complies
157	5785 MHz	15.12	-3.01	12.11	30.00	Complies
165	5825 MHz	14.67	-3.01	11.66	30.00	Complies

Note: Directional gain = -5.87dBi < 6dBi, so the limit doesn't reduce.

Configuration IEEE 802.11ac MCS0/Nss1 VHT40 / Chain 1 + Chain 2 + Chain 3 + Chain 4

Channel	Frequency	Power Density (dBm/MHz)	Max. Limit (dBm/MHz)	Result
38	5190 MHz	9.40	17.00	Complies
46	5230 MHz	11.02	17.00	Complies

Note: Directional gain = -4.84dBi < 6dBi, so the limit doesn't reduce.

Channel	Frequency	Power Density (dBm/MHz)	10log(500kHz/RBW) Factor (dB)	Power Density (dBm/500kHz)	Power Density Limit (dBm/500kHz)	Result
151	5755 MHz	11.95	-3.01	8.94	30.00	Complies
159	5795 MHz	11.83	-3.01	8.82	30.00	Complies

Note: Directional gain = -5.87dBi < 6dBi, so the limit doesn't reduce.

Configuration IEEE 802.11ac MCS0/Nss1 VHT80 / Chain 1 + Chain 2 + Chain 3 + Chain 4

Channel	Frequency	Power Density (dBm/MHz)	Max. Limit (dBm/MHz)	Result
42	5210 MHz	5.32	17.00	Complies

Note: Directional gain = -4.84dBi < 6dBi, so the limit doesn't reduce.

Channel	Frequency	Power Density (dBm/MHz)	10log(500kHz/RBW) Factor (dB)	Power Density (dBm/500kHz)	Power Density Limit (dBm/500kHz)	Result
155	5775 MHz	8.06	-3.01	5.05	30.00	Complies

Note: Directional gain = -5.87dBi < 6dBi, so the limit doesn't reduce.

Note: All the test values were listed in the report.

For plots, only the channel with worse result was shown.

Power Density Plot on Configuration IEEE 802.11a / Chain 1 + Chain 2 + Chain 3 + Chain 4 / 5240 MHz

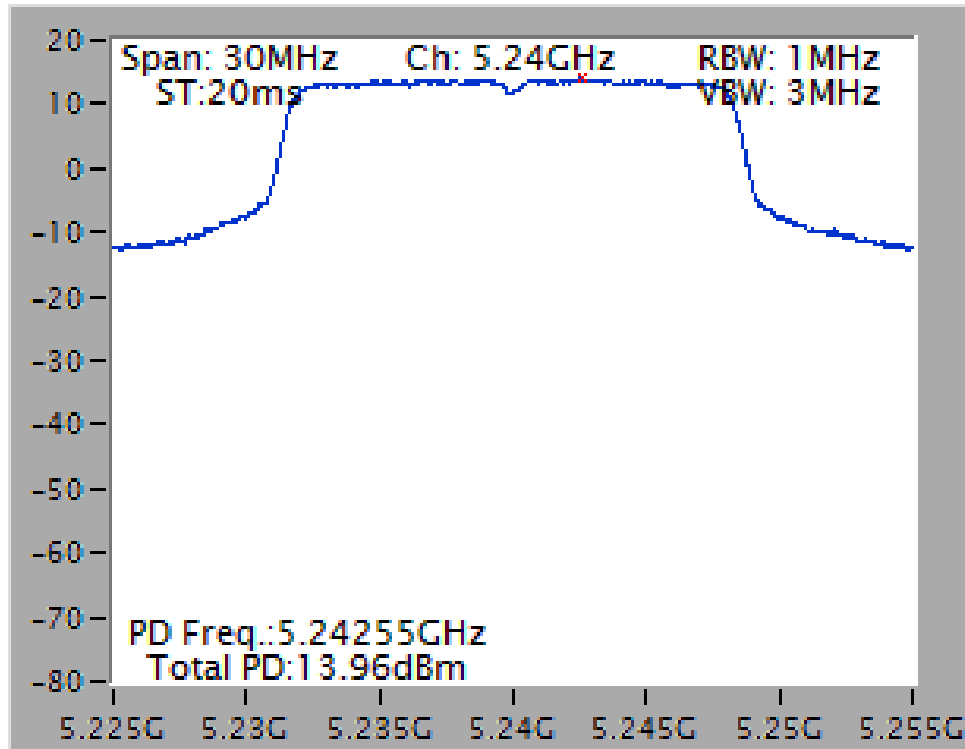

Power Density Plot on Configuration IEEE 802.11a / Chain 1 + Chain 2 + Chain 3 + Chain 4 / 5745 MHz

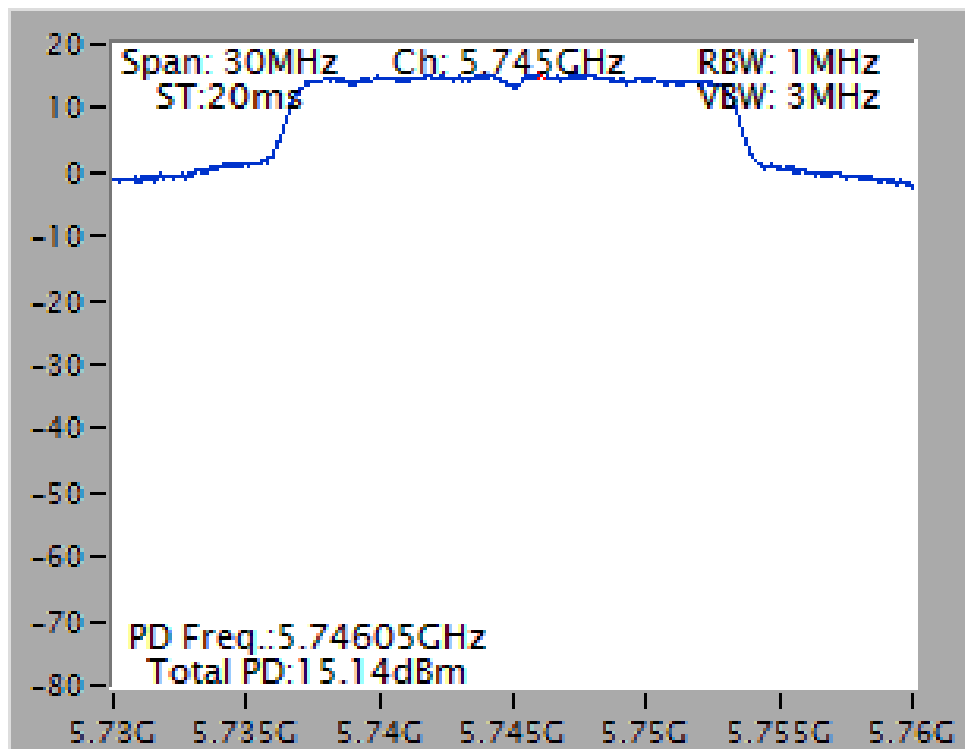

Power Density Plot on Configuration IEEE 802.11ac MCS0/Nss1 VHT20 / Chain 1 + Chain 2 + Chain 3 + Chain 4 / 5200 MHz

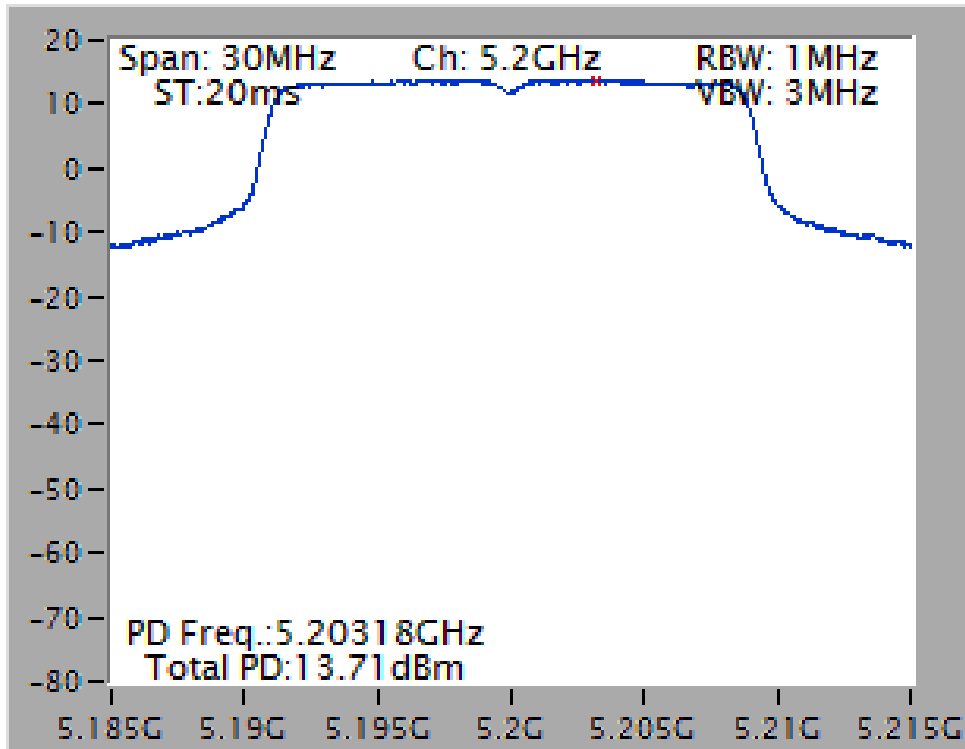

Power Density Plot on Configuration IEEE 802.11ac MCS0/Nss1 VHT20 / Chain 1 + Chain 2 + Chain 3 + Chain 4 / 5745 MHz

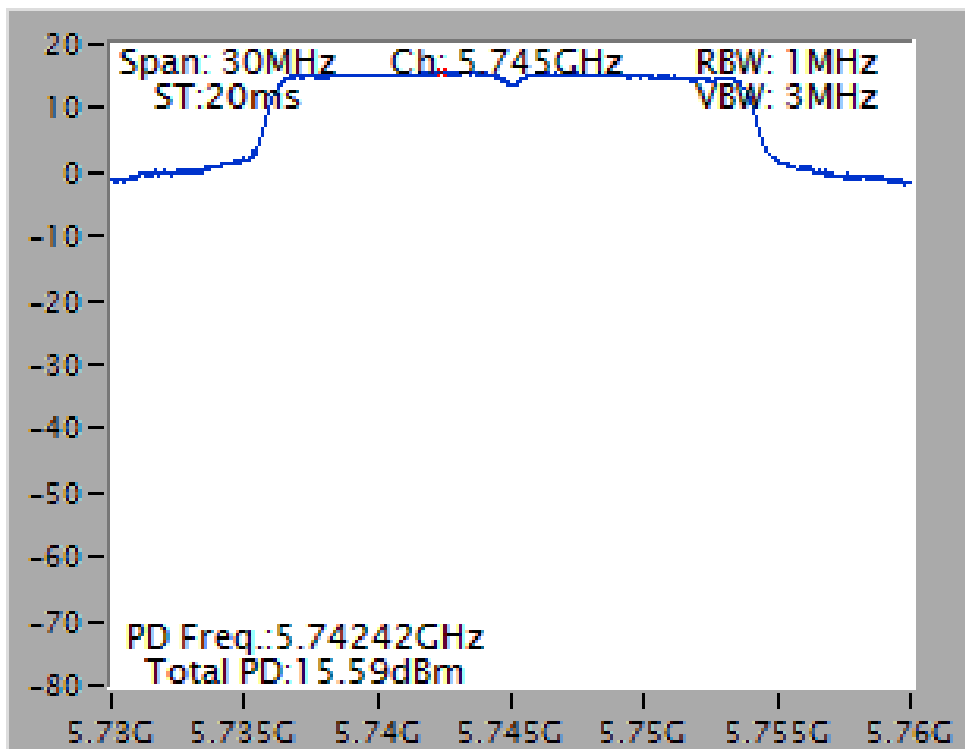

Power Density Plot on Configuration IEEE 802.11ac MCS0/Nss1 VHT40 / Chain 1 + Chain 2 + Chain 3 + Chain 4 / 5230 MHz

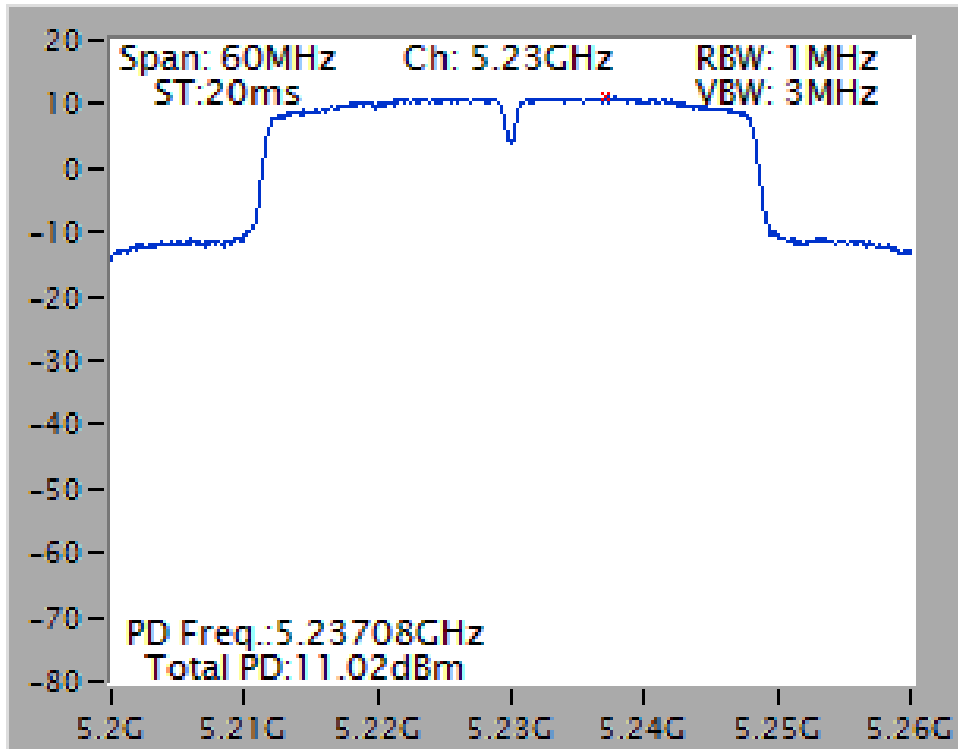

Power Density Plot on Configuration IEEE 802.11ac MCS0/Nss1 VHT40 / Chain 1 + Chain 2 + Chain 3 + Chain 4 / 5755 MHz

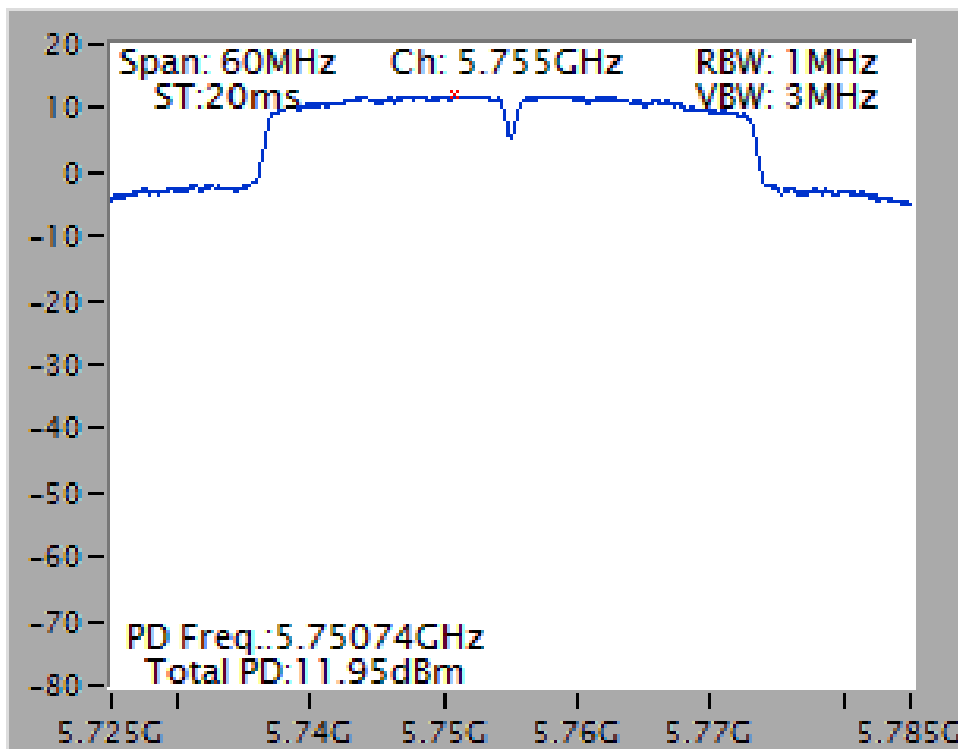

Power Density Plot on Configuration IEEE 802.11ac MCS0/Nss1 VHT80 / Chain 1 + Chain 2 + Chain 3 + Chain 4 / 5210 MHz

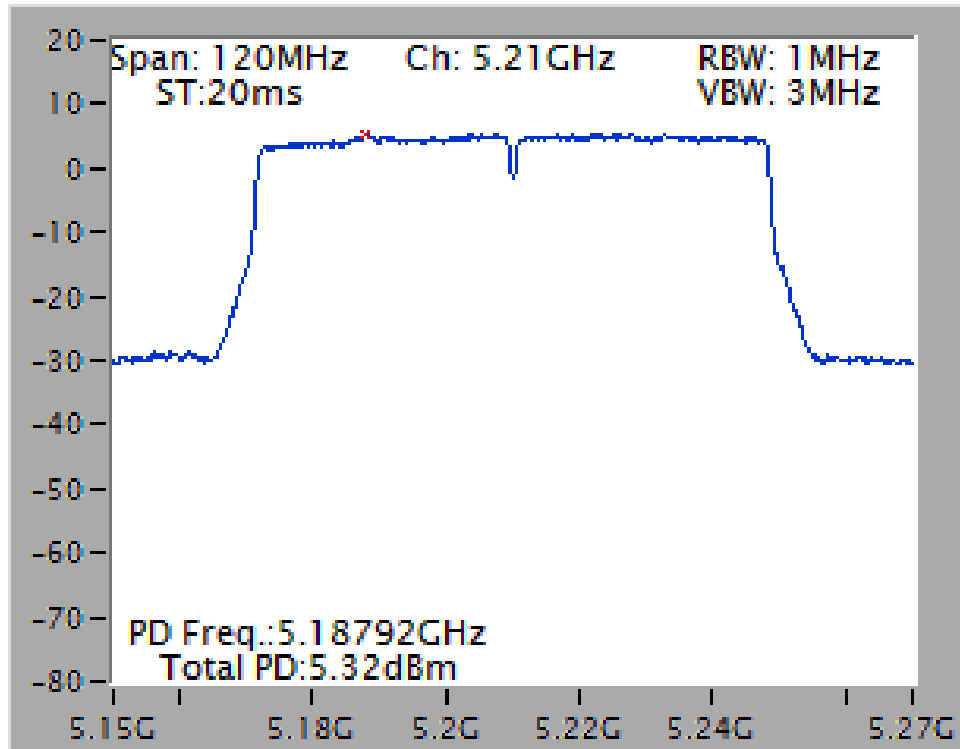

Power Density Plot on Configuration IEEE 802.11ac MCS0/Nss1 VHT80 / Chain 1 + Chain 2 + Chain 3 + Chain 4 / 5775 MHz

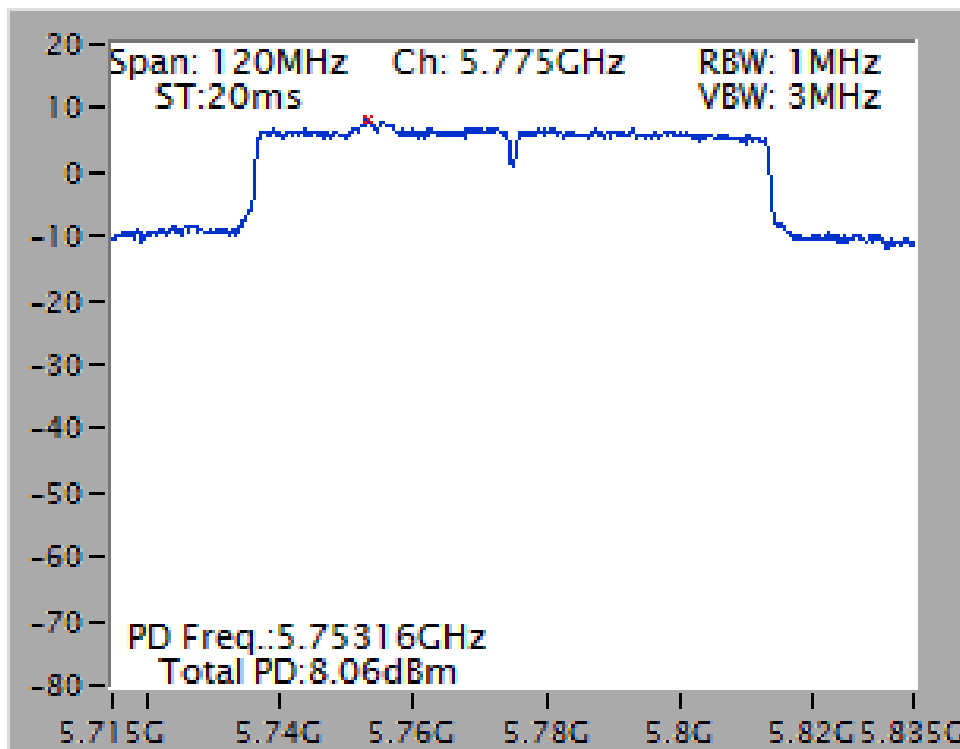

<For Beamforming Mode> Band 1 / Band 4 Indoor, Outdoor use

Temperature	25°C	Humidity	60%
Test Engineer	Akina Chiu	Test Date	Jun. 15, 2016~Jul. 27, 2016

Configuration IEEE 802.11ac MCS0/Nss1 VHT20 / Chain 1 + Chain 2 + Chain 3 + Chain 4

Channel	Frequency	Power Density (dBm/MHz)	Max. Limit (dBm/MHz)	Result
36	5180 MHz	11.53	17.00	Complies
40	5200 MHz	11.68	17.00	Complies
48	5240 MHz	11.63	17.00	Complies

Note: Directional gain = -0.84dBi <6dBi, so the limit doesn't reduce.

Channel	Frequency	Power Density (dBm/MHz)	10log(500kHz/RBW) Factor (dB)	Power Density (dBm/500kHz)	Power Density Limit (dBm/500kHz)	Result
149	5745 MHz	11.92	-3.01	8.91	30.00	Complies
157	5785 MHz	11.84	-3.01	8.83	30.00	Complies
165	5825 MHz	11.00	-3.01	7.99	30.00	Complies

Note: Directional gain = -1.87dBi <6dBi, so the limit doesn't reduce.

Configuration IEEE 802.11ac MCS0/Nss1 VHT40 / Chain 1 + Chain 2 + Chain 3 + Chain 4

Channel	Frequency	Power Density (dBm/MHz)	Max. Limit (dBm/MHz)	Result
38	5190 MHz	8.78	17.00	Complies
46	5230 MHz	8.91	17.00	Complies

Note: Directional gain = -0.84dBi < 6dBi, so the limit doesn't reduce.

Channel	Frequency	Power Density (dBm/MHz)	10log(500kHz/RBW) Factor (dB)	Power Density (dBm/500kHz)	Power Density Limit (dBm/500kHz)	Result
151	5755 MHz	9.21	-3.01	6.20	30.00	Complies
159	5795 MHz	9.09	-3.01	6.08	30.00	Complies

Note: Directional gain = -1.87dBi < 6dBi, so the limit doesn't reduce.

Configuration IEEE 802.11ac MCS0/Nss1 VHT80 / Chain 1 + Chain 2 + Chain 3 + Chain 4

Channel	Frequency	Power Density (dBm/MHz)	Max. Limit (dBm/MHz)	Result
42	5210 MHz	5.53	17.00	Complies

Note: Directional gain = -0.84dBi < 6dBi, so the limit doesn't reduce.

Channel	Frequency	Power Density (dBm/MHz)	10log(500kHz/RBW) Factor (dB)	Power Density (dBm/500kHz)	Power Density Limit (dBm/500kHz)	Result
155	5775 MHz	5.31	-3.01	2.30	30.00	Complies

Note: Directional gain = -1.87dBi < 6dBi, so the limit doesn't reduce.

Note: All the test values were listed in the report.

For plots, only the channel with worse result was shown.

Power Density Plot on Configuration IEEE 802.11ac MCS0/Nss1 VHT20 / Chain 1 + Chain 2 + Chain 3 + Chain 4 / 5200 MHz

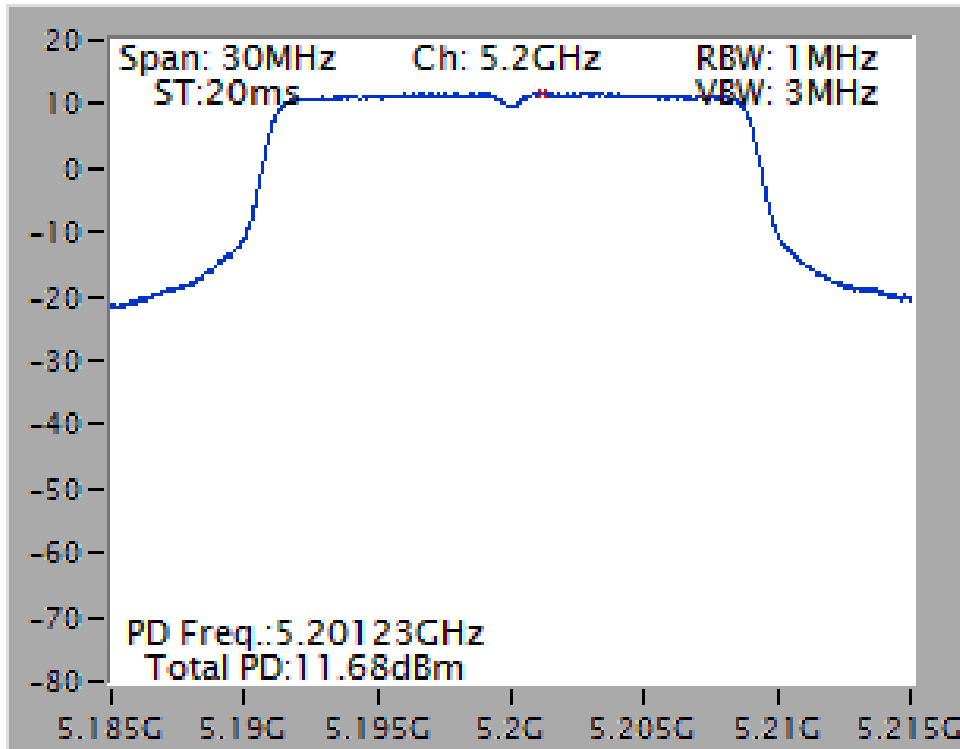

Power Density Plot on Configuration IEEE 802.11ac MCS0/Nss1 VHT20 / Chain 1 + Chain 2 + Chain 3 + Chain 4 / 5745 MHz

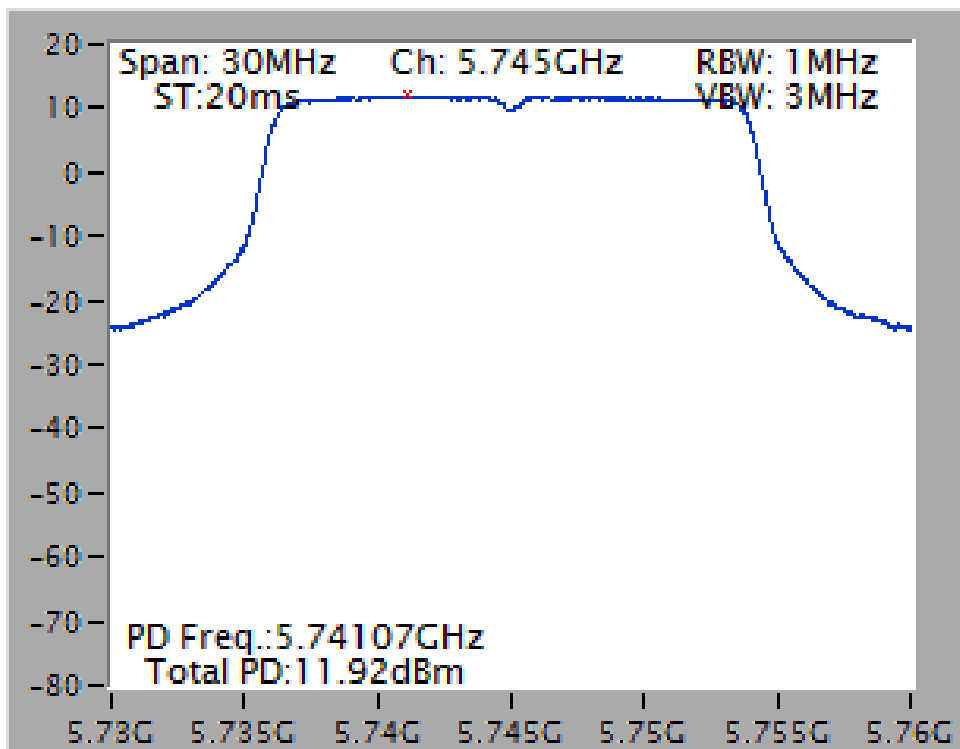

Power Density Plot on Configuration IEEE 802.11ac MCS0/Nss1 VHT40 / Chain 1 + Chain 2 + Chain 3 + Chain 4 / 5230 MHz

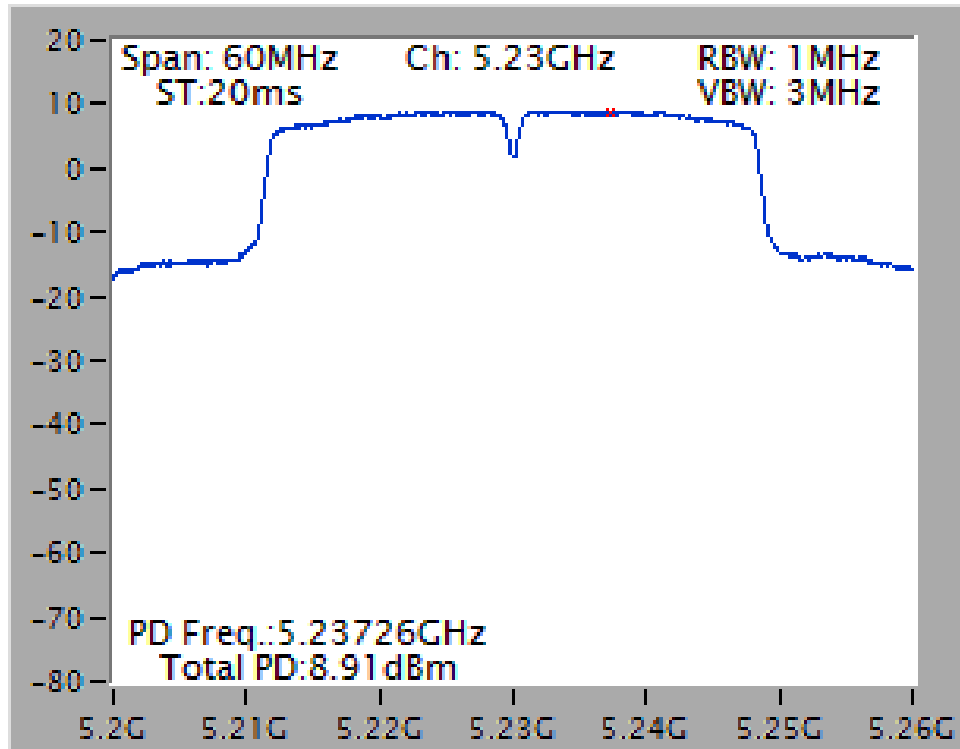

Power Density Plot on Configuration IEEE 802.11ac MCS0/Nss1 VHT40 / Chain 1 + Chain 2 + Chain 3 + Chain 4 / 5755 MHz

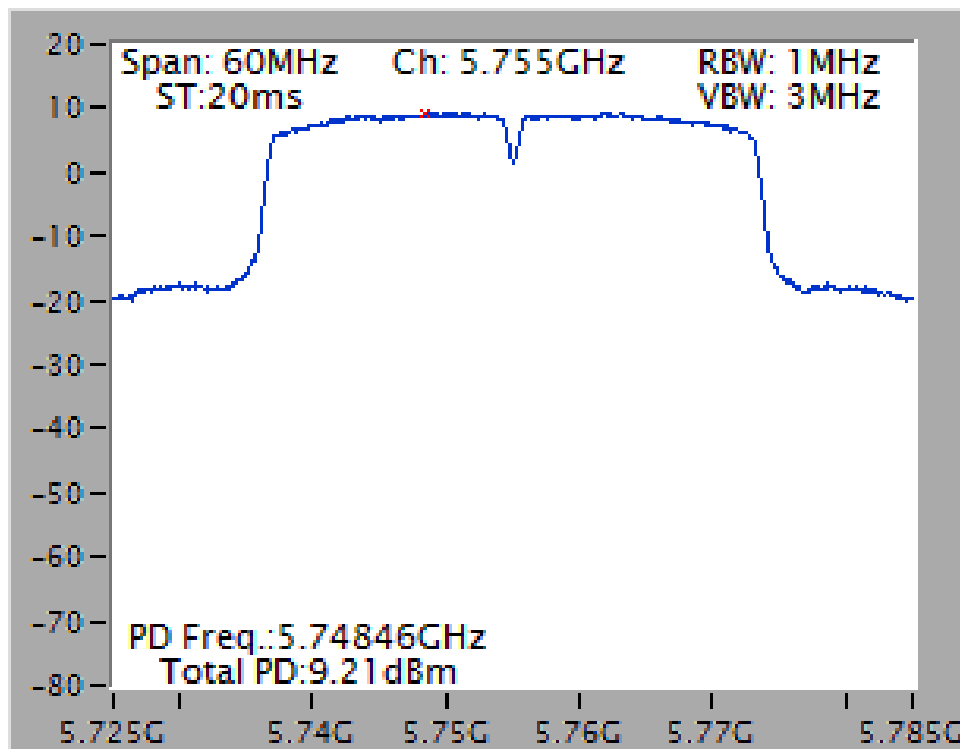

Power Density Plot on Configuration IEEE 802.11ac MCS0/Nss1 VHT80 / Chain 1 + Chain 2 + Chain 3 + Chain 4 / 5210 MHz

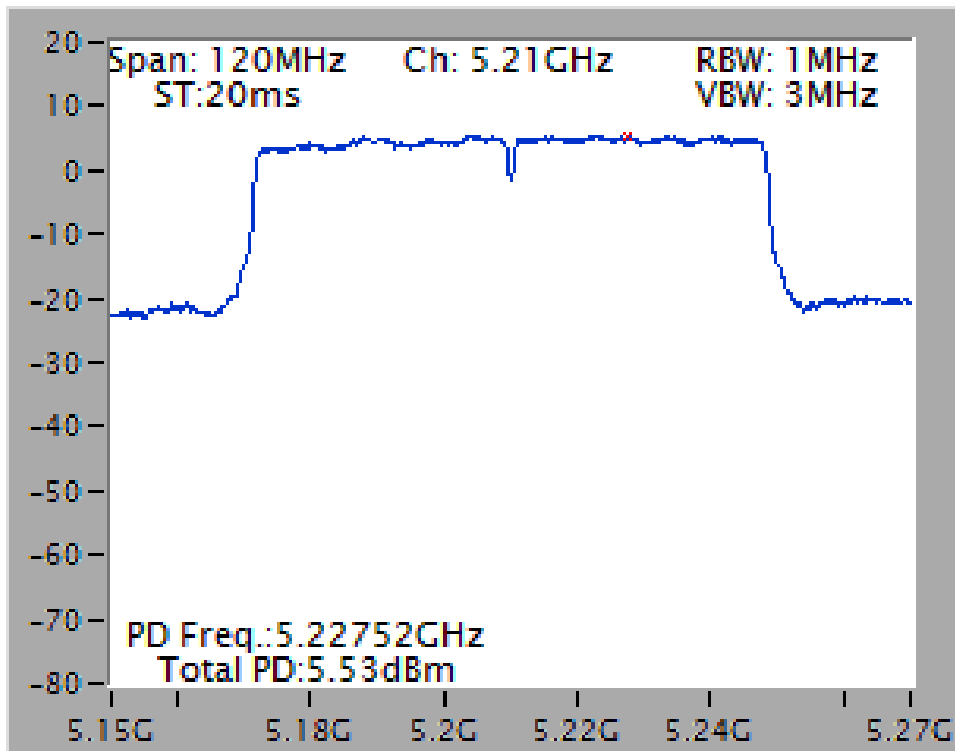

Power Density Plot on Configuration IEEE 802.11ac MCS0/Nss1 VHT80 / Chain 1 + Chain 2 + Chain 3 + Chain 4 / 5775 MHz

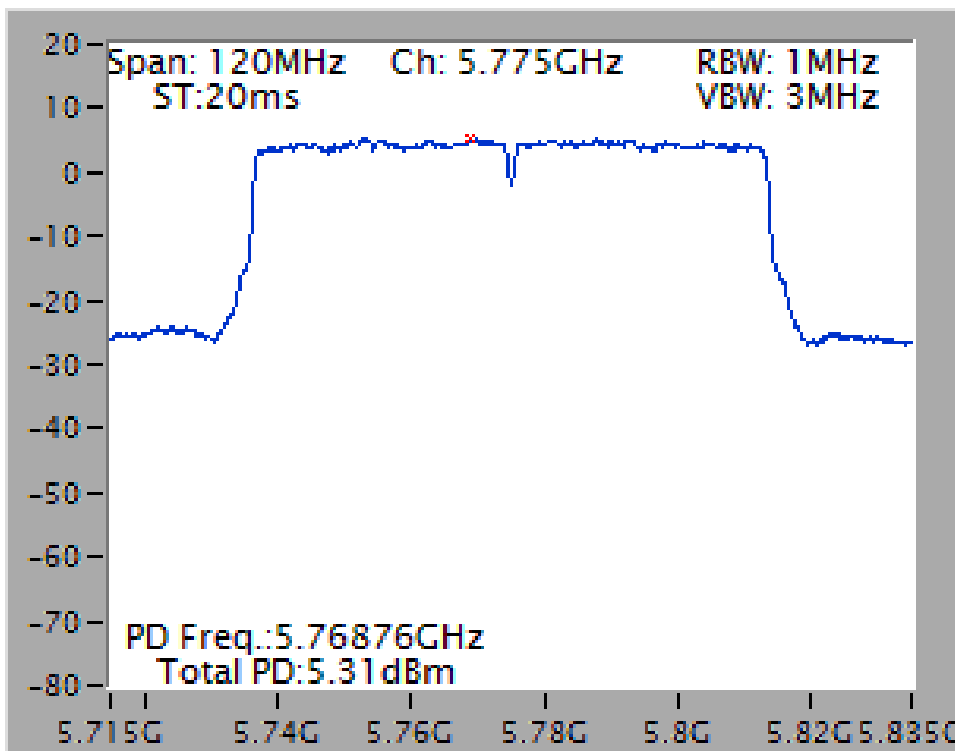

For Directional antenna:

<For Non-Beamforming Mode> Band 1 / Band 4 Indoor, Outdoor use

Temperature	25°C	Humidity	60%
Test Engineer	Akina Chiu	Test Date	Jun. 15, 2016~Jul. 27, 2016

Configuration IEEE 802.11a / Chain 1 + Chain 2 + Chain 3 + Chain 4

Channel	Frequency	Power Density (dBm/MHz)	Max. Limit (dBm/MHz)	Result
36	5180 MHz	9.57	10.00	Complies
40	5200 MHz	9.70	10.00	Complies
48	5240 MHz	9.59	10.00	Complies

Note: Directional gain = 13dBi, so limit = 17-(13-6)=10.00 (dBm/MHz)

Channel	Frequency	Power Density (dBm/MHz)	10log(500kHz/RBW) Factor (dB)	Power Density (dBm/500kHz)	Power Density Limit (dBm/500kHz)	Result
149	5745 MHz	9.56	-3.01	6.55	23.00	Complies
157	5785 MHz	9.49	-3.01	6.48	23.00	Complies
165	5825 MHz	9.35	-3.01	6.34	23.00	Complies

Note: Directional gain = 13dBi, so limit = 30-(13-6)=23.00 (dBm/500kHz)

Configuration IEEE 802.11ac MCS0/Nss1 VHT20 / Chain 1 + Chain 2 + Chain 3 + Chain 4

Channel	Frequency	Power Density (dBm/MHz)	Max. Limit (dBm/MHz)	Result
36	5180 MHz	9.60	10.00	Complies
40	5200 MHz	9.80	10.00	Complies
48	5240 MHz	9.45	10.00	Complies

Note: Directional gain = 13dBi, so limit = 17-(13-6)=10.00 (dBm/MHz)

Channel	Frequency	Power Density (dBm/MHz)	10log(500kHz/RBW) Factor (dB)	Power Density (dBm/500kHz)	Power Density Limit (dBm/500kHz)	Result
149	5745 MHz	9.41	-3.01	6.40	23.00	Complies
157	5785 MHz	9.34	-3.01	6.33	23.00	Complies
165	5825 MHz	9.49	-3.01	6.48	23.00	Complies

Note: Directional gain = 13dBi, so limit = 30-(13-6)=23.00 (dBm/500kHz)

Configuration IEEE 802.11ac MCS0/Nss1 VHT40 / Chain 1 + Chain 2 + Chain 3 + Chain 4

Channel	Frequency	Power Density (dBm/MHz)	Max. Limit (dBm/MHz)	Result
38	5190 MHz	6.51	10.00	Complies
46	5230 MHz	6.90	10.00	Complies

Note: Directional gain = 13dBi, so limit = 17-(13-6)=10.00 (dBm/MHz)

Channel	Frequency	Power Density (dBm/MHz)	10log(500kHz/RBW) Factor (dB)	Power Density (dBm/500kHz)	Power Density Limit (dBm/500kHz)	Result
151	5755 MHz	6.57	-3.01	3.56	23.00	Complies
159	5795 MHz	6.81	-3.01	3.80	23.00	Complies

Note: Directional gain = 13dBi, so limit = 30-(13-6)=23.00 (dBm/500kHz)

Configuration IEEE 802.11ac MCS0/Nss1 VHT80 / Chain 1 + Chain 2 + Chain 3 + Chain 4

Channel	Frequency	Power Density (dBm/MHz)	Max. Limit (dBm/MHz)	Result
42	5210 MHz	2.48	10.00	Complies

Note: Directional gain = 13dBi, so limit = 17-(13-6)=10.00 (dBm/MHz)

Channel	Frequency	Power Density (dBm/MHz)	10log(500kHz/RBW) Factor (dB)	Power Density (dBm/500kHz)	Power Density Limit (dBm/500kHz)	Result
155	5775 MHz	3.80	-3.01	0.79	23.00	Complies

Note: Directional gain = 13dBi, so limit = 30-(13-6)=23.00 (dBm/500kHz)

Note: All the test values were listed in the report.

For plots, only the channel with worse result was shown.

Power Density Plot on Configuration IEEE 802.11a / Chain 1 + Chain 2 + Chain 3 + Chain 4 / 5200 MHz

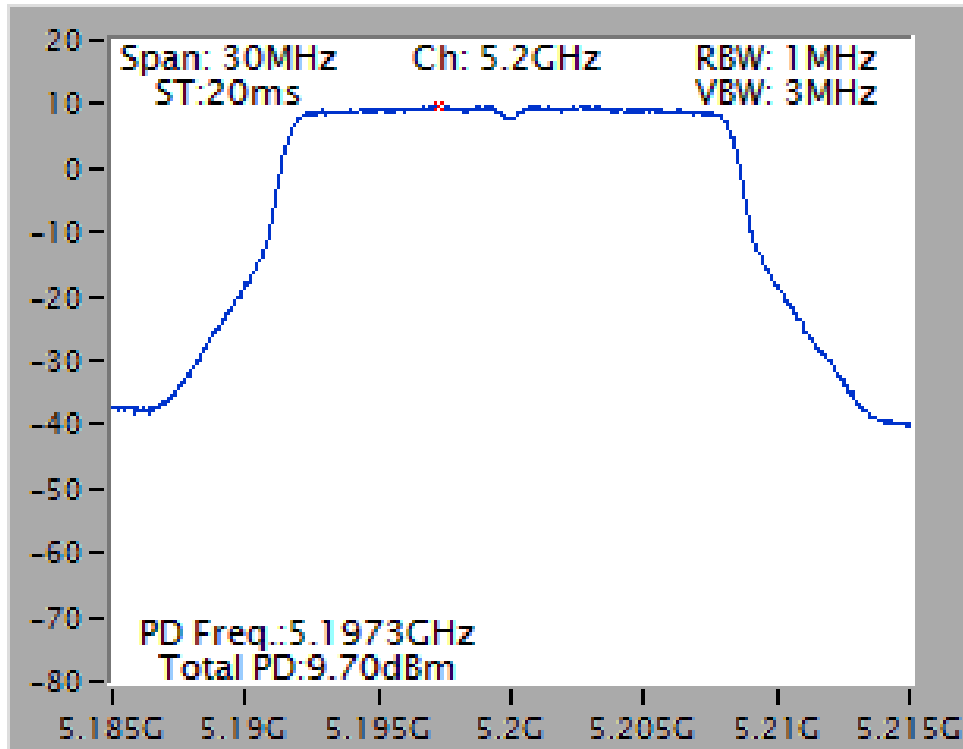

Power Density Plot on Configuration IEEE 802.11a / Chain 1 + Chain 2 + Chain 3 + Chain 4 / 5745 MHz

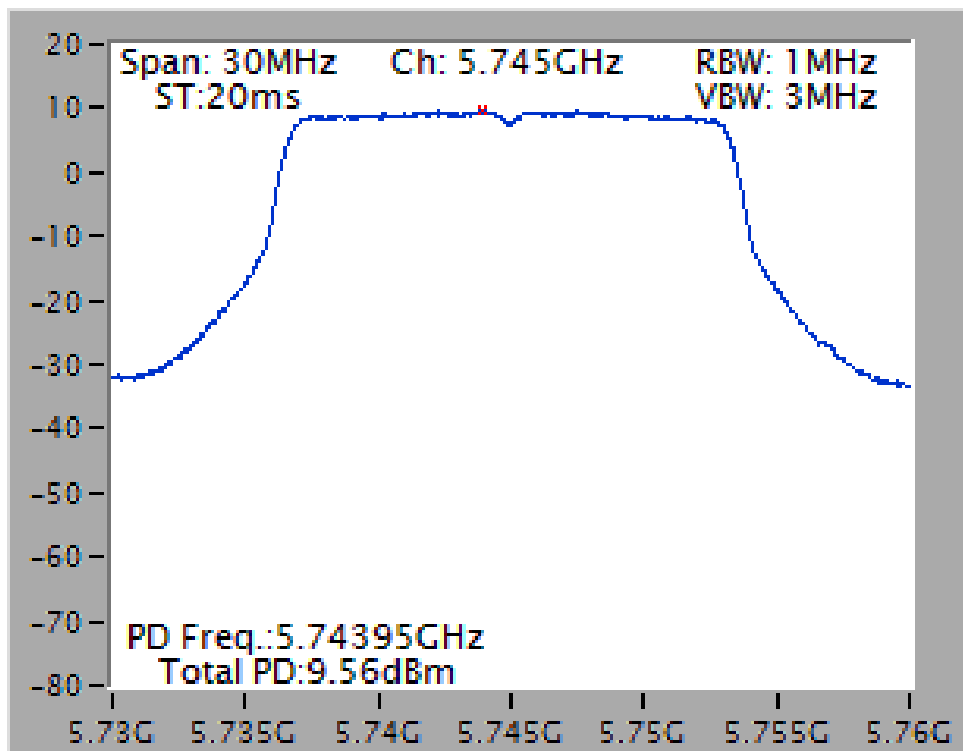

Power Density Plot on Configuration IEEE 802.11ac MCS0/Nss1 VHT20 / Chain 1 + Chain 2 + Chain 3 + Chain 4 / 5200 MHz

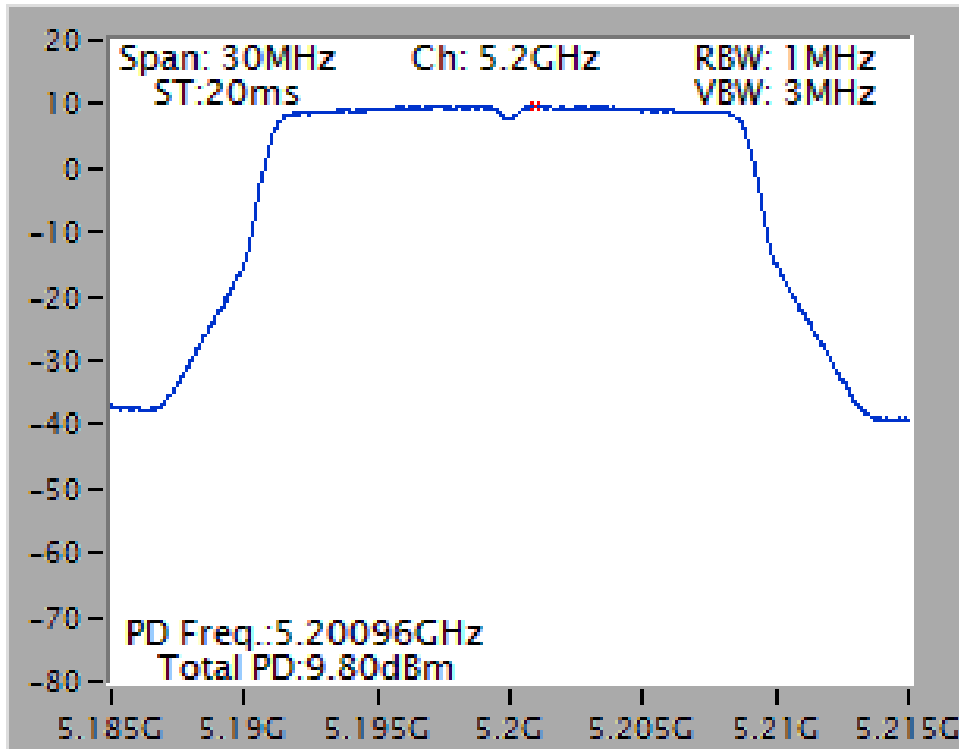

Power Density Plot on Configuration IEEE 802.11ac MCS0/Nss1 VHT20 / Chain 1 + Chain 2 + Chain 3 + Chain 4 / 5825 MHz

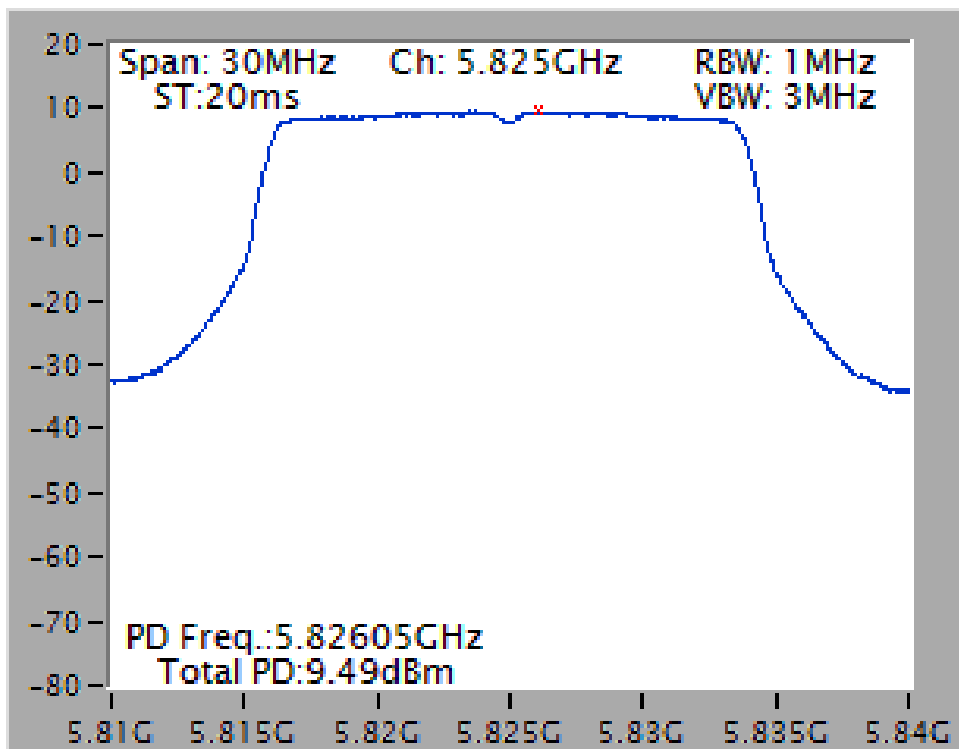

Power Density Plot on Configuration IEEE 802.11ac MCS0/Nss1 VHT40 / Chain 1 + Chain 2 + Chain 3 + Chain 4 / 5230 MHz

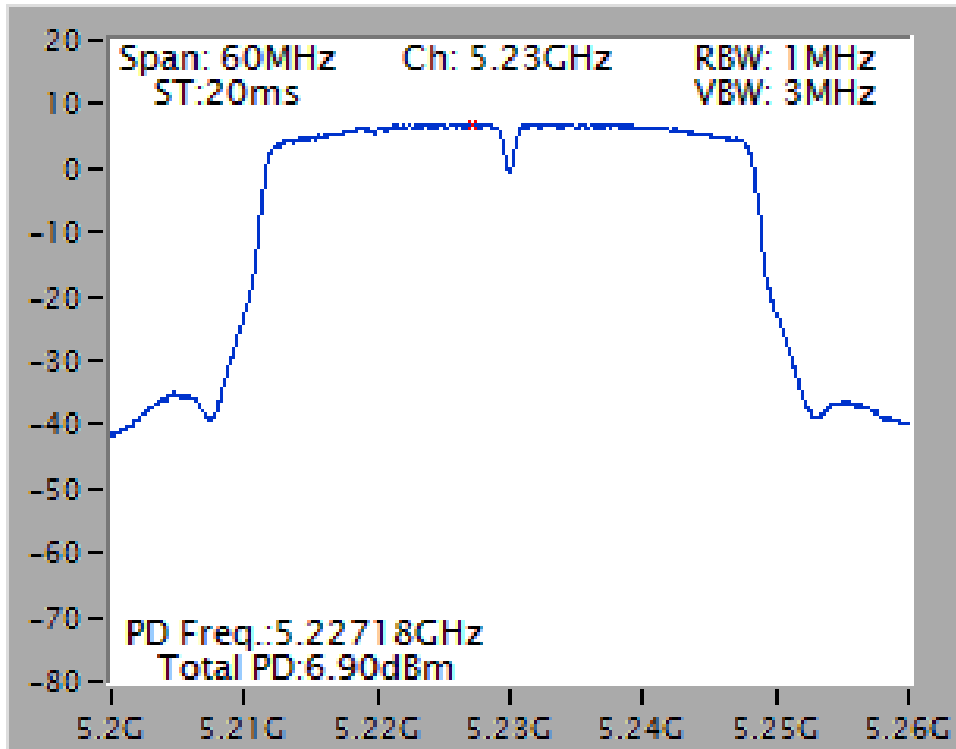

Power Density Plot on Configuration IEEE 802.11ac MCS0/Nss1 VHT40 / Chain 1 + Chain 2 + Chain 3 + Chain 4 / 5755 MHz

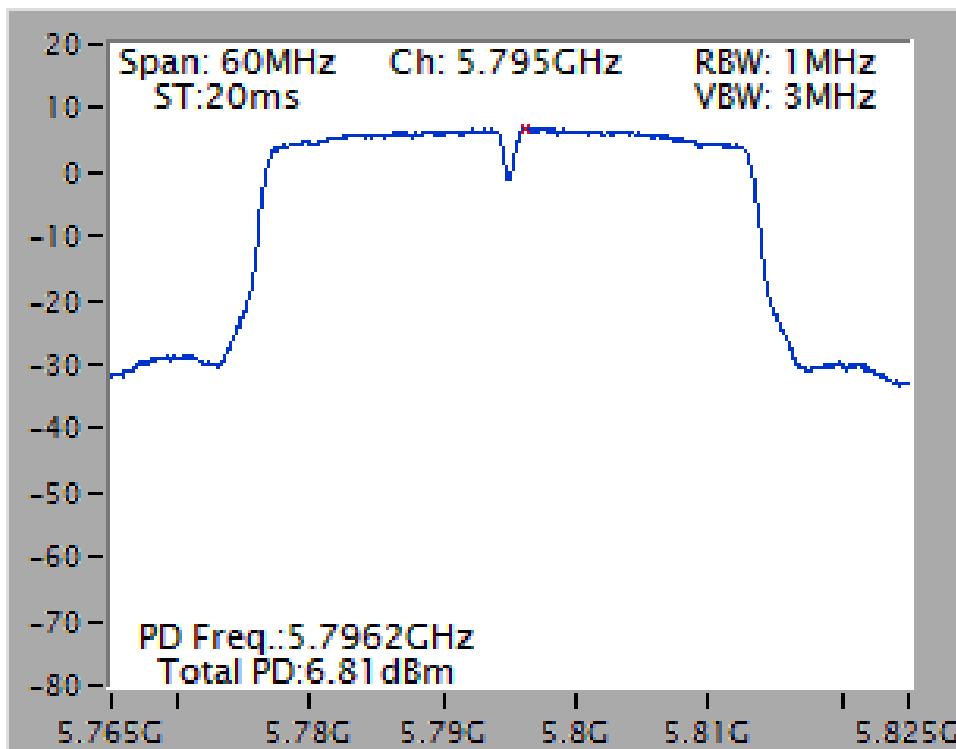

Power Density Plot on Configuration IEEE 802.11ac MCS0/Nss1 VHT80 / Chain 1 + Chain 2 + Chain 3 + Chain 4 / 5210 MHz

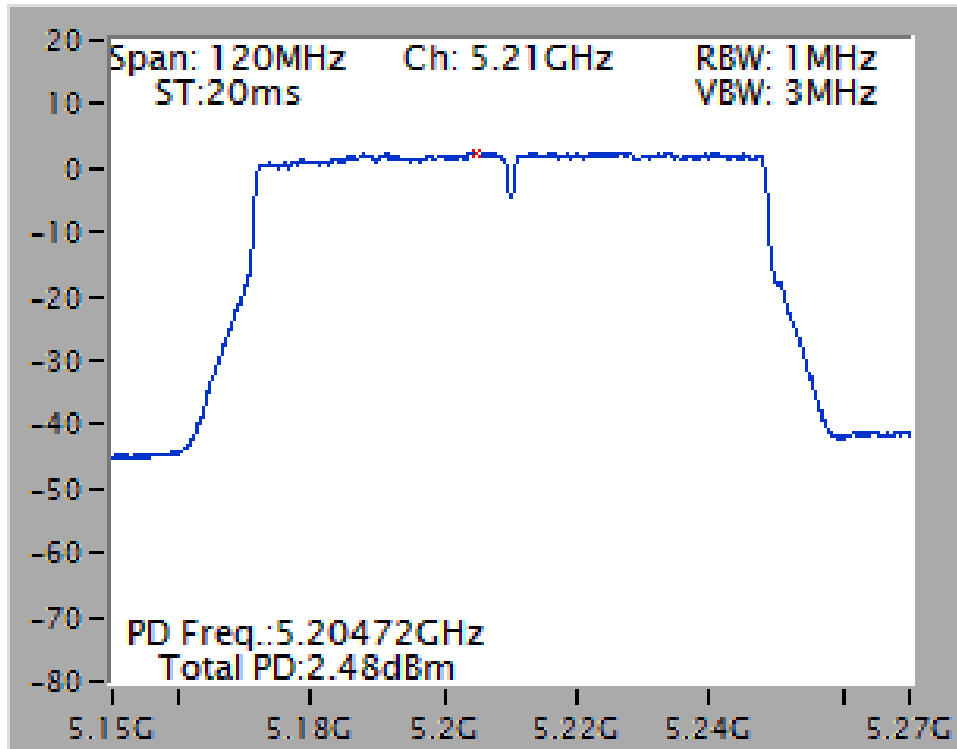

Power Density Plot on Configuration IEEE 802.11ac MCS0/Nss1 VHT80 / Chain 1 + Chain 2 + Chain 3 + Chain 4 / 5775 MHz

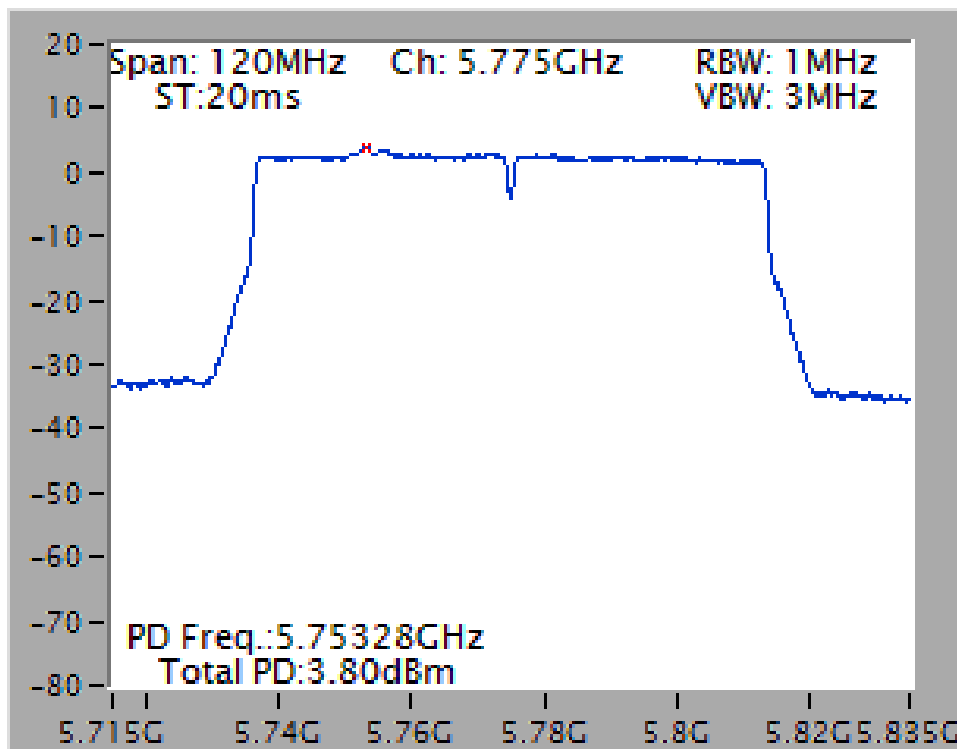

<For Beamforming Mode> Band 1 / Band 4 Indoor, Outdoor use

Temperature	25°C	Humidity	60%
Test Engineer	Akina Chiu	Test Date	Jun. 15, 2016~Jul. 27, 2016

Configuration IEEE 802.11ac MCS0/Nss1 VHT20 / Chain 1 + Chain 2 + Chain 3 + Chain 4

Channel	Frequency	Power Density (dBm/MHz)	Max. Limit (dBm/MHz)	Result
36	5180 MHz	8.54	9.00	Complies
40	5200 MHz	8.53	9.00	Complies
48	5240 MHz	8.52	9.00	Complies

Note: Directional gain = 14dBi, so limit = 17-(14-6)=9.00 (dBm/MHz)

Channel	Frequency	Power Density (dBm/MHz)	10log(500kHz/RBW) Factor (dB)	Power Density (dBm/500kHz)	Power Density Limit (dBm/500kHz)	Result
149	5745 MHz	8.32	-3.01	5.31	22.00	Complies
157	5785 MHz	8.84	-3.01	5.83	22.00	Complies
165	5825 MHz	8.44	-3.01	5.43	22.00	Complies

Note: Directional gain = 14dBi, so limit = 30-(14-6)=22.00 (dBm/500kHz)

Configuration IEEE 802.11ac MCS0/Nss1 VHT40 / Chain 1 + Chain 2 + Chain 3 + Chain 4

Channel	Frequency	Power Density (dBm/MHz)	Max. Limit (dBm/MHz)	Result
38	5190 MHz	5.46	9.00	Complies
46	5230 MHz	5.56	9.00	Complies

Note: Directional gain = 14dBi, so limit = 17-(14-6)=9.00 (dBm/MHz)

Channel	Frequency	Power Density (dBm/MHz)	10log(500kHz/RBW) Factor (dB)	Power Density (dBm/500kHz)	Power Density Limit (dBm/500kHz)	Result
151	5755 MHz	5.80	-3.01	2.79	22.00	Complies
159	5795 MHz	5.34	-3.01	2.33	22.00	Complies

Note: Directional gain = 14dBi, so limit = 30-(14-6)=22.00 (dBm/500kHz)

Configuration IEEE 802.11ac MCS0/Nss1 VHT80 / Chain 1 + Chain 2 + Chain 3 + Chain 4

Channel	Frequency	Power Density (dBm/MHz)	Max. Limit (dBm/MHz)	Result
42	5210 MHz	2.20	9.00	Complies

Note: Directional gain = 14dBi, so limit = 17-(14-6)=9.00 (dBm/MHz)

Channel	Frequency	Power Density (dBm/MHz)	10log(500kHz/RBW) Factor (dB)	Power Density (dBm/500kHz)	Power Density Limit (dBm/500kHz)	Result
155	5775 MHz	2.56	-3.01	-0.45	22.00	Complies

Note: Directional gain = 14dBi, so limit = 30-(14-6)=22.00 (dBm/500kHz)

Note: All the test values were listed in the report.

For plots, only the channel with worse result was shown.

Power Density Plot on Configuration IEEE 802.11ac MCS0/Nss1 VHT20 / Chain 1 + Chain 2 + Chain 3 + Chain 4 / 5180 MHz

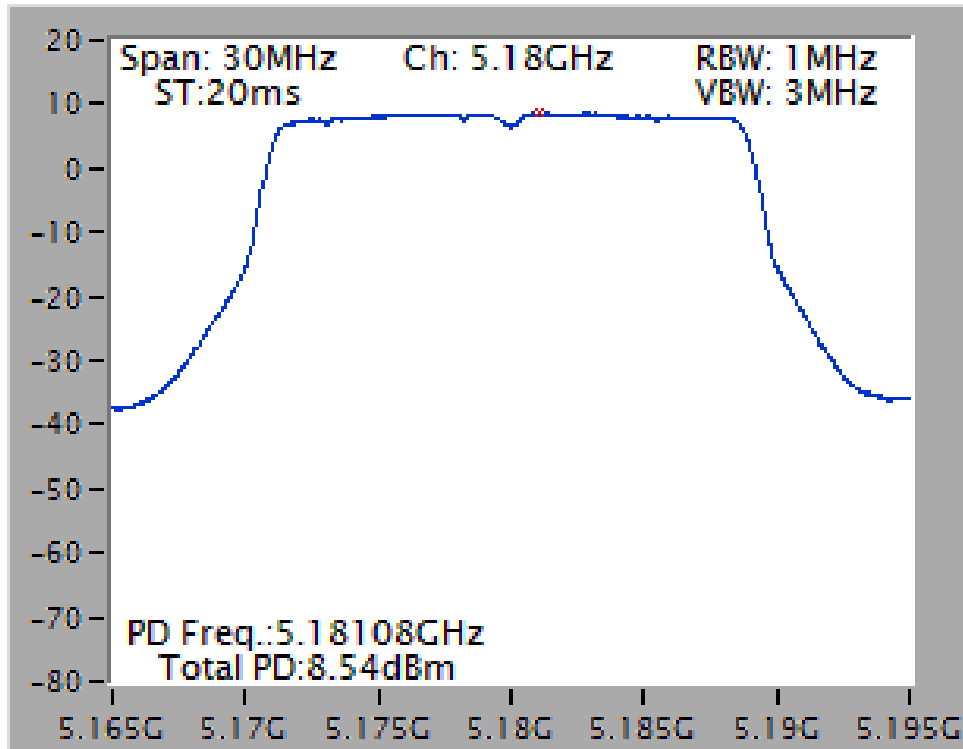

Power Density Plot on Configuration IEEE 802.11ac MCS0/Nss1 VHT20 / Chain 1 + Chain 2 + Chain 3 + Chain 4 / 5785 MHz

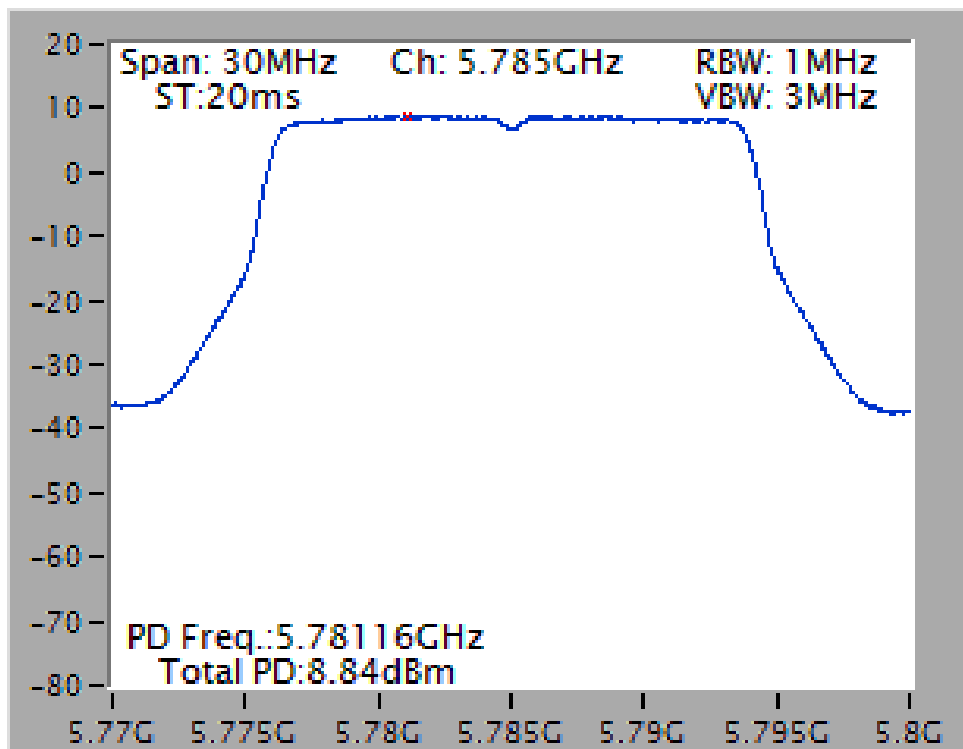

Power Density Plot on Configuration IEEE 802.11ac MCS0/Nss1 VHT40 / Chain 1 + Chain 2 + Chain 3 + Chain 4 / 5230 MHz

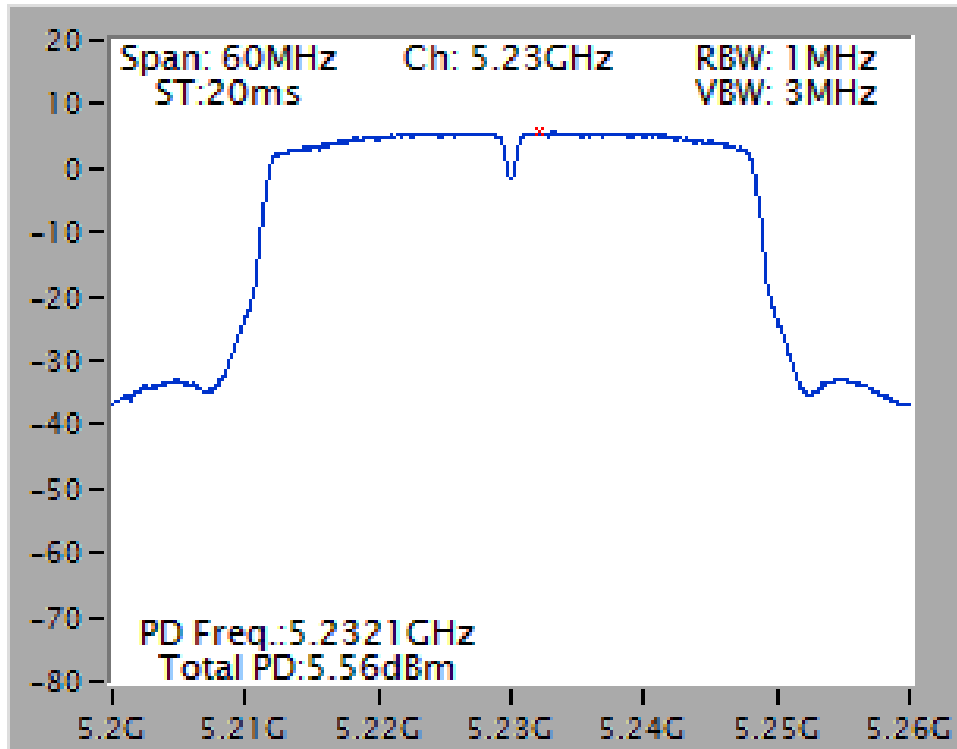

Power Density Plot on Configuration IEEE 802.11ac MCS0/Nss1 VHT40 / Chain 1 + Chain 2 + Chain 3 + Chain 4 / 5755 MHz

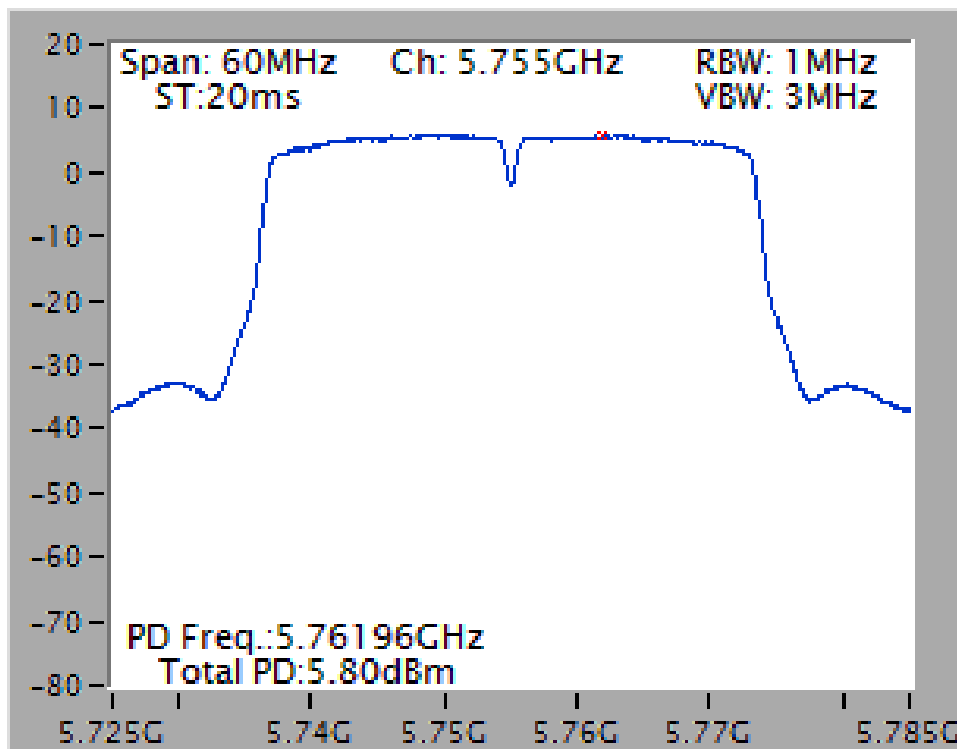

Power Density Plot on Configuration IEEE 802.11ac MCS0/Nss1 VHT80 / Chain 1 + Chain 2 + Chain 3 + Chain 4 / 5210 MHz

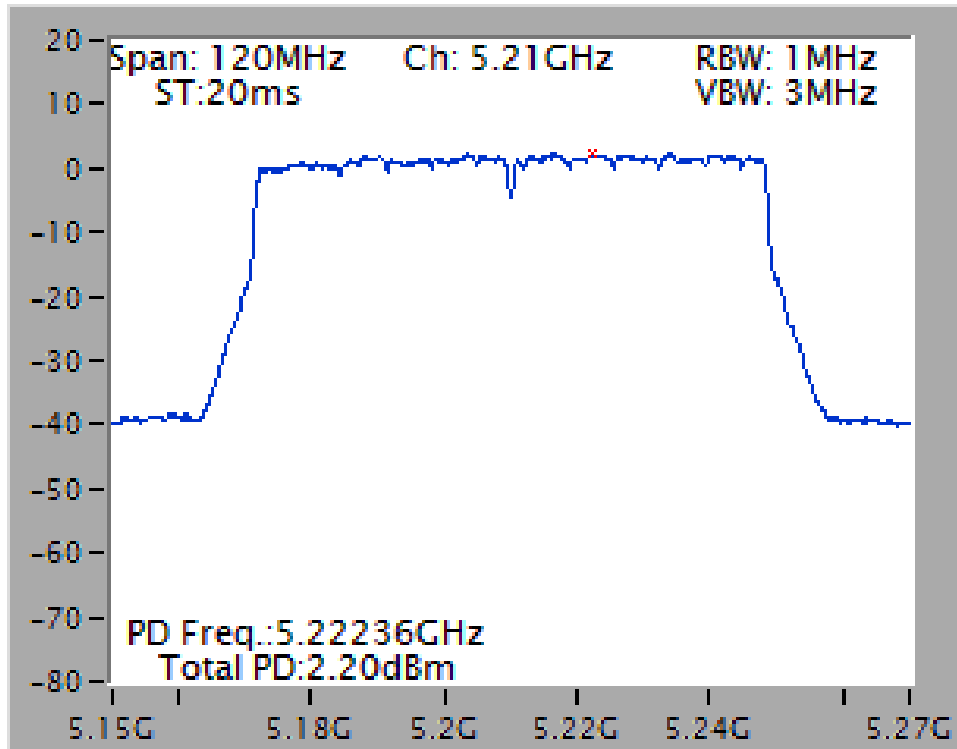

Power Density Plot on Configuration IEEE 802.11ac MCS0/Nss1 VHT80 / Chain 1 + Chain 2 + Chain 3 + Chain 4 / 5775 MHz

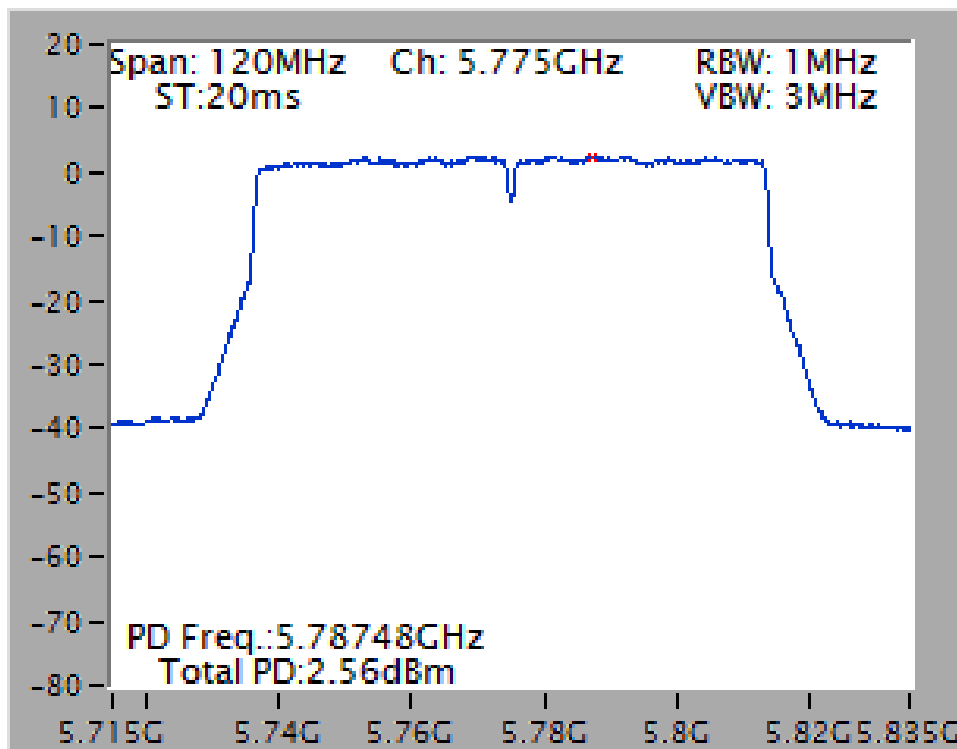

4.6. Radiated Emissions Measurement

4.6.1. Limit

For transmitters operating in the 5.15-5.25 GHz band: all emissions outside of the 5.15-5.35 GHz band shall not exceed an e.i.r.p. of -27 dBm/MHz.

For transmitters operating in the 5.725-5.85 GHz band: all emissions shall be limited to a level of -27 dBm/MHz at 75 MHz or more above or below the band edge increasing linearly to 10 dBm/MHz at 25 MHz above or below the band edge, and from 25 MHz above or below the band edge increasing linearly to a level of 15.6 dBm/MHz at 5 MHz above or below the band edge, and from 5 MHz above or below the band edge increasing linearly to a level of 27 dBm/MHz at the band edge.

In addition, In case the emission fall within the restricted band specified on 15.205(a), then the 15.209(a) limit in the table below has to be followed.

Frequencies (MHz)	Field Strength (micorvolts/meter)	Measurement Distance (meters)
0.009~0.490	2400/F(kHz)	300
0.490~1.705	24000/F(kHz)	30
1.705~30.0	30	30
30~88	100	3
88~216	150	3
216~960	200	3
Above 960	500	3

4.6.2. Measuring Instruments and Setting

Please refer to section 5 of equipments list in this report. The following table is the setting of spectrum analyzer and receiver.

Spectrum Parameter	Setting
Attenuation	Auto
Start Frequency	1000 MHz
Stop Frequency	40 GHz
RBW / VBW (Emission in restricted band)	1MHz / 3MHz for Peak, 1MHz / 1/T for Average
RBW / VBW (Emission in non-restricted band)	1MHz / 3MHz for peak

Receiver Parameter	Setting
Attenuation	Auto
Start ~ Stop Frequency	9kHz~150kHz / RBW 200Hz for QP
Start ~ Stop Frequency	150kHz~30MHz / RBW 9kHz for QP

Start ~ Stop Frequency	30MHz~1000MHz / RBW 120kHz for QP
------------------------	-----------------------------------

4.6.3. Test Procedures

1. Configure the EUT according to ANSI C63.10. The EUT was placed on the top of the turntable 1.5 meter above ground. The phase center of the receiving antenna mounted on the top of a height-variable antenna tower was placed 1m & 3m far away from the turntable.
2. Power on the EUT and all the supporting units. The turntable was rotated by 360 degrees to determine the position of the highest radiation.
3. The height of the broadband receiving antenna was varied between one meter and four meters above ground to find the maximum emissions field strength of both horizontal and vertical polarization.
4. For each suspected emissions, the antenna tower was scan (from 1 M to 4 M) and then the turntable was rotated (from 0 degree to 360 degrees) to find the maximum reading.
5. Set the test-receiver system to Peak or CISPR quasi-peak Detect Function with specified bandwidth under Maximum Hold Mode.
6. For emissions above 1GHz, use 1MHz VBW and 3MHz RBW for peak reading. Then 1MHz RBW and 1/T VBW for average reading in spectrum analyzer.
7. If the emissions level of the EUT in peak mode was 3 dB lower than the average limit specified, then testing will be stopped and peak values of EUT will be reported, otherwise, the emissions which do not have 3 dB margin will be repeated one by one using the quasi-peak method for below 1GHz.
8. For testing above 1GHz, the emissions level of the EUT in peak mode was lower than average limit (that means the emissions level in peak mode also complies with the limit in average mode), then testing will be stopped and peak values of EUT will be reported, otherwise, the emissions will be measured in average mode again and reported.
9. In case the emission is lower than 30MHz, loop antenna has to be used for measurement and the recorded data should be QP measured by receiver. High – Low scan is not required in this case.

4.6.4. Test Setup Layout

For Radiated Emissions: 9kHz ~30MHz

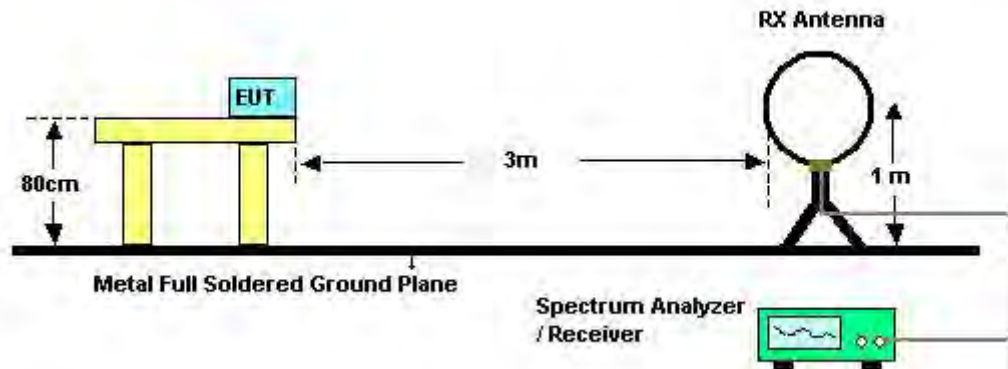

For Radiated Emissions: 30MHz~1GHz

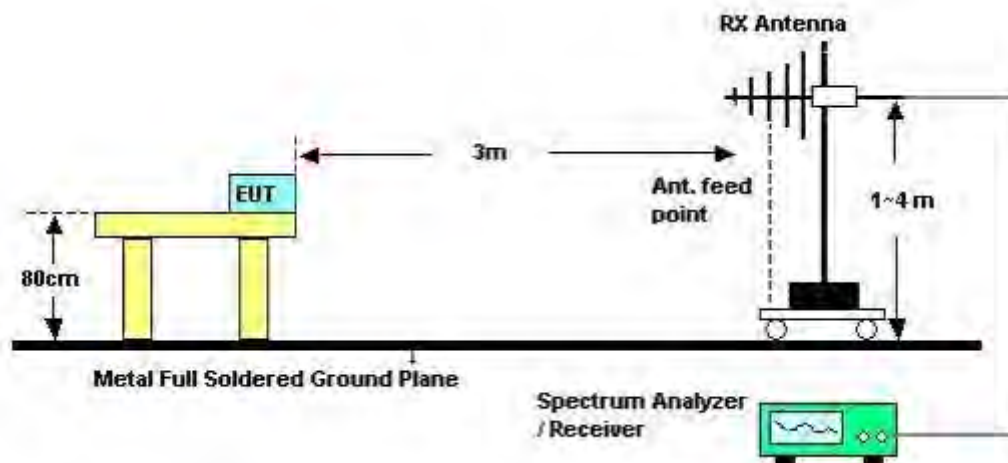

For Radiated Emissions: Above 1GHz

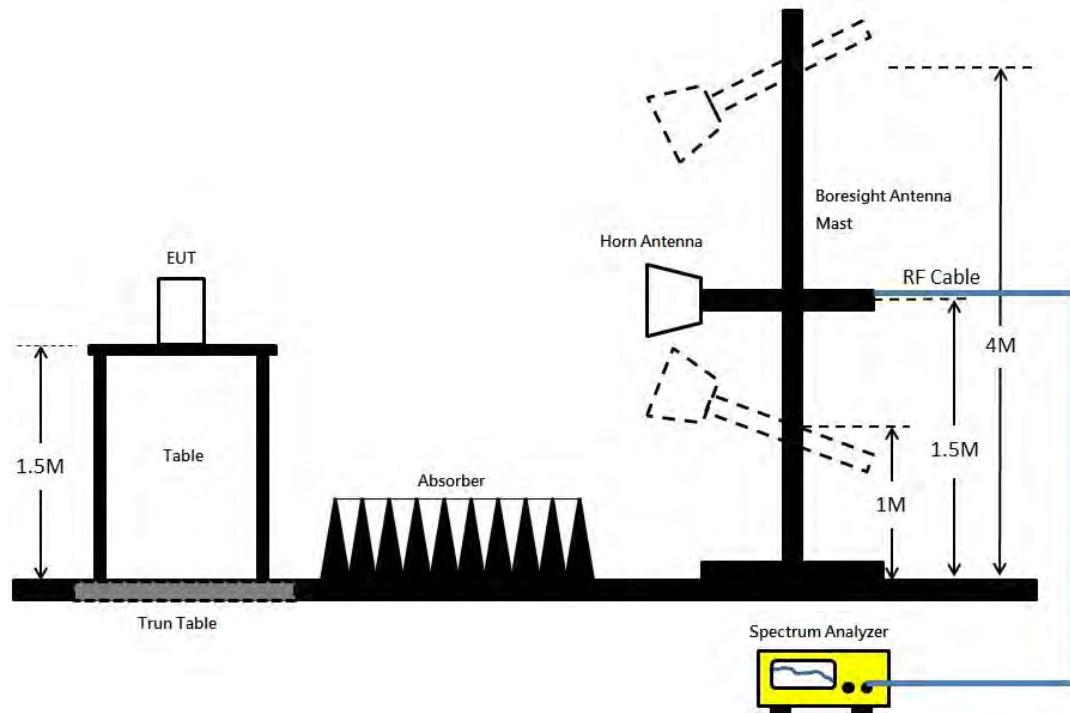

4.6.5. Test Deviation

There is no deviation with the original standard.

4.6.6. EUT Operation during Test

For Non-beamforming mode:

The EUT was programmed to be in continuously transmitting mode.

For beamforming mode:

The EUT was programmed to be in beamforming transmitting mode.

4.6.7. Results of Radiated Emissions (9kHz~30MHz)

Temperature	22°C	Humidity	54%
Test Engineer	Gino Huang	Configurations	Normal Link
Test Date	Jul. 22, 2016	Test Mode	Mode 4

Freq. (MHz)	Level (dBuV)	Over Limit (dB)	Limit Line (dBuV)	Remark
-	-	-	-	See Note

Note:

The amplitude of spurious emissions that are attenuated by more than 20dB below the permissible value has no need to be reported.

Distance extrapolation factor = $40 \log(\text{specific distance} / \text{test distance})$ (dB);

Limit line = specific limits (dBuV) + distance extrapolation factor.

4.6.8. Results of Radiated Emissions (30MHz~1GHz)

Temperature	22°C	Humidity	54%
Test Engineer	Gino Huang	Configurations	Normal Link
Test Mode	Mode 4		

Horizontal

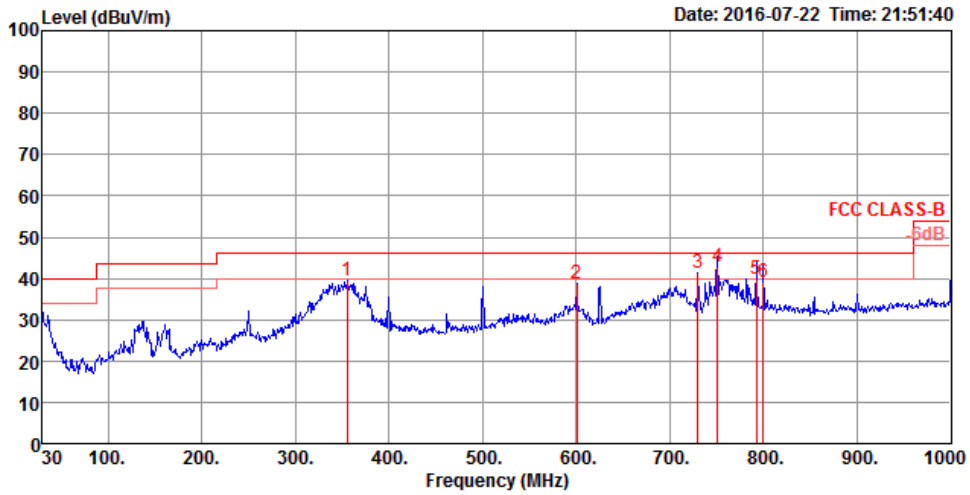

	Freq	Level	Limit Line	Over Limit	Read Level	CableAntenna Loss	Preamp Factor	A/Pos	T/Pos	Remark	Pol/Phase
	MHz	dBuV/m	dBuV/m	dB	dBuV	dB	dB/m	dB	cm	deg	
1	354.95	39.66	46.00	-6.34	48.81	1.62	21.54	32.31	125	93 Peak	HORIZONTAL
2	600.36	38.67	46.00	-7.33	43.56	2.12	25.40	32.41	150	314 Peak	HORIZONTAL
3	730.34	41.16	46.00	-4.84	44.95	2.33	26.20	32.32	100	174 Peak	HORIZONTAL
4	750.71	42.97	46.00	-3.03	46.50	2.37	26.40	32.30	150	352 QP	HORIZONTAL
5	792.42	39.95	46.00	-6.05	42.99	2.45	26.76	32.25	125	7 QP	HORIZONTAL
6	800.18	39.02	46.00	-6.98	42.00	2.46	26.80	32.24	125	1 QP	HORIZONTAL

Vertical

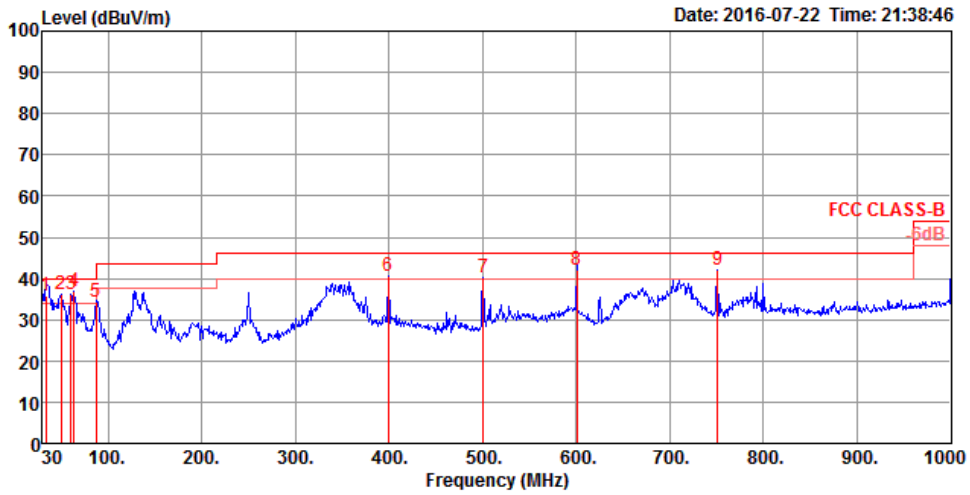

	Freq	Level	Limit Line	Over Limit	Read Level	CableAntenna Loss	Preamp Factor	A/Pos	T/Pos	Remark	Pol/Phase
	MHz	dBuV/m	dBuV/m	dB	dBuV	dB	dB/m	dB	cm	deg	
1	33.88	35.88	40.00	-4.12	44.00	0.51	23.77	32.40	100	359 QP	VERTICAL
2	49.40	36.34	40.00	-3.66	52.95	0.61	15.19	32.41	100	271 Peak	VERTICAL
3	60.07	36.30	40.00	-3.70	54.31	0.69	13.70	32.40	150	71 Peak	VERTICAL
4	63.95	36.92	40.00	-3.08	55.25	0.70	13.37	32.40	200	12 Peak	VERTICAL
5	87.23	34.23	40.00	-5.77	50.83	0.81	14.98	32.39	150	172 Peak	VERTICAL
6	399.57	40.59	46.00	-5.41	48.52	1.73	22.67	32.33	125	155 Peak	VERTICAL
7	500.45	40.34	46.00	-5.66	46.72	1.94	24.03	32.35	150	360 Peak	VERTICAL
8	600.36	42.21	46.00	-3.79	47.10	2.12	25.40	32.41	100	175 QP	VERTICAL
9	750.71	41.94	46.00	-4.06	45.47	2.37	26.40	32.30	100	266 Peak	VERTICAL

Note:

The amplitude of spurious emissions that are attenuated by more than 20dB below the permissible value has no need to be reported.

Emission level (dBuV/m) = 20 log Emission level (uV/m).

Corrected Reading: Antenna Factor + Cable Loss + Read Level - Preamp Factor = Level.

4.6.9. Results for Radiated Emissions (1GHz~40GHz)

For OMNI antenna:

<For Non-Beamforming Mode>

Temperature	22°C	Humidity	54%
Test Engineer	Gino Huang	Configurations	IEEE 802.11a CH 36 / Chain 1 + Chain 2 + Chain 3+ Chain 4
Test Date	May 27, 2016~Jul. 26, 2016		

Horizontal

	Freq	Level	Limit Line	Over Limit	Read Level	CableAntenna Loss	Antenna Factor	Preamp Factor	A/Pos	T/Pos	Remark	Pol/Phase
	MHz	dBuV/m	dBuV/m	dB	dBuV	dB	dB/m	dB	cm	deg		
1	15536.80	53.78	54.00	-0.22	39.03	11.23	38.16	34.64	306	66	Average	HORIZONTAL
2	15544.20	67.12	74.00	-6.88	52.37	11.23	38.16	34.64	306	66	Peak	HORIZONTAL

Vertical

	Freq	Level	Limit Line	Over Limit	Read Level	CableAntenna Loss	Antenna Factor	Preamp Factor	A/Pos	T/Pos	Remark	Pol/Phase
	MHz	dBuV/m	dBuV/m	dB	dBuV	dB	dB/m	dB	cm	deg		
1	15537.20	65.47	74.00	-8.53	50.72	11.23	38.16	34.64	158	220	Peak	VERTICAL
2	15537.20	52.20	54.00	-1.80	37.45	11.23	38.16	34.64	158	220	Average	VERTICAL

Temperature	22°C	Humidity	54%
Test Engineer	Gino Huang	Configurations	IEEE 802.11a CH 40 / Chain 1 + Chain 2 + Chain 3+ Chain 4
Test Date	May 27, 2016~Jul. 26, 2016		

Horizontal

	Freq	Level	Limit Line	Over Limit	Read Level	CableAntenna Loss	Antenna Factor	Preamp Factor	A/Pos	T/Pos	Remark	Pol/Phase
	MHz	dBuV/m	dBuV/m	dB	dBuV	dB	dB/m	dB	cm	deg		
1	15597.00	66.64	74.00	-7.36	51.85	11.24	38.23	34.68	300	75	Peak	HORIZONTAL
2	15597.60	53.78	54.00	-0.22	38.99	11.24	38.23	34.68	300	75	Average	HORIZONTAL

Vertical

	Freq	Level	Limit Line	Over Limit	Read Level	CableAntenna Loss	Antenna Factor	Preamp Factor	A/Pos	T/Pos	Remark	Pol/Phase
	MHz	dBuV/m	dBuV/m	dB	dBuV	dB	dB/m	dB	cm	deg		
1	15597.40	66.12	74.00	-7.88	51.33	11.24	38.23	34.68	232	211	Peak	VERTICAL
2	15597.80	53.46	54.00	-0.54	38.67	11.24	38.23	34.68	232	211	Average	VERTICAL

Temperature	22°C	Humidity	54%
Test Engineer	Gino Huang	Configurations	IEEE 802.11a CH 48 / Chain 1 + Chain 2 + Chain 3+ Chain 4
Test Date	May 27, 2016~Jul. 26, 2016		

Horizontal

	Freq	Level	Limit	Over	Read	CableAntenna	Preamp	A/Pos	T/Pos	Remark	Pol/Phase	
	MHz	dBuV/m	dBuV/m	dB	dBuV	dB	dB/m	dB	cm	deg		
1	15726.20	66.25	74.00	-7.75	51.37	11.27	38.42	34.81	200	75	Peak	HORIZONTAL
2	15727.40	52.59	54.00	-1.41	37.71	11.27	38.42	34.81	200	75	Average	HORIZONTAL

Vertical

	Freq	Level	Limit	Over	Read	CableAntenna	Preamp	A/Pos	T/Pos	Remark	Pol/Phase	
	MHz	dBuV/m	dBuV/m	dB	dBuV	dB	dB/m	dB	cm	deg		
1	15717.44	53.70	54.00	-0.30	38.82	11.27	38.42	34.81	195	214	Average	VERTICAL
2	15718.28	66.82	74.00	-7.18	51.94	11.27	38.42	34.81	195	214	Peak	VERTICAL

Temperature	22°C	Humidity	54%
Test Engineer	Gino Huang	Configurations	IEEE 802.11a CH 149 / Chain 1 + Chain 2 + Chain 3+ Chain 4
Test Date	May 27, 2016~Jul. 26, 2016		

Horizontal

	Freq	Level	Limit	Over	Read	CableAntenna	Preamp	A/Pos	T/Pos	Remark	Pol/Phase	
	MHz	dBuV/m	dBuV/m	dB	dBuV	dB	dB/m	dB	cm	deg		
1	11490.13	57.05	74.00	-16.95	43.55	9.62	38.50	34.62	259	220	Peak	HORIZONTAL
2	11491.91	43.75	54.00	-10.25	30.25	9.62	38.50	34.62	259	220	Average	HORIZONTAL

Vertical

	Freq	Level	Limit	Over	Read	CableAntenna	Preamp	A/Pos	T/Pos	Remark	Pol/Phase	
	MHz	dBuV/m	dBuV/m	dB	dBuV	dB	dB/m	dB	cm	deg		
1	11489.78	42.92	54.00	-11.08	29.42	9.62	38.50	34.62	254	224	Average	VERTICAL
2	11491.48	56.29	74.00	-17.71	42.79	9.62	38.50	34.62	254	224	Peak	VERTICAL

Temperature	22°C	Humidity	54%
Test Engineer	Gino Huang	Configurations	IEEE 802.11a CH 157 / Chain 1 + Chain 2 + Chain 3+ Chain 4
Test Date	May 27, 2016~Jul. 26, 2016		

Horizontal

	Freq	Level	Limit	Over	Read	CableAntenna	Preamp	A/Pos	T/Pos	Remark	Pol/Phase	
	MHz	dBuV/m	dBuV/m	dB	dBuV	dB	dB/m	dB	cm	deg		
1	11569.70	57.14	74.00	-16.86	43.65	9.61	38.53	34.65	222	121	Peak	HORIZONTAL
2	11569.92	44.17	54.00	-9.83	30.68	9.61	38.53	34.65	222	121	Average	HORIZONTAL

Vertical

	Freq	Level	Limit	Over	Read	CableAntenna	Preamp	A/Pos	T/Pos	Remark	Pol/Phase	
	MHz	dBuV/m	dBuV/m	dB	dBuV	dB	dB/m	dB	cm	deg		
1	11570.07	43.50	54.00	-10.50	30.01	9.61	38.53	34.65	220	129	Average	VERTICAL
2	11571.02	56.43	74.00	-17.57	42.94	9.61	38.53	34.65	220	129	Peak	VERTICAL

Temperature	22°C	Humidity	54%
Test Engineer	Gino Huang	Configurations	IEEE 802.11a CH 165 / Chain 1 + Chain 2 + Chain 3+ Chain 4
Test Date	May 27, 2016~Jul. 26, 2016		

Horizontal

	Freq	Level	Limit Line	Over Limit	Read Level	CableAntenna Loss	Antenna Factor	Preamp Factor	A/Pos	T/Pos	Remark	Pol/Phase
	MHz	dBuV/m	dBuV/m	dB	dBuV	dB	dB/m	dB	cm	deg		
1	11651.41	43.85	54.00	-10.15	30.36	9.60	38.57	34.68	227	114	Average	HORIZONTAL
2	11651.85	54.94	74.00	-19.06	41.45	9.60	38.57	34.68	227	114	Peak	HORIZONTAL

Vertical

	Freq	Level	Limit Line	Over Limit	Read Level	CableAntenna Loss	Antenna Factor	Preamp Factor	A/Pos	T/Pos	Remark	Pol/Phase
	MHz	dBuV/m	dBuV/m	dB	dBuV	dB	dB/m	dB	cm	deg		
1	11647.90	55.02	74.00	-18.98	41.55	9.60	38.55	34.68	225	119	Peak	VERTICAL
2	11652.34	44.80	54.00	-9.20	31.31	9.60	38.57	34.68	225	119	Average	VERTICAL

Temperature	22°C	Humidity	54%
Test Engineer	Gino Huang	Configurations	IEEE 802.11ac MCS0/Nss1 VHT20 CH 36 / Chain 1 + Chain 2 + Chain 3+ Chain 4
Test Date	May 27, 2016~Jul. 26, 2016		

Horizontal

	Freq	Level	Limit	Over	Read	CableAntenna	Preamp	A/Pos	T/Pos	Remark	Pol/Phase	
	MHz	dBuV/m	dBuV/m	dB	dBuV	dB	dB/m	dB	cm	deg		
1	15540.56	53.72	54.00	-0.28	38.97	11.23	38.16	34.64	200	126	Average	HORIZONTAL
2	15546.68	68.48	74.00	-5.52	53.73	11.23	38.16	34.64	200	126	Peak	HORIZONTAL

Vertical

	Freq	Level	Limit	Over	Read	CableAntenna	Preamp	A/Pos	T/Pos	Remark	Pol/Phase	
	MHz	dBuV/m	dBuV/m	dB	dBuV	dB	dB/m	dB	cm	deg		
1	15536.08	52.53	54.00	-1.47	37.78	11.23	38.16	34.64	202	208	Average	VERTICAL
2	15546.48	67.29	74.00	-6.71	52.54	11.23	38.16	34.64	202	208	Peak	VERTICAL

Temperature	22°C	Humidity	54%
Test Engineer	Gino Huang	Configurations	IEEE 802.11ac MCS0/Nss1 VHT20 CH 40 / Chain 1 + Chain 2 + Chain 3+ Chain 4
Test Date	May 27, 2016~Jul. 26, 2016		

Horizontal

	Freq	Level	Limit Line	Over Limit	Read Level	CableAntenna Loss	Antenna Factor	Preamp Factor	A/Pos	T/Pos	Remark	Pol/Phase
	MHz	dBuV/m	dBuV/m	dB	dBuV	dB	dB/m	dB	cm	deg		
1	15597.90	67.70	74.00	-6.30	52.91	11.24	38.23	34.68	202	126	Peak	HORIZONTAL
2	15600.60	53.66	54.00	-0.34	38.80	11.25	38.29	34.68	202	126	Average	HORIZONTAL

Vertical

	Freq	Level	Limit Line	Over Limit	Read Level	CableAntenna Loss	Antenna Factor	Preamp Factor	A/Pos	T/Pos	Remark	Pol/Phase
	MHz	dBuV/m	dBuV/m	dB	dBuV	dB	dB/m	dB	cm	deg		
1	15597.70	67.25	74.00	-6.75	52.46	11.24	38.23	34.68	201	210	Peak	VERTICAL
2	15598.80	53.42	54.00	-0.58	38.63	11.24	38.23	34.68	201	210	Average	VERTICAL

Temperature	22°C	Humidity	54%
Test Engineer	Gino Huang	Configurations	IEEE 802.11ac MCS0/Nss1 VHT20 CH 48 / Chain 1 + Chain 2 + Chain 3+ Chain 4
Test Date	May 27, 2016~Jul. 26, 2016		

Horizontal

	Freq	Level	Limit	Over	Read	CableAntenna	Preamp	A/Pos	T/Pos	Remark	Pol/Phase	
	MHz	dBuV/m	dBuV/m	dB	dBuV	dB	dB/m	dB	cm	deg		
1	15726.40	68.15	74.00	-5.85	53.27	11.27	38.42	34.81	199	74	Peak	HORIZONTAL
2	15727.20	53.25	54.00	-0.75	38.37	11.27	38.42	34.81	199	74	Average	HORIZONTAL

Vertical

	Freq	Level	Limit	Over	Read	CableAntenna	Preamp	A/Pos	T/Pos	Remark	Pol/Phase	
	MHz	dBuV/m	dBuV/m	dB	dBuV	dB	dB/m	dB	cm	deg		
1	15716.00	67.48	74.00	-6.52	52.60	11.27	38.42	34.81	201	206	Peak	VERTICAL
2	15717.80	53.14	54.00	-0.86	38.26	11.27	38.42	34.81	201	206	Average	VERTICAL

Temperature	22°C	Humidity	54%
Test Engineer	Gino Huang	Configurations	IEEE 802.11ac MCS0/Nss1 VHT20 CH 149 / Chain 1 + Chain 2 + Chain 3+ Chain 4
Test Date	May 27, 2016~Jul. 26, 2016		

Horizontal

	Freq	Level	Limit	Over	Read	CableAntenna	Preamp	A/Pos	T/Pos	Remark	Pol/Phase	
	MHz	dBuV/m	dBuV/m	dB	dBuV	dB	dB/m	dB	cm	deg		
1	11487.68	55.20	74.00	-18.80	41.70	9.62	38.50	34.62	218	139	Peak	HORIZONTAL
2	11489.68	42.16	54.00	-11.84	28.66	9.62	38.50	34.62	218	139	Average	HORIZONTAL

Vertical

	Freq	Level	Limit	Over	Read	CableAntenna	Preamp	A/Pos	T/Pos	Remark	Pol/Phase	
	MHz	dBuV/m	dBuV/m	dB	dBuV	dB	dB/m	dB	cm	deg		
1	11488.83	56.10	74.00	-17.90	42.60	9.62	38.50	34.62	216	141	Peak	VERTICAL
2	11491.60	41.91	54.00	-12.09	28.41	9.62	38.50	34.62	216	141	Average	VERTICAL

Temperature	22°C	Humidity	54%
Test Engineer	Gino Huang	Configurations	IEEE 802.11ac MCS0/Nss1 VHT20 CH 157 / Chain 1 + Chain 2 + Chain 3+ Chain 4
Test Date	May 27, 2016~Jul. 26, 2016		

Horizontal

	Freq	Level	Limit	Over	Read	CableAntenna	Preamp	A/Pos	T/Pos	Remark	Pol/Phase	
	MHz	dBuV/m	dBuV/m	dB	dBuV	Loss	Factor	Factor	cm	deg		
1	11571.85	43.90	54.00	-10.10	30.41	9.61	38.53	34.65	201	147	Average	HORIZONTAL
2	11572.03	57.37	74.00	-16.63	43.88	9.61	38.53	34.65	201	147	Peak	HORIZONTAL

Vertical

	Freq	Level	Limit	Over	Read	CableAntenna	Preamp	A/Pos	T/Pos	Remark	Pol/Phase	
	MHz	dBuV/m	dBuV/m	dB	dBuV	Loss	Factor	Factor	cm	deg		
1	11571.63	56.29	74.00	-17.71	42.80	9.61	38.53	34.65	204	151	Peak	VERTICAL
2	11572.40	42.41	54.00	-11.59	28.92	9.61	38.53	34.65	204	151	Average	VERTICAL

Temperature	22°C	Humidity	54%
Test Engineer	Gino Huang	Configurations	IEEE 802.11ac MCS0/Nss1 VHT20 CH 165 / Chain 1 + Chain 2 + Chain 3+ Chain 4
Test Date	May 27, 2016~Jul. 26, 2016		

Horizontal

	Freq	Level	Limit Line	Over Limit	Read Level	CableAntenna Loss	Antenna Factor	Preamp Factor	A/Pos	T/Pos	Remark	Pol/Phase
	MHz	dBuV/m	dBuV/m	dB	dBuV	dB	dB/m	dB	cm	deg		
1	11608.80	55.13	74.00	-18.87	41.65	9.60	38.54	34.66	209	154	Peak	HORIZONTAL
2	11609.32	41.79	54.00	-12.21	28.31	9.60	38.54	34.66	209	154	Average	HORIZONTAL

Vertical

	Freq	Level	Limit Line	Over Limit	Read Level	CableAntenna Loss	Antenna Factor	Preamp Factor	A/Pos	T/Pos	Remark	Pol/Phase
	MHz	dBuV/m	dBuV/m	dB	dBuV	dB	dB/m	dB	cm	deg		
1	11611.06	41.60	54.00	-12.40	28.12	9.60	38.54	34.66	207	159	Average	VERTICAL
2	11612.44	54.99	74.00	-19.01	41.51	9.60	38.54	34.66	207	159	Peak	VERTICAL

Temperature	22°C	Humidity	54%
Test Engineer	Gino Huang	Configurations	IEEE 802.11ac MCS0/Nss1 VHT40 CH 38 / Chain 1 + Chain 2 + Chain 3+ Chain 4
Test Date	May 27, 2016~Jul. 26, 2016		

Horizontal

	Freq	Level	Limit Line	Over Limit	Read Level	CableAntenna Loss	Antenna Factor	Preamp Factor	A/Pos	T/Pos	Remark	Pol/Phase
	MHz	dBuV/m	dBuV/m	dB	dBuV	dB	dB/m	dB	cm	deg		
1	15567.60	52.82	54.00	-1.18	38.03	11.24	38.23	34.68	123	92	Average	HORIZONTAL
2	15578.80	65.89	74.00	-8.11	51.10	11.24	38.23	34.68	123	92	Peak	HORIZONTAL

Vertical

	Freq	Level	Limit Line	Over Limit	Read Level	CableAntenna Loss	Antenna Factor	Preamp Factor	A/Pos	T/Pos	Remark	Pol/Phase
	MHz	dBuV/m	dBuV/m	dB	dBuV	dB	dB/m	dB	cm	deg		
1	15566.00	50.15	54.00	-3.85	35.36	11.24	38.23	34.68	157	148	Average	VERTICAL
2	15577.60	62.40	74.00	-11.60	47.61	11.24	38.23	34.68	157	148	Peak	VERTICAL

Temperature	22°C	Humidity	54%
Test Engineer	Gino Huang	Configurations	IEEE 802.11ac MCS0/Nss1 VHT40 CH 46 / Chain 1 + Chain 2 + Chain 3+ Chain 4
Test Date	May 27, 2016~Jul. 26, 2016		

Horizontal

	Freq	Level	Limit	Over	Read	CableAntenna	Preamp	A/Pos	T/Pos	Remark	Pol/Phase	
	MHz	dBuV/m	dBuV/m	dB	dBuV	dB	dB/m	dB	cm	deg		
1	15677.40	61.72	74.00	-12.28	46.88	11.26	38.35	34.77	156	112	Peak	HORIZONTAL
2	15677.40	50.33	54.00	-3.67	35.49	11.26	38.35	34.77	156	112	Average	HORIZONTAL

Vertical

	Freq	Level	Limit	Over	Read	CableAntenna	Preamp	A/Pos	T/Pos	Remark	Pol/Phase	
	MHz	dBuV/m	dBuV/m	dB	dBuV	dB	dB/m	dB	cm	deg		
1	15567.00	59.20	74.00	-14.80	44.41	11.24	38.23	34.68	173	112	Peak	VERTICAL
2	15574.20	46.67	54.00	-7.33	31.88	11.24	38.23	34.68	173	112	Average	VERTICAL

Temperature	22°C	Humidity	54%
Test Engineer	Gino Huang	Configurations	IEEE 802.11ac MCS0/Nss1 VHT40 CH 151 / Chain 1 + Chain 2 + Chain 3+ Chain 4
Test Date	May 27, 2016~Jul. 26, 2016		

Horizontal

	Freq	Level	Limit	Over	Read	CableAntenna	Preamp	A/Pos	T/Pos	Remark	Pol/Phase	
	MHz	dBuV/m	dBuV/m	dB	dBuV	dB	dB/m	dB	cm	deg		
1	11537.83	42.22	54.00	-11.78	28.73	9.61	38.51	34.63	209	161	Average	HORIZONTAL
2	11540.34	55.35	74.00	-18.65	41.86	9.61	38.51	34.63	209	161	Peak	HORIZONTAL

Vertical

	Freq	Level	Limit	Over	Read	CableAntenna	Preamp	A/Pos	T/Pos	Remark	Pol/Phase	
	MHz	dBuV/m	dBuV/m	dB	dBuV	dB	dB/m	dB	cm	deg		
1	11539.44	42.13	54.00	-11.87	28.64	9.61	38.51	34.63	208	172	Average	VERTICAL
2	11540.03	55.22	74.00	-18.78	41.73	9.61	38.51	34.63	208	172	Peak	VERTICAL

Temperature	22°C	Humidity	54%
Test Engineer	Gino Huang	Configuration	IEEE 802.11ac MCS0/Nss1 VHT40 CH 159 / Chain 1 + Chain 2 + Chain 3+ Chain 4
Test Date	May 27, 2016~Jul. 26, 2016		

Horizontal

	Freq	Level	Limit	Over	Read	CableAntenna	Preamp	A/Pos	T/Pos	Remark	Pol/Phase	
	MHz	dBuV/m	dBuV/m	dB	dBuV	dB	dB/m	dB	cm	deg		
1	11587.94	41.89	54.00	-12.11	28.41	9.60	38.54	34.66	213	175	Average	HORIZONTAL
2	11589.35	55.14	74.00	-18.86	41.66	9.60	38.54	34.66	213	175	Peak	HORIZONTAL

Vertical

	Freq	Level	Limit	Over	Read	CableAntenna	Preamp	A/Pos	T/Pos	Remark	Pol/Phase	
	MHz	dBuV/m	dBuV/m	dB	dBuV	dB	dB/m	dB	cm	deg		
1	11587.65	55.11	74.00	-18.89	41.63	9.60	38.54	34.66	211	182	Peak	VERTICAL
2	11587.80	42.01	54.00	-11.99	28.53	9.60	38.54	34.66	211	182	Average	VERTICAL

Temperature	22°C	Humidity	54%
Test Engineer	Gino Huang	Configurations	IEEE 802.11ac MCS0/Nss1 VHT80 CH 42 / Chain 1 + Chain 2 + Chain 3+ Chain 4
Test Date	May 27, 2016~Jul. 26, 2016		

Horizontal

	Freq	Level	Limit Line	Over Limit	Read Level	CableAntenna Loss	Antenna Factor	Preamp Factor	A/Pos	T/Pos	Remark	Pol/Phase
	MHz	dBuV/m	dBuV/m	dB	dBuV	dB	dB/m	dB	cm	deg		
1	15628.08	49.37	54.00	-4.63	34.56	11.25	38.29	34.73	309	258	Average	HORIZONTAL
2	15630.32	61.70	74.00	-12.30	46.89	11.25	38.29	34.73	309	258	Peak	HORIZONTAL

Vertical

	Freq	Level	Limit Line	Over Limit	Read Level	CableAntenna Loss	Antenna Factor	Preamp Factor	A/Pos	T/Pos	Remark	Pol/Phase
	MHz	dBuV/m	dBuV/m	dB	dBuV	dB	dB/m	dB	cm	deg		
1	15595.12	59.03	74.00	-14.97	44.24	11.24	38.23	34.68	307	80	Peak	VERTICAL
2	15619.44	47.18	54.00	-6.82	32.37	11.25	38.29	34.73	307	80	Average	VERTICAL

Temperature	22°C	Humidity	54%
Test Engineer	Gino Huang	Configurations	IEEE 802.11ac MCS0/Nss1 VHT80 CH 155 / Chain 1 + Chain 2 + Chain 3+ Chain 4
Test Date	May 27, 2016~Jul. 26, 2016		

Horizontal

	Freq	Level	Limit	Over	Read	CableAntenna	Preamp	A/Pos	T/Pos	Remark	Pol/Phase	
	MHz	dBuV/m	dBuV/m	dB	dBuV	dB	dB/m	dB	cm	deg		
1	11548.95	42.16	54.00	-11.84	28.69	9.61	38.51	34.65	209	179	Average	HORIZONTAL
2	11549.71	54.85	74.00	-19.15	41.38	9.61	38.51	34.65	209	179	Peak	HORIZONTAL

Vertical

	Freq	Level	Limit	Over	Read	CableAntenna	Preamp	A/Pos	T/Pos	Remark	Pol/Phase	
	MHz	dBuV/m	dBuV/m	dB	dBuV	dB	dB/m	dB	cm	deg		
1	11547.98	42.00	54.00	-12.00	28.53	9.61	38.51	34.65	204	187	Average	VERTICAL
2	11552.12	54.93	74.00	-19.07	41.44	9.61	38.53	34.65	204	187	Peak	VERTICAL

Note:

The amplitude of spurious emissions that are attenuated by more than 20dB below the permissible value has no need to be reported.

Emission level (dBuV/m) = 20 log Emission level (uV/m).

Corrected Reading: Antenna Factor + Cable Loss + Read Level - Preamp Factor = Level.

<For Beamforming Mode>

Temperature	22°C	Humidity	54%
Test Engineer	Gino Huang	Configurations	IEEE 802.11ac MCS0/Nss1 VHT20 CH 36 / Chain 1 + Chain 2 + Chain 3+ Chain 4
Test Date	May 27, 2016~Jul. 26, 2016		

Horizontal

	Freq	Level	Limit Line	Over Limit	Read Level	CableAntenna Loss	Antenna Factor	Preamp Factor	A/Pos	T/Pos	Remark	Pol/Phase
	MHz	dBuV/m	dBuV/m	dB	dBuV	dB	dB/m	dB	cm	deg		
1	15540.52	50.76	54.00	-3.24	34.07	13.38	38.45	35.14	220	162	Average	HORIZONTAL
2	15541.18	62.05	74.00	-11.95	45.36	13.38	38.45	35.14	220	162	Peak	HORIZONTAL

Vertical

	Freq	Level	Limit Line	Over Limit	Read Level	CableAntenna Loss	Antenna Factor	Preamp Factor	A/Pos	T/Pos	Remark	Pol/Phase
	MHz	dBuV/m	dBuV/m	dB	dBuV	dB	dB/m	dB	cm	deg		
1	15539.34	60.66	74.00	-13.34	43.97	13.38	38.45	35.14	187	297	Peak	VERTICAL
2	15539.97	48.59	54.00	-5.41	31.90	13.38	38.45	35.14	187	297	Average	VERTICAL

Temperature	22°C	Humidity	54%
Test Engineer	Gino Huang	Configurations	IEEE 802.11ac MCS0/Nss1 VHT20 CH 40 / Chain 1 + Chain 2 + Chain 3+ Chain 4
Test Date	May 27, 2016~Jul. 26, 2016		

Horizontal

	Freq	Level	Limit Line	Over Limit	Read Level	CableAntenna Loss	Preamp Factor	A/Pos	T/Pos	Remark	Pol/Phase	
	MHz	dBuV/m	dBuV/m	dB	dBuV	dB	dB/m	dB	cm	deg		
1	15599.46	61.24	74.00	-12.76	44.63	13.38	38.39	35.16	187	147	Peak	HORIZONTAL
2	15602.15	50.55	54.00	-3.45	34.02	13.38	38.34	35.19	187	147	Average	HORIZONTAL

Vertical

	Freq	Level	Limit Line	Over Limit	Read Level	CableAntenna Loss	Preamp Factor	A/Pos	T/Pos	Remark	Pol/Phase	
	MHz	dBuV/m	dBuV/m	dB	dBuV	dB	dB/m	dB	cm	deg		
1	15600.22	48.02	54.00	-5.98	31.41	13.38	38.39	35.16	156	180	Average	VERTICAL
2	15601.23	61.30	74.00	-12.70	44.77	13.38	38.34	35.19	156	180	Peak	VERTICAL

Temperature	22°C	Humidity	54%
Test Engineer	Gino Huang	Configurations	IEEE 802.11ac MCS0/Nss1 VHT20 CH 48 / Chain 1 + Chain 2 + Chain 3+ Chain 4
Test Date	May 27, 2016~Jul. 26, 2016		

Horizontal

	Freq	Level	Limit Line	Over Limit	Read Level	CableAntenna Loss	Antenna Factor	Preamp Factor	A/Pos	T/Pos	Remark	Pol/Phase
	MHz	dBuV/m	dBuV/m	dB	dBuV	dB	dB/m	dB	cm	deg		
1	15717.70	50.16	54.00	-3.84	33.78	13.39	38.23	35.24	191	224	Average	HORIZONTAL
2	15719.14	61.87	74.00	-12.13	45.49	13.39	38.23	35.24	191	224	Peak	HORIZONTAL

Vertical

	Freq	Level	Limit Line	Over Limit	Read Level	CableAntenna Loss	Antenna Factor	Preamp Factor	A/Pos	T/Pos	Remark	Pol/Phase
	MHz	dBuV/m	dBuV/m	dB	dBuV	dB	dB/m	dB	cm	deg		
1	15720.02	47.23	54.00	-6.77	30.85	13.39	38.23	35.24	170	164	Average	VERTICAL
2	15720.03	60.22	74.00	-13.78	43.84	13.39	38.23	35.24	170	164	Peak	VERTICAL

Temperature	22°C	Humidity	54%
Test Engineer	Gino Huang	Configurations	IEEE 802.11ac MCS0/Nss1 VHT20 CH 149 / Chain 1 + Chain 2 + Chain 3+ Chain 4
Test Date	May 27, 2016~Jul. 26, 2016		

Horizontal

	Freq	Level	Limit Line	Over Limit	Read Level	CableAntenna Loss	Antenna Factor	Preamp Factor	A/Pos	T/Pos	Remark	Pol/Phase
	MHz	dBuV/m	dBuV/m	dB	dBuV	dB	dB/m	dB	cm	deg		
1	11488.84	56.35	74.00	-17.65	41.27	10.51	39.20	34.63	160	121	Peak	HORIZONTAL
2	11490.62	43.52	54.00	-10.48	28.44	10.51	39.20	34.63	160	121	Average	HORIZONTAL

Vertical

	Freq	Level	Limit Line	Over Limit	Read Level	CableAntenna Loss	Antenna Factor	Preamp Factor	A/Pos	T/Pos	Remark	Pol/Phase
	MHz	dBuV/m	dBuV/m	dB	dBuV	dB	dB/m	dB	cm	deg		
1	11485.02	55.75	74.00	-18.25	40.67	10.51	39.20	34.63	169	161	Peak	VERTICAL
2	11490.82	43.79	54.00	-10.21	28.71	10.51	39.20	34.63	169	161	Average	VERTICAL

Temperature	22°C	Humidity	54%
Test Engineer	Gino Huang	Configurations	IEEE 802.11ac MCS0/Nss1 VHT20 CH 157 / Chain 1 + Chain 2 + Chain 3+ Chain 4
Test Date	May 27, 2016~Jul. 26, 2016		

Horizontal

	Freq	Level	Limit Line	Over Limit	Read Level	CableAntenna Loss	Antenna Factor	Preamp Factor	A/Pos	T/Pos	Remark	Pol/Phase
	MHz	dBuV/m	dBuV/m	dB	dBuV	dB	dB/m	dB	cm	deg		
1	11573.16	54.85	74.00	-19.15	39.84	10.51	39.15	34.65	172	182	Peak	HORIZONTAL
2	11574.20	42.41	54.00	-11.59	27.40	10.51	39.15	34.65	172	182	Average	HORIZONTAL

Vertical

	Freq	Level	Limit Line	Over Limit	Read Level	CableAntenna Loss	Antenna Factor	Preamp Factor	A/Pos	T/Pos	Remark	Pol/Phase
	MHz	dBuV/m	dBuV/m	dB	dBuV	dB	dB/m	dB	cm	deg		
1	11569.22	42.87	54.00	-11.13	27.86	10.51	39.15	34.65	163	209	Average	VERTICAL
2	11572.44	55.59	74.00	-18.41	40.58	10.51	39.15	34.65	163	209	Peak	VERTICAL

Temperature	22°C	Humidity	54%
Test Engineer	Gino Huang	Configurations	IEEE 802.11ac MCS0/Nss1 VHT20 CH 165 / Chain 1 + Chain 2 + Chain 3+ Chain 4
Test Date	May 27, 2016~Jul. 26, 2016		

Horizontal

	Freq	Level	Limit Line	Over Limit	Read Level	CableAntenna Loss	Antenna Factor	Preamp Factor	A/Pos	T/Pos	Remark	Pol/Phase
	MHz	dBuV/m	dBuV/m	dB	dBuV	dB	dB/m	dB	cm	deg		
1	11648.42	56.87	74.00	-17.13	41.93	10.51	39.09	34.66	160	47	Peak	HORIZONTAL
2	11650.10	43.25	54.00	-10.75	28.31	10.51	39.09	34.66	160	47	Average	HORIZONTAL

Vertical

	Freq	Level	Limit Line	Over Limit	Read Level	CableAntenna Loss	Antenna Factor	Preamp Factor	A/Pos	T/Pos	Remark	Pol/Phase
	MHz	dBuV/m	dBuV/m	dB	dBuV	dB	dB/m	dB	cm	deg		
1	11647.30	42.50	54.00	-11.50	27.56	10.51	39.09	34.66	174	98	Average	VERTICAL
2	11648.68	56.63	74.00	-17.37	41.69	10.51	39.09	34.66	174	98	Peak	VERTICAL

Temperature	22°C	Humidity	54%
Test Engineer	Gino Huang	Configurations	IEEE 802.11ac MCS0/Nss1 VHT40 CH 38 / Chain 1 + Chain 2 + Chain 3+ Chain 4
Test Date	May 27, 2016~Jul. 26, 2016		

Horizontal

	Freq	Level	Limit Line	Over Limit	Read Level	CableAntenna Loss	Antenna Factor	Preamp Factor	A/Pos	T/Pos	Remark	Pol/Phase
	MHz	dBuV/m	dBuV/m	dB	dBuV	dB	dB/m	dB	cm	deg		
1	15572.32	48.64	54.00	-5.36	32.03	13.38	38.39	35.16	227	60	Average	HORIZONTAL
2	15580.58	61.04	74.00	-12.96	44.43	13.38	38.39	35.16	227	60	Peak	HORIZONTAL

Vertical

	Freq	Level	Limit Line	Over Limit	Read Level	CableAntenna Loss	Antenna Factor	Preamp Factor	A/Pos	T/Pos	Remark	Pol/Phase
	MHz	dBuV/m	dBuV/m	dB	dBuV	dB	dB/m	dB	cm	deg		
1	15569.28	59.86	74.00	-14.14	43.25	13.38	38.39	35.16	199	94	Peak	VERTICAL
2	15570.95	46.84	54.00	-7.16	30.23	13.38	38.39	35.16	199	94	Average	VERTICAL

Temperature	22°C	Humidity	54%
Test Engineer	Gino Huang	Configurations	IEEE 802.11ac MCS0/Nss1 VHT40 CH 46 / Chain 1 + Chain 2 + Chain 3+ Chain 4
Test Date	May 27, 2016~Jul. 26, 2016		

Horizontal

	Freq	Level	Limit Line	Over Limit	Read Level	CableAntenna Loss	Antenna Factor	Preamp Factor	A/Pos	T/Pos	Remark	Pol/Phase
	MHz	dBuV/m	dBuV/m	dB	dBuV	dB	dB/m	dB	cm	deg		
1	15689.37	48.93	54.00	-5.07	32.47	13.39	38.28	35.21	204	109	Average	HORIZONTAL
2	15692.27	61.00	74.00	-13.00	44.62	13.39	38.23	35.24	204	109	Peak	HORIZONTAL

Vertical

	Freq	Level	Limit Line	Over Limit	Read Level	CableAntenna Loss	Antenna Factor	Preamp Factor	A/Pos	T/Pos	Remark	Pol/Phase
	MHz	dBuV/m	dBuV/m	dB	dBuV	dB	dB/m	dB	cm	deg		
1	15689.06	47.61	54.00	-6.39	31.15	13.39	38.28	35.21	183	193	Average	VERTICAL
2	15689.90	60.35	74.00	-13.65	43.89	13.39	38.28	35.21	183	193	Peak	VERTICAL

Temperature	22°C	Humidity	54%
Test Engineer	Gino Huang	Configurations	IEEE 802.11ac MCS0/Nss1 VHT40 CH 151 / Chain 1 + Chain 2 + Chain 3+ Chain 4
Test Date	May 27, 2016~Jul. 26, 2016		

Horizontal

	Freq	Level	Limit Line	Over Limit	Read Level	CableAntenna Loss	Antenna Factor	Preamp Factor	A/Pos	T/Pos	Remark	Pol/Phase
	MHz	dBuV/m	dBuV/m	dB	dBuV	dB	dB/m	dB	cm	deg		
1	11505.24	53.87	74.00	-20.13	38.79	10.51	39.20	34.63	149	201	Peak	HORIZONTAL
2	11505.28	40.94	54.00	-13.06	25.86	10.51	39.20	34.63	149	201	Average	HORIZONTAL

Vertical

	Freq	Level	Limit Line	Over Limit	Read Level	CableAntenna Loss	Antenna Factor	Preamp Factor	A/Pos	T/Pos	Remark	Pol/Phase
	MHz	dBuV/m	dBuV/m	dB	dBuV	dB	dB/m	dB	cm	deg		
1	11505.20	40.84	54.00	-13.16	25.76	10.51	39.20	34.63	176	158	Average	VERTICAL
2	11506.24	53.85	74.00	-20.15	38.77	10.51	39.20	34.63	176	158	Peak	VERTICAL



Temperature	22°C	Humidity	54%
Test Engineer	Gino Huang	Configuration	IEEE 802.11ac MCS0/Nss1 VHT40 CH 159 / Chain 1 + Chain 2 + Chain 3+ Chain 4
Test Date	May 27, 2016~Jul. 26, 2016		

Horizontal

	Freq	Level	Limit Line	Over Limit	Read Level	CableAntenna Loss	Antenna Factor	Preamp Factor	A/Pos	T/Pos	Remark	Pol/Phase
	MHz	dBuV/m	dBuV/m	dB	dBuV	dB	dB/m	dB	cm	deg		
1	11585.50	56.65	74.00	-17.35	41.68	10.51	39.12	34.66	185	166	Peak	HORIZONTAL
2	11590.14	44.13	54.00	-9.87	29.16	10.51	39.12	34.66	185	166	Average	HORIZONTAL

Vertical

	Freq	Level	Limit Line	Over Limit	Read Level	CableAntenna Loss	Antenna Factor	Preamp Factor	A/Pos	T/Pos	Remark	Pol/Phase
	MHz	dBuV/m	dBuV/m	dB	dBuV	dB	dB/m	dB	cm	deg		
1	11588.46	57.20	74.00	-16.80	42.23	10.51	39.12	34.66	162	230	Peak	VERTICAL
2	11590.10	44.14	54.00	-9.86	29.17	10.51	39.12	34.66	162	230	Average	VERTICAL

Temperature	22°C	Humidity	54%
Test Engineer	Gino Huang	Configurations	IEEE 802.11ac MCS0/Nss1 VHT80 CH 42 / Chain 1 + Chain 2 + Chain 3+ Chain 4
Test Date	May 27, 2016~Jul. 26, 2016		

Horizontal

	Freq	Level	Limit Line	Over Limit	Read Level	CableAntenna Loss	Antenna Factor	Preamp Factor	A/Pos	T/Pos	Remark	Pol/Phase
	MHz	dBuV/m	dBuV/m	dB	dBuV	dB	dB/m	dB	cm	deg		
1	15626.28	46.20	54.00	-7.80	32.68	11.01	38.37	35.86	162	244	Average	HORIZONTAL
2	15635.04	58.27	74.00	-15.73	44.75	11.01	38.37	35.86	162	244	Peak	HORIZONTAL

Vertical

	Freq	Level	Limit Line	Over Limit	Read Level	CableAntenna Loss	Antenna Factor	Preamp Factor	A/Pos	T/Pos	Remark	Pol/Phase
	MHz	dBuV/m	dBuV/m	dB	dBuV	dB	dB/m	dB	cm	deg		
1	15628.08	57.98	74.00	-16.02	44.46	11.01	38.37	35.86	170	283	Peak	VERTICAL
2	15639.68	45.16	54.00	-8.84	31.64	11.01	38.37	35.86	170	283	Average	VERTICAL



Temperature	22°C	Humidity	54%
Test Engineer	Gino Huang	Configurations	IEEE 802.11ac MCS0/Nss1 VHT80 CH 155 / Chain 1 + Chain 2 + Chain 3+ Chain 4
Test Date	May 27, 2016~Jul. 26, 2016		

Horizontal

	Freq	Level	Limit Line	Over Limit	Read Level	CableAntenna Loss	Antenna Factor	Preamp Factor	A/Pos	T/Pos	Remark	Pol/Phase
	MHz	dBuV/m	dBuV/m	dB	dBuV	dB	dB/m	dB	cm	deg		
1	11553.72	57.22	74.00	-16.78	42.21	10.51	39.15	34.65	181	262	Peak	HORIZONTAL
2	11553.84	44.58	54.00	-9.42	29.57	10.51	39.15	34.65	181	262	Average	HORIZONTAL

Vertical

	Freq	Level	Limit Line	Over Limit	Read Level	CableAntenna Loss	Antenna Factor	Preamp Factor	A/Pos	T/Pos	Remark	Pol/Phase
	MHz	dBuV/m	dBuV/m	dB	dBuV	dB	dB/m	dB	cm	deg		
1	11547.24	56.66	74.00	-17.34	41.63	10.51	39.17	34.65	146	305	Peak	VERTICAL
2	11554.02	44.38	54.00	-9.62	29.37	10.51	39.15	34.65	146	305	Average	VERTICAL

Note:

The amplitude of spurious emissions that are attenuated by more than 20dB below the permissible value has no need to be reported.

Emission level (dBuV/m) = 20 log Emission level (uV/m).

Corrected Reading: Antenna Factor + Cable Loss + Read Level - Preamp Factor = Level.

For Directional antenna:

<For Non-Beamforming Mode>

Temperature	22°C	Humidity	54%
Test Engineer	Gino Huang	Configurations	IEEE 802.11a CH 36 / Chain 1 + Chain 2 + Chain 3+ Chain 4
Test Date	May 27, 2016~Jul. 26, 2016		

Horizontal

	Freq	Level	Limit Line	Over Limit	Read Level	CableAntenna Loss	Antenna Factor	Preamp Factor	A/Pos	T/Pos	Remark	Pol/Phase
	MHz	dBuV/m	dBuV/m	dB	dBuV	dB	dB/m	dB	cm	deg		
1	15538.80	53.71	54.00	-0.29	38.96	11.23	38.16	34.64	125	250	Average	HORIZONTAL
2	15541.80	66.39	74.00	-7.61	51.64	11.23	38.16	34.64	125	250	Peak	HORIZONTAL

Vertical

	Freq	Level	Limit Line	Over Limit	Read Level	CableAntenna Loss	Antenna Factor	Preamp Factor	A/Pos	T/Pos	Remark	Pol/Phase
	MHz	dBuV/m	dBuV/m	dB	dBuV	dB	dB/m	dB	cm	deg		
1	15538.80	49.66	54.00	-4.34	34.91	11.23	38.16	34.64	101	158	Average	VERTICAL
2	15539.84	63.20	74.00	-10.80	48.45	11.23	38.16	34.64	101	158	Peak	VERTICAL

Temperature	22°C	Humidity	54%
Test Engineer	Gino Huang	Configurations	IEEE 802.11a CH 40 / Chain 1 + Chain 2 + Chain 3+ Chain 4
Test Date	May 27, 2016~Jul. 26, 2016		

Horizontal

	Freq	Level	Limit Line	Over Limit	Read Level	CableAntenna Loss	Antenna Factor	Preamp Factor	A/Pos	T/Pos	Remark	Pol/Phase
	MHz	dBuV/m	dBuV/m	dB	dBuV	dB	dB/m	dB	cm	deg		
1	15599.28	67.14	74.00	-6.86	52.35	11.24	38.23	34.68	153	251	Peak	HORIZONTAL
2	15600.04	53.90	54.00	-0.10	39.11	11.24	38.23	34.68	153	251	Average	HORIZONTAL

Vertical

	Freq	Level	Limit Line	Over Limit	Read Level	CableAntenna Loss	Antenna Factor	Preamp Factor	A/Pos	T/Pos	Remark	Pol/Phase
	MHz	dBuV/m	dBuV/m	dB	dBuV	dB	dB/m	dB	cm	deg		
1	15600.08	49.58	54.00	-4.42	34.79	11.24	38.23	34.68	101	163	Average	VERTICAL
2	15601.84	62.46	74.00	-11.54	47.60	11.25	38.29	34.68	101	163	Peak	VERTICAL

Temperature	22°C	Humidity	54%
Test Engineer	Gino Huang	Configurations	IEEE 802.11a CH 48 / Chain 1 + Chain 2 + Chain 3+ Chain 4
Test Date	May 27, 2016~Jul. 26, 2016		

Horizontal

	Freq	Level	Limit	Over	Read	CableAntenna	Preamp	A/Pos	T/Pos	Remark	Pol/Phase	
	MHz	dBuV/m	dBuV/m	dB	dBuV	dB	dB/m	dB	cm	deg		
1	15727.36	64.26	74.00	-9.74	49.38	11.27	38.42	34.81	105	249	Peak	HORIZONTAL
2	15727.52	50.65	54.00	-3.35	35.77	11.27	38.42	34.81	105	249	Average	HORIZONTAL

Vertical

	Freq	Level	Limit	Over	Read	CableAntenna	Preamp	A/Pos	T/Pos	Remark	Pol/Phase	
	MHz	dBuV/m	dBuV/m	dB	dBuV	dB	dB/m	dB	cm	deg		
1	15720.88	57.85	74.00	-16.15	42.97	11.27	38.42	34.81	121	66	Peak	VERTICAL
2	15722.32	46.33	54.00	-7.67	31.45	11.27	38.42	34.81	121	66	Average	VERTICAL

Temperature	22°C	Humidity	54%
Test Engineer	Gino Huang	Configurations	IEEE 802.11a CH 149 / Chain 1 + Chain 2 + Chain 3+ Chain 4
Test Date	May 27, 2016~Jul. 26, 2016		

Horizontal

	Freq	Level	Limit	Over	Read	CableAntenna	Preamp	A/Pos	T/Pos	Remark	Pol/Phase	
	MHz	dBuV/m	dBuV/m	dB	dBuV	dB	dB/m	dB	cm	deg		
1	11491.36	67.69	74.00	-6.31	54.19	9.62	38.50	34.62	169	242	Peak	HORIZONTAL
2	11491.80	53.89	54.00	-0.11	40.39	9.62	38.50	34.62	169	242	Average	HORIZONTAL

Vertical

	Freq	Level	Limit	Over	Read	CableAntenna	Preamp	A/Pos	T/Pos	Remark	Pol/Phase	
	MHz	dBuV/m	dBuV/m	dB	dBuV	dB	dB/m	dB	cm	deg		
1	11487.88	47.61	54.00	-6.39	34.11	9.62	38.50	34.62	108	226	Average	VERTICAL
2	11488.00	60.79	74.00	-13.21	47.29	9.62	38.50	34.62	108	226	Peak	VERTICAL

Temperature	22°C	Humidity	54%
Test Engineer	Gino Huang	Configurations	IEEE 802.11a CH 157 / Chain 1 + Chain 2 + Chain 3+ Chain 4
Test Date	May 27, 2016~Jul. 26, 2016		

Horizontal

	Freq	Level	Limit Line	Over Limit	Read Level	CableAntenna Loss	Antenna Factor	Preamp Factor	A/Pos	T/Pos	Remark	Pol/Phase
	MHz	dBuV/m	dBuV/m	dB	dBuV	dB	dB/m	dB	cm	deg		
1	11571.32	68.01	74.00	-5.99	54.52	9.61	38.53	34.65	162	245	Peak	HORIZONTAL
2	11572.20	53.94	54.00	-0.06	40.45	9.61	38.53	34.65	162	245	Average	HORIZONTAL

Vertical

	Freq	Level	Limit Line	Over Limit	Read Level	CableAntenna Loss	Antenna Factor	Preamp Factor	A/Pos	T/Pos	Remark	Pol/Phase
	MHz	dBuV/m	dBuV/m	dB	dBuV	dB	dB/m	dB	cm	deg		
1	11569.72	46.72	54.00	-7.28	33.23	9.61	38.53	34.65	110	228	Average	VERTICAL
2	11571.40	59.67	74.00	-14.33	46.18	9.61	38.53	34.65	110	228	Peak	VERTICAL

Temperature	22°C	Humidity	54%
Test Engineer	Gino Huang	Configurations	IEEE 802.11a CH 165 / Chain 1 + Chain 2 + Chain 3+ Chain 4
Test Date	May 27, 2016~Jul. 26, 2016		

Horizontal

	Freq	Level	Limit Line	Over Limit	Read Level	CableAntenna Loss	Antenna Factor	Preamp Factor	A/Pos	T/Pos	Remark	Pol/Phase
	MHz	dBuV/m	dBuV/m	dB	dBuV	dB	dB/m	dB	cm	deg		
1	11652.88	67.30	74.00	-6.70	53.81	9.60	38.57	34.68	160	248	Peak	HORIZONTAL
2	11652.88	53.96	54.00	-0.04	40.47	9.60	38.57	34.68	160	248	Average	HORIZONTAL

Vertical

	Freq	Level	Limit Line	Over Limit	Read Level	CableAntenna Loss	Antenna Factor	Preamp Factor	A/Pos	T/Pos	Remark	Pol/Phase
	MHz	dBuV/m	dBuV/m	dB	dBuV	dB	dB/m	dB	cm	deg		
1	11651.40	60.76	74.00	-13.24	47.27	9.60	38.57	34.68	100	228	Peak	VERTICAL
2	11652.16	47.03	54.00	-6.97	33.54	9.60	38.57	34.68	100	228	Average	VERTICAL

Temperature	22°C	Humidity	54%
Test Engineer	Gino Huang	Configurations	IEEE 802.11ac MCS0/Nss1 VHT20 CH 36 / Chain 1 + Chain 2 + Chain 3+ Chain 4
Test Date	May 27, 2016~Jul. 26, 2016		

Horizontal

	Freq	Level	Limit Line	Over Limit	Read Level	CableAntenna Loss	Antenna Factor	Preamp Factor	A/Pos	T/Pos	Remark	Pol/Phase
	MHz	dBuV/m	dBuV/m	dB	dBuV	dB	dB/m	dB	cm	deg		
1	15538.24	53.81	54.00	-0.19	39.06	11.23	38.16	34.64	128	251	Average	HORIZONTAL
2	15538.32	69.23	74.00	-4.77	54.48	11.23	38.16	34.64	128	251	Peak	HORIZONTAL

Vertical

	Freq	Level	Limit Line	Over Limit	Read Level	CableAntenna Loss	Antenna Factor	Preamp Factor	A/Pos	T/Pos	Remark	Pol/Phase
	MHz	dBuV/m	dBuV/m	dB	dBuV	dB	dB/m	dB	cm	deg		
1	15535.56	62.68	74.00	-11.32	47.93	11.23	38.16	34.64	101	150	Peak	VERTICAL
2	15535.56	48.86	54.00	-5.14	34.11	11.23	38.16	34.64	101	150	Average	VERTICAL

Temperature	22°C	Humidity	54%
Test Engineer	Gino Huang	Configurations	IEEE 802.11ac MCS0/Nss1 VHT20 CH 40 / Chain 1 + Chain 2 + Chain 3+ Chain 4
Test Date	May 27, 2016~Jul. 26, 2016		

Horizontal

	Freq	Level	Limit	Over	Read	CableAntenna	Preamp	A/Pos	T/Pos	Remark	Pol/Phase	
	MHz	dBuV/m	dBuV/m	dB	dBuV	dB	dB/m	dB	cm	deg		
1	15599.36	68.10	74.00	-5.90	53.31	11.24	38.23	34.68	142	250	Peak	HORIZONTAL
2	15600.80	53.95	54.00	-0.05	39.09	11.25	38.29	34.68	142	250	Average	HORIZONTAL

Vertical

	Freq	Level	Limit	Over	Read	CableAntenna	Preamp	A/Pos	T/Pos	Remark	Pol/Phase	
	MHz	dBuV/m	dBuV/m	dB	dBuV	dB	dB/m	dB	cm	deg		
1	15600.36	49.92	54.00	-4.08	35.13	11.24	38.23	34.68	101	163	Average	VERTICAL
2	15601.16	63.72	74.00	-10.28	48.86	11.25	38.29	34.68	101	163	Peak	VERTICAL

Temperature	22°C	Humidity	54%
Test Engineer	Gino Huang	Configurations	IEEE 802.11ac MCS0/Nss1 VHT20 CH 48 / Chain 1 + Chain 2 + Chain 3+ Chain 4
Test Date	May 27, 2016~Jul. 26, 2016		

Horizontal

	Freq	Level	Limit	Over	Read	CableAntenna	Preamp	A/Pos	T/Pos	Remark	Pol/Phase	
	MHz	dBuV/m	dBuV/m	dB	dBuV	dB	dB/m	dB	cm	deg		
1	15726.32	64.96	74.00	-9.04	50.08	11.27	38.42	34.81	104	249	Peak	HORIZONTAL
2	15727.36	50.65	54.00	-3.35	35.77	11.27	38.42	34.81	104	249	Average	HORIZONTAL

Vertical

	Freq	Level	Limit	Over	Read	CableAntenna	Preamp	A/Pos	T/Pos	Remark	Pol/Phase	
	MHz	dBuV/m	dBuV/m	dB	dBuV	dB	dB/m	dB	cm	deg		
1	15716.24	46.26	54.00	-7.74	31.38	11.27	38.42	34.81	126	53	Average	VERTICAL
2	15722.80	58.65	74.00	-15.35	43.77	11.27	38.42	34.81	126	53	Peak	VERTICAL

Temperature	22°C	Humidity	54%
Test Engineer	Gino Huang	Configurations	IEEE 802.11ac MCS0/Nss1 VHT20 CH 149 / Chain 1 + Chain 2 + Chain 3+ Chain 4
Test Date	May 27, 2016~Jul. 26, 2016		

Horizontal

	Freq	Level	Limit	Over	Read	CableAntenna	Preamp	A/Pos	T/Pos	Remark	Pol/Phase	
	MHz	dBuV/m	dBuV/m	dB	dBuV	dB	dB/m	dB	cm	deg		
1	11484.80	53.96	54.00	-0.04	40.46	9.62	38.50	34.62	164	244	Average	HORIZONTAL
2	11492.72	68.32	74.00	-5.68	54.82	9.62	38.50	34.62	164	244	Peak	HORIZONTAL

Vertical

	Freq	Level	Limit	Over	Read	CableAntenna	Preamp	A/Pos	T/Pos	Remark	Pol/Phase	
	MHz	dBuV/m	dBuV/m	dB	dBuV	dB	dB/m	dB	cm	deg		
1	11489.20	47.04	54.00	-6.96	33.54	9.62	38.50	34.62	113	230	Average	VERTICAL
2	11489.76	60.08	74.00	-13.92	46.58	9.62	38.50	34.62	113	230	Peak	VERTICAL

Temperature	22°C	Humidity	54%
Test Engineer	Gino Huang	Configurations	IEEE 802.11ac MCS0/Nss1 VHT20 CH 157 / Chain 1 + Chain 2 + Chain 3+ Chain 4
Test Date	May 27, 2016~Jul. 26, 2016		

Horizontal

	Freq	Level	Limit Line	Over Limit	Read Level	CableAntenna Loss	Antenna Factor	Preamp Factor	A/Pos	T/Pos	Remark	Pol/Phase
	MHz	dBuV/m	dBuV/m	dB	dBuV	dB	dB/m	dB	cm	deg		
1	11572.28	53.98	54.00	-0.02	40.49	9.61	38.53	34.65	165	244	Average	HORIZONTAL
2	11572.52	69.53	74.00	-4.47	56.04	9.61	38.53	34.65	165	244	Peak	HORIZONTAL

Vertical

	Freq	Level	Limit Line	Over Limit	Read Level	CableAntenna Loss	Antenna Factor	Preamp Factor	A/Pos	T/Pos	Remark	Pol/Phase
	MHz	dBuV/m	dBuV/m	dB	dBuV	dB	dB/m	dB	cm	deg		
1	11569.64	47.00	54.00	-7.00	33.51	9.61	38.53	34.65	103	229	Average	VERTICAL
2	11570.36	60.87	74.00	-13.13	47.38	9.61	38.53	34.65	103	229	Peak	VERTICAL

Temperature	22°C	Humidity	54%
Test Engineer	Gino Huang	Configurations	IEEE 802.11ac MCS0/Nss1 VHT20 CH 165 / Chain 1 + Chain 2 + Chain 3+ Chain 4
Test Date	May 27, 2016~Jul. 26, 2016		

Horizontal

	Freq	Level	Limit	Over	Read	CableAntenna	Preamp	A/Pos	T/Pos	Remark	Pol/Phase	
	MHz	dBuV/m	dBuV/m	dB	dBuV	dB	dB/m	dB	cm	deg		
1	11653.56	66.62	74.00	-7.38	53.13	9.60	38.57	34.68	138	244	Peak	HORIZONTAL
2	11653.56	53.85	54.00	-0.15	40.36	9.60	38.57	34.68	138	244	Average	HORIZONTAL

Vertical

	Freq	Level	Limit	Over	Read	CableAntenna	Preamp	A/Pos	T/Pos	Remark	Pol/Phase	
	MHz	dBuV/m	dBuV/m	dB	dBuV	dB	dB/m	dB	cm	deg		
1	11653.56	58.53	74.00	-15.47	45.04	9.60	38.57	34.68	127	227	Peak	VERTICAL
2	11653.56	46.54	54.00	-7.46	33.05	9.60	38.57	34.68	127	227	Average	VERTICAL

Temperature	22°C	Humidity	54%
Test Engineer	Gino Huang	Configurations	IEEE 802.11ac MCS0/Nss1 VHT40 CH 38 / Chain 1 + Chain 2 + Chain 3+ Chain 4
Test Date	May 27, 2016~Jul. 26, 2016		

Horizontal

	Freq	Level	Limit Line	Over Limit	Read Level	CableAntenna Loss	Preamp Factor	A/Pos	T/Pos	Remark	Pol/Phase	
	MHz	dBuV/m	dBuV/m	dB	dBuV	dB	dB/m	dB	cm	deg		
1	15561.36	46.53	54.00	-7.47	31.74	11.24	38.23	34.68	137	102	Average	HORIZONTAL
2	15565.60	59.61	74.00	-14.39	44.82	11.24	38.23	34.68	137	102	Peak	HORIZONTAL

Vertical

	Freq	Level	Limit Line	Over Limit	Read Level	CableAntenna Loss	Preamp Factor	A/Pos	T/Pos	Remark	Pol/Phase	
	MHz	dBuV/m	dBuV/m	dB	dBuV	dB	dB/m	dB	cm	deg		
1	15562.44	46.26	54.00	-7.74	31.47	11.24	38.23	34.68	140	229	Average	VERTICAL
2	15576.44	59.35	74.00	-14.65	44.56	11.24	38.23	34.68	140	229	Peak	VERTICAL

Temperature	22°C	Humidity	54%
Test Engineer	Gino Huang	Configurations	IEEE 802.11ac MCS0/Nss1 VHT40 CH 46 / Chain 1 + Chain 2 + Chain 3+ Chain 4
Test Date	May 27, 2016~Jul. 26, 2016		

Horizontal

	Freq	Level	Limit	Over	Read	CableAntenna	Preamp	A/Pos	T/Pos	Remark	Pol/Phase	
	MHz	dBuV/m	dBuV/m	dB	dBuV	dB	dB/m	dB	cm	deg		
1	15693.96	61.29	74.00	-12.71	46.37	11.27	38.42	34.77	132	250	Peak	HORIZONTAL
2	15696.32	48.30	54.00	-5.70	33.38	11.27	38.42	34.77	132	250	Average	HORIZONTAL

Vertical

	Freq	Level	Limit	Over	Read	CableAntenna	Preamp	A/Pos	T/Pos	Remark	Pol/Phase	
	MHz	dBuV/m	dBuV/m	dB	dBuV	dB	dB/m	dB	cm	deg		
1	15693.60	58.83	74.00	-15.17	43.91	11.27	38.42	34.77	140	64	Peak	VERTICAL
2	15695.92	46.43	54.00	-7.57	31.51	11.27	38.42	34.77	140	64	Average	VERTICAL

Temperature	22°C	Humidity	54%
Test Engineer	Gino Huang	Configurations	IEEE 802.11ac MCS0/Nss1 VHT40 CH 151 / Chain 1 + Chain 2 + Chain 3+ Chain 4
Test Date	May 27, 2016~Jul. 26, 2016		

Horizontal

	Freq	Level	Limit	Over	Read	CableAntenna	Preamp	A/Pos	T/Pos	Remark	Pol/Phase	
	MHz	dBuV/m	dBuV/m	dB	dBuV	dB	dB/m	dB	cm	deg		
1	11504.24	51.47	54.00	-2.53	37.97	9.62	38.50	34.62	166	241	Average	HORIZONTAL
2	11512.52	63.78	74.00	-10.22	50.29	9.62	38.50	34.63	166	241	Peak	HORIZONTAL

Vertical

	Freq	Level	Limit	Over	Read	CableAntenna	Preamp	A/Pos	T/Pos	Remark	Pol/Phase	
	MHz	dBuV/m	dBuV/m	dB	dBuV	dB	dB/m	dB	cm	deg		
1	11511.72	57.59	74.00	-16.41	44.10	9.62	38.50	34.63	105	257	Peak	VERTICAL
2	11512.36	45.57	54.00	-8.43	32.08	9.62	38.50	34.63	105	257	Average	VERTICAL

Temperature	22°C	Humidity	54%
Test Engineer	Gino Huang	Configuration	IEEE 802.11ac MCS0/Nss1 VHT40 CH 159 / Chain 1 + Chain 2 + Chain 3+ Chain 4
Test Date	May 27, 2016~Jul. 26, 2016		

Horizontal

	Freq	Level	Limit	Over	Read	CableAntenna	Preamp	A/Pos	T/Pos	Remark	Pol/Phase	
	MHz	dBuV/m	dBuV/m	dB	dBuV	dB	dB/m	dB	cm	deg		
1	11592.12	53.59	54.00	-0.41	40.11	9.60	38.54	34.66	162	245	Average	HORIZONTAL
2	11593.28	66.33	74.00	-7.67	52.85	9.60	38.54	34.66	162	245	Peak	HORIZONTAL

Vertical

	Freq	Level	Limit	Over	Read	CableAntenna	Preamp	A/Pos	T/Pos	Remark	Pol/Phase	
	MHz	dBuV/m	dBuV/m	dB	dBuV	dB	dB/m	dB	cm	deg		
1	11586.16	47.83	54.00	-6.17	34.35	9.60	38.54	34.66	124	242	Average	VERTICAL
2	11586.60	60.67	74.00	-13.33	47.19	9.60	38.54	34.66	124	242	Peak	VERTICAL

Temperature	22°C	Humidity	54%
Test Engineer	Gino Huang	Configurations	IEEE 802.11ac MCS0/Nss1 VHT80 CH 42 / Chain 1 + Chain 2 + Chain 3+ Chain 4
Test Date	May 27, 2016~Jul. 26, 2016		

Horizontal

	Freq	Level	Limit Line	Over Limit	Read Level	CableAntenna Loss	Antenna Factor	Preamp Factor	A/Pos	T/Pos	Remark	Pol/Phase
	MHz	dBuV/m	dBuV/m	dB	dBuV	dB	dB/m	dB	cm	deg		
1	15622.64	60.10	74.00	-13.90	45.29	11.25	38.29	34.73	119	205	Peak	HORIZONTAL
2	15628.28	45.90	54.00	-8.10	31.09	11.25	38.29	34.73	119	205	Average	HORIZONTAL

Vertical

	Freq	Level	Limit Line	Over Limit	Read Level	CableAntenna Loss	Antenna Factor	Preamp Factor	A/Pos	T/Pos	Remark	Pol/Phase
	MHz	dBuV/m	dBuV/m	dB	dBuV	dB	dB/m	dB	cm	deg		
1	15626.52	45.93	54.00	-8.07	31.12	11.25	38.29	34.73	134	89	Average	VERTICAL
2	15629.24	58.69	74.00	-15.31	43.88	11.25	38.29	34.73	134	89	Peak	VERTICAL

Temperature	22°C	Humidity	54%
Test Engineer	Gino Huang	Configurations	IEEE 802.11ac MCS0/Nss1 VHT80 CH 155 / Chain 1 + Chain 2 + Chain 3+ Chain 4
Test Date	May 27, 2016~Jul. 26, 2016		

Horizontal

	Freq	Level	Limit	Over	Read	CableAntenna	Preamp	A/Pos	T/Pos	Remark	Pol/Phase	
	MHz	dBuV/m	dBuV/m	dB	dBuV	dB	dB/m	dB	cm	deg		
1	11544.56	50.08	54.00	-3.92	36.59	9.61	38.51	34.63	167	242	Average	HORIZONTAL
2	11553.44	62.66	74.00	-11.34	49.17	9.61	38.53	34.65	167	242	Peak	HORIZONTAL

Vertical

	Freq	Level	Limit	Over	Read	CableAntenna	Preamp	A/Pos	T/Pos	Remark	Pol/Phase	
	MHz	dBuV/m	dBuV/m	dB	dBuV	dB	dB/m	dB	cm	deg		
1	11545.48	45.46	54.00	-8.54	31.97	9.61	38.51	34.63	125	242	Average	VERTICAL
2	11545.72	58.56	74.00	-15.44	45.07	9.61	38.51	34.63	125	242	Peak	VERTICAL

Note:

The amplitude of spurious emissions that are attenuated by more than 20dB below the permissible value has no need to be reported.

Emission level (dBuV/m) = 20 log Emission level (uV/m).

Corrected Reading: Antenna Factor + Cable Loss + Read Level - Preamp Factor = Level.

<For Beamforming Mode>

Temperature	22°C	Humidity	54%
Test Engineer	Gino Huang	Configurations	IEEE 802.11ac MCS0/Nss1 VHT20 CH 36 / Chain 1 + Chain 2 + Chain 3+ Chain 4
Test Date	May 27, 2016~Jul. 26, 2016		

Horizontal

	Freq	Level	Limit Line	Over Limit	Read Level	CableAntenna Loss	Antenna Factor	Preamp Factor	A/Pos	T/Pos	Remark	Pol/Phase
	MHz	dBuV/m	dBuV/m	dB	dBuV	dB	dB/m	dB	cm	deg		
1	15540.66	47.12	54.00	-6.88	30.43	13.38	38.45	35.14	167	54	Average	HORIZONTAL
2	15542.47	59.43	74.00	-14.57	42.74	13.38	38.45	35.14	167	54	Peak	HORIZONTAL

Vertical

	Freq	Level	Limit Line	Over Limit	Read Level	CableAntenna Loss	Antenna Factor	Preamp Factor	A/Pos	T/Pos	Remark	Pol/Phase
	MHz	dBuV/m	dBuV/m	dB	dBuV	dB	dB/m	dB	cm	deg		
1	15542.43	60.69	74.00	-13.31	44.00	13.38	38.45	35.14	227	128	Peak	VERTICAL
2	15542.46	46.91	54.00	-7.09	30.22	13.38	38.45	35.14	227	128	Average	VERTICAL



Temperature	22°C	Humidity	54%
Test Engineer	Gino Huang	Configurations	IEEE 802.11ac MCS0/Nss1 VHT20 CH 40 / Chain 1 + Chain 2 + Chain 3+ Chain 4
Test Date	May 27, 2016~Jul. 26, 2016		

Horizontal

	Freq	Level	Limit Line	Over Limit	Read Level	CableAntenna Loss	Antenna Factor	Preamp Factor	A/Pos	T/Pos	Remark	Pol/Phase
	MHz	dBuV/m	dBuV/m	dB	dBuV	dB	dB/m	dB	cm	deg		
1	15595.74	60.27	74.00	-13.73	43.66	13.38	38.39	35.16	184	204	Peak	HORIZONTAL
2	15604.20	46.14	54.00	-7.86	29.61	13.38	38.34	35.19	184	204	Average	HORIZONTAL

Vertical

	Freq	Level	Limit Line	Over Limit	Read Level	CableAntenna Loss	Antenna Factor	Preamp Factor	A/Pos	T/Pos	Remark	Pol/Phase
	MHz	dBuV/m	dBuV/m	dB	dBuV	dB	dB/m	dB	cm	deg		
1	15596.75	59.51	74.00	-14.49	42.90	13.38	38.39	35.16	191	156	Peak	VERTICAL
2	15599.98	48.16	54.00	-5.84	31.55	13.38	38.39	35.16	191	156	Average	VERTICAL

Temperature	22°C	Humidity	54%
Test Engineer	Gino Huang	Configurations	IEEE 802.11ac MCS0/Nss1 VHT20 CH 48 / Chain 1 + Chain 2 + Chain 3+ Chain 4
Test Date	May 27, 2016~Jul. 26, 2016		

Horizontal

	Freq	Level	Limit Line	Over Limit	Read Level	CableAntenna Loss	Preamp Factor	A/Pos	T/Pos	Remark	Pol/Phase
	MHz	dBuV/m	dBuV/m	dB	dBuV	dB	dB/m	dB	cm	deg	
1	15719.52	45.72	54.00	-8.28	29.34	13.39	38.23	35.24	156	229 Average	HORIZONTAL
2	15724.34	59.59	74.00	-14.41	43.21	13.39	38.23	35.24	156	229 Peak	HORIZONTAL

Vertical

	Freq	Level	Limit Line	Over Limit	Read Level	CableAntenna Loss	Preamp Factor	A/Pos	T/Pos	Remark	Pol/Phase
	MHz	dBuV/m	dBuV/m	dB	dBuV	dB	dB/m	dB	cm	deg	
1	15721.14	58.64	74.00	-15.36	42.26	13.39	38.23	35.24	164	84 Peak	VERTICAL
2	15723.04	46.45	54.00	-7.55	30.07	13.39	38.23	35.24	164	84 Average	VERTICAL