



FCC Test Report

FCC ID : 2AGMRAP24I612
Equipment : 4-Radio Reconfigurable Wide Coverage Indoor Wireless Access Point
Brand Name : EVEREST™ Network Solutions
Model Name : AP24I612
Applicant : Tembo Systems, Inc.
2933 Bunker Hill lane, Suite 100, Santa Clara, CA
95054 U.S.A
Manufacturer : Tembo Systems, Inc.
2933 Bunker Hill lane, Suite 100, Santa Clara, CA
95054 U.S.A
Standard : 47 CFR FCC Part 15.247

The product was received on Mar. 19, 2018, and testing was started from Mar. 28, 2018 and completed on Apr. 09, 2018. We, SPORTON INTERTIONAL INC. EMC & Wireless Communications Laboratory, would like to declare that the tested sample has been evaluated in accordance with the procedures given in ANSI C63.10-2013 and shown compliance with the applicable technical standards.

The report must not be used by the client to claim product certification, approval, or endorsement by TAF or any agency of government.

The test results in this report apply exclusively to the tested model / sample. Without written approval of SPORTON INTERTIONAL INC. EMC & Wireless Communications Laboratory, the test report shall not be reproduced except in full.



Approved by: Allen Lin

SPORTON INTERTIONAL INC. EMC & Wireless Communications Laboratory

No. 52, Huaya 1st Rd., Guishan Dist., Taoyuan City, Taiwan (R.O.C.)



Table of Contents

HISTORY OF THIS TEST REPORT3

SUMMARY OF TEST RESULT4

1 GENERAL DESCRIPTION5

1.1 Information.....5

1.2 Testing Applied Standards6

1.3 Testing Location Information6

1.4 Measurement Uncertainty6

2 TEST CONFIGURATION OF EUT.....7

2.1 Test Condition7

2.2 Test Channel Mode7

2.3 The Worst Case Measurement Configuration.....8

2.4 Support Equipment.....8

2.5 Test Setup Diagram9

3 TRANSMITTER TEST RESULT11

3.1 AC Power-line Conducted Emissions11

3.2 DTS Bandwidth.....13

3.3 Maximum Conducted Output Power14

3.4 Power Spectral Density16

3.5 Emissions in Non-restricted Frequency Bands17

3.6 Emissions in Restricted Frequency Bands.....18

4 TEST EQUIPMENT AND CALIBRATION DATA.....22

APPENDIX A. TEST RESULTS OF AC POWER-LINE CONDUCTED EMISSIONS

APPENDIX B. TEST RESULTS OF DTS BANDWIDTH

APPENDIX C. TEST RESULTS OF MAXIMUM CONDUCTED OUTPUT POWER

APPENDIX D. TEST RESULTS OF POWER SPECTRAL DENSITY

APPENDIX E. TEST RESULTS OF EMISSIONS IN NON-RESTRICTED FREQUENCY BANDS

APPENDIX F. TEST RESULTS OF EMISSIONS IN RESTRICTED FREQUENCY BANDS

APPENDIX G. TEST PHOTOS

PHOTOGRAPHS OF EUT V01



History of this test report

Report No.	Version	Description	Issued Date
FR831528AL	01	Initial issue of report	Apr. 18, 2018
FR831528AL	02	Revise model name and add marketing name	Apr. 23, 2018
FR831528AL	03	Revise typo	May 15, 2018



Summary of Test Result

Report Clause	Ref. Std. Clause	Test Items	Result (PASS/FAIL)	Remark
1.1.2	15.203	Antenna Requirement	PASS	FCC 15.203
3.1	15.207	AC Power-line Conducted Emissions	PASS	FCC 15.207
3.2	15.247(a)	DTS Bandwidth	PASS	≥500kHz
3.3	15.247(b)	Maximum Conducted Output Power	PASS	Power [dBm]:30
3.4	15.247(e)	Power Spectral Density	PASS	PSD [dBm/3kHz]:8
3.5	15.247(d)	Emissions in Non-restricted Frequency Bands	PASS	Non-Restricted Bands: >30 dBc
3.6	15.247(d)	Emissions in Restricted Frequency Bands	PASS	Restricted Bands: FCC 15.209

Reviewed by: Jeremy Lin

Report Producer: Debby Hung

1 General Description

1.1 Information

1.1.1 RF General Information

Frequency Range (MHz)	Bluetooth Mode	Ch. Frequency (MHz)	Channel Number
2400-2483.5	LE	2402-2480	0-39 [40]

Band	Mode	BWch (MHz)	Nant
2.4-2.4835GHz	BT-LE(1Mbps)	1.0	1TX

Note:

- ♦ Bluetooth LE uses a GFSK (1Mbps) modulation for DSSS.
- ♦ BWch is the nominal channel bandwidth.

1.1.2 Antenna Information

Ant.	Brand Holder	Model Name	Antenna Type	Connector	Gain (dBi)	TX Function	Host System Model
	Tembo Systems Inc.	PCA-000020-00 0-X	OMNI Antenna	I-PEX	Note	1TX/1RX	AP1004WRi

Note:

Ant.	Gain (dBi)	Cable loss	True Gain (dBi)	Array Gain (dBi)
	-0.5	0.7	-1.2	0

1.1.3 EUT Information

Identify EUT	
Marketing Name	AP1004WRi
Operational Condition	
EUT Power Type	From AC Adapter
Type of EUT	
<input checked="" type="checkbox"/>	Stand-alone
<input type="checkbox"/>	Combined (EUT where the radio part is fully integrated within another device)
	Combined Equipment - Brand Name / Model No.: ...
<input type="checkbox"/>	Plug-in radio (EUT intended for a variety of host systems)
	Host System - Brand Name / Model No.: ...
<input type="checkbox"/>	Other:

1.1.4 Mode Test Duty Cycle

Mode	DC	DCF(dB)	T(s)	VBW(Hz) ≥ 1/T
BT-LE(1Mbps)	0.576	2.396	360.625u	3k

1.2 Testing Applied Standards

According to the specifications of the manufacturer, the EUT must comply with the requirements of the following standards:

- ♦ 47 CFR FCC Part 15
- ♦ ANSI C63.10-2013
- ♦ KDB 558074 D01 v04

1.3 Testing Location Information

Testing Location		
<input checked="" type="checkbox"/>	HWA YA	ADD : No. 52, Huaya 1st Rd., Guishan Dist., Taoyuan City, Taiwan (R.O.C.) TEL : 886-3-327-3456 FAX : 886-3-327-0973
Test site Designation No. TW1190 with FCC.		
<input type="checkbox"/>	JHUBEI	ADD : No.8, Ln. 724, Bo'ai St., Zhubei City, Hsinchu County, Taiwan (R.O.C.) TEL : 886-3-656-9065 FAX : 886-3-656-9085
Test site Designation No. TW0006 with FCC.		

Test Condition	Test Site No.	Test Engineer	Test Environment	Test Date
AC Conduction	CO04-HY	Jeff	22.2°C / 51.8%	09/Apr/2018
RF Conducted	TH06-HY	Barry	24.3°C / 63%	28/Mar/2018
Radiated	03CH02-HY	Terry	22.2°C / 51.8%	03/Apr/2018

1.4 Measurement Uncertainty

ISO/IEC 17025 requires that an estimate of the measurement uncertainties associated with the emissions test results be included in the report. The measurement uncertainties given below are based on a 95% confidence level (based on a coverage factor (k=2))

Test Items	Uncertainty	Remark
Conducted Emission (150kHz ~ 30MHz)	3.6 dB	Confidence levels of 95%
Radiated Emission (9kHz ~ 30MHz)	3.0 dB	Confidence levels of 95%
Radiated Emission (30MHz ~ 1,000MHz)	4.3 dB	Confidence levels of 95%
Radiated Emission (1GHz ~ 18GHz)	3.9 dB	Confidence levels of 95%
Radiated Emission (18GHz ~ 40GHz)	3.5 dB	Confidence levels of 95%
Conducted Emission	1.3 dB	Confidence levels of 95%
Temperature	0.7 °C	Confidence levels of 95%
Humidity	4 %	Confidence levels of 95%



2 Test Configuration of EUT

2.1 Test Condition

RF Conducted	Abbreviation	Remark
TnomVnom	Tnom	20°C
-	Vnom	120V

2.2 Test Channel Mode



Test Software Version	Dos
-----------------------	-----

Mode	Power Setting
BT-LE(1Mbps)	-
2402MHz	default
2440MHz	default
2480MHz	default

2.3 The Worst Case Measurement Configuration

The Worst Case Mode for Following Conformance Tests	
Tests Item	AC power-line conducted emissions
Condition	AC power-line conducted measurement for line and neutral
Operating Mode	CTX
1	Adapter mode

The Worst Case Mode for Following Conformance Tests	
Tests Item	DTS Bandwidth Maximum Conducted Output Power Power Spectral Density Emissions in Non-restricted Frequency Bands
Test Condition	Conducted measurement at transmit chains

The Worst Case Mode for Following Conformance Tests			
Tests Item	Emissions in Restricted Frequency Bands		
Test Condition	Radiated measurement If EUT consist of multiple antenna assembly (multiple antenna are used in EUT regardless of spatial multiplexing MIMO configuration), the radiated test should be performed with highest antenna gain of each antenna type.		
Operating Mode < 1GHz	CTX		
1	Adapter mode		
Operating Mode > 1GHz	CTX		
Orthogonal Planes of EUT	X Plane	Y Plane	Z Plane
			
Worst Planes of EUT		V	

2.4 Support Equipment

Support Equipment - RF Conducted				
No.	Equipment	Brand Name	Model Name	FCC ID
1	Notebook	DELL	E5410	DOC
2	Adapter for NB	DELL	HA65NM130	DOC
3	AC Source	GW	APS-9102	-

2.5 Test Setup Diagram

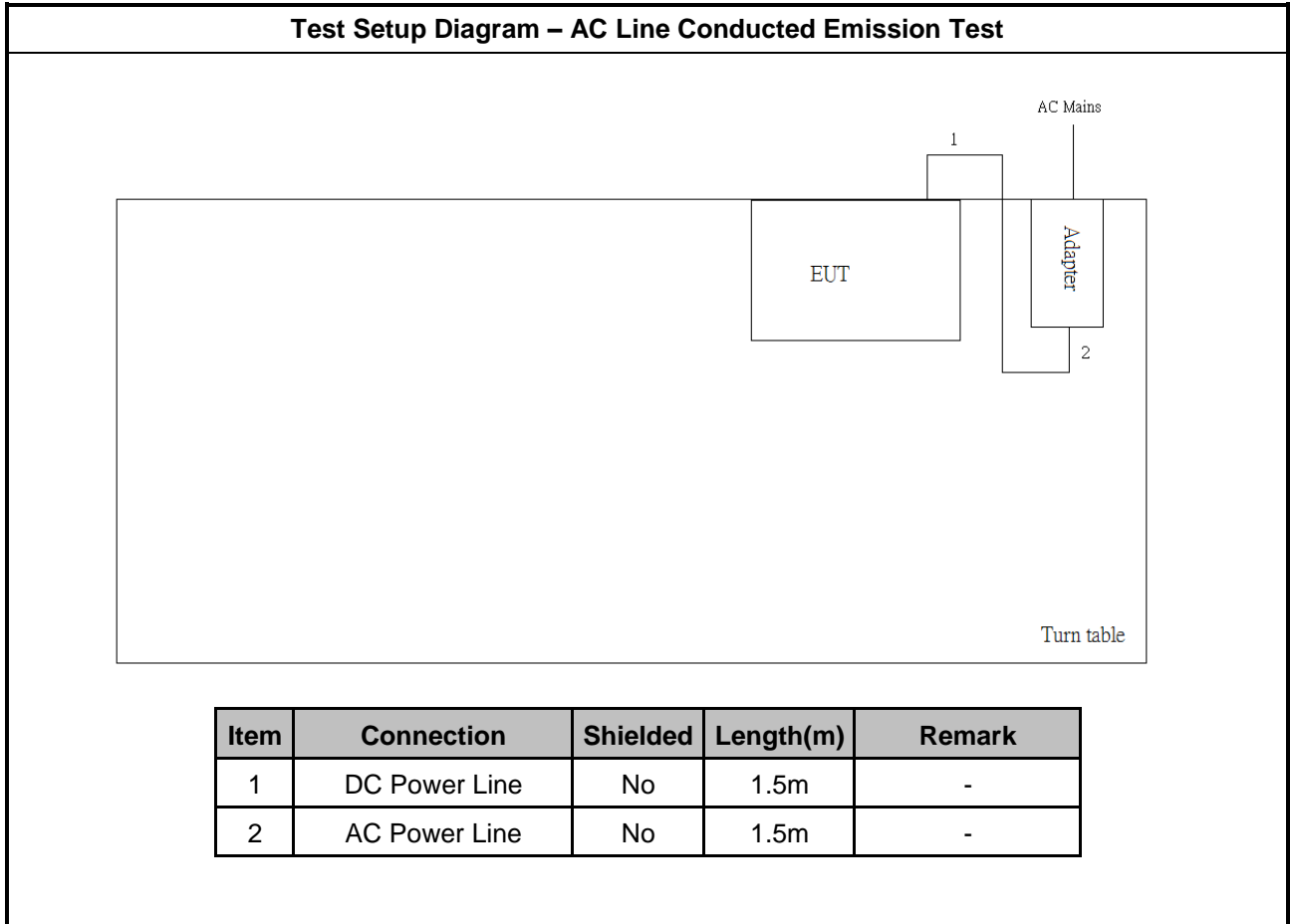

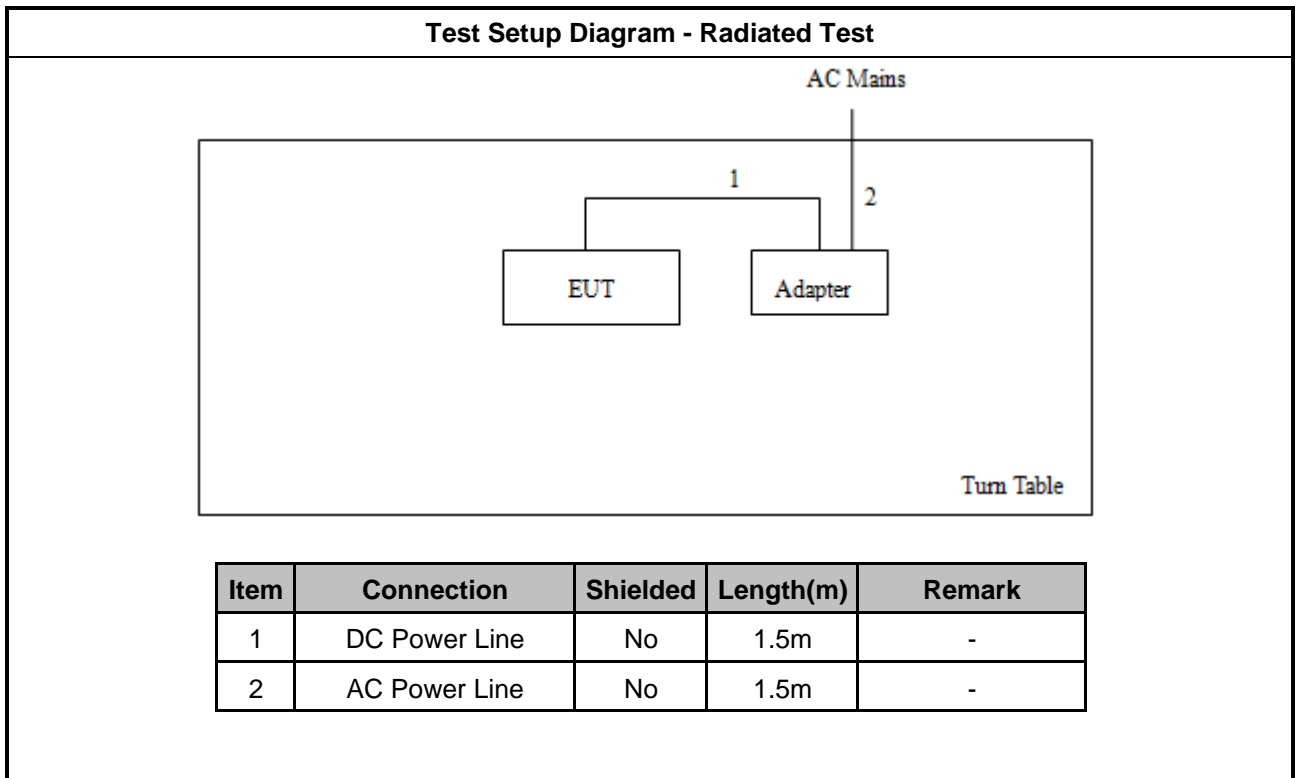

3 Transmitter Test Result

3.1 AC Power-line Conducted Emissions

3.1.1 AC Power-line Conducted Emissions Limit

AC Power-line Conducted Emissions Limit		
Frequency Emission (MHz)	Quasi-Peak	Average
0.15-0.5	66 - 56 *	56 - 46 *
0.5-5	56	46
5-30	60	50

Note 1: * Decreases with the logarithm of the frequency.

3.1.2 Measuring Instruments

Refer a test equipment and calibration data table in this test report.

3.1.3 Test Procedures

Test Method
<ul style="list-style-type: none"> Refer as ANSI C63.10-2013, clause 6.2 foray power-line conducted emissions.

3.1.4 Test Setup

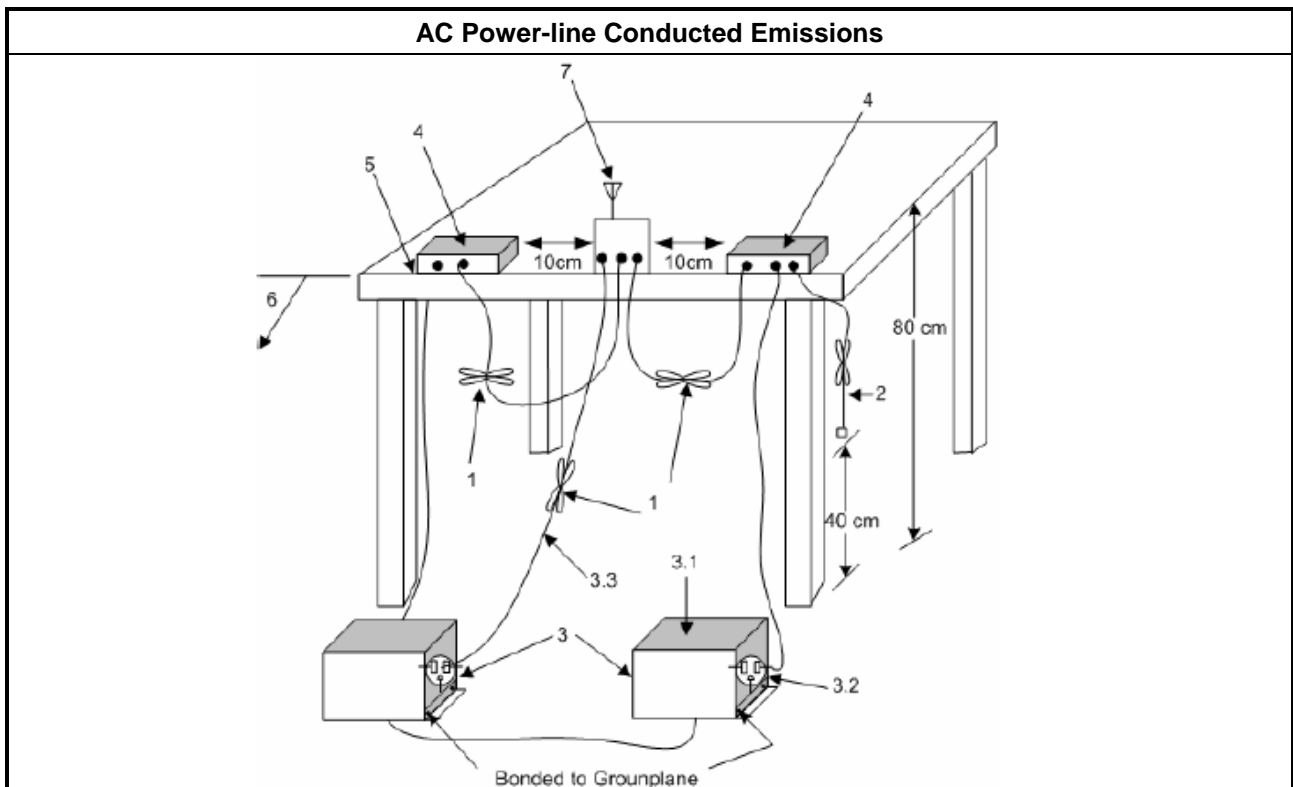



3.1.5 Test Result of AC Power-line Conducted Emissions

Refer as Appendix A

3.2 DTS Bandwidth

3.2.1 6dB Bandwidth Limit

6dB Bandwidth Limit
Systems using digital modulation techniques:
<ul style="list-style-type: none"> ▪ 6 dB bandwidth \geq 500 kHz.

3.2.2 Measuring Instruments

Refer a test equipment and calibration data table in this test report.

3.2.3 Test Procedures

Test Method
<ul style="list-style-type: none"> ▪ For the emission bandwidth shall be measured using one of the options below:
<input checked="" type="checkbox"/> Refer as KDB 558074, clause 8.1 Option 1 for 6 dB bandwidth measurement.
<input type="checkbox"/> Refer as KDB 558074, clause 8.2 Option 2 for 6 dB bandwidth measurement.
<input type="checkbox"/> Refer as ANSI C63.10, clause 6.9.3 for occupied bandwidth testing.

3.2.4 Test Setup

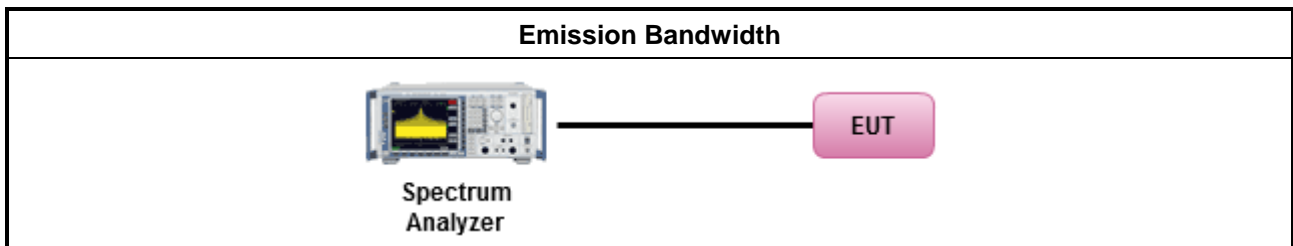

3.2.5 Test Result of Emission Bandwidth

Refer as Appendix B

3.3 Maximum Conducted Output Power

3.3.1 Maximum Conducted Output Power Limit

Maximum Conducted Output Power Limit	
	<ul style="list-style-type: none"> ▪ If $G_{TX} \leq 6$ dBi, then $P_{Out} \leq 30$ dBm (1 W)
	<ul style="list-style-type: none"> ▪ Point-to-multipoint systems (P2M): If $G_{TX} > 6$ dBi, then $P_{Out} = 30 - (G_{TX} - 6)$ dBm
	<ul style="list-style-type: none"> ▪ Point-to-point systems (P2P): If $G_{TX} > 6$ dBi, then $P_{Out} = 30 - (G_{TX} - 6)/3$ dBm
	<ul style="list-style-type: none"> ▪ Smart antenna system (SAS):
	<ul style="list-style-type: none"> - Single beam: If $G_{TX} > 6$ dBi, then $P_{Out} = 30 - (G_{TX} - 6)/3$ dBm
	<ul style="list-style-type: none"> - Overlap beam: If $G_{TX} > 6$ dBi, then $P_{Out} = 30 - (G_{TX} - 6)/3$ dBm
	<ul style="list-style-type: none"> - Aggregate power on all beams: If $G_{TX} > 6$ dBi, then $P_{Out} = 30 - (G_{TX} - 6)/3 + 8$ dB dBm
e.i.r.p. Power Limit:	
	<ul style="list-style-type: none"> ▪ 2400-2483.5 MHz Band
	<ul style="list-style-type: none"> ▪ Point-to-multipoint systems (P2M): $P_{eirp} \leq 36$ dBm (4 W)
	<ul style="list-style-type: none"> ▪ Point-to-point systems (P2P): $P_{eirp} \leq \text{MAX}(36, [P_{Out} + G_{TX}])$ dBm
	<ul style="list-style-type: none"> ▪ Smart antenna system (SAS)
	<ul style="list-style-type: none"> - Single beam: $P_{eirp} \leq \text{MAX}(36, P_{Out} + G_{TX})$ dBm
	<ul style="list-style-type: none"> - Overlap beam: $P_{eirp} \leq \text{MAX}(36, P_{Out} + G_{TX})$ dBm
	<ul style="list-style-type: none"> - Aggregate power on all beams: $P_{eirp} \leq \text{MAX}(36, [P_{Out} + G_{TX} + 8])$ dBm
P_{Out} = maximum peak conducted output power or maximum conducted output power in dBm, G_{TX} = the maximum transmitting antenna directional gain in dBi.	

3.3.2 Measuring Instruments

Refer a test equipment and calibration data table in this test report.

3.3.3 Test Procedures

Test Method	
<ul style="list-style-type: none"> ▪ Maximum Peak Conducted Output Power 	
<input type="checkbox"/>	Refer as KDB 558074, clause 9.1.1 Option 1 (RBW ≥ EBW method).
<input type="checkbox"/>	Refer as KDB 558074, clause 9.1.2 Option 2 (integrated band power method)
<input type="checkbox"/>	Refer as KDB 558074, clause 9.1.3 Option 3 (peak power meter for VBW ≥ DTS BW)
<ul style="list-style-type: none"> ▪ Maximum Average Conducted Output Power 	
Duty cycle ≥ 98%	
<input type="checkbox"/>	Refer as KDB 558074, clause 9.2.2.4 Method AVGSA-2 (spectral trace averaging).
Duty cycle < 98%	
<input type="checkbox"/>	Refer as KDB 558074, clause 9.2.2.5 Method AVGSA-2 Alt. (slow sweep speed)
RF power meter and average over on/off periods with duty factor or gated trigger	
<input checked="" type="checkbox"/>	Refer as KDB 558074, clause 9.2.3.1 Method AVGPM (using an RF average power meter).
<ul style="list-style-type: none"> ▪ For conducted measurement. 	
<ul style="list-style-type: none"> ▪ If the EUT supports multiple transmit chains using options given below: Refer as KDB 662911, In-band power measurements. Using the measure-and-sum approach, measured all transmit ports individually. Sum the power (in linear power units e.g., mW) of all ports for each individual sample and save them. 	
<ul style="list-style-type: none"> ▪ If multiple transmit chains, EIRP calculation could be following as methods: $P_{total} = P_1 + P_2 + \dots + P_n$ (calculated in linear unit [mW] and transfer to log unit [dBm]) $EIRP_{total} = P_{total} + DG$ 	

3.3.4 Test Setup

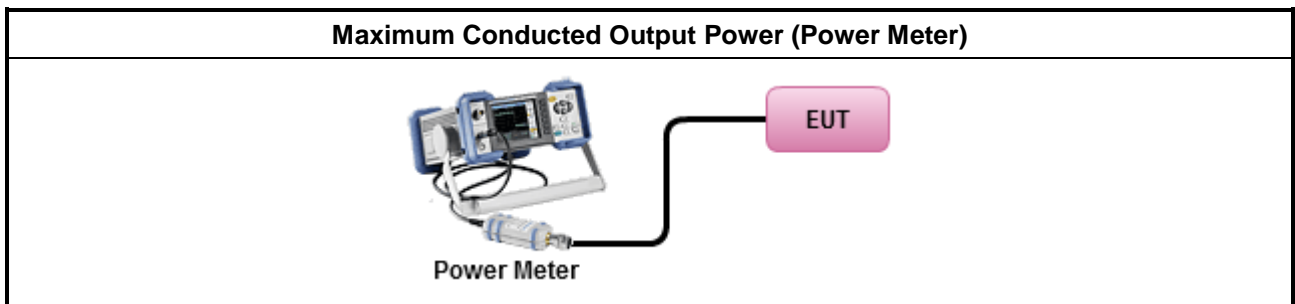

3.3.5 Test Result of Maximum Conducted Output Power

Refer as Appendix C

3.4 Power Spectral Density

3.4.1 Power Spectral Density Limit

Power Spectral Density Limit
<ul style="list-style-type: none"> Power Spectral Density (PSD) ≤ 8 dBm/3kHz

3.4.2 Measuring Instruments

Refer a test equipment and calibration data table in this test report.

3.4.3 Test Procedures

Test Method
<ul style="list-style-type: none"> Peak power spectral density procedures that the same method as used to determine the conducted output power. If maximum peak conducted output power was measured to demonstrate compliance to the output power limit, then the peak PSD procedure below (Method PKPSD) shall be used. If maximum conducted output power was measured to demonstrate compliance to the output power limit, then one of the average PSD procedures shall be used, as applicable based on the following criteria (the peak PSD procedure is also an acceptable option).
<input checked="" type="checkbox"/> Refer as KDB 558074, clause 10.2 Method PKPSD (RBW=3-100kHz; Detector=peak).
<ul style="list-style-type: none"> For conducted measurement. <ul style="list-style-type: none"> If The EUT supports multiple transmit chains using options given below: <ul style="list-style-type: none"> Measure and sum the spectra across the outputs. Refer as KDB 662911, In-band power spectral density (PSD). Sample all transmit ports simultaneously using a spectrum analyzer for each transmit port. Where the trace bin-by-bin of each transmit port summing can be performed. (i.e., in the first spectral bin of output 1 is summed with that in the first spectral bin of output 2 and that from the first spectral bin of output 3, and so on up to the NTX output to obtain the value for the first frequency bin of the summed spectrum.). Add up the amplitude (power) values for the different transmit chains and use this as the new data trace.

3.4.4 Test Setup

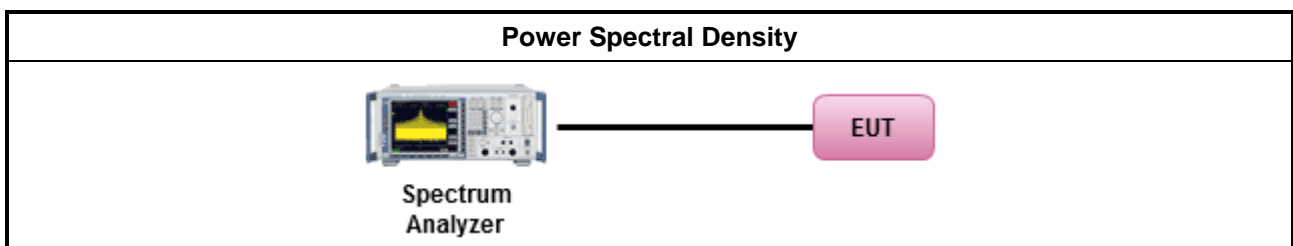

3.4.5 Test Result of Power Spectral Density

Refer as Appendix D

3.5 Emissions in Non-restricted Frequency Bands

3.5.1 Emissions in Non-restricted Frequency Bands Limit

Un-restricted Band Emissions Limit	
RF output power procedure	Limit (dB)
Peak output power procedure	20
Average output power procedure	30

Note 1: If the peak output power procedure is used to measure the fundamental emission power to demonstrate compliance to requirements, then the peak conducted output power measured within any 100 kHz outside the authorized frequency band shall be attenuated by at least 20 dB relative to the maximum measured in-band peak PSD level.

Note 2: If the average output power procedure is used to measure the fundamental emission power to demonstrate compliance to requirements, then the power in any 100 kHz outside of the authorized frequency band shall be attenuated by at least 30 dB relative to the maximum measured in-band average PSD level.

3.5.2 Measuring Instruments

Refer a test equipment and calibration data table in this test report.

3.5.3 Test Procedures

Test Method
<ul style="list-style-type: none"> Refer as KDB 558074, clause 11 for unwanted emissions into non-restricted bands.

3.5.4 Test Setup

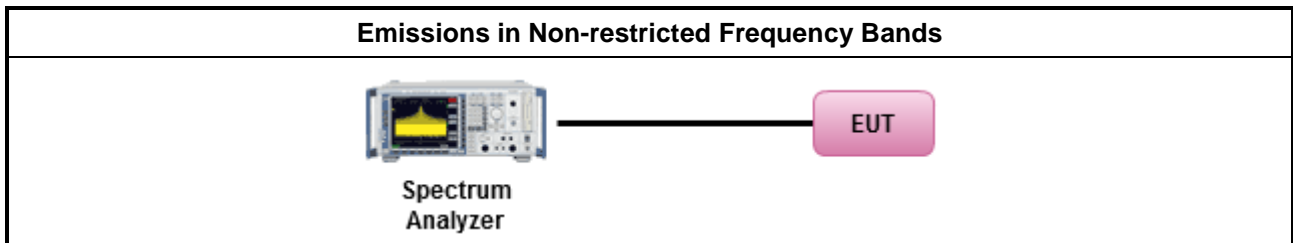

3.5.5 Test Result of Emissions in Non-restricted Frequency Bands

Refer as Appendix E

3.6 Emissions in Restricted Frequency Bands

3.6.1 Emissions in Restricted Frequency Bands Limit

Restricted Band Emissions Limit			
Frequency Range (MHz)	Field Strength (uV/m)	Field Strength (dBuV/m)	Measure Distance (m)
0.009~0.490	2400/F(kHz)	48.5 - 13.8	300
0.490~1.705	24000/F(kHz)	33.8 - 23	30
1.705~30.0	30	29	30
30~88	100	40	3
88~216	150	43.5	3
216~960	200	46	3
Above 960	500	54	3

Note 1: Test distance for frequencies at or above 30 MHz, measurements may be performed at a distance other than the limit distance provided they are not performed in the near field and the emissions to be measured can be detected by the measurement equipment. When performing measurements at a distance other than that specified, the results shall be extrapolated to the specified distance using an extrapolation factor of 20 dB/decade (inverse of linear distance for field-strength measurements, inverse of linear distance-squared for power-density measurements).

Note 2: Test distance for frequencies at below 30 MHz, measurements may be performed at a distance closer than the EUT limit distance; however, an attempt should be made to avoid making measurements in the near field. When performing measurements below 30 MHz at a closer distance than the limit distance, the results shall be extrapolated to the specified distance by either making measurements at a minimum of two or more distances on at least one radial to determine the proper extrapolation factor or by using the square of an inverse linear distance extrapolation factor (40 dB / decade). The test report shall specify the extrapolation method used to determine compliance of the EUT.

Note 3: Using the distance of 1m during the test for above 18 GHz, and the test value to correct for the distance factor at 3m.

3.6.2 Measuring Instruments

Refer a test equipment and calibration data table in this test report.

3.6.3 Test Procedures

Test Method	
<ul style="list-style-type: none"> ▪ The average emission levels shall be measured in [duty cycle \geq 98 or duty factor]. 	
<ul style="list-style-type: none"> ▪ Refer as ANSI C63.10, clause 6.10.3 band-edge testing shall be performed at the lowest frequency channel and highest frequency channel within the allowed operating band. 	
<ul style="list-style-type: none"> ▪ For the transmitter unwanted emissions shall be measured using following options below: 	
<ul style="list-style-type: none"> ▪ Refer as KDB 558074, clause 12 for unwanted emissions into restricted bands. 	
	<input checked="" type="checkbox"/> Refer as KDB 558074, clause 12.2.5.3 (ANSI C63.10, clause 4.1.4.2.3), Reduced VBW \geq 1/T.
	<input checked="" type="checkbox"/> Refer as KDB 558074, clause 12.2.4 measurement procedure peak limit.
<ul style="list-style-type: none"> ▪ For the transmitter band-edge emissions shall be measured using following options below: 	
<ul style="list-style-type: none"> ▪ Refer as KDB 558074 clause 13.1, When the performing peak or average radiated measurements, emissions within 2 MHz of the authorized band edge may be measured using the marker-delta method described below. 	
<ul style="list-style-type: none"> ▪ Refer as KDB 558074, clause 13.2 (ANSI C63.10, clause 6.10.6) for marker-delta method for band-edge measurements. 	
<ul style="list-style-type: none"> ▪ Refer as KDB 558074, clause 13.3 for narrower resolution bandwidth (100kHz) using the band power and summing the spectral levels (i.e., 1 MHz). 	
<ul style="list-style-type: none"> ▪ For conducted and cabinet radiation measurement, refer as KDB 558074, clause 12.2.2. 	
<ul style="list-style-type: none"> ▪ For conducted unwanted emissions into restricted bands (absolute emission limits). Devices with multiple transmit chains using options given below: (1) Measure and sum the spectra across the outputs or (2) Measure and add 10 log(N) dB 	
<ul style="list-style-type: none"> ▪ For KDB 662911 The methodology described here may overestimate array gain, thereby resulting in apparent failures to satisfy the out-of-band limits even if the device is actually compliant. In such cases, compliance may be demonstrated by performing radiated tests around the frequencies at which the apparent failures occurred. 	

3.6.4 Test Setup

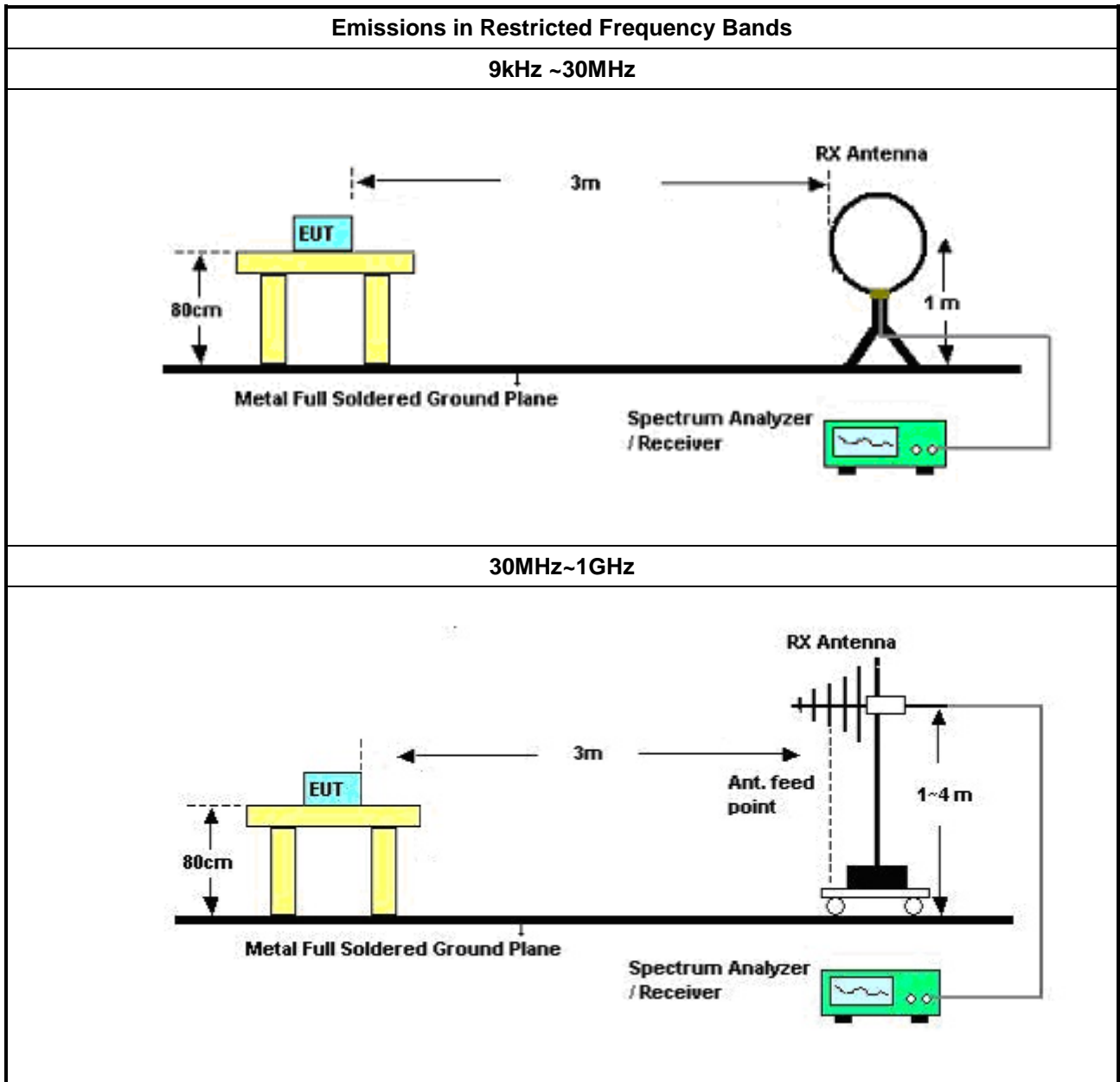

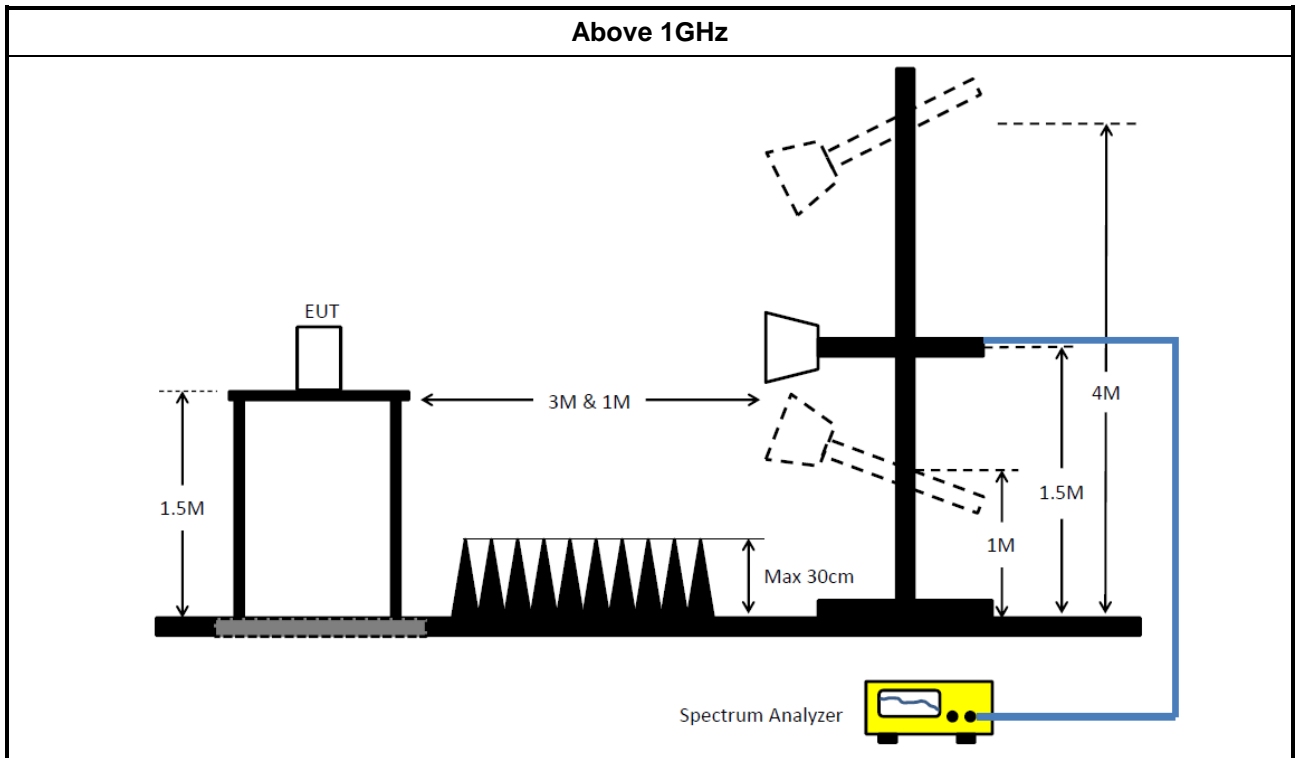

3.6.5 Test Result of Emissions in Restricted Frequency Bands (Below 30MHz)

The amplitude of spurious emissions which are attenuated by more than 20dB below the permissible value has no need to be reported.

3.6.6 Test Result of Emissions in Restricted Frequency Bands

Refer as Appendix F



4 Test Equipment and Calibration Data

Instrument for AC Conduction

Instrument	Manufacturer	Model No.	Serial No.	Spec.	Calibration Date	Calibration Due Date
EMC Receiver	R&S	ESR3	102052	9KHz ~ 3.6GHz	29/Apr/2017	28/Apr/2018
LISN	R&S	ENV216	101295	9kHz ~ 30MHz	17/Nov/2017	16/Nov/2018
RF Cable-CON	HUBER+SUHNER	RG213/U	0761183202000 1	9kHz ~ 30MHz	06/Oct/2017	05/Oct/2018
AC POWER	APC	AFC-11005G	F310050055	47Hz~63Hz 5~300V	NCR	NCR
Impuls Begrenzer Puls e Limiter	SCHWARZBECK	VTSD 9561-F	9561-F041	9 kHz ~ 30 MHz	12/Oct/2017	11/Oct/2018

NCR : Non-Calibration Require

Instrument for Conducted Test

Instrument	Manufacturer	Model No.	Serial No.	Spec.	Calibration Date	Calibration Due Date
Spectrum Analyzer	R&S	FSV 40	101013	9kHz~40GHz	29/Dec/2017	28/Dec/2018
Signal Generator	R&S	SMR40	100116	10MHz ~ 40GHz	27/Jul/2017	26/Jul/2018
Power Sensor	Anritsu	MA2411B	0917017	300MHz ~ 40GHz	05/Feb/2018	04/Feb/2019
Power Meter	Anritsu	ML2495A	0949003	300MHz ~ 40GHz	05/Feb/2018	04/Feb/2019
RF Cable-0.2m	HUBER+SUHNER	SUCOFLEX_10 4	MY10709/4	30MHz ~ 26.5GHz	25/Aug/2017	24/Aug/2018
RF Cable-0.2m	HUBER+SUHNER	SUCOFLEX_10 4	MY10712/4	30MHz ~ 26.5GHz	25/Aug/2017	24/Aug/2018
RF Cable-0.5m	HUBER+SUHNER	SUCOFLEX_10 4	MY10713/4	30MHz ~ 26.5GHz	25/Aug/2017	24/Aug/2018

**Instrument for Radiated Test**

Instrument	Manufacturer	Model No.	Serial No.	Spec.	Calibration Date	Calibration Due Date
Spectrum Analyzer	R&S	FSP40	100305	9KHz - 40GHz	12/Dec/2017	11/Dec/2018
3m Semi Anechoic	SIDT FRANKONIA	SAC-3M	03CH02-HY	30MHz-1GHz	20/Oct/2017	19/Oct/2018
3m Semi Anechoic	SIDT FRANKONIA	SAC-3M	03CH02-HY	1GHz ~ 18GHz	27/Oct/2017	26/Oct/2018
Amplifier	Agilent	8447D	2944A11149	100KHz-1.3GHz	29/Jun/2017	28/Jun/2018
Amplifier	Ketsight	8449B	3008A02602	1GHz-26.5GHz	19/Sep/2017	18/Sep/2018
Horn Antenna	SCHWARZBECK	BBHA9120D	BBHA9120D 01531	1GHz-18GHz	11/May/2017	10/May/2018
Horn Antenna	SCHWARZBECK	BBHA9170	BBHA9170154	18GHz-40GHz	06/Feb/2018	05/Feb/2019
Bilog Antenna	SCHAFFNER	CBL6112B	2723	30MHz-1GHz	09/Sep/2017	08/Sep/2018
Loop Antenna	TESEQ	HLA 6120	31244	9KHz-30MHz	16/Mar/2018	15/Mar/2019
RF Cable-high	SUHNER	SUCOFLEX104	MY34918/4	1GHz ~ 40GHz	19/Jan/2018	18/Jan/2019
RF Cable-R03m	Jye Bao	RG142	CB017	9kHz ~ 1GHz	19/Jan/2018	18/Jan/2019
Receiver	R&S	ESU3	102052	9kHz ~ 3.6GHz	29/Apr/2017	28/Apr/2018



AC Power-line Conducted Emissions Result

Operating Mode	1	Power Phase	Neutral
Operating Function	Adapter Mode		

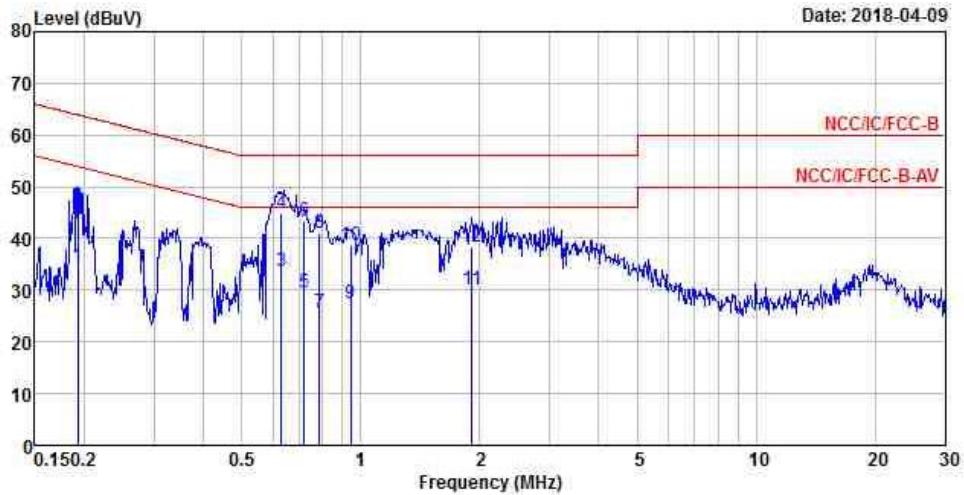

	Freq	Level	Over Limit	Limit Line	Read Level	LISN Factor	Cable Loss	Remark
	MHz	dBuV	dB	dBuV	dBuV	dB	dB	
1	0.1924	34.45	-19.48	53.93	24.82	9.62	0.01	Average
2	0.1924	45.98	-17.95	63.93	36.35	9.62	0.01	QP
3	0.6305	33.66	-12.34	46.00	24.00	9.61	0.05	Average
4 MAX	0.6305	44.96	-11.04	56.00	35.30	9.61	0.05	QP
5	0.7198	29.59	-16.41	46.00	19.93	9.62	0.04	Average
6	0.7198	43.41	-12.59	56.00	33.75	9.62	0.04	QP
7	0.7876	25.63	-20.37	46.00	15.98	9.62	0.03	Average
8	0.7876	41.11	-14.89	56.00	31.46	9.62	0.03	QP
9	0.9431	27.32	-18.68	46.00	17.69	9.62	0.01	Average
10	0.9431	38.70	-17.30	56.00	29.07	9.62	0.01	QP
11	1.9080	30.02	-15.98	46.00	20.39	9.63	0.00	Average
12	1.9080	38.49	-17.51	56.00	28.86	9.63	0.00	QP

Note 1: ">20dB" means emission levels that exceed the level of 20 dB below the applicable limit.
 Note 2: "N/F" means Nothing Found emissions (No emissions were detected.)

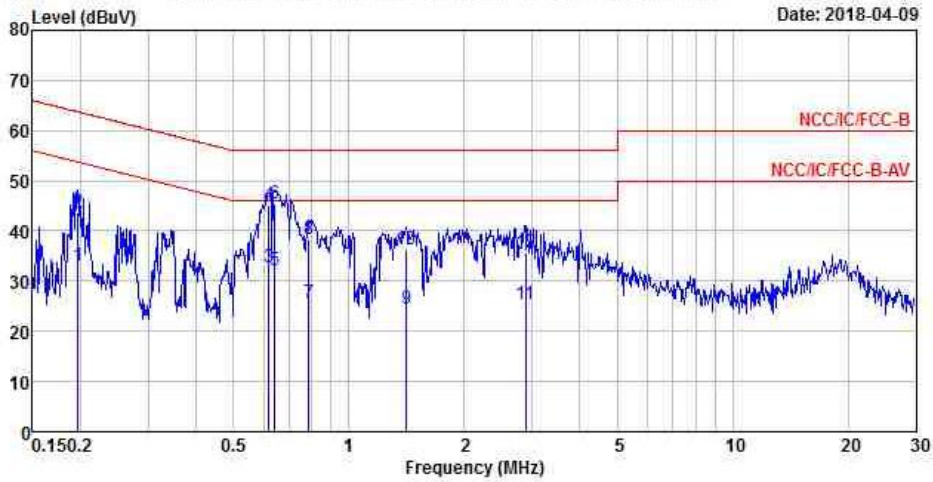

AC Power-line Conducted Emissions Result																																																																																																																																	
Operating Mode	1	Power Phase	Line																																																																																																																														
Operating Function	Adapter Mode																																																																																																																																
 <p style="text-align: right; font-size: small;">Date: 2018-04-09</p>																																																																																																																																	
<table border="1" style="width: 100%; border-collapse: collapse; font-size: x-small;"> <thead> <tr> <th></th> <th>Freq</th> <th>Level</th> <th>Over Limit</th> <th>Limit Line</th> <th>Read Level</th> <th>LISN Factor</th> <th>Cable Loss</th> <th>Remark</th> </tr> <tr> <th></th> <th>MHz</th> <th>dBuV</th> <th>dB</th> <th>dBuV</th> <th>dBuV</th> <th>dB</th> <th>dB</th> <th></th> </tr> </thead> <tbody> <tr><td>1</td><td>0.1965</td><td>32.94</td><td>-20.82</td><td>53.76</td><td>23.32</td><td>9.62</td><td>0.00</td><td>Average</td></tr> <tr><td>2</td><td>0.1965</td><td>43.60</td><td>-20.16</td><td>63.76</td><td>33.98</td><td>9.62</td><td>0.00</td><td>QP</td></tr> <tr><td>3</td><td>0.6186</td><td>32.89</td><td>-13.11</td><td>46.00</td><td>23.23</td><td>9.61</td><td>0.05</td><td>Average</td></tr> <tr><td>4</td><td>0.6186</td><td>45.09</td><td>-10.91</td><td>56.00</td><td>35.43</td><td>9.61</td><td>0.05</td><td>QP</td></tr> <tr><td>5</td><td>0.6406</td><td>32.07</td><td>-13.93</td><td>46.00</td><td>22.41</td><td>9.61</td><td>0.05</td><td>Average</td></tr> <tr style="background-color: #e0e0e0;"><td>6 MAX</td><td>0.6406</td><td>45.38</td><td>-10.62</td><td>56.00</td><td>35.72</td><td>9.61</td><td>0.05</td><td>QP</td></tr> <tr><td>7</td><td>0.7876</td><td>25.63</td><td>-20.37</td><td>46.00</td><td>15.99</td><td>9.61</td><td>0.03</td><td>Average</td></tr> <tr><td>8</td><td>0.7876</td><td>38.48</td><td>-17.52</td><td>56.00</td><td>28.84</td><td>9.61</td><td>0.03</td><td>QP</td></tr> <tr><td>9</td><td>1.4107</td><td>24.48</td><td>-21.52</td><td>46.00</td><td>14.87</td><td>9.61</td><td>0.00</td><td>Average</td></tr> <tr><td>10</td><td>1.4107</td><td>36.44</td><td>-19.56</td><td>56.00</td><td>26.83</td><td>9.61</td><td>0.00</td><td>QP</td></tr> <tr><td>11</td><td>2.8845</td><td>25.41</td><td>-20.59</td><td>46.00</td><td>15.73</td><td>9.63</td><td>0.05</td><td>Average</td></tr> <tr><td>12</td><td>2.8845</td><td>35.61</td><td>-20.39</td><td>56.00</td><td>25.93</td><td>9.63</td><td>0.05</td><td>QP</td></tr> </tbody> </table>					Freq	Level	Over Limit	Limit Line	Read Level	LISN Factor	Cable Loss	Remark		MHz	dBuV	dB	dBuV	dBuV	dB	dB		1	0.1965	32.94	-20.82	53.76	23.32	9.62	0.00	Average	2	0.1965	43.60	-20.16	63.76	33.98	9.62	0.00	QP	3	0.6186	32.89	-13.11	46.00	23.23	9.61	0.05	Average	4	0.6186	45.09	-10.91	56.00	35.43	9.61	0.05	QP	5	0.6406	32.07	-13.93	46.00	22.41	9.61	0.05	Average	6 MAX	0.6406	45.38	-10.62	56.00	35.72	9.61	0.05	QP	7	0.7876	25.63	-20.37	46.00	15.99	9.61	0.03	Average	8	0.7876	38.48	-17.52	56.00	28.84	9.61	0.03	QP	9	1.4107	24.48	-21.52	46.00	14.87	9.61	0.00	Average	10	1.4107	36.44	-19.56	56.00	26.83	9.61	0.00	QP	11	2.8845	25.41	-20.59	46.00	15.73	9.63	0.05	Average	12	2.8845	35.61	-20.39	56.00	25.93	9.63	0.05	QP
	Freq	Level	Over Limit	Limit Line	Read Level	LISN Factor	Cable Loss	Remark																																																																																																																									
	MHz	dBuV	dB	dBuV	dBuV	dB	dB																																																																																																																										
1	0.1965	32.94	-20.82	53.76	23.32	9.62	0.00	Average																																																																																																																									
2	0.1965	43.60	-20.16	63.76	33.98	9.62	0.00	QP																																																																																																																									
3	0.6186	32.89	-13.11	46.00	23.23	9.61	0.05	Average																																																																																																																									
4	0.6186	45.09	-10.91	56.00	35.43	9.61	0.05	QP																																																																																																																									
5	0.6406	32.07	-13.93	46.00	22.41	9.61	0.05	Average																																																																																																																									
6 MAX	0.6406	45.38	-10.62	56.00	35.72	9.61	0.05	QP																																																																																																																									
7	0.7876	25.63	-20.37	46.00	15.99	9.61	0.03	Average																																																																																																																									
8	0.7876	38.48	-17.52	56.00	28.84	9.61	0.03	QP																																																																																																																									
9	1.4107	24.48	-21.52	46.00	14.87	9.61	0.00	Average																																																																																																																									
10	1.4107	36.44	-19.56	56.00	26.83	9.61	0.00	QP																																																																																																																									
11	2.8845	25.41	-20.59	46.00	15.73	9.63	0.05	Average																																																																																																																									
12	2.8845	35.61	-20.39	56.00	25.93	9.63	0.05	QP																																																																																																																									
<p>Note 1: ">20dB" means emission levels that exceed the level of 20 dB below the applicable limit. Note 2: "N/F" means Nothing Found emissions (No emissions were detected.)</p>																																																																																																																																	



Summary

Mode	Max-N dB (Hz)	Max-OBW (Hz)	ITU-Code	Min-N dB (Hz)	Min-OBW (Hz)
2.4-2.4835GHz	-	-	-	-	-
BT-LE(1Mbps)	663.75k	1.034M	1M03F1D	660k	1.027M

Max-N dB = Maximum 6dB down bandwidth; **Max-OBW** = Maximum 99% occupied bandwidth;
Min-N dB = Minimum 6dB down bandwidth; **Min-OBW** = Minimum 99% occupied bandwidth;

Result

Mode	Result	Limit (Hz)	Port 1-N dB (Hz)	Port 1-OBW (Hz)
BT-LE(1Mbps)	-	-	-	-
2402MHz_TnomVnom	Pass	500k	661.25k	1.034M
2440MHz_TnomVnom	Pass	500k	660k	1.032M
2480MHz_TnomVnom	Pass	500k	663.75k	1.027M

Port X-N dB = Port X 6dB down bandwidth; **Port X-OBW** = Port X 99% occupied bandwidth;

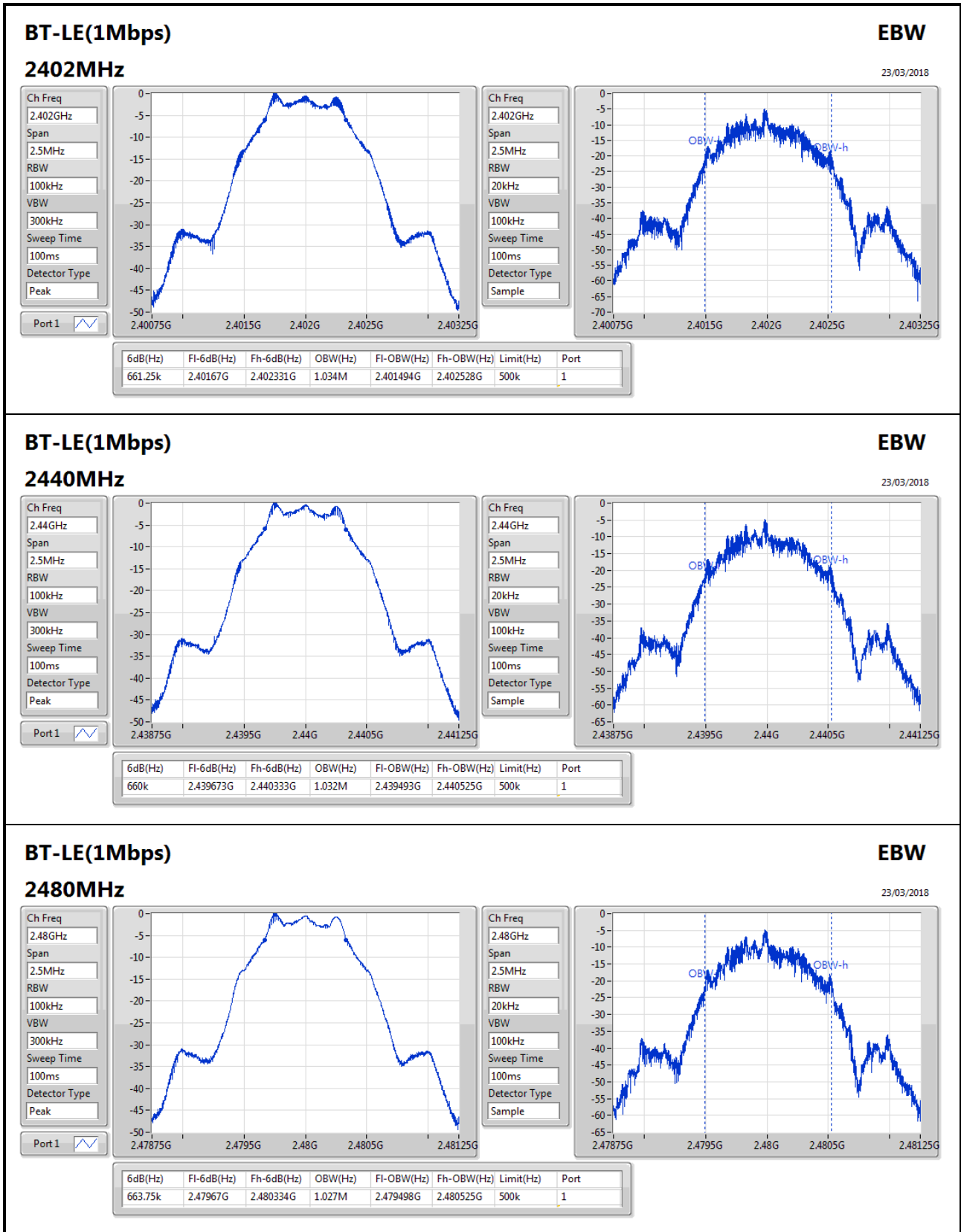
BT-LE(1Mbps)
EBW

23/03/2018

2480MHz

Ch Freq: 2.48GHz
Span: 2.5MHz
RBW: 100kHz
VBW: 300kHz
Sweep Time: 100ms
Detector Type: Peak

Port 1

Ch Freq: 2.48GHz
Span: 2.5MHz
RBW: 20kHz
VBW: 100kHz
Sweep Time: 100ms
Detector Type: Sample



Summary

Mode	Power (dBm)	Power (W)
2.4-2.4835GHz	-	-
BT-LE(1Mbps)	-0.56	0.00088

Result

Mode	Result	Gain (dBi)	Power (dBm)	Power Limit (dBm)
BT-LE(1Mbps)	-	-	-	-
2402MHz_TnomVnom	Pass	-1.20	-0.60	30.00
2440MHz_TnomVnom	Pass	-1.20	-0.56	30.00
2480MHz_TnomVnom	Pass	-1.20	-0.62	30.00



Summary

Mode	PD (dBm/RBW)
2.4-2.4835GHz	-
BT-LE(1Mbps)	-17.22

RBW=3kHz.

Result

Mode	Result	Gain (dBi)	PD (dBm/RBW)	PD Limit (dBm/RBW)
BT-LE(1Mbps)	-	-	-	-
2402MHz_TnomVnom	Pass	-1.20	-17.22	8.00
2440MHz_TnomVnom	Pass	-1.20	-17.81	8.00
2480MHz_TnomVnom	Pass	-1.20	-17.47	8.00

RBW=3kHz.

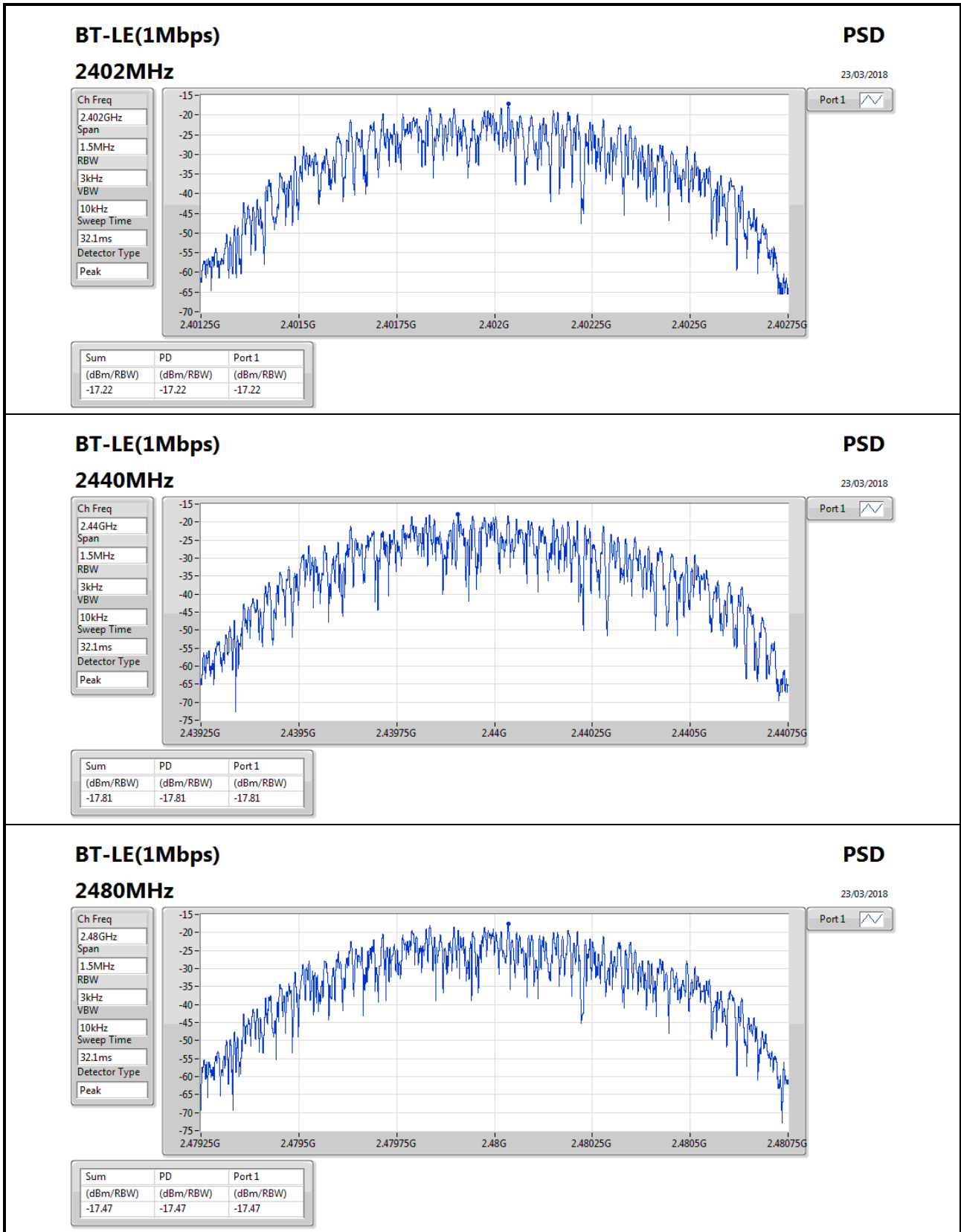

BT-LE(1Mbps)

2480MHz

PSD

23/03/2018

Ch Freq
2.48GHz

Span
1.5MHz

RBW
3kHz

VBW
10kHz

Sweep Time
32.1ms

Detector Type
Peak



Port 1

Sum	PD	Port 1
(dBm/RBW)	(dBm/RBW)	(dBm/RBW)
-17.47	-17.47	-17.47



Summary

Mode	Result	Ref (Hz)	Ref (dBm)	Limit (dBm)	Freq (Hz)	Level (dBm)	Freq (Hz)	Level (dBm)	Freq (Hz)	Level (dBm)	Freq (Hz)	Level (dBm)	Port
2.4-2.4835GHz	-	-	-	-	-	-	-	-	-	-	-	-	-
BT-LE(1Mbps)	Pass	2.439913G	-1.33	-31.33	2.122128G	-60.41	2.399972G	-59.44	2.48378G	-44.32	6.982771G	-52.68	1

Result

Mode	Result	Ref (Hz)	Ref (dBm)	Limit (dBm)	Freq (Hz)	Level (dBm)	Freq (Hz)	Level (dBm)	Freq (Hz)	Level (dBm)	Freq (Hz)	Level (dBm)	Port
BT-LE(1Mbps)	-	-	-	-	-	-	-	-	-	-	-	-	-
2402MHz_TnomVnom	Pass	2.439913G	-1.33	-31.33	2.308016G	-60.03	2.398G	-46.46	2.483708G	-58.91	6.971514G	-53.51	1
2440MHz_TnomVnom	Pass	2.439913G	-1.33	-31.33	1.78824G	-60.24	2.399804G	-59.27	2.483928G	-57.67	6.383323G	-54.01	1
2480MHz_TnomVnom	Pass	2.439913G	-1.33	-31.33	2.122128G	-60.41	2.399972G	-59.44	2.48378G	-44.32	6.982771G	-52.68	1

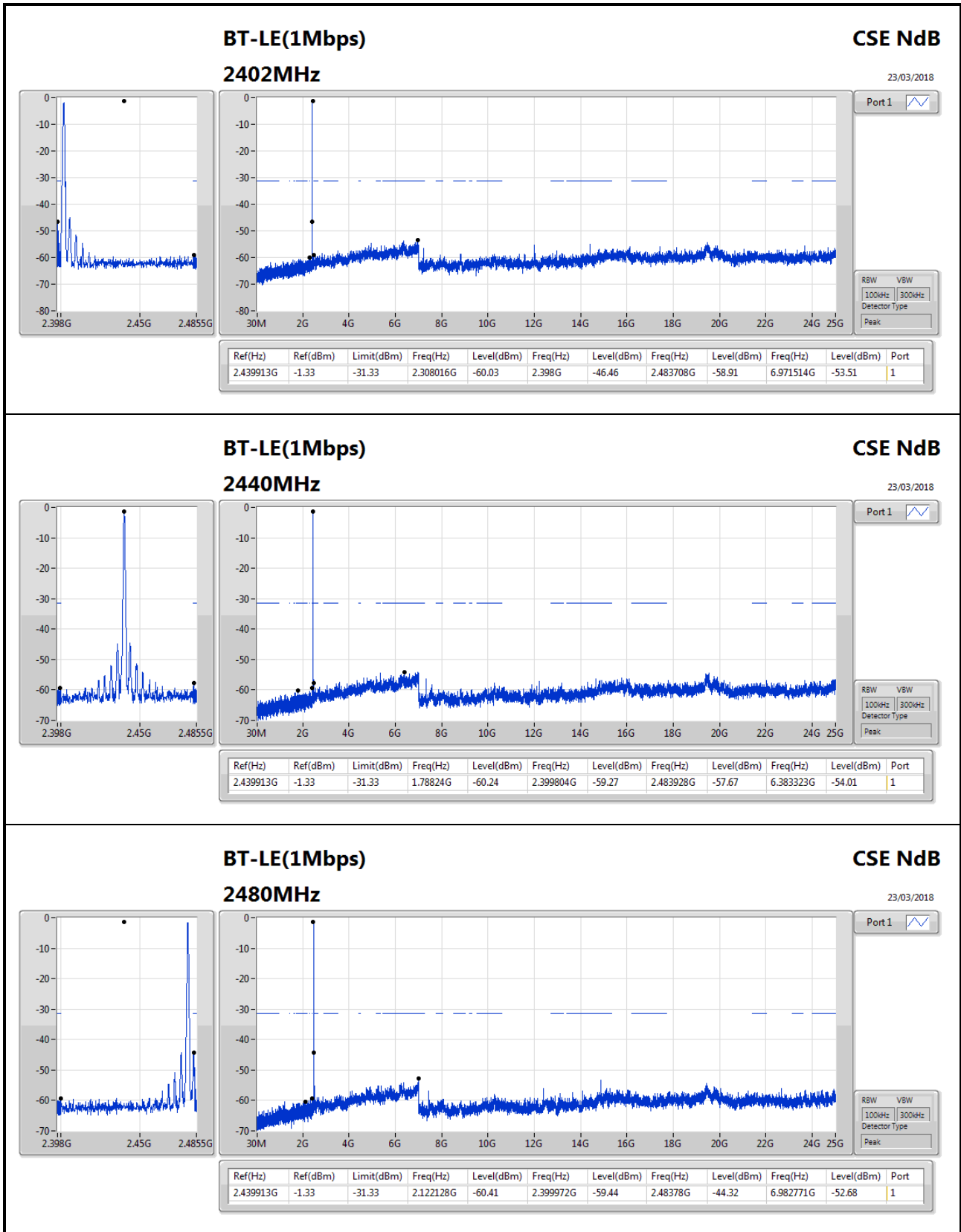



Summary

Mode	Result	Type	Freq (Hz)	Level (dBuV/m)	Limit (dBuV/m)	Margin (dB)	Factor (dB)	Dist (m)	Condition	Azimuth (°)	Height (m)	Comments
2.4-2.4835GHz	-	-	-	-	-	-	-	-	-	-	-	-
BT-LE(1Mbps)	Pass	PK	238.057971M	41.10	46.00	-4.90	-8.33	3	Horizontal	0	1.00	-





Result

Mode	Result	Type	Freq (Hz)	Level (dBuV/m)	Limit (dBuV/m)	Margin (dB)	Factor (dB)	Dist (m)	Condition	Azimuth (°)	Height (m)	Comments
BT-LE(1Mbps)	-	-	-	-	-	-	-	-	-	-	-	-
2440MHz	Pass	PK	30M	25.29	40.00	-14.71	-4.45	3	Horizontal	0	1.00	-
2440MHz	Pass	PK	238.057971M	41.10	46.00	-4.90	-8.33	3	Horizontal	0	1.00	-
2440MHz	Pass	PK	299.913043M	35.62	46.00	-10.38	-5.77	3	Horizontal	0	1.00	-
2440MHz	Pass	PK	437.681159M	39.68	46.00	-6.32	-3.08	3	Horizontal	0	1.00	-
2440MHz	Pass	PK	800.376812M	40.88	46.00	-5.12	1.25	3	Horizontal	0	1.00	-
2440MHz	Pass	PK	999.999M	48.86	54.00	-5.14	4.45	3	Horizontal	0	1.00	-
2440MHz	Pass	PK	32.811594M	26.95	40.00	-13.05	-5.76	3	Vertical	360	1.00	-
2440MHz	Pass	PK	90.449275M	29.52	43.50	-13.98	-12.27	3	Vertical	360	1.00	-
2440MHz	Pass	PK	239.463768M	30.65	46.00	-15.35	-8.14	3	Vertical	360	1.00	-
2440MHz	Pass	PK	380.043478M	40.62	46.00	-5.38	-4.44	3	Vertical	360	1.00	-
2440MHz	Pass	PK	455.956522M	40.35	46.00	-5.65	-2.84	3	Vertical	360	1.00	-
2440MHz	Pass	PK	999.999M	49.10	54.00	-4.90	4.45	3	Vertical	360	1.00	-

BT-LE(1Mbps)
2440MHz_adapter

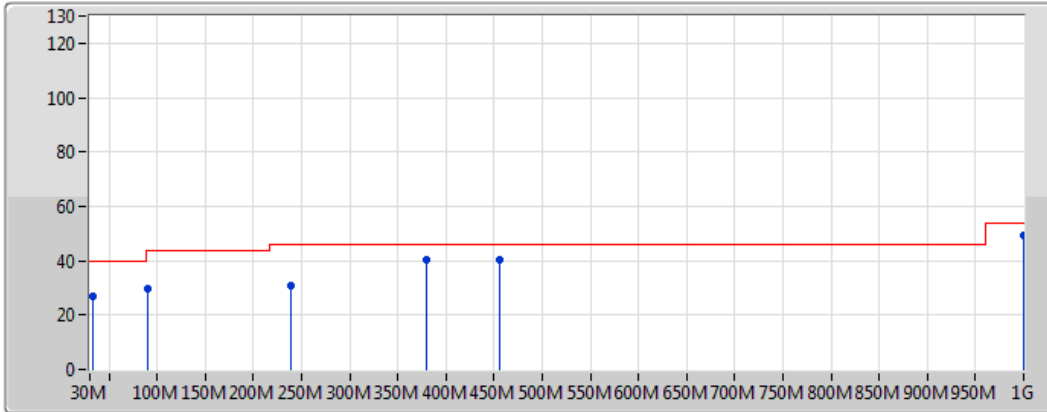
02/04/2018



Legend:
 Lim.PK 
 PK 

Type	Freq (Hz)	Level (dBuV/m)	Limit (dBuV/m)	Margin (dB)	Factor (dB)	Dist (m)	Condition	Azimuth (°)	Height (m)	Comments	Raw (dBuV)	AF (dB)	CL (dB)	PA (dB)
PK	32.811594M	26.95	40.00	-13.05	-5.76	3	Vertical	360	1.00	-	32.71	21.66	0.39	27.81
PK	90.449275M	29.52	43.50	-13.98	-12.27	3	Vertical	360	1.00	-	41.79	14.09	1.39	27.76
PK	239.463768M	30.65	46.00	-15.35	-8.14	3	Vertical	360	1.00	-	38.79	16.52	2.68	27.34
PK	380.043478M	40.62	46.00	-5.38	-4.44	3	Vertical	360	1.00	-	45.06	20.22	3.15	27.81
PK	455.956522M	40.35	46.00	-5.65	-2.84	3	Vertical	360	1.00	-	43.19	22.18	3.24	28.26
PK	999.999M	49.10	54.00	-4.90	4.45	3	Vertical	360	1.00	-	44.65	26.65	5.04	27.24



BT-LE(1Mbps)
2440MHz_adapter

02/04/2018

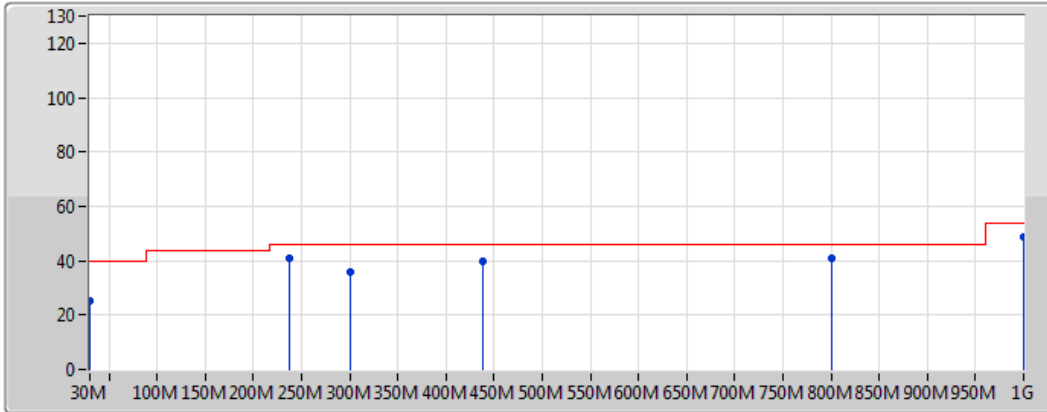

Legend:
 Lim.PK
 PK

Type	Freq (Hz)	Level (dBuV/m)	Limit (dBuV/m)	Margin (dB)	Factor (dB)	Dist (m)	Condition	Azimuth (°)	Height (m)	Comments	Raw (dBuV)	AF (dB)	CL (dB)	PA (dB)
PK	30M	25.29	40.00	-14.71	-4.45	3	Horizontal	0	1.00	-	29.74	23.11	0.29	27.85
PK	238.057971M	41.10	46.00	-4.90	-8.33	3	Horizontal	0	1.00	-	49.43	16.35	2.66	27.35
PK	299.913043M	35.62	46.00	-10.38	-5.77	3	Horizontal	0	1.00	-	41.39	18.43	3.00	27.20
PK	437.681159M	39.68	46.00	-6.32	-3.08	3	Horizontal	0	1.00	-	42.76	21.86	3.22	28.16
PK	800.376812M	40.88	46.00	-5.12	1.25	3	Horizontal	0	1.00	-	39.63	25.15	4.17	28.07
PK	999.999M	48.86	54.00	-5.14	4.45	3	Horizontal	0	1.00	-	44.41	26.65	5.04	27.24



Summary

Mode	Result	Type	Freq (Hz)	Level (dBuV/m)	Limit (dBuV/m)	Margin (dB)	Factor (dB)	Dist (m)	Condition	Azimuth (°)	Height (m)	Comments
2.4-2.4835GHz	-	-	-	-	-	-	-	-	-	-	-	-
BT-LE(1Mbps)	Pass	AV	2.483502G	45.80	54.00	-8.20	32.81	3	Horizontal	7	3.19	-



Result

Mode	Result	Type	Freq (Hz)	Level (dBuV/m)	Limit (dBuV/m)	Margin (dB)	Factor (dB)	Dist (m)	Condition	Azimuth (°)	Height (m)	Comments
BT-LE(1Mbps)	-	-	-	-	-	-	-	-	-	-	-	-
2402MHz	Pass	AV	2.389998G	44.58	54.00	-9.42	32.45	3	Horizontal	11	1.50	-
2402MHz	Pass	AV	2.402G	94.12	Inf	-Inf	32.50	3	Horizontal	11	1.50	-
2402MHz	Pass	PK	2.3898G	56.12	74.00	-17.88	32.45	3	Horizontal	11	1.50	-
2402MHz	Pass	PK	2.4022G	95.51	Inf	-Inf	32.50	3	Horizontal	11	1.50	-
2402MHz	Pass	AV	2.3816G	44.53	54.00	-9.47	32.42	3	Vertical	34	1.49	-
2402MHz	Pass	AV	2.402G	88.24	Inf	-Inf	32.50	3	Vertical	34	1.49	-
2402MHz	Pass	PK	2.3894G	56.03	74.00	-17.97	32.45	3	Vertical	34	1.49	-
2402MHz	Pass	PK	2.4022G	89.59	Inf	-Inf	32.50	3	Vertical	34	1.49	-
2402MHz	Pass	AV	4.804G	35.77	54.00	-18.23	3.09	3	Horizontal	302	3.10	-
2402MHz	Pass	PK	4.804G	46.38	74.00	-27.62	3.09	3	Horizontal	302	3.10	-
2402MHz	Pass	AV	4.804G	34.37	54.00	-19.63	3.09	3	Vertical	200	1.48	-
2402MHz	Pass	PK	4.804G	45.07	74.00	-28.93	3.09	3	Vertical	200	1.48	-
2440MHz	Pass	AV	2.3828G	44.56	54.00	-9.44	32.43	3	Horizontal	11	2.63	-
2440MHz	Pass	AV	2.44G	96.41	Inf	-Inf	32.64	3	Horizontal	11	2.63	-
2440MHz	Pass	AV	2.4908G	45.15	54.00	-8.85	32.84	3	Horizontal	11	2.63	-
2440MHz	Pass	PK	2.3708G	56.11	74.00	-17.89	32.37	3	Horizontal	11	2.63	-
2440MHz	Pass	PK	2.4404G	97.83	Inf	-Inf	32.64	3	Horizontal	11	2.63	-
2440MHz	Pass	PK	2.488G	55.53	74.00	-18.47	32.83	3	Horizontal	11	2.63	-
2440MHz	Pass	AV	2.3848G	44.46	54.00	-9.54	32.43	3	Vertical	86	1.28	-
2440MHz	Pass	AV	2.44G	89.57	Inf	-Inf	32.64	3	Vertical	86	1.28	-
2440MHz	Pass	AV	2.499998G	45.22	54.00	-8.78	32.87	3	Vertical	86	1.28	-
2440MHz	Pass	PK	2.378G	54.90	74.00	-19.10	32.40	3	Vertical	86	1.28	-
2440MHz	Pass	PK	2.4396G	90.92	Inf	-Inf	32.64	3	Vertical	86	1.28	-
2440MHz	Pass	PK	2.49G	55.78	74.00	-18.22	32.83	3	Vertical	86	1.28	-
2440MHz	Pass	AV	7.32G	36.24	54.00	-17.76	9.30	3	Horizontal	181	1.95	-
2440MHz	Pass	PK	7.32G	49.76	74.00	-24.24	9.30	3	Horizontal	181	1.95	-
2440MHz	Pass	AV	7.32G	36.42	54.00	-17.58	9.30	3	Vertical	229	2.71	-
2440MHz	Pass	PK	7.32G	49.60	74.00	-24.40	9.30	3	Vertical	229	2.71	-
2480MHz	Pass	AV	2.48G	93.27	Inf	-Inf	32.79	3	Horizontal	7	3.19	-
2480MHz	Pass	AV	2.483502G	45.80	54.00	-8.20	32.81	3	Horizontal	7	3.19	-
2480MHz	Pass	PK	2.4798G	94.71	Inf	-Inf	32.79	3	Horizontal	7	3.19	-
2480MHz	Pass	PK	2.4838G	63.62	74.00	-10.38	32.81	3	Horizontal	7	3.19	-
2480MHz	Pass	AV	2.48G	93.08	Inf	-Inf	32.79	3	Vertical	4	2.85	-
2480MHz	Pass	AV	2.4836G	45.40	54.00	-8.60	32.81	3	Vertical	4	2.85	-
2480MHz	Pass	PK	2.4798G	94.56	Inf	-Inf	32.79	3	Vertical	4	2.85	-
2480MHz	Pass	PK	2.4836G	63.84	74.00	-10.16	32.81	3	Vertical	4	2.85	-
2480MHz	Pass	AV	7.44G	38.19	54.00	-15.81	9.82	3	Horizontal	240	1.50	-
2480MHz	Pass	PK	7.44G	49.47	74.00	-24.53	9.82	3	Horizontal	240	1.50	-
2480MHz	Pass	AV	7.44G	37.07	54.00	-16.93	9.82	3	Vertical	176	1.50	-
2480MHz	Pass	PK	7.44G	50.44	74.00	-23.56	9.82	3	Vertical	176	1.50	-

BT-LE(1Mbps)

2402MHz_TX

20/03/2018

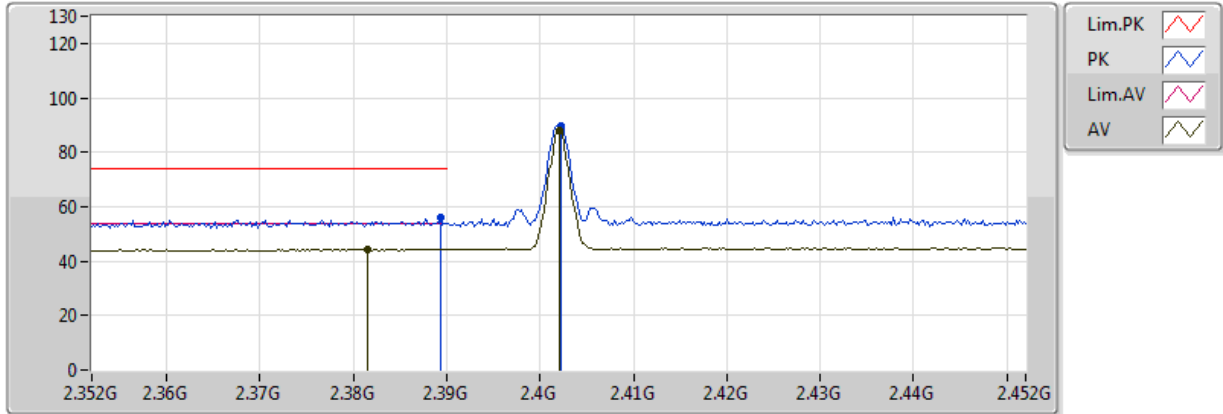

Type	Freq (Hz)	Level (dBuV/m)	Limit (dBuV/m)	Margin (dB)	Factor (dB)	Dist (m)	Condition	Azimuth (°)	Height (m)	Comments	Raw (dBuV)	AF (dB)	CL (dB)	PA (dB)
AV	2.3816G	44.53	54.00	-9.47	32.42	3	Vertical	34	1.49	-	12.11	27.29	5.13	-
AV	2.402G	88.24	Inf	-Inf	32.50	3	Vertical	34	1.49	-	55.74	27.35	5.15	-
PK	2.3894G	56.03	74.00	-17.97	32.45	3	Vertical	34	1.49	-	23.58	27.31	5.14	-
PK	2.4022G	89.59	Inf	-Inf	32.50	3	Vertical	34	1.49	-	57.09	27.35	5.15	-

BT-LE(1Mbps)

2402MHz_TX

20/03/2018

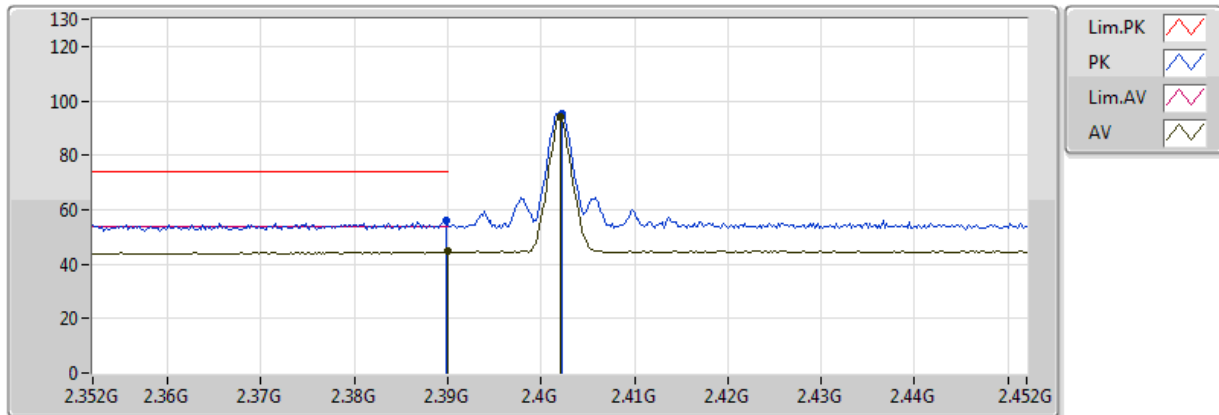

Type	Freq (Hz)	Level (dBuV/m)	Limit (dBuV/m)	Margin (dB)	Factor (dB)	Dist (m)	Condition	Azimuth (°)	Height (m)	Comments	Raw (dBuV)	AF (dB)	CL (dB)	PA (dB)
AV	2.389998G	44.58	54.00	-9.42	32.45	3	Horizontal	11	1.50	-	12.13	27.31	5.14	-
AV	2.402G	94.12	Inf	-Inf	32.50	3	Horizontal	11	1.50	-	61.62	27.35	5.15	-
PK	2.3898G	56.12	74.00	-17.88	32.45	3	Horizontal	11	1.50	-	23.67	27.31	5.14	-
PK	2.4022G	95.51	Inf	-Inf	32.50	3	Horizontal	11	1.50	-	63.01	27.35	5.15	-

BT-LE(1Mbps)

2402MHz_TX

20/03/2018

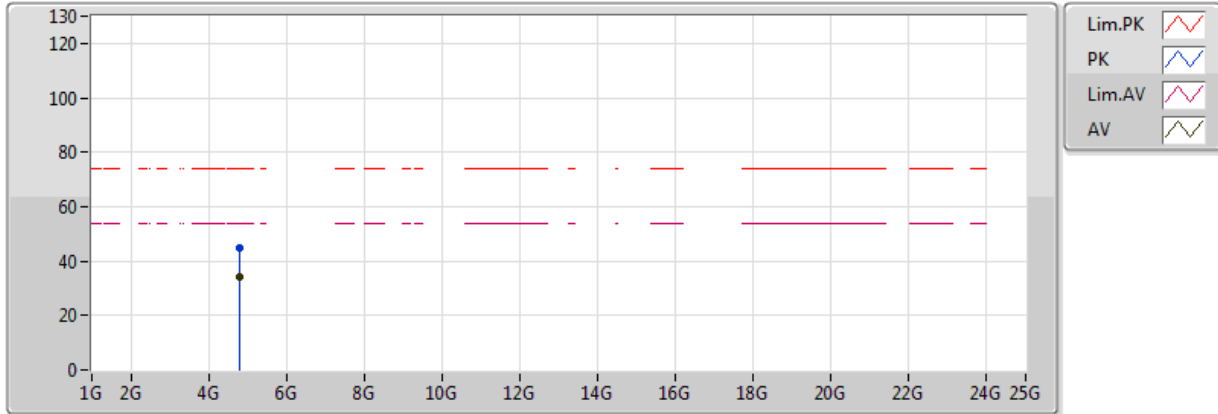

Type	Freq (Hz)	Level (dBuV/m)	Limit (dBuV/m)	Margin (dB)	Factor (dB)	Dist (m)	Condition	Azimuth (°)	Height (m)	Comments	Raw (dBuV)	AF (dB)	CL (dB)	PA (dB)
AV	4.804G	34.37	54.00	-19.63	3.09	3	Vertical	200	1.48	-	31.28	31.25	6.43	34.59
PK	4.804G	45.07	74.00	-28.93	3.09	3	Vertical	200	1.48	-	41.98	31.25	6.43	34.59

BT-LE(1Mbps)

2402MHz_TX

20/03/2018

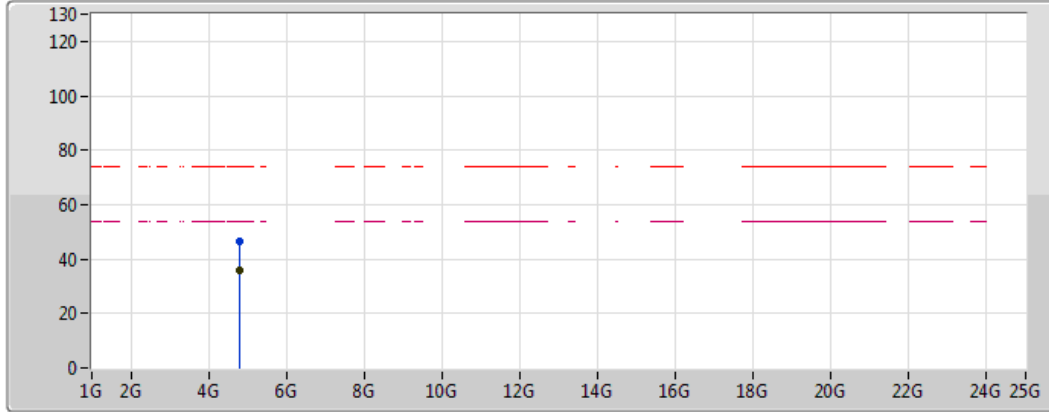

Type	Freq (Hz)	Level (dBuV/m)	Limit (dBuV/m)	Margin (dB)	Factor (dB)	Dist (m)	Condition	Azimuth (°)	Height (m)	Comments	Raw (dBuV)	AF (dB)	CL (dB)	PA (dB)
AV	4.804G	35.77	54.00	-18.23	3.09	3	Horizontal	302	3.10	-	32.68	31.25	6.43	34.59
PK	4.804G	46.38	74.00	-27.62	3.09	3	Horizontal	302	3.10	-	43.29	31.25	6.43	34.59

BT-LE(1Mbps)

2440MHz_TX

20/03/2018

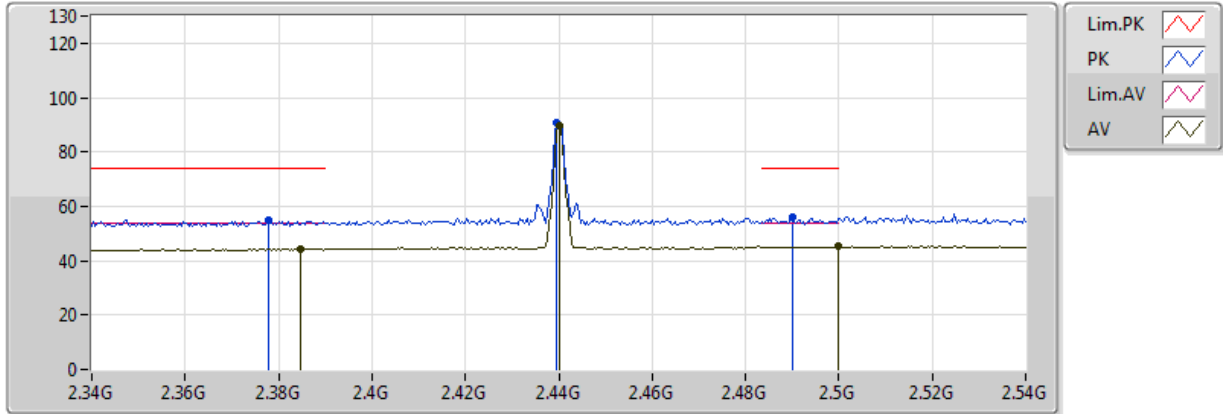

Type	Freq (Hz)	Level (dBuV/m)	Limit (dBuV/m)	Margin (dB)	Factor (dB)	Dist (m)	Condition	Azimuth (°)	Height (m)	Comments	Raw (dBuV)	AF (dB)	CL (dB)	PA (dB)
AV	2.3848G	44.46	54.00	-9.54	32.43	3	Vertical	86	1.28	-	12.03	27.30	5.13	-
AV	2.44G	89.57	Inf	-Inf	32.64	3	Vertical	86	1.28	-	56.93	27.44	5.20	-
AV	2.499998G	45.22	54.00	-8.78	32.87	3	Vertical	86	1.28	-	12.35	27.60	5.27	-
PK	2.378G	54.90	74.00	-19.10	32.40	3	Vertical	86	1.28	-	22.50	27.28	5.12	-
PK	2.4396G	90.92	Inf	-Inf	32.64	3	Vertical	86	1.28	-	58.28	27.44	5.20	-
PK	2.49G	55.78	74.00	-18.22	32.83	3	Vertical	86	1.28	-	22.95	27.57	5.26	-

BT-LE(1Mbps)

2440MHz_TX

20/03/2018

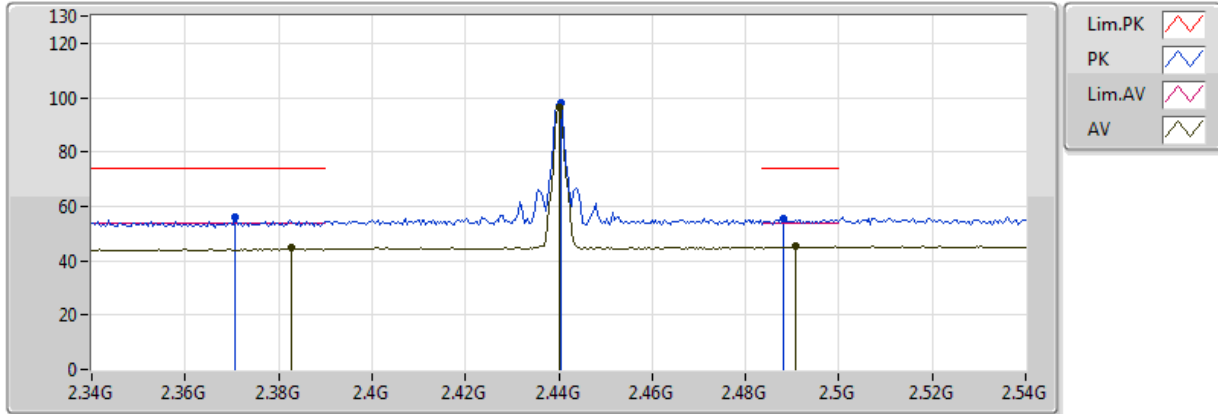

Type	Freq (Hz)	Level (dBuV/m)	Limit (dBuV/m)	Margin (dB)	Factor (dB)	Dist (m)	Condition	Azimuth (°)	Height (m)	Comments	Raw (dBuV)	AF (dB)	CL (dB)	PA (dB)
AV	2.3828G	44.56	54.00	-9.44	32.43	3	Horizontal	11	2.63	-	12.13	27.30	5.13	-
AV	2.44G	96.41	Inf	-Inf	32.64	3	Horizontal	11	2.63	-	63.77	27.44	5.20	-
AV	2.4908G	45.15	54.00	-8.85	32.84	3	Horizontal	11	2.63	-	12.31	27.58	5.26	-
PK	2.3708G	56.11	74.00	-17.89	32.37	3	Horizontal	11	2.63	-	23.74	27.26	5.11	-
PK	2.4404G	97.83	Inf	-Inf	32.64	3	Horizontal	11	2.63	-	65.19	27.45	5.20	-
PK	2.488G	55.53	74.00	-18.47	32.83	3	Horizontal	11	2.63	-	22.70	27.57	5.26	-

BT-LE(1Mbps)

2440MHz_TX

20/03/2018

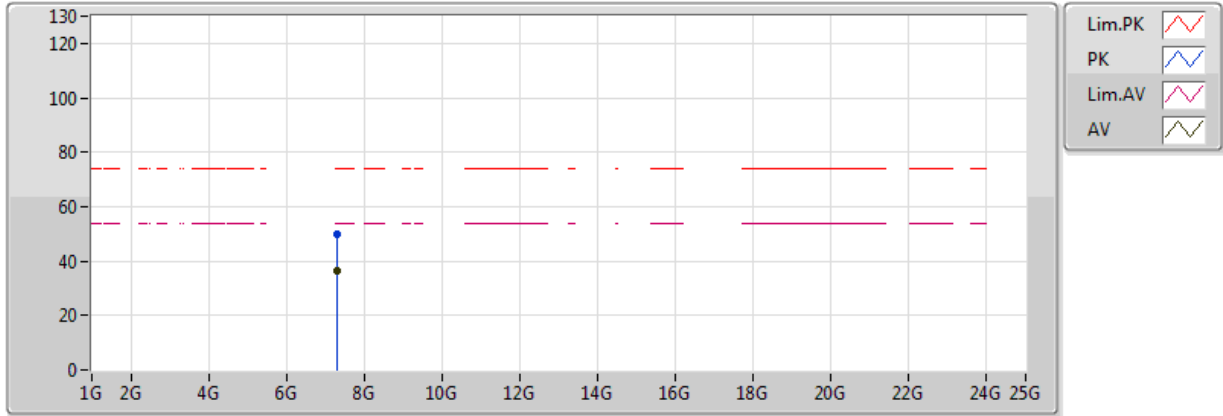

Type	Freq (Hz)	Level (dBuV/m)	Limit (dBuV/m)	Margin (dB)	Factor (dB)	Dist (m)	Condition	Azimuth (°)	Height (m)	Comments	Raw (dBuV)	AF (dB)	CL (dB)	PA (dB)
AV	7.32G	36.42	54.00	-17.58	9.30	3	Vertical	229	2.71	-	27.12	35.83	8.45	34.99
PK	7.32G	49.60	74.00	-24.40	9.30	3	Vertical	229	2.71	-	40.30	35.83	8.45	34.99

BT-LE(1Mbps)

2440MHz_TX

21/03/2018

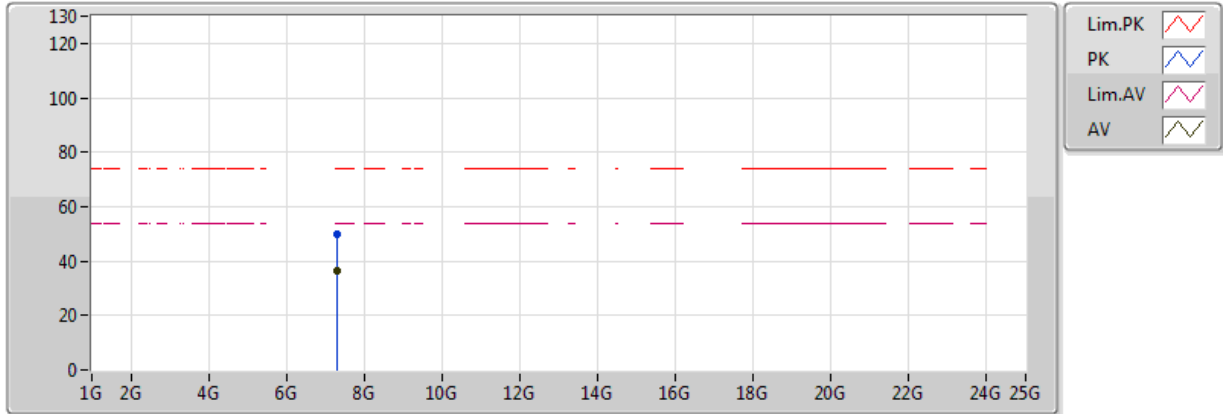

Type	Freq (Hz)	Level (dBuV/m)	Limit (dBuV/m)	Margin (dB)	Factor (dB)	Dist (m)	Condition	Azimuth (°)	Height (m)	Comments	Raw (dBuV)	AF (dB)	CL (dB)	PA (dB)
AV	7.32G	36.24	54.00	-17.76	9.30	3	Horizontal	181	1.95	-	26.94	35.83	8.45	34.99
PK	7.32G	49.76	74.00	-24.24	9.30	3	Horizontal	181	1.95	-	40.46	35.83	8.45	34.99

BT-LE(1Mbps)

2480MHz_TX

20/03/2018

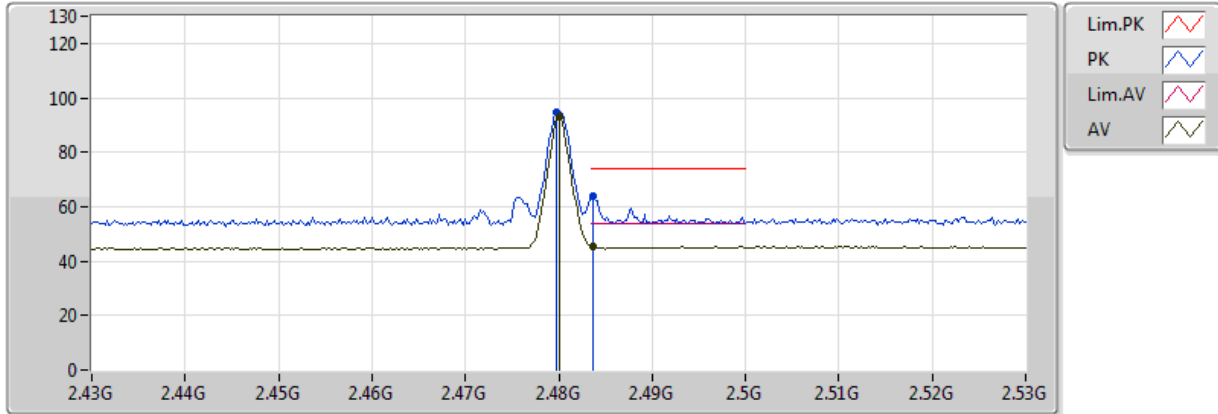

Type	Freq (Hz)	Level (dBuV/m)	Limit (dBuV/m)	Margin (dB)	Factor (dB)	Dist (m)	Condition	Azimuth (°)	Height (m)	Comments	Raw (dBuV)	AF (dB)	CL (dB)	PA (dB)
AV	2.48G	93.08	Inf	-Inf	32.79	3	Vertical	4	2.85	-	60.29	27.55	5.25	-
AV	2.4836G	45.40	54.00	-8.60	32.81	3	Vertical	4	2.85	-	12.59	27.56	5.25	-
PK	2.4798G	94.56	Inf	-Inf	32.79	3	Vertical	4	2.85	-	61.77	27.55	5.25	-
PK	2.4836G	63.84	74.00	-10.16	32.81	3	Vertical	4	2.85	-	31.03	27.56	5.25	-

BT-LE(1Mbps)

2480MHz_TX

20/03/2018

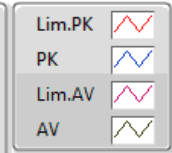
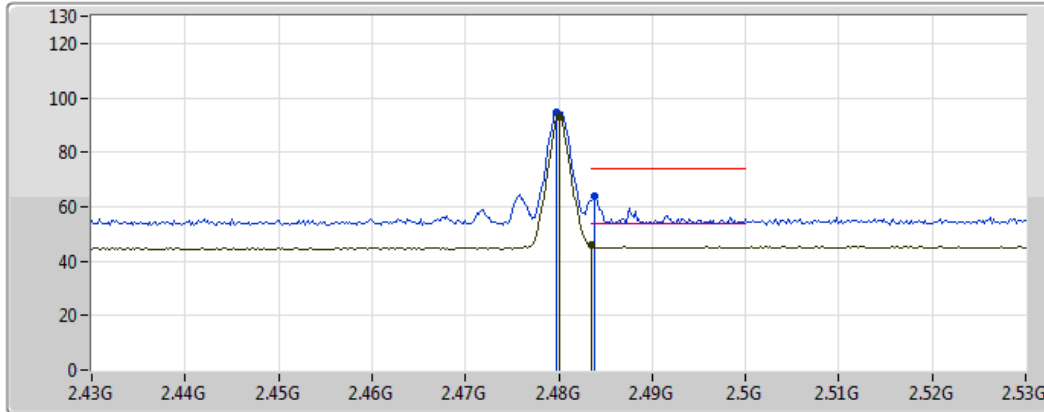

Type	Freq (Hz)	Level (dBuV/m)	Limit (dBuV/m)	Margin (dB)	Factor (dB)	Dist (m)	Condition	Azimuth (°)	Height (m)	Comments	Raw (dBuV)	AF (dB)	CL (dB)	PA (dB)
AV	2.48G	93.27	Inf	-Inf	32.79	3	Horizontal	7	3.19	-	60.48	27.55	5.25	-
AV	2.483502G	45.80	54.00	-8.20	32.81	3	Horizontal	7	3.19	-	12.99	27.56	5.25	-
PK	2.4798G	94.71	Inf	-Inf	32.79	3	Horizontal	7	3.19	-	61.92	27.55	5.25	-
PK	2.4838G	63.62	74.00	-10.38	32.81	3	Horizontal	7	3.19	-	30.81	27.56	5.25	-

BT-LE(1Mbps)

2480MHz_TX

20/03/2018

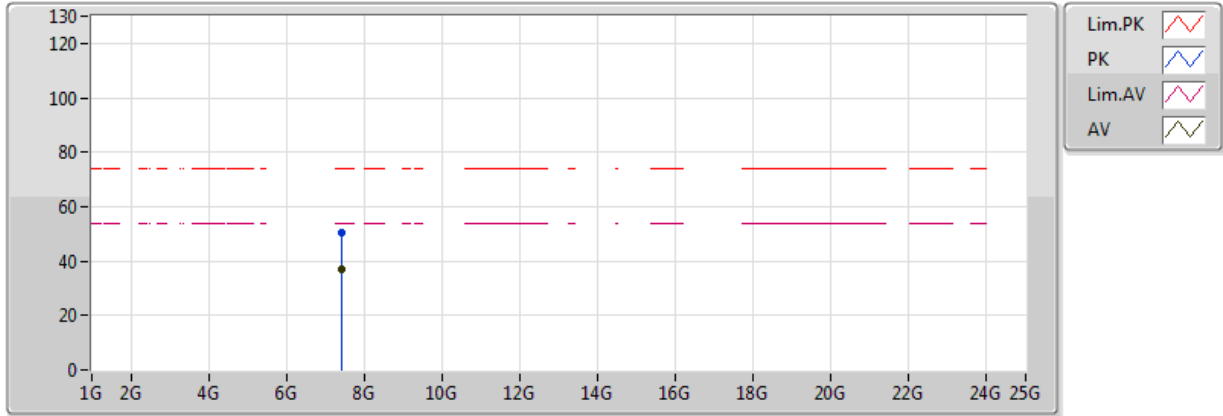

Type	Freq (Hz)	Level (dBuV/m)	Limit (dBuV/m)	Margin (dB)	Factor (dB)	Dist (m)	Condition	Azimuth (°)	Height (m)	Comments	Raw (dBuV)	AF (dB)	CL (dB)	PA (dB)
AV	7.44G	37.07	54.00	-16.93	9.82	3	Vertical	176	1.50	-	27.25	36.14	8.69	35.02
PK	7.44G	50.44	74.00	-23.56	9.82	3	Vertical	176	1.50	-	40.62	36.14	8.69	35.02

BT-LE(1Mbps)

2480MHz_TX

20/03/2018

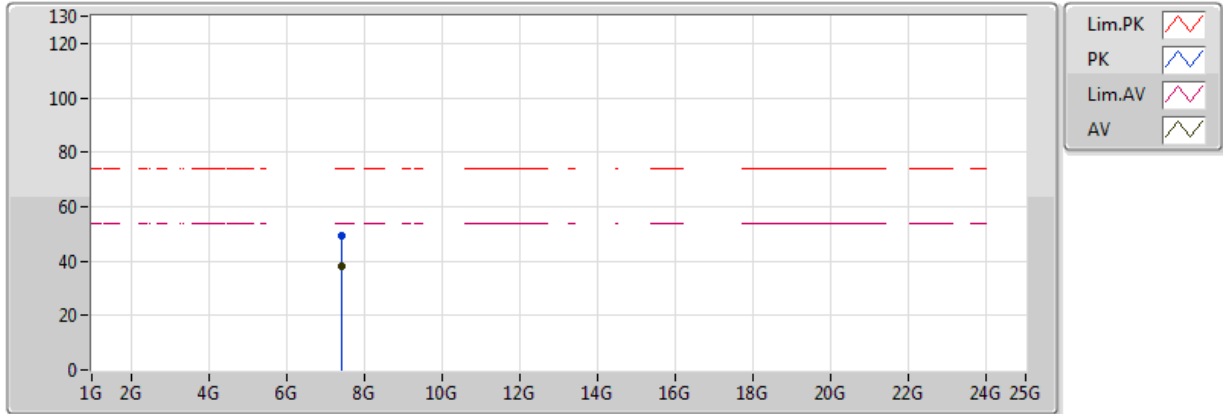

Type	Freq (Hz)	Level (dBuV/m)	Limit (dBuV/m)	Margin (dB)	Factor (dB)	Dist (m)	Condition	Azimuth (°)	Height (m)	Comments	Raw (dBuV)	AF (dB)	CL (dB)	PA (dB)
AV	7.44G	38.19	54.00	-15.81	9.82	3	Horizontal	240	1.50	-	28.37	36.14	8.69	35.02
PK	7.44G	49.47	74.00	-24.53	9.82	3	Horizontal	240	1.50	-	39.65	36.14	8.69	35.02