

FCC Test Report

Report No.: RF160726C12B-1

FCC ID: 2AGMRAP12I360

Test Model: AP12I360

Received Date: Jul. 26, 2016

Test Date: Jul. 30 ~ Sep. 09, 2016

Issued Date: Nov. 10, 2016

Applicant: Tembo Systems, Inc.

Address: 2933 Bunker Hill Lane, Suite 100, Santa Clara, CA 95054, United States.

Issued By: Bureau Veritas Consumer Products Services (H.K.) Ltd., Taoyuan Branch

Lab Address: No. 47-2, 14th Ling, Chia Pau Vil., Lin Kou Dist., New Taipei City, Taiwan (R.O.C.)

Test Location: No. 19, Hwa Ya 2nd Rd., Wen Hwa Vil., Kwei Shan Dist., Taoyuan City 33383, TAIWAN (R.O.C.)



This report is for your exclusive use. Any copying or replication of this report to or for any other person or entity, or use of our name or trademark, is permitted only with our prior written permission. This report sets forth our findings solely with respect to the test samples identified herein. The results set forth in this report are not indicative or representative of the quality or characteristics of the lot from which a test sample was taken or any similar or identical product unless specifically and expressly noted. Our report includes all of the tests requested by you and the results thereof based upon the information that you provided to us. You have 60 days from date of issuance of this report to notify us of any material error or omission caused by our negligence, provided, however, that such notice shall be in writing and shall specifically address the issue you wish to raise. A failure to raise such issue within the prescribed time shall constitute your unqualified acceptance of the completeness of this report, the tests conducted and the correctness of the report contents. Unless specifically mentioned, the uncertainty of measurement has been explicitly taken into account to declare the compliance or non-compliance to the specification. The report must not be used by the client to claim product certification, approval, or endorsement by TAF or any government agencies.

Table of Contents

Release Control Record	4
1 Certificate of Conformity	5
2 Summary of Test Results	6
2.1 Measurement Uncertainty	6
2.2 Modification Record	6
3 General Information	7
3.1 General Description of EUT	7
3.2 Description of Test Modes	10
3.2.1 Test Mode Applicability and Tested Channel Detail	11
3.3 Duty Cycle of Test Signal	13
3.4 Description of Support Units	14
3.4.1 Configuration of System under Test	14
3.5 General Description of Applied Standard	15
4 Test Types and Results	16
4.1 Radiated Emission and Bandedge Measurement.....	16
4.1.1 Limits of Radiated Emission and Bandedge Measurement	16
4.1.2 Test Instruments	17
4.1.3 Test Procedure	18
4.1.4 Deviation from Test Standard	18
4.1.5 Test Setup.....	19
4.1.6 EUT Operating Conditions.....	20
4.1.7 Test Results	21
4.2 Conducted Emission Measurement	42
4.2.1 Limits of Conducted Emission Measurement	42
4.2.2 Test Instruments	42
4.2.3 Test Procedure	43
4.2.4 Deviation from Test Standard	43
4.2.5 Test Setup.....	43
4.2.6 EUT Operating Conditions.....	43
4.2.7 Test Results	44
4.3 Transmit Power Measurement	48
4.3.1 Limits of Transmit Power Measurement	48
4.3.2 Test Setup.....	48
4.3.3 Test Instruments	49
4.3.4 Test Procedure	49
4.3.5 Deviation from Test Standard	49
4.3.6 EUT Operating Conditions.....	49
4.3.7 Test Result.....	50
4.4 Occupied Bandwidth Measurement	55
4.4.1 Test Setup.....	55
4.4.2 Test Instruments	55
4.4.3 Test Procedure	55
4.4.4 Test Result.....	56
4.5 Peak Power Spectral Density Measurement	58
4.5.1 Limits of Peak Power Spectral Density Measurement	58
4.5.2 Test Setup.....	58
4.5.3 Test Instruments	58
4.5.4 Test Procedure	59
4.5.5 Deviation from Test Standard	59
4.5.6 EUT Operating Condition	59
4.5.7 Test Results	60
4.6 Frequency Stability.....	66
4.6.1 Limits of Frequency Stability Measurement	66

4.6.2	Test Setup.....	66
4.6.3	Test Instruments	66
4.6.4	Test Procedure	66
4.6.5	Deviation from Test Standard	66
4.6.6	EUT Operating Condition	66
4.6.7	Test Results	67
4.7	6dB Bandwidth Measurement.....	68
4.7.1	Limits of 6dB Bandwidth Measurement.....	68
4.7.2	Test Setup.....	68
4.7.3	Test Instruments	68
4.7.4	Test Procedure	68
4.7.5	Deviation from Test Standard	68
4.7.6	EUT Operating Condition	68
4.7.7	Test Results	69
5	Pictures of Test Arrangements.....	71
	Annex A- Radiated Out of Band Emission (OOBE) Measurement (For U-NII-3 band).....	72
	Appendix – Information on the Testing Laboratories	75

Release Control Record

Issue No.	Description	Date Issued
RF160726C12B-1	Original release.	Nov. 10, 2016

1 Certificate of Conformity

Product: AP1002Oi 2-Radio Omni-Directional Indoor Access Point

Brand: EVEREST™ Network Solutions

Test Model: AP12I360

Sample Status: Engineering sample

Applicant: Tembo Systems, Inc.

Test Date: Jul. 30 ~ Sep. 09, 2016

Standard: 47 CFR FCC Part 15, Subpart E (Section 15.407)
ANSI C63.10:2013

The above equipment has been tested by **Bureau Veritas Consumer Products Services (H.K.) Ltd., Taoyuan Branch**, and found compliance with the requirement of the above standards. The test record, data evaluation & Equipment Under Test (EUT) configurations represented herein are true and accurate accounts of the measurements of the sample's EMC characteristics under the Conditions specified in this report.

Prepared by :

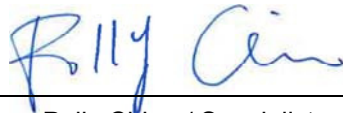
Polly Chien / Specialist

Date:

Nov. 10, 2016

Approved by :

Ken Liu / Senior Manager

Date:

Nov. 10, 2016

2 Summary of Test Results

47 CFR FCC Part 15, Subpart E (Section 15.407)			
FCC Clause	Test Item	Result	Remarks
15.407(b)(6)	AC Power Conducted Emissions	Pass	Meet the requirement of limit. Minimum passing margin is -7.92dB at 0.52544MHz.
15.407(b) (1/2/3/4(i/ii)/6)	Radiated Emissions & Band Edge Measurement	Pass	Meet the requirement of limit. Minimum passing margin is -1.2dB at 10480.00MHz.
15.407(a)(1/2/3)	Max Average Transmit Power	Pass	Meet the requirement of limit.
15.407(a)(1/2/3)	Peak Power Spectral Density	Pass	Meet the requirement of limit.
15.407(e)	6dB bandwidth	Pass	Meet the requirement of limit. (U-NII-3 Band only)
15.407(g)	Frequency Stability	Pass	Meet the requirement of limit.
15.203	Antenna Requirement	Pass	Antenna connector is IPEX not a standard connector.

*For U-NII-3 band compliance with rule part 15.407(b)(4)(i), the OOB test plots were recorded in Annex A.

2.1 Measurement Uncertainty

Where relevant, the following measurement uncertainty levels have been estimated for tests performed on the EUT as specified in CISPR 16-4-2:

Measurement	Frequency	Expanded Uncertainty (k=2) (±)
Conducted Emissions at mains ports	150kHz ~ 30MHz	2.44 dB
Radiated Emissions up to 1 GHz	30MHz ~ 200MHz	3.86 dB
	200MHz ~ 1000MHz	3.87 dB
Radiated Emissions above 1 GHz	1GHz ~ 18GHz	2.29 dB
	18GHz ~ 40GHz	2.29 dB

2.2 Modification Record

There were no modifications required for compliance.

3 General Information

3.1 General Description of EUT

Product	AP1002Oi 2-Radio Omni-Directional Indoor Access Point
Brand	EVEREST™ Network Solutions
Test Model	AP12I360
Sample Status	Engineering sample
Power Supply Rating	12Vdc from adapter 48Vdc from POE
Modulation Type	256QAM, 64QAM, 16QAM, QPSK, BPSK
Modulation Technology	OFDM
Transfer Rate	802.11a: 54/48/36/24/18/12/9/6Mbps 802.11n: up to 600Mbps 802.11ac: up to 1733Mbps
Operating Frequency	5180~5240MHz, 5745~5825MHz
Number of Channel	5180~5240MHz: 802.11a, 802.11n (HT20), 802.11ac (VHT20): 4 802.11n (HT40), 802.11ac (VHT40): 2 802.11ac (VHT80), 802.11ac (VHT80+VHT80): 1 5745~5825MHz: 802.11a, 802.11n (HT20), 802.11ac (VHT20): 5 802.11n (HT40), 802.11ac (VHT40): 2 802.11ac (VHT80), 802.11ac (VHT80+VHT80): 1
Output Power	Radio 2: CDD Mode 5180 ~ 5240MHz: 267.841mW 5745 ~ 5825MHz: 351.314mW Beamforming Mode 5180 ~ 5240MHz: 66.970mW 5745 ~ 5825MHz: 87.810mW
Antenna Type	Refer to Note
Antenna Connector	Refer to Note
Accessory Device	NA
Data Cable Supplied	NA

Note:

1. There are four radios for the EUT.

Radio	Model	Function
Radio 1	QCA9994	WLAN 2.4G
Radio 2	QCA9994	WLAN 5G
Radio 3	QCA9889	WLAN 2.4GHz (TX/RX)+5GHz (RX)
Radio 4	MKW40Z160 MCU	BT LE

2. The EUT incorporates a MIMO function. Physically, the EUT provides 4 completed transmitters and 4 receivers.

Band	Modulation Mode	Beamforming Mode	TX Function	Available Channel	Remark
5GHz (U-NII-1 band)	802.11a	Not Support	4TX	36 ~ 48	Radio 2
	802.11ac (VHT20)	Support	4TX	36 ~ 48	
	802.11ac (VHT40)	Support	4TX	38 ~ 46	
	802.11ac (VHT80)	Support	4TX	42	
	802.11ac (VHT80+ VHT80)	Support	2TX+2TX	42 + 155	Radio 2
	802.11a	Not Support	RX only	36 ~ 48	Radio 3
	802.11ac (VHT20)	Not Support	RX only	36 ~ 48	
	802.11ac (VHT40)	Not Support	RX only	38 ~ 46	
802.11ac (VHT80)	Not Support	RX only	42		
5GHz (U-NII-3 band)	802.11a	Not Support	4TX	149 ~ 165	Radio 2
	802.11ac (VHT20)	Support	4TX	149 ~ 165	
	802.11ac (VHT40)	Support	4TX	151 ~ 159	
	802.11ac (VHT80)	Support	4TX	155	
	802.11ac (VHT80+ VHT80)	Support	2TX+2TX	42 + 155	Radio 2
	802.11a	Not Support	RX only	149 ~ 165	Radio 3
	802.11ac (VHT20)	Not Support	RX only	149 ~ 165	
	802.11ac (VHT40)	Not Support	RX only	151 ~ 159	
802.11ac (VHT80)	Not Support	RX only	155		

* The modulation and bandwidth are similar for 802.11n mode for HT20/HT40 and 802.11ac mode for VHT20/VHT40, therefore investigated worst case to representative mode in test report. (Final test mode refer section 3.2.1)

* For 802.11n & 802.11ac, after pre-tested two modes(with beamforming mode and CDD mode) found CDD mode was the worst, therefore chosen for final test except power output test and presented in the test report.

3. WLAN 2.4GHz, WLAN 5GHz and BT LE technologies can transmit at same time.

4. Spurious emission of the simultaneous operation (2.4GHz, 5GHz and BT LE) has been evaluated and no non-compliance was found.

5. The EUT uses following antennas.

Ant. No.	1	2	3	4	5	6	7	8	9 (Scan) Individual	10 (BLE) Individual
Ant. Type	PIFA								PIFA	Dipole
Frequency (MHz)	2400-2500				5150-5850				2400-2500/ 5150-5850	2400-2500
CDD Gain (dBi)	3.81	3.98	3.47	3.75	5.65	5.50	5.84	5.84	2.9/5.1	3.93
Connector	IPEX								IPEX	IPEX

6. The EUT consumes power from the following adapter and POE. (Support units only)

Adapter	
Brand	AOEM
Model	ADS036T-W120300
Input Power	100-240Vac, 50-60Hz, 1.0A
Output Power	12Vdc, 3.0A
Power Line	1.5m cable with one core attached on adapter

POE	
Brand	EnGenius
Model	EPE-48GR
Output Power	48Vdc, 0.5A, 24W Max

POE's adapter	
Brand	Powertron Electronics Corp.
Model	PA1040-480IB080
Input Power	100-240Vac, 50-60Hz, 1.5A
Output Power	48Vdc, 0.8A, 38.4W Max
Power Line	1.55m cable with one core attached on adapter

3.2 Description of Test Modes

5180 ~ 5240MHz:

4 channels are provided for 802.11a, 802.11n (HT20), 802.11ac (VHT20):

Channel	Frequency	Channel	Frequency
36	5180 MHz	44	5220 MHz
40	5200 MHz	48	5240 MHz

2 channels are provided for 802.11n (HT40), 802.11ac (VHT40):

Channel	Frequency	Channel	Frequency
38	5190 MHz	46	5230 MHz

1 channel is provided for 802.11ac (VHT80), 802.11ac (VHT80+VHT80):

Channel	Frequency
42	5210MHz

5745 ~ 5825MHz:

5 channels are provided for 802.11a, 802.11n (HT20), 802.11ac (VHT20):

Channel	Frequency	Channel	Frequency
149	5745MHz	161	5805MHz
153	5765MHz	165	5825MHz
157	5785MHz		

2 channels are provided for 802.11n (HT40), 802.11ac (VHT40):

Channel	Frequency	Channel	Frequency
151	5755MHz	159	5795MHz

1 channel is provided for 802.11ac (VHT80), 802.11ac (VHT80+VHT80):

Channel	Frequency
155	5775MHz

802.11ac (VHT80+VHT80) only support channel as below:

Channel	Frequency
42+155	5210MHz+5775MHz

3.2.1 Test Mode Applicability and Tested Channel Detail

EUT Configure Mode	Applicable to				Description
	RE≥1G	RE<1G	PLC	APCM	
A	√	√	√	√	Power from adapter
B	-	√	√	-	Power from POE

Where RE≥1G: Radiated Emission above 1GHz & Bandedge Measurement
 RE<1G: Radiated Emission below 1GHz
 PLC: Power Line Conducted Emission
 APCM: Antenna Port Conducted Measurement

Note:

- The EUT had been pre-tested on the positioned of each 3 axis. The worst case was found when positioned on **Y-plane**.
- "-" means no effect.

Radiated Emission Test (Above 1GHz):

- Pre-Scan has been conducted to determine the worst-case mode from all possible combinations between available modulations, data rates and antenna ports (if EUT with antenna diversity architecture).
- Following channel(s) was (were) selected for the final test as listed below.

EUT CONFIGURE MODE	MODE	FREQ. BAND (MHz)	AVAILABLE CHANNEL	TESTED CHANNEL	MODULATION TECHNOLOGY	MODULATION TYPE	DATA RATE (Mbps)	REMARK
A	802.11a	5180-5240	36 to 48	36, 40, 48	OFDM	BPSK	6.0	Radio 2 (4TX)
A	802.11n (HT20)		36 to 48	36, 40, 48	OFDM	BPSK	7.2	Radio 2 (4TX)
A	802.11n (HT40)		38 to 46	38, 46	OFDM	BPSK	15.0	Radio 2 (4TX)
A	802.11ac (VHT80)		42	42	OFDM	BPSK	130.0	Radio 2 (4TX)
A	802.11a	5745-5825	149 to 165	149, 157, 165	OFDM	BPSK	6.0	Radio 2 (4TX)
A	802.11n (HT20)		149 to 165	149, 157, 165	OFDM	BPSK	7.2	Radio 2 (4TX)
A	802.11n (HT40)		151 to 159	151, 159	OFDM	BPSK	15.0	Radio 2 (4TX)
A	802.11ac (VHT80)		155	155	OFDM	BPSK	130.0	Radio 2 (4TX)
A	802.11ac (VHT80+VHT80)	5180-5240	42	42+155	OFDM	BPSK	130.0	Radio 2 (2TX)
		5745-5825	155		OFDM	BPSK	130.0	Radio 2 (2TX)

Radiated Emission Test (Below 1GHz):

- Pre-Scan has been conducted to determine the worst-case mode from all possible combinations between available modulations, data rates and antenna ports (if EUT with antenna diversity architecture).
- Following channel(s) was (were) selected for the final test as listed below.

EUT CONFIGURE MODE	MODE	FREQ. BAND (MHz)	AVAILABLE CHANNEL	TESTED CHANNEL	MODULATION TECHNOLOGY	MODULATION TYPE	DATA RATE (Mbps)	REMARK
A, B	802.11n (HT20)	5180-5240	36 to 48	149	OFDM	BPSK	7.2	Radio 2 (4TX)
	802.11n (HT20)	5745-5825	149 to 165		OFDM	BPSK	7.2	Radio 2 (4TX)

Power Line Conducted Emission Test:

- Pre-Scan has been conducted to determine the worst-case mode from all possible combinations between available modulations, data rates and antenna ports (if EUT with antenna diversity architecture).
- Following channel(s) was (were) selected for the final test as listed below.

EUT CONFIGURE MODE	MODE	FREQ. BAND (MHz)	AVAILABLE CHANNEL	TESTED CHANNEL	MODULATION TECHNOLOGY	MODULATION TYPE	DATA RATE (Mbps)	REMARK
A, B	802.11n (HT20)	5180-5240	36 to 48	149	OFDM	BPSK	7.2	Radio 2 (4TX)
	802.11n (HT20)	5745-5825	149 to 165		OFDM	BPSK	7.2	Radio 2 (4TX)

Antenna Port Conducted Measurement:

- This item includes all test value of each mode, but only includes spectrum plot of worst value of each mode.
- Pre-Scan has been conducted to determine the worst-case mode from all possible combinations between available modulations, data rates and antenna ports (if EUT with antenna diversity architecture).
- Following channel(s) was (were) selected for the final test as listed below.

EUT CONFIGURE MODE	MODE	FREQ. BAND (MHz)	AVAILABLE CHANNEL	TESTED CHANNEL	MODULATION TECHNOLOGY	MODULATION TYPE	DATA RATE (Mbps)	REMARK
A	802.11a	5180-5240	36 to 48	36, 40, 48	OFDM	BPSK	6.0	Radio 2 (4TX)
A	802.11n (HT20)		36 to 48	36, 40, 48	OFDM	BPSK	7.2	Radio 2 (4TX)
A	802.11n (HT40)		38 to 46	38, 46	OFDM	BPSK	15.0	Radio 2 (4TX)
A	802.11ac (VHT80)		42	42	OFDM	BPSK	130.0	Radio 2 (4TX)
A	802.11a	5745-5825	149 to 165	149, 157, 165	OFDM	BPSK	6.0	Radio 2 (4TX)
A	802.11n (HT20)		149 to 165	149, 157, 165	OFDM	BPSK	7.2	Radio 2 (4TX)
A	802.11n (HT40)		151 to 159	151, 159	OFDM	BPSK	15.0	Radio 2 (4TX)
A	802.11ac (VHT80)		155	155	OFDM	BPSK	130.0	Radio 2 (4TX)
A	802.11ac (VHT80+VHT80)	5180-5240	42	42+155	OFDM	BPSK	130.0	Radio 2 (2TX)
		5745-5825	155		OFDM	BPSK	130.0	Radio 2 (2TX)

Test Condition:

Applicable to	Environmental Conditions	Input Power	Tested by
RE \geq 1G	18 deg. C, 70% RH	120Vac, 60Hz	Nick Hsu, James Yang, Jones Chang
	19 deg. C, 70% RH		James Yang, Jones Chang
RE<1G	18 deg. C, 70% RH	120Vac, 60Hz, 48Vdc	Jones Chang
PLC	20 deg. C, 70% RH	120Vac, 60Hz, 48Vdc	Jones Chang
APCM	25 deg. C, 60% RH	120Vac, 60Hz	Leo Tsai, Ted Chang

3.3 Duty Cycle of Test Signal

Duty cycle of test signal is > 98%, duty factor is not required

Duty cycle of test signal is < 98 %, duty factor is required

Radio 2: CDD Mode

802.11a: Duty cycle = $2.052/2.132 = 0.962$, Duty factor = $10 * \log(1/0.962) = 0.17$

802.11n (HT20): Duty cycle = $4.995/5.065 = 0.986$

802.11n (HT40): Duty cycle = $2.425/2.492 = 0.973$, Duty factor = $10 * \log(1/0.973) = 0.12$

802.11ac (VHT80): Duty cycle = $1.145/1.215 = 0.942$, Duty factor = $10 * \log(1/0.942) = 0.26$

802.11ac (VHT80+VHT80): Duty cycle = $1.145/1.222 = 0.937$, Duty factor = $10 * \log(1/0.937) = 0.28$

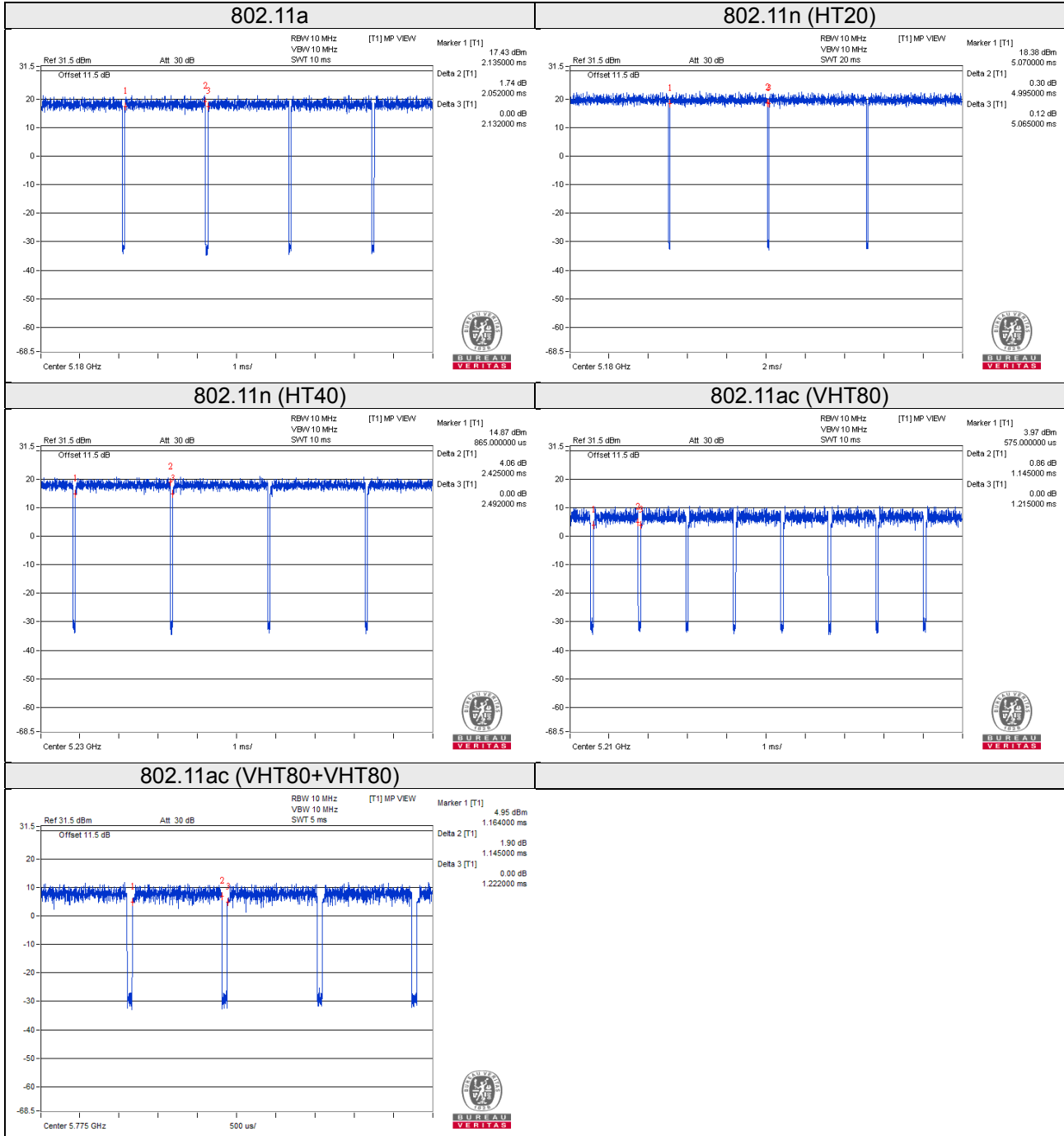

3.4 Description of Support Units

The EUT has been tested as an independent unit together with other necessary accessories or support units. The following support units or accessories were used to form a representative test configuration during the tests.

ID	Product	Brand	Model No.	Serial No.	FCC ID	Remarks
A.	Notebook	DELL	E5410	1HC2XM1	FCC DoC Approved	-
B.	Adapter	AOEM	ADS036T-W120300	N/A	N/A	Provided by manufacturer For test mode A
C.	POE	EnGenius	EPE-48GR	N/A	N/A	Provided by manufacturer For test mode B
D.	POE adapter	Powertron Electronics Corp.	PA1040-480IB080	N/A	N/A	Provided by manufacturer For test mode B
E.	Load	N/A	N/A	N/A	N/A	-
F.	USB Flash	HP	v250W	01	FCC DoC Approved	-

Note:

1. All power cords of the above support units are non-shielded (1.8m).
2. Item A acted as communication partner to transfer data.

ID	Descriptions	Qty.	Length (m)	Shielding (Yes/No)	Cores (Qty.)	Remarks
1.	RJ45 Cable	1	3	N	0	Cat5e
2.	Power Cable	1	1.5	-	1	For test mode A
3.	Power Cable	1	1.55	-	1	For test mode B
4.	RJ45 Cable	1	1.8	N	0	Cat5e
5.	RJ45 to RS-232 Cable	1	1.8	N	0	-
6.	RJ45 Cable	1	1.8	N	0	Cat5e

Note: The core(s) is(are) originally attached to the cable(s).

3.4.1 Configuration of System under Test

Test Mode A

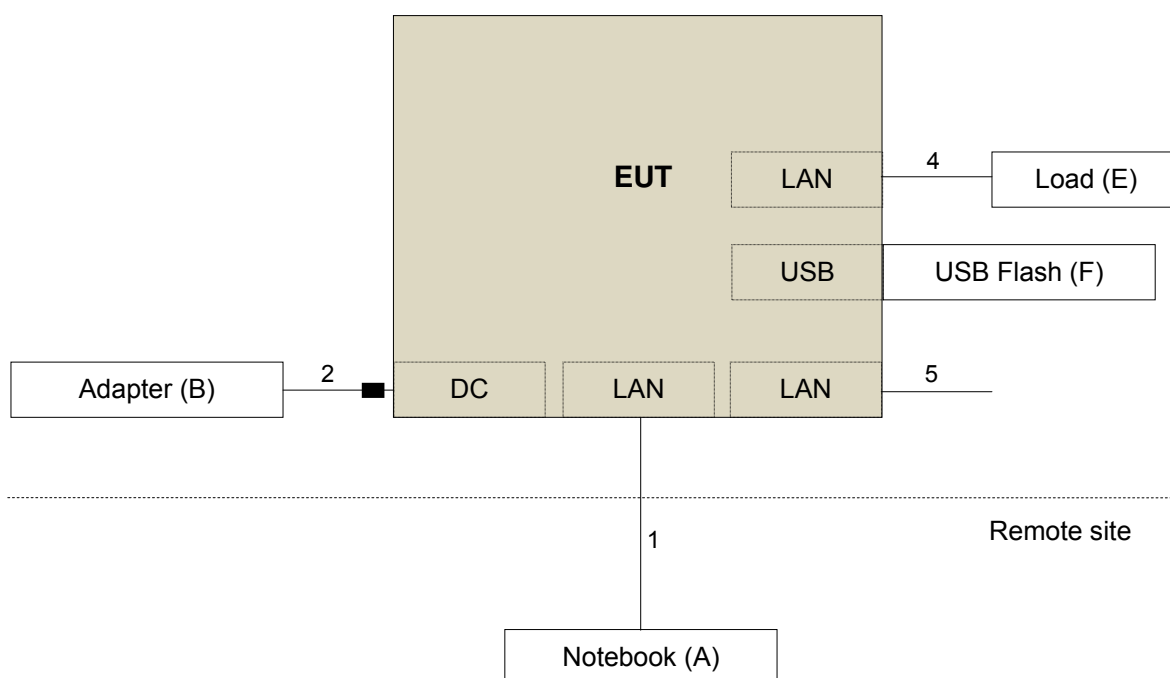

Test Mode B

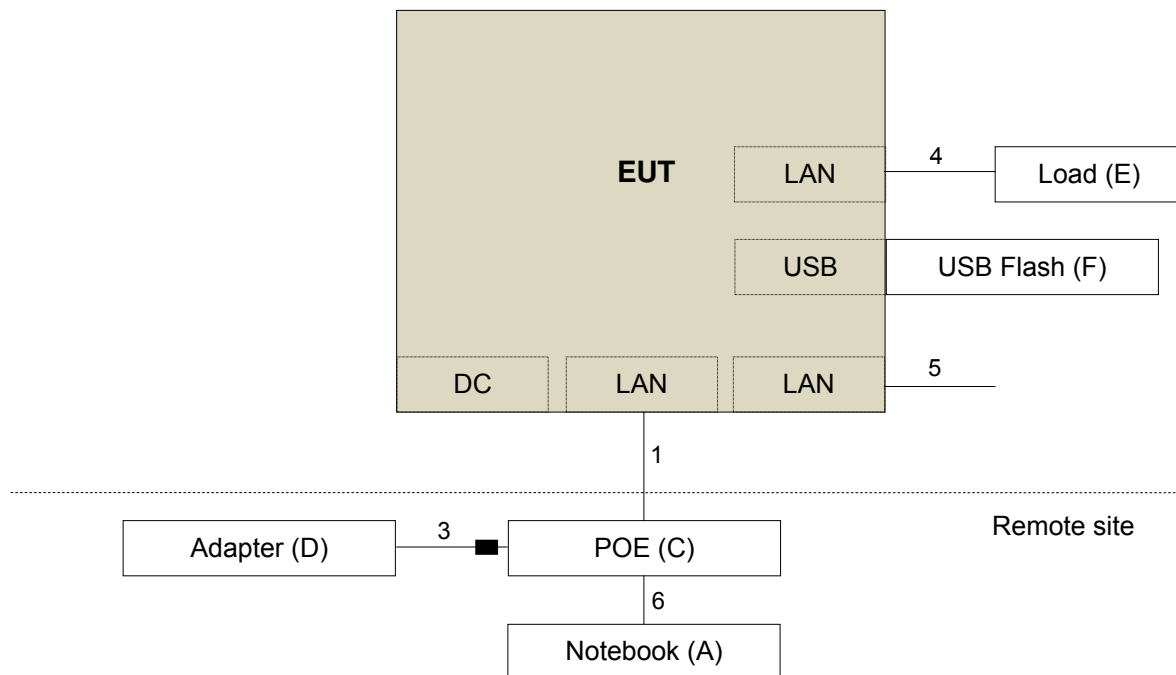

3.5 General Description of Applied Standard

The EUT is a RF Product. According to the specifications of the manufacturer, it must comply with the requirements of the following standards:

FCC Part 15, Subpart E (15.407)
789033 D02 General UNII Test Procedures New Rules v01r03
662911 D01 Multiple Transmitter Output v02r01
 ANSI C63.10:2013

All test items have been performed and recorded as per the above standards.

Note: The EUT has been verified to comply with the requirements of FCC Part 15, Subpart B, Class B (DoC).
 The test report has been issued separately.

4 Test Types and Results

4.1 Radiated Emission and Bandedge Measurement

4.1.1 Limits of Radiated Emission and Bandedge Measurement

Radiated emissions which fall in the restricted bands must comply with the radiated emission limits specified as below table.

Frequencies (MHz)	Field Strength (microvolts/meter)	Measurement Distance (meters)
0.009 ~ 0.490	2400/F(kHz)	300
0.490 ~ 1.705	24000/F(kHz)	30
1.705 ~ 30.0	30	30
30 ~ 88	100	3
88 ~ 216	150	3
216 ~ 960	200	3
Above 960	500	3

NOTE:

- The lower limit shall apply at the transition frequencies.
- Emission level (dBuV/m) = 20 log Emission level (uV/m).
- For frequencies above 1000MHz, the field strength limits are based on average detector, however, the peak field strength of any emission shall not exceed the maximum permitted average limits, specified above by more than 20dB under any condition of modulation.

Limits of unwanted emission out of the restricted bands

Applicable To		Limit	
789033 D02 General UNII Test Procedure New Rules v01r03		Field Strength at 3m	
		PK:74 (dBµV/m)	AV:54 (dBµV/m)
Frequency Band	Applicable To	EIRP Limit	Equivalent Field Strength at 3m
5150~5250 MHz	15.407(b)(1)	PK:-27 (dBm/MHz)	PK:68.2(dBµV/m)
5250~5350 MHz	15.407(b)(2)		
5470~5725 MHz	15.407(b)(3)		
5725~5850 MHz	<input checked="" type="checkbox"/> 15.407(b)(4)(i)	PK:-27 (dBm/MHz) ^{*1} PK:10 (dBm/MHz) ^{*2} PK:15.6 (dBm/MHz) ^{*3} PK:27 (dBm/MHz) ^{*4}	PK: 68.2(dBµV/m) ^{*1} PK:105.2 (dBµV/m) ^{*2} PK: 110.8(dBµV/m) ^{*3} PK:122.2 (dBµV/m) ^{*4}
	<input type="checkbox"/> 15.407(b)(4)(ii)	Emission limits in section 15.247(d)	
^{*1} beyond 75 MHz or more above of the band edge. ^{*3} below the band edge increasing linearly to a level of 15.6 dBm/MHz at 5 MHz above.		^{*2} below the band edge increasing linearly to 10 dBm/MHz at 25 MHz above. ^{*4} from 5 MHz above or below the band edge increasing linearly to a level of 27 dBm/MHz at the band edge.	

Note:

The following formula is used to convert the equipment isotropic radiated power (eirp) to field strength:

$$E = \frac{1000000 \sqrt{30P}}{3} \mu\text{V/m, where } P \text{ is the eirp (Watts).}$$

4.1.2 Test Instruments

Description & Manufacturer	Model No.	Serial No.	Cal. Date	Cal. Due
Test Receiver ROHDE & SCHWARZ	ESIB7	100187	Apr. 18, 2016	Apr. 17, 2017
Spectrum Analyzer ROHDE & SCHWARZ	FSP40	100041	Sep. 02, 2015	Sep. 01, 2016
			Sep. 02, 2016	Sep. 01, 2017
BILOG Antenna SCHWARZBECK	VULB9168	9168-171	Jan. 07, 2016	Jan. 06, 2017
HORN Antenna SCHWARZBECK	9120D	209	Jan. 20, 2016	Jan. 19, 2017
HORN Antenna SCHWARZBECK	BBHA 9170	BBHA9170241	Jan. 18, 2016	Jan. 17, 2017
Loop Antenna	EM-6879	269	Aug. 11, 2016	Aug. 10, 2017
			Aug. 11, 2016	Aug. 10, 2017
Preamplifier Agilent	8447D	2944A10738	Oct.18, 2015	Oct. 17, 2016
Preamplifier Agilent	8449B	3008A01964	Aug. 22, 2015	Aug. 21, 2016
			Aug. 22, 2016	Aug. 21, 2017
RF signal cable HUBER+SUHNER	SUCOFLEX 104	Cable-CH3-03 (214378)	Aug. 22, 2015	Aug. 21, 2016
			Aug. 22, 2016	Aug. 21, 2017
RF signal cable HUBER+SUHNER	SUCOFLEX 106	Cable-CH3-03 (309224+12738)	Aug. 22, 2015	Aug. 21, 2016
			Aug. 22, 2016	Aug. 21, 2017
Software BV ADT	ADT_Radiated_ V7.6.15.9.4	NA	NA	NA
Antenna Tower inn-co GmbH	MA 4000	013303	NA	NA
Antenna Tower Controller BV ADT	AT100	AT93021702	NA	NA
Turn Table BV ADT	TT100	TT93021702	NA	NA
Turn Table Controller BV ADT	SC100	SC93021702	NA	NA
26GHz ~ 40GHz Amplifier	EM26400	815221	Oct. 18, 2015	Oct. 17, 2016
High Speed Peak Power Meter	ML2495A	0824011	Jul. 09, 2015	Jul. 08, 2016
			Jul. 09, 2016	Jul. 08, 2017
Power Sensor	MA2411B	0738171	Jul. 09, 2015	Jul. 08, 2016
			Jul. 09, 2016	Jul. 08, 2017
WIT Standard Temperature And Humidity Chamber	TH-4S-C	W981030	Jun. 08, 2016	Jun. 07, 2017

- Note: 1. The calibration interval of the above test instruments is 12 months and the calibrations are traceable to NML/ROC and NIST/USA.
2. The test was performed in HwaYa Chamber 3.
3. The horn antenna and preamplifier (model: 8449B) are used only for the measurement of emission frequency above 1GHz if tested.
4. The FCC Site Registration No. is 988962.
5. The IC Site Registration No. is IC 7450F-3.

4.1.3 Test Procedure

For Radiated emission below 30MHz

- a. The EUT was placed on the top of a rotating table 0.8 meters above the ground at a 3 meter chamber room. The table was rotated 360 degrees to determine the position of the highest radiation.
- b. The EUT was set 3 meters away from the interference-receiving antenna, which was mounted on the top of a variable-height antenna tower.
- c. Both X and Y axes of the antenna are set to make the measurement.
- d. For each suspected emission, the EUT was arranged to its worst case and the rotatable table was turned from 0 degrees to 360 degrees to find the maximum reading.
- e. The test-receiver system was set to Quasi-Peak Detect Function and Specified Bandwidth with Maximum Hold Mode.

Note:

1. The resolution bandwidth and video bandwidth of test receiver/spectrum analyzer is 9kHz at frequency below 30MHz.

For Radiated emission above 30MHz

- a. The EUT was placed on the top of a rotating table 0.8 meters (for 30MHz ~ 1GHz) / 1.5 meters (for above 1GHz) above the ground at 3 meter chamber room for test. The table was rotated 360 degrees to determine the position of the highest radiation.
- b. The EUT was set 3 meters away from the interference-receiving antenna, which was mounted on the top of a variable-height antenna tower.
- c. The height of antenna is varied from one meter to four meters above the ground to determine the maximum value of the field strength. Both horizontal and vertical polarizations of the antenna are set to make the measurement.
- d. For each suspected emission, the EUT was arranged to its worst case and then the antenna was tuned to heights from 1 meter to 4 meters and the rotatable table was turned from 0 degrees to 360 degrees to find the maximum reading.
- e. The test-receiver system was set to quasi-peak detect function and specified bandwidth with maximum hold mode when the test frequency is below 1 GHz.
- f. The test-receiver system was set to peak and average detect function and specified bandwidth with maximum hold mode when the test frequency is above 1 GHz. If the peak reading value also meets average limit, measurement with the average detector is unnecessary.

Note:

1. The resolution bandwidth and video bandwidth of test receiver/spectrum analyzer is 120kHz for Quasi-peak detection (QP) at frequency below 1GHz.
2. The resolution bandwidth of test receiver/spectrum analyzer is 1 MHz and the video bandwidth is 3 MHz for Peak detection (PK) at frequency above 1GHz.
3. The resolution bandwidth of test receiver/spectrum analyzer is 1MHz and the video bandwidth is $\geq 1/T$ (Duty cycle < 98%) or 10Hz (Duty cycle $\geq 98\%$) for Average detection (AV) at frequency above 1GHz.
4. All modes of operation were investigated and the worst-case emissions are reported.

4.1.4 Deviation from Test Standard

No deviation.

4.1.5 Test Setup

For Radiated emission below 30MHz

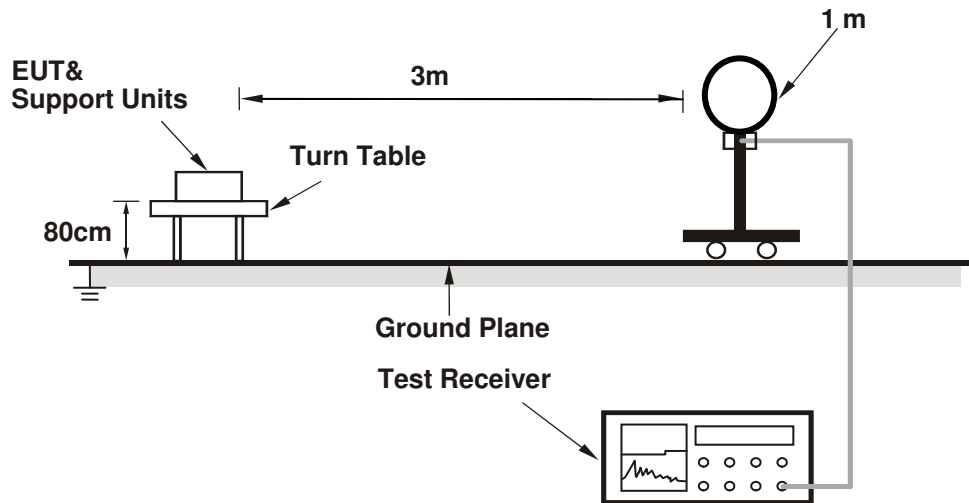

For Radiated emission 30MHz to 1GHz

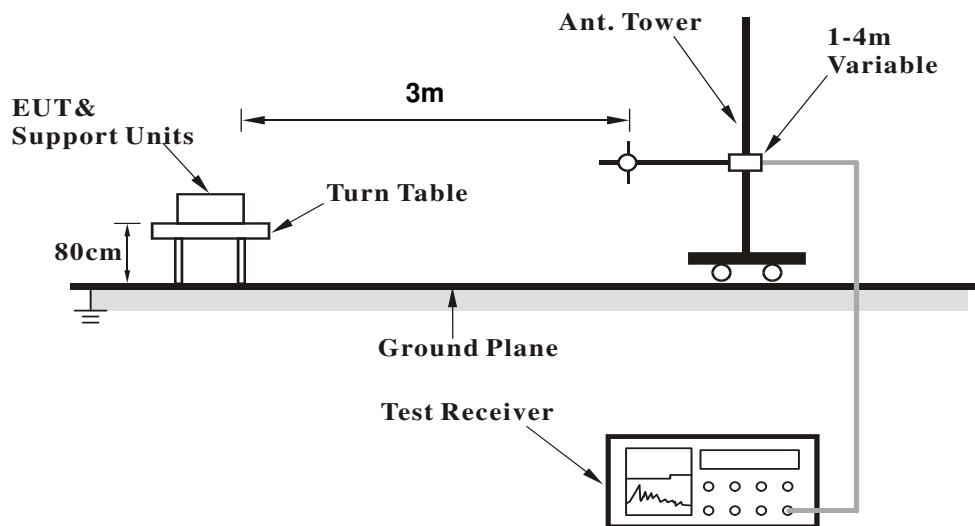

For Radiated emission above 1GHz

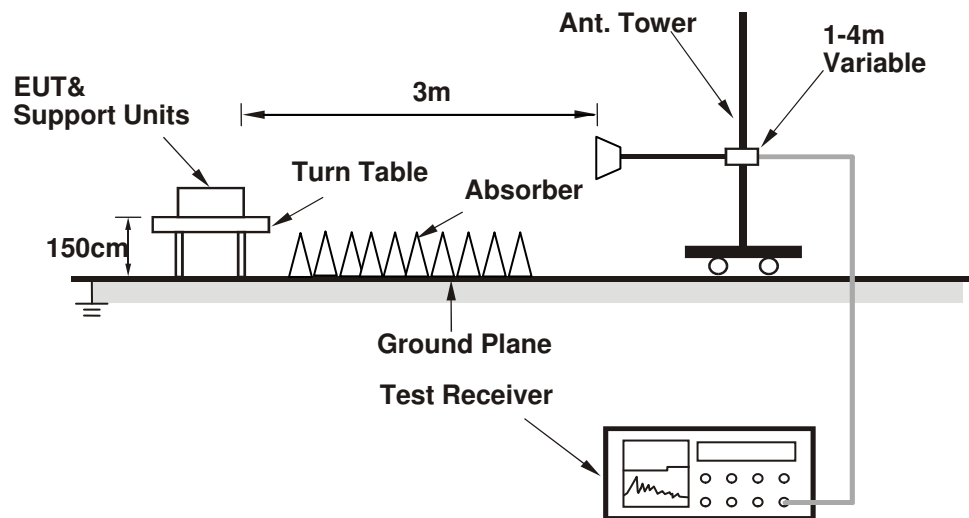

For the actual test configuration, please refer to the attached file (Test Setup Photo).

4.1.6 EUT Operating Conditions

- a. Placed the EUT on the testing table.
- b. Prepared a notebook to act as a communication partner and placed it outside of testing area.
- c. The communication partner connected with EUT via a RJ45 cable and ran a test program (provided by manufacturer) to enable EUT under transmission condition continuously at specific channel frequency.
- d. The communication partner sent data to EUT by command "PING".

4.1.7 Test Results

Above 1GHz Data:

Radio 2: CDD Mode

802.11a

CHANNEL	TX Channel 36	DETECTOR FUNCTION	Peak (PK)
FREQUENCY RANGE	1GHz ~ 40GHz		Average (AV)

ANTENNA POLARITY & TEST DISTANCE: HORIZONTAL AT 3 M								
NO.	FREQ. (MHz)	EMISSION LEVEL (dBuV/m)	LIMIT (dBuV/m)	MARGIN (dB)	ANTENNA HEIGHT (m)	TABLE ANGLE (Degree)	RAW VALUE (dBuV)	CORRECTION FACTOR (dB/m)
1	5150.00	68.6 PK	74.0	-5.4	1.79 H	286	62.60	6.00
2	5150.00	52.7 AV	54.0	-1.3	1.79 H	286	46.70	6.00
3	*5180.00	120.8 PK			1.77 H	289	81.40	39.40
4	*5180.00	110.3 AV			1.77 H	289	70.90	39.40
5	#10360.00	61.8 PK	74.0	-12.2	1.79 H	279	44.00	17.80
6	#10360.00	48.8 AV	54.0	-5.2	1.79 H	279	31.00	17.80
ANTENNA POLARITY & TEST DISTANCE: VERTICAL AT 3 M								
NO.	FREQ. (MHz)	EMISSION LEVEL (dBuV/m)	LIMIT (dBuV/m)	MARGIN (dB)	ANTENNA HEIGHT (m)	TABLE ANGLE (Degree)	RAW VALUE (dBuV)	CORRECTION FACTOR (dB/m)
1	5150.00	63.4 PK	74.0	-10.6	2.13 V	352	57.40	6.00
2	5150.00	49.6 AV	54.0	-4.4	2.13 V	352	43.60	6.00
3	*5180.00	117.9 PK			3.73 V	19	78.50	39.40
4	*5180.00	107.5 AV			3.73 V	19	68.10	39.40
5	#10360.00	61.1 PK	74.0	-12.9	2.22 V	0	43.30	17.80
6	#10360.00	47.9 AV	54.0	-6.1	2.22 V	0	30.10	17.80

REMARKS:

- Emission Level(dBuV/m) = Raw Value(dBuV) + Correction Factor(dB/m)
- Correction Factor(dB/m) = Antenna Factor(dB/m) + Cable Factor(dB) – Pre-Amplifier Factor(dB)
- The other emission levels were very low against the limit.
- Margin value = Emission Level – Limit value
- " * ": Fundamental frequency.
- " # ": The radiated frequency is out of the restricted band.

CHANNEL	TX Channel 40	DETECTOR FUNCTION	Peak (PK)
FREQUENCY RANGE	1GHz ~ 40GHz		Average (AV)

ANTENNA POLARITY & TEST DISTANCE: HORIZONTAL AT 3 M

NO.	FREQ. (MHz)	EMISSION LEVEL (dBuV/m)	LIMIT (dBuV/m)	MARGIN (dB)	ANTENNA HEIGHT (m)	TABLE ANGLE (Degree)	RAW VALUE (dBuV)	CORRECTION FACTOR (dB/m)
1	*5200.00	124.1 PK			1.62 H	291	84.60	39.50
2	*5200.00	113.5 AV			1.62 H	291	74.00	39.50
3	#10400.00	65.5 PK	74.0	-8.5	1.45 H	284	47.80	17.70
4	#10400.00	52.5 AV	54.0	-1.5	1.45 H	284	34.80	17.70

ANTENNA POLARITY & TEST DISTANCE: VERTICAL AT 3 M

NO.	FREQ. (MHz)	EMISSION LEVEL (dBuV/m)	LIMIT (dBuV/m)	MARGIN (dB)	ANTENNA HEIGHT (m)	TABLE ANGLE (Degree)	RAW VALUE (dBuV)	CORRECTION FACTOR (dB/m)
1	*5200.00	121.8 PK			3.24 V	358	82.30	39.50
2	*5200.00	111.1 AV			3.24 V	358	71.60	39.50
3	#10400.00	61.0 PK	74.0	-13.0	3.31 V	315	43.30	17.70
4	#10400.00	48.3 AV	54.0	-5.7	3.31 V	315	30.60	17.70

REMARKS:

1. Emission Level(dBuV/m) = Raw Value(dBuV) + Correction Factor(dB/m)
2. Correction Factor(dB/m) = Antenna Factor(dB/m) + Cable Factor(dB)
– Pre-Amplifier Factor(dB)
3. The other emission levels were very low against the limit.
4. Margin value = Emission Level – Limit value
5. " * ": Fundamental frequency.
6. " # ": The radiated frequency is out of the restricted band.

CHANNEL	TX Channel 48	DETECTOR FUNCTION	Peak (PK)
FREQUENCY RANGE	1GHz ~ 40GHz		Average (AV)

ANTENNA POLARITY & TEST DISTANCE: HORIZONTAL AT 3 M

NO.	FREQ. (MHz)	EMISSION LEVEL (dBuV/m)	LIMIT (dBuV/m)	MARGIN (dB)	ANTENNA HEIGHT (m)	TABLE ANGLE (Degree)	RAW VALUE (dBuV)	CORRECTION FACTOR (dB/m)
1	*5240.00	121.0 PK			1.68 H	289	81.40	39.60
2	*5240.00	110.4 AV			1.68 H	289	70.80	39.60
3	5350.00	48.0 PK	74.0	-26.0	2.01 H	210	41.50	6.50
4	5350.00	45.9 AV	54.0	-8.1	2.01 H	210	39.40	6.50
5	#10480.00	67.7 PK	74.0	-6.3	1.61 H	306	49.00	18.70
6	#10480.00	52.8 AV	54.0	-1.2	1.61 H	306	34.10	18.70

ANTENNA POLARITY & TEST DISTANCE: VERTICAL AT 3 M

NO.	FREQ. (MHz)	EMISSION LEVEL (dBuV/m)	LIMIT (dBuV/m)	MARGIN (dB)	ANTENNA HEIGHT (m)	TABLE ANGLE (Degree)	RAW VALUE (dBuV)	CORRECTION FACTOR (dB/m)
1	*5240.00	117.1 PK			3.62 V	15	77.50	39.60
2	*5240.00	106.8 AV			3.62 V	15	67.20	39.60
3	5350.00	59.0 PK	74.0	-15.0	2.85 V	223	52.50	6.50
4	5350.00	46.1 AV	54.0	-7.9	2.85 V	223	39.60	6.50
5	#10480.00	60.5 PK	74.0	-13.5	2.01 V	194	41.80	18.70
6	#10480.00	47.8 AV	54.0	-6.2	2.01 V	194	29.10	18.70

REMARKS:

1. Emission Level(dBuV/m) = Raw Value(dBuV) + Correction Factor(dB/m)
2. Correction Factor(dB/m) = Antenna Factor(dB/m) + Cable Factor(dB)
– Pre-Amplifier Factor(dB)
3. The other emission levels were very low against the limit.
4. Margin value = Emission Level – Limit value
5. " * ": Fundamental frequency.
6. " # ": The radiated frequency is out of the restricted band.

CHANNEL	TX Channel 149	DETECTOR FUNCTION	Peak (PK)
FREQUENCY RANGE	1GHz ~ 40GHz		Average (AV)

ANTENNA POLARITY & TEST DISTANCE: HORIZONTAL AT 3 M

NO.	FREQ. (MHz)	EMISSION LEVEL (dBuV/m)	LIMIT (dBuV/m)	MARGIN (dB)	ANTENNA HEIGHT (m)	TABLE ANGLE (Degree)	RAW VALUE (dBuV)	CORRECTION FACTOR (dB/m)
1	#5620.00	58.9 PK	68.2	-9.3	2.09 H	54	51.80	7.10
2	*5745.00	124.4 PK			2.09 H	54	83.90	40.50
3	*5745.00	114.1 AV			2.09 H	54	73.60	40.50
4	#5997.60	60.3 PK	68.2	-7.9	2.09 H	54	52.40	7.90
5	11490.00	63.6 PK	74.0	-10.4	2.16 H	274	44.90	18.70
6	11490.00	50.2 AV	54.0	-3.8	2.16 H	274	31.50	18.70

ANTENNA POLARITY & TEST DISTANCE: VERTICAL AT 3 M

NO.	FREQ. (MHz)	EMISSION LEVEL (dBuV/m)	LIMIT (dBuV/m)	MARGIN (dB)	ANTENNA HEIGHT (m)	TABLE ANGLE (Degree)	RAW VALUE (dBuV)	CORRECTION FACTOR (dB/m)
1	#5619.20	58.4 PK	68.2	-9.8	2.83 V	346	51.30	7.10
2	*5745.00	117.1 PK			2.83 V	346	76.60	40.50
3	*5745.00	106.9 AV			2.83 V	346	66.40	40.50
4	#5963.20	59.4 PK	68.2	-8.8	2.83 V	346	51.60	7.80
5	11490.00	61.2 PK	74.0	-12.8	2.31 V	300	42.50	18.70
6	11490.00	47.8 AV	54.0	-6.2	2.31 V	300	29.10	18.70

REMARKS:

1. Emission Level(dBuV/m) = Raw Value(dBuV) + Correction Factor(dB/m)
2. Correction Factor(dB/m) = Antenna Factor(dB/m) + Cable Factor(dB)
– Pre-Amplifier Factor(dB)
3. The other emission levels were very low against the limit.
4. Margin value = Emission Level – Limit value
5. " * ": Fundamental frequency.
6. " # ": The radiated frequency is out of the restricted band.

CHANNEL	TX Channel 157	DETECTOR FUNCTION	Peak (PK)
FREQUENCY RANGE	1GHz ~ 40GHz		Average (AV)

ANTENNA POLARITY & TEST DISTANCE: HORIZONTAL AT 3 M

NO.	FREQ. (MHz)	EMISSION LEVEL (dBuV/m)	LIMIT (dBuV/m)	MARGIN (dB)	ANTENNA HEIGHT (m)	TABLE ANGLE (Degree)	RAW VALUE (dBuV)	CORRECTION FACTOR (dB/m)
1	#5632.00	58.7 PK	68.2	-9.5	2.06 H	52	51.60	7.10
2	*5785.00	124.4 PK			2.06 H	52	83.80	40.60
3	*5785.00	114.3 AV			2.06 H	52	73.70	40.60
4	#5960.00	59.2 PK	68.2	-9.0	2.06 H	52	51.50	7.70
5	11570.00	61.8 PK	74.0	-12.2	2.72 H	305	43.10	18.70
6	11570.00	49.1 AV	54.0	-4.9	2.72 H	305	30.40	18.70

ANTENNA POLARITY & TEST DISTANCE: VERTICAL AT 3 M

NO.	FREQ. (MHz)	EMISSION LEVEL (dBuV/m)	LIMIT (dBuV/m)	MARGIN (dB)	ANTENNA HEIGHT (m)	TABLE ANGLE (Degree)	RAW VALUE (dBuV)	CORRECTION FACTOR (dB/m)
1	#5624.00	59.1 PK	68.2	-9.1	3.20 V	22	52.00	7.10
2	*5785.00	117.6 PK			3.20 V	22	77.00	40.60
3	*5785.00	107.5 AV			3.20 V	22	66.90	40.60
4	#5996.00	60.5 PK	68.2	-7.7	3.20 V	22	52.60	7.90
5	11570.00	61.3 PK	74.0	-12.7	2.56 V	254	42.60	18.70
6	11570.00	48.1 AV	54.0	-5.9	2.56 V	254	29.40	18.70

REMARKS:

1. Emission Level(dBuV/m) = Raw Value(dBuV) + Correction Factor(dB/m)
2. Correction Factor(dB/m) = Antenna Factor(dB/m) + Cable Factor(dB)
– Pre-Amplifier Factor(dB)
3. The other emission levels were very low against the limit.
4. Margin value = Emission Level – Limit value
5. " * ": Fundamental frequency.
6. " # ": The radiated frequency is out of the restricted band.

CHANNEL	TX Channel 165	DETECTOR FUNCTION	Peak (PK)
FREQUENCY RANGE	1GHz ~ 40GHz		Average (AV)

ANTENNA POLARITY & TEST DISTANCE: HORIZONTAL AT 3 M

NO.	FREQ. (MHz)	EMISSION LEVEL (dBuV/m)	LIMIT (dBuV/m)	MARGIN (dB)	ANTENNA HEIGHT (m)	TABLE ANGLE (Degree)	RAW VALUE (dBuV)	CORRECTION FACTOR (dB/m)
1	#5616.00	57.9 PK	68.2	-10.3	1.93 H	60	50.80	7.10
2	*5825.00	124.1 PK			1.93 H	60	83.50	40.60
3	*5825.00	114.1 AV			1.93 H	60	73.50	40.60
4	#5941.60	60.1 PK	68.2	-8.1	1.93 H	60	52.40	7.70
5	11650.00	62.0 PK	74.0	-12.0	2.65 H	300	42.80	19.20
6	11650.00	49.0 AV	54.0	-5.0	2.65 H	300	29.80	19.20

ANTENNA POLARITY & TEST DISTANCE: VERTICAL AT 3 M

NO.	FREQ. (MHz)	EMISSION LEVEL (dBuV/m)	LIMIT (dBuV/m)	MARGIN (dB)	ANTENNA HEIGHT (m)	TABLE ANGLE (Degree)	RAW VALUE (dBuV)	CORRECTION FACTOR (dB/m)
1	#5632.80	59.4 PK	68.2	-8.8	3.15 V	19	52.30	7.10
2	*5825.00	118.4 PK			3.15 V	19	77.80	40.60
3	*5825.00	108.4 AV			3.15 V	19	67.80	40.60
4	#5971.20	60.3 PK	68.2	-7.9	3.15 V	19	52.50	7.80
5	11650.00	62.3 PK	74.0	-11.7	2.33 V	270	43.10	19.20
6	11650.00	49.2 AV	54.0	-4.8	2.33 V	270	30.00	19.20

REMARKS:

1. Emission Level(dBuV/m) = Raw Value(dBuV) + Correction Factor(dB/m)
2. Correction Factor(dB/m) = Antenna Factor(dB/m) + Cable Factor(dB)
– Pre-Amplifier Factor(dB)
3. The other emission levels were very low against the limit.
4. Margin value = Emission Level – Limit value
5. " * ": Fundamental frequency.
6. " # ": The radiated frequency is out of the restricted band.

802.11n (HT20)

CHANNEL	TX Channel 36	DETECTOR FUNCTION	Peak (PK)
FREQUENCY RANGE	1GHz ~ 40GHz		Average (AV)

ANTENNA POLARITY & TEST DISTANCE: HORIZONTAL AT 3 M

NO.	FREQ. (MHz)	EMISSION LEVEL (dBuV/m)	LIMIT (dBuV/m)	MARGIN (dB)	ANTENNA HEIGHT (m)	TABLE ANGLE (Degree)	RAW VALUE (dBuV)	CORRECTION FACTOR (dB/m)
1	5150.00	66.8 PK	74.0	-7.2	2.20 H	280	60.80	6.00
2	5150.00	52.5 AV	54.0	-1.5	2.20 H	280	46.50	6.00
3	*5180.00	121.9 PK			2.02 H	51	82.50	39.40
4	*5180.00	111.6 AV			2.02 H	51	72.20	39.40
5	#10360.00	63.2 PK	74.0	-10.8	2.17 H	278	45.40	17.80
6	#10360.00	49.7 AV	54.0	-4.3	2.17 H	278	31.90	17.80

ANTENNA POLARITY & TEST DISTANCE: VERTICAL AT 3 M

NO.	FREQ. (MHz)	EMISSION LEVEL (dBuV/m)	LIMIT (dBuV/m)	MARGIN (dB)	ANTENNA HEIGHT (m)	TABLE ANGLE (Degree)	RAW VALUE (dBuV)	CORRECTION FACTOR (dB/m)
1	5150.00	63.2 PK	74.0	-10.8	3.15 V	1	57.20	6.00
2	5150.00	49.2 AV	54.0	-4.8	3.15 V	1	43.20	6.00
3	*5180.00	118.0 PK			3.12 V	1	78.60	39.40
4	*5180.00	107.5 AV			3.12 V	1	68.10	39.40
5	#10360.00	61.4 PK	74.0	-12.6	2.98 V	342	43.60	17.80
6	#10360.00	47.8 AV	54.0	-6.2	2.98 V	342	30.00	17.80

REMARKS:

1. Emission Level(dBuV/m) = Raw Value(dBuV) + Correction Factor(dB/m)
2. Correction Factor(dB/m) = Antenna Factor(dB/m) + Cable Factor(dB)
– Pre-Amplifier Factor(dB)
3. The other emission levels were very low against the limit.
4. Margin value = Emission Level – Limit value
5. " * ": Fundamental frequency.
6. " # ": The radiated frequency is out of the restricted band.

CHANNEL	TX Channel 40	DETECTOR FUNCTION	Peak (PK)
FREQUENCY RANGE	1GHz ~ 40GHz		Average (AV)

ANTENNA POLARITY & TEST DISTANCE: HORIZONTAL AT 3 M

NO.	FREQ. (MHz)	EMISSION LEVEL (dBuV/m)	LIMIT (dBuV/m)	MARGIN (dB)	ANTENNA HEIGHT (m)	TABLE ANGLE (Degree)	RAW VALUE (dBuV)	CORRECTION FACTOR (dB/m)
1	*5200.00	123.3 PK			1.59 H	292	83.80	39.50
2	*5200.00	112.5 AV			1.59 H	292	73.00	39.50
3	#10400.00	66.2 PK	74.0	-7.8	1.52 H	285	48.50	17.70
4	#10400.00	52.5 AV	54.0	-1.5	1.52 H	285	34.80	17.70

ANTENNA POLARITY & TEST DISTANCE: VERTICAL AT 3 M

NO.	FREQ. (MHz)	EMISSION LEVEL (dBuV/m)	LIMIT (dBuV/m)	MARGIN (dB)	ANTENNA HEIGHT (m)	TABLE ANGLE (Degree)	RAW VALUE (dBuV)	CORRECTION FACTOR (dB/m)
1	*5200.00	120.9 PK			3.23 V	356	81.40	39.50
2	*5200.00	110.4 AV			3.23 V	356	70.90	39.50
3	#10400.00	60.5 PK	74.0	-13.5	3.23 V	21	42.80	17.70
4	#10400.00	47.7 AV	54.0	-6.3	3.23 V	21	30.00	17.70

REMARKS:

1. Emission Level(dBuV/m) = Raw Value(dBuV) + Correction Factor(dB/m)
2. Correction Factor(dB/m) = Antenna Factor(dB/m) + Cable Factor(dB)
– Pre-Amplifier Factor(dB)
3. The other emission levels were very low against the limit.
4. Margin value = Emission Level – Limit value
5. " * ": Fundamental frequency.
6. " # ": The radiated frequency is out of the restricted band.

CHANNEL	TX Channel 48	DETECTOR FUNCTION	Peak (PK)
FREQUENCY RANGE	1GHz ~ 40GHz		Average (AV)

ANTENNA POLARITY & TEST DISTANCE: HORIZONTAL AT 3 M								
NO.	FREQ. (MHz)	EMISSION LEVEL (dBuV/m)	LIMIT (dBuV/m)	MARGIN (dB)	ANTENNA HEIGHT (m)	TABLE ANGLE (Degree)	RAW VALUE (dBuV)	CORRECTION FACTOR (dB/m)
1	*5240.00	120.7 PK			1.56 H	294	81.10	39.60
2	*5240.00	110.1 AV			1.56 H	294	70.50	39.60
3	5350.00	59.0 PK	74.0	-15.0	1.67 H	302	52.50	6.50
4	5350.00	46.1 AV	54.0	-7.9	1.67 H	302	39.60	6.50
5	#10480.00	66.9 PK	74.0	-7.1	1.62 H	307	48.20	18.70
6	#10480.00	52.7 AV	54.0	-1.3	1.62 H	307	34.00	18.70

ANTENNA POLARITY & TEST DISTANCE: VERTICAL AT 3 M								
NO.	FREQ. (MHz)	EMISSION LEVEL (dBuV/m)	LIMIT (dBuV/m)	MARGIN (dB)	ANTENNA HEIGHT (m)	TABLE ANGLE (Degree)	RAW VALUE (dBuV)	CORRECTION FACTOR (dB/m)
1	*5240.00	117.0 PK			2.94 V	330	77.40	39.60
2	*5240.00	106.5 AV			2.94 V	330	66.90	39.60
3	5350.00	58.2 PK	74.0	-15.8	2.47 V	149	51.70	6.50
4	5350.00	45.8 AV	54.0	-8.2	2.47 V	149	39.30	6.50
5	#10480.00	61.7 PK	74.0	-12.3	2.79 V	315	43.00	18.70
6	#10480.00	49.1 AV	54.0	-4.9	2.79 V	315	30.40	18.70

REMARKS:

1. Emission Level(dBuV/m) = Raw Value(dBuV) + Correction Factor(dB/m)
2. Correction Factor(dB/m) = Antenna Factor(dB/m) + Cable Factor(dB) – Pre-Amplifier Factor(dB)
3. The other emission levels were very low against the limit.
4. Margin value = Emission Level – Limit value
5. " * ": Fundamental frequency.
6. " # ": The radiated frequency is out of the restricted band.

CHANNEL	TX Channel 149	DETECTOR FUNCTION	Peak (PK)
FREQUENCY RANGE	1GHz ~ 40GHz		Average (AV)

ANTENNA POLARITY & TEST DISTANCE: HORIZONTAL AT 3 M

NO.	FREQ. (MHz)	EMISSION LEVEL (dBuV/m)	LIMIT (dBuV/m)	MARGIN (dB)	ANTENNA HEIGHT (m)	TABLE ANGLE (Degree)	RAW VALUE (dBuV)	CORRECTION FACTOR (dB/m)
1	#5644.80	59.9 PK	68.2	-8.3	2.20 H	54	52.80	7.10
2	*5745.00	124.0 PK			2.20 H	54	83.50	40.50
3	*5745.00	113.8 AV			2.20 H	54	73.30	40.50
4	#5978.40	61.0 PK	68.2	-7.2	2.20 H	54	53.10	7.90
5	11490.00	61.3 PK	74.0	-12.7	2.21 H	275	42.60	18.70
6	11490.00	48.5 AV	54.0	-5.5	2.21 H	275	29.80	18.70

ANTENNA POLARITY & TEST DISTANCE: VERTICAL AT 3 M

NO.	FREQ. (MHz)	EMISSION LEVEL (dBuV/m)	LIMIT (dBuV/m)	MARGIN (dB)	ANTENNA HEIGHT (m)	TABLE ANGLE (Degree)	RAW VALUE (dBuV)	CORRECTION FACTOR (dB/m)
1	#5618.40	58.6 PK	68.2	-9.6	3.04 V	0	51.50	7.10
2	*5745.00	119.7 PK			3.49 V	0	79.20	40.50
3	*5745.00	109.2 AV			3.49 V	0	68.70	40.50
4	#5975.20	59.1 PK	68.2	-9.1	3.04 V	0	51.20	7.90
5	11490.00	62.1 PK	74.0	-11.9	2.43 V	344	43.40	18.70
6	11490.00	49.2 AV	54.0	-4.8	2.43 V	344	30.50	18.70

REMARKS:

1. Emission Level(dBuV/m) = Raw Value(dBuV) + Correction Factor(dB/m)
2. Correction Factor(dB/m) = Antenna Factor(dB/m) + Cable Factor(dB)
– Pre-Amplifier Factor(dB)
3. The other emission levels were very low against the limit.
4. Margin value = Emission Level – Limit value
5. " * ": Fundamental frequency.
6. " # ": The radiated frequency is out of the restricted band.

CHANNEL	TX Channel 157	DETECTOR FUNCTION	Peak (PK)
FREQUENCY RANGE	1GHz ~ 40GHz		Average (AV)

ANTENNA POLARITY & TEST DISTANCE: HORIZONTAL AT 3 M

NO.	FREQ. (MHz)	EMISSION LEVEL (dBuV/m)	LIMIT (dBuV/m)	MARGIN (dB)	ANTENNA HEIGHT (m)	TABLE ANGLE (Degree)	RAW VALUE (dBuV)	CORRECTION FACTOR (dB/m)
1	#5625.60	59.4 PK	68.2	-8.8	2.12 H	54	52.30	7.10
2	*5785.00	123.5 PK			2.12 H	54	82.90	40.60
3	*5785.00	113.9 AV			2.12 H	54	73.30	40.60
4	#5980.80	60.6 PK	68.2	-7.6	2.12 H	54	52.70	7.90
5	11570.00	61.4 PK	74.0	-12.6	2.22 H	291	42.70	18.70
6	11570.00	48.5 AV	54.0	-5.5	2.22 H	291	29.80	18.70

ANTENNA POLARITY & TEST DISTANCE: VERTICAL AT 3 M

NO.	FREQ. (MHz)	EMISSION LEVEL (dBuV/m)	LIMIT (dBuV/m)	MARGIN (dB)	ANTENNA HEIGHT (m)	TABLE ANGLE (Degree)	RAW VALUE (dBuV)	CORRECTION FACTOR (dB/m)
1	#5618.40	59.6 PK	68.2	-8.6	2.98 V	322	52.50	7.10
2	*5785.00	117.8 PK			2.98 V	322	77.20	40.60
3	*5785.00	107.1 AV			2.98 V	322	66.50	40.60
4	#5963.20	60.4 PK	68.2	-7.8	2.98 V	322	52.60	7.80
5	11570.00	61.4 PK	74.0	-12.6	2.44 V	357	42.70	18.70
6	11570.00	48.5 AV	54.0	-5.5	2.44 V	357	29.80	18.70

REMARKS:

1. Emission Level(dBuV/m) = Raw Value(dBuV) + Correction Factor(dB/m)
2. Correction Factor(dB/m) = Antenna Factor(dB/m) + Cable Factor(dB)
– Pre-Amplifier Factor(dB)
3. The other emission levels were very low against the limit.
4. Margin value = Emission Level – Limit value
5. " * ": Fundamental frequency.
6. " # ": The radiated frequency is out of the restricted band.

CHANNEL	TX Channel 165	DETECTOR FUNCTION	Peak (PK)
FREQUENCY RANGE	1GHz ~ 40GHz		Average (AV)

ANTENNA POLARITY & TEST DISTANCE: HORIZONTAL AT 3 M

NO.	FREQ. (MHz)	EMISSION LEVEL (dBuV/m)	LIMIT (dBuV/m)	MARGIN (dB)	ANTENNA HEIGHT (m)	TABLE ANGLE (Degree)	RAW VALUE (dBuV)	CORRECTION FACTOR (dB/m)
1	#5608.00	59.6 PK	68.2	-8.6	2.09 H	50	52.50	7.10
2	*5825.00	123.5 PK			2.09 H	50	82.90	40.60
3	*5825.00	113.4 AV			2.09 H	50	72.80	40.60
4	#5948.00	60.7 PK	68.2	-7.5	2.09 H	50	53.00	7.70
5	11650.00	62.2 PK	74.0	-11.8	2.66 H	310	43.00	19.20
6	11650.00	49.1 AV	54.0	-4.9	2.66 H	310	29.90	19.20

ANTENNA POLARITY & TEST DISTANCE: VERTICAL AT 3 M

NO.	FREQ. (MHz)	EMISSION LEVEL (dBuV/m)	LIMIT (dBuV/m)	MARGIN (dB)	ANTENNA HEIGHT (m)	TABLE ANGLE (Degree)	RAW VALUE (dBuV)	CORRECTION FACTOR (dB/m)
1	#5636.80	58.0 PK	68.2	-10.2	3.15 V	345	50.90	7.10
2	*5825.00	116.9 PK			3.15 V	345	76.30	40.60
3	*5825.00	106.8 AV			3.15 V	345	66.20	40.60
4	#5927.20	60.3 PK	68.2	-7.9	3.15 V	345	52.60	7.70
5	11650.00	61.8 PK	74.0	-12.2	2.40 V	278	42.60	19.20
6	11650.00	48.7 AV	54.0	-5.3	2.40 V	278	29.50	19.20

REMARKS:

1. Emission Level(dBuV/m) = Raw Value(dBuV) + Correction Factor(dB/m)
2. Correction Factor(dB/m) = Antenna Factor(dB/m) + Cable Factor(dB)
– Pre-Amplifier Factor(dB)
3. The other emission levels were very low against the limit.
4. Margin value = Emission Level – Limit value
5. " * ": Fundamental frequency.
6. " # ": The radiated frequency is out of the restricted band.

802.11n (HT40)

CHANNEL	TX Channel 38	DETECTOR FUNCTION	Peak (PK)
FREQUENCY RANGE	1GHz ~ 40GHz		Average (AV)

ANTENNA POLARITY & TEST DISTANCE: HORIZONTAL AT 3 M

NO.	FREQ. (MHz)	EMISSION LEVEL (dBuV/m)	LIMIT (dBuV/m)	MARGIN (dB)	ANTENNA HEIGHT (m)	TABLE ANGLE (Degree)	RAW VALUE (dBuV)	CORRECTION FACTOR (dB/m)
1	5150.00	67.2 PK	74.0	-6.8	2.23 H	302	61.20	6.00
2	5150.00	52.4 AV	54.0	-1.6	2.23 H	302	46.40	6.00
3	*5190.00	114.7 PK			1.70 H	290	75.30	39.40
4	*5190.00	104.7 AV			1.70 H	290	65.30	39.40
5	#10380.00	60.0 PK	74.0	-14.0	1.88 H	290	42.30	17.70
6	#10380.00	46.9 AV	54.0	-7.1	1.88 H	290	29.20	17.70

ANTENNA POLARITY & TEST DISTANCE: VERTICAL AT 3 M

NO.	FREQ. (MHz)	EMISSION LEVEL (dBuV/m)	LIMIT (dBuV/m)	MARGIN (dB)	ANTENNA HEIGHT (m)	TABLE ANGLE (Degree)	RAW VALUE (dBuV)	CORRECTION FACTOR (dB/m)
1	5150.00	61.4 PK	74.0	-12.6	3.21 V	26	55.40	6.00
2	5150.00	48.2 AV	54.0	-5.8	3.21 V	26	42.20	6.00
3	*5190.00	112.1 PK			3.23 V	359	72.70	39.40
4	*5190.00	102.7 AV			3.23 V	359	63.30	39.40
5	#10380.00	59.2 PK	74.0	-14.8	2.64 V	291	41.50	17.70
6	#10380.00	46.1 AV	54.0	-7.9	2.64 V	291	28.40	17.70

REMARKS:

1. Emission Level(dBuV/m) = Raw Value(dBuV) + Correction Factor(dB/m)
2. Correction Factor(dB/m) = Antenna Factor(dB/m) + Cable Factor(dB)
– Pre-Amplifier Factor(dB)
3. The other emission levels were very low against the limit.
4. Margin value = Emission Level – Limit value
5. " * ": Fundamental frequency.
6. " # ": The radiated frequency is out of the restricted band.

CHANNEL	TX Channel 46	DETECTOR FUNCTION	Peak (PK)
FREQUENCY RANGE	1GHz ~ 40GHz		Average (AV)

ANTENNA POLARITY & TEST DISTANCE: HORIZONTAL AT 3 M								
NO.	FREQ. (MHz)	EMISSION LEVEL (dBuV/m)	LIMIT (dBuV/m)	MARGIN (dB)	ANTENNA HEIGHT (m)	TABLE ANGLE (Degree)	RAW VALUE (dBuV)	CORRECTION FACTOR (dB/m)
1	5150.00	64.8 PK	74.0	-9.2	2.57 H	287	58.80	6.00
2	5150.00	52.6 AV	54.0	-1.4	2.57 H	287	46.60	6.00
3	*5230.00	119.9 PK			1.49 H	297	80.30	39.60
4	*5230.00	110.4 AV			1.49 H	297	70.80	39.60
5	#10460.00	63.4 PK	74.0	-10.6	1.62 H	308	44.90	18.50
6	#10460.00	51.2 AV	54.0	-2.8	1.62 H	308	32.70	18.50

ANTENNA POLARITY & TEST DISTANCE: VERTICAL AT 3 M								
NO.	FREQ. (MHz)	EMISSION LEVEL (dBuV/m)	LIMIT (dBuV/m)	MARGIN (dB)	ANTENNA HEIGHT (m)	TABLE ANGLE (Degree)	RAW VALUE (dBuV)	CORRECTION FACTOR (dB/m)
1	5150.00	62.5 PK	74.0	-11.5	3.16 V	0	56.50	6.00
2	5150.00	48.1 AV	54.0	-5.9	3.16 V	0	42.10	6.00
3	*5230.00	117.5 PK			3.21 V	357	77.90	39.60
4	*5230.00	107.8 AV			3.21 V	357	68.20	39.60
5	#10460.00	59.9 PK	74.0	-14.1	2.43 V	282	41.40	18.50
6	#10460.00	48.6 AV	54.0	-5.4	2.43 V	282	30.10	18.50

REMARKS:

1. Emission Level(dBuV/m) = Raw Value(dBuV) + Correction Factor(dB/m)
2. Correction Factor(dB/m) = Antenna Factor(dB/m) + Cable Factor(dB) – Pre-Amplifier Factor(dB)
3. The other emission levels were very low against the limit.
4. Margin value = Emission Level – Limit value
5. " * ": Fundamental frequency.
6. " # ": The radiated frequency is out of the restricted band.

CHANNEL	TX Channel 151	DETECTOR FUNCTION	Peak (PK)
FREQUENCY RANGE	1GHz ~ 40GHz		Average (AV)

ANTENNA POLARITY & TEST DISTANCE: HORIZONTAL AT 3 M

NO.	FREQ. (MHz)	EMISSION LEVEL (dBuV/m)	LIMIT (dBuV/m)	MARGIN (dB)	ANTENNA HEIGHT (m)	TABLE ANGLE (Degree)	RAW VALUE (dBuV)	CORRECTION FACTOR (dB/m)
1	#5651.20	61.9 PK	69.1	-7.2	2.10 H	59	54.80	7.10
2	*5755.00	120.6 PK			2.10 H	59	80.00	40.60
3	*5755.00	111.0 AV			2.10 H	59	70.40	40.60
4	#5978.40	60.7 PK	68.2	-7.5	2.10 H	59	52.80	7.90
5	11510.00	62.2 PK	74.0	-11.8	2.23 H	244	43.50	18.70
6	11510.00	48.9 AV	54.0	-5.1	2.23 H	244	30.20	18.70

ANTENNA POLARITY & TEST DISTANCE: VERTICAL AT 3 M

NO.	FREQ. (MHz)	EMISSION LEVEL (dBuV/m)	LIMIT (dBuV/m)	MARGIN (dB)	ANTENNA HEIGHT (m)	TABLE ANGLE (Degree)	RAW VALUE (dBuV)	CORRECTION FACTOR (dB/m)
1	#5608.80	59.4 PK	68.2	-8.8	2.89 V	345	52.30	7.10
2	*5755.00	114.6 PK			2.89 V	345	74.00	40.60
3	*5755.00	106.4 AV			2.89 V	345	65.80	40.60
4	#5944.00	59.7 PK	68.2	-8.5	2.89 V	345	52.00	7.70
5	11510.00	61.0 PK	74.0	-13.0	2.45 V	293	42.30	18.70
6	11510.00	48.0 AV	54.0	-6.0	2.45 V	293	29.30	18.70

REMARKS:

1. Emission Level(dBuV/m) = Raw Value(dBuV) + Correction Factor(dB/m)
2. Correction Factor(dB/m) = Antenna Factor(dB/m) + Cable Factor(dB)
– Pre-Amplifier Factor(dB)
3. The other emission levels were very low against the limit.
4. Margin value = Emission Level – Limit value
5. " * ": Fundamental frequency.
6. " # ": The radiated frequency is out of the restricted band.

CHANNEL	TX Channel 159	DETECTOR FUNCTION	Peak (PK)
FREQUENCY RANGE	1GHz ~ 40GHz		Average (AV)

ANTENNA POLARITY & TEST DISTANCE: HORIZONTAL AT 3 M

NO.	FREQ. (MHz)	EMISSION LEVEL (dBuV/m)	LIMIT (dBuV/m)	MARGIN (dB)	ANTENNA HEIGHT (m)	TABLE ANGLE (Degree)	RAW VALUE (dBuV)	CORRECTION FACTOR (dB/m)
1	#5633.60	59.2 PK	68.2	-9.0	2.01 H	52	52.10	7.10
2	*5795.00	120.5 PK			2.01 H	52	79.90	40.60
3	*5795.00	111.0 AV			2.01 H	52	70.40	40.60
4	#5944.00	60.0 PK	68.2	-8.2	2.01 H	52	52.30	7.70
5	11590.00	61.2 PK	74.0	-12.8	2.28 H	269	42.40	18.80
6	11590.00	48.5 AV	54.0	-5.5	2.28 H	269	29.70	18.80

ANTENNA POLARITY & TEST DISTANCE: VERTICAL AT 3 M

NO.	FREQ. (MHz)	EMISSION LEVEL (dBuV/m)	LIMIT (dBuV/m)	MARGIN (dB)	ANTENNA HEIGHT (m)	TABLE ANGLE (Degree)	RAW VALUE (dBuV)	CORRECTION FACTOR (dB/m)
1	#5641.60	58.7 PK	68.2	-9.5	3.48 V	355	51.60	7.10
2	*5795.00	115.2 PK			3.48 V	355	74.60	40.60
3	*5795.00	105.6 AV			3.48 V	355	65.00	40.60
4	#5986.40	60.2 PK	68.2	-8.0	3.48 V	355	52.30	7.90
5	11590.00	61.5 PK	74.0	-12.5	2.48 V	266	42.70	18.80
6	11590.00	48.4 AV	54.0	-5.6	2.48 V	266	29.60	18.80

REMARKS:

1. Emission Level(dBuV/m) = Raw Value(dBuV) + Correction Factor(dB/m)
2. Correction Factor(dB/m) = Antenna Factor(dB/m) + Cable Factor(dB)
– Pre-Amplifier Factor(dB)
3. The other emission levels were very low against the limit.
4. Margin value = Emission Level – Limit value
5. " * ": Fundamental frequency.
6. " # ": The radiated frequency is out of the restricted band.

802.11ac (VHT80)

CHANNEL	TX Channel 42	DETECTOR FUNCTION	Peak (PK)
FREQUENCY RANGE	1GHz ~ 40GHz		Average (AV)

ANTENNA POLARITY & TEST DISTANCE: HORIZONTAL AT 3 M

NO.	FREQ. (MHz)	EMISSION LEVEL (dBuV/m)	LIMIT (dBuV/m)	MARGIN (dB)	ANTENNA HEIGHT (m)	TABLE ANGLE (Degree)	RAW VALUE (dBuV)	CORRECTION FACTOR (dB/m)
1	5150.00	65.2 PK	74.0	-8.8	2.15 H	52	59.20	6.00
2	5150.00	52.5 AV	54.0	-1.5	2.15 H	52	46.50	6.00
3	*5210.00	107.5 PK			2.44 H	304	68.00	39.50
4	*5210.00	97.6 AV			2.44 H	304	58.10	39.50
5	5350.00	58.1 PK	74.0	-15.9	1.68 H	284	51.60	6.50
6	5350.00	46.9 AV	54.0	-7.1	1.68 H	284	40.40	6.50
7	#10420.00	59.5 PK	74.0	-14.5	2.01 H	111	41.60	17.90
8	#10420.00	46.6 AV	54.0	-7.4	2.01 H	111	28.70	17.90

ANTENNA POLARITY & TEST DISTANCE: VERTICAL AT 3 M

NO.	FREQ. (MHz)	EMISSION LEVEL (dBuV/m)	LIMIT (dBuV/m)	MARGIN (dB)	ANTENNA HEIGHT (m)	TABLE ANGLE (Degree)	RAW VALUE (dBuV)	CORRECTION FACTOR (dB/m)
1	5150.00	62.1 PK	74.0	-11.9	3.20 V	2	56.10	6.00
2	5150.00	49.7 AV	54.0	-4.3	3.20 V	2	43.70	6.00
3	*5210.00	105.0 PK			3.07 V	0	65.50	39.50
4	*5210.00	95.1 AV			3.07 V	0	55.60	39.50
5	5350.00	58.5 PK	74.0	-15.5	2.28 V	156	52.00	6.50
6	5350.00	45.6 AV	54.0	-8.4	2.28 V	156	39.10	6.50
7	#10420.00	59.9 PK	74.0	-14.1	2.32 V	121	42.00	17.90
8	#10420.00	46.4 AV	54.0	-7.6	2.32 V	121	28.50	17.90

REMARKS:

1. Emission Level(dBuV/m) = Raw Value(dBuV) + Correction Factor(dB/m)
2. Correction Factor(dB/m) = Antenna Factor(dB/m) + Cable Factor(dB)
– Pre-Amplifier Factor(dB)
3. The other emission levels were very low against the limit.
4. Margin value = Emission Level – Limit value
5. " * ": Fundamental frequency.
6. " # ": The radiated frequency is out of the restricted band.

CHANNEL	TX Channel 155	DETECTOR FUNCTION	Peak (PK)
FREQUENCY RANGE	1GHz ~ 40GHz		Average (AV)

ANTENNA POLARITY & TEST DISTANCE: HORIZONTAL AT 3 M

NO.	FREQ. (MHz)	EMISSION LEVEL (dBuV/m)	LIMIT (dBuV/m)	MARGIN (dB)	ANTENNA HEIGHT (m)	TABLE ANGLE (Degree)	RAW VALUE (dBuV)	CORRECTION FACTOR (dB/m)
1	#5648.80	64.7 PK	68.2	-3.5	2.25 H	41	57.60	7.10
2	#5650.00	66.7 PK	68.2	-1.5	2.11 H	39	59.60	7.10
3	*5775.00	113.7 PK			2.12 H	43	73.10	40.60
4	*5775.00	104.1 AV			2.12 H	43	63.50	40.60
5	#5932.80	61.3 PK	68.2	-6.9	2.25 H	41	53.60	7.70
6	11550.00	59.9 PK	74.0	-14.1	2.34 H	302	41.30	18.60
7	11550.00	47.2 AV	54.0	-6.8	2.34 H	302	28.60	18.60

ANTENNA POLARITY & TEST DISTANCE: VERTICAL AT 3 M

NO.	FREQ. (MHz)	EMISSION LEVEL (dBuV/m)	LIMIT (dBuV/m)	MARGIN (dB)	ANTENNA HEIGHT (m)	TABLE ANGLE (Degree)	RAW VALUE (dBuV)	CORRECTION FACTOR (dB/m)
1	#5640.00	62.3 PK	68.2	-5.9	3.60 V	359	55.20	7.10
2	*5775.00	111.3 PK			3.60 V	359	70.70	40.60
3	*5775.00	101.5 AV			3.60 V	359	60.90	40.60
4	#5995.20	59.9 PK	68.2	-8.3	3.60 V	359	52.00	7.90
5	11550.00	59.6 PK	74.0	-14.4	2.23 V	290	41.00	18.60
6	11550.00	46.7 AV	54.0	-7.3	2.23 V	290	28.10	18.60

REMARKS:

1. Emission Level(dBuV/m) = Raw Value(dBuV) + Correction Factor(dB/m)
2. Correction Factor(dB/m) = Antenna Factor(dB/m) + Cable Factor(dB)
– Pre-Amplifier Factor(dB)
3. The other emission levels were very low against the limit.
4. Margin value = Emission Level – Limit value
5. " * ": Fundamental frequency.
6. " # ": The radiated frequency is out of the restricted band.

802.11ac (VHT80+VHT80)

CHANNEL	TX Channel 42+155	DETECTOR FUNCTION	Peak (PK)
FREQUENCY RANGE	1GHz ~ 40GHz		Average (AV)

ANTENNA POLARITY & TEST DISTANCE: HORIZONTAL AT 3 M

NO.	FREQ. (MHz)	EMISSION LEVEL (dBuV/m)	LIMIT (dBuV/m)	MARGIN (dB)	ANTENNA HEIGHT (m)	TABLE ANGLE (Degree)	RAW VALUE (dBuV)	CORRECTION FACTOR (dB/m)
1	5150.00	64.2 PK	74.0	-9.8	2.14 H	48	58.20	6.00
2	5150.00	52.5 AV	54.0	-1.5	2.14 H	48	46.50	6.00
3	*5210.00	104.0 PK			2.06 H	42	64.50	39.50
4	*5210.00	93.8 AV			2.06 H	42	54.30	39.50
5	5350.00	57.8 PK	74.0	-16.2	2.20 H	55	51.30	6.50
6	5350.00	44.7 AV	54.0	-9.3	2.20 H	55	38.20	6.50
7	#5623.20	58.8 PK	68.2	-9.4	1.70 H	48	51.70	7.10
8	*5775.00	104.0 PK			1.70 H	48	63.40	40.60
9	*5775.00	93.9 AV			1.70 H	48	53.30	40.60
10	#5954.40	60.0 PK	68.2	-8.2	1.70 H	48	52.30	7.70
11	#10420.00	59.9 PK	74.0	-14.1	2.00 H	110	42.00	17.90
12	#10420.00	46.7 AV	54.0	-7.3	2.00 H	110	28.80	17.90
13	11550.00	60.2 PK	74.0	-13.8	1.77 H	301	41.60	18.60
14	11550.00	47.0 AV	54.0	-7.0	1.77 H	301	28.40	18.60

ANTENNA POLARITY & TEST DISTANCE: VERTICAL AT 3 M

NO.	FREQ. (MHz)	EMISSION LEVEL (dBuV/m)	LIMIT (dBuV/m)	MARGIN (dB)	ANTENNA HEIGHT (m)	TABLE ANGLE (Degree)	RAW VALUE (dBuV)	CORRECTION FACTOR (dB/m)
1	5150.00	61.6 PK	74.0	-12.4	3.25 V	7	55.60	6.00
2	5150.00	48.0 AV	54.0	-6.0	3.25 V	7	42.00	6.00
3	*5210.00	100.2 PK			3.13 V	3	60.70	39.50
4	*5210.00	89.7 AV			3.13 V	3	50.20	39.50
5	5350.00	57.7 PK	74.0	-16.3	3.00 V	1	51.20	6.50
6	5350.00	44.3 AV	54.0	-9.7	3.00 V	1	37.80	6.50
7	#5616.80	58.3 PK	68.2	-9.9	3.12 V	346	51.20	7.10
8	*5775.00	96.6 PK			3.12 V	346	56.00	40.60
9	*5775.00	86.6 AV			3.12 V	346	46.00	40.60
10	#5959.20	59.6 PK	68.2	-8.6	3.12 V	346	51.90	7.70
11	#10420.00	59.4 PK	74.0	-14.6	2.87 V	289	41.50	17.90
12	#10420.00	46.3 AV	54.0	-7.7	2.87 V	289	28.40	17.90
13	11550.00	59.6 PK	74.0	-14.4	1.76 V	88	41.00	18.60
14	11550.00	46.7 AV	54.0	-7.3	1.76 V	88	28.10	18.60

REMARKS:

1. Emission Level(dBuV/m) = Raw Value(dBuV) + Correction Factor(dB/m)
2. Correction Factor(dB/m) = Antenna Factor(dB/m) + Cable Factor(dB) – Pre-Amplifier Factor(dB)
3. The other emission levels were very low against the limit.
4. Margin value = Emission Level – Limit value
5. " * ": Fundamental frequency.
6. " # ": The radiated frequency is out of the restricted band.

Below 1GHz Worst-Case Data:

Radio 2: CDD Mode

802.11n (HT20)

CHANNEL	TX Channel 149	DETECTOR FUNCTION	Quasi-Peak (QP)
FREQUENCY RANGE	9kHz ~ 1GHz		
TEST MODE	A		

ANTENNA POLARITY & TEST DISTANCE: HORIZONTAL AT 3 M

NO.	FREQ. (MHz)	EMISSION LEVEL (dBuV/m)	LIMIT (dBuV/m)	MARGIN (dB)	ANTENNA HEIGHT (m)	TABLE ANGLE (Degree)	RAW VALUE (dBuV)	CORRECTION FACTOR (dB/m)
1	57.12	30.0 QP	40.0	-10.0	1.99 H	47	44.60	-14.60
2	199.05	35.5 QP	43.5	-8.0	1.00 H	115	52.00	-16.50
3	249.60	36.0 QP	46.0	-10.0	1.00 H	5	50.00	-14.00
4	374.04	30.5 QP	46.0	-15.5	1.99 H	138	41.00	-10.50
5	500.42	28.9 QP	46.0	-17.1	1.50 H	236	36.80	-7.90
6	700.68	31.2 QP	46.0	-14.8	1.00 H	207	34.80	-3.60

ANTENNA POLARITY & TEST DISTANCE: VERTICAL AT 3 M

NO.	FREQ. (MHz)	EMISSION LEVEL (dBuV/m)	LIMIT (dBuV/m)	MARGIN (dB)	ANTENNA HEIGHT (m)	TABLE ANGLE (Degree)	RAW VALUE (dBuV)	CORRECTION FACTOR (dB/m)
1	45.86	35.6 QP	40.0	-4.4	1.00 V	6	50.30	-14.70
2	62.95	36.7 QP	40.0	-3.3	1.00 V	47	51.80	-15.10
3	199.05	35.4 QP	43.5	-8.1	1.00 V	4	51.90	-16.50
4	249.60	33.4 QP	46.0	-12.6	1.00 V	231	47.40	-14.00
5	374.04	31.0 QP	46.0	-15.0	1.00 V	161	41.50	-10.50
6	500.42	30.1 QP	46.0	-15.9	1.00 V	258	38.00	-7.90

REMARKS:

1. Emission Level(dBuV/m) = Raw Value(dBuV) + Correction Factor(dB/m)
2. Correction Factor(dB/m) = Antenna Factor(dB/m) + Cable Factor(dB)
– Pre-Amplifier Factor(dB)
3. The other emission levels were very low against the limit.
4. Margin value = Emission Level – Limit value

CHANNEL	TX Channel 149	DETECTOR FUNCTION	Quasi-Peak (QP)
FREQUENCY RANGE	9kHz ~ 1GHz		
TEST MODE	B		

ANTENNA POLARITY & TEST DISTANCE: HORIZONTAL AT 3 M

NO.	FREQ. (MHz)	EMISSION LEVEL (dBuV/m)	LIMIT (dBuV/m)	MARGIN (dB)	ANTENNA HEIGHT (m)	TABLE ANGLE (Degree)	RAW VALUE (dBuV)	CORRECTION FACTOR (dB/m)
1	57.12	28.9 QP	40.0	-11.1	1.50 H	109	43.50	-14.60
2	125.17	30.9 QP	43.5	-12.6	1.50 H	279	47.00	-16.10
3	199.05	35.4 QP	43.5	-8.1	1.50 H	147	51.90	-16.50
4	286.55	33.2 QP	46.0	-12.8	1.01 H	119	45.60	-12.40
5	700.68	33.6 QP	46.0	-12.4	1.01 H	141	37.20	-3.60
6	897.05	42.5 QP	46.0	-3.5	1.50 H	224	41.70	0.80

ANTENNA POLARITY & TEST DISTANCE: VERTICAL AT 3 M

NO.	FREQ. (MHz)	EMISSION LEVEL (dBuV/m)	LIMIT (dBuV/m)	MARGIN (dB)	ANTENNA HEIGHT (m)	TABLE ANGLE (Degree)	RAW VALUE (dBuV)	CORRECTION FACTOR (dB/m)
1	45.45	35.8 QP	40.0	-4.2	1.00 V	19	50.50	-14.70
2	55.18	34.0 QP	40.0	-6.0	1.00 V	76	48.40	-14.40
3	199.05	32.1 QP	43.5	-11.4	1.49 V	16	48.60	-16.50
4	249.60	32.5 QP	46.0	-13.5	1.00 V	232	46.50	-14.00
5	374.04	32.7 QP	46.0	-13.3	1.00 V	166	43.20	-10.50
6	500.42	28.8 QP	46.0	-17.2	1.00 V	230	36.70	-7.90

REMARKS:

1. Emission Level(dBuV/m) = Raw Value(dBuV) + Correction Factor(dB/m)
2. Correction Factor(dB/m) = Antenna Factor(dB/m) + Cable Factor(dB)
– Pre-Amplifier Factor(dB)
3. The other emission levels were very low against the limit.
4. Margin value = Emission Level – Limit value

4.2 Conducted Emission Measurement

4.2.1 Limits of Conducted Emission Measurement

Frequency (MHz)	Conducted Limit (dBuV)	
	Quasi-peak	Average
0.15 - 0.5	66 - 56	56 - 46
0.50 - 5.0	56	46
5.0 - 30.0	60	50

Note: 1. The lower limit shall apply at the transition frequencies.

2. The limit decreases in line with the logarithm of the frequency in the range of 0.15 to 0.50MHz.

4.2.2 Test Instruments

Description & Manufacturer	Model No.	Serial No.	Cal. Date	Cal. Due
Test Receiver ROHDE & SCHWARZ	ESCI	100613	Nov. 16, 2015	Nov. 15, 2016
RF signal cable (with 10dB PAD) Woken	5D-FB	Cable-cond1-01	Dec. 26, 2015	Dec. 25, 2016
LISN/AMN ROHDE & SCHWARZ (EUT)	ESH3-Z5	835239/001	Feb. 26, 2016	Feb. 25, 2017
LISN/AMN ROHDE & SCHWARZ (Peripheral)	ESH3-Z5	100220	Nov. 13, 2015	Nov. 12, 2016
Software ADT	BV ADT_Cond_ V7.3.7.3	NA	NA	NA

Note: 1. The calibration interval of the above test instruments is 12 months and the calibrations are traceable to NML/ROC and NIST/USA.

2. The test was performed in HwaYa Shielded Room 1.

3. The VCCI Site Registration No. is C-2040.

4.2.3 Test Procedure

- The EUT was placed 0.4 meters from the conducting wall of the shielded room with EUT being connected to the power mains through a line impedance stabilization network (LISN). Other support units were connected to the power mains through another LISN. The two LISNs provide 50 ohm/ 50uH of coupling impedance for the measuring instrument.
- Both lines of the power mains connected to the EUT were checked for maximum conducted interference.
- The frequency range from 150kHz to 30MHz was searched. Emission levels under (Limit - 20dB) was not recorded.

NOTE: The resolution bandwidth and video bandwidth of test receiver is 9kHz for quasi-peak detection (QP) and average detection (AV) at frequency 0.15MHz-30MHz.

4.2.4 Deviation from Test Standard

No deviation.

4.2.5 Test Setup

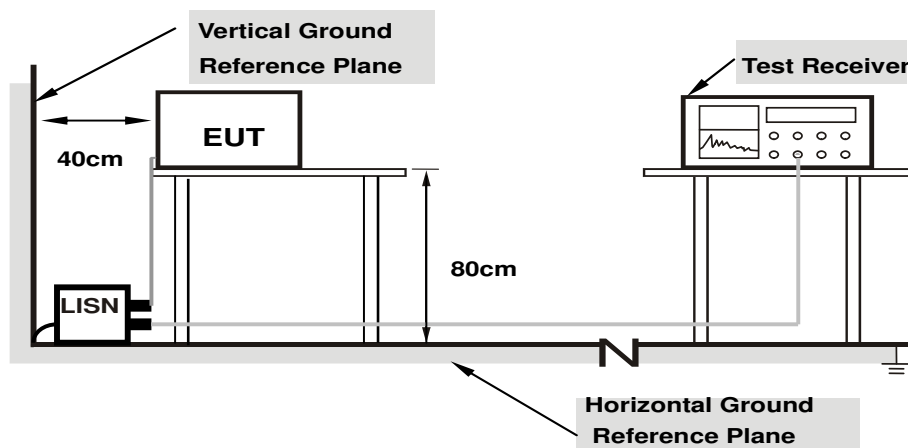

- Note:**
- Support units were connected to second LISN.
 - Both of LISNs (AMN) are 80 cm from EUT and at least 80 from other units and other metal planes

For the actual test configuration, please refer to the attached file (Test Setup Photo).

4.2.6 EUT Operating Conditions

Same as 4.1.6.

4.2.7 Test Results

Radio 2: CDD Mode

Phase	Line (L)	Detector Function	Quasi-Peak (QP) / Average (AV)
Test Mode	A		

No	Freq. [MHz]	Corr. Factor (dB)	Reading Value [dB (uV)]		Emission Level [dB (uV)]		Limit [dB (uV)]		Margin (dB)	
			Q.P.	AV.	Q.P.	AV.	Q.P.	AV.	Q.P.	AV.
			1	0.17374	10.08	40.39	31.29	50.47	41.37	64.78
2	0.24384	10.10	34.26	26.00	44.36	36.10	61.96	51.96	-17.60	-15.86
3	0.34550	10.15	32.16	24.15	42.31	34.30	59.07	49.07	-16.76	-14.77
4	0.52544	10.20	34.00	26.69	44.20	36.89	56.00	46.00	-11.80	-9.11
5	15.06665	11.07	22.16	17.49	33.23	28.56	60.00	50.00	-26.77	-21.44
6	18.39406	11.31	21.03	16.37	32.34	27.68	60.00	50.00	-27.66	-22.32

Remarks:

1. Q.P. and AV. are abbreviations of quasi-peak and average individually.
2. The emission levels of other frequencies were very low against the limit.
3. Margin value = Emission level - Limit value
4. Correction factor = Insertion loss + Cable loss
5. Emission Level = Correction Factor + Reading Value.

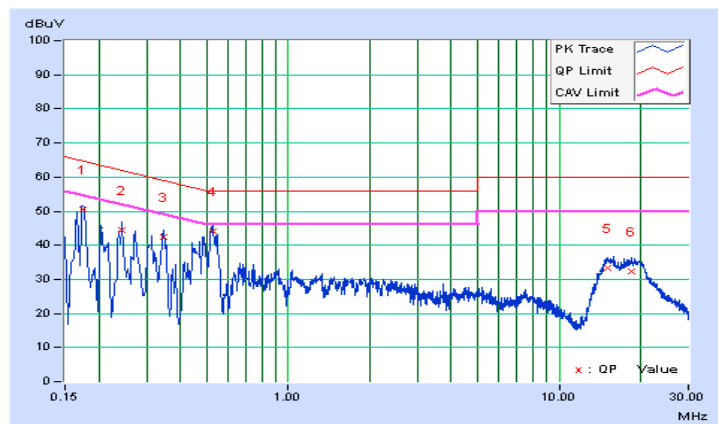

Phase	Neutral (N)	Detector Function	Quasi-Peak (QP) / Average (AV)
Test Mode	A		

No	Freq. [MHz]	Corr. Factor (dB)	Reading Value [dB (uV)]		Emission Level [dB (uV)]		Limit [dB (uV)]		Margin (dB)	
			Q.P.	AV.	Q.P.	AV.	Q.P.	AV.	Q.P.	AV.
			1	0.17374	10.08	40.74	30.29	50.82	40.37	64.78
2	0.20474	10.08	36.60	23.81	46.68	33.89	63.42	53.42	-16.74	-19.53
3	0.31422	10.17	34.07	25.57	44.24	35.74	59.86	49.86	-15.62	-14.12
4	0.34550	10.20	31.35	21.72	41.55	31.92	59.07	49.07	-17.52	-17.15
5	0.52536	10.25	32.45	25.73	42.70	35.98	56.00	46.00	-13.30	-10.02
6	17.80365	11.41	20.23	15.49	31.64	26.90	60.00	50.00	-28.36	-23.10

Remarks:

1. Q.P. and AV. are abbreviations of quasi-peak and average individually.
2. The emission levels of other frequencies were very low against the limit.
3. Margin value = Emission level - Limit value
4. Correction factor = Insertion loss + Cable loss
5. Emission Level = Correction Factor + Reading Value.

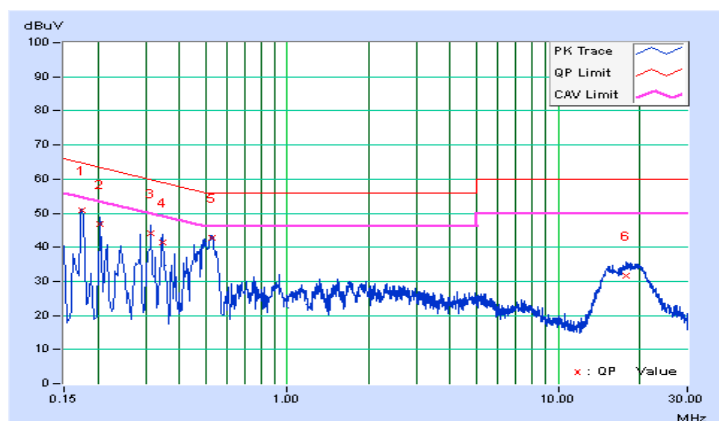

Phase	Line (L)	Detector Function	Quasi-Peak (QP) / Average (AV)
Test Mode	B		

No	Freq. [MHz]	Corr. Factor (dB)	Reading Value [dB (uV)]		Emission Level [dB (uV)]		Limit [dB (uV)]		Margin (dB)	
			Q.P.	AV.	Q.P.	AV.	Q.P.	AV.	Q.P.	AV.
			1	0.17744	10.08	24.29	17.83	34.37	27.91	64.60
2	0.32986	10.14	21.38	14.42	31.52	24.56	59.45	49.45	-27.93	-24.89
3	0.49017	10.19	33.61	26.68	43.80	36.87	56.16	46.16	-12.36	-9.29
4	0.52682	10.20	32.84	26.47	43.04	36.67	56.00	46.00	-12.96	-9.33
5	0.62702	10.22	23.50	15.73	33.72	25.95	56.00	46.00	-22.28	-20.05
6	20.86518	11.47	21.86	16.22	33.33	27.69	60.00	50.00	-26.67	-22.31

Remarks:

1. Q.P. and AV. are abbreviations of quasi-peak and average individually.
2. The emission levels of other frequencies were very low against the limit.
3. Margin value = Emission level - Limit value
4. Correction factor = Insertion loss + Cable loss
5. Emission Level = Correction Factor + Reading Value.

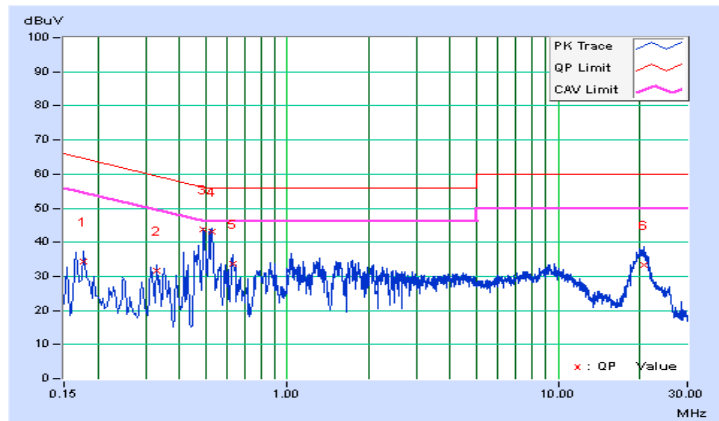

Phase	Neutral (N)	Detector Function	Quasi-Peak (QP) / Average (AV)
Test Mode	B		

No	Freq. [MHz]	Corr. Factor (dB)	Reading Value [dB (uV)]		Emission Level [dB (uV)]		Limit [dB (uV)]		Margin (dB)	
			Q.P.	AV.	Q.P.	AV.	Q.P.	AV.	Q.P.	AV.
			1	0.16181	10.08	27.11	17.95	37.19	28.03	65.37
2	0.32986	10.18	25.00	18.27	35.18	28.45	59.45	49.45	-24.27	-21.00
3	0.49799	10.25	33.11	26.70	43.36	36.95	56.03	46.03	-12.67	-9.08
4	0.52544	10.25	34.18	27.83	44.43	38.08	56.00	46.00	-11.57	-7.92
5	0.83106	10.28	25.07	17.02	35.35	27.30	56.00	46.00	-20.65	-18.70
6	20.26304	11.60	21.44	15.86	33.04	27.46	60.00	50.00	-26.96	-22.54

Remarks:

1. Q.P. and AV. are abbreviations of quasi-peak and average individually.
2. The emission levels of other frequencies were very low against the limit.
3. Margin value = Emission level - Limit value
4. Correction factor = Insertion loss + Cable loss
5. Emission Level = Correction Factor + Reading Value.

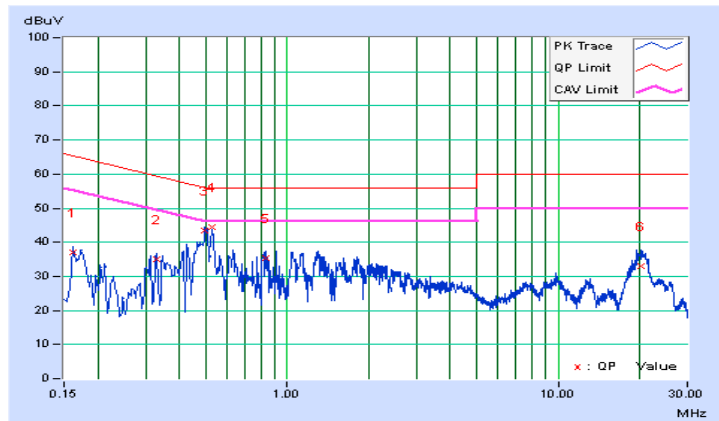

4.3 Transmit Power Measurement

4.3.1 Limits of Transmit Power Measurement

Operation Band	EUT Category		Limit
U-NII-1		Outdoor Access Point	1 Watt (30 dBm) (Max. e.i.r.p \leq 125mW (21 dBm) at any elevation angle above 30 degrees as measured from the horizon)
		Fixed point-to-point Access Point	1 Watt (30 dBm)
	√	Indoor Access Point	1 Watt (30 dBm)
		Mobile and Portable client device	250mW (24 dBm)
U-NII-2A	---		250mW (24 dBm) or 11 dBm+10 log B*
U-NII-2C	---		250mW (24 dBm) or 11 dBm+10 log B*
U-NII-3	√		1 Watt (30 dBm)

*B is the 26 dB emission bandwidth in megahertz

Per KDB 662911 Method of conducted output power measurement on IEEE 802.11 devices,

Array Gain = 0 dB (i.e., no array gain) for $N_{ANT} \leq 4$;

Array Gain = 0 dB (i.e., no array gain) for channel widths ≥ 40 MHz for any N_{ANT} ;

Array Gain = $5 \log(N_{ANT}/N_{SS})$ dB or 3 dB, whichever is less for 20-MHz channel widths with $N_{ANT} \geq 5$.

For power measurements on all other devices: Array Gain = $10 \log(N_{ANT}/N_{SS})$ dB.

4.3.2 Test Setup

For Power Output Measurement

For 802.11a, 802.11n (HT20), 802.11n (HT40)

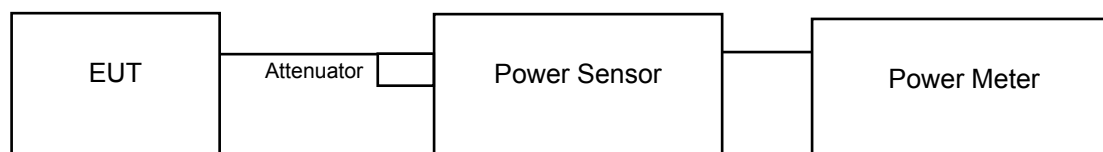

For 802.11ac (VHT80)

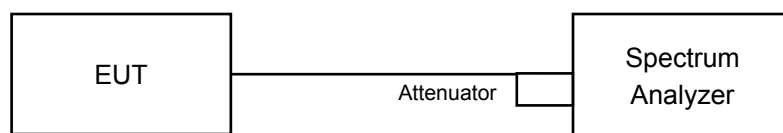

For 26dB Bandwidth

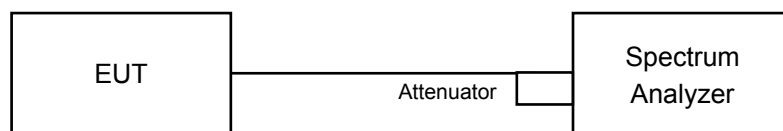

4.3.3 Test Instruments

Refer to section 4.1.2 to get information of above instrument.

4.3.4 Test Procedure

For Average Power Measurement

For 802.11a, 802.11n (HT20), 802.11n (HT40)

Method PM is used to perform output power measurement, trigger and gating function of wide band power meter is enabled to measure max output power of TX on burst. Duty factor is not added to measured value.

For 802.11ac (VHT80)

- a. Set span to encompass the entire 26 dB EBW (or, alternatively, the entire 99% occupied bandwidth) of the signal.
- b. Set sweep trigger to "free run".
- c. Set RBW = 1 MHz.
- d. Set VBW \geq 3 MHz
- e. Number of points in sweep \geq 2 Span / RBW.
- f. Sweep time \leq (number of points in sweep) * T
- g. Using emission bandwidth to determine the frequency span for integration the channel bandwidth.
- h. Detector = RMS.
- i. Trace mode = max hold.
- j. Allow max hold to run for at least 60 seconds, or longer as needed to allow the trace to stabilize.
- k. Compute power by integrating the spectrum across the EBW (or, alternatively, the entire 99% occupied bandwidth) of the signal using the instrument's band power measurement function with band limits set equal to the EBW (or occupied bandwidth) band edges. If the instrument does not have a band power function, sum the spectrum levels (in power units) at 1 MHz intervals extending across the EBW (or, alternatively, the entire 99% occupied bandwidth) of the spectrum.

For 26dB Bandwidth

- a. Set RBW = approximately 1% of the emission bandwidth.
- b. Set the VBW > RBW.
- c. Detector = Peak.
- d. Trace mode = max hold.
- e. Measure the maximum width of the emission that is 26 dB down from the peak of the emission. Compare this with the RBW setting of the analyzer. Readjust RBW and repeat measurement as needed until the RBW/EBW ratio is approximately 1%.

4.3.5 Deviation from Test Standard

No deviation.

4.3.6 EUT Operating Conditions

The software provided by client to enable the EUT under transmission Condition continuously at lowest, middle and highest channel frequencies individually.

4.3.7 Test Result

Power Output:

Radio 2: CDD Mode

802.11a

Channel	Freq. (MHz)	Maximum Conducted Power (dBm)				Total Power (mW)	Total Power (dBm)	Limit (dBm)	Pass / Fail
		Chain 0	Chain 1	Chain 2	Chain 3				
36	5180	15.68	15.42	15.69	15.79	146.816	21.67	30.00	Pass
40	5200	17.50	17.75	17.64	17.52	230.370	23.62	30.00	Pass
48	5240	16.36	16.48	16.25	16.39	173.435	22.39	30.00	Pass
149	5745	19.31	19.15	19.20	19.06	331.248	25.20	30.00	Pass
157	5785	19.62	19.40	19.37	19.35	351.314	25.46	30.00	Pass
165	5825	18.53	18.13	18.25	18.42	272.634	24.36	30.00	Pass

802.11n (HT20)

Channel	Freq. (MHz)	Maximum Conducted Power (dBm)				Total Power (mW)	Total Power (dBm)	Limit (dBm)	Pass / Fail
		Chain 0	Chain 1	Chain 2	Chain 3				
36	5180	16.65	16.63	16.86	16.86	189.322	22.77	30.00	Pass
40	5200	18.06	18.26	18.01	18.02	257.589	24.11	30.00	Pass
48	5240	17.36	17.42	17.13	17.24	214.266	23.31	30.00	Pass
149	5745	19.62	19.46	19.43	19.22	351.190	25.46	30.00	Pass
157	5785	19.52	19.27	19.37	19.42	348.059	25.42	30.00	Pass
165	5825	17.98	17.66	17.83	17.94	244.055	23.87	30.00	Pass

802.11n (HT40)

Channel	Freq. (MHz)	Maximum Conducted Power (dBm)				Total Power (mW)	Total Power (dBm)	Limit (dBm)	Pass / Fail
		Chain 0	Chain 1	Chain 2	Chain 3				
38	5190	12.84	12.68	12.81	12.98	76.726	18.85	30.00	Pass
46	5230	18.05	18.04	18.69	18.22	267.841	24.28	30.00	Pass
151	5755	18.44	18.18	17.99	18.05	262.366	24.19	30.00	Pass
159	5795	19.59	19.27	19.29	19.43	348.137	25.42	30.00	Pass

802.11ac (VHT80)

Channel	Freq. (MHz)	Maximum Conducted Power (dBm)				Total Power (mW)	Total Power (dBm)	Limit (dBm)	Pass / Fail
		Chain 0	Chain 1	Chain 2	Chain 3				
42	5210	9.89	9.97	10.07	10.05	39.959	16.02	30.00	Pass
155	5775	16.20	15.86	15.90	16.03	159.227	22.02	30.00	Pass

802.11ac (VHT80+VHT80)

Channel	Freq. (MHz)	Maximum Conducted Power (dBm)				Total Power (mW)	Total Power (dBm)	Limit (dBm)	Pass / Fail
		Chain 0	Chain 1	Chain 2	Chain 3				
42	5210	10.51	10.76	-	-	23.158	13.65	30.00	Pass
155	5775	-	-	10.59	10.47	22.598	13.54	30.00	Pass

Radio 2: Beamforming Mode

802.11n (HT20)

Channel	Freq. (MHz)	Maximum Conducted Power (dBm)				Total Power (mW)	Total Power (dBm)	Limit (dBm)	Pass / Fail
		Chain 0	Chain 1	Chain 2	Chain 3				
36	5180	10.63	10.61	10.84	10.84	47.337	16.75	24.27	Pass
40	5200	12.04	12.24	11.99	12.00	64.406	18.09	24.27	Pass
48	5240	11.34	11.40	11.11	11.22	53.573	17.29	24.27	Pass
149	5745	13.60	13.44	13.41	13.20	87.810	19.44	24.27	Pass
157	5785	13.50	13.25	13.35	13.40	87.027	19.40	24.27	Pass
165	5825	11.96	11.64	11.81	11.92	61.023	17.85	24.27	Pass

Note: Beamforming gain = $10 \log[(10^{G1/20} + 10^{G2/20} + \dots + 10^{GN/20})^2/4]$ = 11.73dBi > 6dBi , so the power density limit shall be reduced to $30-(11.73-6) = 24.27$ dBm.

802.11n (HT40)

Channel	Freq. (MHz)	Maximum Conducted Power (dBm)				Total Power (mW)	Total Power (dBm)	Limit (dBm)	Pass / Fail
		Chain 0	Chain 1	Chain 2	Chain 3				
38	5190	6.82	6.66	6.79	6.96	19.183	12.83	24.27	Pass
46	5230	12.03	12.02	12.67	12.20	66.970	18.26	24.27	Pass
151	5755	12.42	12.16	11.97	12.03	65.601	18.17	24.27	Pass
159	5795	13.57	13.25	13.27	13.41	87.046	19.40	24.27	Pass

Note: Beamforming gain = $10 \log[(10^{G1/20} + 10^{G2/20} + \dots + 10^{GN/20})^2/4]$ = 11.73dBi > 6dBi , so the power density limit shall be reduced to $30-(11.73-6) = 24.27$ dBm.

802.11ac (VHT80)

Channel	Freq. (MHz)	Maximum Conducted Power (dBm)				Total Power (mW)	Total Power (dBm)	Limit (dBm)	Pass / Fail
		Chain 0	Chain 1	Chain 2	Chain 3				
42	5210	3.87	3.95	4.05	4.03	9.991	10.00	24.27	Pass
155	5775	10.18	9.84	9.88	10.01	39.811	16.00	24.27	Pass

Note: Beamforming gain = $10 \log[(10^{G1/20} + 10^{G2/20} + \dots + 10^{GN/20})^2/4]$ = 11.73dBi > 6dBi , so the power density limit shall be reduced to $30-(11.73-6) = 24.27$ dBm.

802.11ac (VHT80+VHT80)

Channel	Freq. (MHz)	Maximum Conducted Power (dBm)				Total Power (mW)	Total Power (dBm)	Limit (dBm)	Pass / Fail
		Chain 0	Chain 1	Chain 2	Chain 3				
42	5210	4.49	4.74	-	-	5.791	7.63	24.27	Pass
155	5775	-	-	4.57	4.45	5.650	7.52	24.27	Pass

Note: Beamforming gain = $10 \log[(10^{G1/20} + 10^{G2/20} + \dots + 10^{GN/20})^2/4]$ = 11.73dBi > 6dBi , so the power density limit shall be reduced to $30-(11.73-6) = 24.27$ dBm.

26dB Bandwidth:

Radio 2: CDD Mode

802.11a

Channel	Frequency (MHz)	26dBc Bandwidth (MHz)			
		Chain 0	Chain 1	Chain 2	Chain 3
36	5180	34.84	19.42	19.26	18.99
40	5200	20.33	21.54	19.27	19.36
48	5240	19.41	19.36	19.20	19.17

802.11n (HT20)

Channel	Frequency (MHz)	26dBc Bandwidth (MHz)			
		Chain 0	Chain 1	Chain 2	Chain 3
36	5180	20.70	20.51	20.20	20.24
40	5200	25.30	25.18	20.87	20.82
48	5240	20.72	20.69	20.33	20.45

802.11n (HT40)

Channel	Frequency (MHz)	26dBc Bandwidth (MHz)			
		Chain 0	Chain 1	Chain 2	Chain 3
38	5190	40.71	40.85	40.77	40.56
46	5230	41.29	43.33	47.39	54.39

802.11ac (VHT80)

Channel	Frequency (MHz)	26dBc Bandwidth (MHz)			
		Chain 0	Chain 1	Chain 2	Chain 3
42	5210	84.57	84.44	84.59	85.49

802.11ac (VHT80+VHT80)

Channel	Frequency (MHz)	26dBc Bandwidth (MHz)			
		Chain 0	Chain 1	Chain 2	Chain 3
42	5210	84.93	85.60	-	-

Spectrum Plot of Worst Value

802.11a

802.11n (HT20) Ch 40/Chain 0

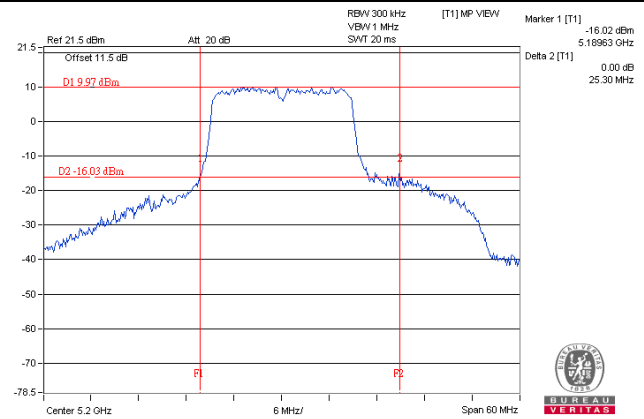
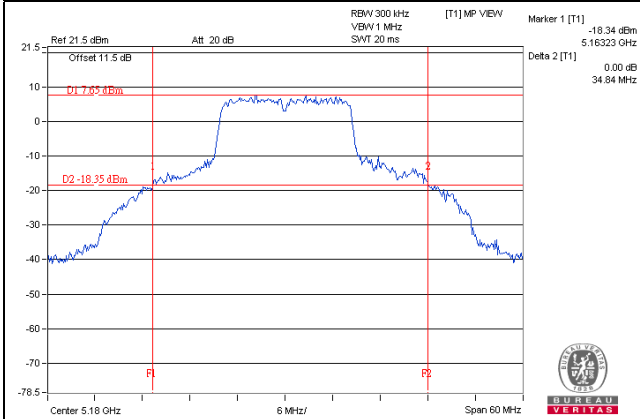

802.11n (HT40)

802.11ac (VHT80)

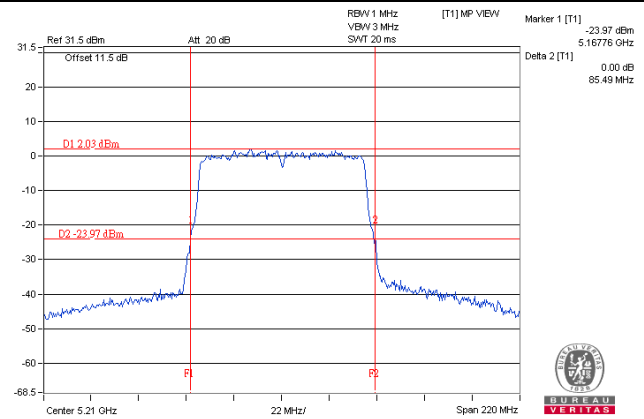
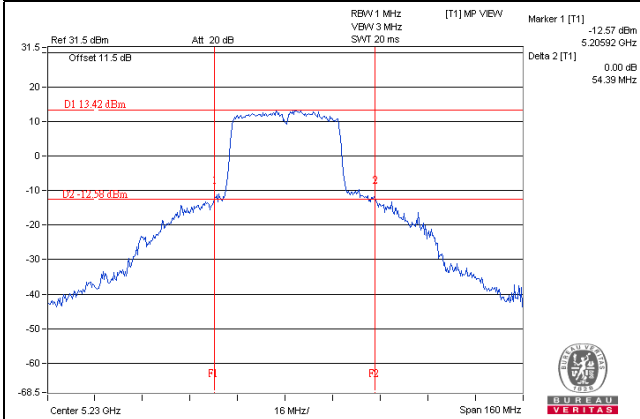

802.11ac (VHT80+VHT80)

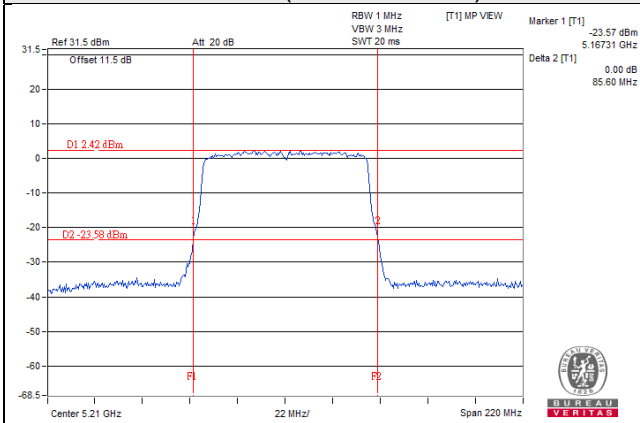

4.4 Occupied Bandwidth Measurement

4.4.1 Test Setup

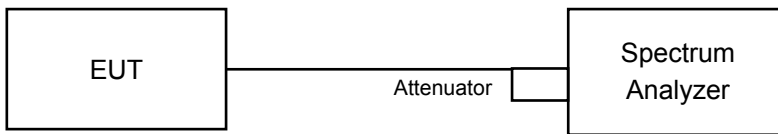

4.4.2 Test Instruments

Refer to section 4.1.2 to get information of above instrument.

4.4.3 Test Procedure

The transmitter output was connected to the spectrum analyzer through an attenuator. The bandwidth of the fundamental frequency was measured by spectrum analyzer with resolution bandwidth in the range of 1% to 5% of the anticipated emission bandwidth, and a video bandwidth at least 3x the resolution bandwidth and set the detector to Sample. The width of a frequency band such that, below the lower and above the upper frequency limits, the mean powers emitted are each equal to a specified percentage 0.5 %of the total mean power of a given emission.

4.4.4 Test Result

Radio 2: CDD Mode

802.11a

Channel	Frequency (MHz)	Occupied Bandwidth (MHz)			
		Chain 0	Chain 1	Chain 2	Chain 3
36	5180	18.36	16.56	16.56	16.56
40	5200	16.56	16.56	16.56	16.56
48	5240	16.56	16.56	16.56	16.56
149	5745	16.69	16.95	16.95	16.78
157	5785	16.80	17.04	17.28	16.92
165	5825	16.56	16.44	16.56	16.44

802.11n (HT20)

Channel	Frequency (MHz)	Occupied Bandwidth (MHz)			
		Chain 0	Chain 1	Chain 2	Chain 3
36	5180	17.76	17.76	17.76	17.64
40	5200	17.76	17.76	17.76	17.76
48	5240	17.76	17.76	17.76	17.64
149	5745	17.88	18.00	18.12	17.88
157	5785	18.00	18.12	18.36	18.00
165	5825	17.64	17.64	17.76	17.64

802.11n (HT40)

Channel	Frequency (MHz)	Occupied Bandwidth (MHz)			
		Chain 0	Chain 1	Chain 2	Chain 3
38	5190	36.12	36.12	36.36	36.12
46	5230	36.24	36.24	36.36	36.48
151	5755	36.24	36.24	36.24	36.24
159	5795	36.36	36.60	36.60	36.36

802.11ac (VHT80)

Channel	Frequency (MHz)	Occupied Bandwidth (MHz)			
		Chain 0	Chain 1	Chain 2	Chain 3
42	5210	76.08	75.84	76.08	76.08
155	5775	75.88	75.88	75.88	75.88

802.11ac (VHT80+VHT80)

Channel	Frequency (MHz)	Occupied Bandwidth (MHz)			
		Chain 0	Chain 1	Chain 2	Chain 3
42	5210	76.32	75.84	-	-
155	5775	-	-	75.84	75.84

Spectrum Plot of Worst Value

802.11a

802.11n (HT20)

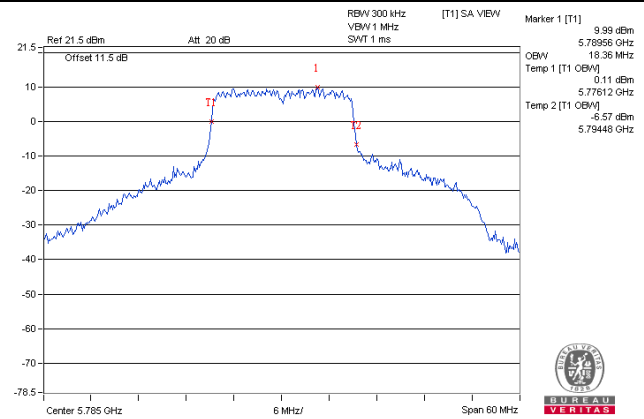
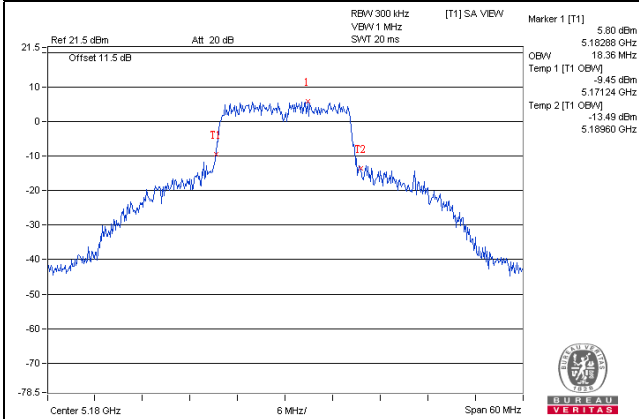

802.11n (HT40)

802.11ac (VHT80)

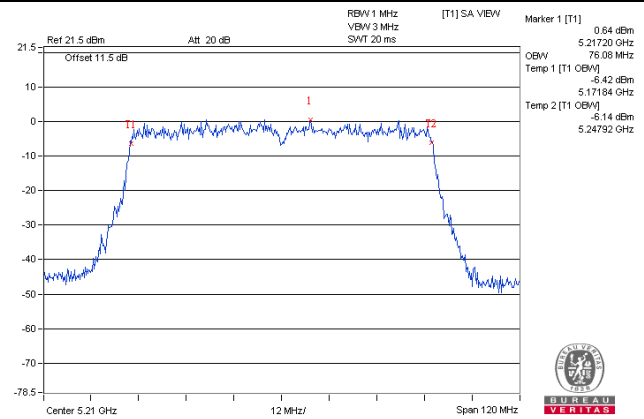
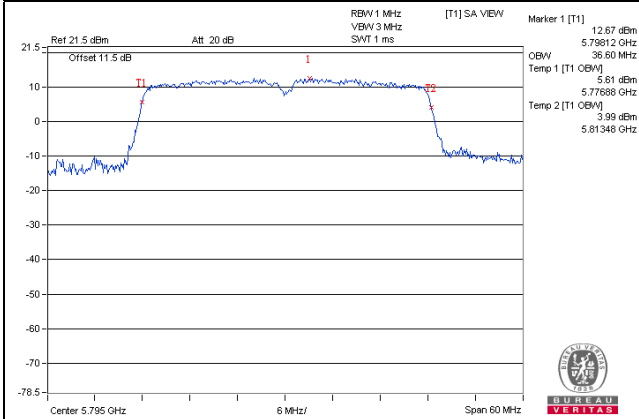

802.11ac (VHT80+VHT80)

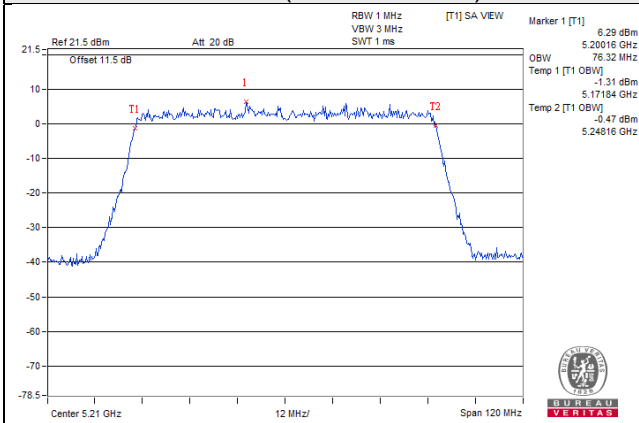

4.5 Peak Power Spectral Density Measurement

4.5.1 Limits of Peak Power Spectral Density Measurement

Operation Band	EUT Category		Limit
U-NII-1		Outdoor Access Point	17dBm/ MHz
		Fixed point-to-point Access Point	
	√	Indoor Access Point	
		Mobile and Portable client device	
U-NII-2A	---		11dBm/ MHz
U-NII-2C	---		11dBm/ MHz
U-NII-3	√		30dBm/ 500kHz

4.5.2 Test Setup

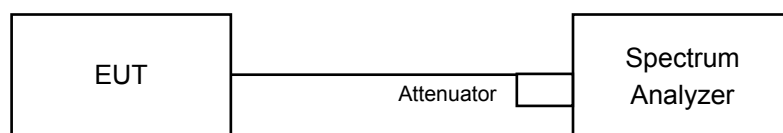

4.5.3 Test Instruments

Refer to section 4.1.2 to get information of above instrument.

4.5.4 Test Procedure

For U-NII-1 band:

Using method SA-1, Duty cycle >98%:

- a. Set span to encompass the entire emission bandwidth (EBW) of the signal.
- b. Set RBW = 1 MHz, Set VBW \geq 3 MHz, Detector = RMS
- c. Sweep time = auto, trigger set to "free run".
- d. Trace average at least 100 traces in power averaging mode.
- e. Record the max value

Using method SA-2, Duty cycle <98%

- a. Set span to encompass the entire emission bandwidth (EBW) of the signal.
- b. Set RBW = 1 MHz, Set VBW \geq 3 MHz, Detector = RMS
- c. Sweep time = auto, trigger set to "free run".
- d. Trace average at least 100 traces in power averaging mode.
- e. Record the max value and add $10 \log (1/\text{duty cycle})$

For U-NII-3 band:

Duty cycle >98%

- a. Set span to encompass the entire emission bandwidth (EBW) of the signal.
- b. Set RBW = 300 kHz, Set VBW \geq 1 MHz, Detector = RMS
- c. Use the peak marker function to determine the maximum power level in any 300 kHz band segment within the fundamental EBW.
- d. Scale the observed power level to an equivalent value in 500 kHz by adjusting (reducing) the measured power by a bandwidth correction factor (BWCF) where $\text{BWCF} = 10\log(500 \text{ kHz}/300\text{kHz})$
- e. Sweep time = auto, trigger set to "free run".
- f. Trace average at least 100 traces in power averaging mode.
- g. Record the max value

Duty cycle <98%

- a. Set span to encompass the entire emission bandwidth (EBW) of the signal.
- b. Set RBW = 300 kHz, Set VBW \geq 1 MHz, Detector = RMS
- c. Use the peak marker function to determine the maximum power level in any 300 kHz band segment within the fundamental EBW.
- d. Scale the observed power level to an equivalent value in 500 kHz by adjusting (reducing) the measured power by a bandwidth correction factor (BWCF) where $\text{BWCF} = 10\log(500 \text{ kHz}/300\text{kHz})$
- e. Sweep time = auto, trigger set to "free run".
- f. Trace average at least 100 traces in power averaging mode.
- g. Record the max value and add $10 \log (1/\text{duty cycle})$

4.5.5 Deviation from Test Standard

No deviation.

4.5.6 EUT Operating Condition

Same as Item 4.3.6.

4.5.7 Test Results

For U-NII-1 band:

Radio 2: CDD Mode

802.11a

Chan.	Freq. (MHz)	PSD (dBm)				Total PSD w/o duty factor (dBm/10kHz)	Duty factor	Total PSD with duty factor (dBm/10kHz)	Max. Limit (dBm/3kHz)	Pass / Fail
		Chain 0	Chain 1	Chain 2	Chain 3					
36	5180	1.89	1.87	2.20	1.80	7.96	0.17	8.13	11.27	Pass
40	5200	4.64	4.64	4.73	4.41	10.63	0.17	10.80	11.27	Pass
48	5240	3.77	3.62	3.47	3.38	9.58	0.17	9.75	11.27	Pass

Note:

- Method 1 of power density measurement of KDB 662911 is using for calculating total power density. Total power density is summing entire spectra across corresponding frequency bins on the various outputs by computer.
- Directional gain = $10 \log[(10^{G1/20} + 10^{G2/20} + \dots + 10^{GN/20})^2/4] = 11.73\text{dBi} > 6\text{dBi}$, so the power density limit shall be reduced to $17 - (11.73 - 6) = 11.27\text{dBm}$.
- Refer to section 3.3 for duty cycle spectrum plot.

802.11n (HT20)

Chan.	Freq. (MHz)	PSD (dBm)				Total PSD (dBm/3kHz)	Max. Limit (dBm/3kHz)	Pass / Fail
		Chain 0	Chain 1	Chain 2	Chain 3			
36	5180	2.39	2.97	3.34	2.53	8.84	11.27	Pass
40	5200	4.62	4.94	5.36	4.85	10.97	11.27	Pass
48	5240	4.38	4.32	4.56	4.17	10.38	11.27	Pass

Note:

- Method 1 of power density measurement of KDB 662911 is using for calculating total power density. Total power density is summing entire spectra across corresponding frequency bins on the various outputs by computer.
- Directional gain = $10 \log[(10^{G1/20} + 10^{G2/20} + \dots + 10^{GN/20})^2/4] = 11.73\text{dBi} > 6\text{dBi}$, so the power density limit shall be reduced to $17 - (11.73 - 6) = 11.27\text{dBm}$.

802.11n (HT40)

Chan.	Freq. (MHz)	PSD (dBm)				Total PSD w/o duty factor (dBm/10kHz)	Duty factor	Total PSD with duty factor (dBm/10kHz)	Max. Limit (dBm/3kHz)	Pass / Fail
		Chain 0	Chain 1	Chain 2	Chain 3					
38	5190	-4.02	-3.52	-3.06	-3.71	2.46	0.12	2.58	11.27	Pass
46	5230	2.16	2.31	2.58	2.31	8.36	0.12	8.48	11.27	Pass

Note:

- Method 1 of power density measurement of KDB 662911 is using for calculating total power density. Total power density is summing entire spectra across corresponding frequency bins on the various outputs by computer.
- Directional gain = $10 \log[(10^{G1/20} + 10^{G2/20} + \dots + 10^{GN/20})^2/4] = 11.73\text{dBi} > 6\text{dBi}$, so the power density limit shall be reduced to $17 - (11.73 - 6) = 11.27\text{dBm}$.
- Refer to section 3.3 for duty cycle spectrum plot.

802.11ac (VHT80)

Chan.	Freq. (MHz)	PSD (dBm)				Total PSD w/o duty factor (dBm/10kHz)	Duty factor	Total PSD with duty factor (dBm/10kHz)	Max. Limit (dBm/3kHz)	Pass / Fail
		Chain 0	Chain 1	Chain 2	Chain 3					
42	5210	-9.75	-9.61	-10.20	-9.84	-3.82	0.26	-3.56	11.27	Pass

Note:

1. Method 1 of power density measurement of KDB 662911 is using for calculating total power density. Total power density is summing entire spectra across corresponding frequency bins on the various outputs by computer.
2. Directional gain = $10 \log[(10^{G1/20} + 10^{G2/20} + \dots + 10^{GN/20})^2/4] = 11.73\text{dBi} > 6\text{dBi}$, so the power density limit shall be reduced to $17-(11.73-6) = 11.27\text{dBm}$.
3. Refer to section 3.3 for duty cycle spectrum plot.

802.11ac (VHT80+VHT80)

Chan.	Freq. (MHz)	PSD (dBm)				Total PSD w/o duty factor (dBm/10kHz)	Duty factor	Total PSD with duty factor (dBm/10kHz)	Max. Limit (dBm/3kHz)	Pass / Fail
		Chain 0	Chain 1	Chain 2	Chain 3					
42	5210	-8.47	-8.61	-	-	-5.53	0.28	-5.25	11.27	Pass

Note:

1. Method 1 of power density measurement of KDB 662911 is using for calculating total power density. Total power density is summing entire spectra across corresponding frequency bins on the various outputs by computer.
2. Directional gain = $10 \log[(10^{G1/20} + 10^{G2/20} + \dots + 10^{GN/20})^2/4] = 11.73\text{dBi} > 6\text{dBi}$, so the power density limit shall be reduced to $17-(11.73-6) = 11.27\text{dBm}$.
3. Refer to section 3.3 for duty cycle spectrum plot.

Spectrum Plot of Worst Value

802.11a / Ch 40 / Chain 2

802.11n (HT20) / Ch 40 / Chain 2

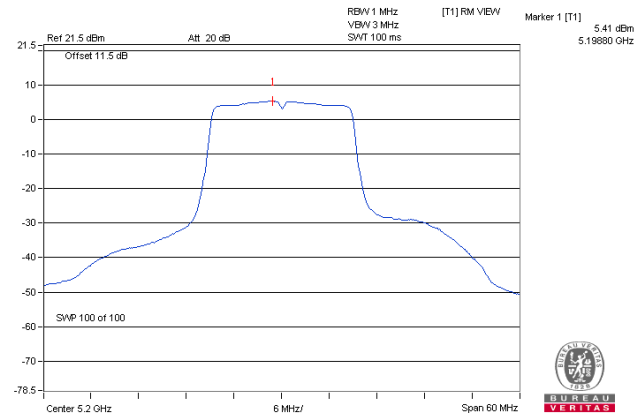
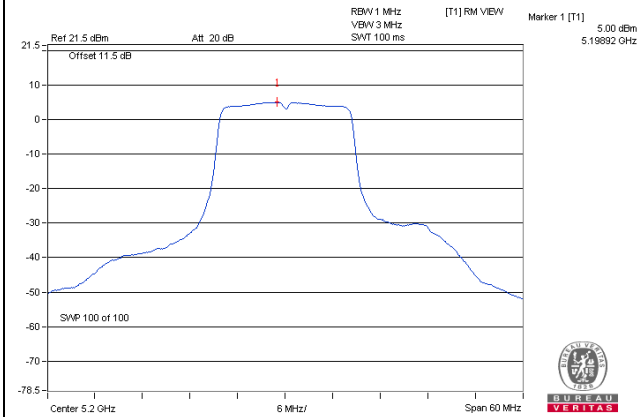

802.11n (HT40) / Ch 46 / Chain 2

802.11ac (VHT80) / Ch 42 / Chain 1

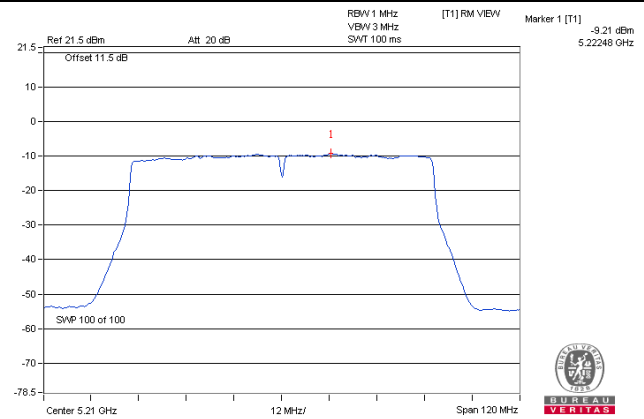
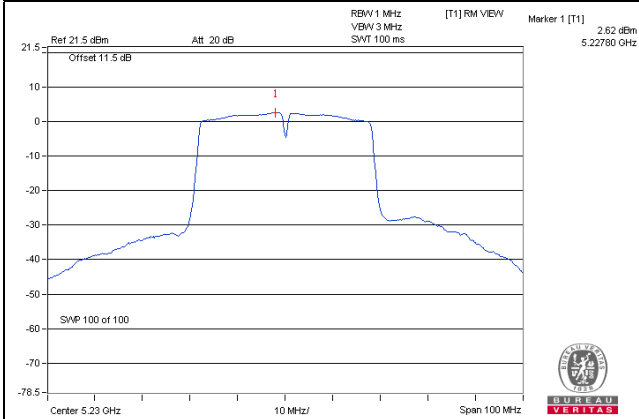

802.11ac (VHT80+VHT80) / Ch 42 / Chain 0

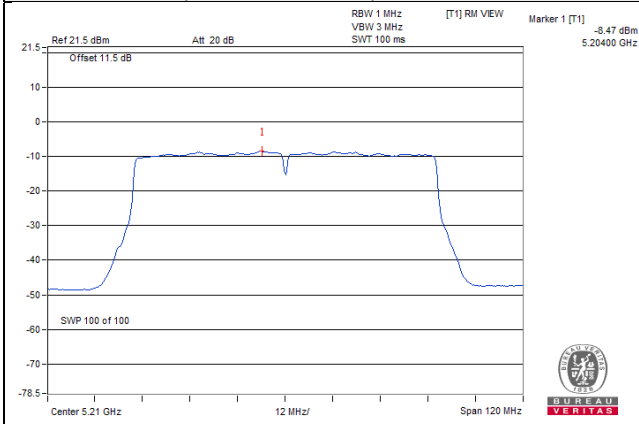

For U-NII-3 Band

Radio 2: CDD Mode

802.11a

TX chain	Channel	Chan. Freq. (MHz)	PSD W/O Duty Factor		10 log (N=4) dB	Duty factor	Total PSD With Duty Factor (dBm/500kHz)	Limit (dBm/500kHz)	Pass / Fail
			(dBm/300kHz)	(dBm/500kHz)					
0	149	5745	-2.55	-0.33	6.02	0.17	5.86	24.27	Pass
	157	5785	-2.45	-0.23	6.02	0.17	5.96	24.27	Pass
	165	5825	-3.57	-1.35	6.02	0.17	4.84	24.27	Pass
1	149	5745	-2.93	-0.71	6.02	0.17	5.48	24.27	Pass
	157	5785	-2.63	-0.41	6.02	0.17	5.78	24.27	Pass
	165	5825	-3.67	-1.45	6.02	0.17	4.74	24.27	Pass
2	149	5745	-2.96	-0.74	6.02	0.17	5.45	24.27	Pass
	157	5785	-2.87	-0.65	6.02	0.17	5.54	24.27	Pass
	165	5825	-4.05	-1.83	6.02	0.17	4.36	24.27	Pass
3	149	5745	-2.91	-0.69	6.02	0.17	5.50	24.27	Pass
	157	5785	-2.91	-0.69	6.02	0.17	5.50	24.27	Pass
	165	5825	-3.94	-1.72	6.02	0.17	4.47	24.27	Pass

Note:

1. Directional gain = $10 \log[(10^{G1/20} + 10^{G2/20} + \dots + 10^{GN/20})^2/4] = 11.73\text{dBi} > 6\text{dBi}$, so the power density limit shall be reduced to $30 - (11.73 - 6) = 24.27\text{dBm}$.
2. Refer to section 3.3 for duty cycle spectrum plot.

802.11n (HT20)

TX chain	Channel	Freq. (MHz)	PSD		10 log (N=4) dB	Total PSD (dBm/500kHz)	Limit (dBm/500kHz)	Pass / Fail
			(dBm/300kHz)	(dBm/500kHz)				
0	149	5745	-2.81	-0.59	6.02	5.43	24.27	Pass
	157	5785	-2.68	-0.46	6.02	5.56	24.27	Pass
	165	5825	-4.14	-1.92	6.02	4.10	24.27	Pass
1	149	5745	-2.86	-0.64	6.02	5.38	24.27	Pass
	157	5785	-2.86	-0.64	6.02	5.38	24.27	Pass
	165	5825	-4.24	-2.02	6.02	4.00	24.27	Pass
2	149	5745	-2.86	-0.64	6.02	5.38	24.27	Pass
	157	5785	-2.89	-0.67	6.02	5.35	24.27	Pass
	165	5825	-4.53	-2.31	6.02	3.71	24.27	Pass
3	149	5745	-2.58	-0.36	6.02	5.66	24.27	Pass
	157	5785	-2.58	-0.36	6.02	5.66	24.27	Pass
	165	5825	-3.94	-1.72	6.02	4.30	24.27	Pass

Note:

1. Directional gain = $10 \log[(10^{G1/20} + 10^{G2/20} + \dots + 10^{GN/20})^2/4] = 11.73\text{dBi} > 6\text{dBi}$, so the power density limit shall be reduced to $30 - (11.73 - 6) = 24.27\text{dBm}$.

802.11n (HT40)

TX chain	Channel	Chan. Freq. (MHz)	PSD W/O Duty Factor		10 log (N=4) dB	Duty factor	Total PSD With Duty Factor (dBm/500kHz)	Limit (dBm/500kHz)	Pass / Fail
			(dBm/300kHz)	(dBm/500kHz)					
0	151	5755	-6.93	-4.71	6.02	0.12	1.43	24.27	Pass
	159	5795	-5.99	-3.77	6.02	0.12	2.37	24.27	Pass
1	151	5755	-7.37	-5.15	6.02	0.12	0.99	24.27	Pass
	159	5795	-6.15	-3.93	6.02	0.12	2.21	24.27	Pass
2	151	5755	-7.22	-5.00	6.02	0.12	1.14	24.27	Pass
	159	5795	-6.23	-4.01	6.02	0.12	2.13	24.27	Pass
3	151	5755	-6.99	-4.77	6.02	0.12	1.37	24.27	Pass
	159	5795	-6.05	-3.83	6.02	0.12	2.31	24.27	Pass

Note:

1. Directional gain = $10 \log[(10^{G1/20} + 10^{G2/20} + \dots + 10^{GN/20})^2/4] = 11.73\text{dBi} > 6\text{dBi}$, so the power density limit shall be reduced to $30 - (11.73 - 6) = 24.27\text{dBm}$.
2. Refer to section 3.3 for duty cycle spectrum plot.

802.11ac (VHT80)

TX chain	Channel	Chan. Freq. (MHz)	PSD W/O Duty Factor		10 log (N=4) dB	Duty factor	Total PSD With Duty Factor (dBm/500kHz)	Limit (dBm/500kHz)	Pass / Fail
			(dBm/300kHz)	(dBm/500kHz)					
0	155	5775	-12.53	-10.31	6.02	0.26	-4.03	24.27	Pass
1	155	5775	-13.11	-10.89	6.02	0.26	-4.61	24.27	Pass
2	155	5775	-13.09	-10.87	6.02	0.26	-4.59	24.27	Pass
3	155	5775	-12.75	-10.53	6.02	0.26	-4.25	24.27	Pass

Note:

1. Directional gain = $10 \log[(10^{G1/20} + 10^{G2/20} + \dots + 10^{GN/20})^2/4] = 11.73\text{dBi} > 6\text{dBi}$, so the power density limit shall be reduced to $30 - (11.73 - 6) = 24.27\text{dBm}$.
2. Refer to section 3.3 for duty cycle spectrum plot.

802.11ac (VHT80+VHT80)

TX chain	Channel	Chan. Freq. (MHz)	PSD W/O Duty Factor		10 log (N=4) dB	Duty factor	Total PSD With Duty Factor (dBm/500kHz)	Limit (dBm/500kHz)	Pass / Fail
			(dBm/300kHz)	(dBm/500kHz)					
2	155	5775	-17.22	-15.00	6.02	0.28	-8.70	24.27	Pass
3	155	5775	-17.33	-15.11	6.02	0.28	-8.81	24.27	Pass

Note:

1. Directional gain = $10 \log[(10^{G1/20} + 10^{G2/20} + \dots + 10^{GN/20})^2/4] = 11.73\text{dBi} > 6\text{dBi}$, so the power density limit shall be reduced to $30 - (11.73 - 6) = 24.27\text{dBm}$.
2. Refer to section 3.3 for duty cycle spectrum plot.

Spectrum Plot of Worst Value

802.11a

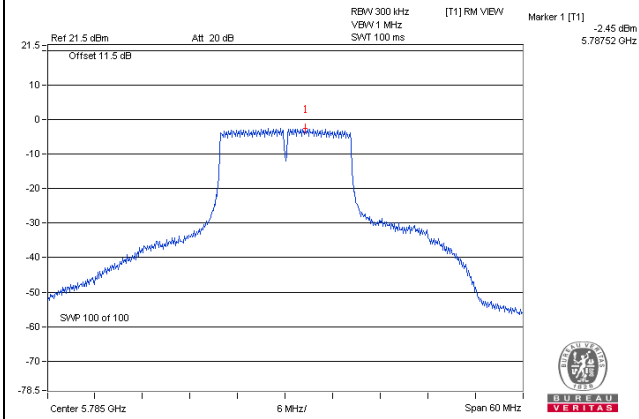

802.11n (HT20)

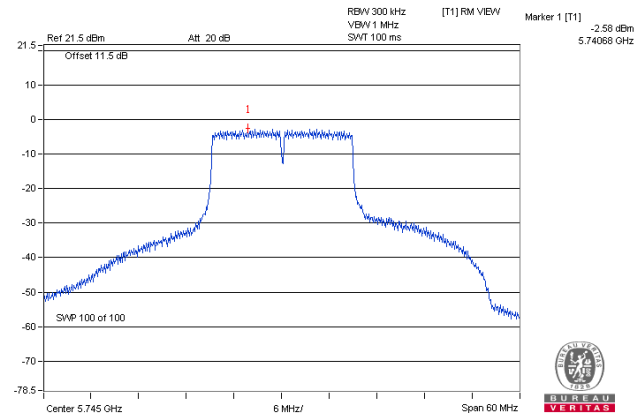

802.11n (HT40)

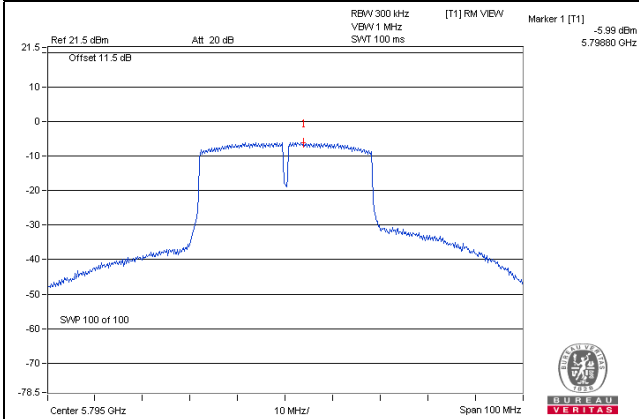

802.11ac (VHT80)

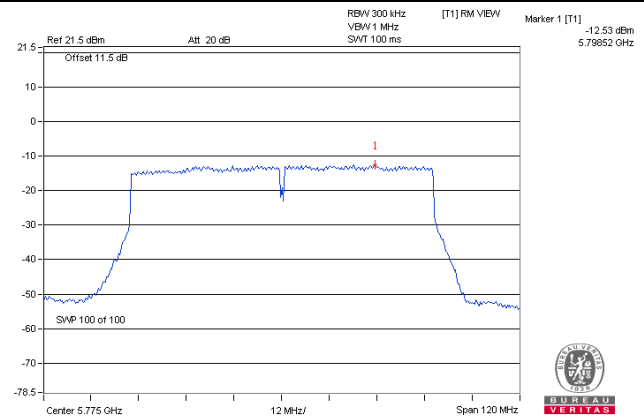

802.11ac (VHT80+VHT80)

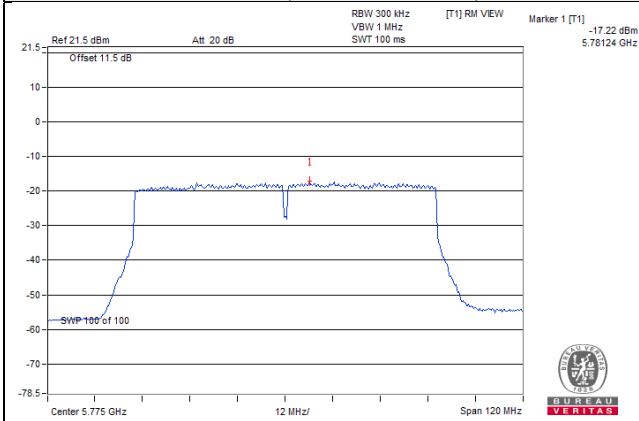

4.6 Frequency Stability

4.6.1 Limits of Frequency Stability Measurement

The frequency of the carrier signal shall be maintained within band of operation

4.6.2 Test Setup

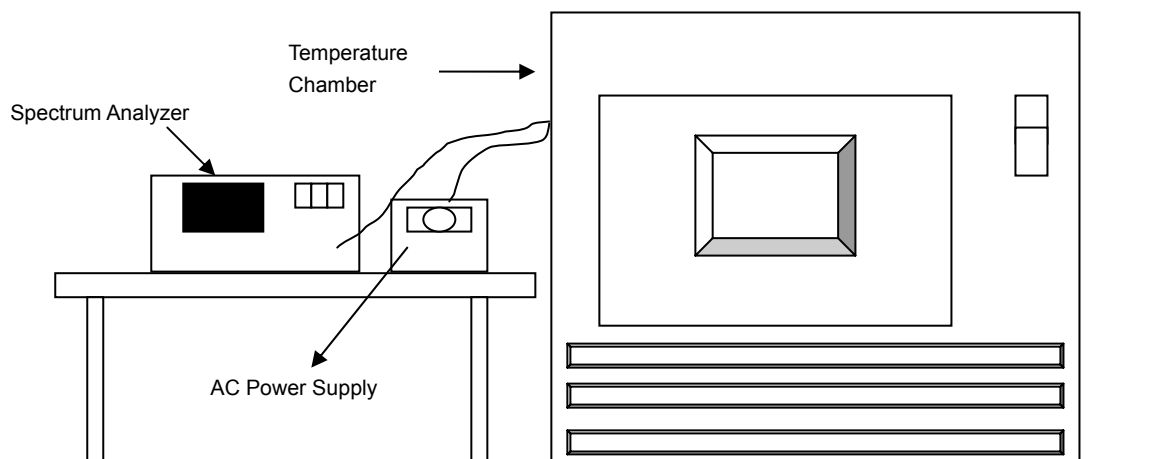

4.6.3 Test Instruments

Refer to section 4.1.2 to get information of above instrument.

4.6.4 Test Procedure

- The EUT was placed inside the environmental test chamber and powered by nominal AC voltage.
- Turn the EUT on and couple its output to a spectrum analyzer.
- Turn the EUT off and set the chamber to the highest temperature specified.
- Allow sufficient time (approximately 30 min) for the temperature of the chamber to stabilize, turn the EUT on and measure the operating frequency after 2, 5, and 10 minutes.
- Repeat step 2 and 3 with the temperature chamber set to the lowest temperature.
- The test chamber was allowed to stabilize at +20 degree C for a minimum of 30 minutes. The supply voltage was then adjusted on the EUT from 85% to 115% and the frequency record.

4.6.5 Deviation from Test Standard

No deviation.

4.6.6 EUT Operating Condition

Set the EUT transmit at un-modulation mode to test frequency stability.

4.6.7 Test Results

Radio 2: CDD Mode

Frequency Stability Versus Temp.									
Operating Frequency: 5180MHz									
Temp. (°C)	Power Supply (Vac)	0 Minute		2 Minute		5 Minute		10 Minute	
		Measured Frequency (MHz)	Frequency Drift (%)	Measured Frequency (MHz)	Frequency Drift (%)	Measured Frequency (MHz)	Frequency Drift (%)	Measured Frequency (MHz)	Frequency Drift (%)
50	120	5180.0192	0.00037	5180.0193	0.00037	5180.0212	0.00041	5180.0200	0.00039
40	120	5180.0124	0.00024	5180.0129	0.00025	5180.0146	0.00028	5180.0131	0.00025
30	120	5179.9765	-0.00045	5179.9721	-0.00054	5179.9754	-0.00047	5179.9722	-0.00054
20	120	5180.0220	0.00042	5180.0220	0.00042	5180.0228	0.00044	5180.0230	0.00044
10	120	5179.9860	-0.00027	5179.9897	-0.00020	5179.9864	-0.00026	5179.9896	-0.00020
0	120	5179.9899	-0.00019	5179.9906	-0.00018	5179.9906	-0.00018	5179.9921	-0.00015
-10	120	5180.0166	0.00032	5180.0144	0.00028	5180.0144	0.00028	5180.0170	0.00033
-20	120	5180.0056	0.00011	5180.0102	0.00020	5180.0075	0.00014	5180.0080	0.00015
-30	120	5180.0201	0.00039	5180.0224	0.00043	5180.0197	0.00038	5180.0212	0.00041

Frequency Stability Versus Voltage									
Operating Frequency: 5180MHz									
Temp. (°C)	Power Supply (Vac)	0 Minute		2 Minute		5 Minute		10 Minute	
		Measured Frequency (MHz)	Frequency Drift (%)	Measured Frequency (MHz)	Frequency Drift (%)	Measured Frequency (MHz)	Frequency Drift (%)	Measured Frequency (MHz)	Frequency Drift (%)
20	138	5180.0226	0.00044	5180.0228	0.00044	5180.0237	0.00046	5180.0238	0.00046
	120	5180.0220	0.00042	5180.0220	0.00042	5180.0228	0.00044	5180.0230	0.00044
	102	5180.0225	0.00043	5180.0221	0.00043	5180.0226	0.00044	5180.0235	0.00045

4.7 6dB Bandwidth Measurement

4.7.1 Limits of 6dB Bandwidth Measurement

The minimum of 6dB Bandwidth Measurement is 0.5MHz.

4.7.2 Test Setup

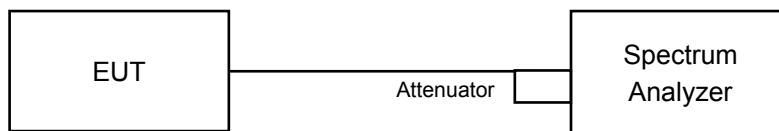

4.7.3 Test Instruments

Refer to section 4.1.2 to get information of above instrument.

4.7.4 Test Procedure

- Set resolution bandwidth (RBW) = 100kHz
- Set the video bandwidth (VBW) $\geq 3 \times$ RBW, Detector = Peak
- Trace mode = max hold
- Sweep = auto couple
- Measure the maximum width of the emission that is constrained by the frequencies associated with the two amplitude points (upper and lower) that are attenuated by 6 dB relative to the maximum level measured in the fundamental emission

4.7.5 Deviation from Test Standard

No deviation.

4.7.6 EUT Operating Condition

The software provided by client to enable the EUT under transmission Condition continuously at lowest, middle and highest channel frequencies individually.

4.7.7 Test Results

Radio 2: CDD Mode

802.11a

Channel	Frequency (MHz)	6dB Bandwidth (MHz)				Minimum Limit (MHz)	Pass / Fail
		Chain 0	Chain 1	Chain 2	Chain 3		
149	5745	16.35	16.34	16.34	16.36	0.5	Pass
157	5785	16.37	16.37	16.37	16.39	0.5	Pass
165	5825	16.38	16.38	16.38	16.40	0.5	Pass

802.11n (HT20)

Channel	Frequency (MHz)	6dB Bandwidth (MHz)				Minimum Limit (MHz)	Pass / Fail
		Chain 0	Chain 1	Chain 2	Chain 3		
149	5745	17.60	17.58	17.61	17.61	0.5	Pass
157	5785	17.59	17.62	17.59	17.62	0.5	Pass
165	5825	17.61	17.61	17.62	17.63	0.5	Pass

802.11n (HT40)

Channel	Frequency (MHz)	6dB Bandwidth (MHz)				Minimum Limit (MHz)	Pass / Fail
		Chain 0	Chain 1	Chain 2	Chain 3		
151	5755	35.33	35.23	35.31	35.24	0.5	Pass
159	5795	35.23	35.27	35.25	35.19	0.5	Pass

802.11ac (VHT80)

Channel	Frequency (MHz)	6dB Bandwidth (MHz)				Minimum Limit (MHz)	Pass / Fail
		Chain 0	Chain 1	Chain 2	Chain 3		
155	5775	75.68	75.49	75.49	75.54	0.5	Pass

802.11ac (VHT80+VHT80)

Channel	Frequency (MHz)	6dB Bandwidth (MHz)				Minimum Limit (MHz)	Pass / Fail
		Chain 0	Chain 1	Chain 2	Chain 3		
155	5775	-	-	75.52	75.47	0.5	Pass

Spectrum Plot of Worst Value

802.11a

802.11n (HT20)

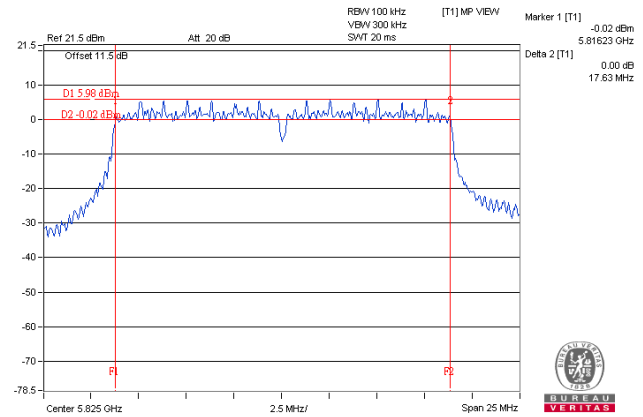
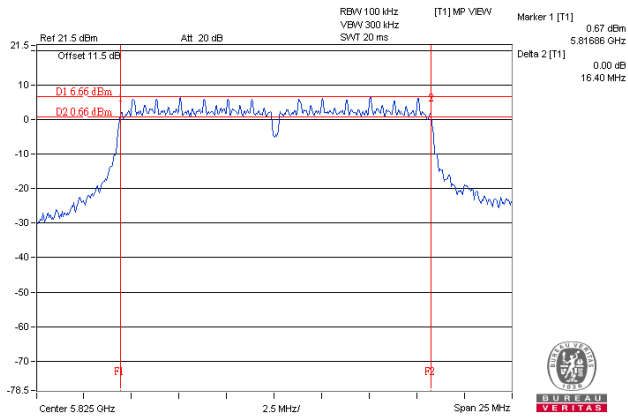

802.11n (HT40)

802.11ac (VHT80)

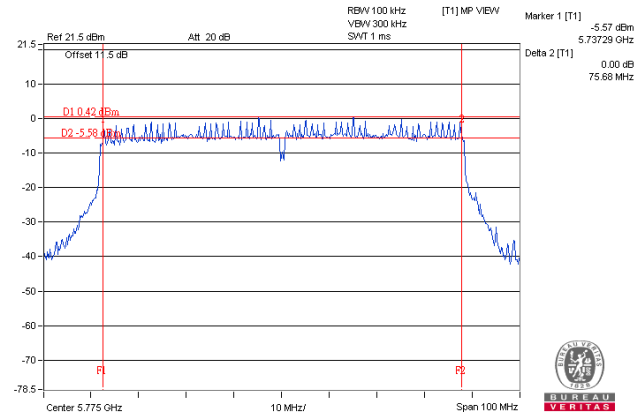
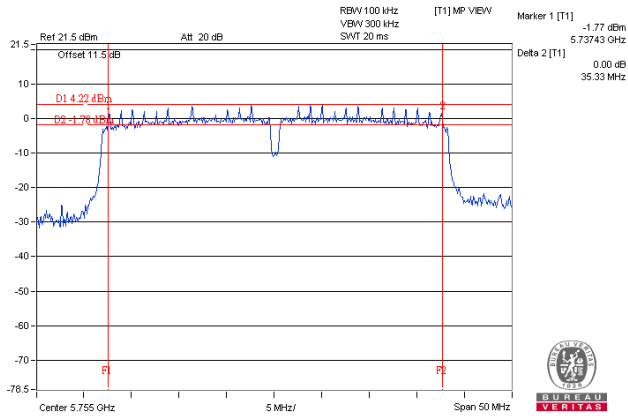

802.11ac (VHT80+VHT80)

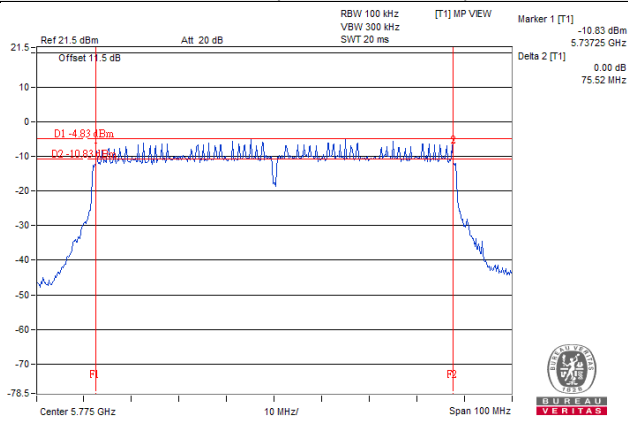

5 Pictures of Test Arrangements

Please refer to the attached file (Test Setup Photo).

Annex A- Radiated Out of Band Emission (OOBE) Measurement (For U-NII-3 band)

Radio 2: CDD Mode

802.11a

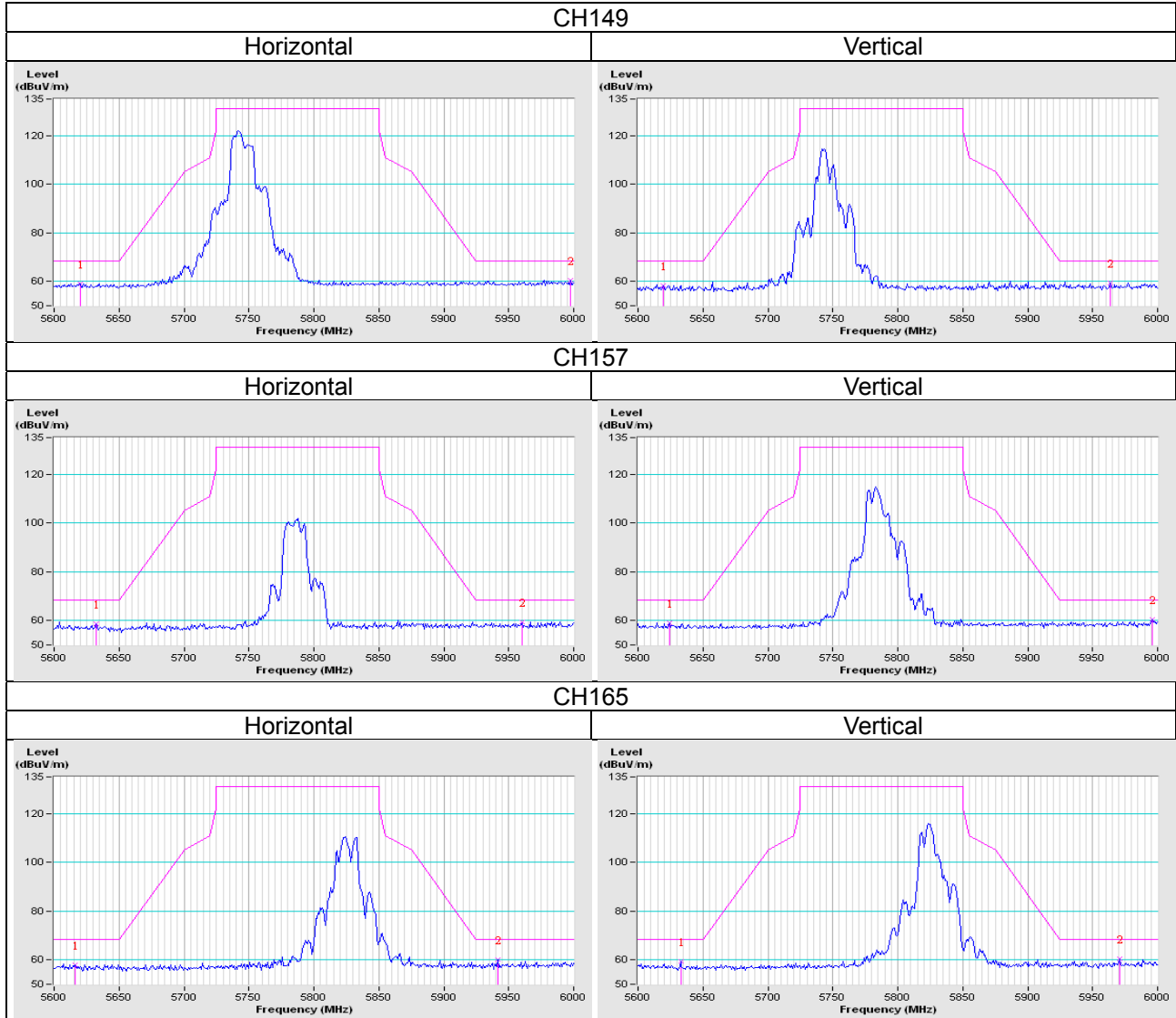

802.11n (HT20)

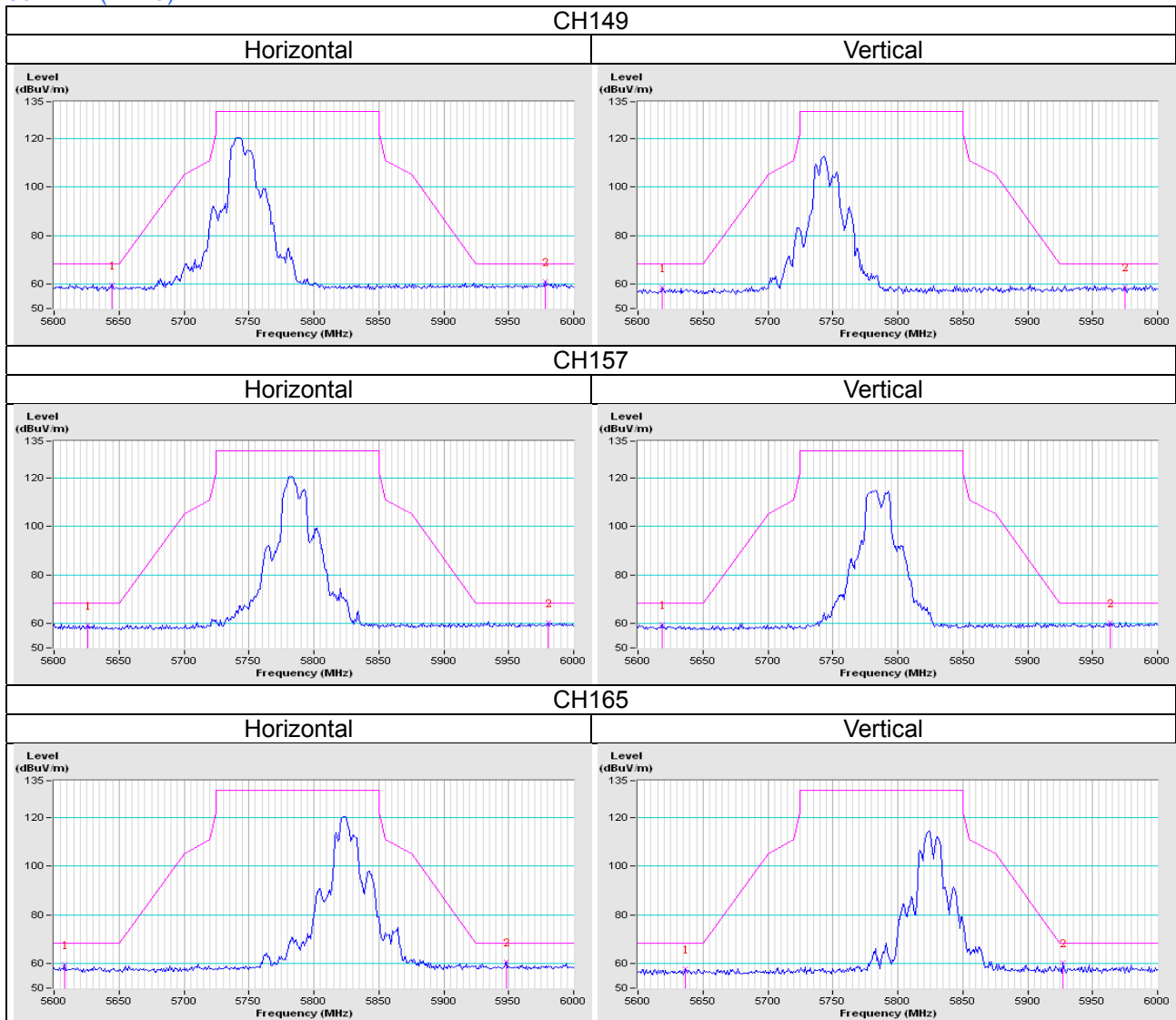

802.11n (HT40)

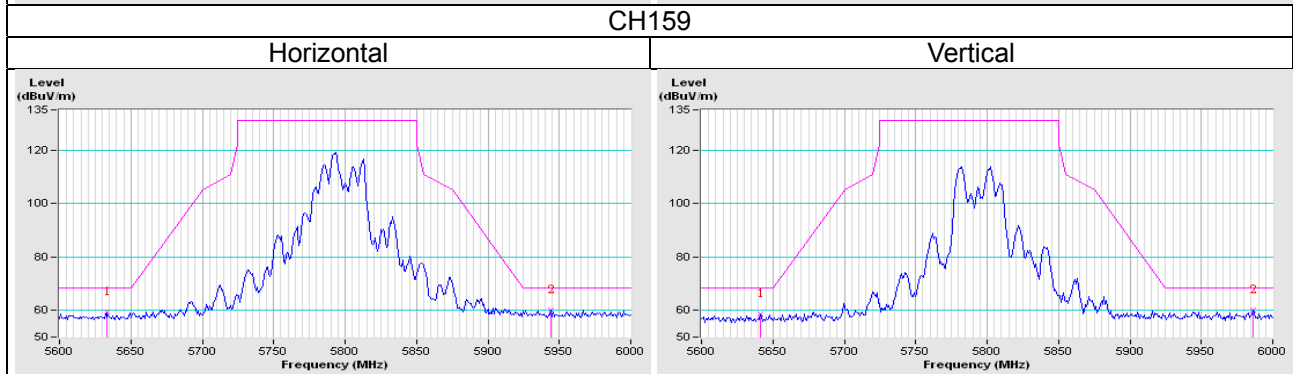
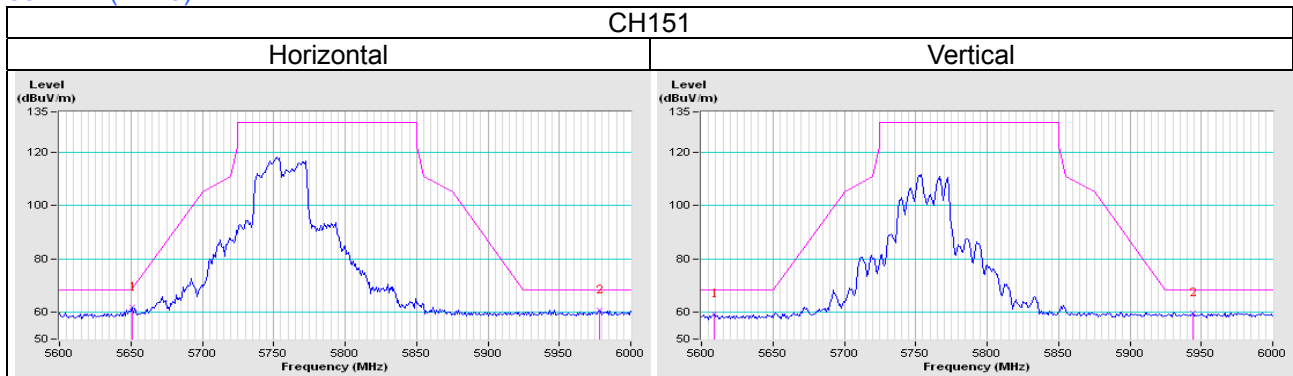

802.11ac (VHT80)

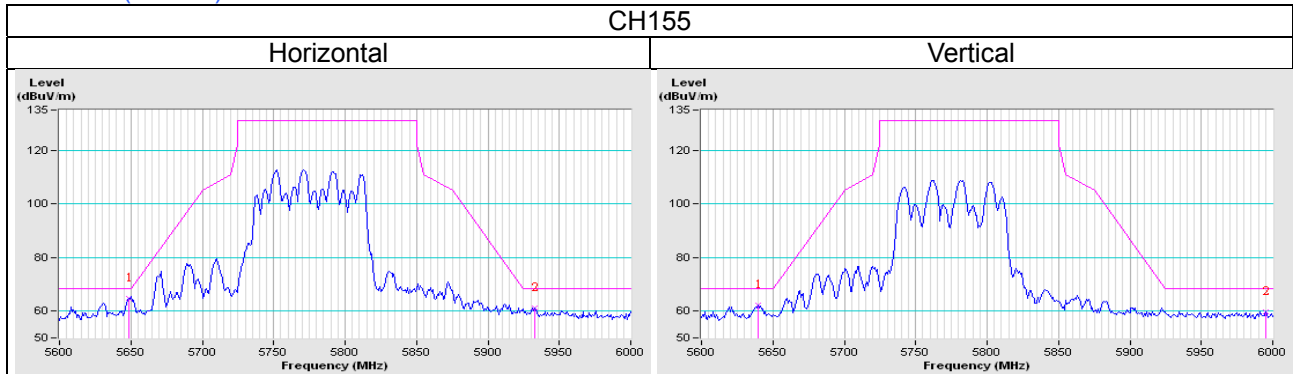

802.11ac (VHT80+VHT80)

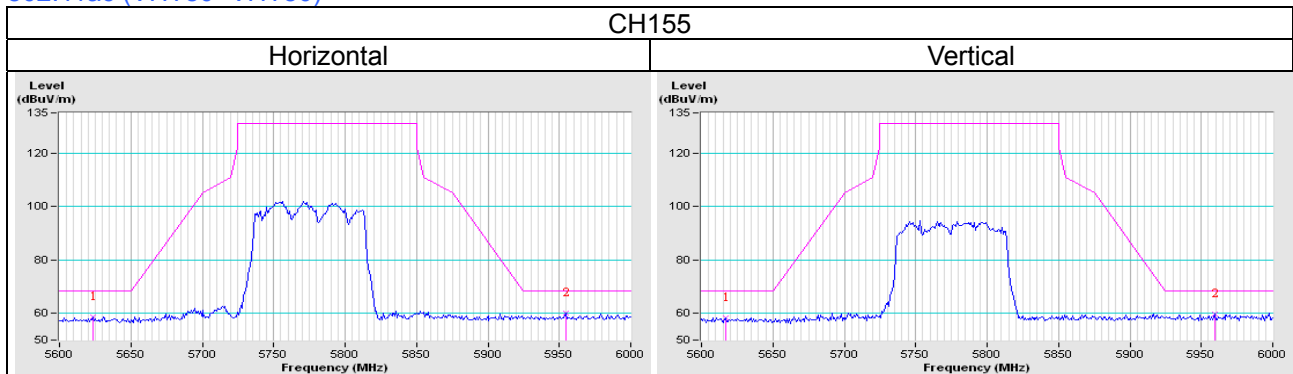

Appendix – Information on the Testing Laboratories

We, Bureau Veritas Consumer Products Services (H.K.) Ltd., Taoyuan Branch, were founded in 1988 to provide our best service in EMC, Radio, Telecom and Safety consultation. Our laboratories are accredited and approved according to ISO/IEC 17025.

If you have any comments, please feel free to contact us at the following:

Linko EMC/RF Lab

Tel: 886-2-26052180

Fax: 886-2-26051924

Hsin Chu EMC/RF/Telecom Lab

Tel: 886-3-6668565

Fax: 886-3-6668323

Hwa Ya EMC/RF/Safety Lab

Tel: 886-3-3183232

Fax: 886-3-3270892

Email: service.adt@tw.bureauveritas.com

Web Site: www.bureauveritas-adt.com

The address and road map of all our labs can be found in our web site also.

--- END ---