

FCC Test Report

Report No.: RF160726C12B

FCC ID: 2AGMRAP12I360

Test Model: AP12I360

Received Date: Jul. 26, 2016

Test Date: Jul. 29 ~ Sep. 09, 2016

Issued Date: Nov. 10, 2016

Applicant: Tembo Systems, Inc.

Address: 2933 Bunker Hill Lane, Suite 100, Santa Clara, CA 95054, United States.

Issued By: Bureau Veritas Consumer Products Services (H.K.) Ltd., Taoyuan Branch

Lab Address: No. 47-2, 14th Ling, Chia Pau Vil., Lin Kou Dist., New Taipei City, Taiwan, R.O.C.

Test Location: No.19, Hwa Ya 2nd Rd., Wen Hwa Vil., Kwei Shan Dist., Taoyuan City 33383, TAIWAN (R.O.C.)



This report is for your exclusive use. Any copying or replication of this report to or for any other person or entity, or use of our name or trademark, is permitted only with our prior written permission. This report sets forth our findings solely with respect to the test samples identified herein. The results set forth in this report are not indicative or representative of the quality or characteristics of the lot from which a test sample was taken or any similar or identical product unless specifically and expressly noted. Our report includes all of the tests requested by you and the results thereof based upon the information that you provided to us. You have 60 days from date of issuance of this report to notify us of any material error or omission caused by our negligence, provided, however, that such notice shall be in writing and shall specifically address the issue you wish to raise. A failure to raise such issue within the prescribed time shall constitute your unqualified acceptance of the completeness of this report, the tests conducted and the correctness of the report contents. Unless specific mention, the uncertainty of measurement has been explicitly taken into account to declare the compliance or non-compliance to the specification. This report should not be used by the client to claim product certification, approval, or endorsement by TAF or any government agencies.

Table of Contents

Release Control Record	4
1 Certificate of Conformity	5
2 Summary of Test Results	6
2.1 Measurement Uncertainty.....	6
2.2 Modification Record.....	6
3 General Information	7
3.1 General Description of EUT.....	7
3.2 Description of Test Modes.....	9
3.2.1 Test Mode Applicability and Tested Channel Detail.....	10
3.3 Duty Cycle of Test Signal.....	12
3.4 Description of Support Units.....	14
3.4.1 Configuration of System under Test.....	15
3.5 General Description of Applied Standards.....	16
4 Test Types and Results	17
4.1 Radiated Emission and Bandedge Measurement.....	17
4.1.1 Limits of Radiated Emission and Bandedge Measurement.....	17
4.1.2 Test Instruments.....	18
4.1.3 Test Procedures.....	19
4.1.4 Deviation from Test Standard.....	19
4.1.5 Test Set Up.....	20
4.1.6 EUT Operating Conditions.....	21
4.1.7 Test Results.....	22
4.2 Conducted Emission Measurement.....	50
4.2.1 Limits of Conducted Emission Measurement.....	50
4.2.2 Test Instruments.....	50
4.2.3 Test Procedures.....	51
4.2.4 Deviation from Test Standard.....	51
4.2.5 Test Setup.....	51
4.2.6 EUT Operating Conditions.....	51
4.2.7 Test Results.....	52
4.3 6dB Bandwidth Measurement.....	60
4.3.1 Limits of 6dB Bandwidth Measurement.....	60
4.3.2 Test Setup.....	60
4.3.3 Test Instruments.....	60
4.3.4 Test Procedure.....	60
4.3.5 Deviation from Test Standard.....	60
4.3.6 EUT Operating Conditions.....	60
4.3.7 Test Result.....	61
4.4 Conducted Output Power Measurement.....	65
4.4.1 Limits of Conducted Output Power Measurement.....	65
4.4.2 Test Setup.....	65
4.4.3 Test Instruments.....	65
4.4.4 Test Procedures.....	65
4.4.5 Deviation from Test Standard.....	65
4.4.6 EUT Operating Conditions.....	65
4.4.7 Test Results.....	66
4.5 Power Spectral Density Measurement.....	69
4.5.1 Limits of Power Spectral Density Measurement.....	69
4.5.2 Test Setup.....	69
4.5.3 Test Instruments.....	69
4.5.4 Test Procedure.....	69
4.5.5 Deviation from Test Standard.....	70
4.5.6 EUT Operating Condition.....	70

4.5.7 Test Results	71
4.6 Conducted Out of Band Emission Measurement.....	78
4.6.1 Limits of Conducted Out of Band Emission Measurement	78
4.6.2 Test Setup.....	78
4.6.3 Test Instruments	78
4.6.4 Test Procedure	78
4.6.5 Deviation from Test Standard	79
4.6.6 EUT Operating Condition	79
4.6.7 Test Results	79
5 Pictures of Test Arrangements.....	100
Appendix – Information on the Testing Laboratories	101

Release Control Record

Issue No.	Description	Date Issued
RF160726C12B	Original release	Nov. 10, 2016

1 Certificate of Conformity

Product: AP1002Oi 2-Radio Omni-Directional Indoor Access Point

Brand: EVEREST™ Network Solutions

Test Model: AP12I360

Sample Status: Engineering sample

Applicant: Tembo Systems, Inc.

Test Date: Jul. 29 ~ Sep. 09, 2016

Standards: 47 CFR FCC Part 15, Subpart C (Section 15.247)
ANSI C63.10:2013

The above equipment has been tested by **Bureau Veritas Consumer Products Services (H.K.) Ltd., Taoyuan Branch**, and found compliance with the requirement of the above standards. The test record, data evaluation & Equipment Under Test (EUT) configurations represented herein are true and accurate accounts of the measurements of the sample's EMC characteristics under the conditions specified in this report.

Prepared by : Celine Chou , **Date:** Nov. 10, 2016
Celine Chou / Specialist

Approved by : Ken Liu , **Date:** Nov. 10, 2016
Ken Liu / Senior Manager

2 Summary of Test Results

47 CFR FCC Part 15, Subpart C (Section 15.247)			
FCC Clause	Test Item	Result	Remarks
15.207	AC Power Conducted Emission	Pass	Meet the requirement of limit. Minimum passing margin is -7.70dB at 0.52544MHz
15.205 / 15.209 / 15.247(d)	Radiated Emissions and Band Edge Measurement	Pass	Meet the requirement of limit. Minimum passing margin is -1.1dB at 4874.00MHz.
15.247(d)	Antenna Port Emission	Pass	Meet the requirement of limit.
15.247(a)(2)	6dB bandwidth	Pass	Meet the requirement of limit.
15.247(b)	Conducted power	Pass	Meet the requirement of limit.
15.247(e)	Power Spectral Density	Pass	Meet the requirement of limit.
15.203	Antenna Requirement	Pass	Antenna connector is IPEX not a standard connector.

2.1 Measurement Uncertainty

Where relevant, the following measurement uncertainty levels have been estimated for tests performed on the EUT as specified in CISPR 16-4-2:

Measurement	Frequency	Expanded Uncertainty (k=2) (\pm)
Conducted Emissions at mains ports	150kHz ~ 30MHz	2.44 dB
Radiated Emissions up to 1 GHz	30MHz ~ 200MHz	3.86 dB
	200MHz ~ 1000MHz	3.87 dB
Radiated Emissions above 1 GHz	1GHz ~ 18GHz	2.29 dB
	18GHz ~ 40GHz	2.29 dB

2.2 Modification Record

There were no modifications required for compliance.

3 General Information

3.1 General Description of EUT

Product	AP1002Oi 2-Radio Omni-Directional Indoor Access Point
Brand	EVEREST™ Network Solutions
Test Model	AP12I360
Sample Status	Engineering sample
Power Supply Rating	12Vdc from adapter 48Vdc from POE
Modulation Type	CCK, DQPSK, DBPSK for DSSS 64QAM, 16QAM, QPSK, BPSK for OFDM
Modulation Technology	DSSS, OFDM
Transfer Rate	802.11b: 11.0/ 5.5/ 2.0/ 1.0Mbps 802.11g: 54.0/ 48.0/ 36.0/ 24.0/ 18.0/ 12.0/ 9.0/ 6.0Mbps 802.11n: up to 600Mbps
Operating Frequency	2412 ~ 2462MHz
Number of Channel	11 for 802.11b, 802.11g, 802.11n (HT20) 7 for 802.11n (HT40)
Output Power	Radio 1: CDD Mode: 315.359mW Beamforming Mode: 75.262mW Radio 3: CDD Mode: 20.091mW
Antenna Type	Refer to note
Antenna Connector	Refer to note
Accessory Device	NA
Data Cable Supplied	NA

Note:

1. There are four radios for the EUT.

Radio	Model	Function
Radio 1	QCA9994	WLAN 2.4G
Radio 2	QCA9994	WLAN 5G
Radio 3	QCA9889	WLAN 2.4GHz (TX/RX)+5GHz (RX)
Radio 4	MKW40Z160 MCU	BT LE

2. The EUT incorporates a MIMO function. Physically, the EUT provides 4 completed transmitters and 4 receivers.

Modulation Mode	TX Function	Beamforming	Remark
802.11b	4TX	Not Support	Radio 1
802.11g	4TX	Not Support	
802.11n (HT20)	4TX	Support	
802.11n (HT40)	4TX	Support	
802.11b	1TX	Not Support	Radio 3
802.11g	1TX	Not Support	
802.11n (HT20)	1TX	Not Support	
802.11n (HT40)	1TX	Not Support	

* For 2.4GHz band, CDD mode is the worst case for final tests except RF output power test after pretesting CDD mode and beamforming mode.

3. The EUT uses following antennas.

Ant. No.	1	2	3	4	5	6	7	8	9 (Scan) Individual	10 (BLE) Individual
Ant. Type	PIFA								PIFA	Dipole
Frequency (MHz)	2400-2500				5150-5850				2400-2500/ 5150-5850	2400-2500
Gain (dBi)	3.81	3.98	3.47	3.75	5.65	5.50	5.84	5.84	2.9/5.1	3.93
Connector	IPEX								IPEX	IPEX

4. The EUT consumes power from the following adapter and POE. (Support units only)

Adapter	
Brand	AOEM
Model	ADS036T-W120300
Input Power	100-240Vac, 50-60Hz, 1.0A
Output Power	12Vdc, 3.0A
Power Line	1.5m cable with one core attached on adapter

POE	
Brand	EnGenius
Model	EPE-48GR
Output Power	48Vdc, 0.5A, 24W Max

POE's adapter	
Brand	Powertron Electronics Corp.
Model	PA1040-480IB080
Input Power	100-240Vac, 50-60Hz, 1.5A
Output Power	48Vdc, 0.8A, 38.4W Max
Power Line	1.55m cable with one core attached on adapter

5. 2.4GHz, 5GHz and BT LE technology can transmit at same time.

6. Spurious emission of the simultaneous operation (2.4GHz, 5GHz and BT LE) has been evaluated and no non-compliance was found.

3.2 Description of Test Modes

11 channels are provided for 802.11b, 802.11g and 802.11n (HT20):

Channel	Frequency	Channel	Frequency
1	2412MHz	7	2442MHz
2	2417MHz	8	2447MHz
3	2422MHz	9	2452MHz
4	2427MHz	10	2457MHz
5	2432MHz	11	2462MHz
6	2437MHz		

7 channels are provided for 802.11n (HT40):

Channel	Frequency	Channel	Frequency
3	2422MHz	7	2442MHz
4	2427MHz	8	2447MHz
5	2432MHz	9	2452MHz
6	2437MHz		

3.2.1 Test Mode Applicability and Tested Channel Detail

EUT CONFIGURE MODE	APPLICABLE TO				DESCRIPTION
	RE \geq 1G	RE<1G	PLC	APCM	
A	√	√	√	√	Power from adapter
B	-	√	√	-	Power from POE

Where **RE \geq 1G**: Radiated Emission above 1GHz & Bandedge Measurement
RE<1G: Radiated Emission below 1GHz
PLC: Power Line Conducted Emission
APCM: Antenna Port Conducted Measurement

Note:

1. The EUT had been pre-tested on the positioned of each 3 axis. The worst case was found when positioned on **Y-plane**.
2. "-" means no effect.

Radiated Emission Test (Above 1GHz):

- Pre-Scan has been conducted to determine the worst-case mode from all possible combinations between available modulations, data rates and antenna ports (if EUT with antenna diversity architecture).
- Following channel(s) was (were) selected for the final test as listed below.

EUT CONFIGURE MODE	MODE	AVAILABLE CHANNEL	TESTED CHANNEL	MODULATION TECHNOLOGY	MODULATION TYPE	DATA RATE (Mbps)	REMARK
A	802.11b	1 to 11	1, 6, 11	DSSS	DBPSK	1.0	Radio 1 (4TX)
		1 to 11	1, 6, 11	DSSS	DBPSK	1.0	Radio 3 (1TX)
A	802.11g	1 to 11	1, 6, 11	OFDM	BPSK	6.0	Radio 1 (4TX)
		1 to 11	1, 6, 11	OFDM	BPSK	6.0	Radio 3 (1TX)
A	802.11n (HT20)	1 to 11	1, 6, 11	OFDM	BPSK	6.5	Radio 1 (4TX)
		1 to 11	1, 6, 11	OFDM	BPSK	6.5	Radio 3 (1TX)
A	802.11n (HT40)	3 to 9	3, 6, 9	OFDM	BPSK	13.5	Radio 1 (4TX)
		3 to 9	3, 6, 9	OFDM	BPSK	13.5	Radio 3 (1TX)

Radiated Emission Test (Below 1GHz):

- Pre-Scan has been conducted to determine the worst-case mode from all possible combinations between available modulations, data rates and antenna ports (if EUT with antenna diversity architecture).
- Following channel(s) was (were) selected for the final test as listed below.

EUT CONFIGURE MODE	MODE	AVAILABLE CHANNEL	TESTED CHANNEL	MODULATION TECHNOLOGY	MODULATION TYPE	DATA RATE (Mbps)	REMARK
A, B	802.11b	1 to 11	1	DSSS	DBPSK	1.0	Radio 1 (4TX)
		1 to 11		DSSS	DBPSK	1.0	Radio 3 (1TX)

Power Line Conducted Emission Test:

- Pre-Scan has been conducted to determine the worst-case mode from all possible combinations between available modulations, data rates and antenna ports (if EUT with antenna diversity architecture).
- Following channel(s) was (were) selected for the final test as listed below.

EUT CONFIGURE MODE	MODE	AVAILABLE CHANNEL	TESTED CHANNEL	MODULATION TECHNOLOGY	MODULATION TYPE	DATA RATE (Mbps)	REMARK
A, B	802.11b	1 to 11	1	DSSS	DBPSK	1.0	Radio 1 (4TX)
		1 to 11		DSSS	DBPSK	1.0	Radio 3 (1TX)

Antenna Port Conducted Measurement:

- This item includes all test value of each mode, but only includes spectrum plot of worst value of each mode.
- Pre-Scan has been conducted to determine the worst-case mode from all possible combinations between available modulations, data rates and antenna ports (if EUT with antenna diversity architecture).
- Following channel(s) was (were) selected for the final test as listed below.

EUT CONFIGURE MODE	MODE	AVAILABLE CHANNEL	TESTED CHANNEL	MODULATION TECHNOLOGY	MODULATION TYPE	DATA RATE (Mbps)	REMARK
CDD Mode							
A	802.11b	1 to 11	1, 6, 11	DSSS	DBPSK	1.0	Radio 1 (4TX)
		1 to 11	1, 6, 11	DSSS	DBPSK	1.0	Radio 3 (1TX)
A	802.11g	1 to 11	1, 6, 11	OFDM	BPSK	6.0	Radio 1 (4TX)
		1 to 11	1, 6, 11	OFDM	BPSK	6.0	Radio 3 (1TX)
A	802.11n (HT20)	1 to 11	1, 6, 11	OFDM	BPSK	6.5	Radio 1 (4TX)
		1 to 11	1, 6, 11	OFDM	BPSK	6.5	Radio 3 (1TX)
A	802.11n (HT40)	3 to 9	3, 6, 9	OFDM	BPSK	13.5	Radio 1 (4TX)
		3 to 9	3, 6, 9	OFDM	BPSK	13.5	Radio 3 (1TX)
Beamforming Mode							
A	802.11n (HT20)	1 to 11	1, 6, 11	OFDM	BPSK	6.5	Radio 1 (4TX)
A	802.11n (HT40)	3 to 9	3, 6, 9	OFDM	BPSK	13.5	Radio 1 (4TX)

Test Condition:

APPLICABLE TO	ENVIRONMENTAL CONDITIONS	INPUT POWER	TESTED BY
RE≥1G	19deg. C, 70%RH 18deg. C, 70%RH	120Vac, 60Hz	James Yang
RE<1G	19deg. C, 70%RH 18deg. C, 70%RH	120Vac, 60Hz 48Vdc	Jones Chang
PLC	20deg. C, 70%RH	120Vac, 60Hz 48Vdc	Jones Chang
APCM	25deg. C, 60%RH	120Vac, 60Hz	Leo Tsai

3.3 Duty Cycle of Test Signal

Radio 1

802.11b, 802.11n (HT20): Duty cycle of test signal is > 98%, duty factor is not required.

802.11g, 802.11n (HT40): Duty cycle of test signal is < 98%, duty factor shall be considered.

802.11b: Duty cycle = $12.437/12.499 = 0.995$

802.11g: Duty cycle = $2.060/2.150 = 0.958$, Duty factor = $10 * \log(1/0.958) = 0.19$

802.11n (HT20): Duty cycle = $4.997/5.090 = 0.982$

802.11n (HT40): Duty cycle = $2.422/2.497 = 0.970$, Duty factor = $10 * \log(1/0.970) = 0.13$

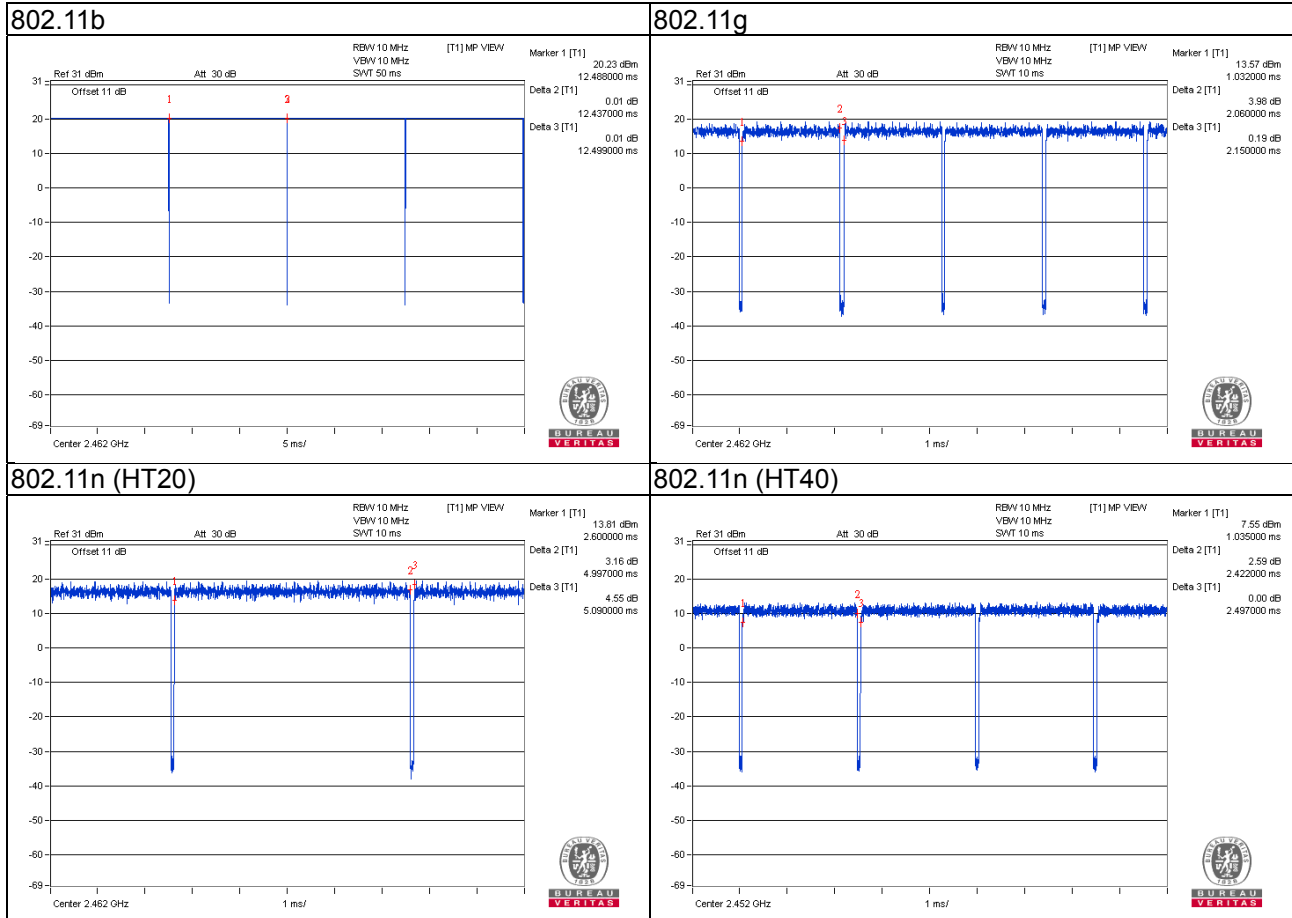

Radio 3

802.11b: Duty cycle of test signal is > 98%.

802.11g, 802.11n (HT20), 802.11n (HT40): Duty cycle of test signal is < 98%.

802.11g: Duty cycle = $13.150/13.287 = 0.990$

802.11g: Duty cycle = $2.197/2.282 = 0.963$, Duty factor = $10 * \log(1/0.963) = 0.16$

802.11n (HT20): Duty cycle = $2.043/2.148 = 0.951$, Duty factor = $10 * \log(1/0.951) = 0.22$

802.11n (HT40): Duty cycle = $0.994/1.099 = 0.904$, Duty factor = $10 * \log(1/0.904) = 0.44$

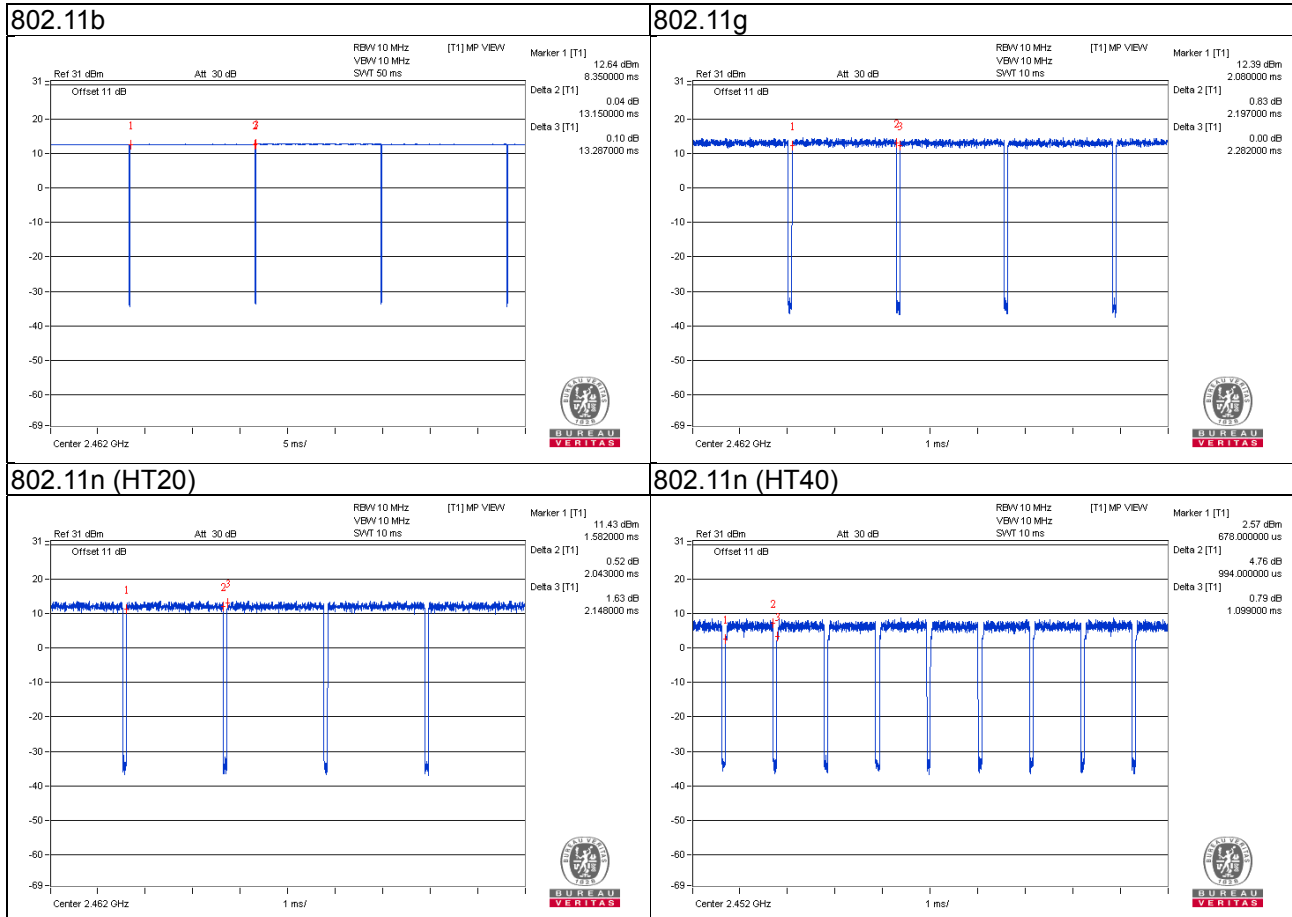

3.4 Description of Support Units

The EUT has been tested as an independent unit together with other necessary accessories or support units. The following support units or accessories were used to form a representative test configuration during the tests.

ID	Product	Brand	Model No.	Serial No.	FCC ID	Remarks
A.	Notebook	DELL	E5410	1HC2XM1	FCC DoC Approved	-
B.	Adapter	AOEM	ADS036T-W120300	N/A	N/A	Provided by manufacturer For test mode A only
C.	POE	EnGenius	EPE-48GR	N/A	N/A	Provided by manufacturer For test mode B only
D.	POE adapter	Powertron Electronics Corp.	PA1040-480IB080	N/A	N/A	Provided by manufacturer For test mode B only
E.	Load	N/A	N/A	N/A	N/A	-
F.	USB Flash	HP	v250W	01	FCC DoC Approved	-

Note:

1. All power cords of the above support units are non-shielded (1.8m).
2. Item A acted as communication partner to transfer data.

ID	Descriptions	Qty.	Length (m)	Shielding (Yes/No)	Cores (Qty.)	Remarks
1.	RJ45 Cable	1	3	N	0	Cat5e
2.	Power Cable	1	1.5	-	1	For test mode A only
3.	Power Cable	1	1.55	-	1	For test mode B only
4.	RJ45 Cable	1	1.8	N	0	Cat5e
5.	RJ45 to RS-232 Cable	1	1.8	N	0	-
6.	RJ45 Cable	1	1.8	N	0	Cat5e

Note: The core(s) is(are) originally attached to the cable(s).

3.4.1 Configuration of System under Test

Test Mode A

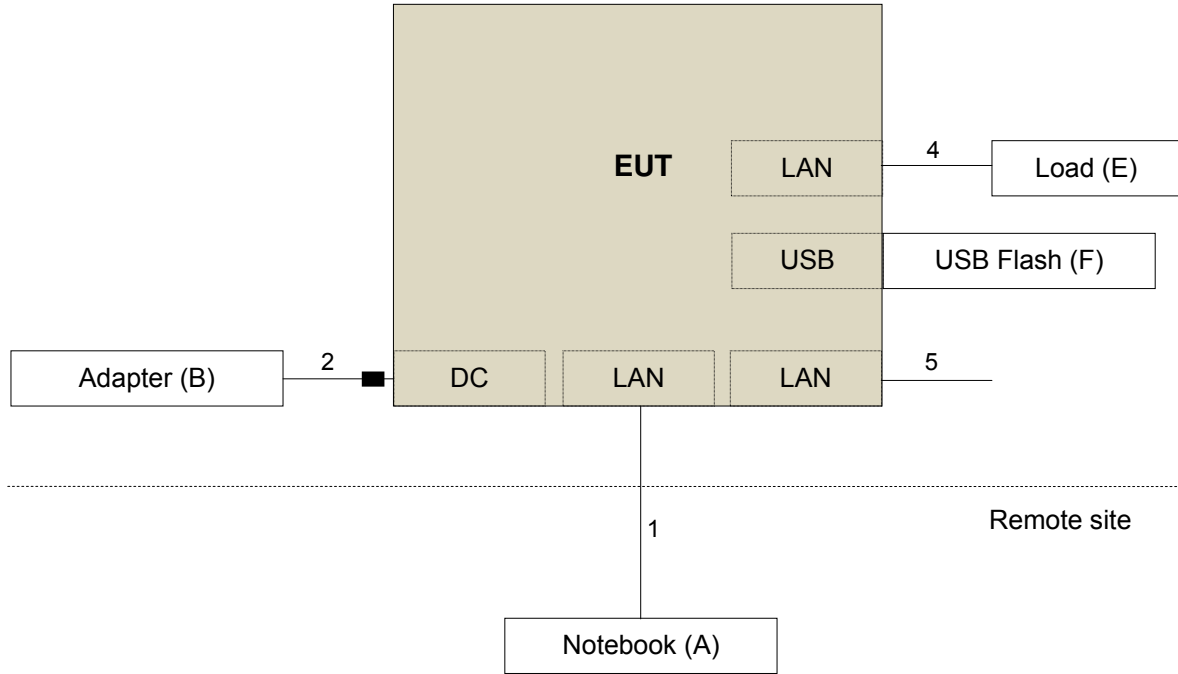

Test Mode B

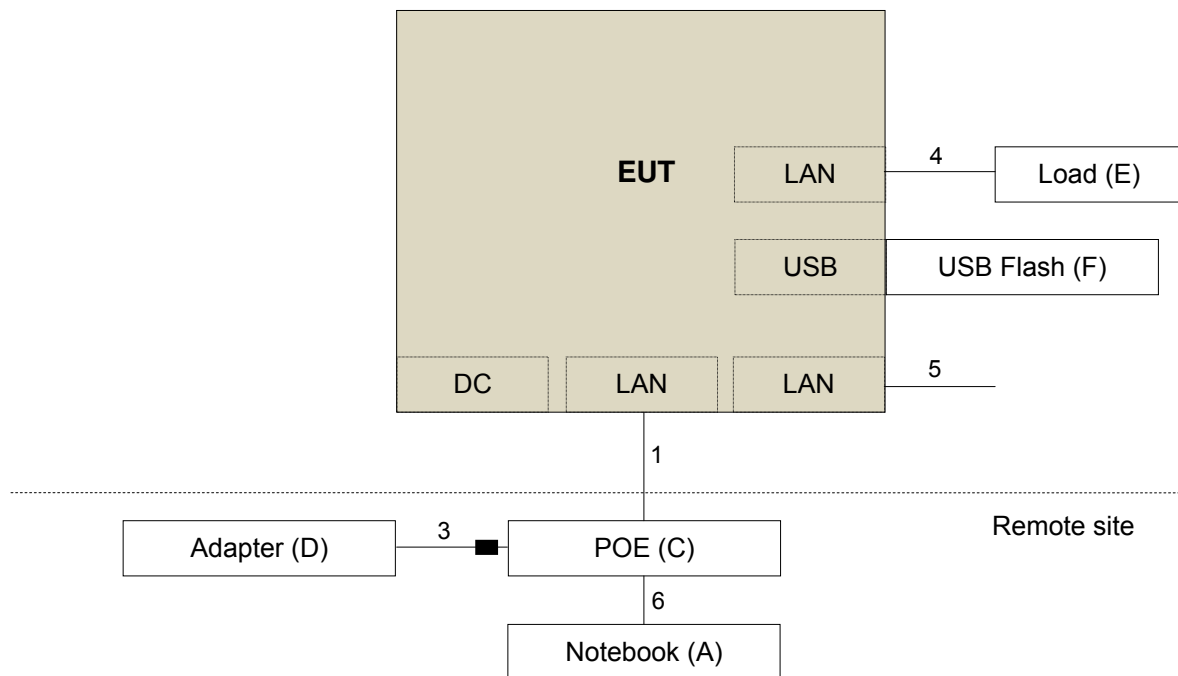

3.5 General Description of Applied Standards

The EUT is a RF Product. According to the specifications of the manufacturer, it must comply with the requirements of the following standards:

FCC Part 15, Subpart C (15.247)

KDB 558074 D01 DTS Meas Guidance v03r05

KDB 662911 D01 Multiple Transmitter Output v02r01

ANSI C63.10-2013

All test items have been performed and recorded as per the above standards.

Note: The EUT has been verified to comply with the requirements of FCC Part 15, Subpart B, Class B (DoC).
The test report has been issued separately.

4 Test Types and Results

4.1 Radiated Emission and Bandedge Measurement

4.1.1 Limits of Radiated Emission and Bandedge Measurement

Radiated emissions which fall in the restricted bands must comply with the radiated emission limits specified as below table. Other emissions shall be at least 30dB below the highest level of the desired power:

Frequencies (MHz)	Field Strength (microvolts/meter)	Measurement Distance (meters)
0.009 ~ 0.490	2400/F(kHz)	300
0.490 ~ 1.705	24000/F(kHz)	30
1.705 ~ 30.0	30	30
30 ~ 88	100	3
88 ~ 216	150	3
216 ~ 960	200	3
Above 960	500	3

Note:

1. The lower limit shall apply at the transition frequencies.
2. Emission level (dBuV/m) = 20 log Emission level (uV/m).
3. For frequencies above 1000MHz, the field strength limits are based on average detector, however, the peak field strength of any emission shall not exceed the maximum permitted average limits, specified above by more than 30dB under any condition of modulation.

4.1.2 Test Instruments

Description & Manufacturer	Model No.	Serial No.	Cal. Date	Cal. Due
Test Receiver ROHDE & SCHWARZ	ESIB7	100187	Apr. 18, 2016	Apr. 17, 2017
Spectrum Analyzer ROHDE & SCHWARZ	FSP40	100041	Sep. 02, 2015	Sep. 01, 2016
			Sep. 02, 2016	Sep. 01, 2017
BILOG Antenna SCHWARZBECK	VULB9168	9168-171	Jan. 07, 2016	Jan. 06, 2017
HORN Antenna SCHWARZBECK	9120D	209	Jan. 20, 2016	Jan. 19, 2017
HORN Antenna SCHWARZBECK	BBHA 9170	BBHA9170241	Jan. 18, 2016	Jan. 17, 2017
Loop Antenna	EM-6879	269	Aug. 11, 2015	Aug. 10, 2016
			Aug. 11, 2016	Aug. 10, 2017
Preamplifier Agilent	8447D	2944A10738	Aug. 22, 2015	Aug. 21, 2016
			Aug. 22, 2016	Aug. 21, 2017
Preamplifier Agilent	8449B	3008A01964	Aug. 22, 2015	Aug. 21, 2016
			Aug. 22, 2016	Aug. 21, 2017
RF signal cable HUBER+SUHNER	SUCOFLEX 104	Cable-CH3-03 (214378)	Aug. 22, 2015	Aug. 21, 2016
			Aug. 22, 2016	Aug. 21, 2017
RF signal cable HUBER+SUHNER	SUCOFLEX 106	Cable-CH3-03 (309224+12738)	Aug. 22, 2015	Aug. 21, 2016
			Aug. 22, 2016	Aug. 21, 2017
Software BV ADT	ADT_Radiated_ V7.6.15.9.4	NA	NA	NA
Antenna Tower inn-co GmbH	MA 4000	013303	NA	NA
Antenna Tower Controller BV ADT	AT100	AT93021702	NA	NA
Turn Table BV ADT	TT100	TT93021702	NA	NA
Turn Table Controller BV ADT	SC100	SC93021702	NA	NA
High Speed Peak Power Meter	ML2495A	0824011	Jul. 09, 2016	Jul. 08, 2017
Power Sensor	MA2411B	0738171	Aug. 11, 2015	Aug. 10, 2016
			Aug. 11, 2016	Aug. 10, 2017

- Note: 1. The calibration interval of the above test instruments is 12 months and the calibrations are traceable to NML/ROC and NIST/USA.
2. The test was performed in HwaYa Chamber 3.
3. The horn antenna and preamplifier (model: 8449B) are used only for the measurement of emission frequency above 1GHz if tested.
4. The FCC Site Registration No. is 988962.
5. The IC Site Registration No. is IC 7450F-3.

4.1.3 Test Procedures

For Radiated emission below 30MHz

- a. The EUT was placed on the top of a rotating table 0.8 meters above the ground at a 3 meter chamber room. The table was rotated 360 degrees to determine the position of the highest radiation.
- b. The EUT was set 3 meters away from the interference-receiving antenna, which was mounted on the top of a variable-height antenna tower.
- c. Both X and Y axes of the antenna are set to make the measurement.
- d. For each suspected emission, the EUT was arranged to its worst case and the rotatable table was turned from 0 degrees to 360 degrees to find the maximum reading.
- e. The test-receiver system was set to Quasi-Peak Detect Function and Specified Bandwidth with Maximum Hold Mode.

Note:

1. The resolution bandwidth and video bandwidth of test receiver/spectrum analyzer is 9kHz at frequency below 30MHz.

For Radiated emission above 30MHz

- a. The EUT was placed on the top of a rotating table 0.8 meters (for 30MHz ~ 1GHz) / 1.5 meters (for above 1GHz) above the ground at 3 meter chamber room for test. The table was rotated 360 degrees to determine the position of the highest radiation.
- b. The EUT was set 3 meters away from the interference-receiving antenna, which was mounted on the top of a variable-height antenna tower.
- c. The height of antenna is varied from one meter to four meters above the ground to determine the maximum value of the field strength. Both horizontal and vertical polarizations of the antenna are set to make the measurement.
- d. For each suspected emission, the EUT was arranged to its worst case and then the antenna was tuned to heights from 1 meter to 4 meters and the rotatable table was turned from 0 degrees to 360 degrees to find the maximum reading.
- e. The test-receiver system was set to quasi-peak detect function and specified bandwidth with maximum hold mode when the test frequency is below 1 GHz.
- f. The test-receiver system was set to peak and average detect function and specified bandwidth with maximum hold mode when the test frequency is above 1 GHz. If the peak reading value also meets average limit, measurement with the average detector is unnecessary.

Note:

1. The resolution bandwidth and video bandwidth of test receiver/spectrum analyzer is 120kHz for Quasi-peak detection (QP) at frequency below 1GHz.
2. The resolution bandwidth of test receiver/spectrum analyzer is 1 MHz and the video bandwidth is 3 MHz for Peak detection (PK) at frequency above 1GHz.
3. The resolution bandwidth of test receiver/spectrum analyzer is 1MHz and the video bandwidth is $\geq 1/T$ (Duty cycle < 98%) or 10Hz (Duty cycle $\geq 98\%$) for Average detection (AV) at frequency above 1GHz.
4. All modes of operation were investigated and the worst-case emissions are reported.

4.1.4 Deviation from Test Standard

No deviation.

4.1.5 Test Set Up

For Radiated emission below 30MHz

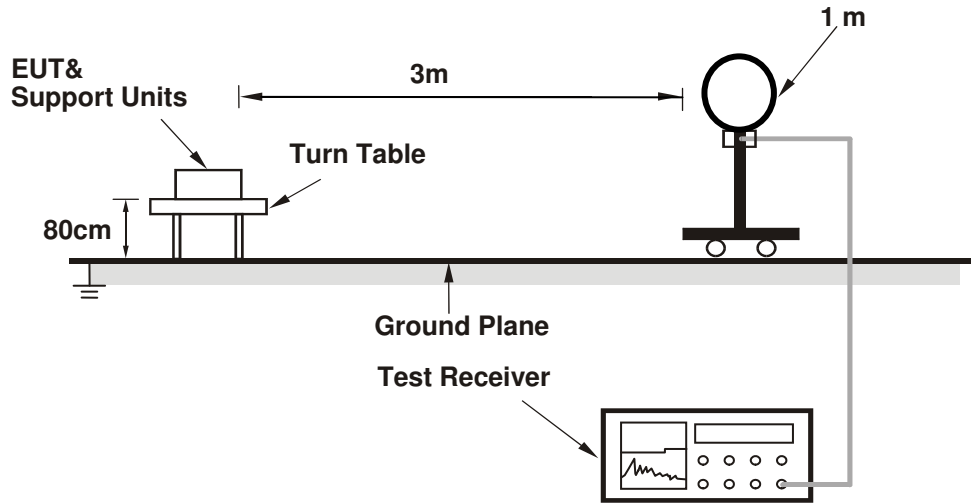

For Radiated emission 30MHz to 1GHz

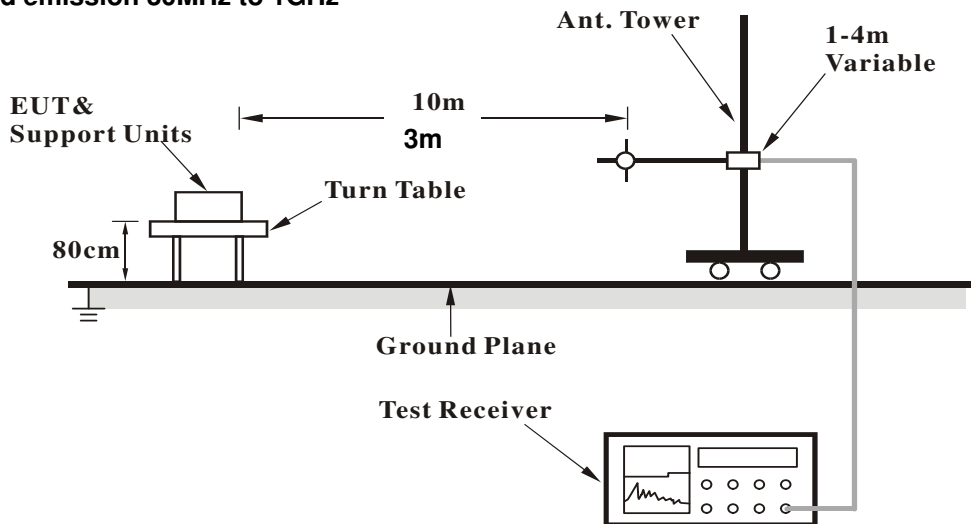

For Radiated emission above 1GHz

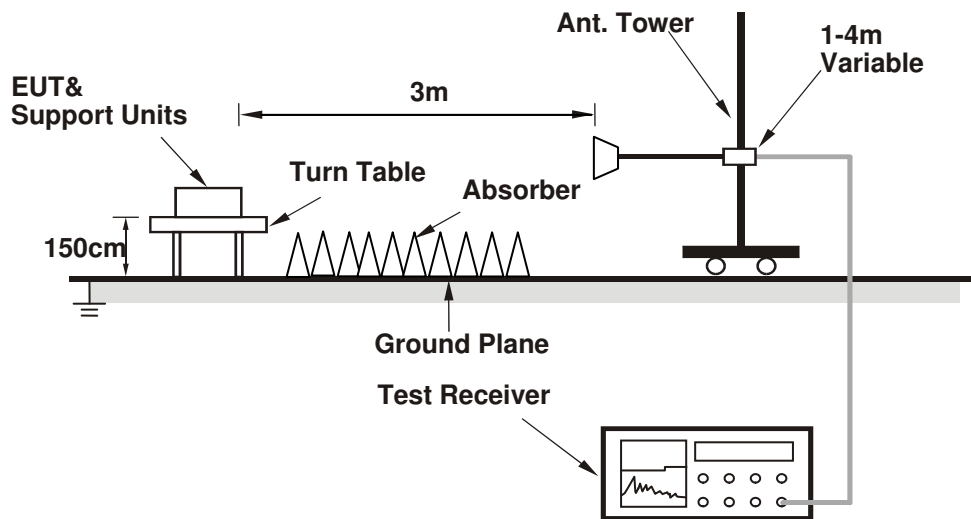

For the actual test configuration, please refer to the attached file (Test Setup Photo).

4.1.6 EUT Operating Conditions

- Placed the EUT on the testing table.
- Prepared a notebook to act as a communication partner and placed it outside of testing area.
- The communication partner connected with EUT via a RJ45 cable and ran a test program (provided by manufacturer) to enable EUT under transmission condition continuously at specific channel frequency.
- The communication partner sent data to EUT by command "PING".

4.1.7 Test Results

Above 1GHz worst-Case data:

Radio 1: CDD Mode

802.11b

CHANNEL	TX Channel 1	DETECTOR FUNCTION	Peak (PK)
FREQUENCY RANGE	1GHz ~ 25GHz		Average (AV)

ANTENNA POLARITY & TEST DISTANCE: HORIZONTAL AT 3 M								
NO.	FREQ. (MHz)	EMISSION LEVEL (dBuV/m)	LIMIT (dBuV/m)	MARGIN (dB)	ANTENNA HEIGHT (m)	TABLE ANGLE (Degree)	RAW VALUE (dBuV)	CORRECTION FACTOR (dB/m)
1	2390.00	58.1 PK	74.0	-15.9	2.34 H	3	25.3	32.8
2	2390.00	48.5 AV	54.0	-5.5	2.34 H	3	15.7	32.8
3	*2412.00	115.1 PK			1.94 H	53	82.2	32.9
4	*2412.00	111.4 AV			1.94 H	53	78.5	32.9
5	4824.00	51.7 PK	74.0	-22.3	1.94 H	279	45.8	5.9
6	4824.00	47.0 AV	54.0	-7.0	1.94 H	279	41.1	5.9
ANTENNA POLARITY & TEST DISTANCE: VERTICAL AT 3 M								
NO.	FREQ. (MHz)	EMISSION LEVEL (dBuV/m)	LIMIT (dBuV/m)	MARGIN (dB)	ANTENNA HEIGHT (m)	TABLE ANGLE (Degree)	RAW VALUE (dBuV)	CORRECTION FACTOR (dB/m)
1	2390.00	56.3 PK	74.0	-17.7	1.96 V	256	23.5	32.8
2	2390.00	45.4 AV	54.0	-8.6	1.96 V	256	12.6	32.8
3	*2412.00	114.1 PK			2.55 V	326	81.2	32.9
4	*2412.00	110.3 AV			2.55 V	326	77.4	32.9
5	4824.00	49.0 PK	74.0	-25.0	2.19 V	302	43.1	5.9
6	4824.00	39.5 AV	54.0	-14.5	2.19 V	302	33.6	5.9

Remarks:

1. Emission Level(dBuV/m) = Raw Value(dBuV) + Correction Factor(dB/m)
2. Correction Factor(dB/m) = Antenna Factor(dB/m) + Cable Factor(dB)
3. The other emission levels were very low against the limit.
4. Margin value = Emission Level – Limit value
5. " * ": Fundamental frequency.

CHANNEL	TX Channel 6	DETECTOR FUNCTION	Peak (PK)
FREQUENCY RANGE	1GHz ~ 25GHz		Average (AV)

ANTENNA POLARITY & TEST DISTANCE: HORIZONTAL AT 3 M

NO.	FREQ. (MHz)	EMISSION LEVEL (dBuV/m)	LIMIT (dBuV/m)	MARGIN (dB)	ANTENNA HEIGHT (m)	TABLE ANGLE (Degree)	RAW VALUE (dBuV)	CORRECTION FACTOR (dB/m)
1	*2437.00	116.1 PK			2.33 H	285	83.2	32.9
2	*2437.00	112.2 AV			2.33 H	285	79.3	32.9
3	4874.00	55.6 PK	74.0	-18.4	2.04 H	284	49.6	6.0
4	4874.00	52.4 AV	54.0	-1.6	2.04 H	284	46.4	6.0

ANTENNA POLARITY & TEST DISTANCE: VERTICAL AT 3 M

NO.	FREQ. (MHz)	EMISSION LEVEL (dBuV/m)	LIMIT (dBuV/m)	MARGIN (dB)	ANTENNA HEIGHT (m)	TABLE ANGLE (Degree)	RAW VALUE (dBuV)	CORRECTION FACTOR (dB/m)
1	*2437.00	114.9 PK			2.48 V	353	82.0	32.9
2	*2437.00	111.2 AV			2.48 V	353	78.3	32.9
3	4874.00	48.7 PK	74.0	-25.3	1.95 V	356	42.7	6.0
4	4874.00	39.4 AV	54.0	-14.6	1.95 V	356	33.4	6.0

Remarks:

1. Emission Level(dBuV/m) = Raw Value(dBuV) + Correction Factor(dB/m)
2. Correction Factor(dB/m) = Antenna Factor(dB/m) + Cable Factor(dB)
3. The other emission levels were very low against the limit.
4. Margin value = Emission Level – Limit value
5. " * ": Fundamental frequency.

CHANNEL	TX Channel 11	DETECTOR FUNCTION	Peak (PK)
FREQUENCY RANGE	1GHz ~ 25GHz		Average (AV)

ANTENNA POLARITY & TEST DISTANCE: HORIZONTAL AT 3 M								
NO.	FREQ. (MHz)	EMISSION LEVEL (dBuV/m)	LIMIT (dBuV/m)	MARGIN (dB)	ANTENNA HEIGHT (m)	TABLE ANGLE (Degree)	RAW VALUE (dBuV)	CORRECTION FACTOR (dB/m)
1	*2462.00	115.8 PK			2.71 H	27	82.9	32.9
2	*2462.00	112.1 AV			2.71 H	27	79.2	32.9
3	2483.50	61.0 PK	74.0	-13.0	2.41 H	303	28.0	33.0
4	2483.50	52.8 AV	54.0	-1.2	2.41 H	303	19.8	33.0
5	4924.00	56.1 PK	74.0	-17.9	2.34 H	341	50.1	6.0
6	4924.00	52.7 AV	54.0	-1.3	2.34 H	341	46.7	6.0

ANTENNA POLARITY & TEST DISTANCE: VERTICAL AT 3 M								
NO.	FREQ. (MHz)	EMISSION LEVEL (dBuV/m)	LIMIT (dBuV/m)	MARGIN (dB)	ANTENNA HEIGHT (m)	TABLE ANGLE (Degree)	RAW VALUE (dBuV)	CORRECTION FACTOR (dB/m)
1	*2462.00	114.8 PK			2.67 V	15	81.9	32.9
2	*2462.00	110.9 AV			2.67 V	15	78.0	32.9
3	2483.50	60.5 PK	74.0	-13.5	2.88 V	10	27.5	33.0
4	2483.50	48.6 AV	54.0	-5.4	2.88 V	10	15.6	33.0
5	4924.00	49.2 PK	74.0	-24.8	2.65 V	18	43.2	6.0
6	4924.00	42.5 AV	54.0	-11.5	2.65 V	18	36.5	6.0

Remarks:

1. Emission Level(dBuV/m) = Raw Value(dBuV) + Correction Factor(dB/m)
2. Correction Factor(dB/m) = Antenna Factor(dB/m) + Cable Factor(dB)
3. The other emission levels were very low against the limit.
4. Margin value = Emission Level – Limit value
5. " * ": Fundamental frequency.

802.11g

CHANNEL	TX Channel 1	DETECTOR FUNCTION	Peak (PK)
FREQUENCY RANGE	1GHz ~ 25GHz		Average (AV)

ANTENNA POLARITY & TEST DISTANCE: HORIZONTAL AT 3 M

NO.	FREQ. (MHz)	EMISSION LEVEL (dBuV/m)	LIMIT (dBuV/m)	MARGIN (dB)	ANTENNA HEIGHT (m)	TABLE ANGLE (Degree)	RAW VALUE (dBuV)	CORRECTION FACTOR (dB/m)
1	2390.00	67.0 PK	74.0	-7.0	2.11 H	301	34.2	32.8
2	2390.00	52.7 AV	54.0	-1.3	2.11 H	301	19.9	32.8
3	*2412.00	114.0 PK			1.78 H	38	81.1	32.9
4	*2412.00	103.3 AV			1.78 H	38	70.4	32.9
5	4824.00	47.6 PK	74.0	-26.4	1.83 H	281	41.7	5.9
6	4824.00	35.5 AV	54.0	-18.5	1.83 H	281	29.6	5.9

ANTENNA POLARITY & TEST DISTANCE: VERTICAL AT 3 M

NO.	FREQ. (MHz)	EMISSION LEVEL (dBuV/m)	LIMIT (dBuV/m)	MARGIN (dB)	ANTENNA HEIGHT (m)	TABLE ANGLE (Degree)	RAW VALUE (dBuV)	CORRECTION FACTOR (dB/m)
1	2390.00	65.7 PK	74.0	-8.3	2.50 V	316	32.9	32.8
2	2390.00	49.5 AV	54.0	-4.5	2.50 V	316	16.7	32.8
3	*2412.00	113.6 PK			2.41 V	314	80.7	32.9
4	*2412.00	102.5 AV			2.41 V	314	69.6	32.9
5	4824.00	47.1 PK	74.0	-26.9	2.12 V	147	41.2	5.9
6	4824.00	34.4 AV	54.0	-19.6	2.12 V	147	28.5	5.9

Remarks:

1. Emission Level(dBuV/m) = Raw Value(dBuV) + Correction Factor(dB/m)
2. Correction Factor(dB/m) = Antenna Factor(dB/m) + Cable Factor(dB)
3. The other emission levels were very low against the limit.
4. Margin value = Emission Level – Limit value
5. " * ": Fundamental frequency.

CHANNEL	TX Channel 6	DETECTOR FUNCTION	Peak (PK)
FREQUENCY RANGE	1GHz ~ 25GHz		Average (AV)

ANTENNA POLARITY & TEST DISTANCE: HORIZONTAL AT 3 M

NO.	FREQ. (MHz)	EMISSION LEVEL (dBuV/m)	LIMIT (dBuV/m)	MARGIN (dB)	ANTENNA HEIGHT (m)	TABLE ANGLE (Degree)	RAW VALUE (dBuV)	CORRECTION FACTOR (dB/m)
1	*2437.00	119.4 PK			1.87 H	36	86.5	32.9
2	*2437.00	108.9 AV			1.87 H	36	76.0	32.9
3	4874.00	52.4 PK	74.0	-21.6	2.00 H	343	46.4	6.0
4	4874.00	39.2 AV	54.0	-14.8	2.00 H	343	33.2	6.0

ANTENNA POLARITY & TEST DISTANCE: VERTICAL AT 3 M

NO.	FREQ. (MHz)	EMISSION LEVEL (dBuV/m)	LIMIT (dBuV/m)	MARGIN (dB)	ANTENNA HEIGHT (m)	TABLE ANGLE (Degree)	RAW VALUE (dBuV)	CORRECTION FACTOR (dB/m)
1	*2437.00	117.7 PK			2.99 V	359	84.8	32.9
2	*2437.00	107.5 AV			2.99 V	359	74.6	32.9
3	4874.00	50.0 PK	74.0	-24.0	3.01 V	32	44.0	6.0
4	4874.00	36.8 AV	54.0	-17.2	3.01 V	32	30.8	6.0

Remarks:

1. Emission Level(dBuV/m) = Raw Value(dBuV) + Correction Factor(dB/m)
2. Correction Factor(dB/m) = Antenna Factor(dB/m) + Cable Factor(dB)
3. The other emission levels were very low against the limit.
4. Margin value = Emission Level – Limit value
5. " * ": Fundamental frequency.

CHANNEL	TX Channel 11	DETECTOR FUNCTION	Peak (PK)
FREQUENCY RANGE	1GHz ~ 25GHz		Average (AV)

ANTENNA POLARITY & TEST DISTANCE: HORIZONTAL AT 3 M								
NO.	FREQ. (MHz)	EMISSION LEVEL (dBuV/m)	LIMIT (dBuV/m)	MARGIN (dB)	ANTENNA HEIGHT (m)	TABLE ANGLE (Degree)	RAW VALUE (dBuV)	CORRECTION FACTOR (dB/m)
1	*2462.00	115.0 PK			1.98 H	39	82.1	32.9
2	*2462.00	104.8 AV			1.98 H	39	71.9	32.9
3	2483.50	67.2 PK	74.0	-6.8	2.39 H	303	34.2	33.0
4	2483.50	52.6 AV	54.0	-1.4	2.39 H	303	19.6	33.0
5	4924.00	50.5 PK	74.0	-23.5	2.18 H	340	44.5	6.0
6	4924.00	37.5 AV	54.0	-16.5	2.18 H	340	31.5	6.0

ANTENNA POLARITY & TEST DISTANCE: VERTICAL AT 3 M								
NO.	FREQ. (MHz)	EMISSION LEVEL (dBuV/m)	LIMIT (dBuV/m)	MARGIN (dB)	ANTENNA HEIGHT (m)	TABLE ANGLE (Degree)	RAW VALUE (dBuV)	CORRECTION FACTOR (dB/m)
1	*2462.00	112.5 PK			2.43 V	357	79.6	32.9
2	*2462.00	101.9 AV			2.43 V	357	69.0	32.9
3	2483.50	59.4 PK	74.0	-14.6	2.59 V	4	26.4	33.0
4	2483.50	47.3 AV	54.0	-6.7	2.59 V	4	14.3	33.0
5	4924.00	46.0 PK	74.0	-28.0	2.36 V	227	40.0	6.0
6	4924.00	34.3 AV	54.0	-19.7	2.36 V	227	28.3	6.0

Remarks:

1. Emission Level(dBuV/m) = Raw Value(dBuV) + Correction Factor(dB/m)
2. Correction Factor(dB/m) = Antenna Factor(dB/m) + Cable Factor(dB)
3. The other emission levels were very low against the limit.
4. Margin value = Emission Level – Limit value
5. " * ": Fundamental frequency.

802.11n (HT20)

CHANNEL	TX Channel 1	DETECTOR FUNCTION	Peak (PK)
FREQUENCY RANGE	1GHz ~ 25GHz		Average (AV)

ANTENNA POLARITY & TEST DISTANCE: HORIZONTAL AT 3 M

NO.	FREQ. (MHz)	EMISSION LEVEL (dBuV/m)	LIMIT (dBuV/m)	MARGIN (dB)	ANTENNA HEIGHT (m)	TABLE ANGLE (Degree)	RAW VALUE (dBuV)	CORRECTION FACTOR (dB/m)
1	2390.00	66.4 PK	74.0	-7.6	2.33 H	302	33.6	32.8
2	2390.00	52.6 AV	54.0	-1.4	2.33 H	302	19.8	32.8
3	*2412.00	114.8 PK			1.57 H	37	81.9	32.9
4	*2412.00	104.2 AV			1.57 H	37	71.3	32.9
5	4824.00	47.3 PK	74.0	-26.7	2.11 H	293	41.4	5.9
6	4824.00	34.2 AV	54.0	-19.8	2.11 H	293	28.3	5.9

ANTENNA POLARITY & TEST DISTANCE: VERTICAL AT 3 M

NO.	FREQ. (MHz)	EMISSION LEVEL (dBuV/m)	LIMIT (dBuV/m)	MARGIN (dB)	ANTENNA HEIGHT (m)	TABLE ANGLE (Degree)	RAW VALUE (dBuV)	CORRECTION FACTOR (dB/m)
1	2390.00	65.7 PK	74.0	-8.3	3.50 V	8	32.9	32.8
2	2390.00	50.5 AV	54.0	-3.5	3.50 V	8	17.7	32.8
3	*2412.00	115.8 PK			3.45 V	351	82.9	32.9
4	*2412.00	105.4 AV			3.45 V	351	72.5	32.9
5	4824.00	47.6 PK	74.0	-26.4	2.58 V	175	41.7	5.9
6	4824.00	34.8 AV	54.0	-19.2	2.58 V	175	28.9	5.9

Remarks:

1. Emission Level(dBuV/m) = Raw Value(dBuV) + Correction Factor(dB/m)
2. Correction Factor(dB/m) = Antenna Factor(dB/m) + Cable Factor(dB)
3. The other emission levels were very low against the limit.
4. Margin value = Emission Level – Limit value
5. " * ": Fundamental frequency.

CHANNEL	TX Channel 6	DETECTOR FUNCTION	Peak (PK)
FREQUENCY RANGE	1GHz ~ 25GHz		Average (AV)

ANTENNA POLARITY & TEST DISTANCE: HORIZONTAL AT 3 M

NO.	FREQ. (MHz)	EMISSION LEVEL (dBuV/m)	LIMIT (dBuV/m)	MARGIN (dB)	ANTENNA HEIGHT (m)	TABLE ANGLE (Degree)	RAW VALUE (dBuV)	CORRECTION FACTOR (dB/m)
1	2390.00	63.1 PK	74.0	-10.9	1.87 H	37	30.3	32.8
2	2390.00	48.8 AV	54.0	-5.2	1.87 H	37	16.0	32.8
3	*2437.00	119.4 PK			1.84 H	39	86.5	32.9
4	*2437.00	109.5 AV			1.84 H	39	76.6	32.9
5	4874.00	56.3 PK	74.0	-17.7	1.84 H	282	50.3	6.0
6	4874.00	40.6 AV	54.0	-13.4	1.84 H	282	34.6	6.0

ANTENNA POLARITY & TEST DISTANCE: VERTICAL AT 3 M

NO.	FREQ. (MHz)	EMISSION LEVEL (dBuV/m)	LIMIT (dBuV/m)	MARGIN (dB)	ANTENNA HEIGHT (m)	TABLE ANGLE (Degree)	RAW VALUE (dBuV)	CORRECTION FACTOR (dB/m)
1	2390.00	66.3 PK	74.0	-7.7	3.46 V	353	33.5	32.8
2	2390.00	50.7 AV	54.0	-3.3	3.46 V	353	17.9	32.8
3	*2437.00	118.8 PK			3.42 V	355	85.9	32.9
4	*2437.00	107.9 AV			3.42 V	355	75.0	32.9
5	4874.00	50.6 PK	74.0	-23.4	2.15 V	305	44.6	6.0
6	4874.00	35.7 AV	54.0	-18.3	2.15 V	305	29.7	6.0

Remarks:

1. Emission Level(dBuV/m) = Raw Value(dBuV) + Correction Factor(dB/m)
2. Correction Factor(dB/m) = Antenna Factor(dB/m) + Cable Factor(dB)
3. The other emission levels were very low against the limit.
4. Margin value = Emission Level – Limit value
5. " * ": Fundamental frequency.

CHANNEL	TX Channel 11	DETECTOR FUNCTION	Peak (PK)
FREQUENCY RANGE	1GHz ~ 25GHz		Average (AV)

ANTENNA POLARITY & TEST DISTANCE: HORIZONTAL AT 3 M								
NO.	FREQ. (MHz)	EMISSION LEVEL (dBuV/m)	LIMIT (dBuV/m)	MARGIN (dB)	ANTENNA HEIGHT (m)	TABLE ANGLE (Degree)	RAW VALUE (dBuV)	CORRECTION FACTOR (dB/m)
1	*2462.00	115.6 PK			1.72 H	36	82.7	32.9
2	*2462.00	105.3 AV			1.72 H	36	72.4	32.9
3	2483.50	67.5 PK	74.0	-6.5	2.44 H	301	34.5	33.0
4	2483.50	52.2 AV	54.0	-1.8	2.44 H	301	19.2	33.0
5	4924.00	48.1 PK	74.0	-25.9	1.73 H	310	42.1	6.0
6	4924.00	36.0 AV	54.0	-18.0	1.73 H	310	30.0	6.0

ANTENNA POLARITY & TEST DISTANCE: VERTICAL AT 3 M								
NO.	FREQ. (MHz)	EMISSION LEVEL (dBuV/m)	LIMIT (dBuV/m)	MARGIN (dB)	ANTENNA HEIGHT (m)	TABLE ANGLE (Degree)	RAW VALUE (dBuV)	CORRECTION FACTOR (dB/m)
1	*2462.00	114.6 PK			2.91 V	349	81.7	32.9
2	*2462.00	103.9 AV			2.91 V	349	71.0	32.9
3	2483.50	62.2 PK	74.0	-11.8	2.86 V	320	29.2	33.0
4	2483.50	49.9 AV	54.0	-4.1	2.86 V	320	16.9	33.0
5	4924.00	47.3 PK	74.0	-26.7	2.00 V	252	41.3	6.0
6	4924.00	35.1 AV	54.0	-18.9	2.00 V	252	29.1	6.0

Remarks:

1. Emission Level(dBuV/m) = Raw Value(dBuV) + Correction Factor(dB/m)
2. Correction Factor(dB/m) = Antenna Factor(dB/m) + Cable Factor(dB)
3. The other emission levels were very low against the limit.
4. Margin value = Emission Level – Limit value
5. " * ": Fundamental frequency.

802.11n (HT40)

CHANNEL	TX Channel 3	DETECTOR FUNCTION	Peak (PK)
FREQUENCY RANGE	1GHz ~ 25GHz		Average (AV)

ANTENNA POLARITY & TEST DISTANCE: HORIZONTAL AT 3 M

NO.	FREQ. (MHz)	EMISSION LEVEL (dBuV/m)	LIMIT (dBuV/m)	MARGIN (dB)	ANTENNA HEIGHT (m)	TABLE ANGLE (Degree)	RAW VALUE (dBuV)	CORRECTION FACTOR (dB/m)
1	2390.00	66.5 PK	74.0	-7.5	3.14 H	307	33.7	32.8
2	2390.00	52.6 AV	54.0	-1.4	3.14 H	307	19.8	32.8
3	*2422.00	109.4 PK			1.90 H	39	76.5	32.9
4	*2422.00	99.5 AV			1.90 H	39	66.6	32.9
5	4844.00	46.7 PK	74.0	-27.3	2.28 H	145	40.9	5.8
6	4844.00	33.5 AV	54.0	-20.5	2.28 H	145	27.7	5.8

ANTENNA POLARITY & TEST DISTANCE: VERTICAL AT 3 M

NO.	FREQ. (MHz)	EMISSION LEVEL (dBuV/m)	LIMIT (dBuV/m)	MARGIN (dB)	ANTENNA HEIGHT (m)	TABLE ANGLE (Degree)	RAW VALUE (dBuV)	CORRECTION FACTOR (dB/m)
1	2390.00	61.7 PK	74.0	-12.3	2.80 V	327	28.9	32.8
2	2390.00	47.7 AV	54.0	-6.3	2.80 V	327	14.9	32.8
3	*2422.00	106.3 PK			2.40 V	313	73.4	32.9
4	*2422.00	96.6 AV			2.40 V	313	63.7	32.9
5	4844.00	46.1 PK	74.0	-27.9	2.41 V	195	40.3	5.8
6	4844.00	33.5 AV	54.0	-20.5	2.41 V	195	27.7	5.8

Remarks:

1. Emission Level(dBuV/m) = Raw Value(dBuV) + Correction Factor(dB/m)
2. Correction Factor(dB/m) = Antenna Factor(dB/m) + Cable Factor(dB)
3. The other emission levels were very low against the limit.
4. Margin value = Emission Level – Limit value
5. " * ": Fundamental frequency.

CHANNEL	TX Channel 6	DETECTOR FUNCTION	Peak (PK)
FREQUENCY RANGE	1GHz ~ 25GHz		Average (AV)

ANTENNA POLARITY & TEST DISTANCE: HORIZONTAL AT 3 M								
NO.	FREQ. (MHz)	EMISSION LEVEL (dBuV/m)	LIMIT (dBuV/m)	MARGIN (dB)	ANTENNA HEIGHT (m)	TABLE ANGLE (Degree)	RAW VALUE (dBuV)	CORRECTION FACTOR (dB/m)
1	2390.00	65.5 PK	74.0	-8.5	1.31 H	28	32.7	32.8
2	2390.00	52.5 AV	54.0	-1.5	1.31 H	28	19.7	32.8
3	*2437.00	112.2 PK			1.85 H	38	79.3	32.9
4	*2437.00	102.0 AV			1.85 H	38	69.1	32.9
5	2483.50	64.9 PK	74.0	-9.1	1.86 H	333	31.9	33.0
6	2483.50	51.7 AV	54.0	-2.3	1.86 H	333	18.7	33.0
7	4874.00	47.1 PK	74.0	-26.9	2.03 H	283	41.1	6.0
8	4874.00	35.9 AV	54.0	-18.1	2.03 H	283	29.9	6.0

ANTENNA POLARITY & TEST DISTANCE: VERTICAL AT 3 M								
NO.	FREQ. (MHz)	EMISSION LEVEL (dBuV/m)	LIMIT (dBuV/m)	MARGIN (dB)	ANTENNA HEIGHT (m)	TABLE ANGLE (Degree)	RAW VALUE (dBuV)	CORRECTION FACTOR (dB/m)
1	2390.00	64.3 PK	74.0	-9.7	3.10 V	352	31.5	32.8
2	2390.00	49.2 AV	54.0	-4.8	3.10 V	352	16.4	32.8
3	*2437.00	109.9 PK			2.40 V	316	77.0	32.9
4	*2437.00	100.4 AV			2.40 V	316	67.5	32.9
5	2483.50	64.2 PK	74.0	-9.8	3.07 V	309	31.2	33.0
6	2483.50	50.4 AV	54.0	-3.6	3.07 V	309	17.4	33.0
7	4874.00	47.5 PK	74.0	-26.5	2.71 V	201	41.5	6.0
8	4874.00	33.9 AV	54.0	-20.1	2.71 V	201	27.9	6.0

Remarks:

1. Emission Level(dBuV/m) = Raw Value(dBuV) + Correction Factor(dB/m)
2. Correction Factor(dB/m) = Antenna Factor(dB/m) + Cable Factor(dB)
3. The other emission levels were very low against the limit.
4. Margin value = Emission Level – Limit value
5. " * ": Fundamental frequency.

CHANNEL	TX Channel 9	DETECTOR FUNCTION	Peak (PK)
FREQUENCY RANGE	1GHz ~ 25GHz		Average (AV)

ANTENNA POLARITY & TEST DISTANCE: HORIZONTAL AT 3 M								
NO.	FREQ. (MHz)	EMISSION LEVEL (dBuV/m)	LIMIT (dBuV/m)	MARGIN (dB)	ANTENNA HEIGHT (m)	TABLE ANGLE (Degree)	RAW VALUE (dBuV)	CORRECTION FACTOR (dB/m)
1	*2452.00	110.6 PK			1.78 H	38	77.6	33.0
2	*2452.00	101.2 AV			1.78 H	38	68.2	33.0
3	2483.50	67.5 PK	74.0	-6.5	1.79 H	40	34.5	33.0
4	2483.50	52.5 AV	54.0	-1.5	1.79 H	40	19.5	33.0
5	4904.00	46.8 PK	74.0	-27.2	1.86 H	180	40.9	5.9
6	4904.00	34.6 AV	54.0	-19.4	1.86 H	180	28.7	5.9
ANTENNA POLARITY & TEST DISTANCE: VERTICAL AT 3 M								
NO.	FREQ. (MHz)	EMISSION LEVEL (dBuV/m)	LIMIT (dBuV/m)	MARGIN (dB)	ANTENNA HEIGHT (m)	TABLE ANGLE (Degree)	RAW VALUE (dBuV)	CORRECTION FACTOR (dB/m)
1	*2452.00	107.5 PK			2.46 V	357	74.5	33.0
2	*2452.00	98.1 AV			2.46 V	357	65.1	33.0
3	2483.50	66.6 PK	74.0	-7.4	1.89 V	353	33.6	33.0
4	2483.50	50.5 AV	54.0	-3.5	1.89 V	353	17.5	33.0
5	4904.00	46.6 PK	74.0	-27.4	1.96 V	279	40.7	5.9
6	4904.00	34.3 AV	54.0	-19.7	1.96 V	279	28.4	5.9

Remarks:

1. Emission Level(dBuV/m) = Raw Value(dBuV) + Correction Factor(dB/m)
2. Correction Factor(dB/m) = Antenna Factor(dB/m) + Cable Factor(dB)
3. The other emission levels were very low against the limit.
4. Margin value = Emission Level – Limit value
5. " * ": Fundamental frequency.

Radio 3: CDD Mode

802.11b

CHANNEL	TX Channel 1	DETECTOR FUNCTION	Peak (PK)
FREQUENCY RANGE	1GHz ~ 25GHz		Average (AV)

ANTENNA POLARITY & TEST DISTANCE: HORIZONTAL AT 3 M								
NO.	FREQ. (MHz)	EMISSION LEVEL (dBuV/m)	LIMIT (dBuV/m)	MARGIN (dB)	ANTENNA HEIGHT (m)	TABLE ANGLE (Degree)	RAW VALUE (dBuV)	CORRECTION FACTOR (dB/m)
1	2390.00	58.7 PK	74.0	-15.3	2.19 H	45	25.9	32.8
2	2390.00	47.5 AV	54.0	-6.5	2.19 H	45	14.7	32.8
3	*2412.00	101.5 PK			2.13 H	38	68.6	32.9
4	*2412.00	97.9 AV			2.13 H	38	65.0	32.9
5	4824.00	56.3 PK	74.0	-17.7	1.35 H	39	50.4	5.9
6	4824.00	52.4 AV	54.0	-1.6	1.35 H	39	46.5	5.9
ANTENNA POLARITY & TEST DISTANCE: VERTICAL AT 3 M								
NO.	FREQ. (MHz)	EMISSION LEVEL (dBuV/m)	LIMIT (dBuV/m)	MARGIN (dB)	ANTENNA HEIGHT (m)	TABLE ANGLE (Degree)	RAW VALUE (dBuV)	CORRECTION FACTOR (dB/m)
1	2390.00	58.6 PK	74.0	-15.4	2.88 V	22	25.8	32.8
2	2390.00	46.3 AV	54.0	-7.7	2.88 V	22	13.5	32.8
3	*2412.00	94.9 PK			2.86 V	24	62.0	32.9
4	*2412.00	91.1 AV			2.86 V	24	58.2	32.9
5	4824.00	57.7 PK	74.0	-16.3	2.54 V	321	51.8	5.9
6	4824.00	52.6 AV	54.0	-1.4	2.54 V	321	46.7	5.9

Remarks:

1. Emission Level(dBuV/m) = Raw Value(dBuV) + Correction Factor(dB/m)
2. Correction Factor(dB/m) = Antenna Factor(dB/m) + Cable Factor(dB)
3. The other emission levels were very low against the limit.
4. Margin value = Emission Level – Limit value
5. " * ": Fundamental frequency.

CHANNEL	TX Channel 6	DETECTOR FUNCTION	Peak (PK)
FREQUENCY RANGE	1GHz ~ 25GHz		Average (AV)

ANTENNA POLARITY & TEST DISTANCE: HORIZONTAL AT 3 M

NO.	FREQ. (MHz)	EMISSION LEVEL (dBuV/m)	LIMIT (dBuV/m)	MARGIN (dB)	ANTENNA HEIGHT (m)	TABLE ANGLE (Degree)	RAW VALUE (dBuV)	CORRECTION FACTOR (dB/m)
1	*2437.00	101.1 PK			2.31 H	33	68.2	32.9
2	*2437.00	96.7 AV			2.31 H	33	63.8	32.9
3	4874.00	57.6 PK	74.0	-16.4	1.39 H	42	51.6	6.0
4	4874.00	52.6 AV	54.0	-1.4	1.39 H	42	46.6	6.0

ANTENNA POLARITY & TEST DISTANCE: VERTICAL AT 3 M

NO.	FREQ. (MHz)	EMISSION LEVEL (dBuV/m)	LIMIT (dBuV/m)	MARGIN (dB)	ANTENNA HEIGHT (m)	TABLE ANGLE (Degree)	RAW VALUE (dBuV)	CORRECTION FACTOR (dB/m)
1	*2437.00	95.9 PK			2.96 V	16	63.0	32.9
2	*2437.00	91.7 AV			2.96 V	16	58.8	32.9
3	4874.00	57.2 PK	74.0	-16.8	2.36 V	318	51.2	6.0
4	4874.00	52.3 AV	54.0	-1.7	2.36 V	318	46.3	6.0

Remarks:

1. Emission Level(dBuV/m) = Raw Value(dBuV) + Correction Factor(dB/m)
2. Correction Factor(dB/m) = Antenna Factor(dB/m) + Cable Factor(dB)
3. The other emission levels were very low against the limit.
4. Margin value = Emission Level – Limit value
5. " * ": Fundamental frequency.

CHANNEL	TX Channel 11	DETECTOR FUNCTION	Peak (PK)
FREQUENCY RANGE	1GHz ~ 25GHz		Average (AV)

ANTENNA POLARITY & TEST DISTANCE: HORIZONTAL AT 3 M								
NO.	FREQ. (MHz)	EMISSION LEVEL (dBuV/m)	LIMIT (dBuV/m)	MARGIN (dB)	ANTENNA HEIGHT (m)	TABLE ANGLE (Degree)	RAW VALUE (dBuV)	CORRECTION FACTOR (dB/m)
1	*2462.00	102.7 PK			1.82 H	37	69.8	32.9
2	*2462.00	98.3 AV			1.82 H	37	65.4	32.9
3	2483.50	58.7 PK	74.0	-15.3	1.78 H	45	25.7	33.0
4	2483.50	46.4 AV	54.0	-7.6	1.78 H	45	13.4	33.0
5	4924.00	56.2 PK	74.0	-17.8	1.57 H	39	50.2	6.0
6	4924.00	52.8 AV	54.0	-1.2	1.57 H	39	46.8	6.0
ANTENNA POLARITY & TEST DISTANCE: VERTICAL AT 3 M								
NO.	FREQ. (MHz)	EMISSION LEVEL (dBuV/m)	LIMIT (dBuV/m)	MARGIN (dB)	ANTENNA HEIGHT (m)	TABLE ANGLE (Degree)	RAW VALUE (dBuV)	CORRECTION FACTOR (dB/m)
1	*2462.00	96.6 PK			2.84 V	16	63.7	32.9
2	*2462.00	92.3 AV			2.84 V	16	59.4	32.9
3	2483.50	58.4 PK	74.0	-15.6	2.66 V	37	25.4	33.0
4	2483.50	46.1 AV	54.0	-7.9	2.66 V	37	13.1	33.0
5	4924.00	56.4 PK	74.0	-17.6	2.35 V	321	50.4	6.0
6	4924.00	51.6 AV	54.0	-2.4	2.35 V	321	45.6	6.0

Remarks:

1. Emission Level(dBuV/m) = Raw Value(dBuV) + Correction Factor(dB/m)
2. Correction Factor(dB/m) = Antenna Factor(dB/m) + Cable Factor(dB)
3. The other emission levels were very low against the limit.
4. Margin value = Emission Level – Limit value
5. " * ": Fundamental frequency.

802.11g

CHANNEL	TX Channel 1	DETECTOR FUNCTION	Peak (PK) Average (AV)
FREQUENCY RANGE	1GHz ~ 25GHz		

ANTENNA POLARITY & TEST DISTANCE: HORIZONTAL AT 3 M

NO.	FREQ. (MHz)	EMISSION LEVEL (dBuV/m)	LIMIT (dBuV/m)	MARGIN (dB)	ANTENNA HEIGHT (m)	TABLE ANGLE (Degree)	RAW VALUE (dBuV)	CORRECTION FACTOR (dB/m)
1	2390.00	68.5 PK	74.0	-5.5	2.68 H	37	35.7	32.8
2	2390.00	52.6 AV	54.0	-1.4	2.68 H	37	19.8	32.8
3	*2412.00	101.2 PK			2.56 H	37	68.3	32.9
4	*2412.00	90.7 AV			2.56 H	37	57.8	32.9
5	4824.00	54.0 PK	74.0	-20.0	1.23 H	38	48.1	5.9
6	4824.00	40.6 AV	54.0	-13.4	1.23 H	38	34.7	5.9

ANTENNA POLARITY & TEST DISTANCE: VERTICAL AT 3 M

NO.	FREQ. (MHz)	EMISSION LEVEL (dBuV/m)	LIMIT (dBuV/m)	MARGIN (dB)	ANTENNA HEIGHT (m)	TABLE ANGLE (Degree)	RAW VALUE (dBuV)	CORRECTION FACTOR (dB/m)
1	2390.00	57.8 PK	74.0	-16.2	1.35 V	340	25.0	32.8
2	2390.00	46.2 AV	54.0	-7.8	1.35 V	340	13.4	32.8
3	*2412.00	94.1 PK			1.37 V	346	61.2	32.9
4	*2412.00	83.5 AV			1.37 V	346	50.6	32.9
5	4824.00	55.6 PK	74.0	-18.4	2.66 V	319	49.7	5.9
6	4824.00	40.9 AV	54.0	-13.1	2.66 V	319	35.0	5.9

Remarks:

1. Emission Level(dBuV/m) = Raw Value(dBuV) + Correction Factor(dB/m)
2. Correction Factor(dB/m) = Antenna Factor(dB/m) + Cable Factor(dB)
3. The other emission levels were very low against the limit.
4. Margin value = Emission Level – Limit value
5. " * ": Fundamental frequency.

CHANNEL	TX Channel 6	DETECTOR FUNCTION	Peak (PK)
FREQUENCY RANGE	1GHz ~ 25GHz		Average (AV)

ANTENNA POLARITY & TEST DISTANCE: HORIZONTAL AT 3 M

NO.	FREQ. (MHz)	EMISSION LEVEL (dBuV/m)	LIMIT (dBuV/m)	MARGIN (dB)	ANTENNA HEIGHT (m)	TABLE ANGLE (Degree)	RAW VALUE (dBuV)	CORRECTION FACTOR (dB/m)
1	*2437.00	106.6 PK			1.64 H	34	73.7	32.9
2	*2437.00	95.6 AV			1.64 H	34	62.7	32.9
3	4874.00	66.6 PK	74.0	-7.4	1.36 H	40	60.6	6.0
4	4874.00	52.6 AV	54.0	-1.4	1.36 H	40	46.6	6.0

ANTENNA POLARITY & TEST DISTANCE: VERTICAL AT 3 M

NO.	FREQ. (MHz)	EMISSION LEVEL (dBuV/m)	LIMIT (dBuV/m)	MARGIN (dB)	ANTENNA HEIGHT (m)	TABLE ANGLE (Degree)	RAW VALUE (dBuV)	CORRECTION FACTOR (dB/m)
1	*2437.00	97.9 PK			2.64 V	19	65.0	32.9
2	*2437.00	88.2 AV			2.64 V	19	55.3	32.9
3	4874.00	62.7 PK	74.0	-11.3	1.39 V	324	56.7	6.0
4	4874.00	49.1 AV	54.0	-4.9	1.39 V	324	43.1	6.0

Remarks:

1. Emission Level(dBuV/m) = Raw Value(dBuV) + Correction Factor(dB/m)
2. Correction Factor(dB/m) = Antenna Factor(dB/m) + Cable Factor(dB)
3. The other emission levels were very low against the limit.
4. Margin value = Emission Level – Limit value
5. " * ": Fundamental frequency.

CHANNEL	TX Channel 11	DETECTOR FUNCTION	Peak (PK)
FREQUENCY RANGE	1GHz ~ 25GHz		Average (AV)

ANTENNA POLARITY & TEST DISTANCE: HORIZONTAL AT 3 M								
NO.	FREQ. (MHz)	EMISSION LEVEL (dBuV/m)	LIMIT (dBuV/m)	MARGIN (dB)	ANTENNA HEIGHT (m)	TABLE ANGLE (Degree)	RAW VALUE (dBuV)	CORRECTION FACTOR (dB/m)
1	*2462.00	104.5 PK			1.82 H	33	71.6	32.9
2	*2462.00	93.7 AV			1.82 H	33	60.8	32.9
3	2483.50	66.3 PK	74.0	-7.7	1.83 H	31	33.3	33.0
4	2483.50	52.7 AV	54.0	-1.3	1.83 H	31	19.7	33.0
5	4924.00	54.7 PK	74.0	-19.3	1.39 H	41	48.7	6.0
6	4924.00	40.8 AV	54.0	-13.2	1.39 H	41	34.8	6.0

ANTENNA POLARITY & TEST DISTANCE: VERTICAL AT 3 M								
NO.	FREQ. (MHz)	EMISSION LEVEL (dBuV/m)	LIMIT (dBuV/m)	MARGIN (dB)	ANTENNA HEIGHT (m)	TABLE ANGLE (Degree)	RAW VALUE (dBuV)	CORRECTION FACTOR (dB/m)
1	*2462.00	95.2 PK			2.64 V	19	62.3	32.9
2	*2462.00	85.3 AV			2.64 V	19	52.4	32.9
3	2483.50	60.5 PK	74.0	-13.5	2.53 V	20	27.5	33.0
4	2483.50	48.6 AV	54.0	-5.4	2.53 V	20	15.6	33.0
5	4924.00	51.9 PK	74.0	-22.1	1.57 V	325	45.9	6.0
6	4924.00	38.4 AV	54.0	-15.6	1.57 V	325	32.4	6.0

Remarks:

1. Emission Level(dBuV/m) = Raw Value(dBuV) + Correction Factor(dB/m)
2. Correction Factor(dB/m) = Antenna Factor(dB/m) + Cable Factor(dB)
3. The other emission levels were very low against the limit.
4. Margin value = Emission Level – Limit value
5. " * ": Fundamental frequency.

802.11n (HT20)

CHANNEL	TX Channel 1	DETECTOR FUNCTION	Peak (PK) Average (AV)
FREQUENCY RANGE	1GHz ~ 25GHz		

ANTENNA POLARITY & TEST DISTANCE: HORIZONTAL AT 3 M

NO.	FREQ. (MHz)	EMISSION LEVEL (dBuV/m)	LIMIT (dBuV/m)	MARGIN (dB)	ANTENNA HEIGHT (m)	TABLE ANGLE (Degree)	RAW VALUE (dBuV)	CORRECTION FACTOR (dB/m)
1	2390.00	68.2 PK	74.0	-5.8	1.90 H	36	35.4	32.8
2	2390.00	52.8 AV	54.0	-1.2	1.90 H	36	20.0	32.8
3	*2412.00	99.3 PK			2.62 H	42	66.4	32.9
4	*2412.00	89.7 AV			2.62 H	42	56.8	32.9
5	4824.00	51.0 PK	74.0	-23.0	1.33 H	54	45.1	5.9
6	4824.00	37.9 AV	54.0	-16.1	1.33 H	54	32.0	5.9

ANTENNA POLARITY & TEST DISTANCE: VERTICAL AT 3 M

NO.	FREQ. (MHz)	EMISSION LEVEL (dBuV/m)	LIMIT (dBuV/m)	MARGIN (dB)	ANTENNA HEIGHT (m)	TABLE ANGLE (Degree)	RAW VALUE (dBuV)	CORRECTION FACTOR (dB/m)
1	2390.00	61.4 PK	74.0	-12.6	2.56 V	22	28.6	32.8
2	2390.00	47.5 AV	54.0	-6.5	2.56 V	22	14.7	32.8
3	*2412.00	92.5 PK			2.66 V	17	59.6	32.9
4	*2412.00	83.1 AV			2.66 V	17	50.2	32.9
5	4824.00	51.3 PK	74.0	-22.7	2.50 V	321	45.4	5.9
6	4824.00	37.4 AV	54.0	-16.6	2.50 V	321	31.5	5.9

Remarks:

1. Emission Level(dBuV/m) = Raw Value(dBuV) + Correction Factor(dB/m)
2. Correction Factor(dB/m) = Antenna Factor(dB/m) + Cable Factor(dB)
3. The other emission levels were very low against the limit.
4. Margin value = Emission Level – Limit value
5. " * ": Fundamental frequency.

CHANNEL	TX Channel 6	DETECTOR FUNCTION	Peak (PK)
FREQUENCY RANGE	1GHz ~ 25GHz		Average (AV)

ANTENNA POLARITY & TEST DISTANCE: HORIZONTAL AT 3 M

NO.	FREQ. (MHz)	EMISSION LEVEL (dBuV/m)	LIMIT (dBuV/m)	MARGIN (dB)	ANTENNA HEIGHT (m)	TABLE ANGLE (Degree)	RAW VALUE (dBuV)	CORRECTION FACTOR (dB/m)
1	*2437.00	105.2 PK			1.63 H	31	72.3	32.9
2	*2437.00	96.0 AV			1.63 H	31	63.1	32.9
3	4874.00	66.9 PK	74.0	-7.1	1.30 H	44	60.9	6.0
4	4874.00	52.3 AV	54.0	-1.7	1.30 H	44	46.3	6.0

ANTENNA POLARITY & TEST DISTANCE: VERTICAL AT 3 M

NO.	FREQ. (MHz)	EMISSION LEVEL (dBuV/m)	LIMIT (dBuV/m)	MARGIN (dB)	ANTENNA HEIGHT (m)	TABLE ANGLE (Degree)	RAW VALUE (dBuV)	CORRECTION FACTOR (dB/m)
1	*2437.00	100.6 PK			3.22 V	26	67.7	32.9
2	*2437.00	90.6 AV			3.22 V	26	57.7	32.9
3	4874.00	68.0 PK	74.0	-6.0	2.52 V	319	62.0	6.0
4	4874.00	52.9 AV	54.0	-1.1	2.52 V	319	46.9	6.0

Remarks:

1. Emission Level(dBuV/m) = Raw Value(dBuV) + Correction Factor(dB/m)
2. Correction Factor(dB/m) = Antenna Factor(dB/m) + Cable Factor(dB)
3. The other emission levels were very low against the limit.
4. Margin value = Emission Level – Limit value
5. " * ": Fundamental frequency.

CHANNEL	TX Channel 11	DETECTOR FUNCTION	Peak (PK)
FREQUENCY RANGE	1GHz ~ 25GHz		Average (AV)

ANTENNA POLARITY & TEST DISTANCE: HORIZONTAL AT 3 M								
NO.	FREQ. (MHz)	EMISSION LEVEL (dBuV/m)	LIMIT (dBuV/m)	MARGIN (dB)	ANTENNA HEIGHT (m)	TABLE ANGLE (Degree)	RAW VALUE (dBuV)	CORRECTION FACTOR (dB/m)
1	*2462.00	100.1 PK			2.30 H	40	67.2	32.9
2	*2462.00	90.1 AV			2.30 H	40	57.2	32.9
3	2483.50	65.3 PK	74.0	-8.7	2.03 H	34	32.3	33.0
4	2483.50	52.5 AV	54.0	-1.5	2.03 H	34	19.5	33.0
5	4924.00	52.6 PK	74.0	-21.4	1.40 H	56	46.6	6.0
6	4924.00	39.6 AV	54.0	-14.4	1.40 H	56	33.6	6.0
ANTENNA POLARITY & TEST DISTANCE: VERTICAL AT 3 M								
NO.	FREQ. (MHz)	EMISSION LEVEL (dBuV/m)	LIMIT (dBuV/m)	MARGIN (dB)	ANTENNA HEIGHT (m)	TABLE ANGLE (Degree)	RAW VALUE (dBuV)	CORRECTION FACTOR (dB/m)
1	*2462.00	95.0 PK			2.63 V	27	62.1	32.9
2	*2462.00	85.5 AV			2.63 V	27	52.6	32.9
3	2483.50	60.9 PK	74.0	-13.1	2.63 V	27	27.9	33.0
4	2483.50	49.0 AV	54.0	-5.0	2.63 V	27	16.0	33.0
5	4924.00	50.7 PK	74.0	-23.3	2.56 V	315	44.7	6.0
6	4924.00	37.0 AV	54.0	-17.0	2.56 V	315	31.0	6.0

Remarks:

1. Emission Level(dBuV/m) = Raw Value(dBuV) + Correction Factor(dB/m)
2. Correction Factor(dB/m) = Antenna Factor(dB/m) + Cable Factor(dB)
3. The other emission levels were very low against the limit.
4. Margin value = Emission Level – Limit value
5. " * ": Fundamental frequency.

802.11n (HT40)

CHANNEL	TX Channel 3	DETECTOR FUNCTION	Peak (PK)
FREQUENCY RANGE	1GHz ~ 25GHz		Average (AV)

ANTENNA POLARITY & TEST DISTANCE: HORIZONTAL AT 3 M

NO.	FREQ. (MHz)	EMISSION LEVEL (dBuV/m)	LIMIT (dBuV/m)	MARGIN (dB)	ANTENNA HEIGHT (m)	TABLE ANGLE (Degree)	RAW VALUE (dBuV)	CORRECTION FACTOR (dB/m)
1	2390.00	64.4 PK	74.0	-9.6	2.28 H	35	31.6	32.8
2	2390.00	52.6 AV	54.0	-1.4	2.28 H	35	19.8	32.8
3	*2422.00	95.8 PK			2.31 H	36	62.9	32.9
4	*2422.00	85.3 AV			2.31 H	36	52.4	32.9
5	4844.00	49.2 PK	74.0	-24.8	2.07 H	269	43.4	5.8
6	4844.00	35.6 AV	54.0	-18.4	2.07 H	269	29.8	5.8

ANTENNA POLARITY & TEST DISTANCE: VERTICAL AT 3 M

NO.	FREQ. (MHz)	EMISSION LEVEL (dBuV/m)	LIMIT (dBuV/m)	MARGIN (dB)	ANTENNA HEIGHT (m)	TABLE ANGLE (Degree)	RAW VALUE (dBuV)	CORRECTION FACTOR (dB/m)
1	2390.00	59.2 PK	74.0	-14.8	2.72 V	306	26.4	32.8
2	2390.00	47.8 AV	54.0	-6.2	2.72 V	306	15.0	32.8
3	*2422.00	87.7 PK			3.68 V	312	54.8	32.9
4	*2422.00	78.3 AV			3.68 V	312	45.4	32.9
5	4844.00	46.8 PK	74.0	-27.2	2.01 V	44	41.0	5.8
6	4844.00	34.1 AV	54.0	-19.9	2.01 V	44	28.3	5.8

Remarks:

1. Emission Level(dBuV/m) = Raw Value(dBuV) + Correction Factor(dB/m)
2. Correction Factor(dB/m) = Antenna Factor(dB/m) + Cable Factor(dB)
3. The other emission levels were very low against the limit.
4. Margin value = Emission Level – Limit value
5. " * ": Fundamental frequency.

CHANNEL	TX Channel 6	DETECTOR FUNCTION	Peak (PK)
FREQUENCY RANGE	1GHz ~ 25GHz		Average (AV)

ANTENNA POLARITY & TEST DISTANCE: HORIZONTAL AT 3 M								
NO.	FREQ. (MHz)	EMISSION LEVEL (dBuV/m)	LIMIT (dBuV/m)	MARGIN (dB)	ANTENNA HEIGHT (m)	TABLE ANGLE (Degree)	RAW VALUE (dBuV)	CORRECTION FACTOR (dB/m)
1	2390.00	63.5 PK	74.0	-10.5	1.96 H	37	30.7	32.8
2	2390.00	49.7 AV	54.0	-4.3	1.96 H	37	16.9	32.8
3	*2437.00	101.2 PK			1.87 H	29	68.3	32.9
4	*2437.00	90.1 AV			1.87 H	29	57.2	32.9
5	2483.50	66.9 PK	74.0	-7.1	2.05 H	34	33.9	33.0
6	2483.50	52.7 AV	54.0	-1.3	2.05 H	34	19.7	33.0
7	4874.00	52.0 PK	74.0	-22.0	1.68 H	33	46.0	6.0
8	4874.00	39.5 AV	54.0	-14.5	1.68 H	33	33.5	6.0

ANTENNA POLARITY & TEST DISTANCE: VERTICAL AT 3 M								
NO.	FREQ. (MHz)	EMISSION LEVEL (dBuV/m)	LIMIT (dBuV/m)	MARGIN (dB)	ANTENNA HEIGHT (m)	TABLE ANGLE (Degree)	RAW VALUE (dBuV)	CORRECTION FACTOR (dB/m)
1	2390.00	58.4 PK	74.0	-15.6	2.41 V	19	25.6	32.8
2	2390.00	47.9 AV	54.0	-6.1	2.41 V	19	15.1	32.8
3	*2437.00	91.3 PK			3.62 V	342	58.4	32.9
4	*2437.00	82.0 AV			3.62 V	342	49.1	32.9
5	2483.50	59.2 PK	74.0	-14.8	3.62 V	342	26.2	33.0
6	2483.50	47.5 AV	54.0	-6.5	3.62 V	342	14.5	33.0
7	4874.00	51.0 PK	74.0	-23.0	1.69 V	228	45.0	6.0
8	4874.00	38.1 AV	54.0	-15.9	1.69 V	228	32.1	6.0

Remarks:

1. Emission Level(dBuV/m) = Raw Value(dBuV) + Correction Factor(dB/m)
2. Correction Factor(dB/m) = Antenna Factor(dB/m) + Cable Factor(dB)
3. The other emission levels were very low against the limit.
4. Margin value = Emission Level – Limit value
5. " * ": Fundamental frequency.

CHANNEL	TX Channel 9	DETECTOR FUNCTION	Peak (PK)
FREQUENCY RANGE	1GHz ~ 25GHz		Average (AV)

ANTENNA POLARITY & TEST DISTANCE: HORIZONTAL AT 3 M

NO.	FREQ. (MHz)	EMISSION LEVEL (dBuV/m)	LIMIT (dBuV/m)	MARGIN (dB)	ANTENNA HEIGHT (m)	TABLE ANGLE (Degree)	RAW VALUE (dBuV)	CORRECTION FACTOR (dB/m)
1	*2452.00	97.5 PK			1.83 H	33	64.5	33.0
2	*2452.00	86.3 AV			1.83 H	33	53.3	33.0
3	2483.50	65.0 PK	74.0	-9.0	1.38 H	35	32.0	33.0
4	2483.50	52.6 AV	54.0	-1.4	1.38 H	35	19.6	33.0
5	4904.00	48.8 PK	74.0	-25.2	2.22 H	127	42.9	5.9
6	4904.00	36.3 AV	54.0	-17.7	2.22 H	127	30.4	5.9

ANTENNA POLARITY & TEST DISTANCE: VERTICAL AT 3 M

NO.	FREQ. (MHz)	EMISSION LEVEL (dBuV/m)	LIMIT (dBuV/m)	MARGIN (dB)	ANTENNA HEIGHT (m)	TABLE ANGLE (Degree)	RAW VALUE (dBuV)	CORRECTION FACTOR (dB/m)
1	*2452.00	88.0 PK			3.62 V	357	55.0	33.0
2	*2452.00	78.8 AV			3.62 V	357	45.8	33.0
3	2483.50	59.1 PK	74.0	-14.9	3.28 V	359	26.1	33.0
4	2483.50	48.1 AV	54.0	-5.9	3.28 V	359	15.1	33.0
5	4904.00	46.8 PK	74.0	-27.2	2.56 V	333	40.9	5.9
6	4904.00	34.1 AV	54.0	-19.9	2.56 V	333	28.2	5.9

Remarks:

1. Emission Level(dBuV/m) = Raw Value(dBuV) + Correction Factor(dB/m)
2. Correction Factor(dB/m) = Antenna Factor(dB/m) + Cable Factor(dB)
3. The other emission levels were very low against the limit.
4. Margin value = Emission Level – Limit value
5. " * ": Fundamental frequency.

Below 1GHz worst-case data:

Radio 1: CDD Mode

802.11b

CHANNEL	TX Channel 1	DETECTOR FUNCTION	Quasi-Peak (QP)
FREQUENCY RANGE	9kHz ~ 1GHz		
TEST MODE	A		

ANTENNA POLARITY & TEST DISTANCE: HORIZONTAL AT 3 M								
NO.	FREQ. (MHz)	EMISSION LEVEL (dBuV/m)	LIMIT (dBuV/m)	MARGIN (dB)	ANTENNA HEIGHT (m)	TABLE ANGLE (Degree)	RAW VALUE (dBuV)	CORRECTION FACTOR (dB/m)
1	57.12	31.1 QP	40.0	-8.9	1.99 H	238	45.7	-14.6
2	119.34	32.5 QP	43.5	-11.0	1.49 H	111	48.9	-16.4
3	199.05	38.7 QP	43.5	-4.8	1.49 H	115	55.2	-16.5
4	249.60	34.6 QP	46.0	-11.4	1.00 H	9	48.6	-14.0
5	374.04	30.7 QP	46.0	-15.3	1.99 H	139	41.2	-10.5
6	500.42	30.8 QP	46.0	-15.2	1.49 H	270	38.7	-7.9

ANTENNA POLARITY & TEST DISTANCE: VERTICAL AT 3 M								
NO.	FREQ. (MHz)	EMISSION LEVEL (dBuV/m)	LIMIT (dBuV/m)	MARGIN (dB)	ANTENNA HEIGHT (m)	TABLE ANGLE (Degree)	RAW VALUE (dBuV)	CORRECTION FACTOR (dB/m)
1	45.45	36.7 QP	40.0	-3.3	1.00 V	105	51.4	-14.7
2	70.73	37.7 QP	40.0	-2.3	1.49 V	239	54.2	-16.5
3	199.05	34.7 QP	43.5	-8.8	1.00 V	342	51.2	-16.5
4	249.60	32.8 QP	46.0	-13.2	1.00 V	354	46.8	-14.0
5	374.04	30.0 QP	46.0	-16.0	1.00 V	176	40.5	-10.5
6	500.42	30.1 QP	46.0	-15.9	1.00 V	247	38.0	-7.9

Remarks:

1. Emission Level(dBuV/m) = Raw Value(dBuV) + Correction Factor(dB/m)
2. Correction Factor(dB/m) = Antenna Factor(dB/m) + Cable Factor(dB)
3. The other emission levels were very low against the limit.
4. Margin value = Emission Level – Limit value

CHANNEL	TX Channel 1	DETECTOR FUNCTION	Quasi-Peak (QP)
FREQUENCY RANGE	9kHz ~ 1GHz		
TEST MODE	B		

ANTENNA POLARITY & TEST DISTANCE: HORIZONTAL AT 3 M

NO.	FREQ. (MHz)	EMISSION LEVEL (dBuV/m)	LIMIT (dBuV/m)	MARGIN (dB)	ANTENNA HEIGHT (m)	TABLE ANGLE (Degree)	RAW VALUE (dBuV)	CORRECTION FACTOR (dB/m)
1	70.73	33.3 QP	40.0	-6.7	1.50 H	274	49.8	-16.5
2	119.34	34.1 QP	43.5	-9.4	1.99 H	122	50.5	-16.4
3	199.05	35.8 QP	43.5	-7.7	1.50 H	145	52.3	-16.5
4	249.60	35.3 QP	46.0	-10.7	1.00 H	263	49.3	-14.0
5	500.42	31.0 QP	46.0	-15.0	1.50 H	16	38.9	-7.9
6	700.68	32.7 QP	46.0	-13.3	1.00 H	148	36.3	-3.6

ANTENNA POLARITY & TEST DISTANCE: VERTICAL AT 3 M

NO.	FREQ. (MHz)	EMISSION LEVEL (dBuV/m)	LIMIT (dBuV/m)	MARGIN (dB)	ANTENNA HEIGHT (m)	TABLE ANGLE (Degree)	RAW VALUE (dBuV)	CORRECTION FACTOR (dB/m)
1	45.45	34.5 QP	40.0	-5.5	1.00 V	305	49.2	-14.7
2	55.18	35.0 QP	40.0	-5.0	1.00 V	69	49.4	-14.4
3	199.05	32.0 QP	43.5	-11.5	1.00 V	9	48.5	-16.5
4	249.60	34.3 QP	46.0	-11.7	1.00 V	223	48.3	-14.0
5	374.04	31.8 QP	46.0	-14.2	1.00 V	174	42.3	-10.5
6	500.42	32.9 QP	46.0	-13.1	1.00 V	265	40.8	-7.9

Remarks:

1. Emission Level(dBuV/m) = Raw Value(dBuV) + Correction Factor(dB/m)
2. Correction Factor(dB/m) = Antenna Factor(dB/m) + Cable Factor(dB)
3. The other emission levels were very low against the limit.
4. Margin value = Emission Level – Limit value

Radio 3: CDD Mode

802.11b

CHANNEL	TX Channel 1	DETECTOR FUNCTION	Quasi-Peak (QP)
FREQUENCY RANGE	9kHz ~ 1GHz		
TEST MODE	A		

ANTENNA POLARITY & TEST DISTANCE: HORIZONTAL AT 3 M

NO.	FREQ. (MHz)	EMISSION LEVEL (dBuV/m)	LIMIT (dBuV/m)	MARGIN (dB)	ANTENNA HEIGHT (m)	TABLE ANGLE (Degree)	RAW VALUE (dBuV)	CORRECTION FACTOR (dB/m)
1	57.12	30.1 QP	40.0	-9.9	2.00 H	235	44.7	-14.6
2	199.05	36.3 QP	43.5	-7.2	1.50 H	103	52.8	-16.5
3	249.60	36.5 QP	46.0	-9.5	1.01 H	4	50.5	-14.0
4	374.04	31.8 QP	46.0	-14.2	2.00 H	152	42.3	-10.5
5	500.42	31.7 QP	46.0	-14.3	1.50 H	246	39.6	-7.9
6	700.68	30.9 QP	46.0	-15.1	1.01 H	203	34.5	-3.6

ANTENNA POLARITY & TEST DISTANCE: VERTICAL AT 3 M

NO.	FREQ. (MHz)	EMISSION LEVEL (dBuV/m)	LIMIT (dBuV/m)	MARGIN (dB)	ANTENNA HEIGHT (m)	TABLE ANGLE (Degree)	RAW VALUE (dBuV)	CORRECTION FACTOR (dB/m)
1	45.45	36.8 QP	40.0	-3.2	1.50 V	146	51.5	-14.7
2	62.95	36.2 QP	40.0	-3.8	1.50 V	16	51.3	-15.1
3	199.05	33.3 QP	43.5	-10.2	1.00 V	12	49.8	-16.5
4	249.60	32.8 QP	46.0	-13.2	1.00 V	338	46.8	-14.0
5	374.04	30.4 QP	46.0	-15.6	1.00 V	162	40.9	-10.5
6	500.42	30.4 QP	46.0	-15.6	1.00 V	251	38.3	-7.9

Remarks:

1. Emission Level(dBuV/m) = Raw Value(dBuV) + Correction Factor(dB/m)
2. Correction Factor(dB/m) = Antenna Factor(dB/m) + Cable Factor(dB)
3. The other emission levels were very low against the limit.
4. Margin value = Emission Level – Limit value

CHANNEL	TX Channel 1	DETECTOR FUNCTION	Quasi-Peak (QP)
FREQUENCY RANGE	9kHz ~ 1GHz		
TEST MODE	B		

ANTENNA POLARITY & TEST DISTANCE: HORIZONTAL AT 3 M

NO.	FREQ. (MHz)	EMISSION LEVEL (dBuV/m)	LIMIT (dBuV/m)	MARGIN (dB)	ANTENNA HEIGHT (m)	TABLE ANGLE (Degree)	RAW VALUE (dBuV)	CORRECTION FACTOR (dB/m)
1	57.12	29.5 QP	40.0	-10.5	2.00 H	127	44.1	-14.6
2	125.17	30.0 QP	43.5	-13.5	1.50 H	294	46.1	-16.1
3	199.05	35.7 QP	43.5	-7.8	1.50 H	153	52.2	-16.5
4	249.60	34.4 QP	46.0	-11.6	1.01 H	264	48.4	-14.0
5	500.42	30.0 QP	46.0	-16.0	1.50 H	6	37.9	-7.9
6	700.68	32.3 QP	46.0	-13.7	1.01 H	147	35.9	-3.6

ANTENNA POLARITY & TEST DISTANCE: VERTICAL AT 3 M

NO.	FREQ. (MHz)	EMISSION LEVEL (dBuV/m)	LIMIT (dBuV/m)	MARGIN (dB)	ANTENNA HEIGHT (m)	TABLE ANGLE (Degree)	RAW VALUE (dBuV)	CORRECTION FACTOR (dB/m)
1	45.45	35.5 QP	40.0	-4.5	1.00 V	15	50.2	-14.7
2	55.18	34.5 QP	40.0	-5.5	1.49 V	10	48.9	-14.4
3	199.05	32.3 QP	43.5	-11.2	1.00 V	27	48.8	-16.5
4	249.60	32.7 QP	46.0	-13.3	1.00 V	234	46.7	-14.0
5	374.04	31.0 QP	46.0	-15.0	1.49 V	171	41.5	-10.5
6	500.42	33.0 QP	46.0	-13.0	1.00 V	259	40.9	-7.9

Remarks:

1. Emission Level(dBuV/m) = Raw Value(dBuV) + Correction Factor(dB/m)
2. Correction Factor(dB/m) = Antenna Factor(dB/m) + Cable Factor(dB)
3. The other emission levels were very low against the limit.
4. Margin value = Emission Level – Limit value

4.2 Conducted Emission Measurement

4.2.1 Limits of Conducted Emission Measurement

Frequency (MHz)	Conducted Limit (dBuV)	
	Quasi-peak	Average
0.15 - 0.5	66 - 56	56 - 46
0.50 - 5.0	56	46
5.0 - 30.0	60	50

- Note:** 1. The lower limit shall apply at the transition frequencies.
 2. The limit decreases in line with the logarithm of the frequency in the range of 0.15 to 0.50MHz.

4.2.2 Test Instruments

Description & Manufacturer	Model No.	Serial No.	Cal. Date	Cal. Due
Test Receiver ROHDE & SCHWARZ	ESCI	100613	Nov. 16, 2015	Nov. 15, 2016
RF signal cable (with 10dB PAD) Woken	5D-FB	Cable-cond1-01	Dec. 26, 2015	Dec. 25, 2016
LISN/AMN ROHDE & SCHWARZ (EUT)	ESH3-Z5	835239/001	Feb. 26, 2016	Feb. 25, 2017
LISN/AMN ROHDE & SCHWARZ (Peripheral)	ESH3-Z5	100220	Nov. 13, 2015	Nov. 12, 2016
Software ADT	BV ADT_Cond_ V7.3.7.3	NA	NA	NA

- Note:** 1. The calibration interval of the above test instruments is 12 months and the calibrations are traceable to NML/ROC and NIST/USA.
 2. The test was performed in HwaYa Shielded Room 1.
 3. The VCCI Site Registration No. is C-2040.

4.2.3 Test Procedures

- The EUT was placed 0.4 meters from the conducting wall of the shielded room with EUT being connected to the power mains through a line impedance stabilization network (LISN). Other support units were connected to the power mains through another LISN. The two LISNs provide 50 ohm/ 50uH of coupling impedance for the measuring instrument.
- Both lines of the power mains connected to the EUT were checked for maximum conducted interference.
- The frequency range from 150kHz to 30MHz was searched. Emission levels under (Limit - 20dB) was not recorded.

Note: The resolution bandwidth and video bandwidth of test receiver is 9kHz for quasi-peak detection (QP) and average detection (AV) at frequency 0.15MHz-30MHz.

4.2.4 Deviation from Test Standard

No deviation.

4.2.5 Test Setup

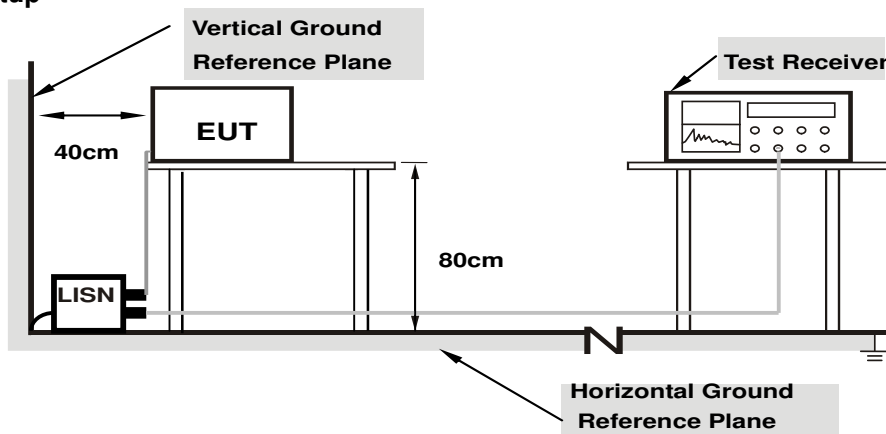

Note: 1.Support units were connected to second LISN.

For the actual test configuration, please refer to the attached file (Test Setup Photo).

4.2.6 EUT Operating Conditions

Same as 4.1.6.

4.2.7 Test Results

Radio 1: CDD Mode

Phase	Line (L)	Detector Function	Quasi-Peak (QP) / Average (AV)
Test Mode	A		

No	Freq. [MHz]	Corr. Factor (dB)	Reading Value		Emission Level		Limit		Margin	
			[dB (uV)]		[dB (uV)]		[dB (uV)]		(dB)	
			Q.P.	AV.	Q.P.	AV.	Q.P.	AV.	Q.P.	AV.
1	0.15391	10.08	38.81	21.17	48.89	31.25	65.79	55.79	-16.90	-24.54
2	0.18122	10.08	36.05	21.08	46.13	31.16	64.43	54.43	-18.30	-23.27
3	0.29076	10.12	35.23	26.35	45.35	36.47	60.50	50.50	-15.15	-14.03
4	0.32187	10.13	31.28	19.29	41.41	29.42	59.66	49.66	-18.25	-20.24
5	0.51856	10.19	32.35	26.12	42.54	36.31	56.00	46.00	-13.46	-9.69
6	15.86429	11.13	21.77	17.12	32.90	28.25	60.00	50.00	-27.10	-21.75

Remarks:

1. Q.P. and AV. are abbreviations of quasi-peak and average individually.
2. The emission levels of other frequencies were very low against the limit.
3. Margin value = Emission level - Limit value
4. Correction factor = Insertion loss + Cable loss
5. Emission Level = Correction Factor + Reading Value.

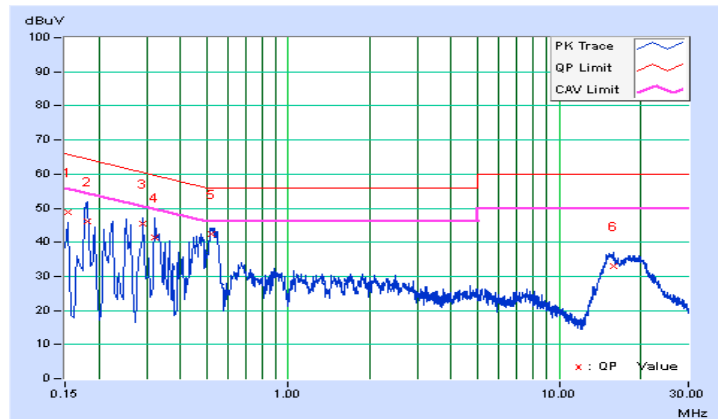

Phase	Neutral (N)	Detector Function	Quasi-Peak (QP) / Average (AV)
Test Mode	A		

No	Freq. [MHz]	Corr. Factor (dB)	Reading Value [dB (uV)]		Emission Level [dB (uV)]		Limit [dB (uV)]		Margin (dB)	
			Q.P.	AV.	Q.P.	AV.	Q.P.	AV.	Q.P.	AV.
			1	0.15000	10.08	33.96	14.13	44.04	24.21	66.00
2	0.18754	10.08	29.72	14.15	39.80	24.23	64.14	54.14	-24.34	-29.91
3	0.22434	10.10	34.32	20.08	44.42	30.18	62.66	52.66	-18.24	-22.48
4	0.29858	10.16	29.78	12.61	39.94	22.77	60.28	50.28	-20.34	-27.51
5	0.53318	10.25	30.97	20.35	41.22	30.60	56.00	46.00	-14.78	-15.40
6	18.01870	11.42	20.18	15.52	31.60	26.94	60.00	50.00	-28.40	-23.06

Remarks:

1. Q.P. and AV. are abbreviations of quasi-peak and average individually.
2. The emission levels of other frequencies were very low against the limit.
3. Margin value = Emission level - Limit value
4. Correction factor = Insertion loss + Cable loss
5. Emission Level = Correction Factor + Reading Value.

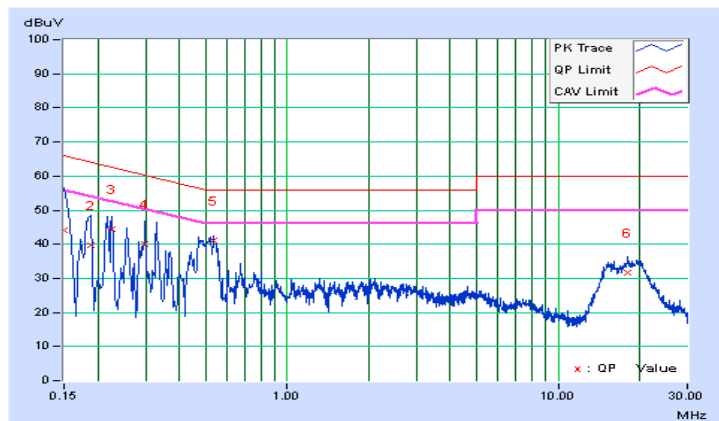

Phase	Line (L)	Detector Function	Quasi-Peak (QP) / Average (AV)
Test Mode	B		

No	Freq. [MHz]	Corr. Factor (dB)	Reading Value [dB (uV)]		Emission Level [dB (uV)]		Limit [dB (uV)]		Margin (dB)	
			Q.P.	AV.	Q.P.	AV.	Q.P.	AV.	Q.P.	AV.
			1	0.16181	10.08	25.31	16.44	35.39	26.52	65.37
2	0.50000	10.19	33.58	26.81	43.77	37.00	56.00	46.00	-12.23	-9.00
3	0.52544	10.20	33.16	26.57	43.36	36.77	56.00	46.00	-12.64	-9.23
4	1.02975	10.29	21.98	15.03	32.27	25.32	56.00	46.00	-23.73	-20.68
5	1.32300	10.32	21.27	13.61	31.59	23.93	56.00	46.00	-24.41	-22.07
6	20.16529	11.43	22.76	17.19	34.19	28.62	60.00	50.00	-25.81	-21.38

Remarks:

1. Q.P. and AV. are abbreviations of quasi-peak and average individually.
2. The emission levels of other frequencies were very low against the limit.
3. Margin value = Emission level - Limit value
4. Correction factor = Insertion loss + Cable loss
5. Emission Level = Correction Factor + Reading Value.

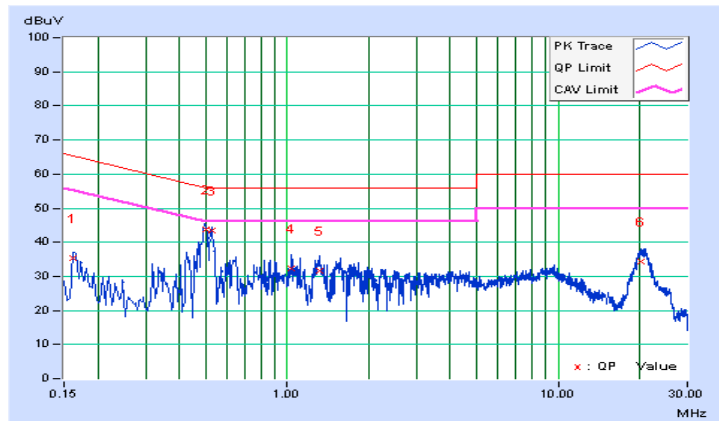

Phase	Neutral (N)	Detector Function	Quasi-Peak (QP) / Average (AV)
Test Mode	B		

No	Freq. [MHz]	Corr. Factor (dB)	Reading Value [dB (uV)]		Emission Level [dB (uV)]		Limit [dB (uV)]		Margin (dB)	
			Q.P.	AV.	Q.P.	AV.	Q.P.	AV.	Q.P.	AV.
			1	0.16955	10.08	25.65	17.89	35.73	27.97	64.98
2	0.30939	10.17	21.96	9.81	32.13	19.98	59.99	49.99	-27.86	-30.01
3	0.52130	10.25	34.15	24.92	44.40	35.17	56.00	46.00	-11.60	-10.83
4	0.61543	10.26	25.25	14.15	35.51	24.41	56.00	46.00	-20.49	-21.59
5	0.91636	10.28	23.40	15.37	33.68	25.65	56.00	46.00	-22.32	-20.35
6	19.78602	11.56	20.76	15.06	32.32	26.62	60.00	50.00	-27.68	-23.38

Remarks:

1. Q.P. and AV. are abbreviations of quasi-peak and average individually.
2. The emission levels of other frequencies were very low against the limit.
3. Margin value = Emission level - Limit value
4. Correction factor = Insertion loss + Cable loss
5. Emission Level = Correction Factor + Reading Value.

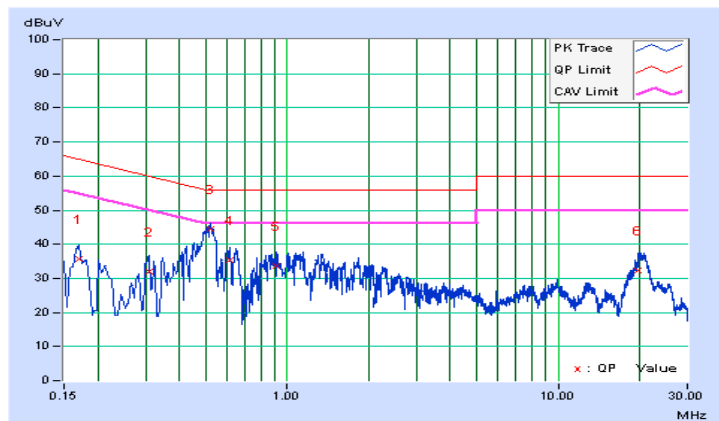

Radio 3: CDD Mode

Phase	Line (L)	Detector Function	Quasi-Peak (QP) / Average (AV)
Test Mode	A		

No	Freq. [MHz]	Corr. Factor (dB)	Reading Value [dB (uV)]		Emission Level [dB (uV)]		Limit [dB (uV)]		Margin (dB)	
			Q.P.	AV.	Q.P.	AV.	Q.P.	AV.	Q.P.	AV.
			1	0.17346	10.08	38.35	29.85	48.43	39.93	64.79
2	0.20084	10.08	34.52	21.52	44.60	31.60	63.58	53.58	-18.98	-21.98
3	0.31031	10.13	34.90	28.54	45.03	38.67	59.96	49.96	-14.93	-11.29
4	0.34159	10.14	31.76	23.60	41.90	33.74	59.16	49.16	-17.26	-15.42
5	0.52821	10.20	32.77	20.68	42.97	30.88	56.00	46.00	-13.03	-15.12
6	15.49284	11.10	21.33	16.61	32.43	27.71	60.00	50.00	-27.57	-22.29

Remarks:

1. Q.P. and AV. are abbreviations of quasi-peak and average individually.
2. The emission levels of other frequencies were very low against the limit.
3. Margin value = Emission level - Limit value
4. Correction factor = Insertion loss + Cable loss
5. Emission Level = Correction Factor + Reading Value.

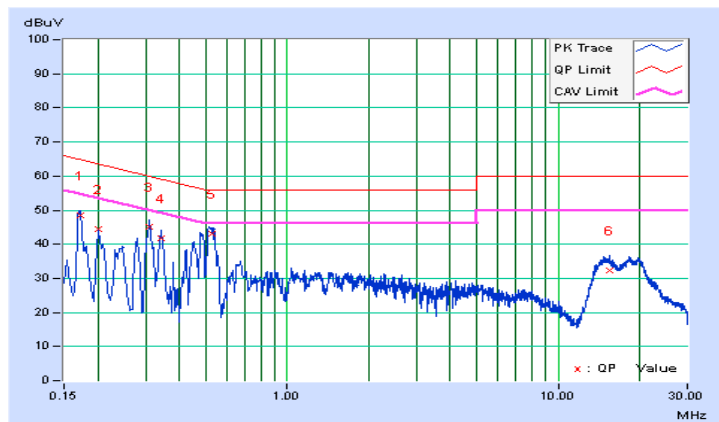

Phase	Neutral (N)	Detector Function	Quasi-Peak (QP) / Average (AV)
Test Mode	A		

No	Freq. [MHz]	Corr. Factor (dB)	Reading Value [dB (uV)]		Emission Level [dB (uV)]		Limit [dB (uV)]		Margin (dB)	
			Q.P.	AV.	Q.P.	AV.	Q.P.	AV.	Q.P.	AV.
			1	0.16955	10.08	39.03	28.80	49.11	38.88	64.98
2	0.20865	10.09	34.91	22.12	45.00	32.21	63.26	53.26	-18.26	-21.05
3	0.23602	10.11	32.63	22.23	42.74	32.34	62.24	52.24	-19.50	-19.90
4	0.31813	10.17	30.19	17.30	40.36	27.47	59.76	49.76	-19.40	-22.29
5	0.52544	10.25	32.83	23.23	43.08	33.48	56.00	46.00	-12.92	-12.52
6	19.04703	11.50	19.71	15.13	31.21	26.63	60.00	50.00	-28.79	-23.37

Remarks:

1. Q.P. and AV. are abbreviations of quasi-peak and average individually.
2. The emission levels of other frequencies were very low against the limit.
3. Margin value = Emission level - Limit value
4. Correction factor = Insertion loss + Cable loss
5. Emission Level = Correction Factor + Reading Value.

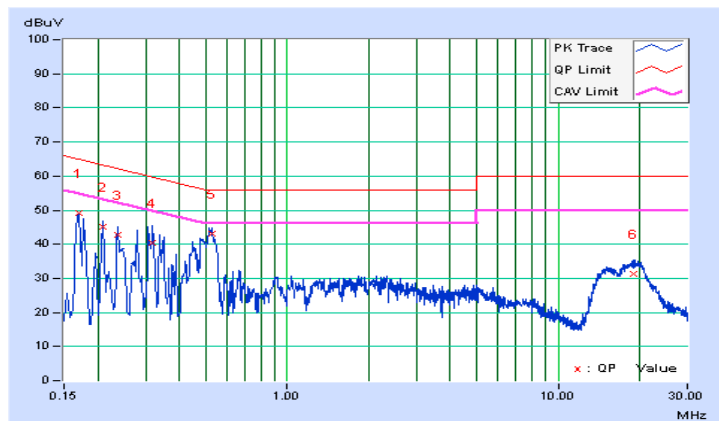

Phase	Line (L)	Detector Function	Quasi-Peak (QP) / Average (AV)
Test Mode	B		

No	Freq. [MHz]	Corr. Factor (dB)	Reading Value [dB (uV)]		Emission Level [dB (uV)]		Limit [dB (uV)]		Margin (dB)	
			Q.P.	AV.	Q.P.	AV.	Q.P.	AV.	Q.P.	AV.
			1	0.15000	10.07	23.66	8.67	33.73	18.74	66.00
2	0.34108	10.14	20.08	10.09	30.22	20.23	59.18	49.18	-28.96	-28.95
3	0.50000	10.19	34.13	26.90	44.32	37.09	56.00	46.00	-11.68	-8.91
4	0.52927	10.20	32.70	26.82	42.90	37.02	56.00	46.00	-13.10	-8.98
5	0.59627	10.21	24.05	16.11	34.26	26.32	56.00	46.00	-21.74	-19.68
6	19.90723	11.41	21.77	16.15	33.18	27.56	60.00	50.00	-26.82	-22.44

Remarks:

1. Q.P. and AV. are abbreviations of quasi-peak and average individually.
2. The emission levels of other frequencies were very low against the limit.
3. Margin value = Emission level - Limit value
4. Correction factor = Insertion loss + Cable loss
5. Emission Level = Correction Factor + Reading Value.

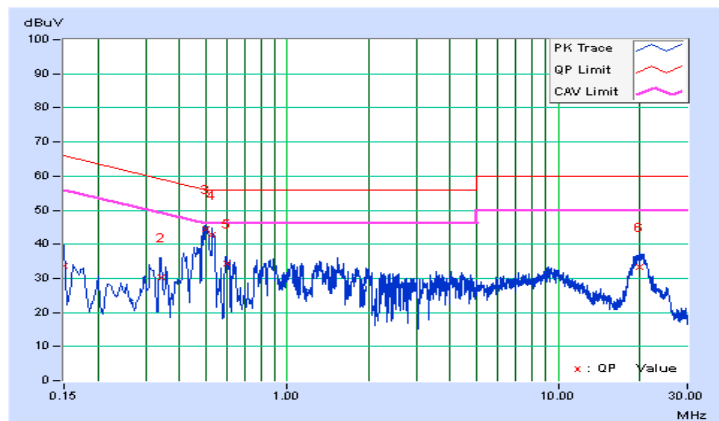

Phase	Neutral (N)	Detector Function	Quasi-Peak (QP) / Average (AV)
Test Mode	B		

No	Freq. [MHz]	Corr. Factor (dB)	Reading Value [dB (uV)]		Emission Level [dB (uV)]		Limit [dB (uV)]		Margin (dB)	
			Q.P.	AV.	Q.P.	AV.	Q.P.	AV.	Q.P.	AV.
			1	0.16569	10.08	27.94	21.87	38.02	31.95	65.17
2	0.48935	10.25	32.43	25.44	42.68	35.69	56.18	46.18	-13.50	-10.49
3	0.52544	10.25	34.47	28.05	44.72	38.30	56.00	46.00	-11.28	-7.70
4	0.64266	10.26	26.75	15.70	37.01	25.96	56.00	46.00	-18.99	-20.04
5	0.87335	10.28	25.93	18.46	36.21	28.74	56.00	46.00	-19.79	-17.26
6	20.32560	11.60	20.75	15.17	32.35	26.77	60.00	50.00	-27.65	-23.23

Remarks:

1. Q.P. and AV. are abbreviations of quasi-peak and average individually.
2. The emission levels of other frequencies were very low against the limit.
3. Margin value = Emission level - Limit value
4. Correction factor = Insertion loss + Cable loss
5. Emission Level = Correction Factor + Reading Value.

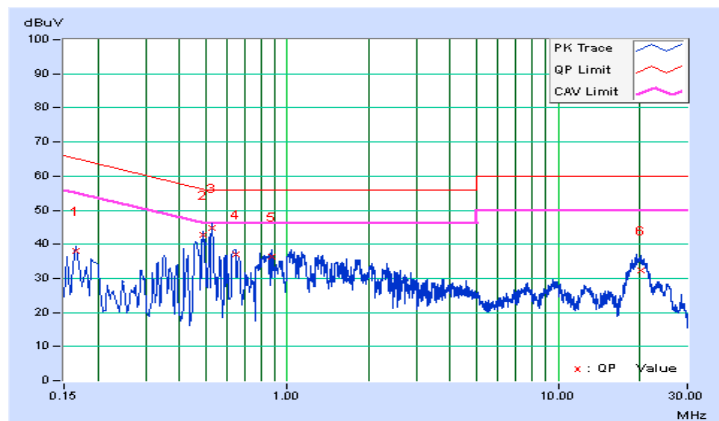

4.3 6dB Bandwidth Measurement

4.3.1 Limits of 6dB Bandwidth Measurement

The minimum of 6dB Bandwidth Measurement is 0.5 MHz.

4.3.2 Test Setup

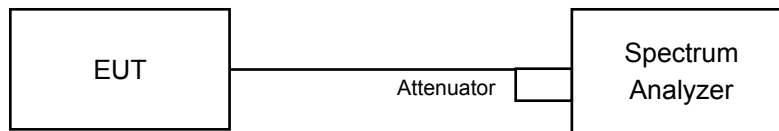

4.3.3 Test Instruments

Refer to section 4.1.2 to get information of above instrument.

4.3.4 Test Procedure

- Set resolution bandwidth (RBW) = 100kHz
- Set the video bandwidth (VBW) $\geq 3 \times$ RBW, Detector = average.
- Trace mode = max hold.
- Sweep = auto couple.
- Measure the maximum width of the emission that is constrained by the frequencies associated with the two amplitude points (upper and lower) that are attenuated by 6 dB relative to the maximum level measured in the fundamental emission

4.3.5 Deviation from Test Standard

No deviation.

4.3.6 EUT Operating Conditions

The software provided by client to enable the EUT under transmission condition continuously at lowest, middle and highest channel frequencies individually.

4.3.7 Test Result

Radio1: CDD Mode

802.11b

Channel	Frequency (MHz)	6dB Bandwidth (MHz)				Minimum Limit (MHz)	Pass / Fail
		Chain 0	Chain 1	Chain 2	Chain 3		
1	2412	8.11	8.11	8.08	8.12	0.5	Pass
6	2437	8.11	8.11	8.09	8.07	0.5	Pass
11	2462	8.11	6.60	7.12	8.10	0.5	Pass

802.11g

Channel	Frequency (MHz)	6dB Bandwidth (MHz)				Minimum Limit (MHz)	Pass / Fail
		Chain 0	Chain 1	Chain 2	Chain 3		
1	2412	16.37	16.31	16.39	16.39	0.5	Pass
6	2437	16.36	15.68	16.34	16.40	0.5	Pass
11	2462	16.38	15.29	15.77	16.39	0.5	Pass

802.11n (HT20)

Channel	Frequency (MHz)	6dB Bandwidth (MHz)				Minimum Limit (MHz)	Pass / Fail
		Chain 0	Chain 1	Chain 2	Chain 3		
1	2412	17.60	16.33	17.21	17.62	0.5	Pass
6	2437	17.60	15.59	17.18	17.62	0.5	Pass
11	2462	17.57	15.95	16.92	17.61	0.5	Pass

802.11n (HT40)

Channel	Frequency (MHz)	6dB Bandwidth (MHz)				Minimum Limit (MHz)	Pass / Fail
		Chain 0	Chain 1	Chain 2	Chain 3		
3	2422	35.89	35.83	35.87	35.83	0.5	Pass
6	2437	35.80	35.81	35.77	35.29	0.5	Pass
9	2452	35.81	35.82	35.78	35.24	0.5	Pass

Spectrum Plot of Worst Value

802.11b

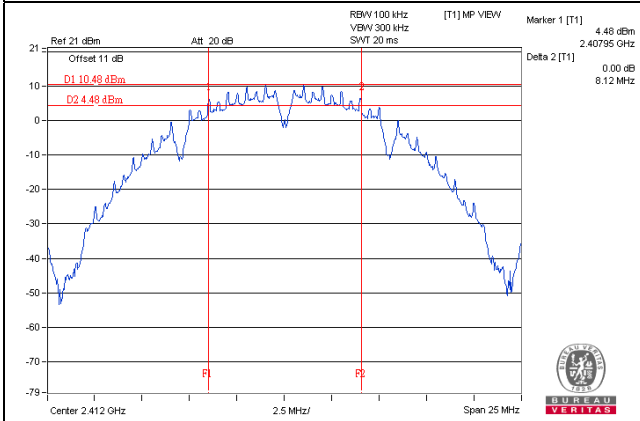

802.11g

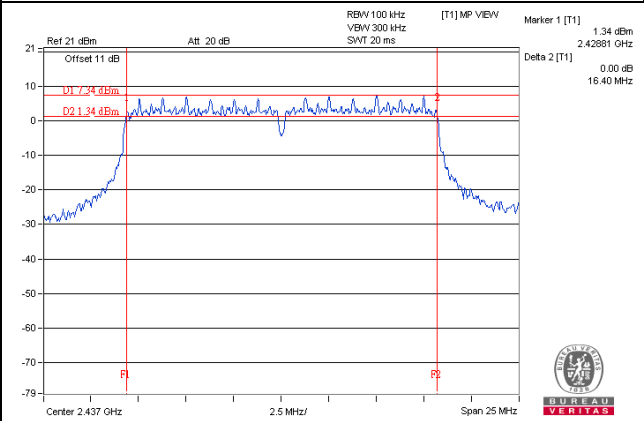

802.11n (HT20)

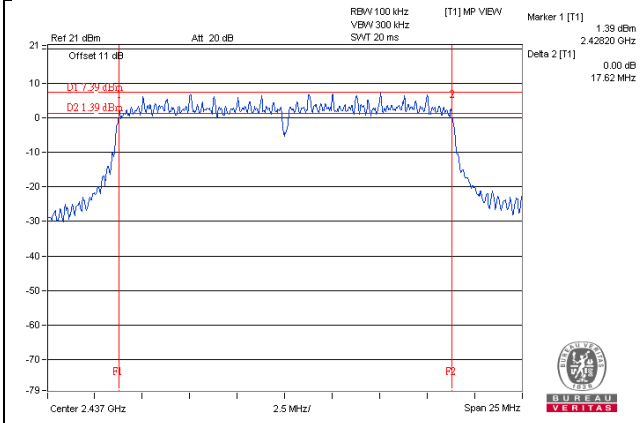

802.11n (HT40)

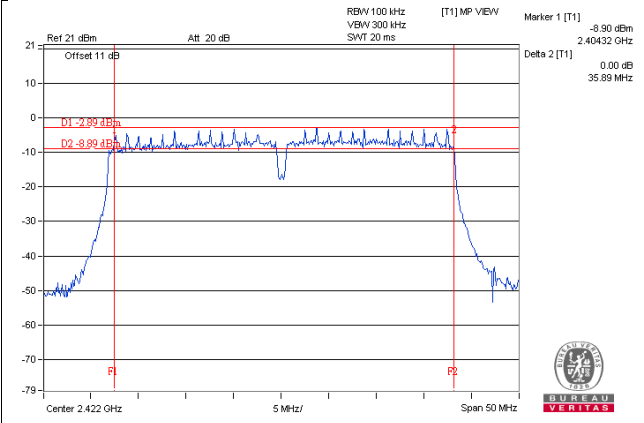

Radio3: CDD Mode

802.11b

Channel	Frequency (MHz)	6dB Bandwidth (MHz)	Minimum Limit (MHz)	Pass / Fail
1	2412	6.13	0.5	Pass
6	2437	6.14	0.5	Pass
11	2462	6.08	0.5	Pass

802.11g

Channel	Frequency (MHz)	6dB Bandwidth (MHz)	Minimum Limit (MHz)	Pass / Fail
1	2412	16.31	0.5	Pass
6	2437	16.08	0.5	Pass
11	2462	16.09	0.5	Pass

802.11n (HT20)

Channel	Frequency (MHz)	6dB Bandwidth (MHz)	Minimum Limit (MHz)	Pass / Fail
1	2412	16.90	0.5	Pass
6	2437	16.86	0.5	Pass
11	2462	16.85	0.5	Pass

802.11n (HT40)

Channel	Frequency (MHz)	6dB Bandwidth (MHz)	Minimum Limit (MHz)	Pass / Fail
3	2422	35.35	0.5	Pass
6	2437	35.28	0.5	Pass
9	2452	35.27	0.5	Pass

Spectrum Plot of Worst Value

802.11b

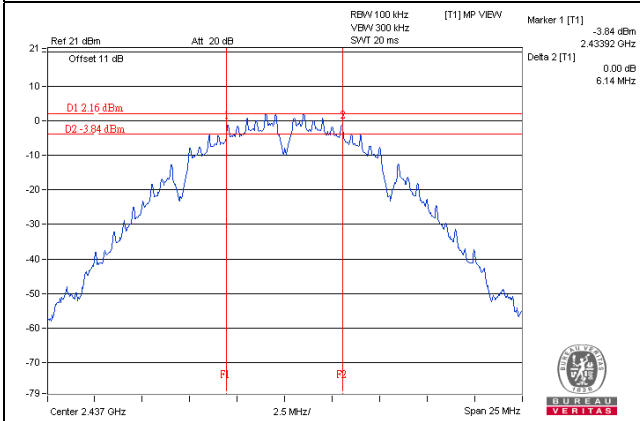

802.11g

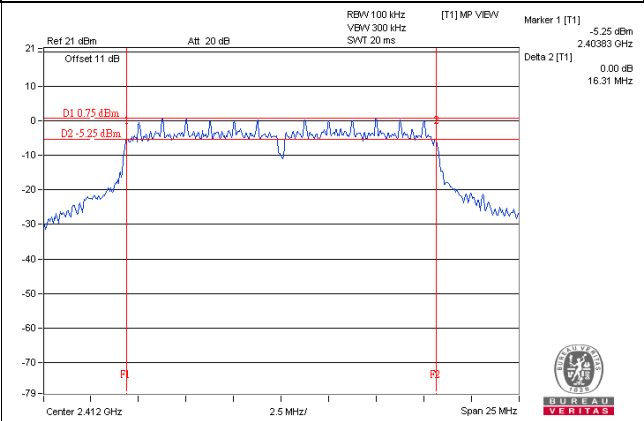

802.11n (HT20)

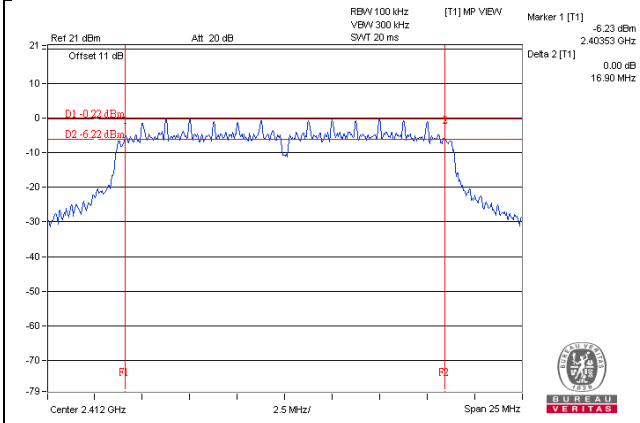

802.11n (HT40)

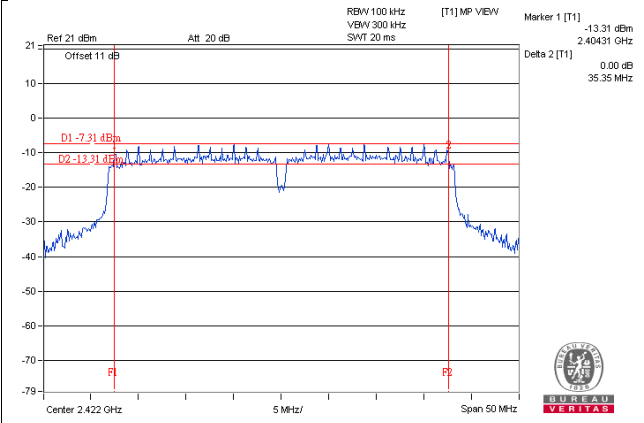

4.4 Conducted Output Power Measurement

4.4.1 Limits of Conducted Output Power Measurement

For systems using digital modulation in the 2400–2483.5 MHz bands: 1 Watt (30dBm)

Per KDB 662911 D01 Multiple Transmitter Output Method of conducted output power measurement on IEEE 802.11 devices,

Array Gain = 0 dB (i.e., no array gain) for $NANT \leq 4$;

Array Gain = 0 dB (i.e., no array gain) for channel widths ≥ 40 MHz for any NANT;

Array Gain = $5 \log(NANT/NSS)$ dB or 3 dB, whichever is less for 20-MHz channel widths with $NANT \geq 5$.

For power measurements on all other devices: Array Gain = $10 \log(NANT/NSS)$ dB.

4.4.2 Test Setup

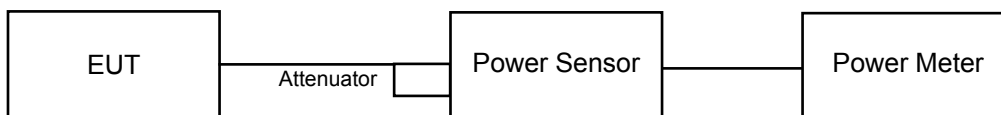

4.4.3 Test Instruments

Refer to section 4.1.2 to get information of above instrument.

4.4.4 Test Procedures

An average power sensor was used on the output port of the EUT. A power meter was used to read the response of the average power sensor. Record the power level.

4.4.5 Deviation from Test Standard

No deviation.

4.4.6 EUT Operating Conditions

Same as Item 4.3.6.

4.4.7 Test Results

Radio 1: CDD Mode

802.11b

Channel	Frequency (MHz)	Average Power (dBm)				Total Power (mW)	Total Power (dBm)	Limit (dBm)	Pass / Fail
		Chain 0	Chain 1	Chain 2	Chain 3				
1	2412	18.58	19.46	19.12	18.65	315.359	24.99	30	Pass
6	2437	18.73	19.39	18.40	18.61	303.335	24.82	30	Pass
11	2462	16.11	16.83	15.84	15.96	166.844	22.22	30	Pass

802.11g

Channel	Frequency (MHz)	Average Power (dBm)				Total Power (mW)	Total Power (dBm)	Limit (dBm)	Pass / Fail
		Chain 0	Chain 1	Chain 2	Chain 3				
1	2412	15.03	14.90	14.80	14.91	123.919	20.93	30	Pass
6	2437	18.85	19.05	18.38	18.55	297.568	24.74	30	Pass
11	2462	13.26	13.65	13.11	13.12	85.334	19.31	30	Pass

802.11n (HT20)

Channel	Frequency (MHz)	Average Power (dBm)				Total Power (mW)	Total Power (dBm)	Limit (dBm)	Pass / Fail
		Chain 0	Chain 1	Chain 2	Chain 3				
1	2412	15.06	15.10	14.92	14.96	126.801	21.03	30	Pass
6	2437	18.82	18.98	18.66	18.59	301.004	24.79	30	Pass
11	2462	13.25	13.54	13.29	13.28	86.340	19.36	30	Pass

802.11n (HT40)

Channel	Frequency (MHz)	Average Power (dBm)				Total Power (mW)	Total Power (dBm)	Limit (dBm)	Pass / Fail
		Chain 0	Chain 1	Chain 2	Chain 3				
3	2422	11.79	11.63	11.35	11.21	56.515	17.52	30	Pass
6	2437	13.67	13.67	13.45	13.34	90.270	19.56	30	Pass
9	2452	11.10	11.00	10.89	10.72	49.548	16.95	30	Pass

Radio 1: Beamforming Mode

802.11n (HT20)

Channel	Frequency (MHz)	Average Power (dBm)				Total Power (mW)	Total Power (dBm)	Limit (dBm)	Pass / Fail
		Chain 0	Chain 1	Chain 2	Chain 3				
1	2412	9.04	9.08	8.90	8.94	31.704	15.01	26.22	Pass
6	2437	12.80	12.96	12.64	12.57	75.262	18.77	26.22	Pass
11	2462	7.23	7.52	7.27	7.26	21.587	13.34	26.22	Pass

Note: Directional gain = $10 \log[(10^{G1/20} + 10^{G2/20} + \dots + 10^{GN/20})^2/4] = 9.78\text{dBi} > 6\text{dBi}$, so the power limit shall be reduced to $30 - (9.78 - 6) = 26.22\text{dBm}$.

802.11n (HT40)

Channel	Frequency (MHz)	Average Power (dBm)				Total Power (mW)	Total Power (dBm)	Limit (dBm)	Pass / Fail
		Chain 0	Chain 1	Chain 2	Chain 3				
3	2422	5.77	5.61	5.33	5.19	14.131	11.50	26.22	Pass
6	2437	7.65	7.65	7.43	7.32	22.571	13.54	26.22	Pass
9	2452	5.08	4.98	4.87	4.70	12.389	10.93	26.22	Pass

Note: Directional gain = $10 \log[(10^{G1/20} + 10^{G2/20} + \dots + 10^{GN/20})^2/4] = 9.78\text{dBi} > 6\text{dBi}$, so the power limit shall be reduced to $30 - (9.78 - 6) = 26.22\text{dBm}$.

Radio 3: CDD Mode

802.11b

Channel	Frequency (MHz)	Average Power (mW)	Average Power (dBm)	Limit (dBm)	Pass / Fail
1	2412	6.281	7.98	30	Pass
6	2437	6.427	8.08	30	Pass
11	2462	5.768	7.61	30	Pass

802.11g

Channel	Frequency (MHz)	Average Power (mW)	Average Power (dBm)	Limit (dBm)	Pass / Fail
1	2412	8.299	9.19	30	Pass
6	2437	17.865	12.52	30	Pass
11	2462	7.031	8.47	30	Pass

802.11n (HT20)

Channel	Frequency (MHz)	Average Power (mW)	Average Power (dBm)	Limit (dBm)	Pass / Fail
1	2412	6.577	8.18	30	Pass
6	2437	20.091	13.03	30	Pass
11	2462	5.929	7.73	30	Pass

802.11n (HT40)

Channel	Frequency (MHz)	Average Power (mW)	Average Power (dBm)	Limit (dBm)	Pass / Fail
3	2422	3.062	4.86	30	Pass
6	2437	7.638	8.83	30	Pass
9	2452	2.812	4.49	30	Pass

4.5 Power Spectral Density Measurement

4.5.1 Limits of Power Spectral Density Measurement

The Maximum of Power Spectral Density Measurement is 8dBm.

4.5.2 Test Setup

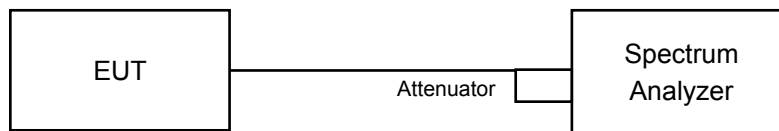

4.5.3 Test Instruments

Refer to section 4.1.2 to get information of above instrument.

4.5.4 Test Procedure

Duty cycle $\geq 98\%$

- Set instrument center frequency to DTS channel center frequency.
- Set span to at least 1.5 times the OBW.
- Set RBW to: $3 \text{ kHz} \leq \text{RBW} \leq 100 \text{ kHz}$.
- Set VBW $\geq 3 \times \text{RBW}$.
- Detector = power averaging (RMS) or sample detector (when RMS not available).
- Ensure that the number of measurement points in the sweep $\geq 2 \times \text{span}/\text{RBW}$.
- Sweep time = auto couple.
- Employ trace averaging (RMS) mode over a minimum of 100 traces.
- Use the peak marker function to determine the maximum amplitude level.

Duty cycle $< 98\%$

- Measure the duty cycle (x).
- Set instrument center frequency to DTS channel center frequency.
- Set span to at least 1.5 times the OBW.
- Set RBW to: $3 \text{ kHz} \leq \text{RBW} \leq 100 \text{ kHz}$.
- Set VBW $\geq 3 \times \text{RBW}$.
- Detector = power averaging (RMS) or sample detector (when RMS not available).
- Ensure that the number of measurement points in the sweep $\geq 2 \times \text{span}/\text{RBW}$.
- Sweep time = auto couple.
- Do not use sweep triggering. Allow sweep to "free run".
- Employ trace averaging (RMS) mode over a minimum of 100 traces.
- Use the peak marker function to determine the maximum amplitude level.
- Add $10 \log (1/x)$, where x is the duty cycle measured in step (a), to the measured PSD to compute the average PSD during the actual transmission time.

4.5.5 Deviation from Test Standard

No deviation.

4.5.6 EUT Operating Condition

Same as Item 4.3.6

4.5.7 Test Results

Radio 1: CDD Mode

802.11b

TX chain	Channel	Frequency (MHz)	PSD (dBm/3kHz)	10 log (N=4) dB	Total PSD (dBm/3kHz)	Limit (dBm/3kHz)	Pass / Fail
0	1	2412	-14.11	6.02	-8.09	4.22	Pass
	6	2437	-13.72	6.02	-7.70	4.22	Pass
	11	2462	-16.60	6.02	-10.58	4.22	Pass
1	1	2412	-14.81	6.02	-8.79	4.22	Pass
	6	2437	-14.23	6.02	-8.21	4.22	Pass
	11	2462	-15.31	6.02	-9.29	4.22	Pass
2	1	2412	-13.05	6.02	-7.03	4.22	Pass
	6	2437	-13.59	6.02	-7.57	4.22	Pass
	11	2462	-15.80	6.02	-9.78	4.22	Pass
3	1	2412	-14.12	6.02	-8.10	4.22	Pass
	6	2437	-14.50	6.02	-8.48	4.22	Pass
	11	2462	-16.54	6.02	-10.52	4.22	Pass

Note:

- Method 1 of power density measurement of KDB 662911 is using for calculating total power density. Total power density is summing entire spectra across corresponding frequency bins on the various outputs by computer.
- Directional gain = $10 \log[(10^{G1/20} + 10^{G2/20} + \dots + 10^{GN/20})^2/4] = 9.78\text{dBi} > 6\text{dBi}$, so the power density limit shall be reduced to $8 - (9.78 - 6) = 4.22\text{dBm}$.

802.11g

TX chain	Channel	Freq. (MHz)	PSD w/o Duty Factor (dBm/3kHz)	10 log (N=4) dB	Duty Factor (dB)	Total PSD With Duty Factor (dBm/3kHz)	Limit (dBm/3kHz)	Pass / Fail
0	1	2412	-21.54	6.02	0.19	-15.33	4.22	Pass
	6	2437	-17.77	6.02	0.19	-11.56	4.22	Pass
	11	2462	-23.13	6.02	0.19	-16.92	4.22	Pass
1	1	2412	-21.55	6.02	0.19	-15.34	4.22	Pass
	6	2437	-16.77	6.02	0.19	-10.56	4.22	Pass
	11	2462	-22.02	6.02	0.19	-15.81	4.22	Pass
2	1	2412	-22.06	6.02	0.19	-15.85	4.22	Pass
	6	2437	-17.87	6.02	0.19	-11.66	4.22	Pass
	11	2462	-23.02	6.02	0.19	-16.81	4.22	Pass
3	1	2412	-21.94	6.02	0.19	-15.73	4.22	Pass
	6	2437	-18.00	6.02	0.19	-11.79	4.22	Pass
	11	2462	-22.97	6.02	0.19	-16.76	4.22	Pass

Note:

1. Method 1 of power density measurement of KDB 662911 is using for calculating total power density. Total power density is summing entire spectra across corresponding frequency bins on the various outputs by computer.
2. Directional gain = $10 \log[(10^{G1/20} + 10^{G2/20} + \dots + 10^{GN/20})^2/4] = 9.78\text{dBi} > 6\text{dBi}$, so the power density limit shall be reduced to $8 - (9.78 - 6) = 4.22\text{dBm}$.
3. Refer to section 3.3 for duty cycle spectrum plot.

802.11n (HT20)

TX chain	Channel	Frequency (MHz)	PSD (dBm/3kHz)	10 log (N=4) dB	Total PSD (dBm/3kHz)	Limit (dBm/3kHz)	Pass / Fail
0	1	2412	-21.97	6.02	-15.95	4.22	Pass
	6	2437	-17.68	6.02	-11.66	4.22	Pass
	11	2462	-23.53	6.02	-17.51	4.22	Pass
1	1	2412	-21.21	6.02	-15.19	4.22	Pass
	6	2437	-16.98	6.02	-10.96	4.22	Pass
	11	2462	-22.33	6.02	-16.31	4.22	Pass
2	1	2412	-22.38	6.02	-16.36	4.22	Pass
	6	2437	-17.62	6.02	-11.60	4.22	Pass
	11	2462	-22.64	6.02	-16.62	4.22	Pass
3	1	2412	-21.57	6.02	-15.55	4.22	Pass
	6	2437	-17.36	6.02	-11.34	4.22	Pass
	11	2462	-23.29	6.02	-17.27	4.22	Pass

Note:

- Method 1 of power density measurement of KDB 662911 is using for calculating total power density. Total power density is summing entire spectra across corresponding frequency bins on the various outputs by computer.
- Directional gain = $10 \log[(10^{G1/20} + 10^{G2/20} + \dots + 10^{GN/20})^2/4] = 9.78\text{dBi} > 6\text{dBi}$, so the power density limit shall be reduced to $8 - (9.78 - 6) = 4.22\text{dBm}$.

802.11n (HT40)

TX chain	Channel	Freq. (MHz)	PSD w/o Duty Factor (dBm/3kHz)	10 log (N=4) dB	Duty Factor (dB)	Total PSD With Duty Factor (dBm/3kHz)	Limit (dBm/3kHz)	Pass / Fail
0	3	2422	-28.47	6.02	0.13	-22.32	4.22	Pass
	6	2437	-26.67	6.02	0.13	-20.52	4.22	Pass
	9	2452	-29.15	6.02	0.13	-23.00	4.22	Pass
1	3	2422	-28.60	6.02	0.13	-22.45	4.22	Pass
	6	2437	-25.37	6.02	0.13	-19.22	4.22	Pass
	9	2452	-28.98	6.02	0.13	-22.83	4.22	Pass
2	3	2422	-28.97	6.02	0.13	-22.82	4.22	Pass
	6	2437	-26.58	6.02	0.13	-20.43	4.22	Pass
	9	2452	-28.51	6.02	0.13	-22.36	4.22	Pass
3	3	2422	-28.65	6.02	0.13	-22.50	4.22	Pass
	6	2437	-26.84	6.02	0.13	-20.69	4.22	Pass
	9	2452	-29.41	6.02	0.13	-23.26	4.22	Pass

Note:

1. Method 1 of power density measurement of KDB 662911 is using for calculating total power density. Total power density is summing entire spectra across corresponding frequency bins on the various outputs by computer.
2. Directional gain = $10 \log[(10^{G1/20} + 10^{G2/20} + \dots + 10^{GN/20})^2/4] = 9.78\text{dBi} > 6\text{dBi}$, so the power density limit shall be reduced to $8 - (9.78 - 6) = 4.22\text{dBm}$.
3. Refer to section 3.3 for duty cycle spectrum plot.

Spectrum Plot of Worst Value

802.11b

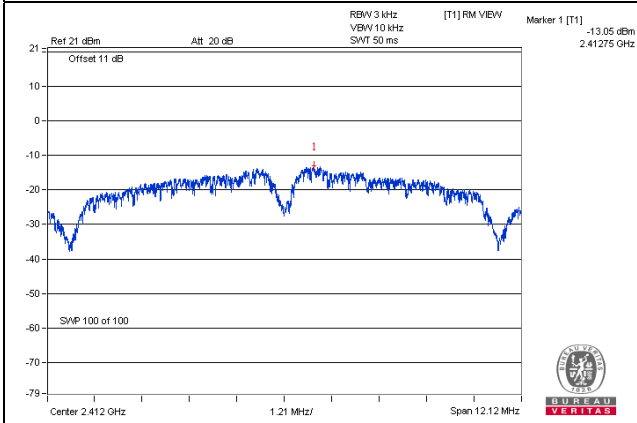

802.11g

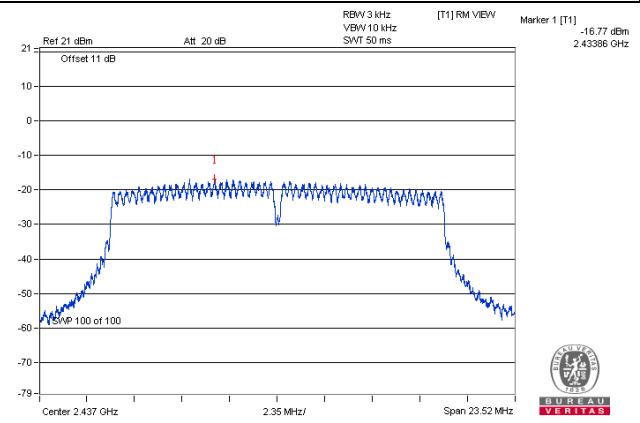

802.11n (HT20)

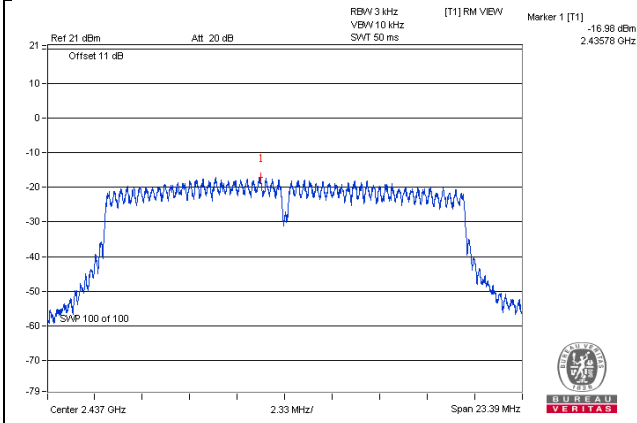

802.11n (HT40)

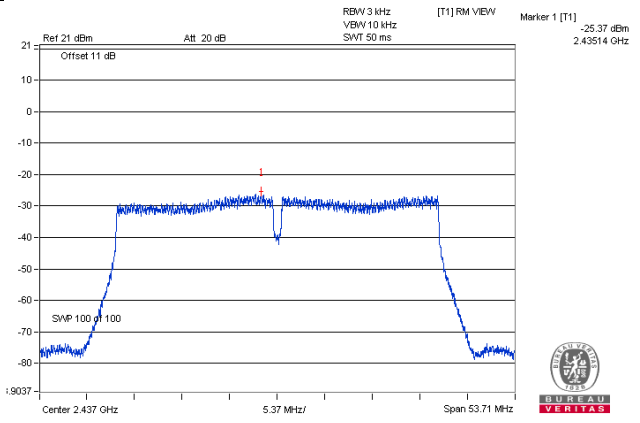

Radio 3: CDD Mode

802.11b

Channel	Freq. (MHz)	PSD (dBm/3kHz)	Limit (dBm/3kHz)	Pass / Fail
1	2412	-22.03	8.00	Pass
6	2437	-22.54	8.00	Pass
11	2462	-22.28	8.00	Pass

802.11g

Channel	Frequency (MHz)	PSD w/o Duty Factor (dBm/3kHz)	Duty Factor (dB)	Total PSD With Duty Factor (dBm/3kHz)	Limit (dBm/3kHz)	Pass / Fail
1	2412	-25.58	0.16	-25.42	8.00	Pass
6	2437	-21.14	0.16	-20.98	8.00	Pass
11	2462	-25.35	0.16	-25.19	8.00	Pass

Note: Refer to section 3.3 for duty cycle spectrum plot.

802.11n (HT20)

Channel	Frequency (MHz)	PSD w/o Duty Factor (dBm/3kHz)	Duty Factor (dB)	Total PSD With Duty Factor (dBm/3kHz)	Limit (dBm/3kHz)	Pass / Fail
1	2412	-26.16	0.22	-25.94	8.00	Pass
6	2437	-20.95	0.22	-20.73	8.00	Pass
11	2462	-26.61	0.22	-26.39	8.00	Pass

Note: Refer to section 3.3 for duty cycle spectrum plot.

802.11n (HT40)

Channel	Frequency (MHz)	PSD w/o Duty Factor (dBm/3kHz)	Duty Factor (dB)	Total PSD With Duty Factor (dBm/3kHz)	Limit (dBm/3kHz)	Pass / Fail
3	2422	-33.93	0.44	-33.49	8.00	Pass
6	2437	-29.16	0.44	-28.72	8.00	Pass
9	2452	-33.96	0.44	-33.52	8.00	Pass

Note: Refer to section 3.3 for duty cycle spectrum plot.

Spectrum Plot of Worst Value

802.11b

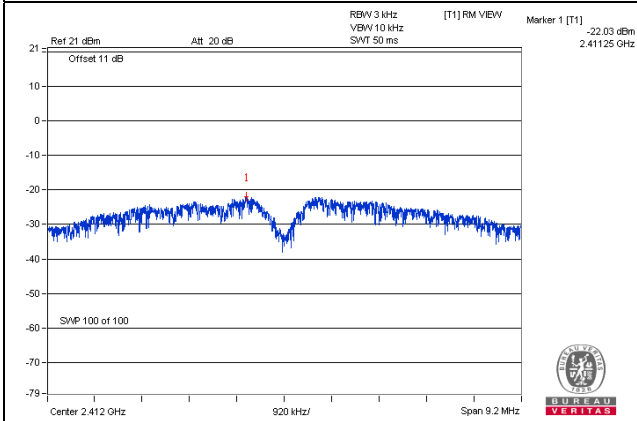

802.11g

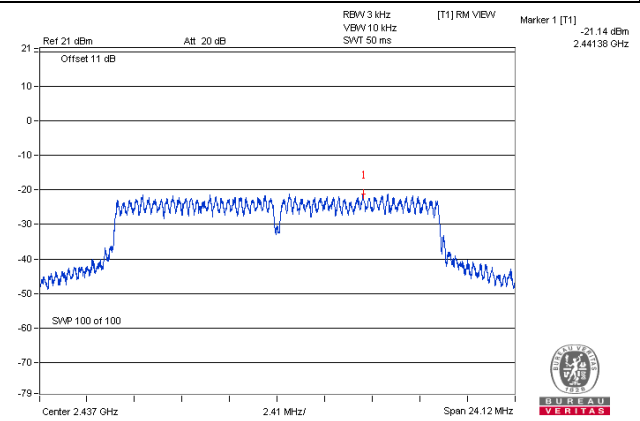

802.11n (HT20)

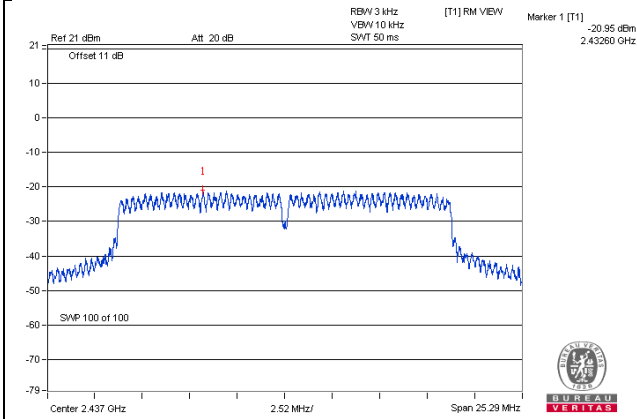

802.11n (HT40)

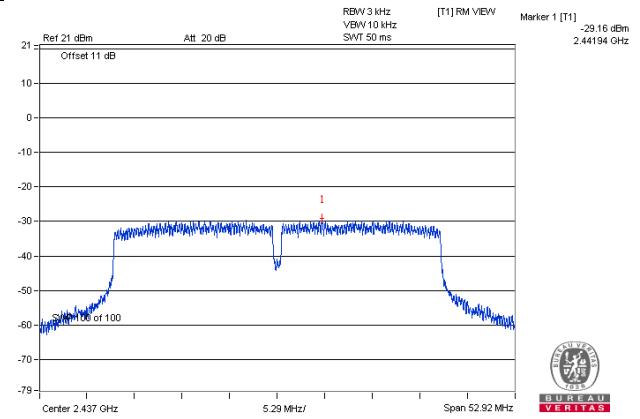

4.6 Conducted Out of Band Emission Measurement

4.6.1 Limits of Conducted Out of Band Emission Measurement

Below 30dB of the highest emission level of operating band (in 100kHz Resolution Bandwidth).

4.6.2 Test Setup

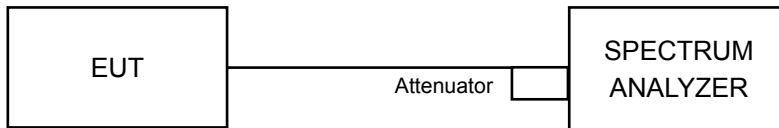

4.6.3 Test Instruments

Refer to section 4.1.2 to get information of above instrument.

4.6.4 Test Procedure

MEASUREMENT PROCEDURE REF

- Set the RBW = 100 kHz.
- Set the VBW \geq 300 kHz.
- Detector = average.
- Sweep time = auto couple.
- Trace mode = max hold.
- Allow trace to fully stabilize.
- Use the peak marker function to determine the maximum power level in any 100 kHz band segment within the fundamental EBW.

MEASUREMENT PROCEDURE OOB

- Set RBW = 100 kHz.
- Set VBW \geq 300 kHz.
- Ensure that the number of measurement points \geq span/RBW
- According to measurement points to set differ measurement span.
- Detector = average.
- Trace Mode = max hold.
- Sweep = auto couple.

4.6.5 Deviation from Test Standard

No deviation.

4.6.6 EUT Operating Condition

Same as Item 4.3.6

4.6.7 Test Results

The spectrum plots are attached on the following pages. D1 line indicates the highest level, and D2 line indicates the 30dB offset below D1. It shows compliance with the requirement.

Radio 1: CDD Mode
802.11b_Chain 0

CH 1

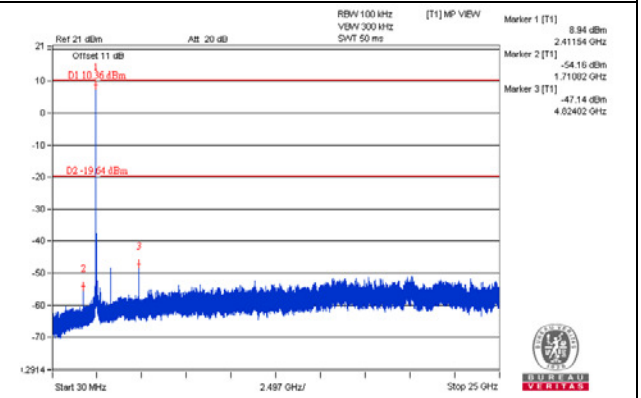
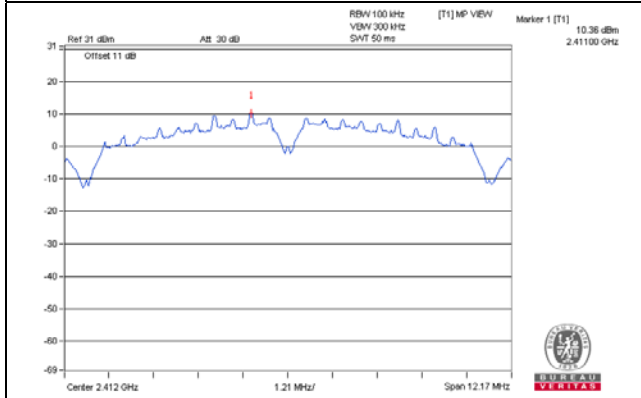

CH 6

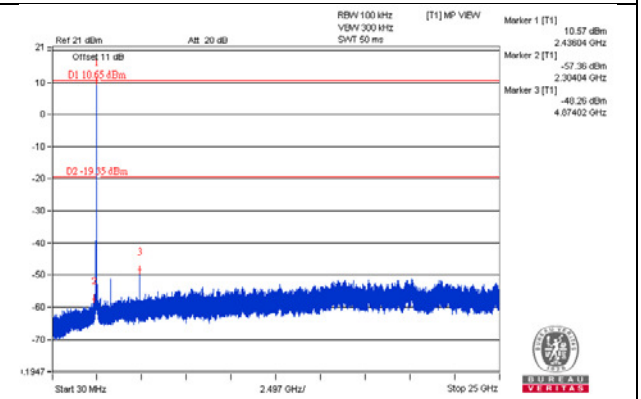
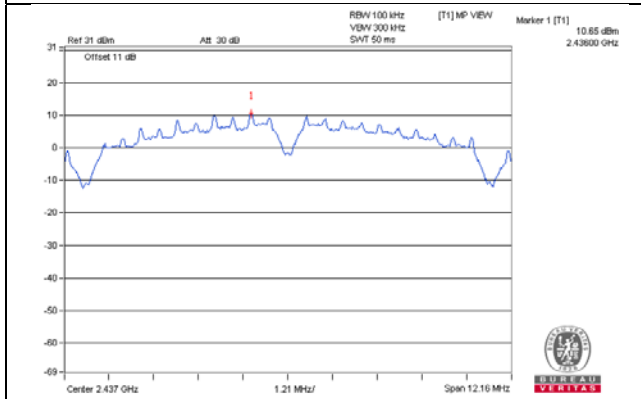

CH 11

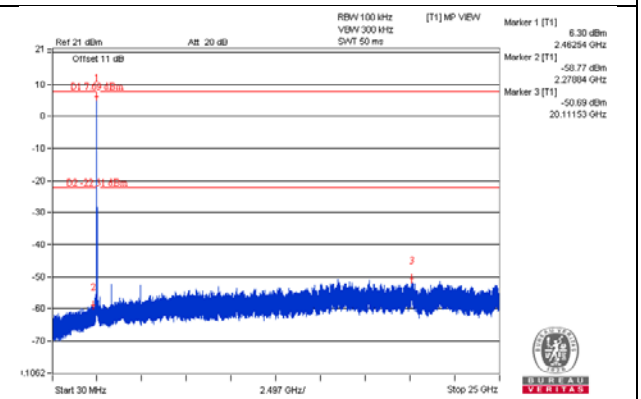
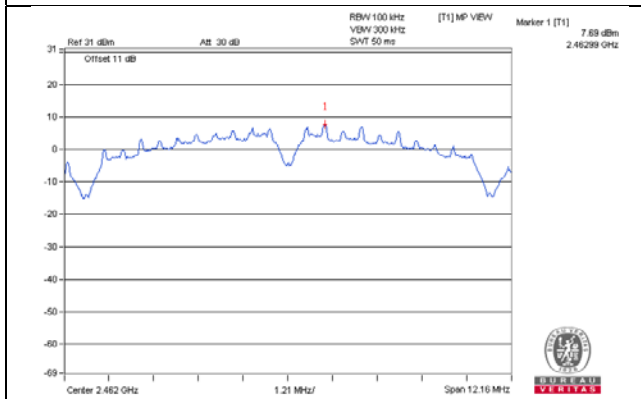

CH 1 Band edge

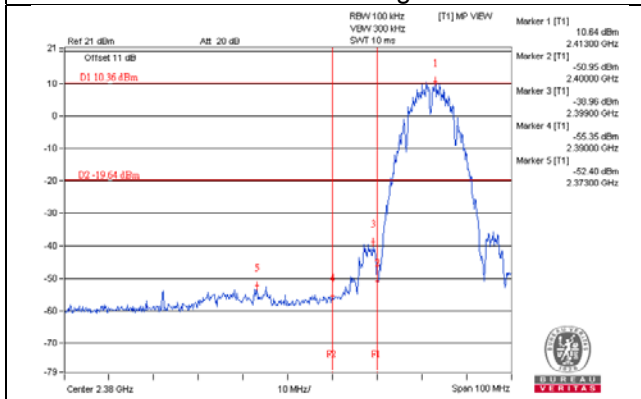

CH 11 Band edge

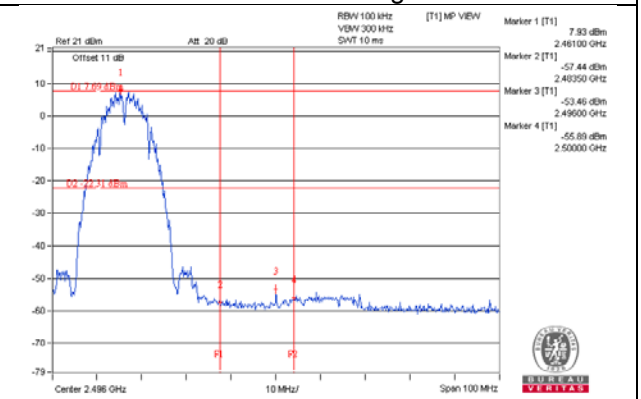

802.11b_Chain 1

CH 1

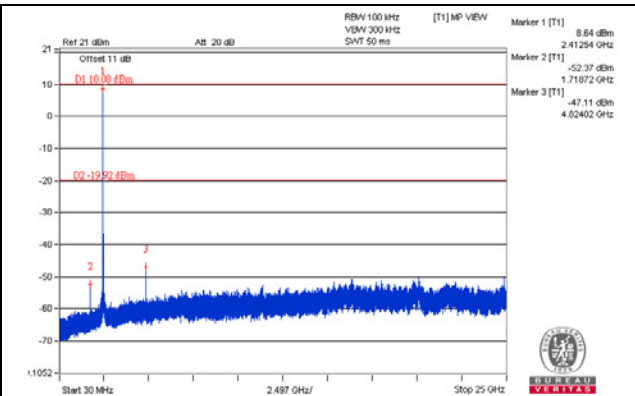
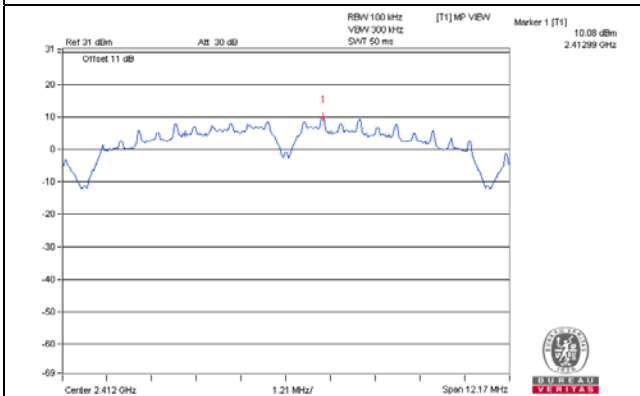

CH 6

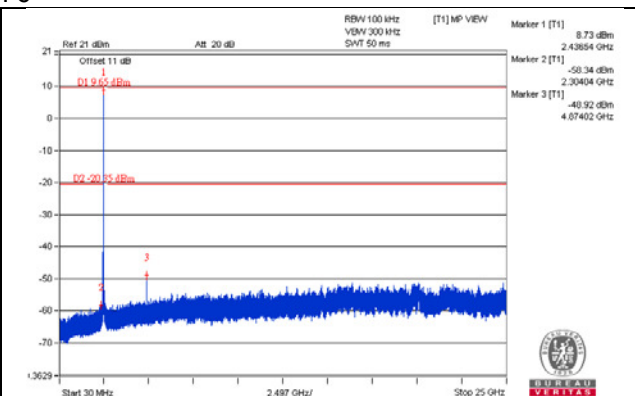
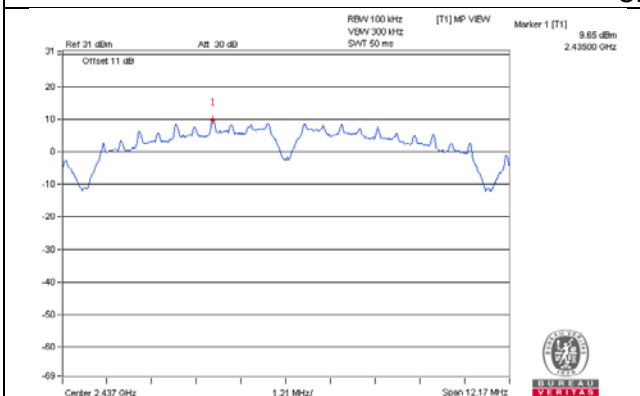

CH 11

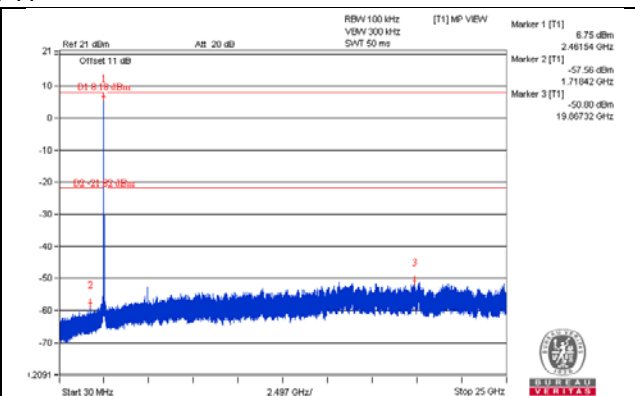
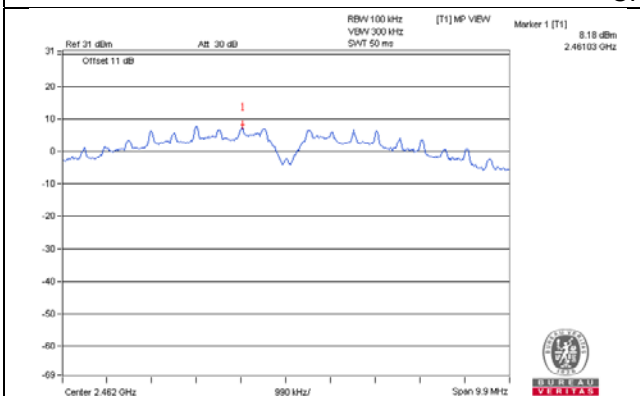

CH 1 Band edge

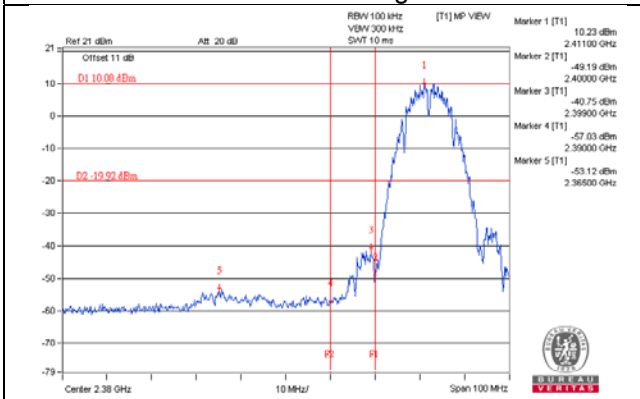

CH 11 Band edge

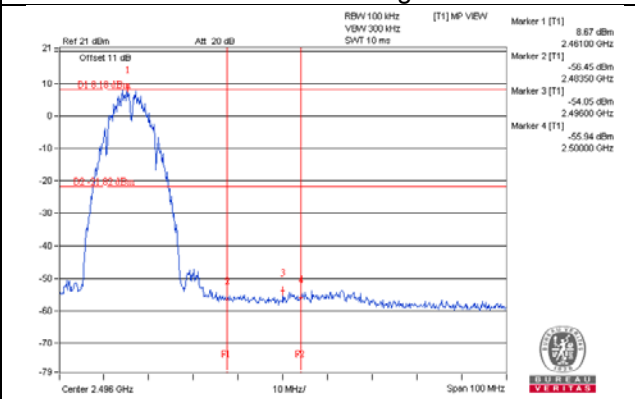

802.11b_Chain 2

CH 1

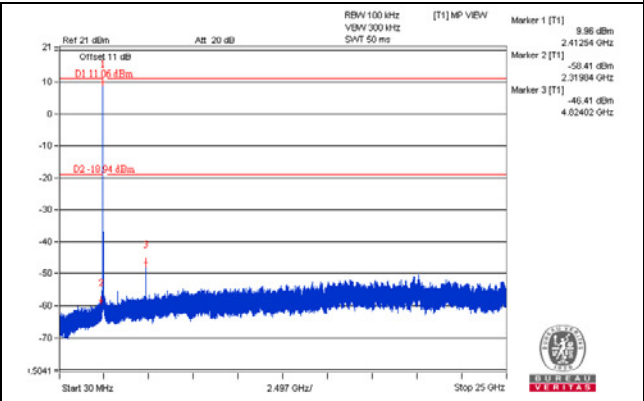
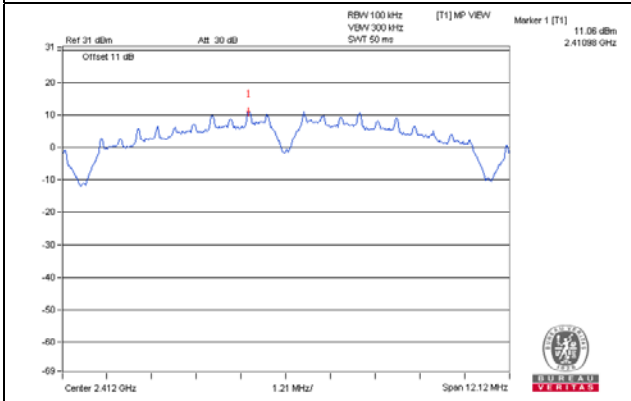

CH 6

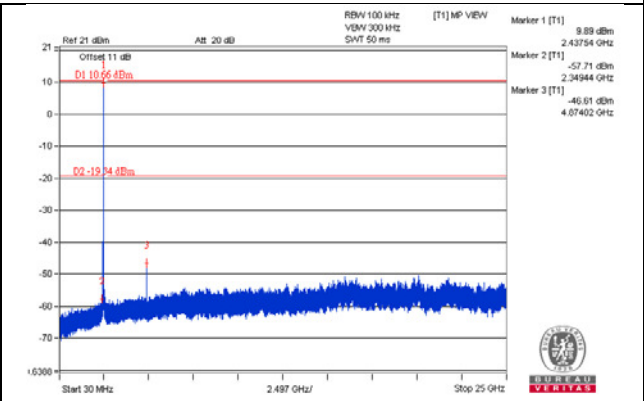
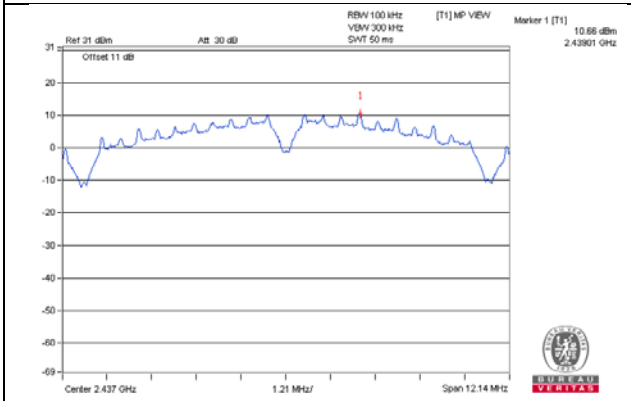

CH 11

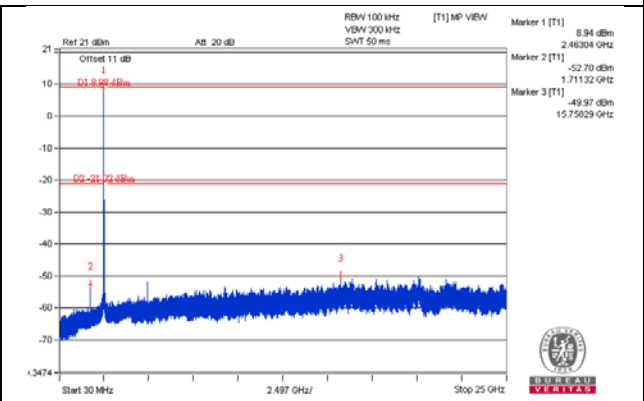
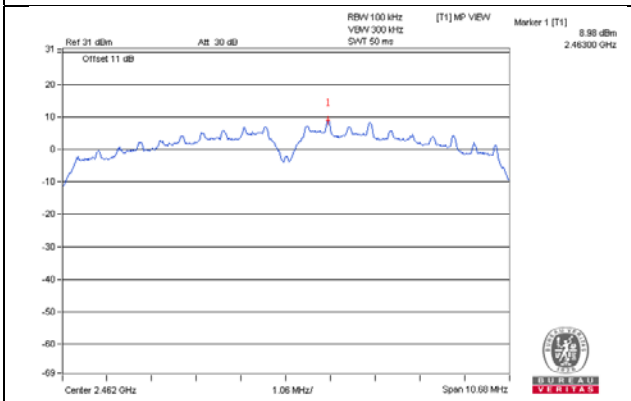

CH 1 Band edge

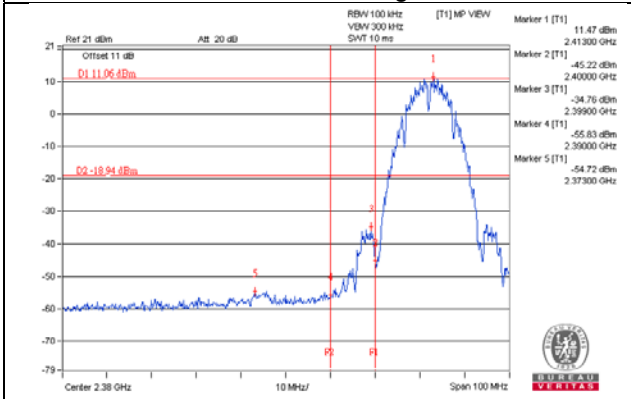

CH 11 Band edge

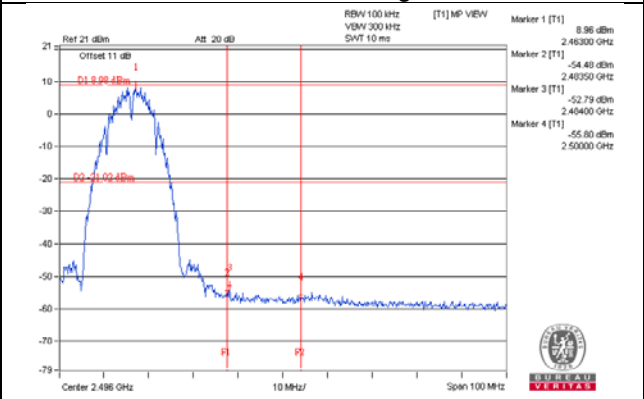

802.11b_Chain 3

CH 1

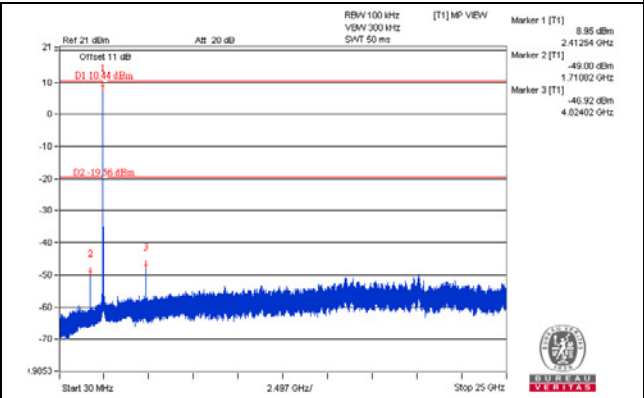
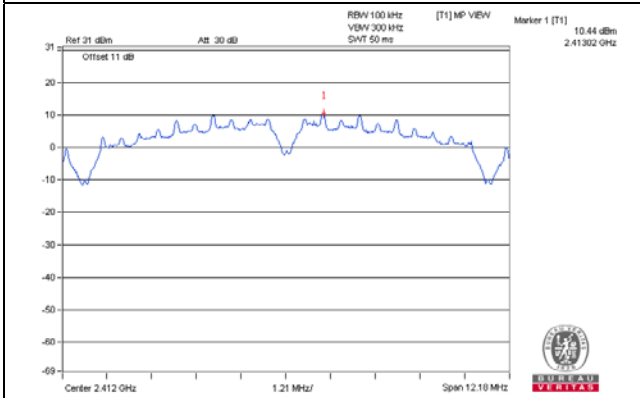

CH 6

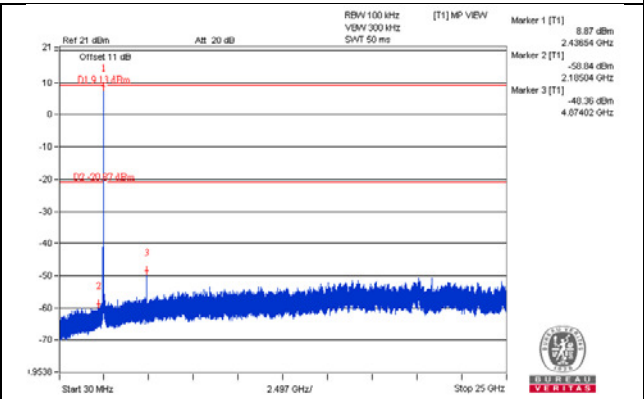
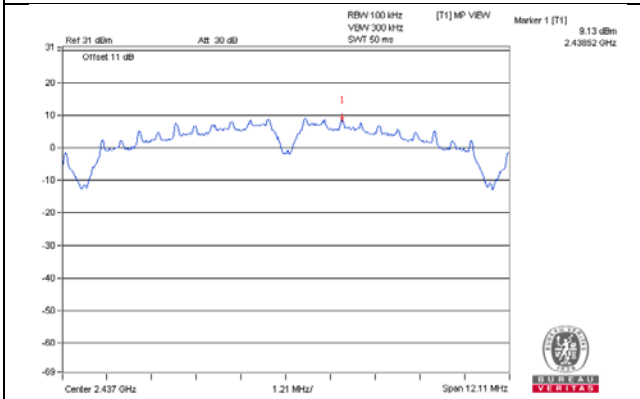

CH 11

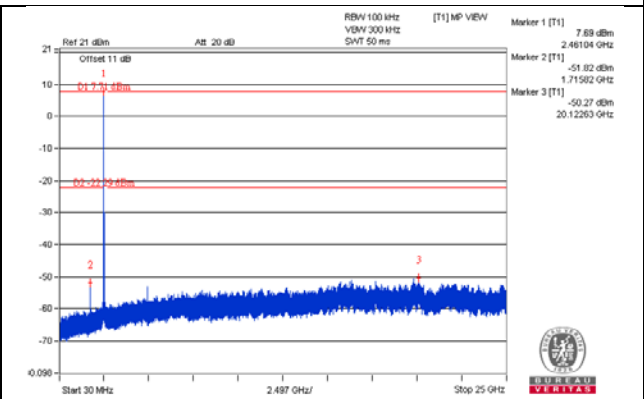
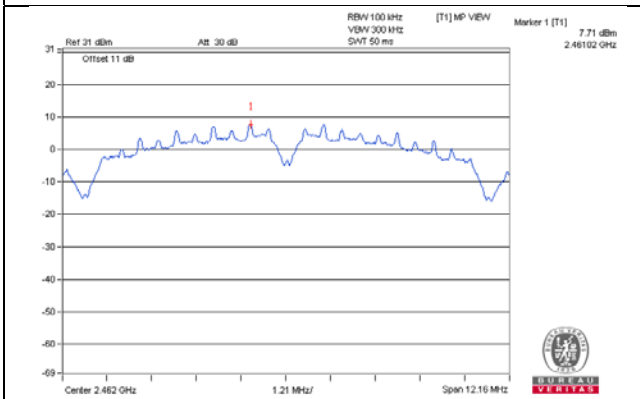

CH 1 Band edge

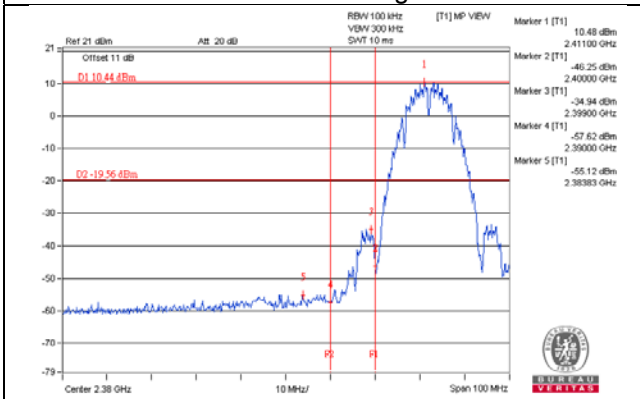

CH 11 Band edge

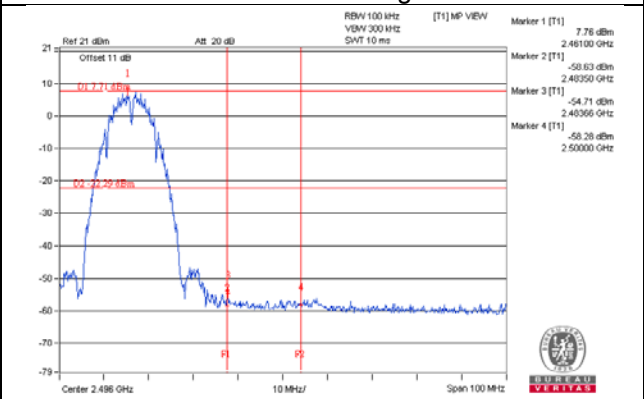

802.11g_Chain 0

CH 1

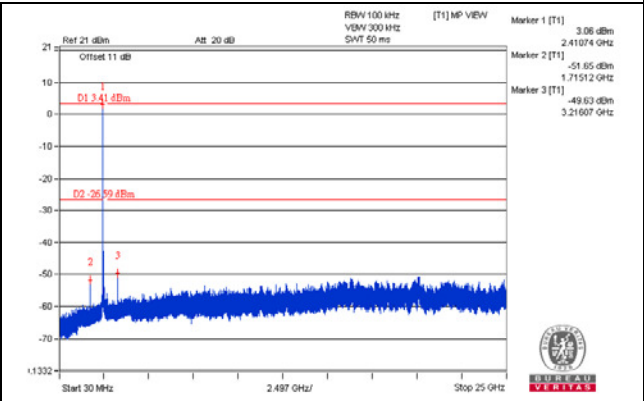
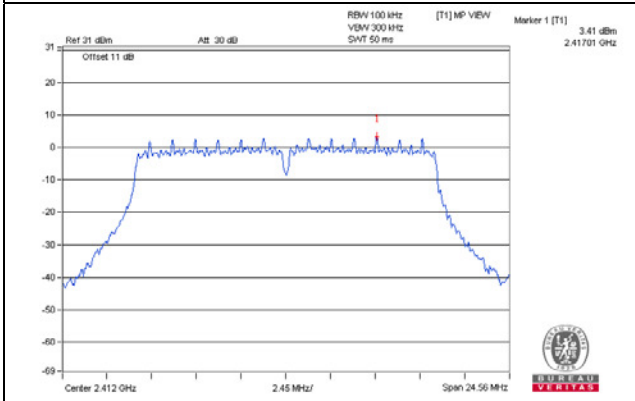

CH 6

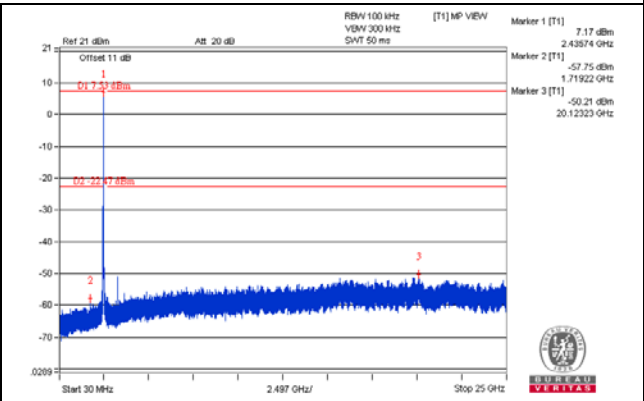
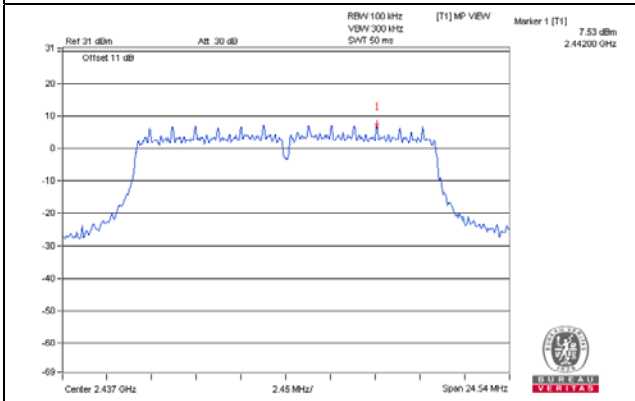

CH 11

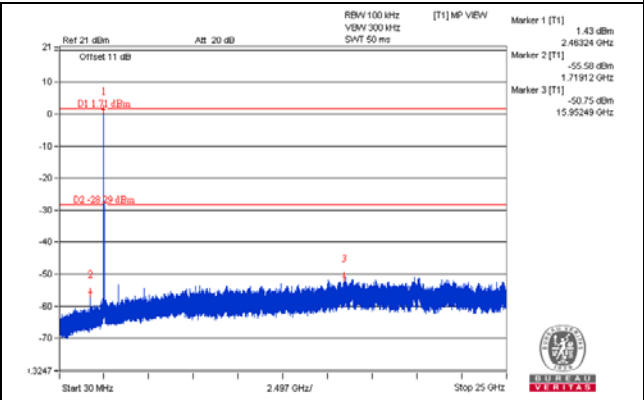
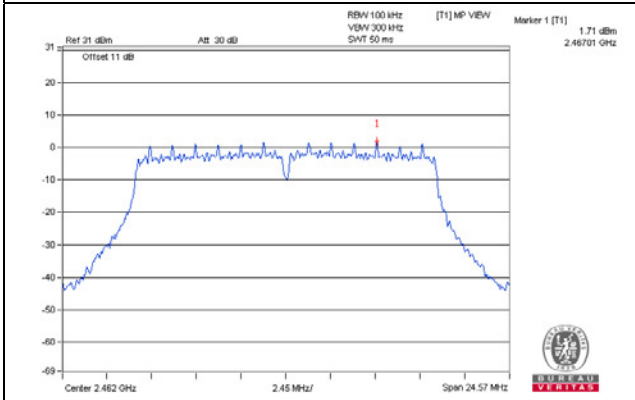

CH 1 Band edge

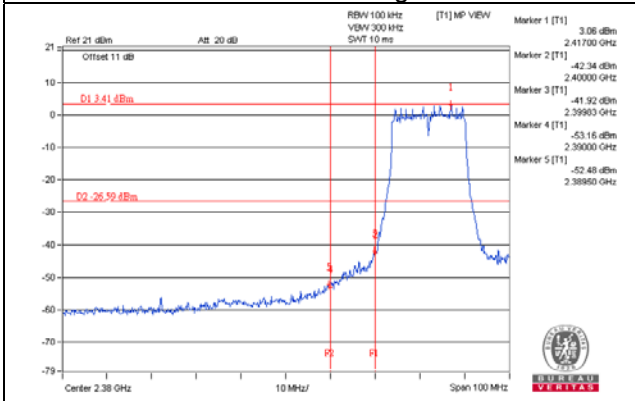

CH 11 Band edge

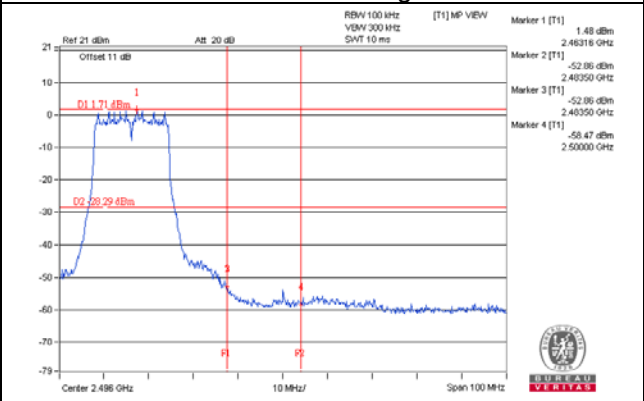

802.11g_Chain 1

CH 1

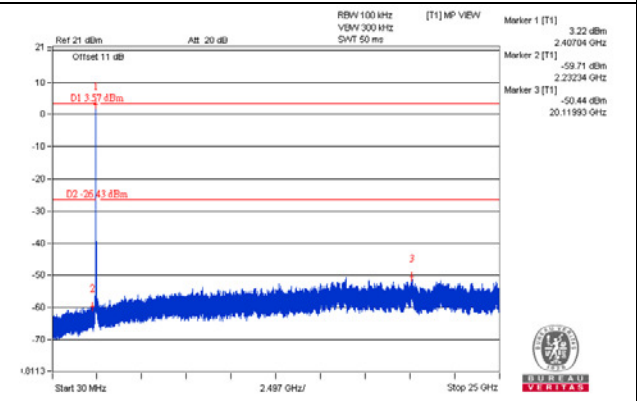
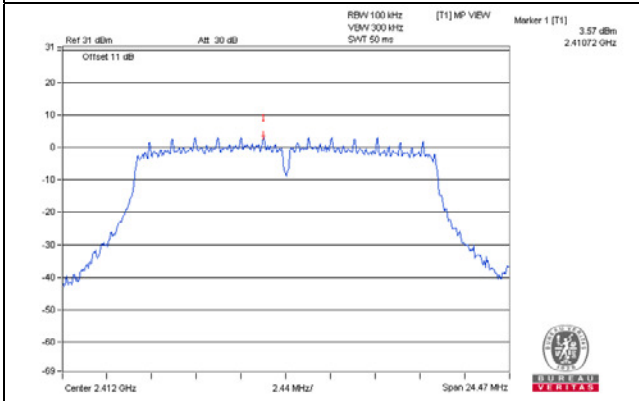

CH 6

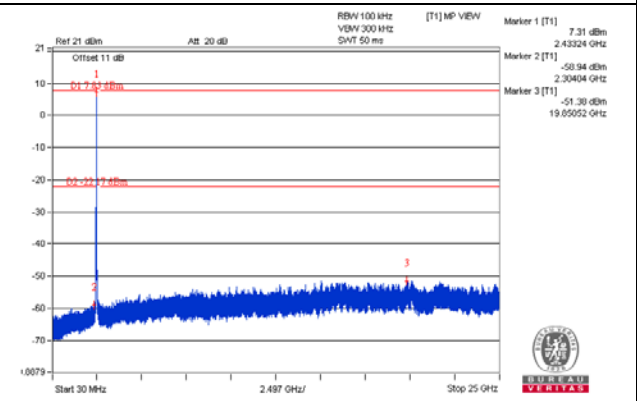
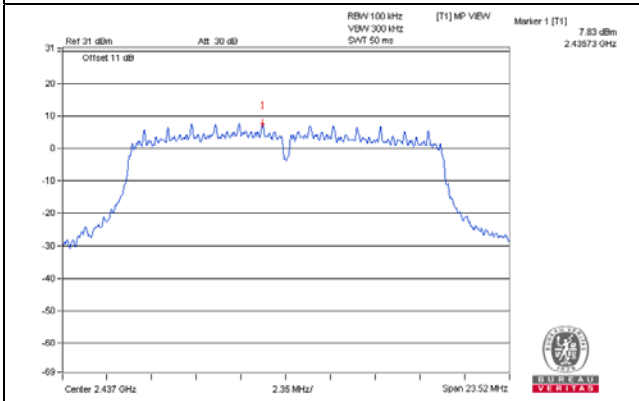

CH 11

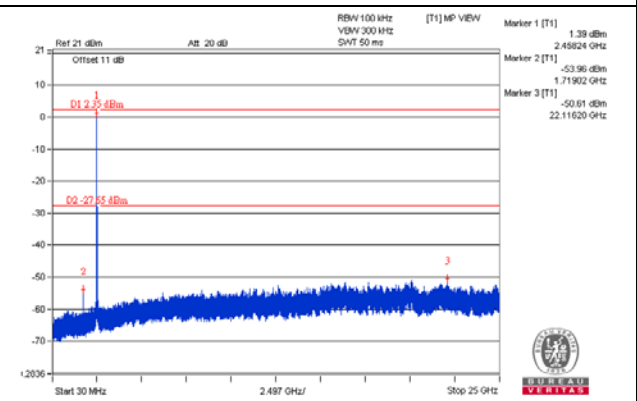
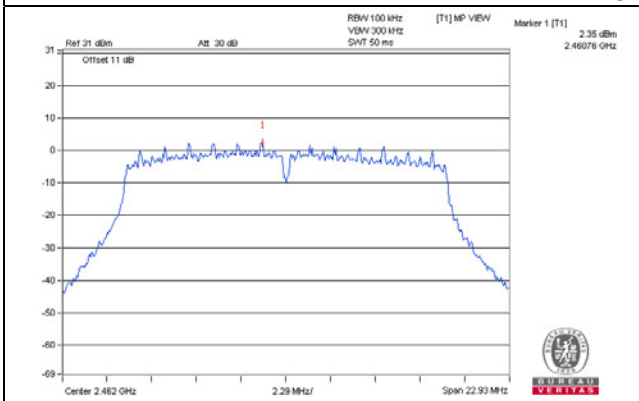

CH 1 Band edge

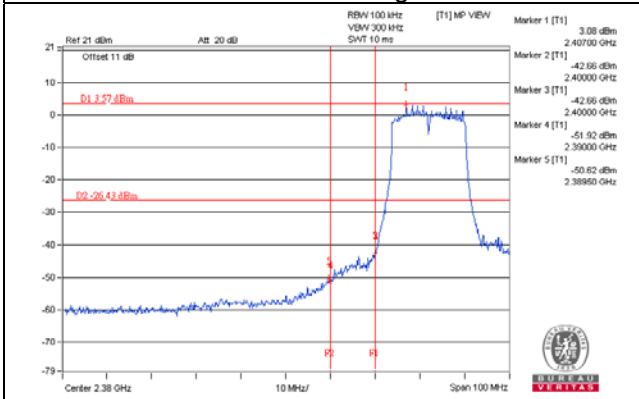

CH 11 Band edge

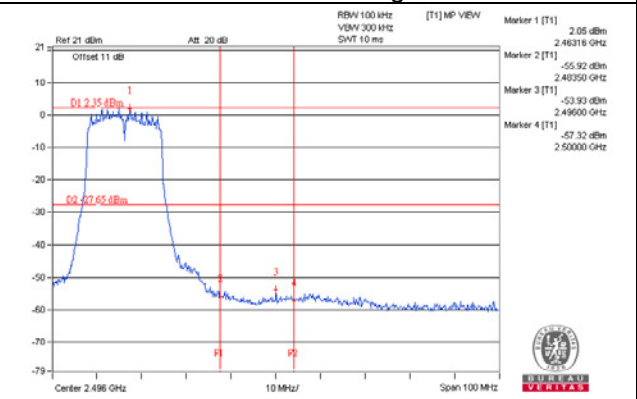

802.11g_Chain 2

CH 1

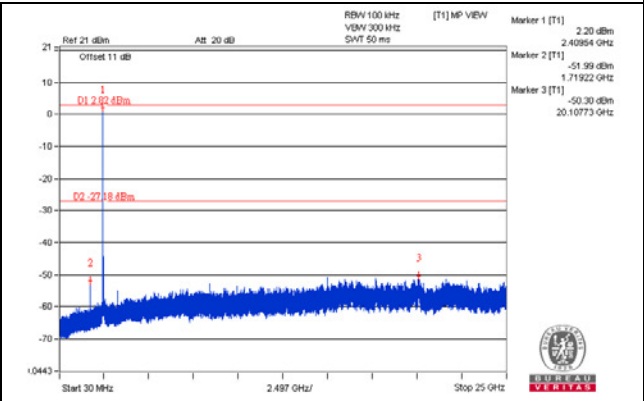
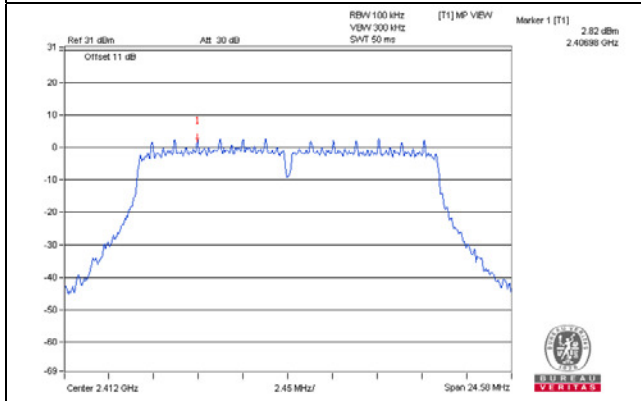

CH 6

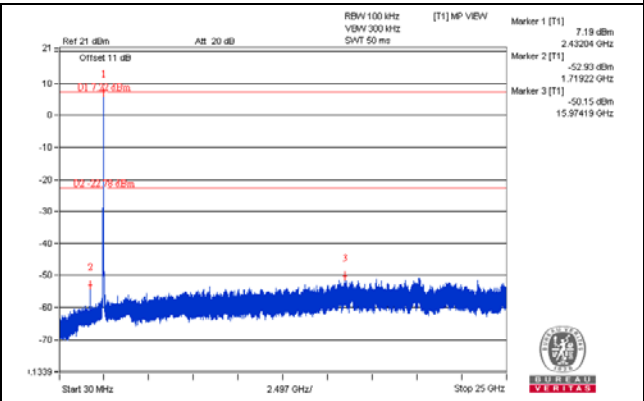
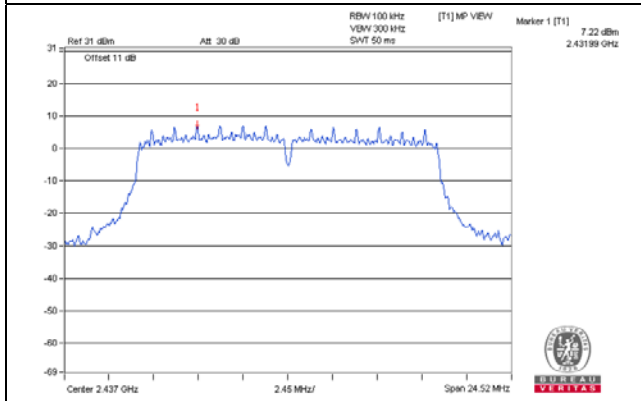

CH 11

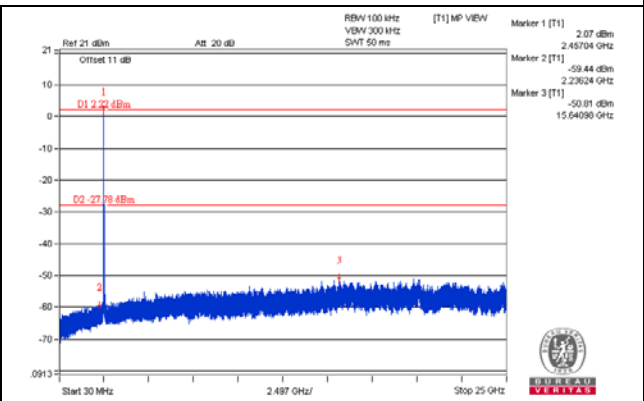
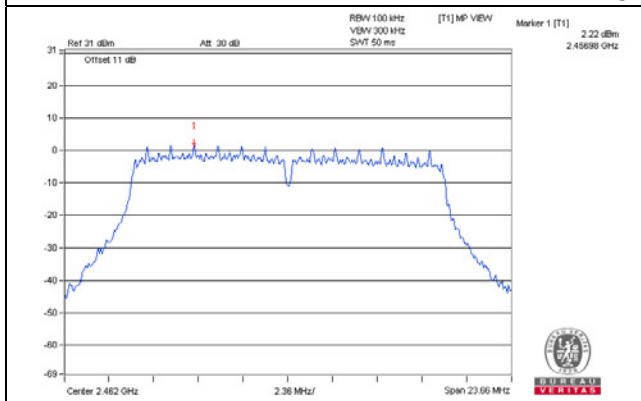

CH 1 Band edge

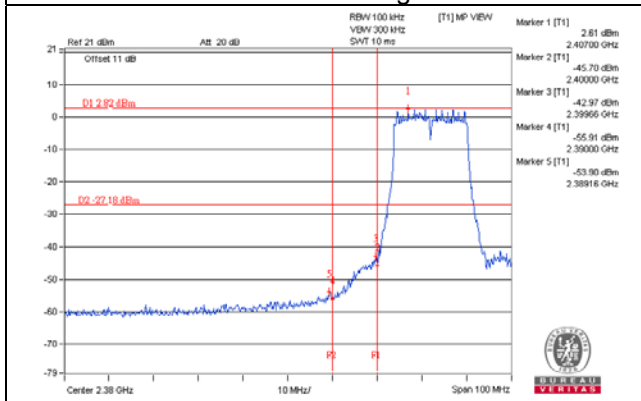

CH 11 Band edge

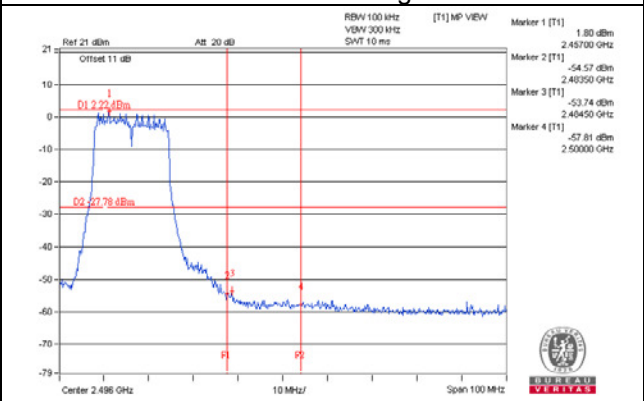

802.11g_Chain 3

CH 1

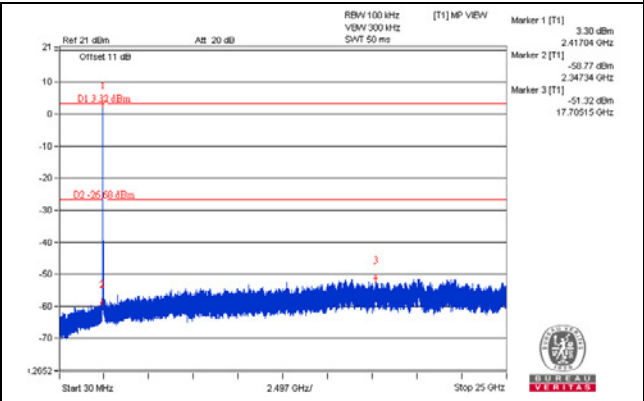
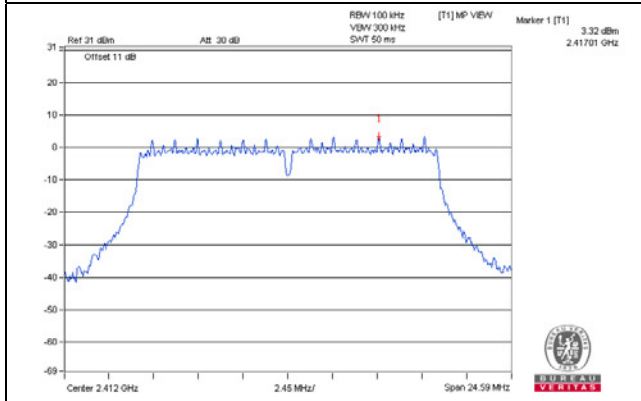

CH 6

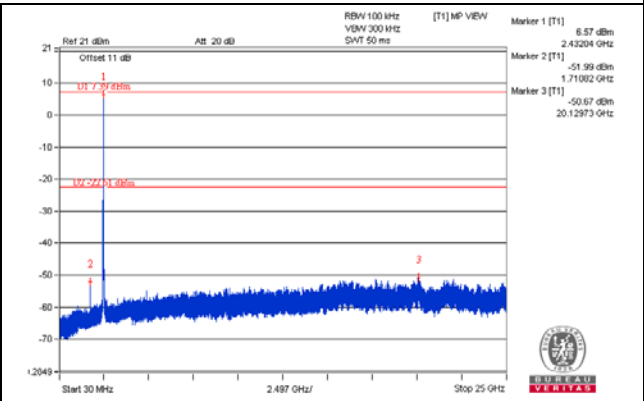
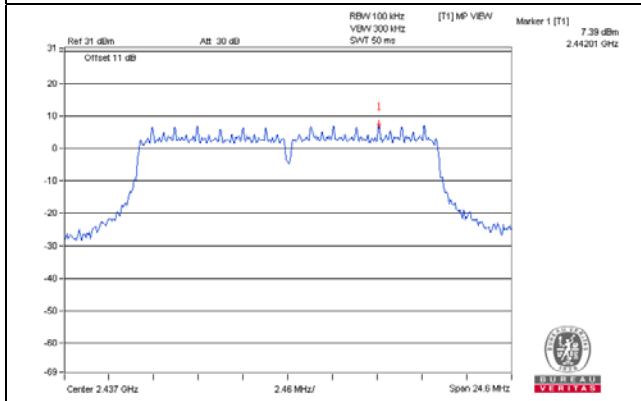

CH 11

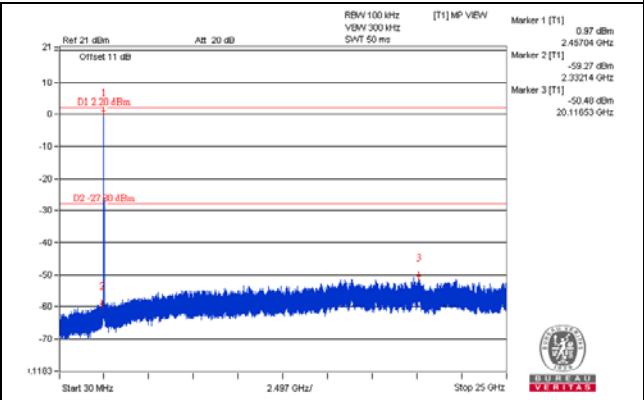
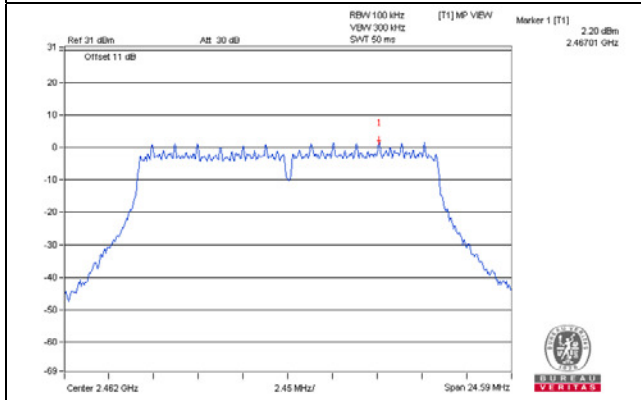

CH 1 Band edge

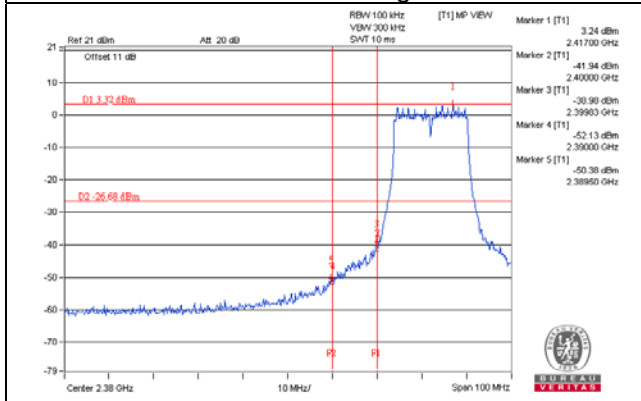

CH 11 Band edge

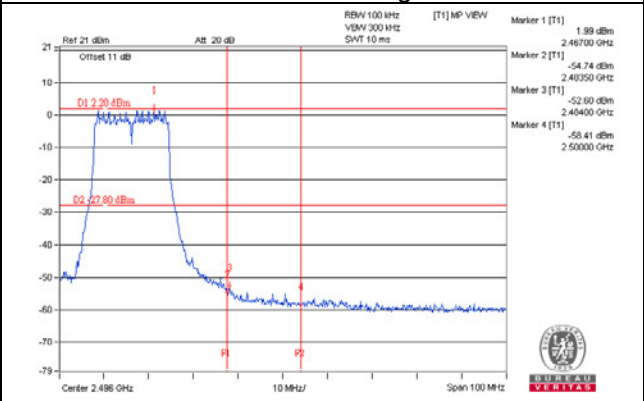

802.11n (HT20)_Chain 0

CH 1

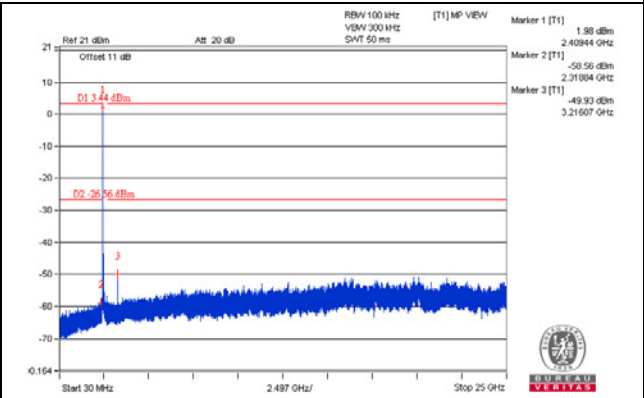
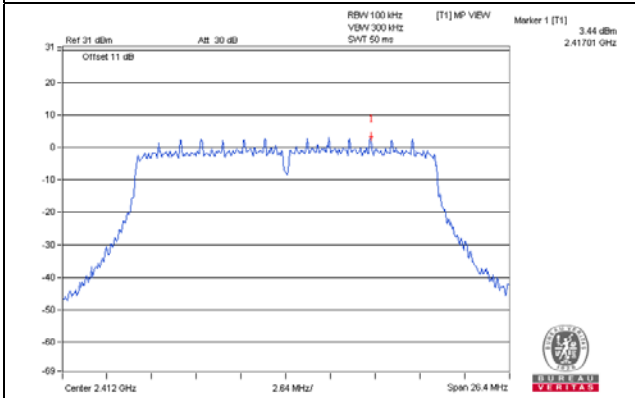

CH 6

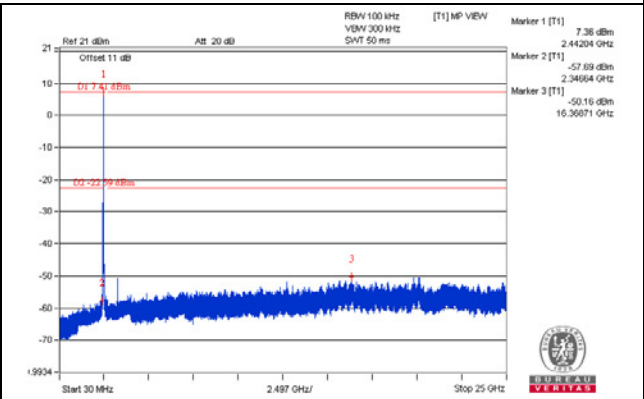
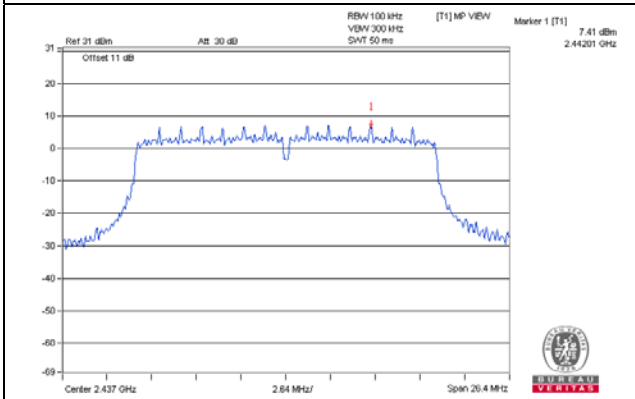

CH 11

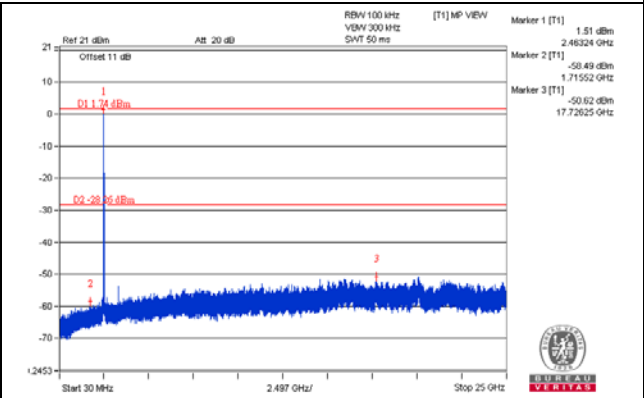
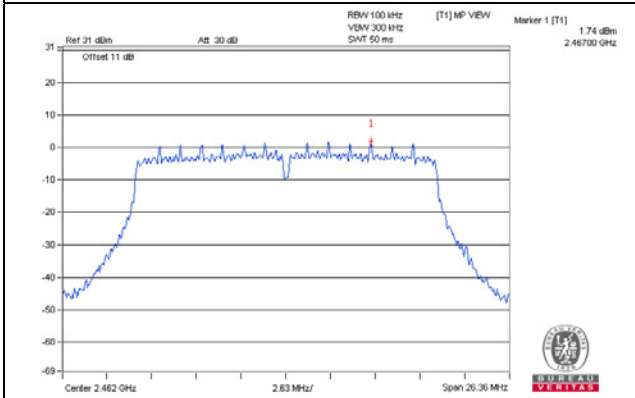

CH 1 Band edge

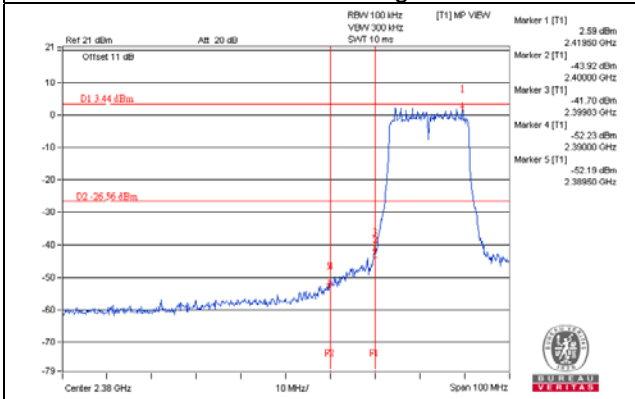

CH 11 Band edge

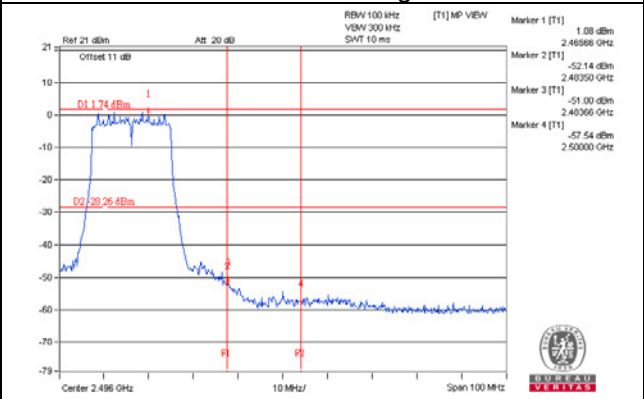

802.11n (HT20)_Chain 1

CH 1

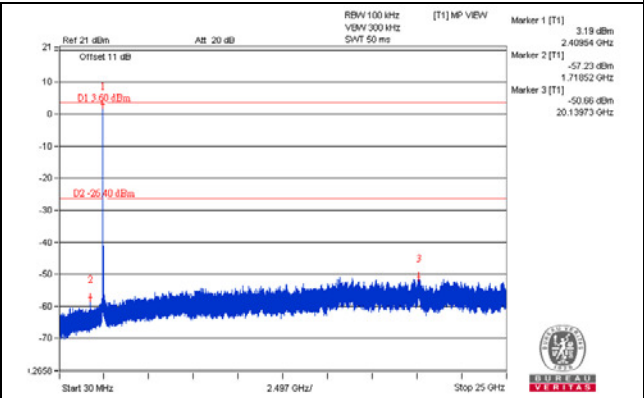
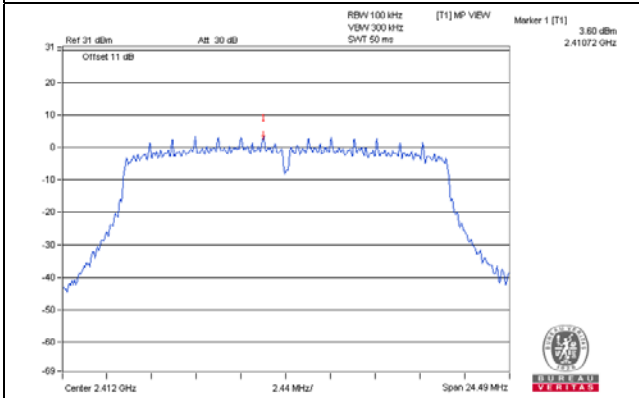

CH 6

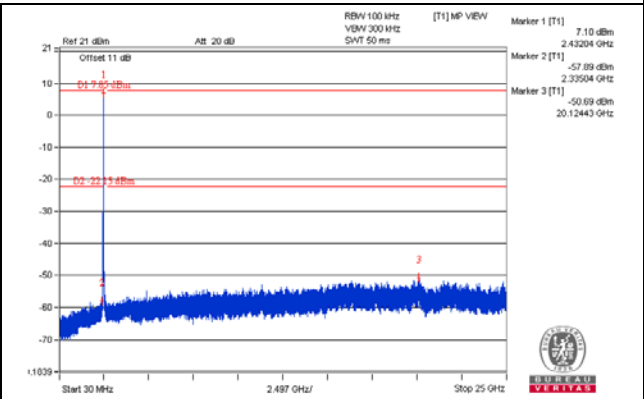
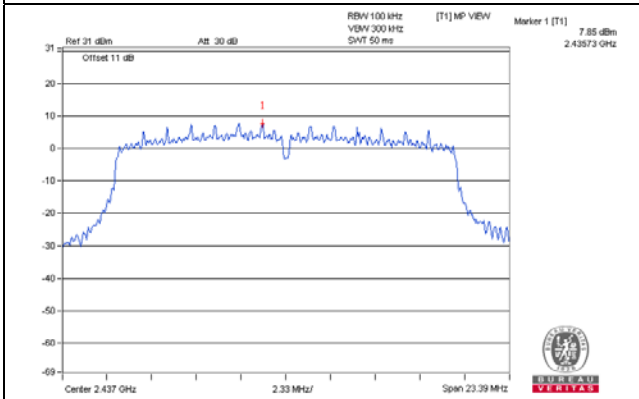

CH 11

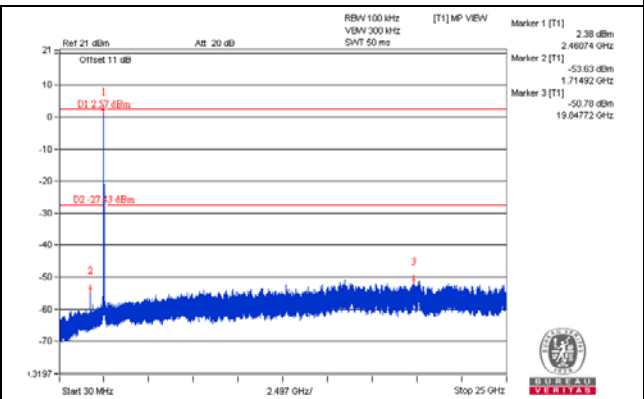
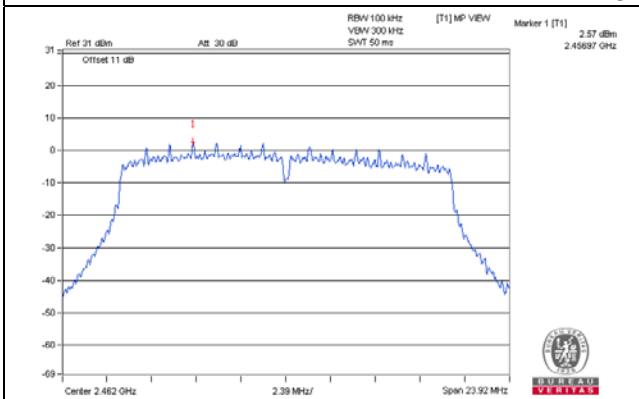

CH 1 Band edge

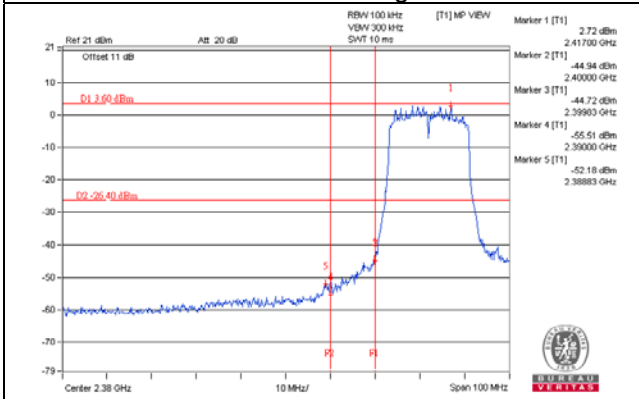

CH 11 Band edge

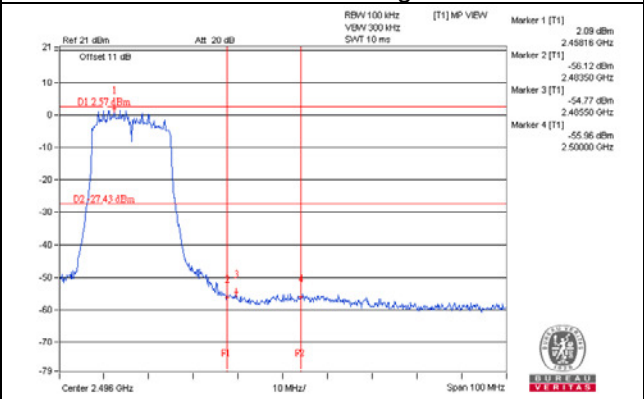

802.11n (HT20)_Chain 2

CH 1

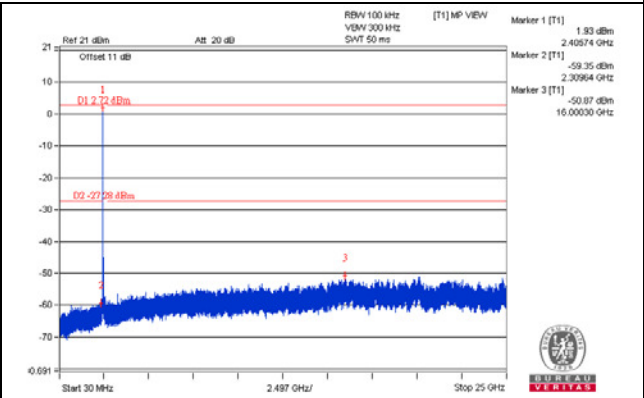
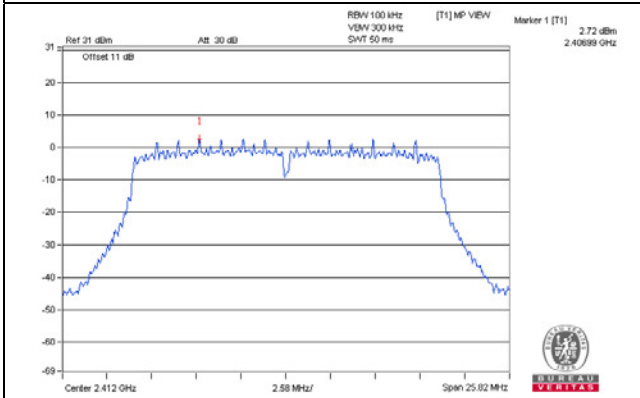

CH 6

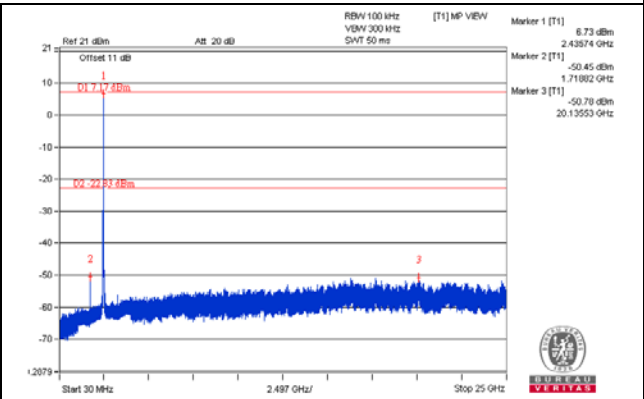
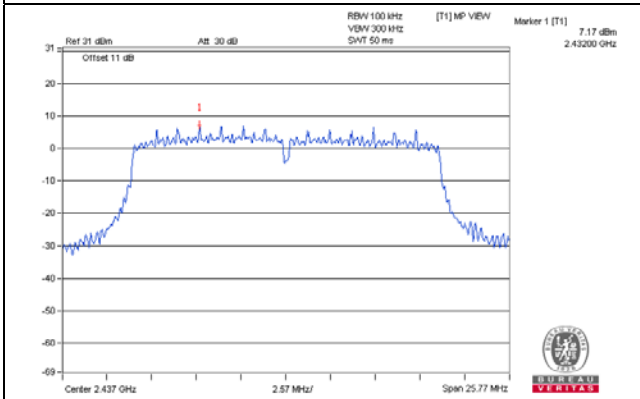

CH 11

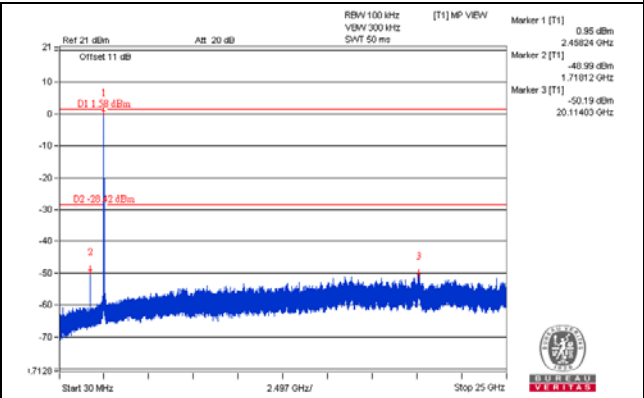
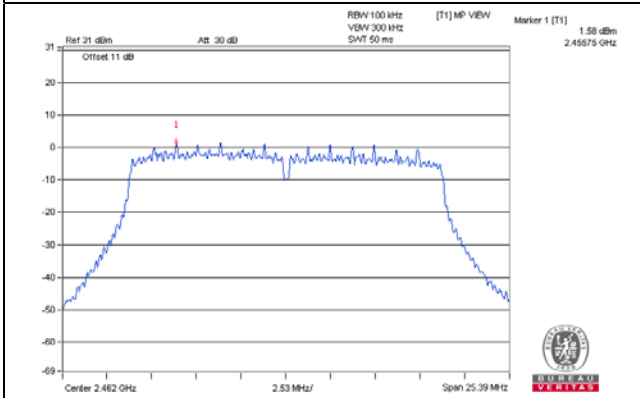

CH 1 Band edge

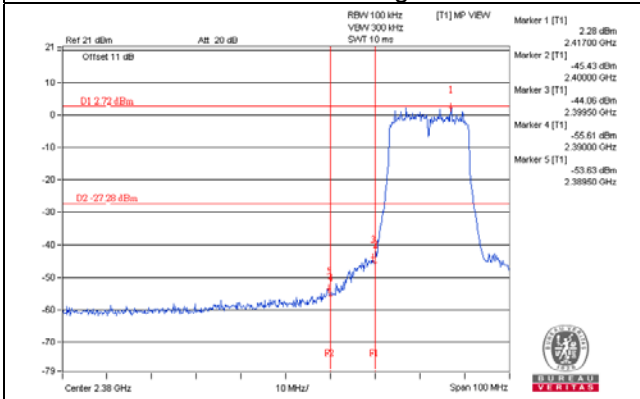

CH 11 Band edge

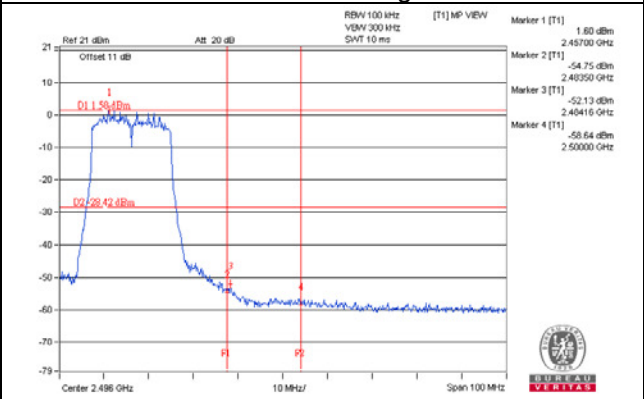

802.11n (HT20)_Chain 3

CH 1

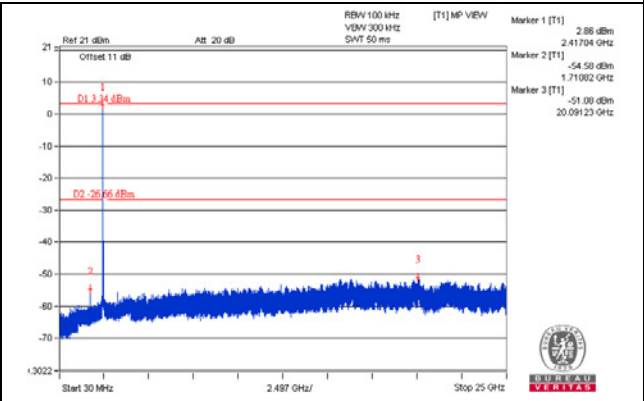
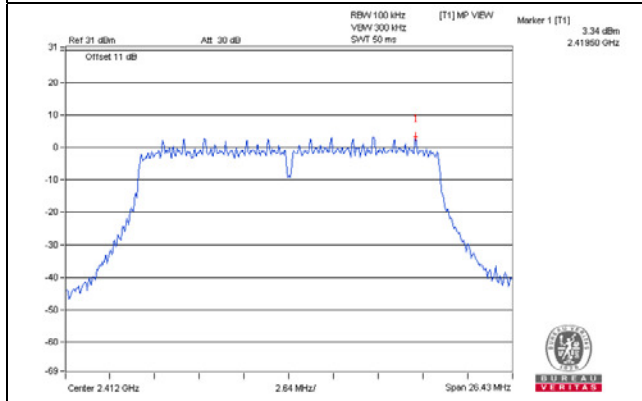

CH 6

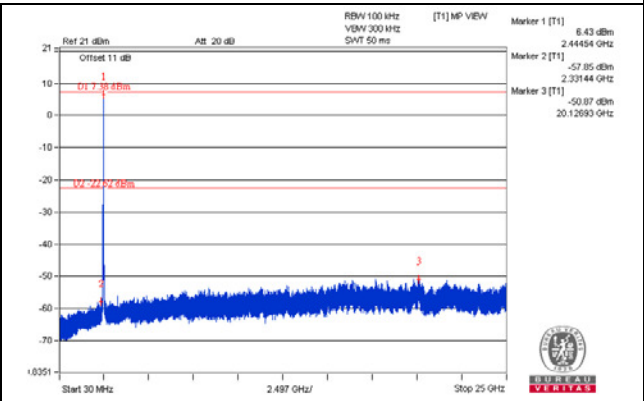
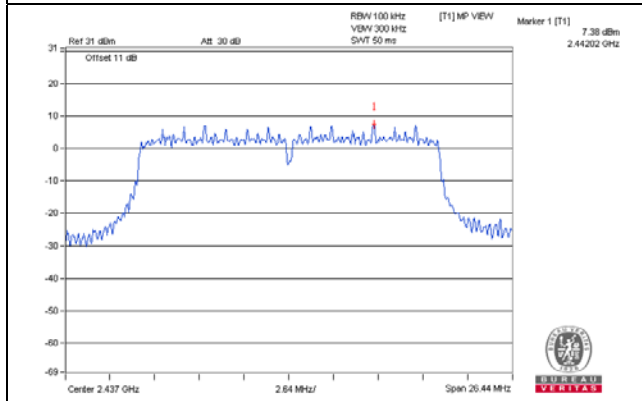

CH 11

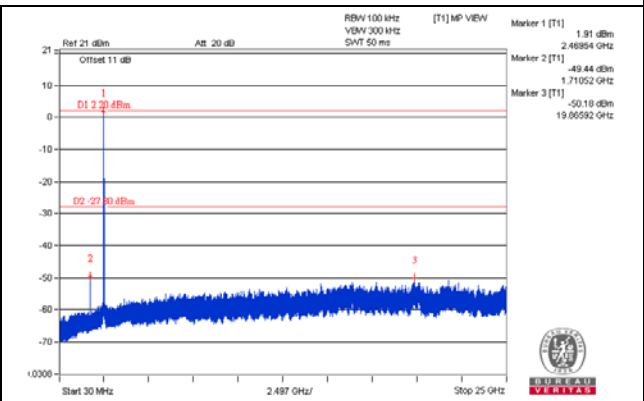
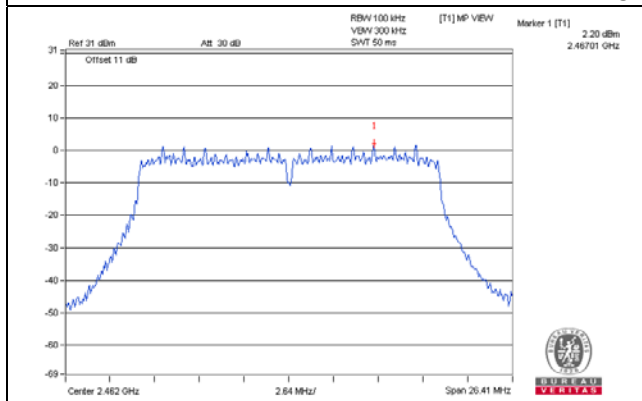

CH 1 Band edge

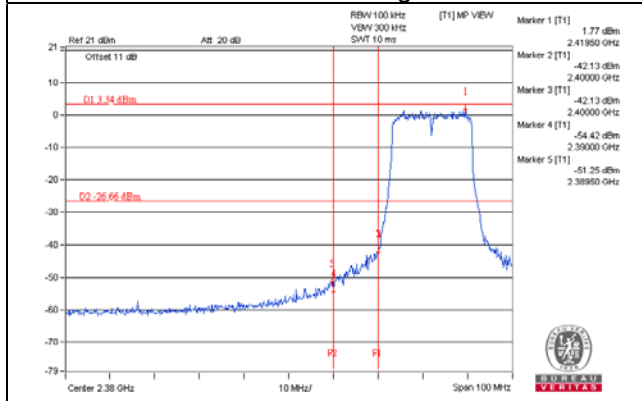

CH 11 Band edge

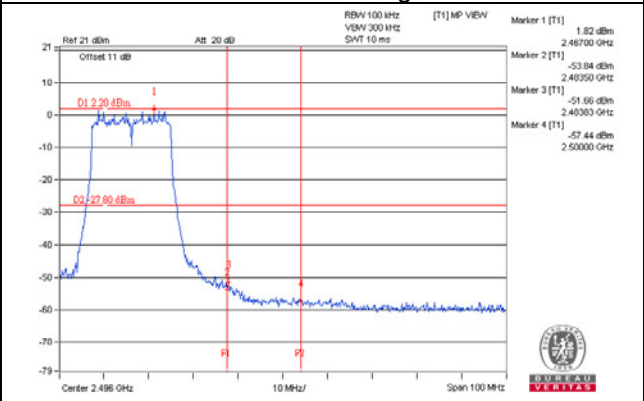

802.11n (HT40)_Chain 0

CH 3

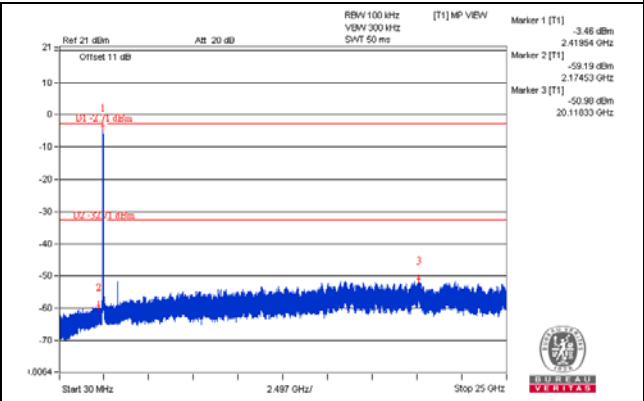
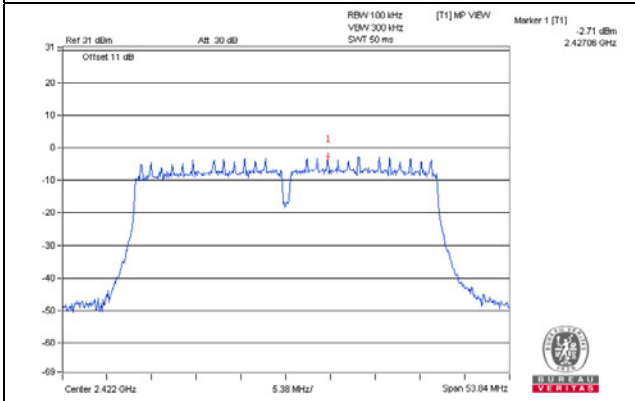

CH 6

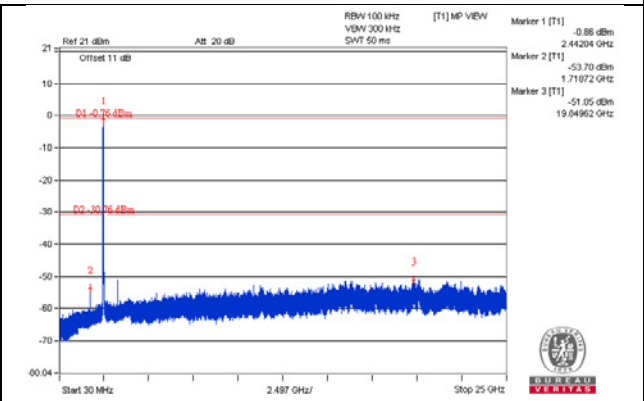
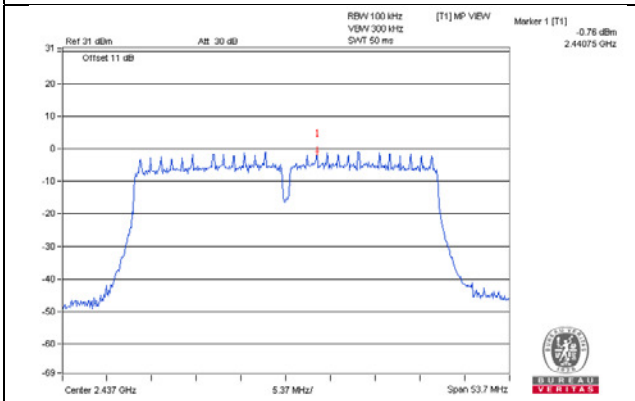

CH 9

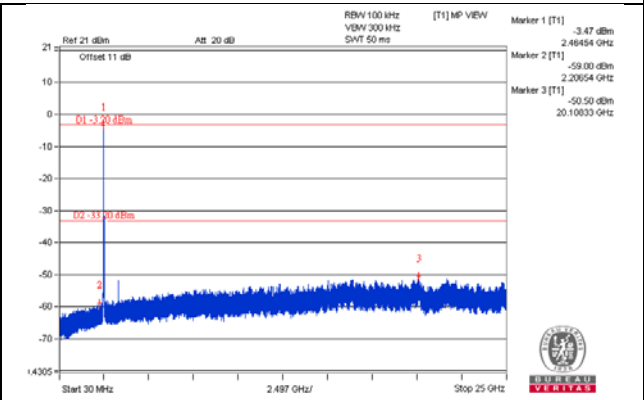
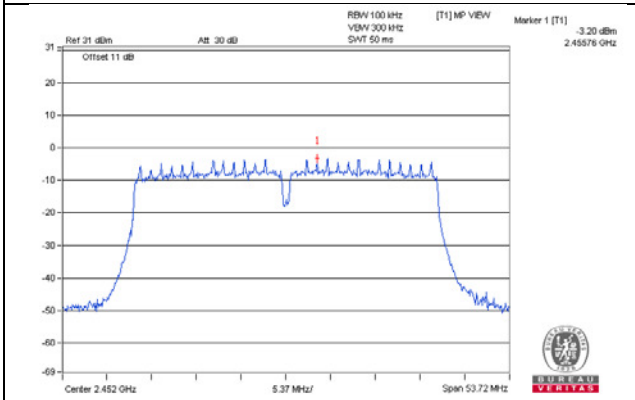

CH 3 Band edge

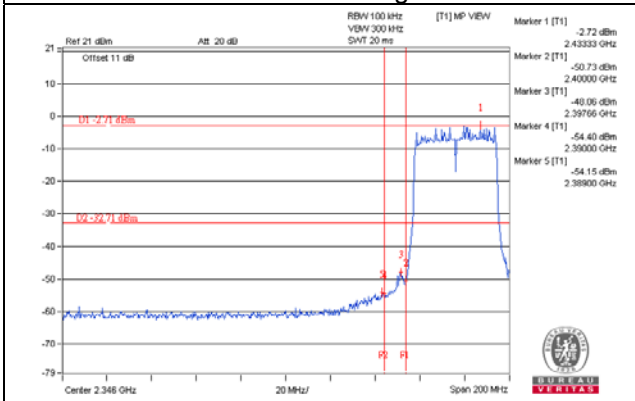

CH 9 Band edge

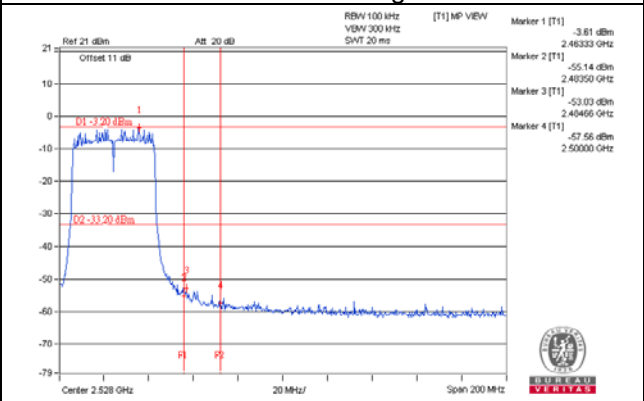

802.11n (HT40)_Chain 1

CH 3

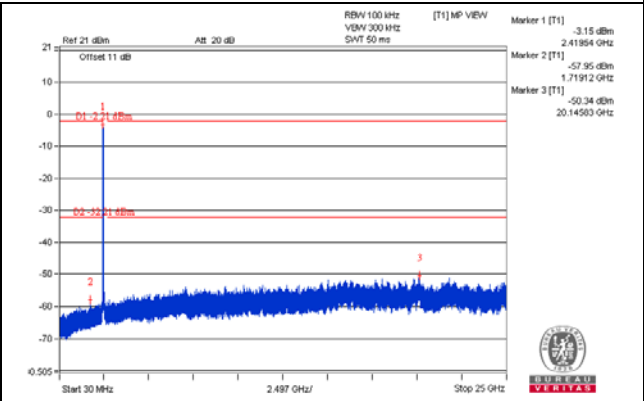
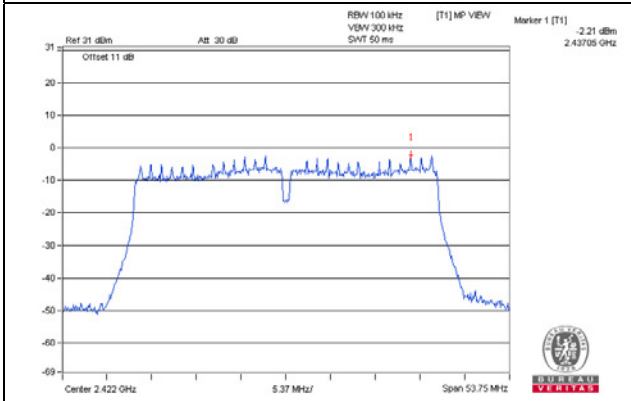

CH 6

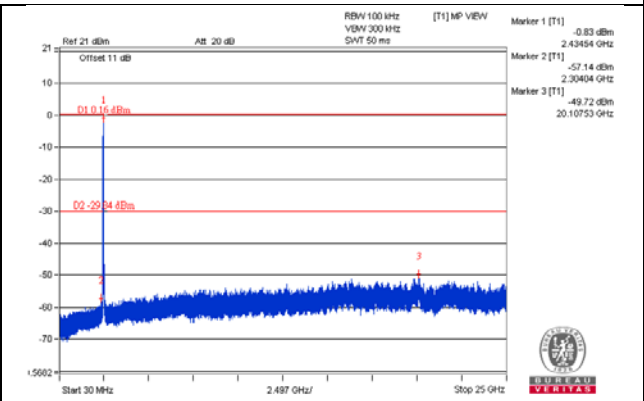
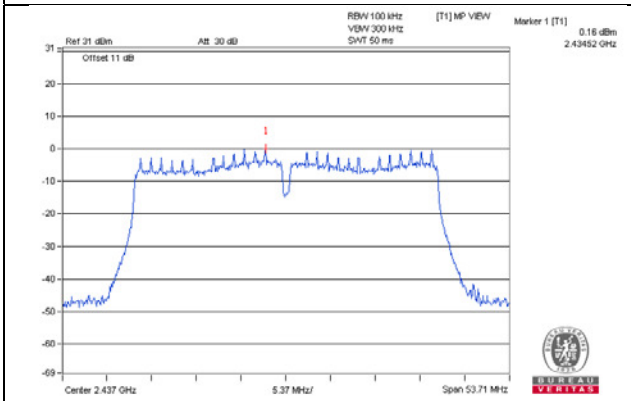

CH 9

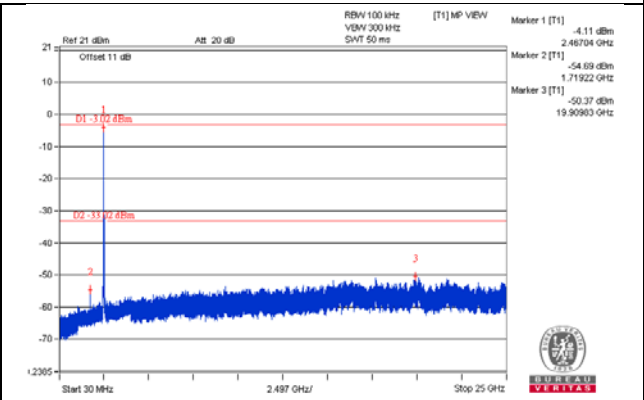
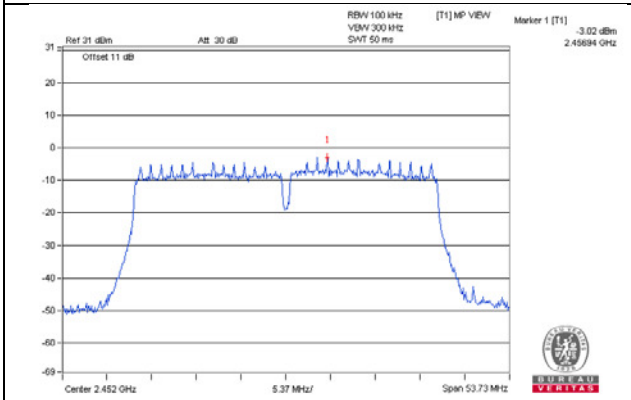

CH 3 Band edge

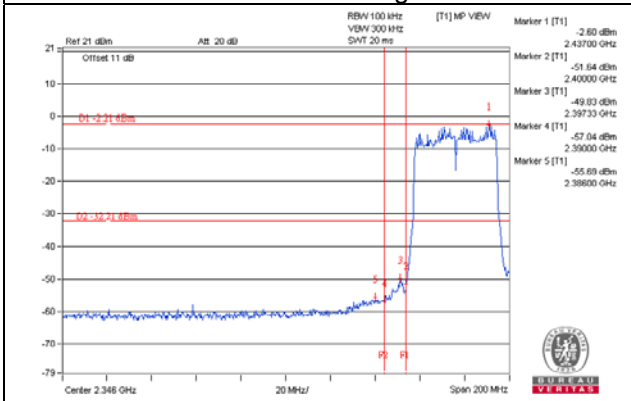

CH 9 Band edge

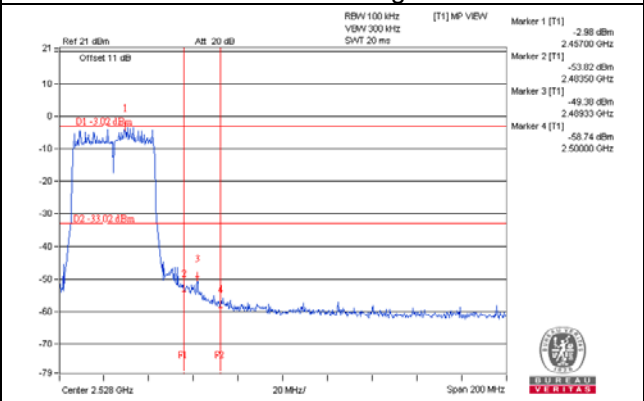

802.11n (HT40)_Chain 2

CH 3

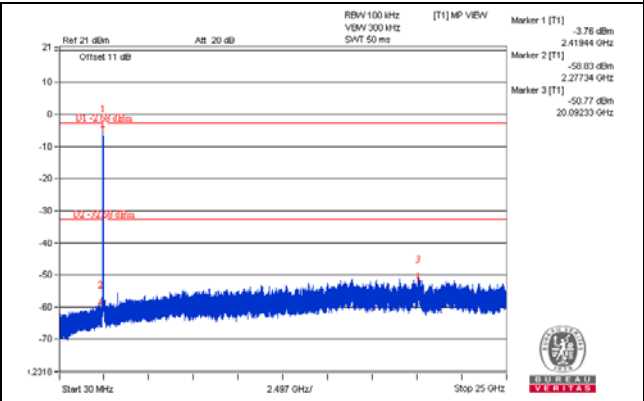
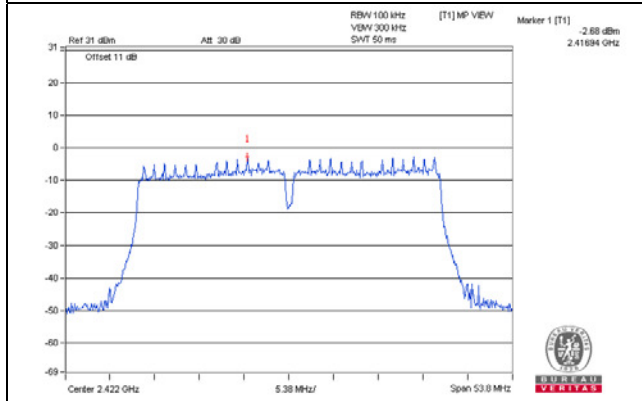

CH 6

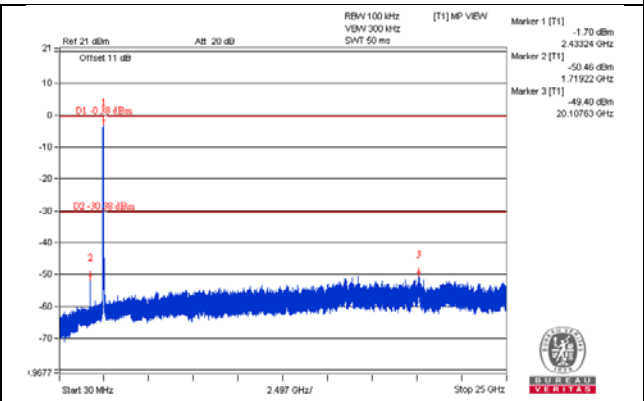
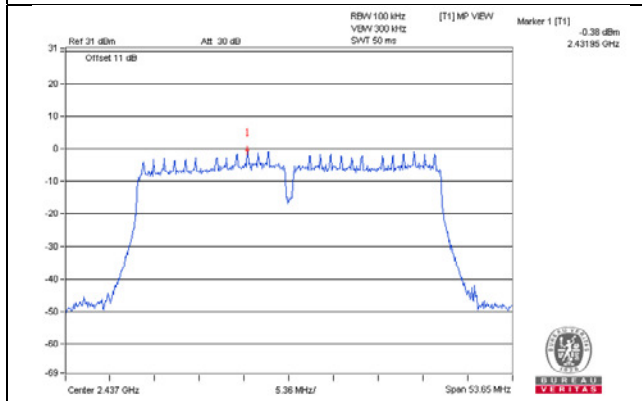

CH 9

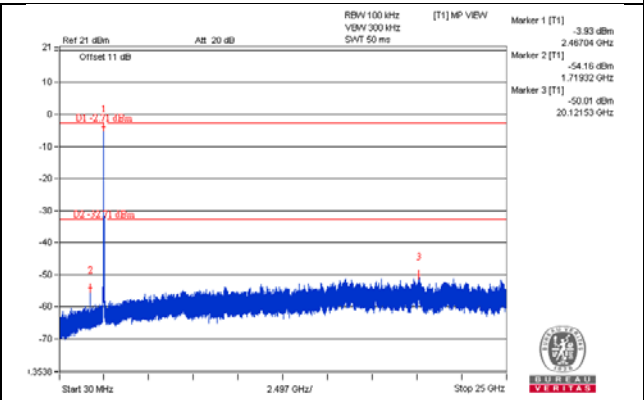
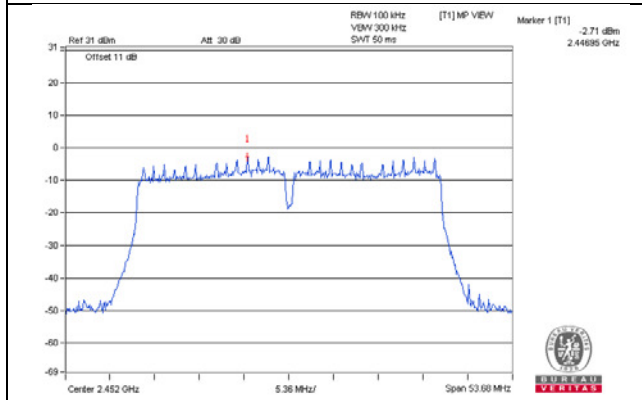

CH 3 Band edge

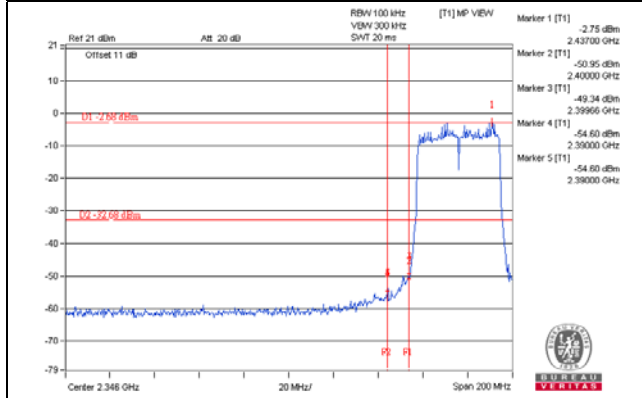

CH 9 Band edge

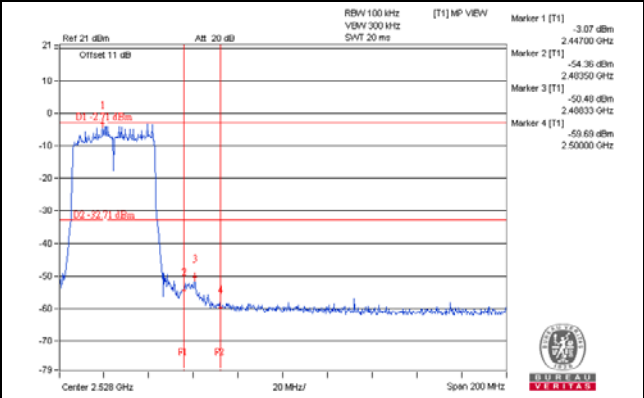

802.11n (HT40)_Chain 3

CH 3

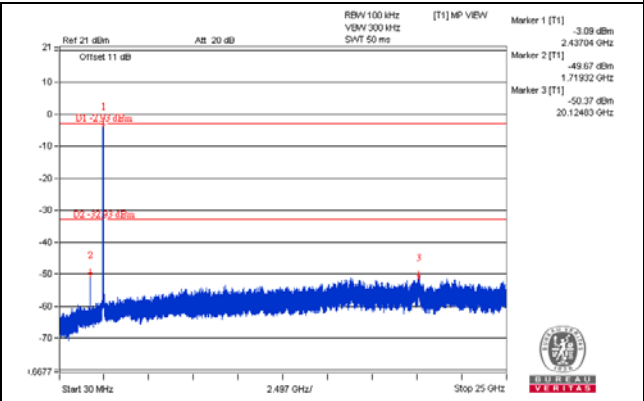
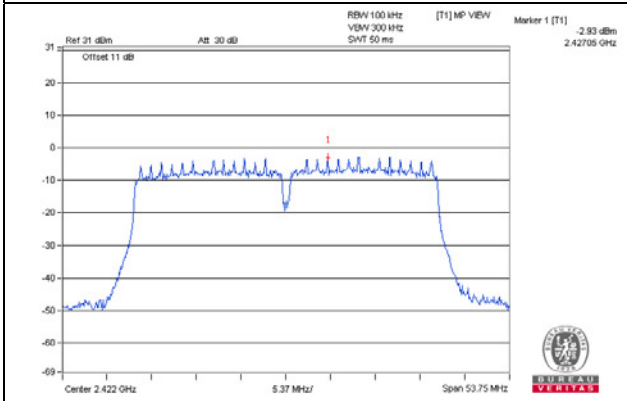

CH 6

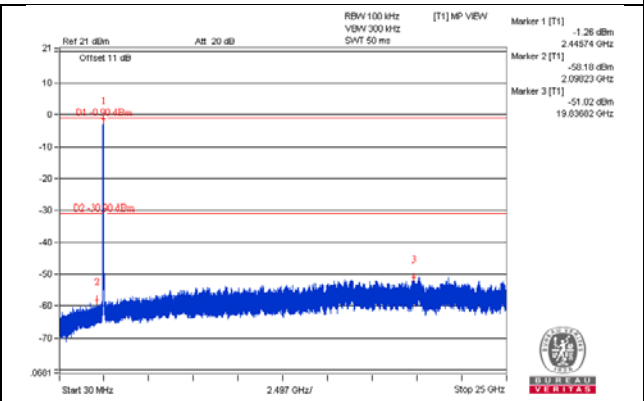
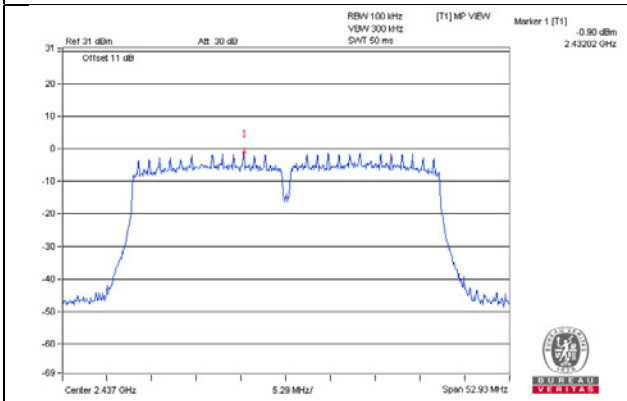

CH 9

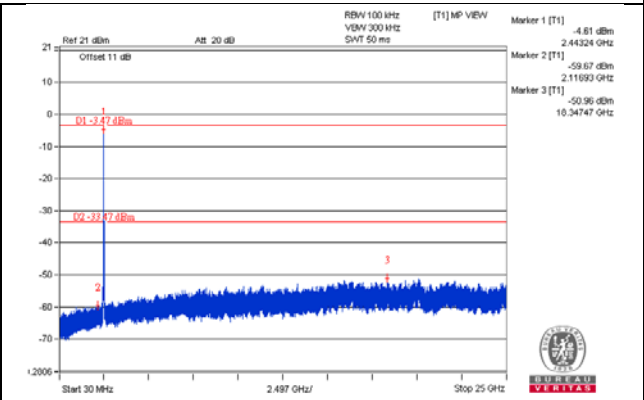
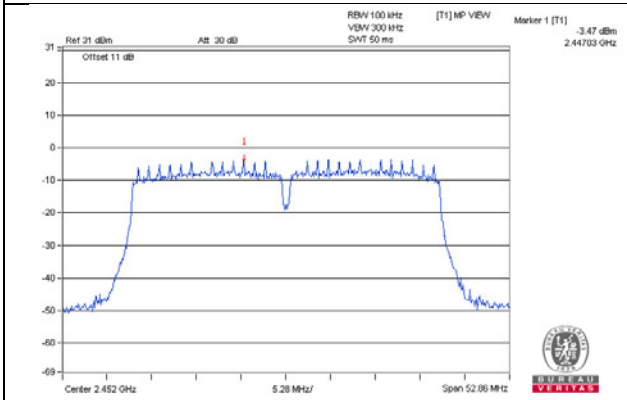

CH 3 Band edge

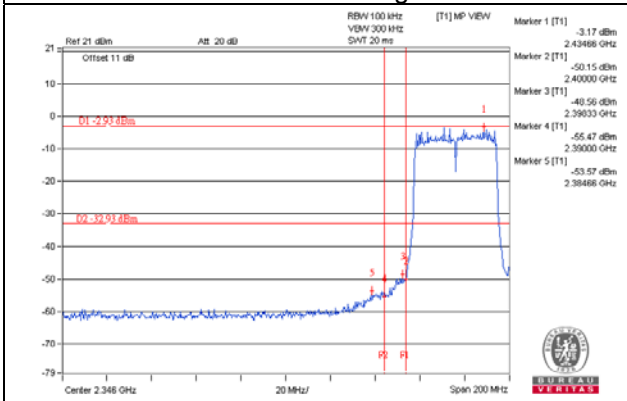

CH 9 Band edge

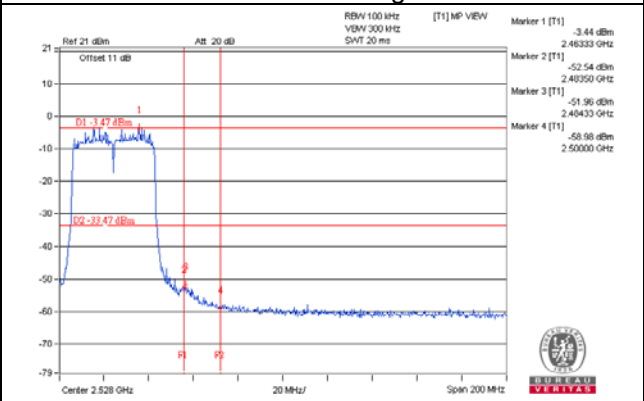

Radio 3: CDD Mode
802.11b

CH 1

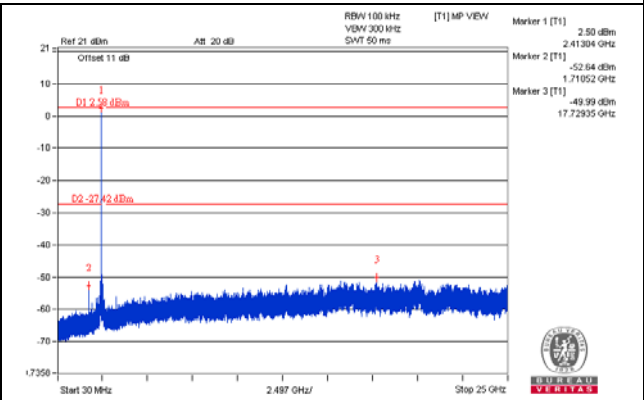
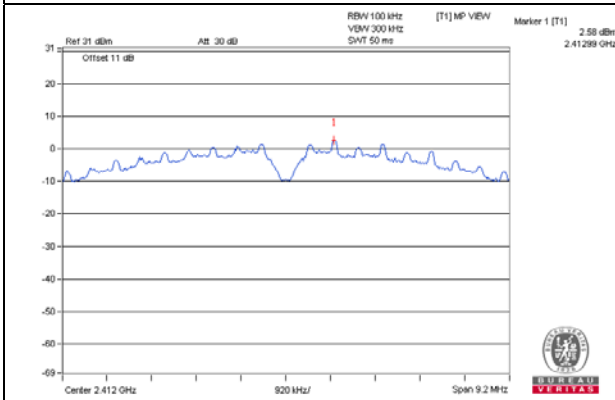

CH 6

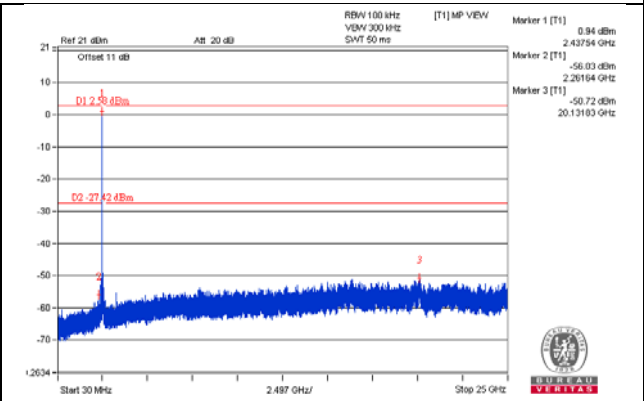
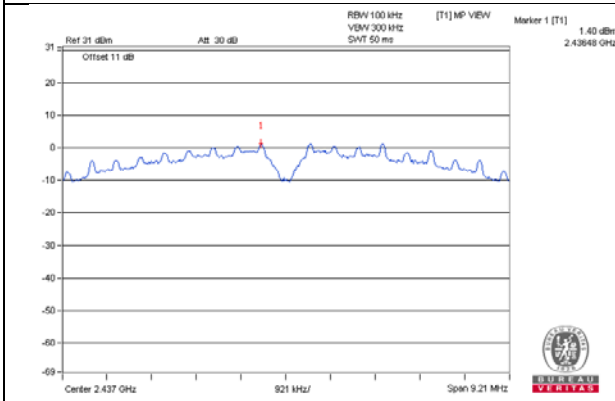

CH 11

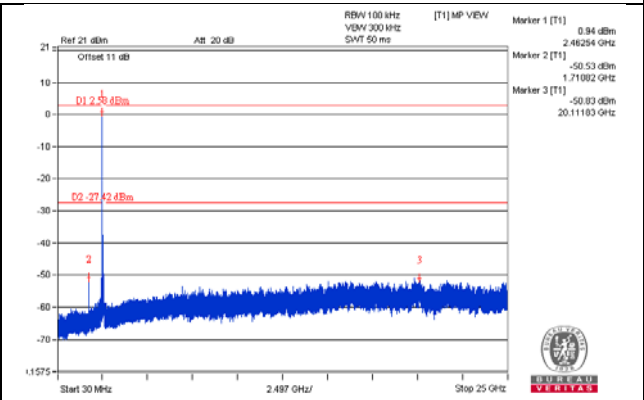
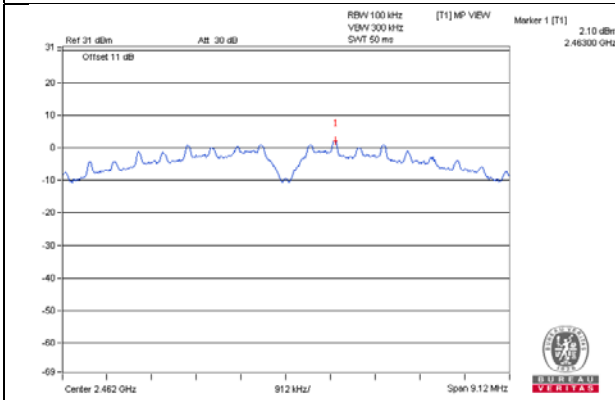

CH 1 Band edge

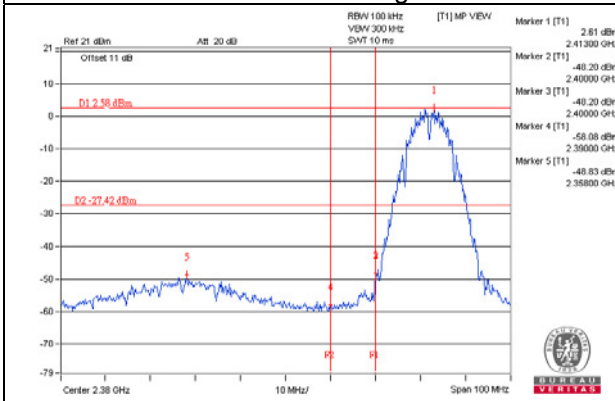

CH 11 Band edge

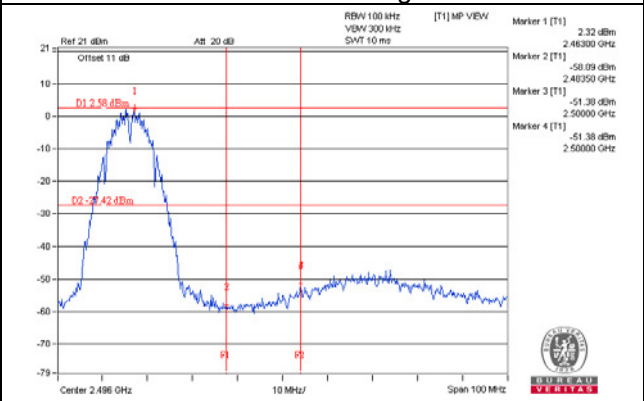

Note: Chosen the highest reference level for band edge limit.

802.11g

CH 1

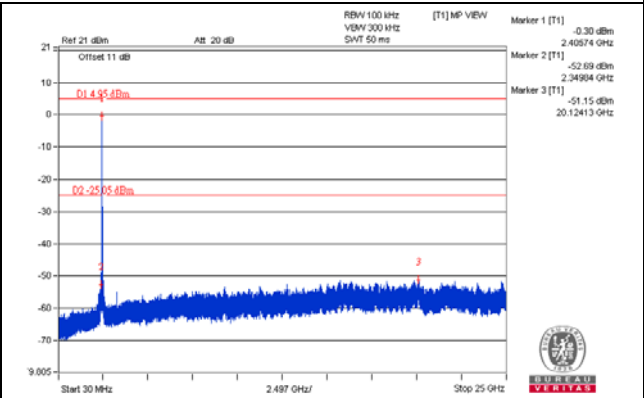
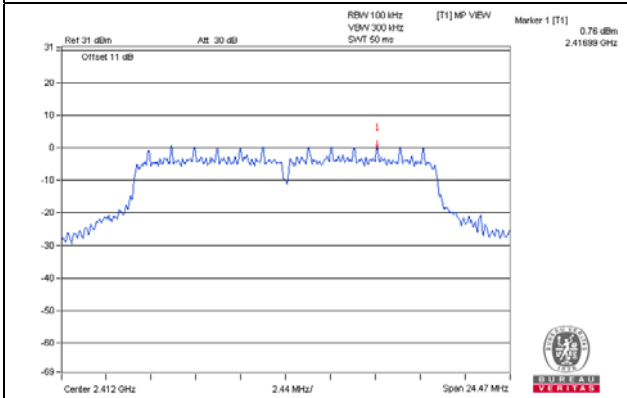

CH 6

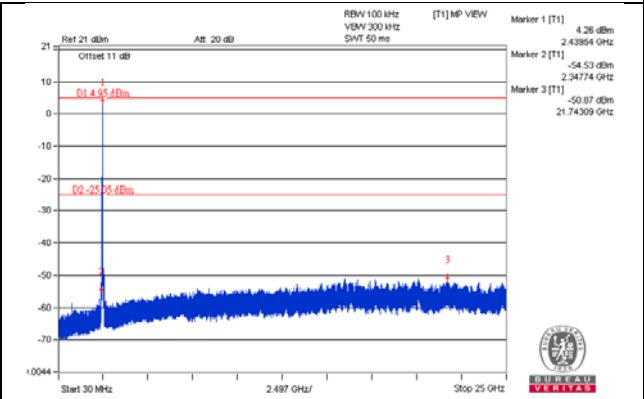
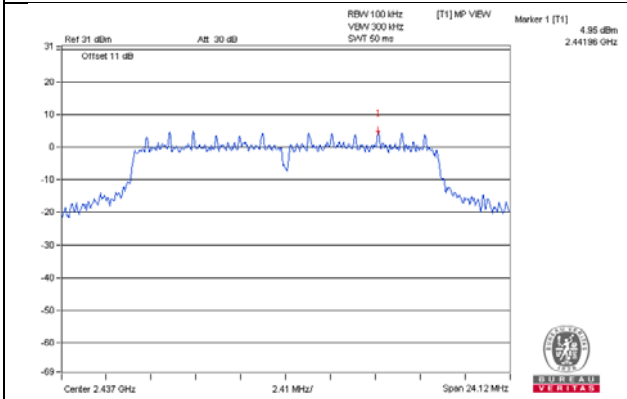

CH 11

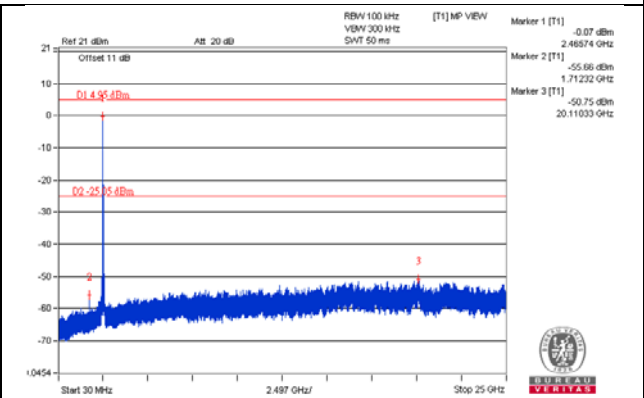
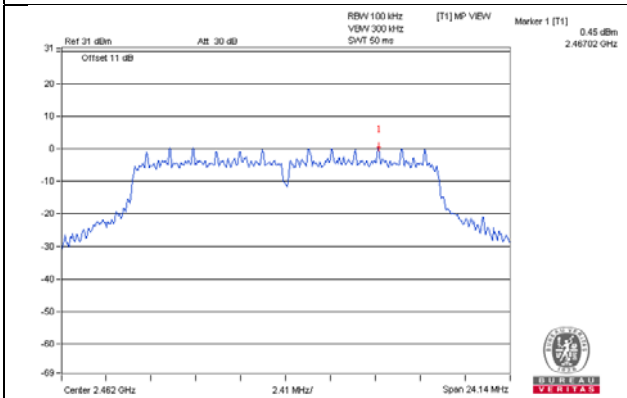

CH 1 Band edge

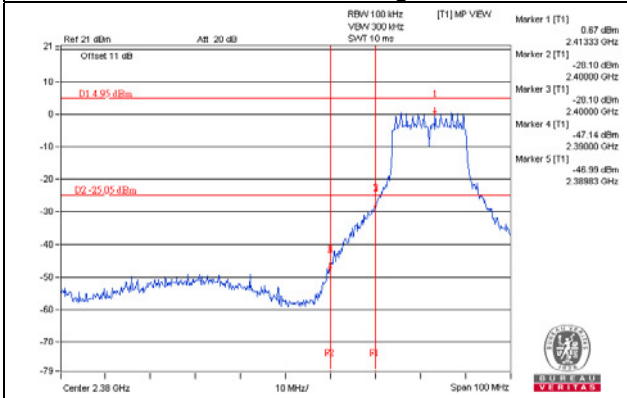

CH 11 Band edge

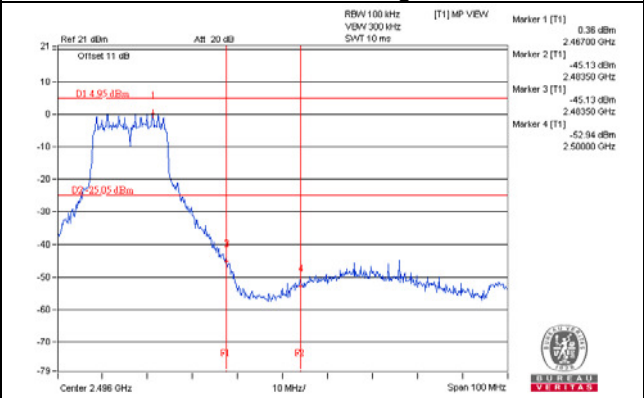

Note: Chosen the highest reference level for band edge limit.

802.11n (HT20)

CH 1

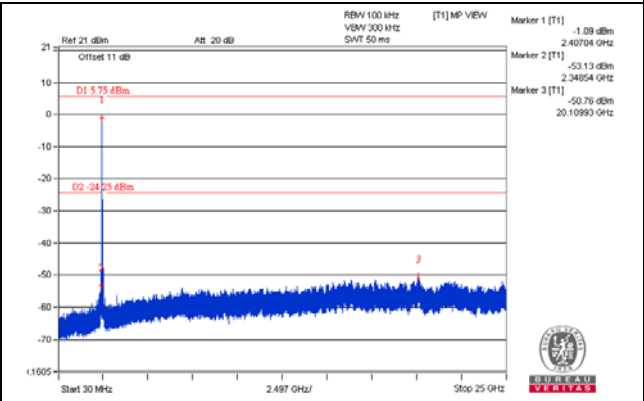
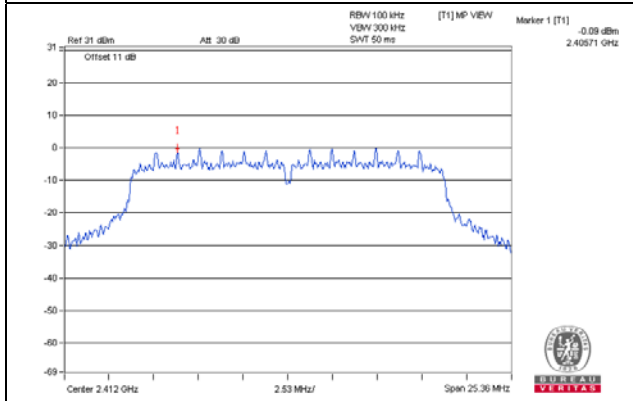

CH 6

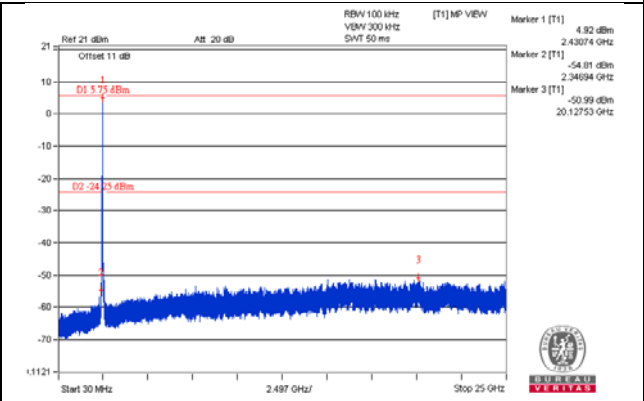
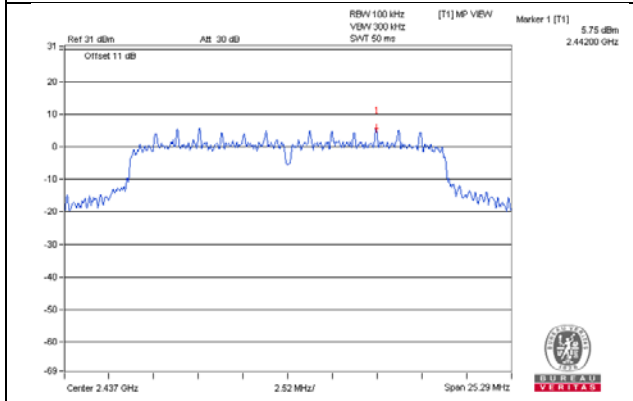

CH 11

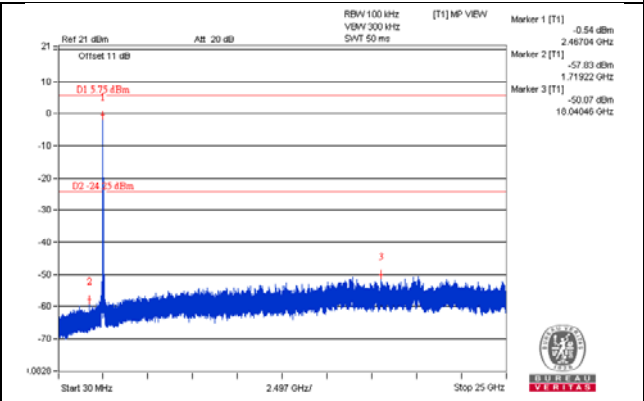
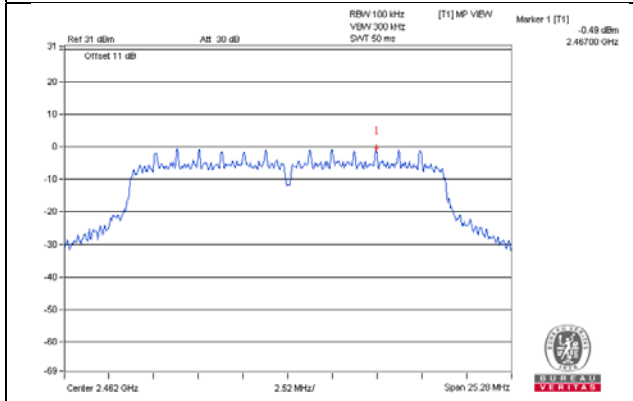

CH 1 Band edge

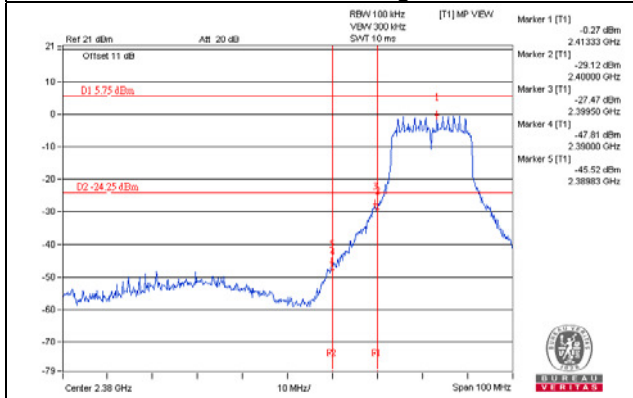

CH 11 Band edge

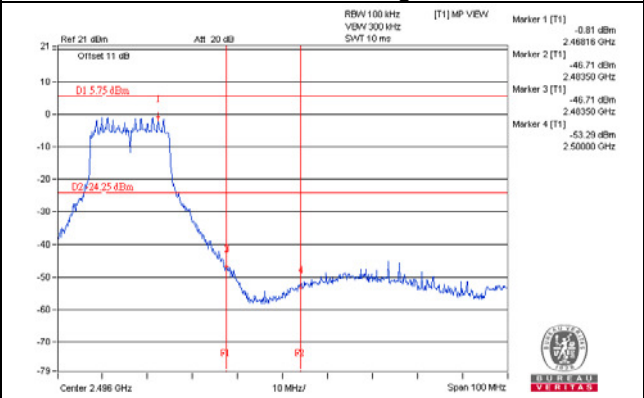

Note: Chosen the highest reference level for band edge limit.

802.11n (HT40)

CH 3

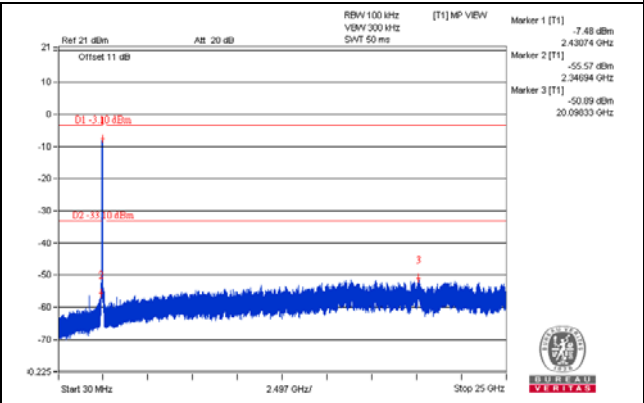
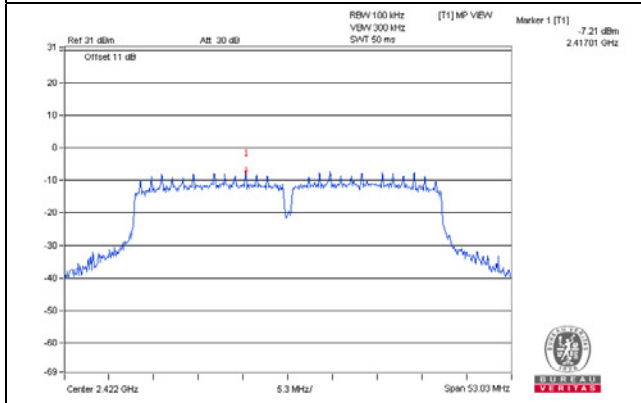

CH 6

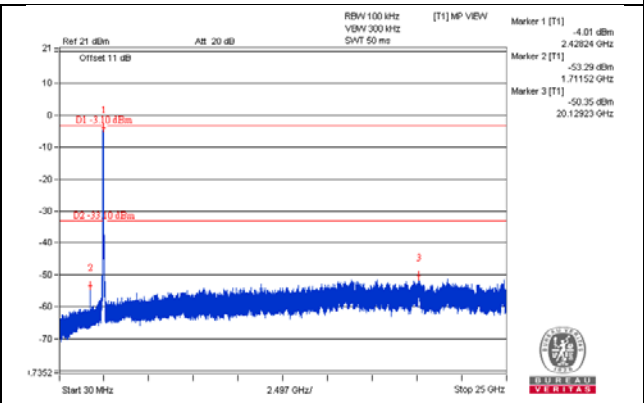
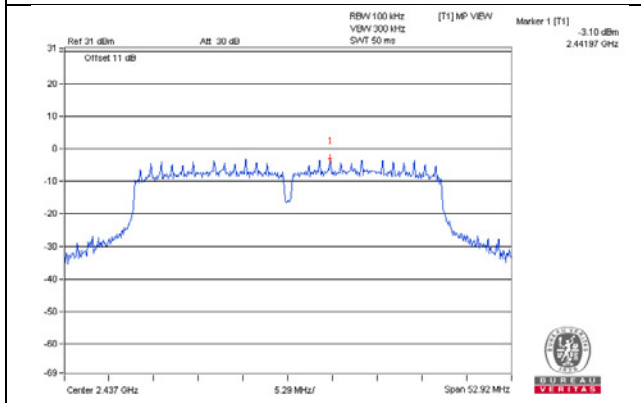

CH 9

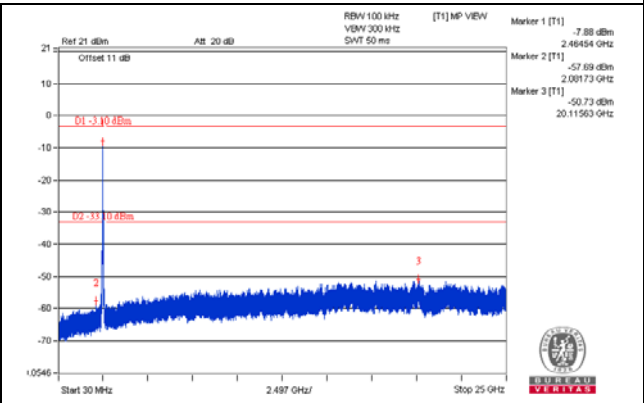
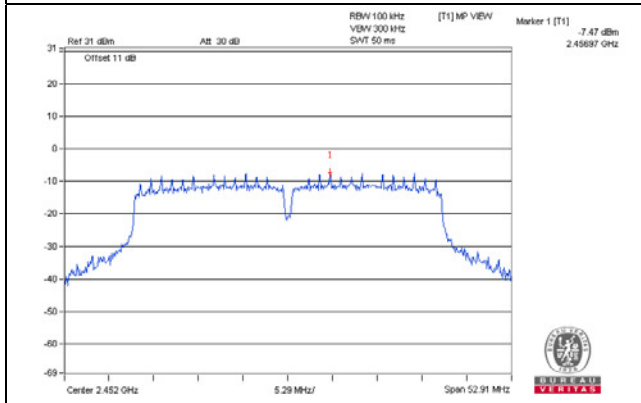

CH 3 Band edge

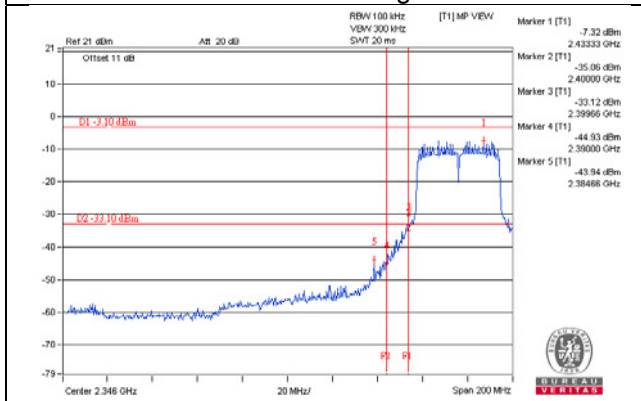

CH 9 Band edge

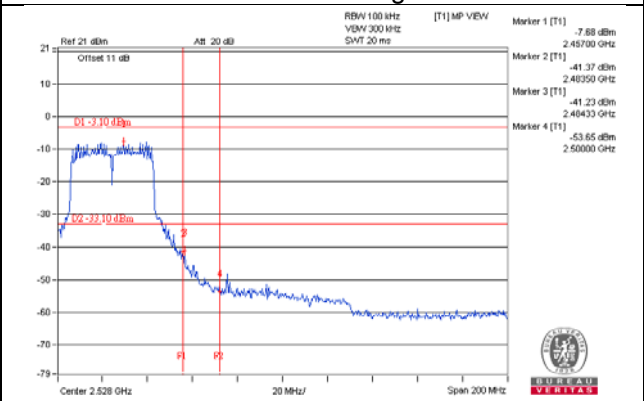

Note: Chosen the highest reference level for band edge limit.

5 Pictures of Test Arrangements

Please refer to the attached file (Test Setup Photo).

Appendix – Information on the Testing Laboratories

We, Bureau Veritas Consumer Products Services (H.K.) Ltd., Taoyuan Branch, were founded in 1988 to provide our best service in EMC, Radio, Telecom and Safety consultation. Our laboratories are accredited and approved according to ISO/IEC 17025.

If you have any comments, please feel free to contact us at the following:

Linko EMC/RF Lab

Tel: 886-2-26052180

Fax: 886-2-26051924

Hsin Chu EMC/RF/Telecom Lab

Tel: 886-3-6668565

Fax: 886-3-6668323

Hwa Ya EMC/RF/Safety Lab

Tel: 886-3-3183232

Fax: 886-3-3270892

Email: service.adt@tw.bureauveritas.com

Web Site: www.bureauveritas-adt.com

The address and road map of all our labs can be found in our web site also.

--- END ---