

FCC Test Report

Report No.: RF160726C12B-2

FCC ID: 2AGMRAP12I360

Test Model: AP12I360

Received Date: Jul. 26, 2016

Test Date: Sep. 09 ~ Nov. 08, 2016

Issued Date: Nov. 10, 2016

Applicant: Tembo Systems, Inc.

Address: 2933 Bunker Hill Lane, Suite 100, Santa Clara, CA 95054, United States.

Issued By: Bureau Veritas Consumer Products Services (H.K.) Ltd., Taoyuan Branch

Lab Address: No. 47-2, 14th Ling, Chia Pau Vil., Lin Kou Dist., New Taipei City, Taiwan, R.O.C.

Test Location: No.19, Hwa Ya 2nd Rd., Wen Hwa Vil., Kwei Shan Dist., Taoyuan City 33383, TAIWAN (R.O.C.)



This report is for your exclusive use. Any copying or replication of this report to or for any other person or entity, or use of our name or trademark, is permitted only with our prior written permission. This report sets forth our findings solely with respect to the test samples identified herein. The results set forth in this report are not indicative or representative of the quality or characteristics of the lot from which a test sample was taken or any similar or identical product unless specifically and expressly noted. Our report includes all of the tests requested by you and the results thereof based upon the information that you provided to us. You have 60 days from date of issuance of this report to notify us of any material error or omission caused by our negligence, provided, however, that such notice shall be in writing and shall specifically address the issue you wish to raise. A failure to raise such issue within the prescribed time shall constitute your unqualified acceptance of the completeness of this report, the tests conducted and the correctness of the report contents. Unless specific mention, the uncertainty of measurement has been explicitly taken into account to declare the compliance or non-compliance to the specification. This report should not be used by the client to claim product certification, approval, or endorsement by TAF or any government agencies.

Table of Contents

Release Control Record	4
1 Certificate of Conformity	5
2 Summary of Test Results	6
2.1 Measurement Uncertainty.....	6
2.2 Modification Record.....	6
3 General Information	7
3.1 General Description of EUT.....	7
3.2 Description of Test Modes.....	8
3.2.1 Test Mode Applicability and Tested Channel Detail.....	9
3.3 Duty Cycle of Test Signal.....	10
3.4 Description of Support Units.....	11
3.4.1 Configuration of System under Test.....	12
3.5 General Description of Applied Standards.....	13
4 Test Types and Results	14
4.1 Radiated Emission and Bandedge Measurement.....	14
4.1.1 Limits of Radiated Emission and Bandedge Measurement.....	14
4.1.2 Test Instruments.....	15
4.1.3 Test Procedures.....	16
4.1.4 Deviation from Test Standard.....	16
4.1.5 Test Set Up.....	17
4.1.6 EUT Operating Conditions.....	18
4.1.7 Test Results.....	19
4.2 Conducted Emission Measurement.....	24
4.2.1 Limits of Conducted Emission Measurement.....	24
4.2.2 Test Instruments.....	24
4.2.3 Test Procedures.....	25
4.2.4 Deviation from Test Standard.....	25
4.2.5 Test Setup.....	25
4.2.6 EUT Operating Conditions.....	25
4.2.7 Test Results.....	26
4.3 6dB Bandwidth Measurement.....	30
4.3.1 Limits of 6dB Bandwidth Measurement.....	30
4.3.2 Test Setup.....	30
4.3.3 Test Instruments.....	30
4.3.4 Test Procedure.....	30
4.3.5 Deviation from Test Standard.....	30
4.3.6 EUT Operating Conditions.....	30
4.3.7 Test Result.....	31
4.4 Conducted Output Power Measurement.....	32
4.4.1 Limits of Conducted Output Power Measurement.....	32
4.4.2 Test Setup.....	32
4.4.3 Test Instruments.....	32
4.4.4 Test Procedures.....	32
4.4.5 Deviation from Test Standard.....	32
4.4.6 EUT Operating Conditions.....	32
4.4.7 Test Results.....	32
4.5 Power Spectral Density Measurement.....	33
4.5.1 Limits of Power Spectral Density Measurement.....	33
4.5.2 Test Setup.....	33
4.5.3 Test Instruments.....	33
4.5.4 Test Procedure.....	33
4.5.5 Deviation from Test Standard.....	33
4.5.6 EUT Operating Condition.....	33

4.5.7 Test Results	34
4.6 Conducted Out of Band Emission Measurement.....	35
4.6.1 Limits of Conducted Out of Band Emission Measurement	35
4.6.2 Test Setup.....	35
4.6.3 Test Instruments	35
4.6.4 Test Procedure	35
4.6.5 Deviation from Test Standard	36
4.6.6 EUT Operating Condition	36
4.6.7 Test Results	36
5 Pictures of Test Arrangements.....	38
Appendix – Information on the Testing Laboratories	39

Release Control Record

Issue No.	Description	Date Issued
RF160726C12B-2	Original release	Nov. 10, 2016

1 Certificate of Conformity

Product: AP1002Oi 2-Radio Omni-Directional Indoor Access Point

Brand: EVEREST™ Network Solutions

Test Model: AP12I360

Sample Status: Engineering sample

Applicant: Tembo Systems, Inc.

Test Date: Sep. 09 ~ Nov. 08, 2016

Standards: 47 CFR FCC Part 15, Subpart C (Section 15.247)
ANSI C63.10:2013

The above equipment has been tested by **Bureau Veritas Consumer Products Services (H.K.) Ltd., Taoyuan Branch**, and found compliance with the requirement of the above standards. The test record, data evaluation & Equipment Under Test (EUT) configurations represented herein are true and accurate accounts of the measurements of the sample's EMC characteristics under the conditions specified in this report.

Prepared by : Celine Chou , **Date:** Nov. 10, 2016
Celine Chou / Specialist

Approved by : Ken Liu , **Date:** Nov. 10, 2016
Ken Liu / Senior Manager

2 Summary of Test Results

47 CFR FCC Part 15, Subpart C (Section 15.247)			
FCC Clause	Test Item	Result	Remarks
15.207	AC Power Conducted Emission	Pass	Meet the requirement of limit. Minimum passing margin is -4.13dB at 13.42054MHz
15.205 / 15.209 / 15.247(d)	Radiated Emissions and Band Edge Measurement	Pass	Meet the requirement of limit. Minimum passing margin is -1.8dB at 38.94MHz.
15.247(d)	Antenna Port Emission	Pass	Meet the requirement of limit.
15.247(a)(2)	6dB bandwidth	Pass	Meet the requirement of limit.
15.247(b)	Conducted power	Pass	Meet the requirement of limit.
15.247(e)	Power Spectral Density	Pass	Meet the requirement of limit.
15.203	Antenna Requirement	Pass	Antenna connector is IPEX not a standard connector.

2.1 Measurement Uncertainty

Where relevant, the following measurement uncertainty levels have been estimated for tests performed on the EUT as specified in CISPR 16-4-2:

Measurement	Frequency	Expanded Uncertainty (k=2) (\pm)
Conducted Emissions at mains ports	150kHz ~ 30MHz	2.44 dB
Radiated Emissions up to 1 GHz	30MHz ~ 200MHz	3.86 dB
	200MHz ~ 1000MHz	3.87 dB
Radiated Emissions above 1 GHz	1GHz ~ 18GHz	2.29 dB
	18GHz ~ 40GHz	2.29 dB

2.2 Modification Record

There were no modifications required for compliance.

3 General Information

3.1 General Description of EUT

Product	AP1002Oi 2-Radio Omni-Directional Indoor Access Point
Brand	EVEREST™ Network Solutions
Test Model	AP12I360
Sample Status	Engineering sample
Power Supply Rating	12Vdc from adapter 48Vdc from POE
Modulation Type	GFSK
Transfer Rate	1Mbps
Operating Frequency	2402 ~ 2480MHz
Number of Channel	40
Channel Spacing	2MHz
Output Power	1.026mW
Antenna Type	Refer to note
Antenna Connector	Refer to note
Accessory Device	NA
Data Cable Supplied	NA

Note:

1. There are four radios for the EUT.

Radio	Model	Function
Radio 1	QCA9994	WLAN 2.4G
Radio 2	QCA9994	WLAN 5G
Radio 3	QCA9889	WLAN 2.4GHz (TX/RX)+5GHz (RX)
Radio 4	MKW40Z160 MCU	BT LE

2. The EUT uses following antennas.

Ant. No.	1	2	3	4	5	6	7	8	9 (Scan) Individual	10 (BLE) Individual
Ant. Type	PIFA								PIFA	Dipole
Frequency (MHz)	2400-2500				5150-5850				2400-2500/ 5150-5850	2400-2500
Gain (dBi)	3.81	3.98	3.47	3.75	5.65	5.50	5.84	5.84	2.9/5.1	3.93
Connector	IPEX								IPEX	IPEX

3. The EUT consumes power from the following adapter and POE. (Support units only)

Adapter	
Brand	AOEM
Model	ADS036T-W120300
Input Power	100-240Vac, 50-60Hz, 1.0A
Output Power	12Vdc, 3.0A
Power Line	1.5m cable with one core attached on adapter

POE	
Brand	EnGenius
Model	EPE-48GR
Output Power	48Vdc, 0.5A, 24W Max

POE's adapter	
Brand	Powertron Electronics Corp.
Model	PA1040-480IB080
Input Power	100-240Vac, 50-60Hz, 1.5A
Output Power	48Vdc, 0.8A, 38.4W Max
Power Line	1.55m cable with one core attached on adapter

4. 2.4GHz, 5GHz and BT LE technology can transmit at same time.
5. Spurious emission of the simultaneous operation (2.4GHz, 5GHz and BT LE) has been evaluated and no non-compliance was found.

3.2 Description of Test Modes

40 channels are provided to this EUT:

Channel	Freq. (MHz)	Channel	Freq. (MHz)	Channel	Freq. (MHz)	Channel	Freq. (MHz)
0	2402	10	2422	20	2442	30	2462
1	2404	11	2424	21	2444	31	2464
2	2406	12	2426	22	2446	32	2466
3	2408	13	2428	23	2448	33	2468
4	2410	14	2430	24	2450	34	2470
5	2412	15	2432	25	2452	35	2472
6	2414	16	2434	26	2454	36	2474
7	2416	17	2436	27	2456	37	2476
8	2418	18	2438	28	2458	38	2478
9	2420	19	2440	29	2460	39	2480

3.2.1 Test Mode Applicability and Tested Channel Detail

EUT CONFIGURE MODE	APPLICABLE TO				DESCRIPTION
	RE \geq 1G	RE $<$ 1G	PLC	APCM	
A	√	√	√	√	Power from adapter
B	-	√	√	-	Power from POE

Where **RE \geq 1G**: Radiated Emission above 1GHz & Bandedge Measurement
RE $<$ 1G: Radiated Emission below 1GHz
PLC: Power Line Conducted Emission
APCM: Antenna Port Conducted Measurement

Note:

1. The EUT had been pre-tested on the positioned of each 3 axis. The worst case was found when positioned on **Z-plane**.
2. "-" means no effect.

Radiated Emission Test (Above 1GHz):

- Pre-Scan has been conducted to determine the worst-case mode from all possible combinations between available modulations, data rates and antenna ports (if EUT with antenna diversity architecture).
- Following channel(s) was (were) selected for the final test as listed below.

EUT CONFIGURE MODE	AVAILABLE CHANNEL	TESTED CHANNEL	MODULATION TYPE	DATA RATE (Mbps)
A	0 to 39	0, 19, 39	GFSK	1

Radiated Emission Test (Below 1GHz):

- Pre-Scan has been conducted to determine the worst-case mode from all possible combinations between available modulations, data rates and antenna ports (if EUT with antenna diversity architecture).
- Following channel(s) was (were) selected for the final test as listed below.

EUT CONFIGURE MODE	AVAILABLE CHANNEL	TESTED CHANNEL	MODULATION TYPE	DATA RATE (Mbps)
A, B	0 to 39	0	GFSK	1

Power Line Conducted Emission Test:

- Pre-Scan has been conducted to determine the worst-case mode from all possible combinations between available modulations, data rates and antenna ports (if EUT with antenna diversity architecture).
- Following channel(s) was (were) selected for the final test as listed below.

EUT CONFIGURE MODE	AVAILABLE CHANNEL	TESTED CHANNEL	MODULATION TYPE	DATA RATE (Mbps)
A, B	0 to 39	0	GFSK	1

Antenna Port Conducted Measurement:

- This item includes all test value of each mode, but only includes spectrum plot of worst value of each mode.
- Pre-Scan has been conducted to determine the worst-case mode from all possible combinations between available modulations, data rates and antenna ports (if EUT with antenna diversity architecture).
- Following channel(s) was (were) selected for the final test as listed below.

EUT CONFIGURE MODE	AVAILABLE CHANNEL	TESTED CHANNEL	MODULATION TYPE	DATA RATE (Mbps)
A	0 to 39	0, 19, 39	GFSK	1

Test Condition:

APPLICABLE TO	ENVIRONMENTAL CONDITIONS	INPUT POWER	TESTED BY
RE \geq 1G	19deg. C, 70%RH	120Vac, 60Hz	Jones Chang
RE $<$ 1G	19deg. C, 70%RH	120Vac, 60Hz 48Vdc	Jones Chang
PLC	16deg. C, 70%RH	120Vac, 60Hz 48Vdc	Nick Hsu
APCM	25deg. C, 60%RH	120Vac, 60Hz	Leo Tsai

3.3 Duty Cycle of Test Signal

Duty cycle of test signal is < 98 %, duty factor is required.

Duty cycle = $0.380/0.625 = 0.608$, Duty factor = $10 * \log(1/0.608) = 2.16$

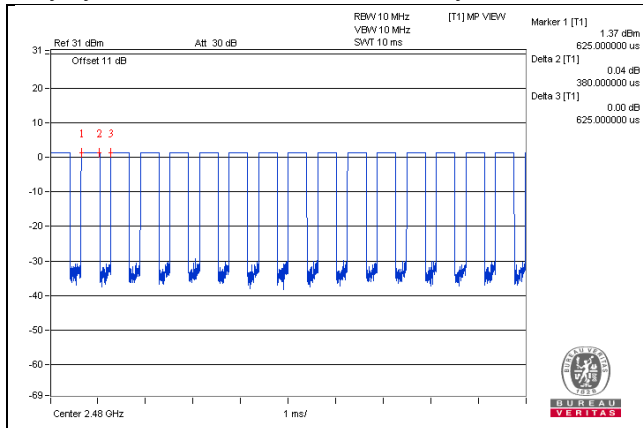

3.4 Description of Support Units

The EUT has been tested as an independent unit together with other necessary accessories or support units. The following support units or accessories were used to form a representative test configuration during the tests.

ID	Product	Brand	Model No.	Serial No.	FCC ID	Remarks
A.	Notebook	DELL	E5410	1HC2XM1	FCC DoC Approved	-
B.	Adapter	AOEM	ADS036T-W120300	N/A	N/A	Provided by manufacturer For test mode A only
C.	POE	EnGenius	EPE-48GR	N/A	N/A	Provided by manufacturer For test mode B only
D.	POE adapter	Powertron Electronics Corp.	PA1040-480IB080	N/A	N/A	Provided by manufacturer For test mode B only
E.	Load	N/A	N/A	N/A	N/A	-
F.	USB Flash	HP	v250W	01	FCC DoC Approved	-

Note:

1. All power cords of the above support units are non-shielded (1.8m).
2. Item A acted as communication partner to transfer data.

ID	Descriptions	Qty.	Length (m)	Shielding (Yes/No)	Cores (Qty.)	Remarks
1.	RJ45 Cable	1	3	N	0	Cat5e
2.	Power Cable	1	1.5	-	1	For test mode A only
3.	Power Cable	1	1.55	-	1	For test mode B only
4.	RJ45 Cable	1	1.8	N	0	Cat5e
5.	RJ45 to RS-232 Cable	1	1.8	N	0	-
6.	RJ45 Cable	1	1.8	N	0	Cat5e

Note: The core(s) is(are) originally attached to the cable(s).

3.4.1 Configuration of System under Test

Test Mode A

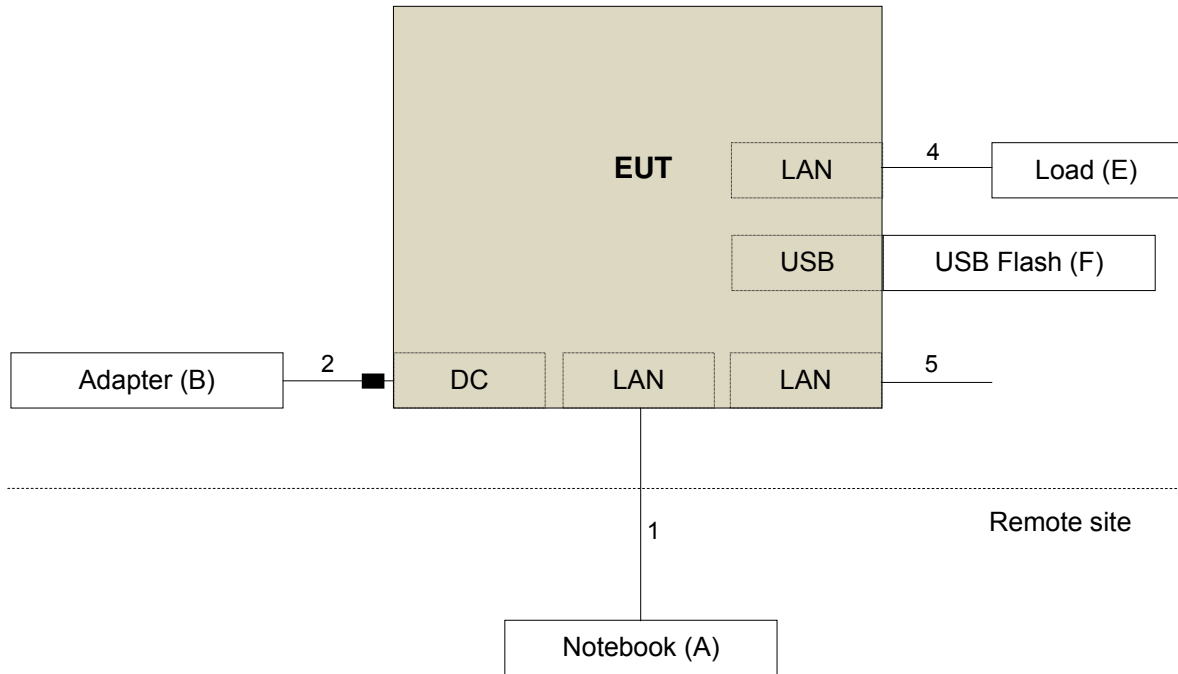

Test Mode B

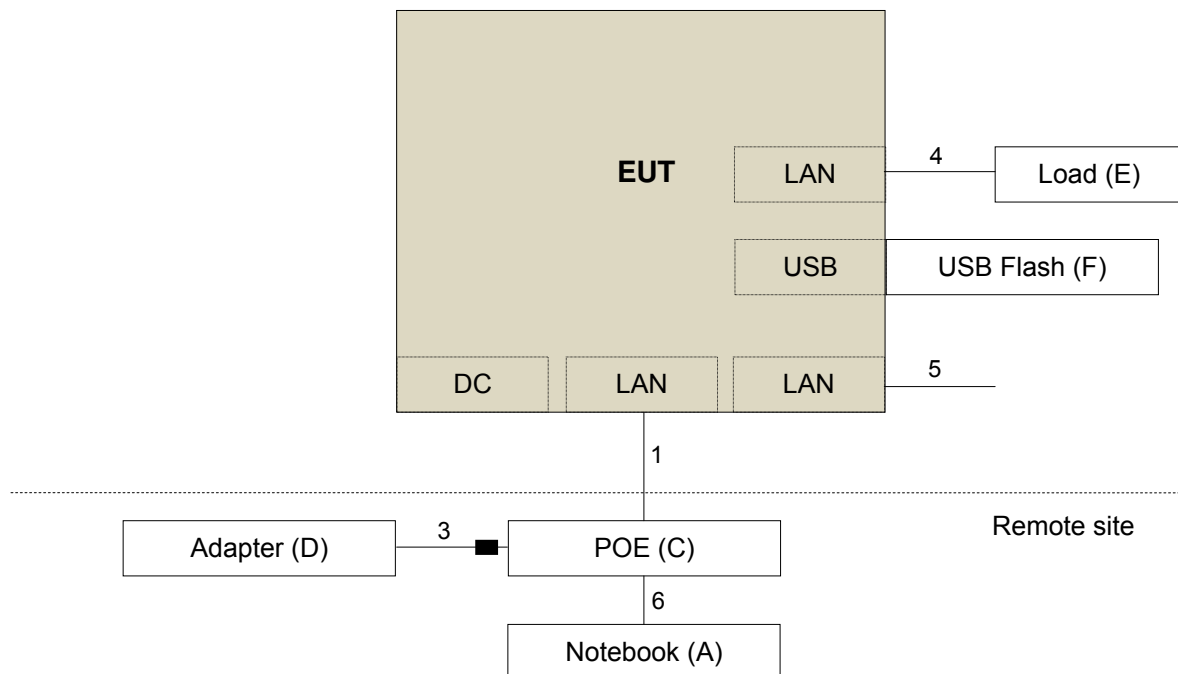

3.5 General Description of Applied Standards

The EUT is a RF Product. According to the specifications of the manufacturer, it must comply with the requirements of the following standards:

FCC Part 15, Subpart C (15.247)

KDB 558074 D01 DTS Meas Guidance v03r05

ANSI C63.10-2013

All test items have been performed and recorded as per the above standards.

Note: The EUT has been verified to comply with the requirements of FCC Part 15, Subpart B, Class B (DoC).
The test report has been issued separately.

4 Test Types and Results

4.1 Radiated Emission and Bandedge Measurement

4.1.1 Limits of Radiated Emission and Bandedge Measurement

Radiated emissions which fall in the restricted bands must comply with the radiated emission limits specified as below table. Other emissions shall be at least 30dB below the highest level of the desired power:

Frequencies (MHz)	Field Strength (microvolts/meter)	Measurement Distance (meters)
0.009 ~ 0.490	2400/F(kHz)	300
0.490 ~ 1.705	24000/F(kHz)	30
1.705 ~ 30.0	30	30
30 ~ 88	100	3
88 ~ 216	150	3
216 ~ 960	200	3
Above 960	500	3

Note:

1. The lower limit shall apply at the transition frequencies.
2. Emission level (dBuV/m) = 20 log Emission level (uV/m).
3. For frequencies above 1000MHz, the field strength limits are based on average detector, however, the peak field strength of any emission shall not exceed the maximum permitted average limits, specified above by more than 30dB under any condition of modulation.

4.1.2 Test Instruments

Description & Manufacturer	Model No.	Serial No.	Cal. Date	Cal. Due
Test Receiver ROHDE & SCHWARZ	ESIB7	100187	Apr. 18, 2016	Apr. 17, 2017
Spectrum Analyzer ROHDE & SCHWARZ	FSP40	100041	Sep. 02, 2016	Sep. 01, 2017
BILOG Antenna SCHWARZBECK	VULB9168	9168-171	Jan. 07, 2016	Jan. 06, 2017
HORN Antenna SCHWARZBECK	9120D	209	Jan. 20, 2016	Jan. 19, 2017
HORN Antenna SCHWARZBECK	BBHA 9170	BBHA9170241	Jan. 18, 2016	Jan. 17, 2017
Loop Antenna	EM-6879	269	Aug. 11, 2016	Aug. 10, 2017
Preamplifier Agilent	8447D	2944A10738	Aug. 22, 2016	Aug. 21, 2017
Preamplifier Agilent	8449B	3008A01964	Aug. 22, 2016	Aug. 21, 2017
RF signal cable HUBER+SUHNER	SUCOFLEX 104	Cable-CH3-03 (214378)	Aug. 22, 2016	Aug. 21, 2017
RF signal cable HUBER+SUHNER	SUCOFLEX 106	Cable-CH3-03 (309224+12738)	Aug. 22, 2016	Aug. 21, 2017
Software BV ADT	ADT_Radiated_ V7.6.15.9.4	NA	NA	NA
Antenna Tower inn-co GmbH	MA 4000	013303	NA	NA
Antenna Tower Controller BV ADT	AT100	AT93021702	NA	NA
Turn Table BV ADT	TT100	TT93021702	NA	NA
Turn Table Controller BV ADT	SC100	SC93021702	NA	NA
High Speed Peak Power Meter	ML2495A	0824011	Jul. 09, 2016	Jul. 08, 2017
Power Sensor	MA2411B	0738171	Aug. 11, 2016	Aug. 10, 2017

- Note:
1. The calibration interval of the above test instruments is 12 months and the calibrations are traceable to NML/ROC and NIST/USA.
 2. The test was performed in HwaYa Chamber 3.
 3. The horn antenna and preamplifier (model: 8449B) are used only for the measurement of emission frequency above 1GHz if tested.
 4. The FCC Site Registration No. is 988962.
 5. The IC Site Registration No. is IC 7450F-3.

4.1.3 Test Procedures

For Radiated emission below 30MHz

- a. The EUT was placed on the top of a rotating table 0.8 meters above the ground at a 3 meter chamber room. The table was rotated 360 degrees to determine the position of the highest radiation.
- b. The EUT was set 3 meters away from the interference-receiving antenna, which was mounted on the top of a variable-height antenna tower.
- c. Both X and Y axes of the antenna are set to make the measurement.
- d. For each suspected emission, the EUT was arranged to its worst case and the rotatable table was turned from 0 degrees to 360 degrees to find the maximum reading.
- e. The test-receiver system was set to Quasi-Peak Detect Function and Specified Bandwidth with Maximum Hold Mode.

Note:

1. The resolution bandwidth and video bandwidth of test receiver/spectrum analyzer is 9kHz at frequency below 30MHz.

For Radiated emission above 30MHz

- a. The EUT was placed on the top of a rotating table 0.8 meters (for 30MHz ~ 1GHz) / 1.5 meters (for above 1GHz) above the ground at 3 meter chamber room for test. The table was rotated 360 degrees to determine the position of the highest radiation.
- b. The EUT was set 3 meters away from the interference-receiving antenna, which was mounted on the top of a variable-height antenna tower.
- c. The height of antenna is varied from one meter to four meters above the ground to determine the maximum value of the field strength. Both horizontal and vertical polarizations of the antenna are set to make the measurement.
- d. For each suspected emission, the EUT was arranged to its worst case and then the antenna was tuned to heights from 1 meter to 4 meters and the rotatable table was turned from 0 degrees to 360 degrees to find the maximum reading.
- e. The test-receiver system was set to quasi-peak detect function and specified bandwidth with maximum hold mode when the test frequency is below 1 GHz.
- f. The test-receiver system was set to peak and average detect function and specified bandwidth with maximum hold mode when the test frequency is above 1 GHz. If the peak reading value also meets average limit, measurement with the average detector is unnecessary.

Note:

1. The resolution bandwidth and video bandwidth of test receiver/spectrum analyzer is 120kHz for Quasi-peak detection (QP) at frequency below 1GHz.
2. The resolution bandwidth of test receiver/spectrum analyzer is 1 MHz and the video bandwidth is 3 MHz for Peak detection (PK) at frequency above 1GHz.
3. The resolution bandwidth of test receiver/spectrum analyzer is 1MHz and the video bandwidth is $\geq 1/T$ (Duty cycle < 98%) or 10Hz (Duty cycle $\geq 98\%$) for Average detection (AV) at frequency above 1GHz.
4. All modes of operation were investigated and the worst-case emissions are reported.

4.1.4 Deviation from Test Standard

No deviation.

4.1.5 Test Set Up

For Radiated emission below 30MHz

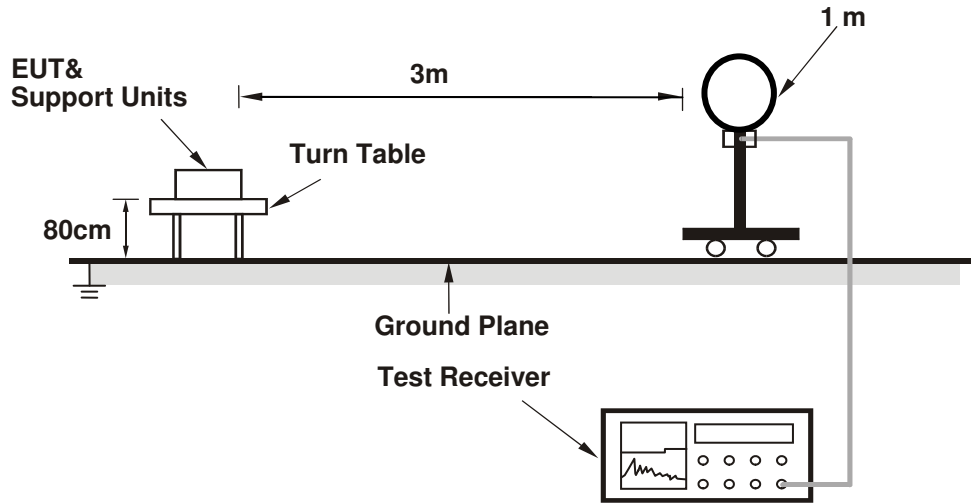

For Radiated emission 30MHz to 1GHz

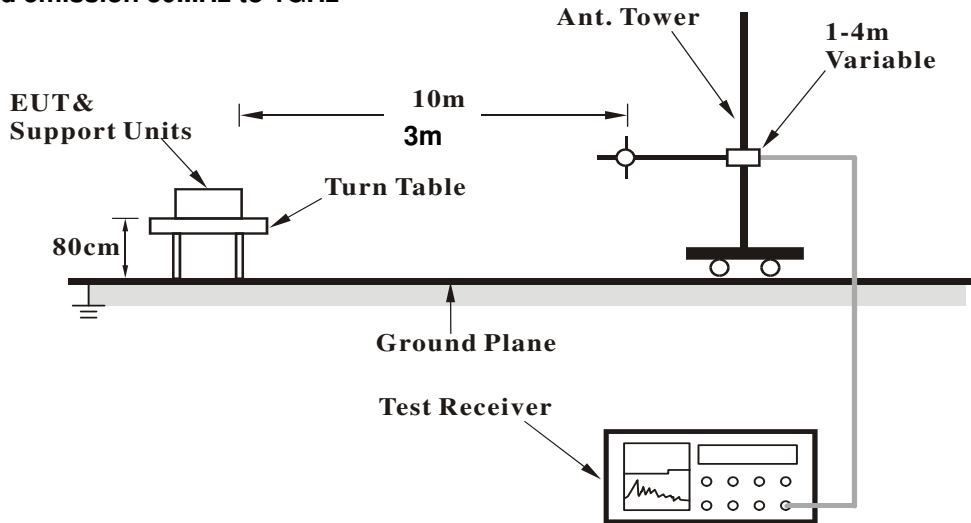

For Radiated emission above 1GHz

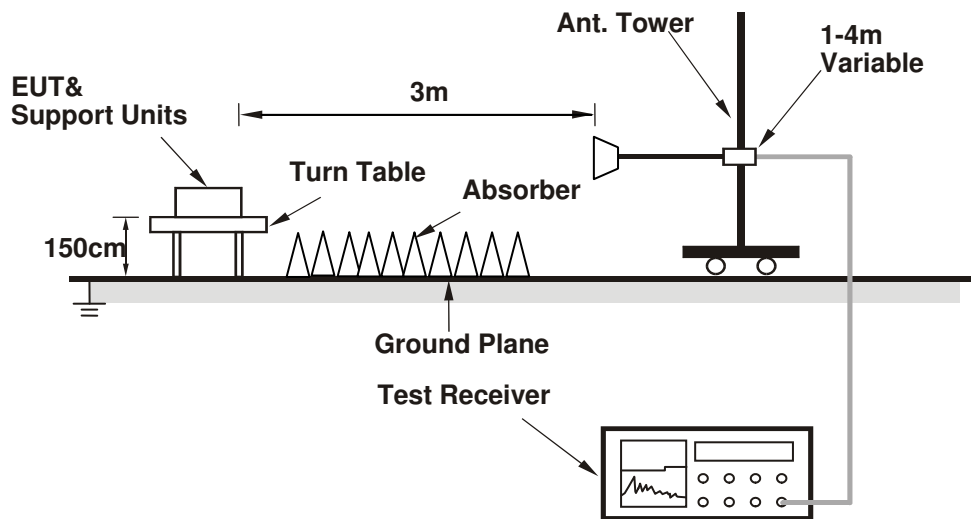

For the actual test configuration, please refer to the attached file (Test Setup Photo).

4.1.6 EUT Operating Conditions

- Placed the EUT on the testing table.
- Prepared a notebook to act as a communication partner and placed it outside of testing area.
- The communication partner connected with EUT via a RJ45 cable and ran a test program (provided by manufacturer) to enable EUT under transmission condition continuously at specific channel frequency.
- The communication partner sent data to EUT by command "PING".

4.1.7 Test Results

Above 1GHz worst-case data:

CHANNEL	TX Channel 0	DETECTOR FUNCTION	Peak (PK)
FREQUENCY RANGE	1GHz ~ 25GHz		Average (AV)

ANTENNA POLARITY & TEST DISTANCE: HORIZONTAL AT 3 M								
NO.	FREQ. (MHz)	EMISSION LEVEL (dBuV/m)	LIMIT (dBuV/m)	MARGIN (dB)	ANTENNA HEIGHT (m)	TABLE ANGLE (Degree)	RAW VALUE (dBuV)	CORRECTION FACTOR (dB/m)
1	2390.00	54.3 PK	74.0	-19.7	1.80 H	320	23.4	30.9
2	2390.00	44.1 AV	54.0	-9.9	1.80 H	320	13.2	30.9
3	*2402.00	93.1 PK			1.78 H	310	62.1	31.0
4	*2402.00	88.8 AV			1.78 H	310	57.8	31.0
5	4804.00	48.9 PK	74.0	-25.1	2.31 H	348	44.5	4.4
6	4804.00	38.9 AV	54.0	-15.1	2.31 H	348	34.5	4.4
ANTENNA POLARITY & TEST DISTANCE: VERTICAL AT 3 M								
NO.	FREQ. (MHz)	EMISSION LEVEL (dBuV/m)	LIMIT (dBuV/m)	MARGIN (dB)	ANTENNA HEIGHT (m)	TABLE ANGLE (Degree)	RAW VALUE (dBuV)	CORRECTION FACTOR (dB/m)
1	2390.00	56.0 PK	74.0	-18.0	1.66 V	220	23.2	32.8
2	2390.00	45.2 AV	54.0	-8.8	1.66 V	220	12.4	32.8
3	*2402.00	88.7 PK			1.55 V	192	55.9	32.8
4	*2402.00	84.5 AV			1.55 V	192	51.7	32.8
5	4804.00	48.3 PK	74.0	-25.7	2.51 V	19	42.4	5.9
6	4804.00	39.4 AV	54.0	-14.6	2.51 V	19	33.5	5.9

Remarks:

1. Emission Level(dBuV/m) = Raw Value(dBuV) + Correction Factor(dB/m)
2. Correction Factor(dB/m) = Antenna Factor(dB/m) + Cable Factor(dB)
3. The other emission levels were very low against the limit.
4. Margin value = Emission Level – Limit value
5. " * ": Fundamental frequency.
6. " # ": The radiated frequency is out of the restricted band.

CHANNEL	TX Channel 19	DETECTOR FUNCTION	Peak (PK)
FREQUENCY RANGE	1GHz ~ 25GHz		Average (AV)

ANTENNA POLARITY & TEST DISTANCE: HORIZONTAL AT 3 M								
NO.	FREQ. (MHz)	EMISSION LEVEL (dBuV/m)	LIMIT (dBuV/m)	MARGIN (dB)	ANTENNA HEIGHT (m)	TABLE ANGLE (Degree)	RAW VALUE (dBuV)	CORRECTION FACTOR (dB/m)
1	*2440.00	92.7 PK			2.59 H	315	59.7	33.0
2	*2440.00	88.4 AV			2.59 H	315	55.4	33.0
3	4880.00	50.1 PK	74.0	-23.9	2.19 H	344	44.1	6.0
4	4880.00	39.5 AV	54.0	-14.5	2.19 H	344	33.5	6.0
ANTENNA POLARITY & TEST DISTANCE: VERTICAL AT 3 M								
NO.	FREQ. (MHz)	EMISSION LEVEL (dBuV/m)	LIMIT (dBuV/m)	MARGIN (dB)	ANTENNA HEIGHT (m)	TABLE ANGLE (Degree)	RAW VALUE (dBuV)	CORRECTION FACTOR (dB/m)
1	*2440.00	88.5 PK			1.53 V	192	55.5	33.0
2	*2440.00	87.5 AV			1.53 V	192	54.5	33.0
3	4880.00	50.8 PK	74.0	-23.2	2.53 V	19	44.8	6.0
4	4880.00	39.4 AV	54.0	-14.6	2.53 V	19	33.4	6.0

Remarks:

1. Emission Level(dBuV/m) = Raw Value(dBuV) + Correction Factor(dB/m)
2. Correction Factor(dB/m) = Antenna Factor(dB/m) + Cable Factor(dB)
3. The other emission levels were very low against the limit.
4. Margin value = Emission Level – Limit value
5. " * ": Fundamental frequency.

CHANNEL	TX Channel 39	DETECTOR FUNCTION	Peak (PK)
FREQUENCY RANGE	1GHz ~ 25GHz		Average (AV)

ANTENNA POLARITY & TEST DISTANCE: HORIZONTAL AT 3 M								
NO.	FREQ. (MHz)	EMISSION LEVEL (dBuV/m)	LIMIT (dBuV/m)	MARGIN (dB)	ANTENNA HEIGHT (m)	TABLE ANGLE (Degree)	RAW VALUE (dBuV)	CORRECTION FACTOR (dB/m)
1	*2480.00	94.4 PK			2.49 H	318	61.4	33.0
2	*2480.00	89.9 AV			2.49 H	318	56.9	33.0
3	2483.50	66.5 PK	74.0	-7.5	2.49 H	318	33.5	33.0
4	2483.50	45.3 AV	54.0	-8.7	2.49 H	318	12.3	33.0
5	4960.00	48.4 PK	74.0	-25.6	1.69 H	335	42.3	6.1
6	4960.00	37.9 AV	54.0	-16.1	1.69 H	335	31.8	6.1
7	7440.00	55.3 PK	74.0	-18.7	2.19 H	25	41.8	13.5
8	7440.00	43.6 AV	54.0	-10.4	2.19 H	25	30.1	13.5

ANTENNA POLARITY & TEST DISTANCE: VERTICAL AT 3 M								
NO.	FREQ. (MHz)	EMISSION LEVEL (dBuV/m)	LIMIT (dBuV/m)	MARGIN (dB)	ANTENNA HEIGHT (m)	TABLE ANGLE (Degree)	RAW VALUE (dBuV)	CORRECTION FACTOR (dB/m)
1	*2480.00	88.7 PK			2.73 V	180	55.7	33.0
2	*2480.00	84.7 AV			2.73 V	180	51.7	33.0
3	2483.50	59.9 PK	74.0	-14.1	2.73 V	180	26.9	33.0
4	2483.50	45.5 AV	54.0	-8.5	2.73 V	180	12.5	33.0
5	4960.00	48.5 PK	74.0	-25.5	1.78 V	22	42.4	6.1
6	4960.00	38.4 AV	54.0	-15.6	1.78 V	22	32.3	6.1
7	7440.00	54.8 PK	74.0	-19.2	2.07 V	19	41.3	13.5
8	7440.00	43.5 AV	54.0	-10.5	2.07 V	19	30.0	13.5

Remarks:

1. Emission Level(dBuV/m) = Raw Value(dBuV) + Correction Factor(dB/m)
2. Correction Factor(dB/m) = Antenna Factor(dB/m) + Cable Factor(dB)
3. The other emission levels were very low against the limit.
4. Margin value = Emission Level – Limit value
5. " * ": Fundamental frequency.

Below 1GHz worst-case data:

CHANNEL	TX Channel 0	DETECTOR FUNCTION	Quasi-Peak (QP)
FREQUENCY RANGE	9kHz ~ 1GHz		
TEST MODE	A		

ANTENNA POLARITY & TEST DISTANCE: HORIZONTAL AT 3 M

NO.	FREQ. (MHz)	EMISSION LEVEL (dBuV/m)	LIMIT (dBuV/m)	MARGIN (dB)	ANTENNA HEIGHT (m)	TABLE ANGLE (Degree)	RAW VALUE (dBuV)	CORRECTION FACTOR (dB/m)
1	80.45	29.1 QP	40.0	-10.9	2.00 H	74	47.7	-18.6
2	156.28	30.3 QP	43.5	-13.2	1.50 H	267	44.1	-13.8
3	199.05	34.6 QP	43.5	-8.9	1.50 H	54	51.1	-16.5
4	294.32	31.4 QP	46.0	-14.6	1.00 H	159	43.7	-12.3
5	902.89	40.4 QP	46.0	-5.6	2.00 H	16	39.6	0.8
6	1000.00	37.3 QP	54.0	-16.7	1.50 H	11	35.3	2.0

ANTENNA POLARITY & TEST DISTANCE: VERTICAL AT 3 M

NO.	FREQ. (MHz)	EMISSION LEVEL (dBuV/m)	LIMIT (dBuV/m)	MARGIN (dB)	ANTENNA HEIGHT (m)	TABLE ANGLE (Degree)	RAW VALUE (dBuV)	CORRECTION FACTOR (dB/m)
1	38.94	34.8 QP	40.0	-5.2	1.00 V	75	50.0	-15.2
2	60.01	34.7 QP	40.0	-5.3	1.02 V	153	49.4	-14.7
3	76.03	33.0 QP	40.0	-7.0	1.02 V	9	50.7	-17.7
4	150.45	35.7 QP	43.5	-7.8	1.00 V	301	49.4	-13.7
5	199.05	37.0 QP	43.5	-6.5	1.00 V	163	53.5	-16.5
6	323.49	35.5 QP	46.0	-10.5	1.99 V	141	47.0	-11.5

Remarks:

1. Emission Level(dBuV/m) = Raw Value(dBuV) + Correction Factor(dB/m)
2. Correction Factor(dB/m) = Antenna Factor(dB/m) + Cable Factor(dB)
3. The other emission levels were very low against the limit.
4. Margin value = Emission Level – Limit value

CHANNEL	TX Channel 0	DETECTOR FUNCTION	Quasi-Peak (QP)
FREQUENCY RANGE	9kHz ~ 1GHz		
TEST MODE	B		

ANTENNA POLARITY & TEST DISTANCE: HORIZONTAL AT 3 M

NO.	FREQ. (MHz)	EMISSION LEVEL (dBuV/m)	LIMIT (dBuV/m)	MARGIN (dB)	ANTENNA HEIGHT (m)	TABLE ANGLE (Degree)	RAW VALUE (dBuV)	CORRECTION FACTOR (dB/m)
1	57.12	29.3 QP	40.0	-10.7	2.00 H	270	43.9	-14.6
2	201.00	29.3 QP	43.5	-14.2	1.00 H	197	45.8	-16.5
3	249.60	29.8 QP	46.0	-16.2	1.00 H	134	43.8	-14.0
4	401.26	25.2 QP	46.0	-20.8	1.00 H	7	35.3	-10.1
5	902.89	38.2 QP	46.0	-7.8	1.51 H	87	37.4	0.8
6	1000.00	38.1 QP	54.0	-15.9	1.51 H	214	36.1	2.0

ANTENNA POLARITY & TEST DISTANCE: VERTICAL AT 3 M

NO.	FREQ. (MHz)	EMISSION LEVEL (dBuV/m)	LIMIT (dBuV/m)	MARGIN (dB)	ANTENNA HEIGHT (m)	TABLE ANGLE (Degree)	RAW VALUE (dBuV)	CORRECTION FACTOR (dB/m)
1	38.94	38.2 QP	40.0	-1.8	1.00 V	159	53.4	-15.2
2	70.73	30.9 QP	40.0	-9.1	1.00 V	337	47.4	-16.5
3	125.17	22.7 QP	43.5	-20.8	1.00 V	205	38.8	-16.1
4	249.60	26.5 QP	46.0	-19.5	1.00 V	43	40.5	-14.0
5	599.58	26.8 QP	46.0	-19.2	1.00 V	13	32.2	-5.4
6	902.05	41.3 QP	46.0	-4.7	1.50 V	232	40.5	0.8

Remarks:

1. Emission Level(dBuV/m) = Raw Value(dBuV) + Correction Factor(dB/m)
2. Correction Factor(dB/m) = Antenna Factor(dB/m) + Cable Factor(dB)
3. The other emission levels were very low against the limit.
4. Margin value = Emission Level – Limit value

4.2 Conducted Emission Measurement

4.2.1 Limits of Conducted Emission Measurement

Frequency (MHz)	Conducted Limit (dBuV)	
	Quasi-peak	Average
0.15 - 0.5	66 - 56	56 - 46
0.50 - 5.0	56	46
5.0 - 30.0	60	50

- Note:** 1. The lower limit shall apply at the transition frequencies.
 2. The limit decreases in line with the logarithm of the frequency in the range of 0.15 to 0.50MHz.

4.2.2 Test Instruments

Description & Manufacturer	Model No.	Serial No.	Cal. Date	Cal. Due
Test Receiver ROHDE & SCHWARZ	ESCI	100613	Nov. 16, 2015	Nov. 15, 2016
RF signal cable (with 10dB PAD) Woken	5D-FB	Cable-cond1-01	Dec. 26, 2015	Dec. 25, 2016
LISN/AMN ROHDE & SCHWARZ (EUT)	ESH3-Z5	835239/001	Feb. 26, 2016	Feb. 25, 2017
LISN/AMN ROHDE & SCHWARZ (Peripheral)	ESH3-Z5	100220	Nov. 13, 2015	Nov. 12, 2016
Software ADT	BV ADT_Cond_ V7.3.7.3	NA	NA	NA

- Note:** 1. The calibration interval of the above test instruments is 12 months and the calibrations are traceable to NML/ROC and NIST/USA.
 2. The test was performed in HwaYa Shielded Room 1.
 3. The VCCI Site Registration No. is C-2040.

4.2.3 Test Procedures

- The EUT was placed 0.4 meters from the conducting wall of the shielded room with EUT being connected to the power mains through a line impedance stabilization network (LISN). Other support units were connected to the power mains through another LISN. The two LISNs provide 50 ohm/ 50uH of coupling impedance for the measuring instrument.
- Both lines of the power mains connected to the EUT were checked for maximum conducted interference.
- The frequency range from 150kHz to 30MHz was searched. Emission levels under (Limit - 20dB) was not recorded.

Note: The resolution bandwidth and video bandwidth of test receiver is 9kHz for quasi-peak detection (QP) and average detection (AV) at frequency 0.15MHz-30MHz.

4.2.4 Deviation from Test Standard

No deviation.

4.2.5 Test Setup

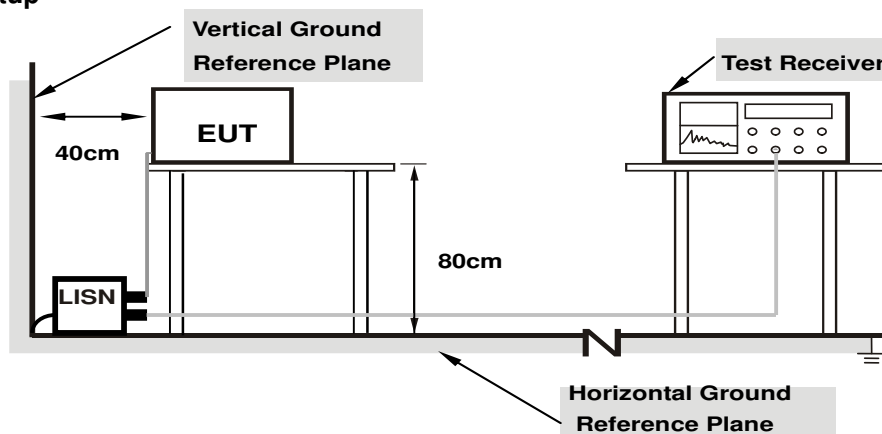

Note: 1.Support units were connected to second LISN.

For the actual test configuration, please refer to the attached file (Test Setup Photo).

4.2.6 EUT Operating Conditions

Same as 4.1.6.

4.2.7 Test Results

Phase	Line (L)	Detector Function	Quasi-Peak (QP) / Average (AV)
Test Mode	A		

No	Freq. [MHz]	Corr. Factor (dB)	Reading Value		Emission Level		Limit		Margin	
			[dB (uV)]		[dB (uV)]		[dB (uV)]		(dB)	
			Q.P.	AV.	Q.P.	AV.	Q.P.	AV.	Q.P.	AV.
1	0.16569	10.08	44.38	34.43	54.46	44.51	65.17	55.17	-10.71	-10.66
2	0.20404	10.08	36.06	28.71	46.14	38.79	63.44	53.44	-17.30	-14.65
3	0.30249	10.13	34.28	29.02	44.41	39.15	60.17	50.17	-15.76	-11.02
4	0.52927	10.20	34.09	28.92	44.29	39.12	56.00	46.00	-11.71	-6.88
5	0.66781	10.22	21.14	14.51	31.36	24.73	56.00	46.00	-24.64	-21.27
6	19.74301	11.40	20.96	16.33	32.36	27.73	60.00	50.00	-27.64	-22.27

Remarks:

1. Q.P. and AV. are abbreviations of quasi-peak and average individually.
2. The emission levels of other frequencies were very low against the limit.
3. Margin value = Emission level - Limit value
4. Correction factor = Insertion loss + Cable loss
5. Emission Level = Correction Factor + Reading Value.

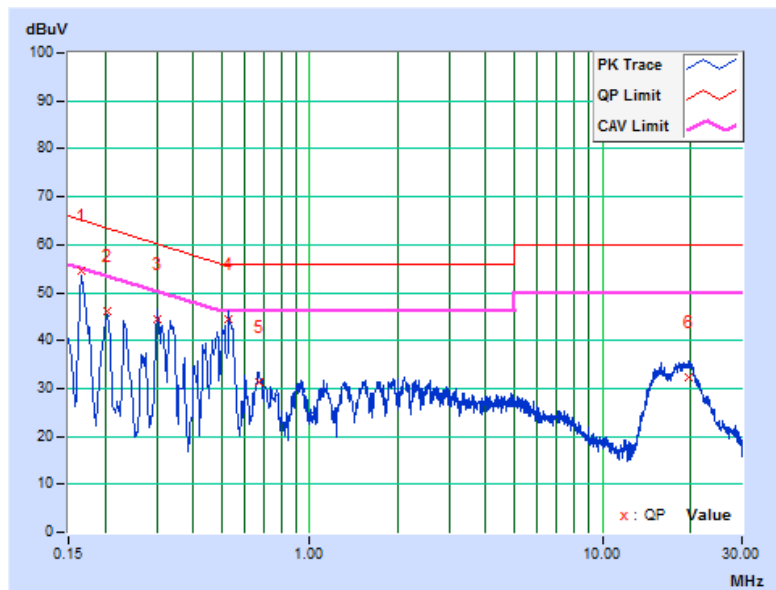

Phase	Neutral (N)	Detector Function	Quasi-Peak (QP) / Average (AV)
Test Mode	A		

No	Freq. [MHz]	Corr. Factor (dB)	Reading Value [dB (uV)]		Emission Level [dB (uV)]		Limit [dB (uV)]		Margin (dB)	
			Q.P.	AV.	Q.P.	AV.	Q.P.	AV.	Q.P.	AV.
			1	0.16569	10.08	45.26	36.66	55.34	46.74	65.17
2	0.30249	10.16	34.82	29.97	44.98	40.13	60.17	50.17	-15.19	-10.04
3	0.33396	10.19	33.24	28.13	43.43	38.32	59.35	49.35	-15.92	-11.03
4	0.52960	10.25	34.65	25.51	44.90	35.76	56.00	46.00	-11.10	-10.24
5	0.93982	10.28	20.46	14.01	30.74	24.29	56.00	46.00	-25.26	-21.71
6	18.01088	11.42	20.75	16.13	32.17	27.55	60.00	50.00	-27.83	-22.45

Remarks:

1. Q.P. and AV. are abbreviations of quasi-peak and average individually.
2. The emission levels of other frequencies were very low against the limit.
3. Margin value = Emission level - Limit value
4. Correction factor = Insertion loss + Cable loss
5. Emission Level = Correction Factor + Reading Value.

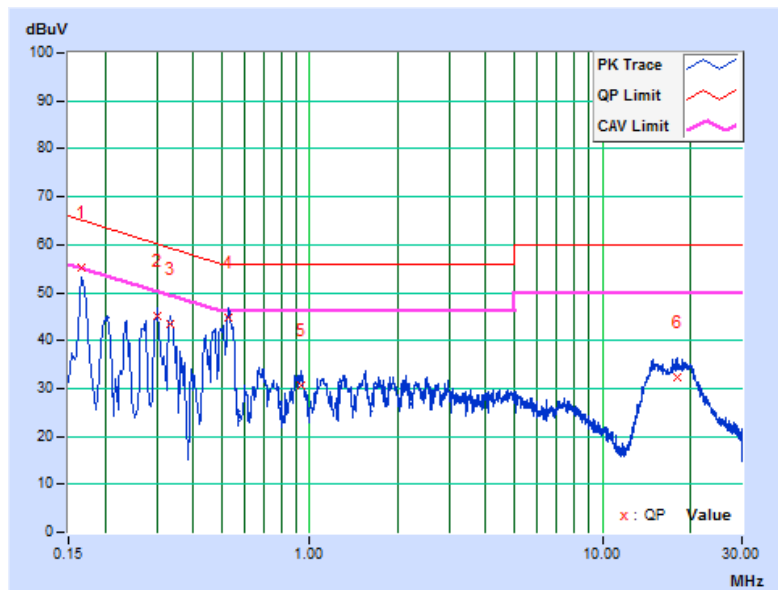

Phase	Line (L)	Detector Function	Quasi-Peak (QP) / Average (AV)
Test Mode	B		

No	Freq. [MHz]	Corr. Factor (dB)	Reading Value [dB (uV)]		Emission Level [dB (uV)]		Limit [dB (uV)]		Margin (dB)	
			Q.P.	AV.	Q.P.	AV.	Q.P.	AV.	Q.P.	AV.
			1	0.50190	10.19	37.87	31.49	48.06	41.68	56.00
2	1.07276	10.30	27.00	19.17	37.30	29.47	56.00	46.00	-18.70	-16.53
3	1.62798	10.34	32.21	26.56	42.55	36.90	56.00	46.00	-13.45	-9.10
4	7.16063	10.63	30.26	26.54	40.89	37.17	60.00	50.00	-19.11	-12.83
5	13.35806	10.97	35.70	33.97	46.67	44.94	60.00	50.00	-13.33	-5.06
6	16.22792	11.15	30.22	26.93	41.37	38.08	60.00	50.00	-18.63	-11.92

Remarks:

1. Q.P. and AV. are abbreviations of quasi-peak and average individually.
2. The emission levels of other frequencies were very low against the limit.
3. Margin value = Emission level - Limit value
4. Correction factor = Insertion loss + Cable loss
5. Emission Level = Correction Factor + Reading Value.

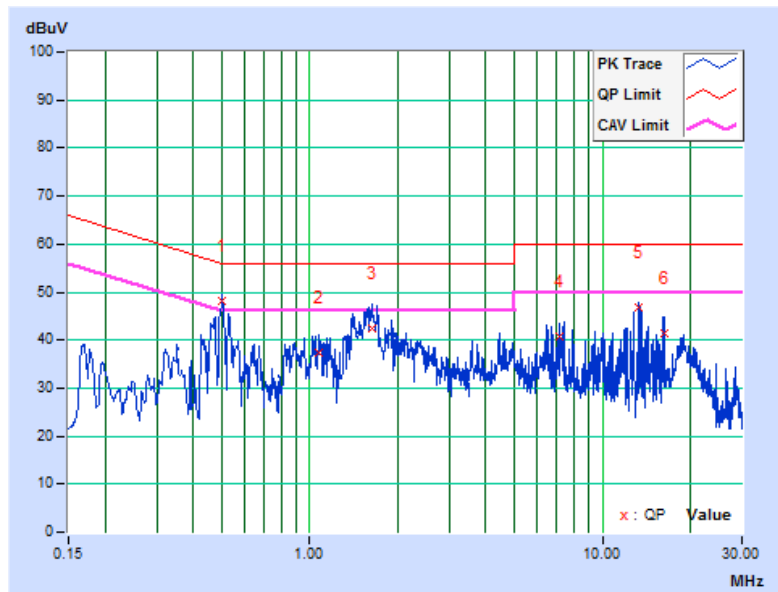

Phase	Neutral (N)	Detector Function	Quasi-Peak (QP) / Average (AV)
Test Mode	B		

No	Freq. [MHz]	Corr. Factor (dB)	Reading Value [dB (uV)]		Emission Level [dB (uV)]		Limit [dB (uV)]		Margin (dB)	
			Q.P.	AV.	Q.P.	AV.	Q.P.	AV.	Q.P.	AV.
			1	0.50242	10.25	37.62	31.01	47.87	41.26	56.00
2	1.02584	10.29	33.67	22.62	43.96	32.91	56.00	46.00	-12.04	-13.09
3	1.61234	10.35	34.95	28.92	45.30	39.27	56.00	46.00	-10.70	-6.73
4	4.44709	10.61	31.09	27.51	41.70	38.12	56.00	46.00	-14.30	-7.88
5	6.48029	10.70	33.39	31.73	44.09	42.43	60.00	50.00	-15.91	-7.57
6	13.42054	11.08	36.15	34.79	47.23	45.87	60.00	50.00	-12.77	-4.13

Remarks:

1. Q.P. and AV. are abbreviations of quasi-peak and average individually.
2. The emission levels of other frequencies were very low against the limit.
3. Margin value = Emission level - Limit value
4. Correction factor = Insertion loss + Cable loss
5. Emission Level = Correction Factor + Reading Value.

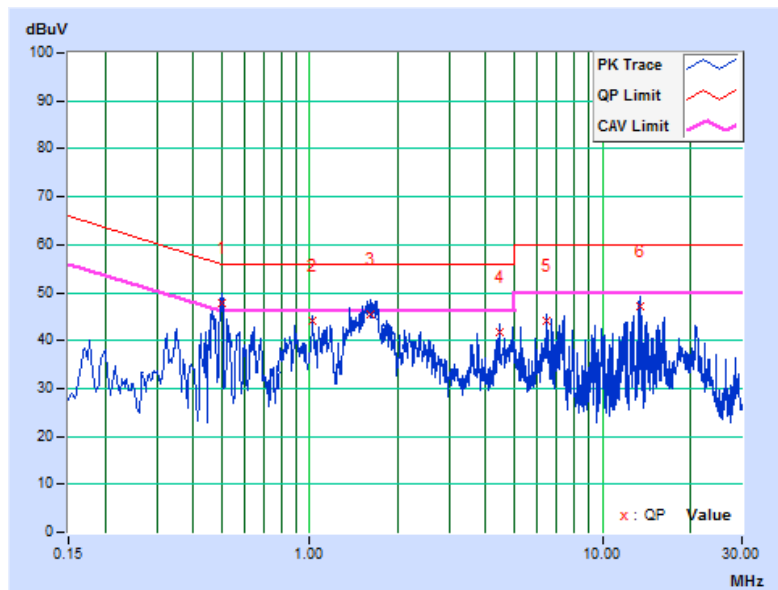

4.3 6dB Bandwidth Measurement

4.3.1 Limits of 6dB Bandwidth Measurement

The minimum of 6dB Bandwidth Measurement is 0.5 MHz.

4.3.2 Test Setup

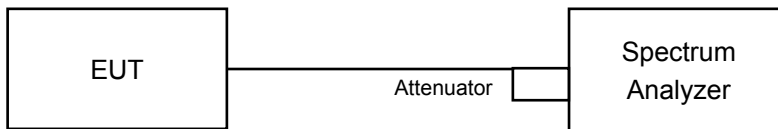

4.3.3 Test Instruments

Refer to section 4.1.2 to get information of above instrument.

4.3.4 Test Procedure

- Set resolution bandwidth (RBW) = 100kHz
- Set the video bandwidth (VBW) $\geq 3 \times$ RBW, Detector = average.
- Trace mode = max hold.
- Sweep = auto couple.
- Measure the maximum width of the emission that is constrained by the frequencies associated with the two amplitude points (upper and lower) that are attenuated by 6 dB relative to the maximum level measured in the fundamental emission

4.3.5 Deviation from Test Standard

No deviation.

4.3.6 EUT Operating Conditions

The software provided by client to enable the EUT under transmission condition continuously at lowest, middle and highest channel frequencies individually.

4.3.7 Test Result

Channel	Frequency (MHz)	6dB Bandwidth (kHz)	Minimum Limit (MHz)	Pass / Fail
0	2402	651.80	0.5	Pass
19	2440	653.96	0.5	Pass
39	2480	653.58	0.5	Pass

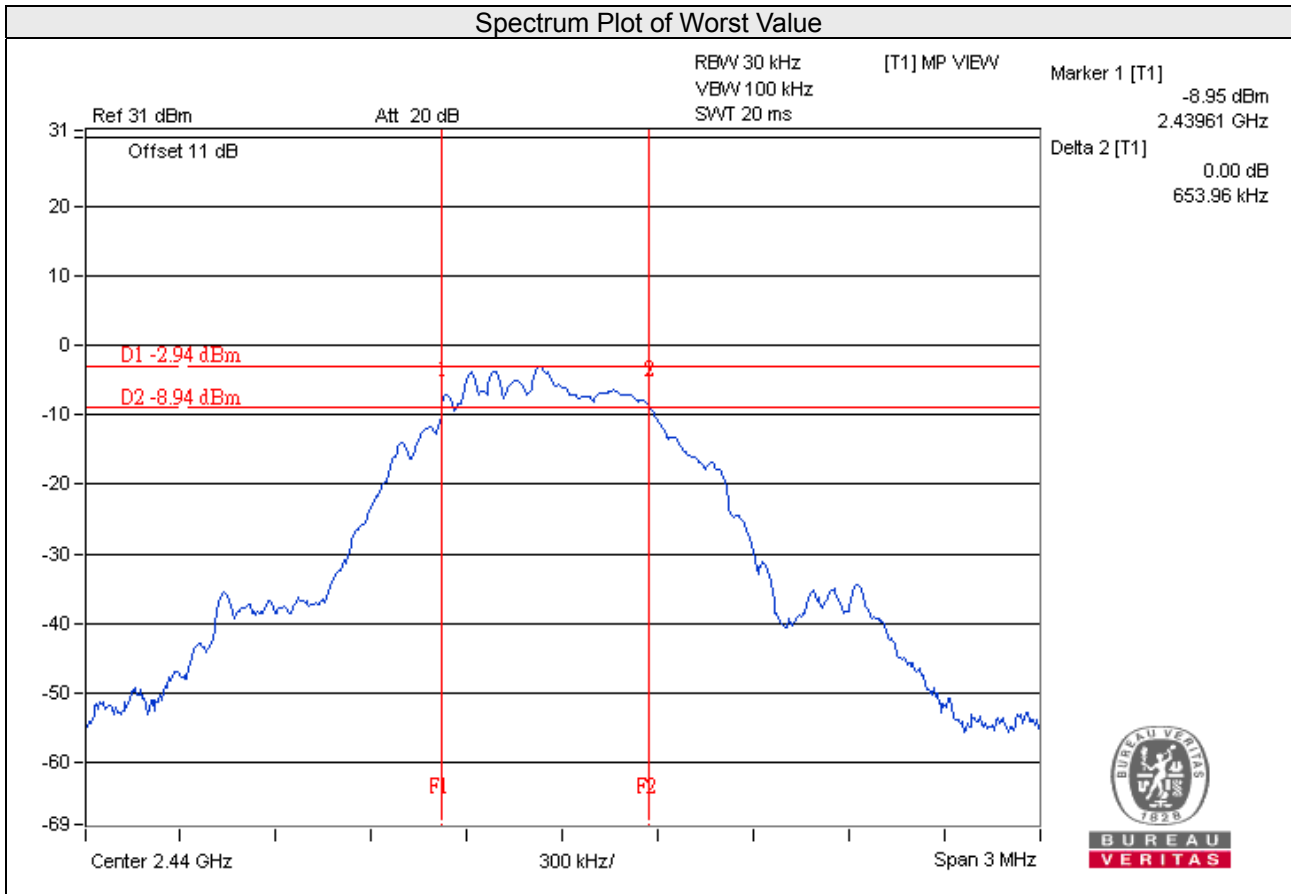

4.4 Conducted Output Power Measurement

4.4.1 Limits of Conducted Output Power Measurement

For systems using digital modulation in the 2400–2483.5 MHz bands: 1 Watt (30dBm)

4.4.2 Test Setup

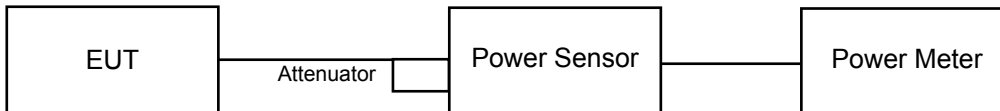

4.4.3 Test Instruments

Refer to section 4.1.2 to get information of above instrument.

4.4.4 Test Procedures

An average power sensor was used on the output port of the EUT. A power meter was used to read the response of the average power sensor. Record the power level.

4.4.5 Deviation from Test Standard

No deviation.

4.4.6 EUT Operating Conditions

Same as Item 4.3.6.

4.4.7 Test Results

Channel	Frequency (MHz)	Average Power (mW)	Average Power (dBm)	Limit (dBm)	Pass/Fail
0	2402	1.026	0.11	30	Pass
19	2440	1.014	0.06	30	Pass
39	2480	0.964	-0.16	30	Pass

4.5 Power Spectral Density Measurement

4.5.1 Limits of Power Spectral Density Measurement

The Maximum of Power Spectral Density Measurement is 8dBm.

4.5.2 Test Setup

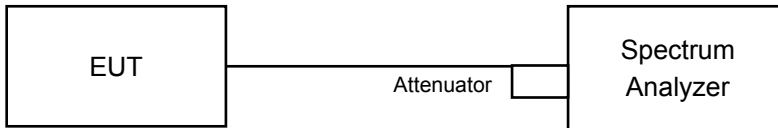

4.5.3 Test Instruments

Refer to section 4.1.2 to get information of above instrument.

4.5.4 Test Procedure

- a. Measure the duty cycle (x).
- b. Set instrument center frequency to DTS channel center frequency.
- c. Set span to at least 1.5 times the OBW.
- d. Set RBW to: $3 \text{ kHz} \leq \text{RBW} \leq 100 \text{ kHz}$.
- e. Set VBW $\geq 3 \times \text{RBW}$.
- f. Detector = power averaging (RMS) or sample detector (when RMS not available).
- g. Ensure that the number of measurement points in the sweep $\geq 2 \times \text{span}/\text{RBW}$.
- h. Sweep time = auto couple.
- i. Do not use sweep triggering. Allow sweep to "free run".
- j. Employ trace averaging (RMS) mode over a minimum of 100 traces.
- k. Use the peak marker function to determine the maximum amplitude level.
- l. Add $10 \log (1/x)$, where x is the duty cycle measured in step (a), to the measured PSD to compute the average PSD during the actual transmission time.

4.5.5 Deviation from Test Standard

No deviation.

4.5.6 EUT Operating Condition

Same as Item 4.3.6

4.5.7 Test Results

Channel	Frequency (MHz)	PSD w/o Duty Factor (dBm/3kHz)	Duty Factor (dB)	Total PSD With Duty Factor (dBm/3kHz)	Limit (dBm/3kHz)	Pass / Fail
0	2402	-20.34	2.16	-18.18	8.00	Pass
19	2440	-19.67	2.16	-17.51	8.00	Pass
39	2480	-19.52	2.16	-17.36	8.00	Pass

Note: Refer to section 3.3 for duty cycle spectrum plot.

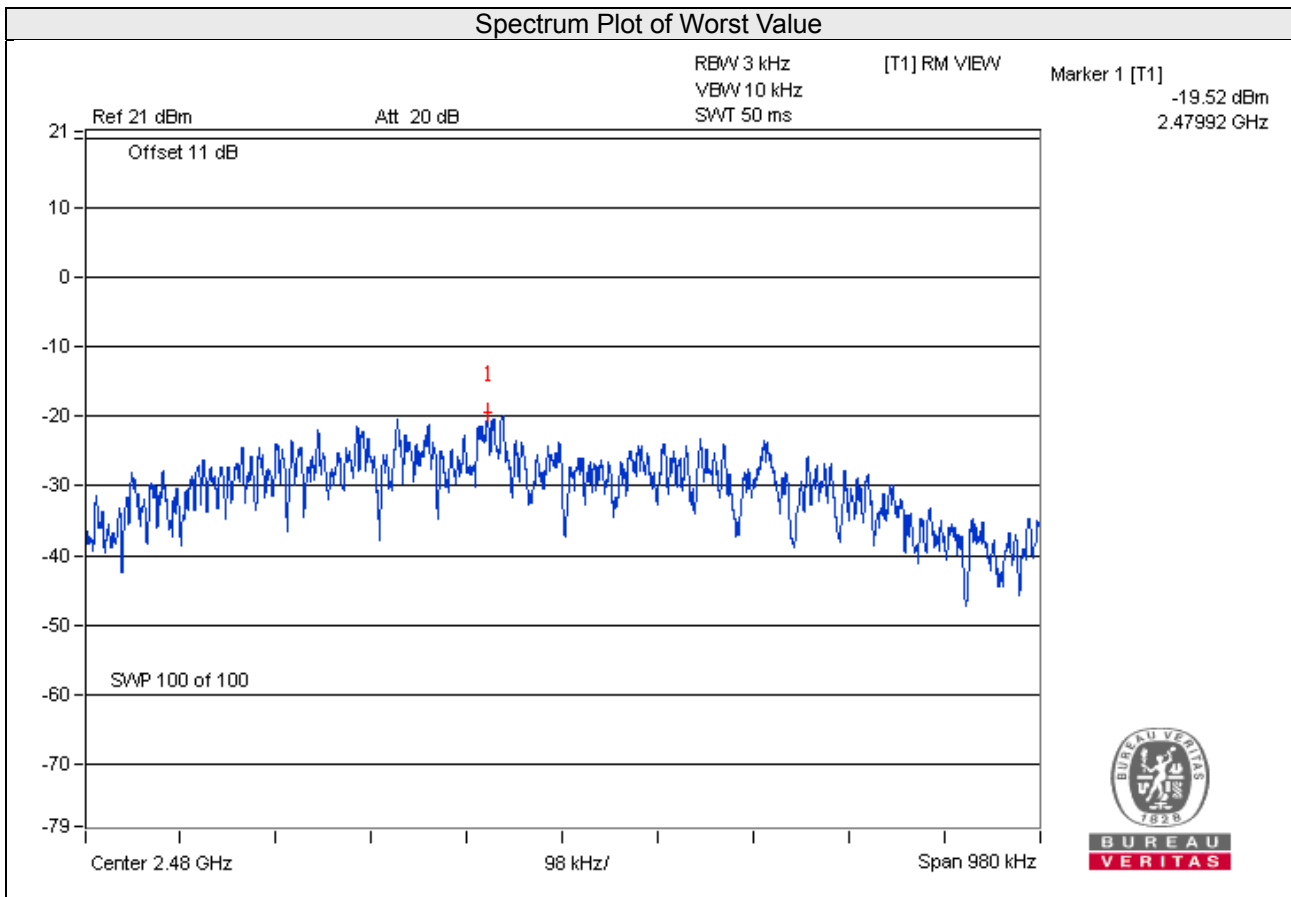

4.6 Conducted Out of Band Emission Measurement

4.6.1 Limits of Conducted Out of Band Emission Measurement

Below 30dB of the highest emission level of operating band (in 100kHz Resolution Bandwidth).

4.6.2 Test Setup

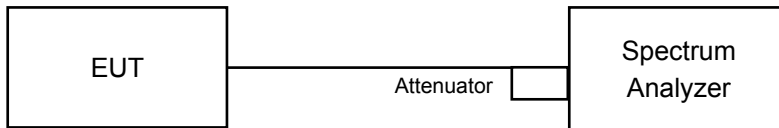

4.6.3 Test Instruments

Refer to section 4.1.2 to get information of above instrument.

4.6.4 Test Procedure

MEASUREMENT PROCEDURE REF

- Set the RBW = 100 kHz.
- Set the VBW \geq 300 kHz.
- Detector = average.
- Sweep time = auto couple.
- Trace mode = max hold.
- Allow trace to fully stabilize.
- Use the peak marker function to determine the maximum power level in any 100 kHz band segment within the fundamental EBW.

MEASUREMENT PROCEDURE OOBE

- Set RBW = 100 kHz.
- Set VBW \geq 300 kHz.
- Detector = average.
- Sweep = auto couple.
- Trace Mode = max hold.
- Allow trace to fully stabilize.
- Use the peak marker function to determine the maximum amplitude level.

4.6.5 Deviation from Test Standard

No deviation.

4.6.6 EUT Operating Condition

Same as Item 4.3.6

4.6.7 Test Results

The spectrum plots are attached on the following pages. D1 line indicates the highest level, and D2 line indicates the 30dB offset below D1. It shows compliance with the requirement.

CH 0

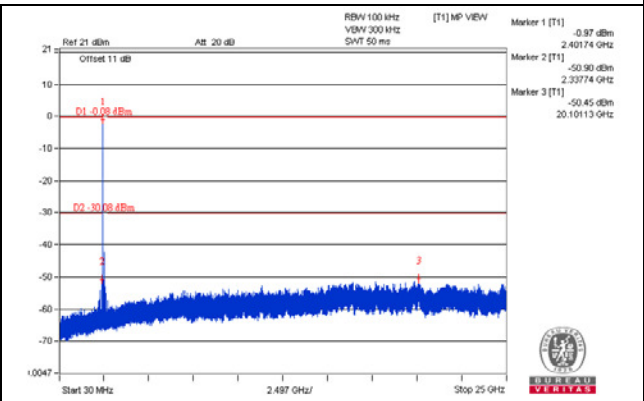
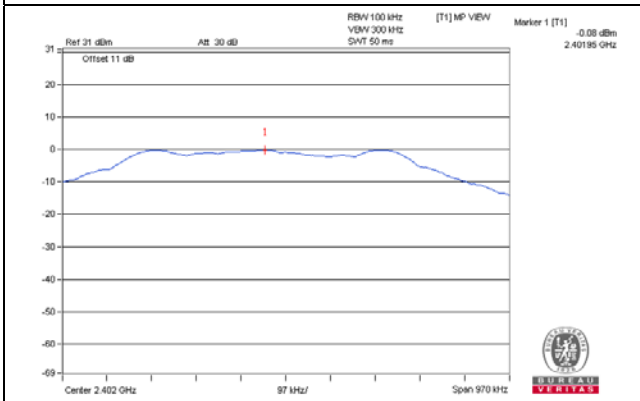

CH 19

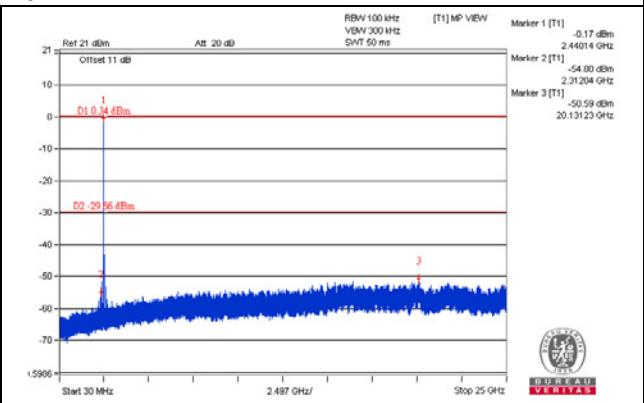
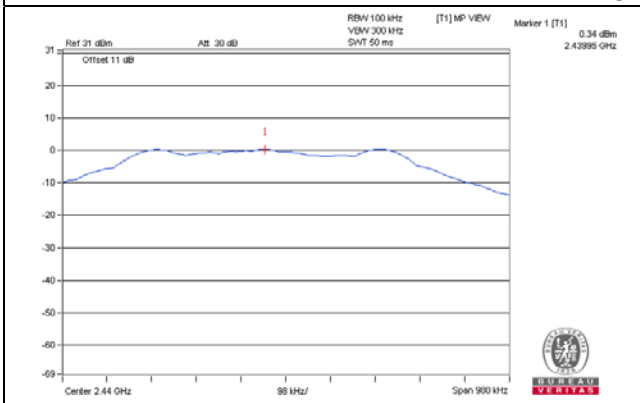

CH 39

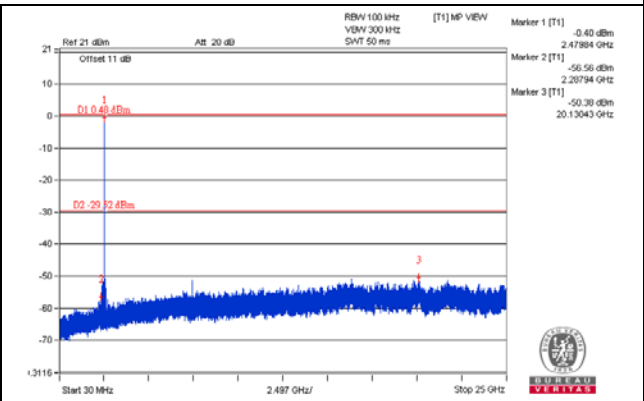
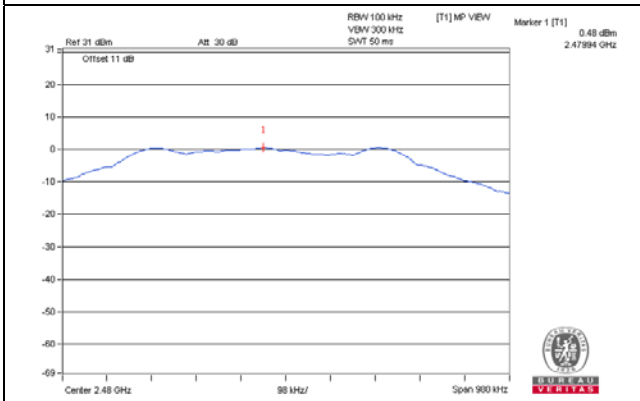

CH 0 Band edge

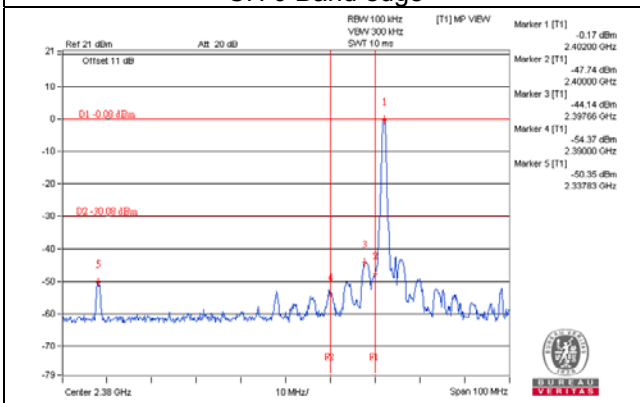

CH 39 Band edge

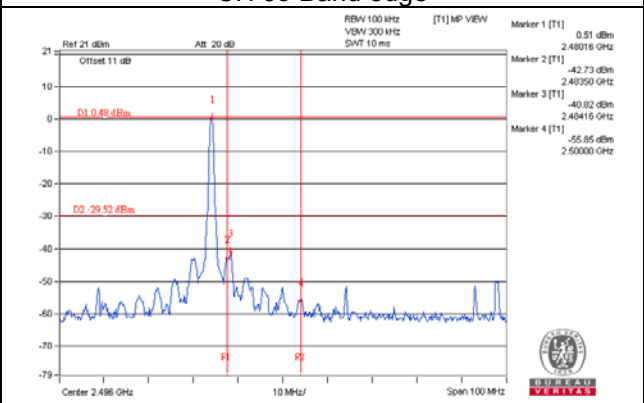

5 Pictures of Test Arrangements

Please refer to the attached file (Test Setup Photo).

Appendix – Information on the Testing Laboratories

We, Bureau Veritas Consumer Products Services (H.K.) Ltd., Taoyuan Branch, were founded in 1988 to provide our best service in EMC, Radio, Telecom and Safety consultation. Our laboratories are accredited and approved according to ISO/IEC 17025.

If you have any comments, please feel free to contact us at the following:

Linko EMC/RF Lab

Tel: 886-2-26052180

Fax: 886-2-26051924

Hsin Chu EMC/RF/Telecom Lab

Tel: 886-3-6668565

Fax: 886-3-6668323

Hwa Ya EMC/RF/Safety Lab

Tel: 886-3-3183232

Fax: 886-3-3270892

Email: service.adt@tw.bureauveritas.com

Web Site: www.bureauveritas-adt.com

The address and road map of all our labs can be found in our web site also.

--- END ---