



313 West 12800 South, Suite 311

Draper, UT 84020

(801) 260-4040

Test Report

Certification

FCC ID	2AGL3-BTMV2
Equipment Under Test	ITS31
Test Report Serial No	V045348_04
Date of Test	July 2, 2018
Report Issue Date	July 17, 2018

Test Specifications:	Applicant:
FCC Part 15, Subpart C	iTOVi, LLC 355 S 520 W, Suite 250 Lindon, UT 84042 U.S.A.



Certification of Engineering Report

This report has been prepared by VPI Laboratories, Inc. to document compliance of the device described below with the requirements of Federal Communications Commission (FCC) Part 15, Subpart C. This report may be reproduced in full. Partial reproduction of this report may only be made with the written consent of the laboratory. The results in this report apply only to the sample tested.

Applicant	iTOVi, LLC
Manufacturer	iTOVi, LLC
Brand Name	iTOVi
Model Number	ITS31
FCC ID	2AGL3-BTMV2

On this 17th day of July 2018, I, individually and for VPI Laboratories, Inc., certify that the statements made in this engineering report are true, complete, and correct to the best of my knowledge, and are made in good faith.

Although NVLAP has accredited the VPI Laboratories, Inc. EMC testing facilities, this report must not be used to claim product certification, approval, or endorsement by NVLAP, NIST, or any agency of the federal government.

VPI Laboratories, Inc.



Tested by: Norman P. Hansen



Reviewed by: Joseph W. Jackson

Revision History		
Revision	Description	Date
01	Original Report Release	July 17, 2018
02	Amend FCC ID Number and Model Number per Applicants Request	September 17, 2018
03	Updated report to include antenna gain, and show measurement conversions from EIRP to conducted power measurements, update the summary table to remove antenna port conducted spurious measurements, update equipment list to identify antenna with attenuator and amplifier as an assembly.	October 19, 2018
04	Corrected conducted power reported in the table of page 17.	November 9, 2018

Table of Contents

1	Client Information.....	5
1.1	Applicant.....	5
1.2	Manufacturer.....	5
2	Equipment Under Test (EUT).....	6
2.1	Identification of EUT.....	6
2.2	Description of EUT.....	6
2.3	EUT and Support Equipment.....	6
2.4	Interface Ports on EUT.....	7
2.5	Modification Incorporated/Special Accessories on EUT.....	7
2.6	Deviation from Test Standard.....	7
3	Test Specification, Methods and Procedures.....	8
3.1	Test Specification.....	8
3.2	Methods & Procedures.....	8
3.3	Test Procedure.....	12
4	Operation of EUT During Testing.....	13
4.1	Operating Environment.....	13
4.2	Operating Modes.....	13
4.3	EUT Exercise Software.....	13
5	Summary of Test Results.....	14
5.1	FCC Part 15, Subpart C.....	14
5.2	Result.....	14
6	Measurements, Examinations and Derived Results.....	15
6.1	General Comments.....	15
6.2	Test Results.....	15
7	Test Procedures and Test Equipment.....	25
7.1	Radiated Emissions.....	25
7.2	Equipment Calibration.....	26
7.3	Measurement Uncertainty.....	27
8	Photographs.....	28

1 Client Information

1.1 Applicant

Company Name	iTOVi, LLC 355 S 520 W, Suite 250 Lindon, UT 84042 U.S.A.
Contact Name	Mike Wadman
Title	CEO

1.2 Manufacturer

Company Name	iTOVi, LLC 355 S 520 W, Suite 250 Lindon, UT 84042 U.S.A.
Contact Name	Mike Wadman
Title	CEO

2 Equipment Under Test (EUT)

2.1 Identification of EUT

Brand Name	iTOVi
Model Number	ITS31
Hardware Version	2.0
Serial Number	None
Dimensions (cm)	8.0 x 3.5 x 3.0

2.2 Description of EUT

The ITS31 combines bio-impedance, pressure sensor, temperature, and Bluetooth® technologies to generate personalized wellness evaluations. Power is provided by a 3.7 V LiPol battery.

The Bluetooth LE transceiver uses 40 channels from 2402 MHz to 2480 MHz, spaced 2 MHz apart. The antenna used is a trace on the PCB with a maximum gain of 2.7 dBi. A table showing the frequencies used by the EUT is shown below.

Channel	Frequency (MHz)	Channel	Frequency (MHz)	Channel	Frequency (MHz)	Channel	Frequency (MHz)
1	2402	11	2422	21	2442	31	2462
2	2404	12	2424	22	2444	32	2464
3	2406	13	2426	23	2446	33	2466
4	2408	14	2428	24	2448	34	2468
5	2410	15	2430	25	2450	35	2470
6	2412	16	2432	26	2452	36	2472
7	2414	17	2434	27	2454	37	2474
8	2416	18	2436	28	2456	38	2476
9	2418	19	2438	29	2458	39	2478
10	2420	20	2440	30	2460	40	2480

This report covers the circuitry of the devices subject to FCC Part 15, Subpart C. The circuitry of the device subject to FCC Subpart B is to be covered in separate testing and report.

2.3 EUT and Support Equipment

The EUT and support equipment used during the test are listed below.

Brand Name Model Number Serial Number	Description	Name of Interface Ports / Interface Cables
BN: iTOVi MN: ITS31 (Note 1) SN: None	Bio-impedance analyzer	See Section 2.4

Notes: (1) EUT

2.4 Interface Ports on EUT

Name of Ports	No. of Ports Fitted to EUT	Cable Description/Length
Charging	0 (Note 1)	
Note 1: Production firmware does not allow the transceiver to operate when the battery is charging.		

2.5 Modification Incorporated/Special Accessories on EUT

There were no modifications or special accessories required to comply with the specification.

2.6 Deviation from Test Standard

There were no deviations from the test specification.

3 Test Specification, Methods and Procedures

3.1 Test Specification

Title	FCC PART 15, Subpart C (47 CFR 15) 15.203, 15.207, and 15.247 Limits and methods of measurement of radio interference characteristics of radio frequency devices.
Purpose of Test	The tests were performed to demonstrate initial compliance

3.2 Methods & Procedures

3.2.1 §15.203 Antenna Requirement

An intentional radiator shall be designed to ensure that no antenna other than that furnished by the responsible party shall be used with the device. The use of a permanently attached antenna or of an antenna that uses a unique coupling to the intentional radiator shall be considered sufficient to comply with the provisions of this Section. The manufacturer may design the unit so that a broken antenna can be replaced by the user, but the use of a standard antenna jack or electrical connector is prohibited. This requirement does not apply to carrier current devices or to devices operated under the provisions of Sections 15.211, 15.213, 15.217, 15.219, or 15.221. Further, this requirement does not apply to intentional radiators that must be professionally installed, such as perimeter protection systems and some field disturbance sensors, or to other intentional radiators which, in accordance with Section 15.31(d), must be measured at the installation site. However, the installer shall be responsible for ensuring that the proper antenna is employed so that the limits in this Part are not exceeded.

3.2.2 §15.207 Conducted Limits

(a) Except as shown in paragraphs (b) and (c) of this section, for an intentional radiator that is designed to be connected to the public utility (AC) power line, the radio frequency voltage that is conducted back onto the AC power line on any frequency or frequencies, within the band 150 kHz to 30 MHz, shall not exceed the limits in the following table, as measured using a 50 μ H/50 ohms line impedance stabilization network (LISN). Compliance with the provisions of this paragraph shall be based on the measurement of the radio frequency voltage between each power line and ground at the power terminal. The lower limit applies at the boundary between the frequency ranges.

Frequency range (MHz)	Limit (dB μ V)	
	Quasi-peak	Average
0.15 to 0.50*	66 to 56*	56 to 46*
0.50 to 5	56	46
5 to 30	60	50

*Decreases with the logarithm of the frequency.

Table 1: Limits for conducted emissions at mains ports of Class B ITE.

3.2.3 §15.247 Operation within the bands 902 – 928 MHz, 2400 – 2483.5 MHz, and 5725 – 5850 MHz

- a) Operation under the provisions of this Section is limited to frequency hopping and digitally modulated intentional radiators that comply with the following provisions.

- 1) Frequency hopping systems shall have hopping channel carrier frequencies separated by a minimum of 25 kHz or the 20 dB bandwidth of the hopping channel, whichever is greater. Alternatively, frequency hopping systems operating in the 2400 – 2483.5 MHz band may have hopping channel carrier frequencies that are separated by 25 kHz or two-thirds of the 20 dB bandwidth of the hopping channel, whichever is greater, provided the systems operate with an output power no greater than 125 mW. The system shall hop to channel frequencies that are selected at the system hopping rate from a pseudorandomly ordered list of hopping frequencies. Each frequency must be used equally on the average by each transmitter. The system receivers shall have input bandwidths that match the hopping channel bandwidths of their corresponding transmitters and shall shift frequencies in synchronization with the transmitted signals.
 - i. For frequency hopping systems operating in the 902-928 MHz band: if the 20 dB bandwidth of the hopping channel is less than 250 kHz, the system shall use at least 50 hopping frequencies and the average time of occupancy on any frequency shall not be greater than 0.4 seconds within a 20 second period; if the 20 dB bandwidth of the hopping channel is 250 kHz or greater, the system shall use at least 25 hopping frequencies and the average time of occupancy on any frequency shall not be greater than 0.4 seconds within a 10 second period. The maximum allowed 20 dB bandwidth of the hopping channel is 500 kHz.
 - ii. Frequency hopping systems operating in the 5725-5850 MHz band shall use at least 75 hopping frequencies. The maximum 20 dB bandwidth of the hopping channel is 1 MHz. The average time of occupancy on any frequency shall not be greater than 0.4 seconds within a 30 second period.
 - iii. Frequency hopping systems in the 2400-2483.5 MHz band shall use at least 15 non-overlapping channels. The average time of occupancy on any channel shall not be greater than 0.4 seconds within a period of 0.4 seconds multiplied by the number of hopping channels employed. Frequency hopping systems may avoid or suppress transmissions on a particular hopping frequency provided that a minimum of 15 non-overlapping channels are used.
 - 2) Systems using digital modulation techniques may operate in the 902 - 928 MHz, 2400 - 2483.5 MHz, and 5725 - 5850 MHz bands. The minimum 6 dB bandwidth shall be at least 500 kHz.
- b) The maximum peak output power of the intentional radiator shall not exceed the following:
- 1) For frequency hopping systems operating in the 2400-2483.5 MHz band employing at least 75 non-overlapping hopping channels, and all frequency hopping systems in the 5725-5850 MHz band: 1 watt. For all other frequency hopping systems in the 2400-2483.5 MHz band: 0.125 watts.
 - 2) For frequency hopping systems operating in the 902-928 MHz band: 1 watt for systems employing at least 50 hopping channels; and, 0.25 watts for systems employing less than 50 hopping channels, but at least 25 hopping channels, as permitted under paragraph (a)(1)(i) of this section.

- 3) For systems using digital modulation in the 902-928 MHz, 2400-2483.5 MHz, and 5725 – 5850 MHz bands: 1 watt. As an alternative to a peak power measurement, compliance with the Conducted Output Power is defined as the total transmit power delivered to all antennas and antenna elements averaged across all symbols in the signaling alphabet when the transmitter is operating at its maximum power control level. Power must be summed across all antennas and antenna elements. The average must not include any time intervals during which the transmitter is off or is transmitting at a reduced power level. If multiple modes of operation are possible (e.g., alternative modulation methods), the maximum conducted output power is the highest total transmit power occurring in any mode.
 - 4) The conducted output power limit specified in paragraph (b) of this section is based on the use of antennas with directional gains that do not exceed 6 dBi. Except as shown in paragraph (c) of this section, if transmitting antennas of directional gain greater than 6 dBi are used, the conducted power from the intentional radiator shall be reduced below the stated values in paragraphs (b)(1), (b)(2), and (b)(3) of this section, as appropriate, by the amount in dB that the directional gain of the antenna exceeds 6 dBi.
- c) Operation with directional antenna gains greater than 6 dBi.
- 1) Fixed point-to-point operation:
 - i. Systems operating in the 2400-2483.5 MHz band that are used exclusively for fixed, point-to-point operations may employ transmitting antennas with directional gain greater than 6 dBi provided the maximum peak output power of the intentional radiator is reduced by 1 dB for every 3 dB that the directional gain of the antenna exceeds 6 dBi.
 - ii. Systems operating in the 5725-5850 MHz band that are used exclusively for fixed, point-to-point operations may employ transmitting antennas with directional gain greater than 6 dBi without any corresponding reduction in transmitter peak output power.
 - iii. Fixed, point-to-point operation, as used in paragraphs (b)(4)(i) and (b)(4)(ii) of this section, excludes the use of point-to-multipoint systems, omnidirectional applications, and multiple co-located intentional radiators transmitting the same information. The operator of the spread spectrum or digitally modulated intentional radiator or, if the equipment is professionally installed, the installer is responsible for ensuring that the system is used exclusively for fixed, point-to-point operations. The instruction manual furnished with the intentional radiator shall contain language in the installation instructions informing the operator and the installer of this responsibility.
 - 2) In addition to the provisions in paragraphs (b)(1), (b)(3), (b)(4) and (c)(1)(i) of this section, transmitters operating in the 2400-2483.5 MHz band that emit multiple directional beams, simultaneously or sequentially, for the purpose of directing signals to individual receivers or to groups of receivers provided the emissions comply with the following:
 - i. Different information must be transmitted to each receiver.

- ii. If the transmitter employs an antenna system that emits multiple directional beams but does not emit multiple directional beams simultaneously, the total output power conducted to the array or arrays that comprise the device, i.e., the sum of the power supplied to all antennas, antenna elements, staves, etc. and summed across all carriers or frequency channels, shall not exceed the limit specified in paragraph (b)(1) or (b)(3) of this section, as applicable. However, the total conducted output power shall be reduced by 1 dB below the specified limits for each 3 dB that the directional gain of the antenna /antenna array exceeds 6 dBi. The directional antenna gain shall be computed as follows:
 - A. The directional gain shall be calculated as the sum of 10 log (number of array elements or staves) plus the directional gain of the element or stave having the highest gain.
 - B. A lower value for the directional gain than that calculated in paragraph (c)(2)(ii)(A) of this section will be accepted if sufficient evidence is presented, e.g., due to shading of the array or coherence loss in the beamforming.
 - iii. If a transmitter employs an antenna that operates simultaneously on multiple directional beams using the same or different frequency channels, the power supplied to each emission beam is subject to the power limit specified in paragraph (c)(2)(ii) of this section. If transmitted beams overlap, the power shall be reduced to ensure that their aggregate power does not exceed the limit specified in paragraph (c)(2)(ii) of this section. In addition, the aggregate power transmitted simultaneously on all beams shall not exceed the limit specified in paragraph (c)(2)(ii) of this section by more than 8 dB.
 - iv. Transmitters that emit a single directional beam shall operate under the provisions of paragraph (c)(1) of this section.
- d) In any 100 kHz bandwidth outside the frequency band in which the spread spectrum or digitally modulated intentional radiator is operating, the radio frequency power that is produced by the intentional radiator shall be at least 20 dB below that in the 100 kHz bandwidth within the band that contains the highest level of the desired power, based on either an RF conducted or a radiated measurement, provided the transmitter demonstrates compliance with the peak conducted power limits. If the transmitter complies with the conducted power limits based on the use of RMS averaging over a time interval, as permitted under paragraph (b)(3) of this section, the attenuation required under this paragraph shall be 30 dB instead of 20 dB. Attenuation below the general limits specified in Section 15.209(a) is not required. In addition, radiated emissions which fall in the restricted bands, as defined in Section 15.205(a), must also comply with the radiated emission limits specified in Section 15.209(a) (see Section 15.205(c)).
 - e) For digitally modulated systems, the power spectral density conducted from the intentional radiator to the antenna shall not be greater than 8 dBm in any 3 kHz band during any time interval of continuous transmission. This power spectral density shall be determined in accordance with the provisions of paragraph (b) of this section. The same method of determining the conducted output power shall be used to determine the power spectral density.
 - f) For the purposes of this section, hybrid systems are those that employ a combination of both frequency hopping and digital modulation techniques. The frequency hopping operation of the hybrid system, with the direct sequence or digital modulation operation turned off, shall have an

average time of occupancy on any frequency not to exceed 0.4 seconds within a time period in seconds equal to the number of hopping frequencies employed multiplied by 0.4. The digital modulation operation of the hybrid system, with the frequency hopping turned off, shall comply with the power density requirements of paragraph (d) of this section.

- g) Frequency hopping spread spectrum systems are not required to employ all available hopping channels during each transmission. However, the system, consisting of both the transmitter and the receiver, must be designed to comply with all of the regulations in this section should the transmitter be presented with a continuous data (or information) stream. In addition, a system employing short transmission bursts must comply with the definition of a frequency hopping system and must distribute its transmissions over the minimum number of hopping channels specified in this section.
- h) The incorporation of intelligence within a frequency hopping spread spectrum system that permits the system to recognize other users within the spectrum band so that it individually and independently chooses and adapts its hops to avoid hopping on occupied channels is permitted. The coordination of frequency hopping systems in any other manner for the express purpose of avoiding the simultaneous occupancy of individual hopping frequencies by multiple transmitters is not permitted.
- i) Systems operating under the provisions of this section shall be operated in a manner that ensures that the public is not exposed to radio frequency energy levels in excess of the Commission's guidelines. See § 1.1307(b)(1) of this Chapter.

Note: Spread spectrum systems are sharing these bands on a noninterference basis with systems supporting critical Government requirements that have been allocated the usage of these bands, secondary only to ISM equipment operated under the provisions of Part 18 of this Chapter. Many of these Government systems are airborne radiolocation systems that emit a high EIRP which can cause interference to other users. Also, investigations of the effect of spread spectrum interference to U. S. Government operations in the 902-928 MHz band may require a future decrease in the power limits allowed for spread spectrum operation.

3.3 Test Procedure

The testing was performed according to the procedures in ANSI C63.10-2013, KDB 558074, and 47 CFR Part 15. Testing was performed at the VPI Laboratories, Inc. Wanship Upper Open Area Test Site, located at 29145 Old Lincoln Highway, Wanship, UT. VPI Laboratories, Inc. is accredited by National Voluntary Laboratory Accreditation Program (NVLAP); NVLAP Lab Code: 100272-0, which is effective until September 30, 2018. VPI Laboratories, Inc. carries FCC Accreditation Designation Number US5263.

4 Operation of EUT During Testing

4.1 Operating Environment

Power Supply	3.7 VDC LiPol battery
--------------	-----------------------

4.2 Operating Modes

The transmitter was tested on 3 orthogonal axes while in a constant transmit mode at the upper, middle, and lower channels. A fully charged battery was used for testing. A short cable with a header was extended from the EUT PCB to allow a computer to be temporarily connected to set the transceiver in the desired mode.

4.3 EUT Exercise Software

iTOVi 3.0 was used to exercise the EUT.

5 Summary of Test Results

5.1 FCC Part 15, Subpart C

5.1.1 Summary of Tests

Section	Environmental Phenomena	Frequency Range (MHz)	Result
15.203	Antenna Requirements	Structural requirement	Complied
15.207	Conducted Disturbance at Mains Ports	0.15 to 30	Not Applicable (Note 1)
15.247(a)	Bandwidth Requirement	2400 to 2483.5	Complied
15.247(b)	Peak Output Power	2400 to 2483.5	Complied
15.247(d)	Spurious Emissions	0.009 - 25000	Complied
15.247(e)	Peak Power Spectral Density	2400 to 2483.5	Complied
Note 1: Production firmware does not allow the transceiver to operate when the battery is charging.			

5.2 Result

In the configuration tested, the EUT complied with the requirements of the specification.

6 Measurements, Examinations and Derived Results

6.1 General Comments

This section contains the test results only. Details of the test methods used and a list of the test equipment used during the measurements can be found in Section 7 of this report.

6.2 Test Results

6.2.1 §15.203 Antenna Requirements

The EUT uses a trace on the PCB as an antenna with a maximum gain of 2.7 dBi and is not user accessible or replaceable. The antenna gain was calculated comparing radiated measurements of the EUT and a half wave length dipole antenna (2.15 dBi per 1.3 of KDB 412172 v01r01).

Result

The EUT complied with the specification.

6.2.2 §15.247(a)(2) Emissions Bandwidth

Frequency (MHz)	Emissions 6 dB bandwidth (kHz)
2402	789
2440	789
2480	855

Result

In the configuration tested, the 6 dB bandwidth was greater than 500 kHz; therefore, the EUT complied with the requirements of the specification (see spectrum analyzer plots below).

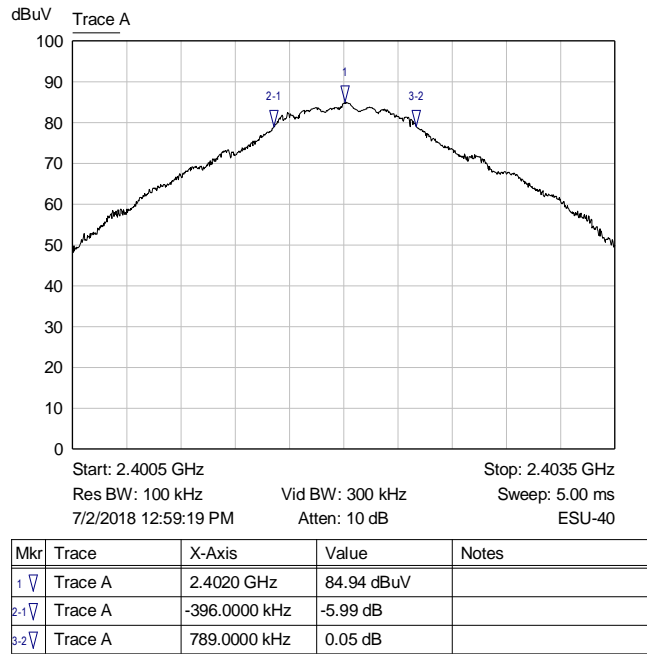
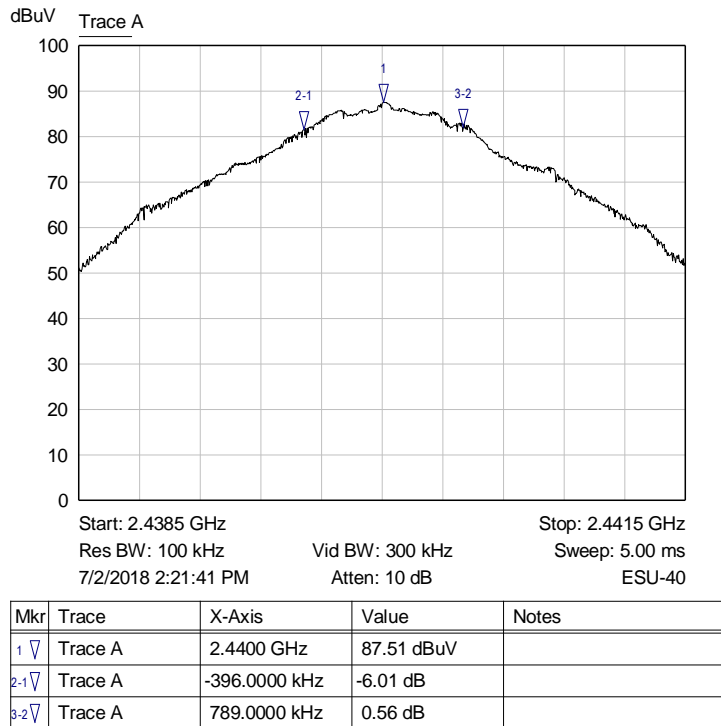
Graph 1: Lowest Channel Bandwidth

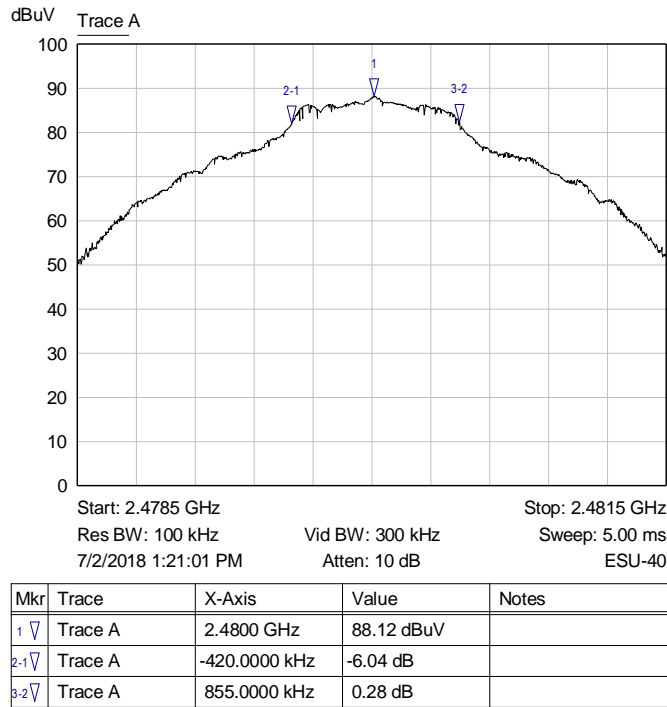
Graph 2: Middle Channel Bandwidth



Graph 3: Highest Channel Bandwidth

6.2.3 §15.247(b)(3) Peak Output Power

The maximum peak RF power measured using radiated methods as an integral antenna with no provision for doing a direct connection at the antenna port provided. The field strength measurements were converted to EIRP using the equation 1.1 of FCC KDB 412172. The antenna gain was then subtracted from the calculated EIRP to give a calculated conducted power and compared to the limit of 1 Watt.

Frequency (MHz)	Measured Field Strength (dBµV/m)	EIRP (mW)	EIRP (dBm)	Calculated Conducted Power (dBm)	Calculated Conducted Power (W)
2402	87.57	0.17	-7.66	-10.36	0.00009
2440	88.14	0.20	-7.09	-9.79	0.00010
2480	88.78	0.23	-6.45	-9.15	0.00012

Result

In the configuration tested, the maximum peak power was less than 1 Watt; therefore, the EUT complied with the requirements of the specification (see spectrum analyzer plots below).

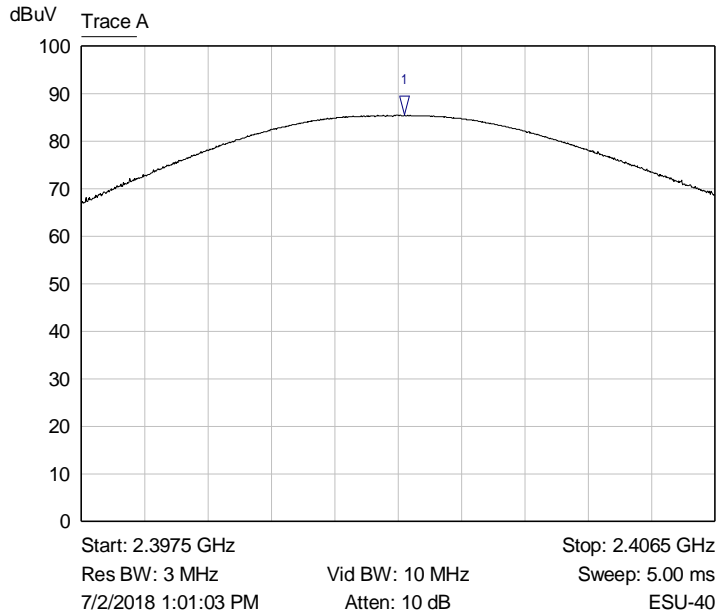

Mkr	Trace	X-Axis	Value	Notes
1 ▾	Trace A	2.4021 GHz	85.57 dBuV	

Graph 4: Lowest Channel Output Power Plot

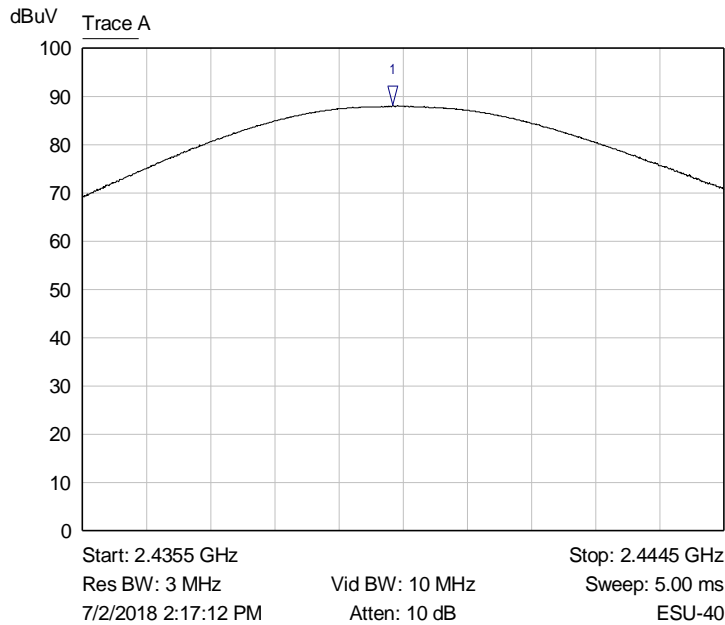

Mkr	Trace	X-Axis	Value	Notes
1 ▾	Trace A	2.4399 GHz	88.14 dBuV	

Graph 5: Middle Channel Output Power

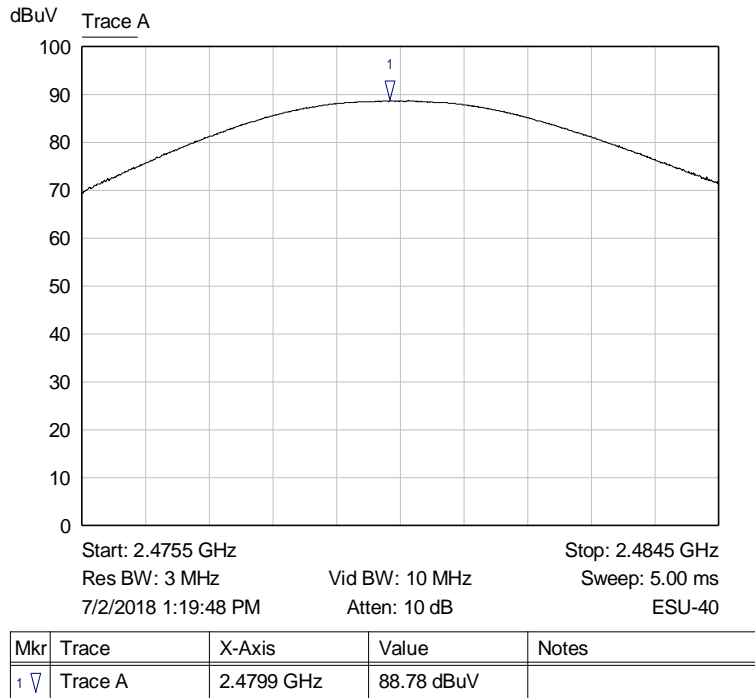

Graph 6: Highest Channel Output Power Plot

6.2.4 §15.247(d) Spurious Emissions

The frequency range from the lowest frequency generated or used in the device to the tenth harmonic of the highest fundamental emission was investigated to measure any radiated emissions. The following tables show measurements of any emission found. The tables show the worst-case emission measured from the EUT. For frequencies above 18.0 GHz, a measurement distance of 1 meter was used. The noise floor was a minimum of 6 dB below the limit. All emissions were compared to the limits specified in §15.209. Tabular data for each of the spurious emissions is shown below for each of the units. Plots of the band edges are also shown.

Result

All emissions were compared to the tighter limits of §15.209 and all emissions met the limits of §15.209; therefore, the EUT complies with the specification.

Frequency (MHz)	Detector	Antenna Polarity	Receiver Reading (dBµV)	Correction Factor (dB)	Field Strength (dBµV/m)	Limit (dBµV/m)	Margin (dB)
4804.0	Peak	Vertical	10.0	39.5	49.5	74.0	-24.5
4804.0	Average	Vertical	5.7	39.5	45.2	54.0	-8.8
4804.0	Peak	Horizontal	11.2	39.5	50.7	74.0	-23.3
4804.0	Average	Horizontal	6.0	39.5	45.5	54.0	-8.5
7206.0	Peak	Vertical	11.9	44.4	56.3	74.0	-17.7
7206.0	Average	Vertical	4.0	44.4	48.4	54.0	-5.6

Frequency (MHz)	Detector	Antenna Polarity	Receiver Reading (dBμV)	Correction Factor (dB)	Field Strength (dBμV/m)	Limit (dBμV/m)	Margin (dB)
7206.0	Peak	Horizontal	10.8	44.4	55.2	74.0	-18.8
7206.0	Average	Horizontal	1.3	44.4	45.7	54.0	-8.3

Table 2: Transmitting at the Lowest Frequency

Frequency (MHz)	Detector	Antenna Polarity	Receiver Reading (dBμV)	Correction Factor (dB)	Field Strength (dBμV/m)	Limit (dBμV/m)	Margin (dB)
4880.0	Peak	Vertical	8.3	39.7	48.0	74.0	-26.0
4880.0	Average	Vertical	2.4	39.7	42.1	54.0	-11.9
4880.0	Peak	Horizontal	10.5	39.7	50.2	74.0	-23.8
4880.0	Average	Horizontal	5.9	39.7	45.6	54.0	-8.4
7320.0	Peak	Vertical	10.5	44.7	55.2	74.0	-18.8
7320.0	Average	Vertical	3.9	44.7	48.6	54.0	-5.4
7320.0	Peak	Horizontal	8.5	44.7	53.2	74.0	-20.8
7320.0	Average	Horizontal	1.0	44.7	45.7	54.0	-8.3

Table 3: Transmitting at the Middle Frequency

Frequency (MHz)	Detector	Antenna Polarity	Receiver Reading (dBμV)	Correction Factor (dB)	Field Strength (dBμV/m)	Limit (dBμV/m)	Margin (dB)
4960.0	Peak	Vertical	8.8	39.9	48.7	74.0	-25.3
4960.0	Average	Vertical	4.7	39.9	44.6	54.0	-9.4
4960.0	Peak	Horizontal	10.2	39.9	50.1	74.0	-23.9
4960.0	Average	Horizontal	7.6	39.9	47.5	54.0	-6.5
7440.0	Peak	Vertical	8.0	45.1	53.1	74.0	-20.9
7440.0	Average	Vertical	0.8	45.1	45.9	54.0	-8.1
7440.0	Peak	Horizontal	7.5	45.1	52.6	74.0	-21.4
7440.0	Average	Horizontal	0.8	45.1	45.9	54.0	-8.1

Table 4: Transmitting at the Highest Frequency

No other emissions were seen.

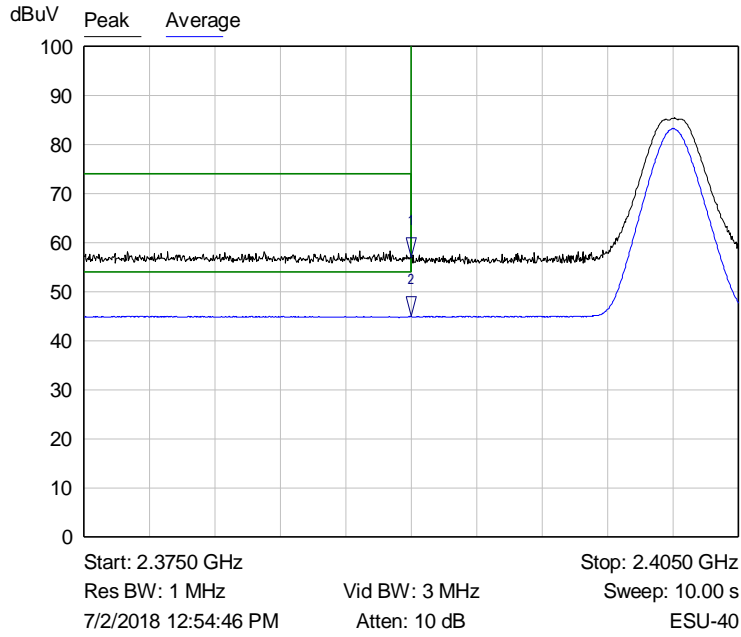

Mkr	Trace	X-Axis	Value	Notes
1 ▾	Peak	2.3900 GHz	56.95 dBuV	
2 ▾	Average	2.3900 GHz	44.94 dBuV	

Graph 7: Radiated Lower Band Edge Plot

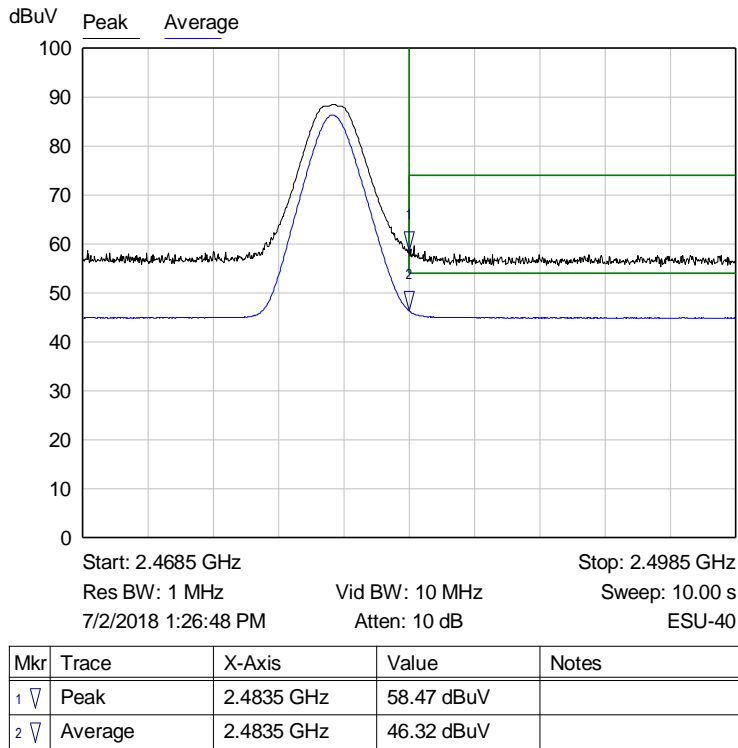

Graph 8: Radiated Upper Band Edge Plot

6.2.5 §15.247(e) Peak Power Spectral Density

The maximum peak 3 kHz spectral density measured using radiated methods as an integral antenna with no provision for doing a direct connection at the antenna port provided. The field strength measurements were converted to EIRP using the equation 1.1 of FCC KDB 412172. The maximum antenna gain of 2.7 dBi was then subtracted from the calculated EIRP and was then compared to the limit of 8 dBm.

Frequency (MHz)	Measurement (dBuV/m)	EIRP (dBm)	Calculated Conducted PSD (dBm)
2402	71.16	-24.07	-26.77
2440	74.21	-21.02	-23.29
2480	75.43	-19.80	-22.50

Result

The maximum peak power spectral density was less than the limit of 8 dB; therefore, the EUT complies with the specification.

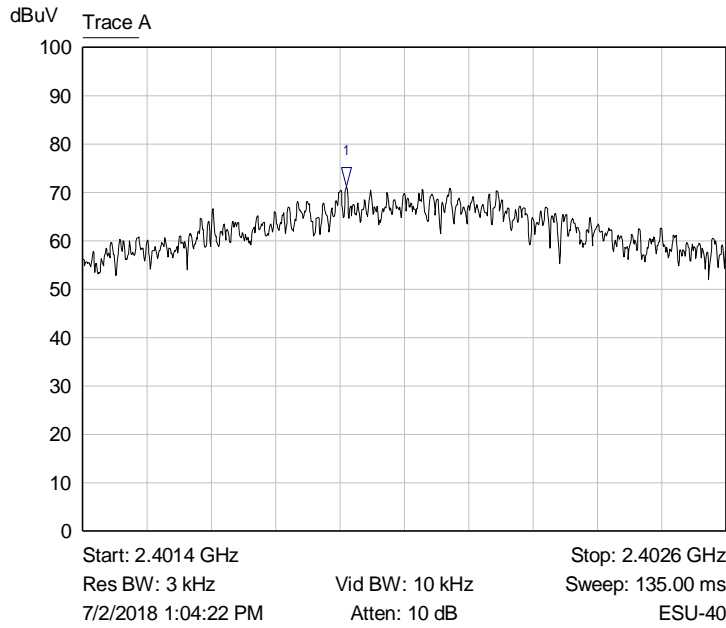

Mkr	Trace	X-Axis	Value	Notes
1 ▽	Trace A	2.4019 GHz	71.16 dBuV	

Graph 9: Lowest Channel 3 kHz PSD Plot

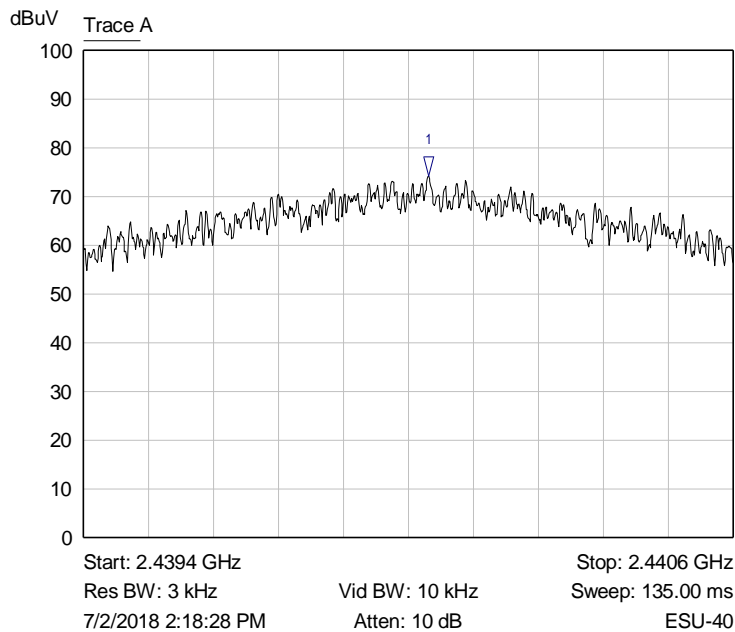

Mkr	Trace	X-Axis	Value	Notes
1 ▽	Trace A	2.4400 GHz	74.21 dBuV	

Graph 10: Middle Channel 3 kHz PSD Plot

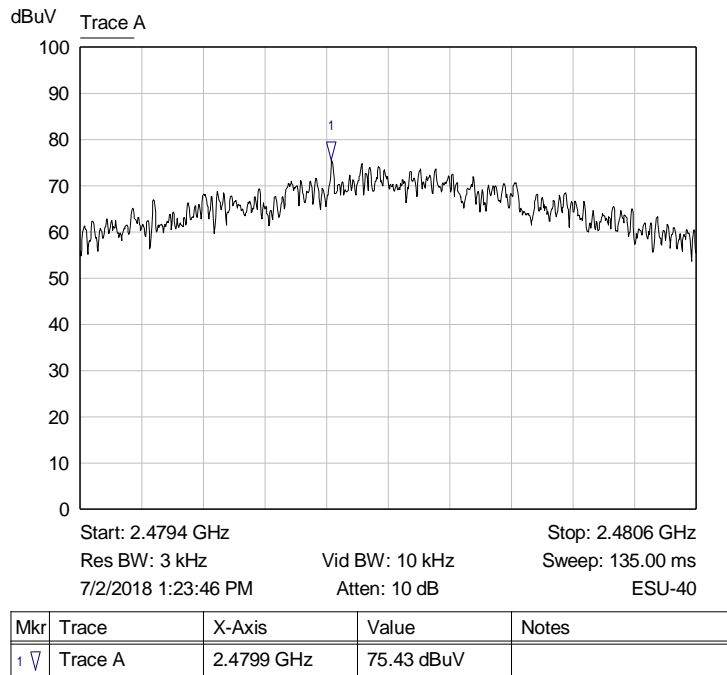

Graph 11: Highest Channel Output 3 kHz PSD Plot

7 Test Procedures and Test Equipment

7.1 Radiated Emissions

The radiated emissions from the EUT were measured using a spectrum analyzer with a quasi-peak adapter for peak and quasi-peak readings.

A preamplifier with a fixed gain of 51 dB was used to increase the sensitivity of the measuring instrumentation. The quasi-peak adapter uses a bandwidth of 120 kHz, with the spectrum analyzer's resolution bandwidth set at 1 MHz, for readings in the 30 to 1000 MHz frequency ranges. For frequencies below 30 MHz, a 9 kHz resolution Bandwidth was used.

A loop antenna was used to measure frequencies below 30 MHz. A biconilog antenna was used to measure the frequency range of 30 to 1000 MHz, at a distance of 3 meters from the EUT. The readings obtained by these antennas are correlated to the levels obtained with a tuned dipole antenna by adding antenna factors. A double-ridged guide antenna was used to measure the emissions at frequencies above 1000 MHz at a distance of 3 and/or 1 meter from the EUT.

The configuration of the EUT was varied to find the maximum radiated emission. The EUT was connected to the peripherals listed in Section 2.3 via the interconnecting cables listed in Section 2.4. A technician manually manipulated these interconnecting cables to obtain worst-case radiated emissions. The EUT was rotated 360 degrees, and the antenna height was varied from 1 to 4 meters to find the maximum radiated emission. Where there were multiple interface ports all of the same type, cables are either placed on all of the ports or cables added to these ports until the emissions do not increase by more than 2 dB.

Desktop EUT are measured on a non-conducting table 0.8 meters above the ground plane. For frequencies above 1000 MHz, the EUT is placed on a table 1.5 meters above the ground plane. The table is placed on a turntable, which is level with the ground plane. For equipment normally placed on floors, the equipment shall be placed directly on the turntable.

For radiated emissions testing that is performed at distances closer than the specified distance; an inverse proportionality factor of 20 dB per decade is used to normalize the measured data for determining compliance.

Type of Equipment	Manufacturer	Model Number	Asset Number	Date of Last Calibration	Due Date of Calibration
Spectrum Analyzer/Receiver	Rohde & Schwarz	ESU40	V033119	06/06/2017	07/06/2018
Spectrum Analyzer	Hewlett Packard	8566B	V034141	03/05/2018	03/05/2019
Quasi-Peak Detector	Hewlett Packard	85650A	V033345	08/04/2017	08/04/2018
Loop Antenna	EMCO	6502	V034216	01/25/2017	01/25/2019
Biconilog Antenna with 6 dB attenuator and preamp	EMCO	3142	V034155	01/13/2017	01/13/2019
Double Ridged Guide Antenna	EMCO	3115	V034194	03/08/2017	03/08/2019
Standard Gain Horn	ETS-Lindgren	3160-09	V034223	ICO	ICO
High Frequency Amplifier	Miteq	AFS4-001018000-35-10P-4	V033997	01/09/2018	01/09/2019

Type of Equipment	Manufacturer	Model Number	Asset Number	Date of Last Calibration	Due Date of Calibration
2.4 GHz Notch Filter	Micro-Tronics	BRM50702-03	V034213	01/09/2018	01/09/2019
6' High Frequency Cable	Microcoax	UFB197C-0-0720-000000	V033638	01/09/2018	01/09/2019
20' High Frequency Cable	Microcoax	UFB197C-1-3120-000000	V033979	01/09/2018	01/09/2019
3 Meter Radiated Emissions Cable Wanship Upper Site	Microcoax	UFB205A-0-4700-000000	V033639	01/09/2018	01/09/2019
Test Software (FCC)	VPI Labs	Revision 01	V035673	N/A	N/A

Table 5: List of equipment used for radiated emissions testing.

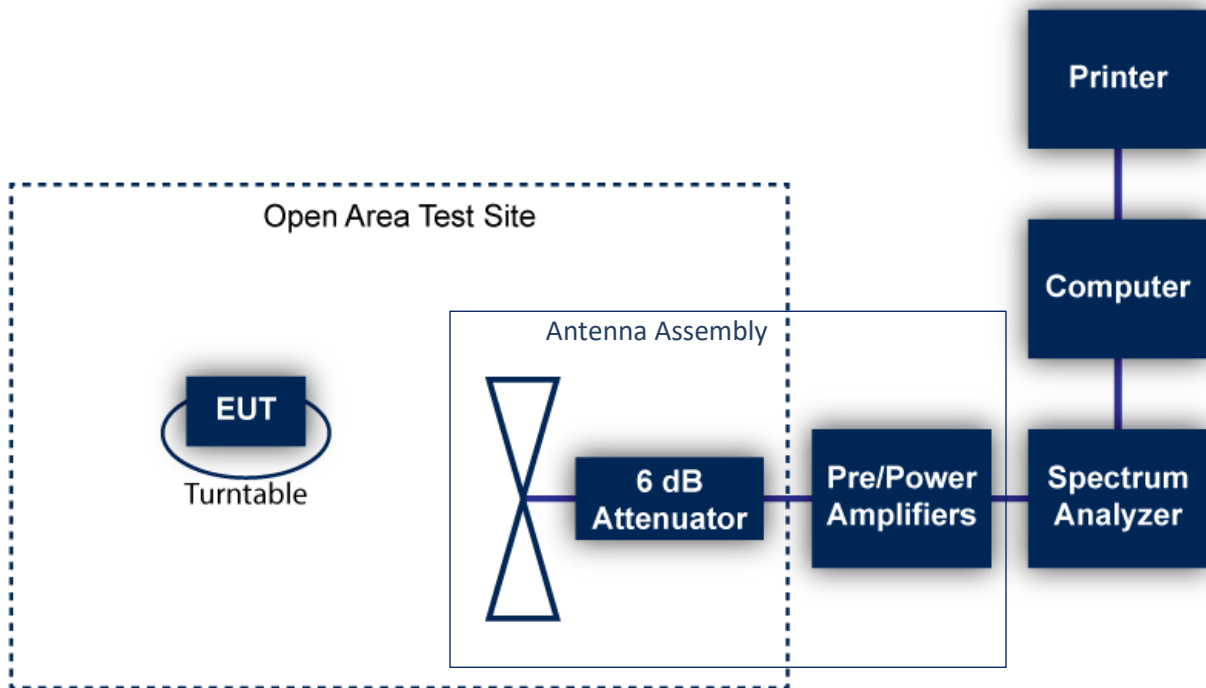

Figure 1: Radiated Emissions Test

7.2 Equipment Calibration

All applicable equipment is calibrated using either an independent calibration laboratory or VPI Laboratories, Inc. personnel at intervals defined in ANSI C63.4:2014 following outlined calibration procedures. All measurement instrumentation is traceable to the National Institute of Standards and Technology (NIST). Supporting documentation relative to tractability is on file and is available for examination upon request.

7.3 Measurement Uncertainty

Test	Uncertainty (\pm dB)	Confidence (%)
Conducted Emissions	2.8	95
Radiated Emission (9 kHz to 30 MHz)	3.3	95
Radiated Emissions (30 MHz to 1 GHz)	3.4	95
Radiated Emissions (1 GHz to 18 GHz)	5.0	95
Radiated Emissions (18 GHz to 40 GHz)	4.1	95

8 Photographs

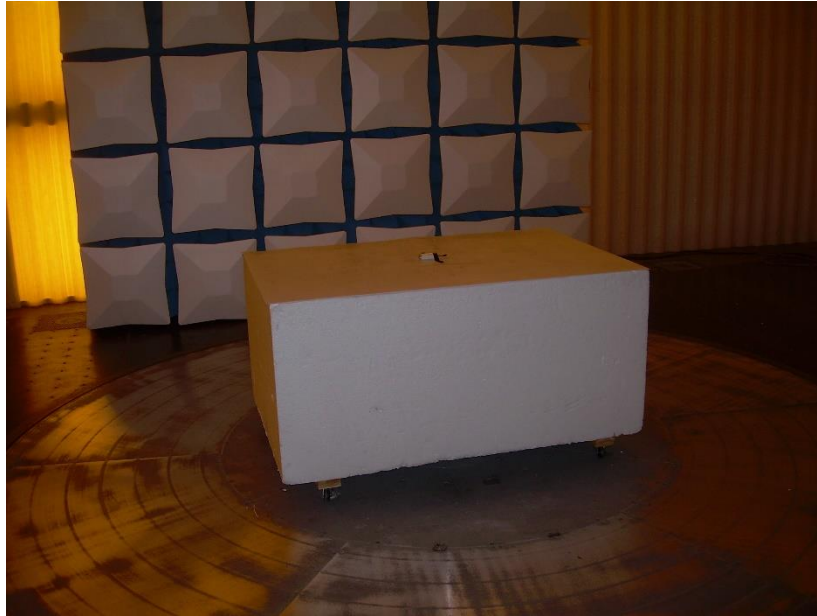

Photograph 1: Front View Radiated Emissions – Below 1000 MHz

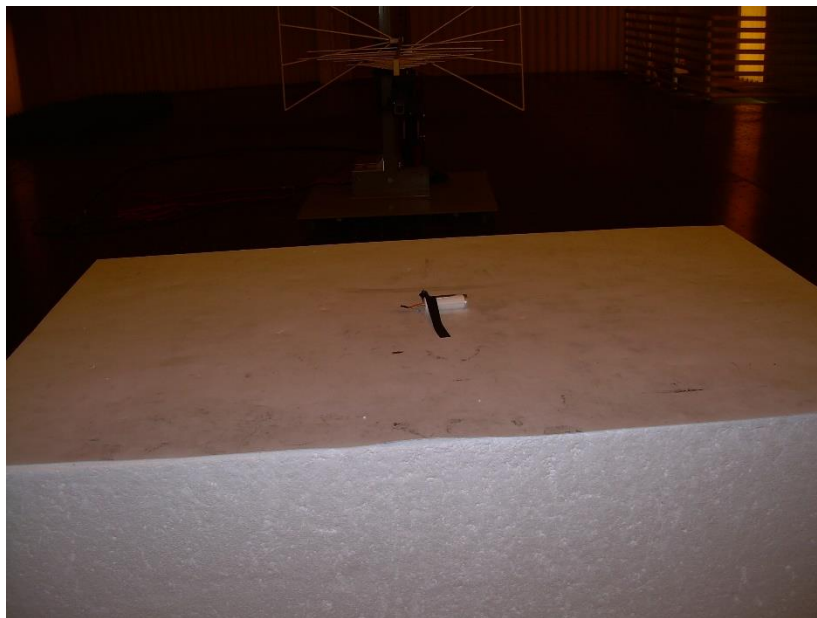

Photograph 2: Back View Radiated Emissions – 30 MHz to 1000 MHz

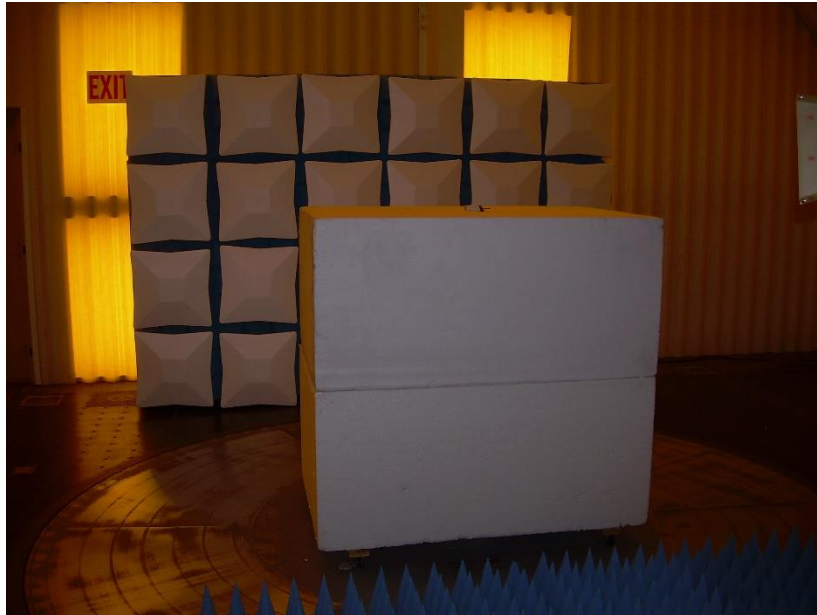

Photograph 3 – Front View Radiated Emissions – Above 1000 MHz



Photograph 4 – Back View Radiated Emissions – Above 1000 MHz

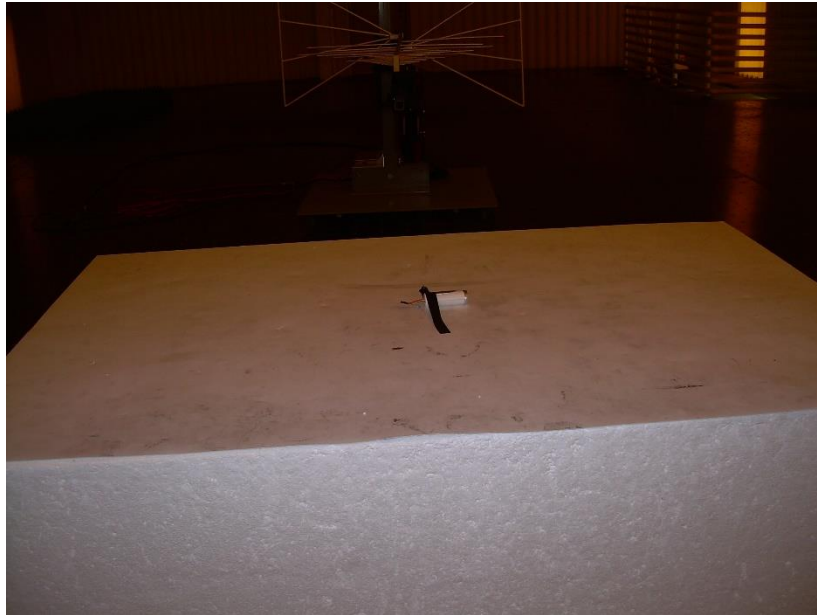

Photograph 5 – Flat Orientation

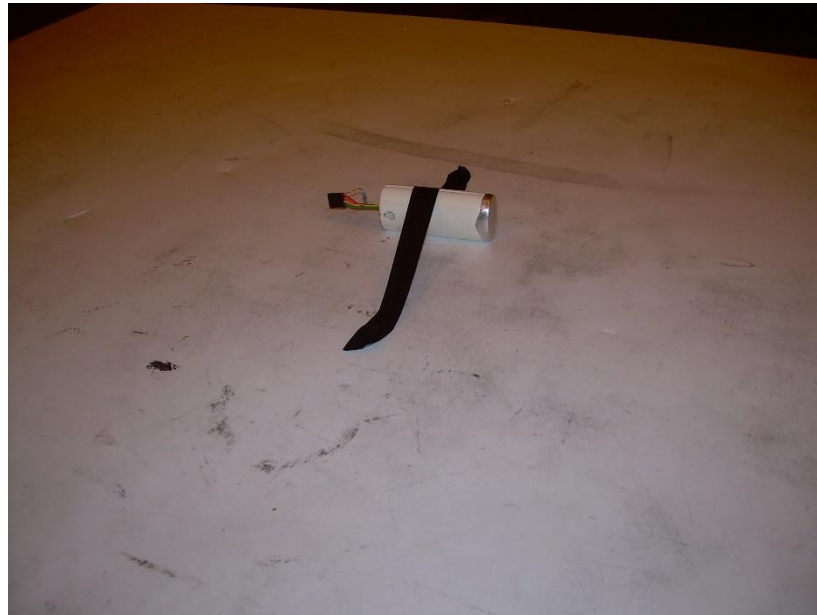

Photograph 6 – On Edge Orientation



Photograph 7 –Vertical Orientation



Photograph 8 – Top View of the EUT



Photograph 9 – Bottom View of the EUT



Photograph 10 – View of Switch/Charging End of the EUT



Photograph 11 – End View of the EUT

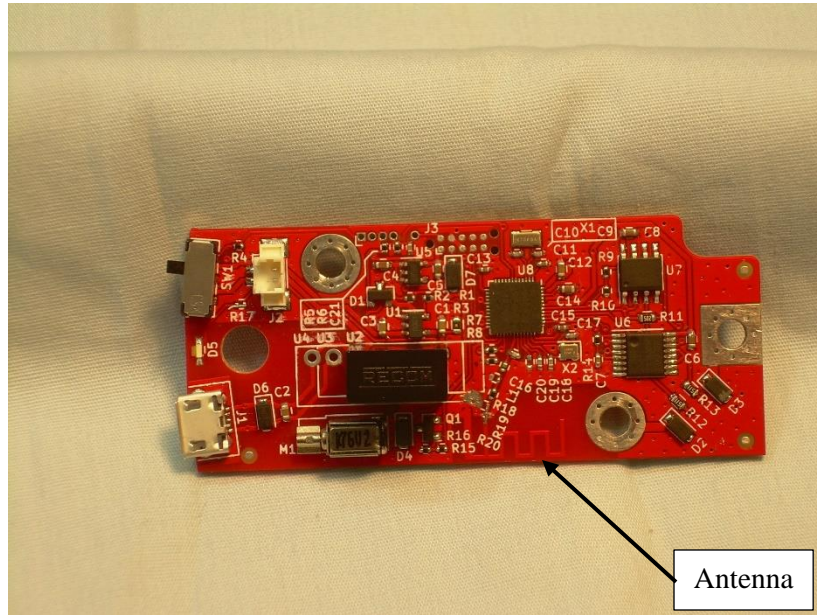

Photograph 12 – View of the Component Side of the PCB

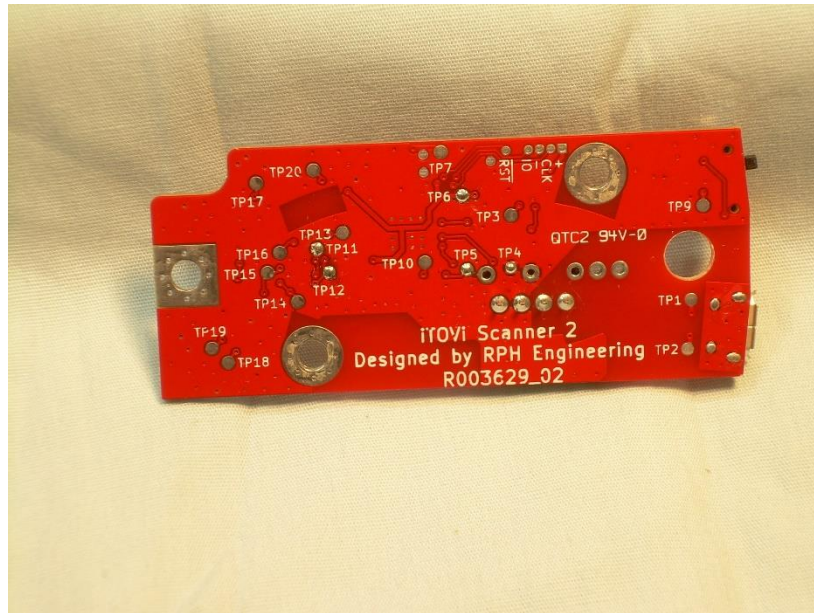

Photograph 13 – View of the Trace Side of the PCB

--- End of Report ---