

FCC Test Report

Report No.: RF150713C14-1

FCC ID: VPYLB1ES

Test Model: LBEQ6ZZ1ES

Received Date: Jul. 13, 2015

Test Date: Jul. 22 ~ Sep. 11, 2015

Issued Date: Sep. 16, 2015

Applicant: Murata Manufacturing Co., Ltd.

Address: 10-1, Higashikotari 1-chome, Nagaokakyo-shi, Kyoto 617-8555, Japan

Issued By: Bureau Veritas Consumer Products Services (H.K.) Ltd., Taoyuan Branch

Lab Address: No. 47-2, 14th Ling, Chia Pau Vil., Lin Kou Dist., New Taipei City, Taiwan, R.O.C.

Lab Address: No.19, Hwa Ya 2nd Rd., Wen Hwa Vil., Kwei Shan Dist., Taoyuan City 33383, TAIWAN (R.O.C.)



This report is for your exclusive use. Any copying or replication of this report to or for any other person or entity, or use of our name or trademark, is permitted only with our prior written permission. This report sets forth our findings solely with respect to the test samples identified herein. The results set forth in this report are not indicative or representative of the quality or characteristics of the lot from which a test sample was taken or any similar or identical product unless specifically and expressly noted. Our report includes all of the tests requested by you and the results thereof based upon the information that you provided to us. You have 60 days from date of issuance of this report to notify us of any material error or omission caused by our negligence, provided, however, that such notice shall be in writing and shall specifically address the issue you wish to raise. A failure to raise such issue within the prescribed time shall constitute your unqualified acceptance of the completeness of this report, the tests conducted and the correctness of the report contents. Unless specific mention, the uncertainty of measurement has been explicitly taken into account to declare the compliance or non-compliance to the specification. The report must not be used by the client to claim product certification, approval, or endorsement by TAF or any government agencies.

Table of Contents

Release Control Record	4
1 Certificate of Conformity	5
2 Summary of Test Results	6
2.1 Measurement Uncertainty.....	6
2.2 Modification Record.....	6
3 General Information	7
3.1 General Description of EUT.....	7
3.2 Description of Test Modes.....	8
3.2.1 Test Mode Applicability and Tested Channel Detail.....	10
3.3 Duty Cycle of Test Signal.....	12
3.4 Description of Support Units.....	13
3.4.1 Configuration of System under Test.....	13
3.5 General Description of Applied Standards.....	13
4 Test Types and Results	14
4.1 Radiated Emission and Bandedge Measurement.....	14
4.1.1 Limits of Radiated Emission and Bandedge Measurement.....	14
4.1.2 Test Instruments.....	15
4.1.3 Test Procedures.....	16
4.1.4 Deviation from Test Standard.....	16
4.1.5 Test Set Up.....	17
4.1.6 EUT Operating Conditions.....	17
4.1.7 Test Results.....	18
4.2 Conducted Emission Measurement.....	56
4.2.1 Limits of Conducted Emission Measurement.....	56
4.2.2 Test Instruments.....	56
4.2.3 Test Procedures.....	56
4.2.4 Deviation from Test Standard.....	57
4.2.5 Test Setup.....	57
4.2.6 EUT Operating Conditions.....	57
4.2.7 Test Results.....	58
4.3 Transmit Power Measurement.....	60
4.3.1 Limits of Transmit Power Measurement.....	60
4.3.2 Test Setup.....	60
4.3.3 Test Instruments.....	60
4.3.4 Test Procedure.....	61
4.3.5 Deviation from Test Standard.....	61
4.3.6 EUT Operating Conditions.....	61
4.3.7 Test Result.....	62
4.4 Peak Power Spectral Density Measurement.....	72
4.4.1 Limits of Peak Power Spectral Density Measurement.....	72
4.4.2 Test Setup.....	72
4.4.3 Test Instruments.....	72
4.4.4 Test Procedures.....	72
4.4.5 Deviation from Test Standard.....	73
4.4.6 EUT Operating Conditions.....	73
4.4.7 Test Results.....	74
4.5 Frequency Stability.....	79
4.5.1 Limits of Frequency Stability Measurement.....	79
4.5.2 Test Setup.....	79
4.5.3 Test Instruments.....	79
4.5.4 Test Procedure.....	79
4.5.5 Deviation from Test Standard.....	79
4.5.6 EUT Operating Condition.....	79

4.5.7 Test Results	80
4.6 6dB Bandwidth Measurement	81
4.6.1 Limits of 6dB Bandwidth Measurement	81
4.6.2 Test Setup	81
4.6.3 Test Instruments	81
4.6.4 Test Procedure	81
4.6.5 Deviation from Test Standard	81
4.6.6 EUT Operating Condition	81
4.6.7 Test Results	82
5 Pictures of Test Arrangements	84
Appendix – Information on the Testing Laboratories	85



A D T

Release Control Record

Issue No.	Description	Date Issued
RF150713C14-1	Original release	Sep. 16, 2015

1 Certificate of Conformity

Product: Communication Module
Brand: MURATA
Test Model: LBEQ6ZZ1ES
Sample Status: Engineering sample
Applicant: Murata Manufacturing Co., Ltd.
Test Date: Jul. 22 ~ Sep. 11, 2015
Standards: 47 CFR FCC Part 15, Subpart E (Section 15.407)
ANSI C63.10:2013

The above equipment has been tested by **Bureau Veritas Consumer Products Services (H.K.) Ltd., Taoyuan Branch**, and found compliance with the requirement of the above standards. The test record, data evaluation & Equipment Under Test (EUT) configurations represented herein are true and accurate accounts of the measurements of the sample's EMC characteristics under the conditions specified in this report.

Prepared by :  , **Date:** Sep. 16, 2015
Pettie Chen / Senior Specialist

Approved by :  , **Date:** Sep. 16, 2015
Ken Liu / Senior Manager

2 Summary of Test Results

47 CFR FCC Part 15, Subpart E (Section 15.407)			
FCC Clause	Test Item	Result	Remarks
15.207 15.407(b)(6)	AC Power Conducted Emissions	Pass	Meet the requirement of limit. Minimum passing margin is -19.36dB at 0.15782MHz.
15.407(b) (1/2/3/4/6)	Radiated Emissions & Band Edge Measurement	Pass	Meet the requirement of limit. Minimum passing margin is -1.0dB at 62.89, 5150.00, 5350.00, 5470.00, 5714.00, 5725.00, 5861.00MHz.
15.407(a)(1/2 /3)	Max Average Transmit Power	Pass	Meet the requirement of limit.
15.407(a)(1/2 /3)	Peak Power Spectral Density	Pass	Meet the requirement of limit.
15.407(e)	6dB bandwidth	Pass	Meet the requirement of limit. (U-NII-3 Band only)
15.407(g)	Frequency Stability	Pass	Meet the requirement of limit.
15.203	Antenna Requirement	Pass	Antenna connector is RP-SMA Male Straight Connector not a standard connector.

2.1 Measurement Uncertainty

Where relevant, the following measurement uncertainty levels have been estimated for tests performed on the EUT as specified in CISPR 16-4-2:

Measurement	Frequency	Expanded Uncertainty (k=2) (\pm)
Conducted Emissions at mains ports	150kHz ~ 30MHz	2.44 dB
Radiated Emissions up to 1 GHz	30MHz ~ 200MHz	3.59 dB
	200MHz ~ 1000MHz	3.60 dB
Radiated Emissions above 1 GHz	1GHz ~ 18GHz	2.29 dB
	18GHz ~ 40GHz	2.29 dB

2.2 Modification Record

There were no modifications required for compliance.

3 General Information

3.1 General Description of EUT

Product	Communication Module
Brand	MURATA
Test Model	LBEQ6ZZ1ES
Sample Status	Engineering sample
Power Supply Rating	3.3Vdc (host)
Modulation Type	256QAM, 64QAM, 16QAM, QPSK, BPSK
Modulation Technology	OFDM
Transfer Rate	802.11a: 54.0/ 48.0/ 36.0/ 24.0/ 18.0/ 12.0/ 9.0/ 6.0Mbps 802.11n: up to 135Mbps 802.11ac: up to 390Mbps
Operating Frequency	5180 ~ 5240MHz, 5260 ~ 5320MHz, 5500 ~ 5700MHz & 5745 ~ 5825MHz
Number of Channel	5180MHz ~ 5240MHz 802.11a, 802.11n (HT20), 802.11ac (VHT20): 4 802.11n (HT40), 802.11ac (VHT40): 2 802.11ac (VHT80): 1 5260MHz ~ 5320MHz: 802.11a, 802.11n (HT20), 802.11ac (VHT20): 4 802.11n (HT40), 802.11ac (VHT40): 2 802.11ac (VHT80): 1 5500MHz ~ 5700MHz: 802.11a, 802.11n (HT20), 802.11ac (VHT20): 11 802.11n (HT40), 802.11ac (VHT40): 5 802.11ac (VHT80): 2 5745MHz ~ 5825MHz: 802.11a, 802.11n (HT20), 802.11ac (VHT20): 5 802.11n (HT40), 802.11ac (VHT40): 2 802.11ac (VHT80): 1
Output Power	5180MHz ~ 5240MHz: 22.439mW 5260MHz ~ 5320MHz: 20.749mW 5500MHz ~ 5700MHz: 19.679mW 5745MHz ~ 5825MHz: 20.941mW
Antenna Type	Dipole antenna with 2.43dBi gain
Antenna Connector	RP-SMA Male Straight Connector
Accessory Device	NA
Data Cable Supplied	NA

Note:

1. The EUT provides 1 completed transmitter and 1 receiver.

Modulation Mode	TX Function
802.11a	1TX
802.11n (HT20)	1TX
802.11n (HT40)	1TX
802.11ac (VHT80)	1TX

* The modulation and bandwidth are similar for 802.11n mode for HT20 / HT40 and 802.11ac mode for VHT20 / VHT40, therefore investigated worst case to representative mode in test report. (Final test mode refer section 3.2.1)

3.2 Description of Test Modes

For 5180 ~ 5240MHz

4 channels are provided for 802.11a, 802.11n (HT20), 802.11ac (VHT20):

Channel	Frequency	Channel	Frequency
36	5180 MHz	44	5220 MHz
40	5200 MHz	48	5240 MHz

2 channels are provided for 802.11n (HT40), 802.11ac (VHT40):

Channel	Frequency	Channel	Frequency
38	5190 MHz	46	5230 MHz

1 channel is provided for 802.11ac (VHT80):

Channel	Frequency
42	5210MHz

For 5260 ~ 5320MHz

4 channels are provided for 802.11a, 802.11n (HT20), 802.11ac (VHT20):

Channel	Frequency	Channel	Frequency
52	5260 MHz	60	5300 MHz
56	5280 MHz	64	5320 MHz

2 channels are provided for 802.11n (HT40), 802.11ac (VHT40):

Channel	Frequency	Channel	Frequency
54	5270 MHz	62	5310 MHz

1 channel is provided for 802.11ac (VHT80):

Channel	Frequency
58	5290MHz

For 5500 ~ 5700MHz

11 channels are provided for 802.11a, 802.11n (HT20), 802.11ac (VHT20):

Channel	Frequency	Channel	Frequency
100	5500 MHz	124	5620 MHz
104	5520 MHz	128	5640 MHz
108	5540 MHz	132	5660 MHz
112	5560 MHz	136	5680 MHz
116	5580 MHz	140	5700 MHz
120	5600 MHz		

5 channels are provided for 802.11n (HT40), 802.11ac (VHT40):

Channel	Frequency	Channel	Frequency
102	5510 MHz	126	5630 MHz
110	5550 MHz	134	5670 MHz
118	5590 MHz		

2 channels are provided for 802.11ac (VHT80):

Channel	Frequency	Channel	Frequency
106	5530MHz	122	5610 MHz

For 5745 ~ 5825MHz:

5 channels are provided for 802.11a, 802.11n (HT20), 802.11ac (VHT20):

Channel	Frequency	Channel	Frequency
149	5745MHz	161	5805MHz
153	5765MHz	165	5825MHz
157	5785MHz		

2 channels are provided for 802.11n (HT40), 802.11ac (VHT40):

Channel	Frequency	Channel	Frequency
151	5755MHz	159	5795MHz

1 channel is provided for 802.11ac (VHT80):

Channel	Frequency
155	5775MHz

3.2.1 Test Mode Applicability and Tested Channel Detail

EUT CONFIGURE MODE	APPLICABLE TO				DESCRIPTION
	RE≥1G	RE<1G	PLC	APCM	
-	√	√	√	√	-

Where **RE≥1G**: Radiated Emission above 1GHz & Bandedge Measurement
RE<1G: Radiated Emission below 1GHz
PLC: Power Line Conducted Emission
APCM: Antenna Port Conducted Measurement

Note: The EUT had been pre-tested on the positioned of each 3 axis. The worst case was found when positioned on **X-plane**.

Radiated Emission Test (Above 1GHz):

- Pre-Scan has been conducted to determine the worst-case mode from all possible combinations between available modulations, data rates and antenna ports (if EUT with antenna diversity architecture).
- Following channel(s) was (were) selected for the final test as listed below.

EUT CONFIGURE MODE	MODE	FREQ. BAND (MHz)	AVAILABLE CHANNEL	TESTED CHANNEL	MODULATION TECHNOLOGY	MODULATION TYPE	DATA RATE (Mbps)
-	802.11a	5180-5240	36 to 48	36, 40, 48	OFDM	BPSK	6.0
-	802.11n (HT20)		36 to 48	36, 40, 48	OFDM	BPSK	6.5
-	802.11n (HT40)		38 to 46	38, 46	OFDM	BPSK	13.5
-	802.11ac (VHT80)		42	42	OFDM	BPSK	29.3
-	802.11a	5260-5320	52 to 64	52, 60, 64	OFDM	BPSK	6.0
-	802.11n (HT20)		52 to 64	52, 60, 64	OFDM	BPSK	6.5
-	802.11n (HT40)		54 to 62	54, 62	OFDM	BPSK	13.5
-	802.11ac (VHT80)		58	58	OFDM	BPSK	29.3
-	802.11a	5500-5700	100 to 140	100, 116, 140	OFDM	BPSK	6.0
-	802.11n (HT20)		100 to 140	100, 116, 140	OFDM	BPSK	6.5
-	802.11n (HT40)		102 to 134	102, 110, 134	OFDM	BPSK	13.5
-	802.11ac (VHT80)		106	106	OFDM	BPSK	29.3
-	802.11a	5745-5825	149 to 165	149, 157, 165	OFDM	BPSK	6.0
-	802.11n (HT20)		149 to 165	149, 157, 165	OFDM	BPSK	6.5
-	802.11n (HT40)		151 to 159	151, 159	OFDM	BPSK	13.5
-	802.11ac (VHT80)		155	155	OFDM	BPSK	29.3

Radiated Emission Test (Below 1GHz):

- Pre-Scan has been conducted to determine the worst-case mode from all possible combinations between available modulations, data rates and antenna ports (if EUT with antenna diversity architecture).
- Following channel(s) was (were) selected for the final test as listed below.

EUT CONFIGURE MODE	MODE	FREQ. BAND (MHz)	AVAILABLE CHANNEL	TESTED CHANNEL	MODULATION TECHNOLOGY	MODULATION TYPE	DATA RATE (Mbps)
-	802.11a	5180-5240	36 to 48	36	OFDM	BPSK	6.0
-	802.11a	5260-5320	52 to 64		OFDM	BPSK	6.0
-	802.11a	5500-5700	100 to 140		OFDM	BPSK	6.0
-	802.11a	5745-5825	149 to 165		OFDM	BPSK	6.0

Power Line Conducted Emission Test:

- Pre-Scan has been conducted to determine the worst-case mode from all possible combinations between available modulations, data rates and antenna ports (if EUT with antenna diversity architecture).
- Following channel(s) was (were) selected for the final test as listed below.

EUT CONFIGURE MODE	MODE	FREQ. BAND (MHz)	AVAILABLE CHANNEL	TESTED CHANNEL	MODULATION TECHNOLOGY	MODULATION TYPE	DATA RATE (Mbps)
-	802.11a	5180-5240	36 to 48	36	OFDM	BPSK	6.0
-	802.11a	5260-5320	52 to 64		OFDM	BPSK	6.0
-	802.11a	5500-5700	100 to 140		OFDM	BPSK	6.0
-	802.11a	5745-5825	149 to 165		OFDM	BPSK	6.0

Antenna Port Conducted Measurement:

- This item includes all test value of each mode, but only includes spectrum plot of worst value of each mode.
- Pre-Scan has been conducted to determine the worst-case mode from all possible combinations between available modulations, data rates and antenna ports (if EUT with antenna diversity architecture).
- Following channel(s) was (were) selected for the final test as listed below.

EUT CONFIGURE MODE	MODE	FREQ. BAND (MHz)	AVAILABLE CHANNEL	TESTED CHANNEL	MODULATION TECHNOLOGY	MODULATION TYPE	DATA RATE (Mbps)
-	802.11a	5180-5240	36 to 48	36, 40, 48	OFDM	BPSK	6.0
-	802.11n (HT20)		36 to 48	36, 40, 48	OFDM	BPSK	6.5
-	802.11n (HT40)		38 to 46	38, 46	OFDM	BPSK	13.5
-	802.11ac (VHT80)		42	42	OFDM	BPSK	29.3
-	802.11a	5260-5320	52 to 64	52, 60, 64	OFDM	BPSK	6.0
-	802.11n (HT20)		52 to 64	52, 60, 64	OFDM	BPSK	6.5
-	802.11n (HT40)		54 to 62	54, 62	OFDM	BPSK	13.5
-	802.11ac (VHT80)		58	58	OFDM	BPSK	29.3
-	802.11a	5500-5700	100 to 140	100, 116, 140	OFDM	BPSK	6.0
-	802.11n (HT20)		100 to 140	100, 116, 140	OFDM	BPSK	6.5
-	802.11n (HT40)		102 to 134	102, 110, 134	OFDM	BPSK	13.5
-	802.11ac (VHT80)		106	106	OFDM	BPSK	29.3
-	802.11a	5745-5825	149 to 165	149, 157, 165	OFDM	BPSK	6.0
-	802.11n (HT20)		149 to 165	149, 157, 165	OFDM	BPSK	6.5
-	802.11n (HT40)		151 to 159	151, 159	OFDM	BPSK	13.5
-	802.11ac (VHT80)		155	155	OFDM	BPSK	29.3

Test Condition:

APPLICABLE TO	ENVIRONMENTAL CONDITIONS	INPUT POWER (SYSTEM)	TESTED BY
RE _≥ 1G	25deg. C, 65%RH	120Vac, 60Hz	Chris Lin
RE _{<} 1G	25deg. C, 65%RH	120Vac, 60Hz	Chris Lin
PLC	25deg. C, 65%RH	120Vac, 60Hz	Chris Lin
APCM	25deg. C, 60%RH	120Vac, 60Hz	Leo Tsai

3.3 Duty Cycle of Test Signal

Duty cycle of test signal is < 98 %, duty factor shall be considered.

802.11a: Duty cycle = 1.432/1.507= 0.95, Duty factor = 10 * log(1/0.95) = 0.22

802.11n (HT20): Duty cycle = 1.329/1.397 = 0.951, Duty factor = 10 * log(1/0.951) = 0.22

802.11n (HT40): Duty cycle = 0.657/0.73 = 0.90, Duty factor = 10 * log(1/0.90) = 0.46

802.11ac (VHT80): Duty cycle = 0.33/0.39 = 0.846, Duty factor = 10 * log(1/0.846) = 0.73

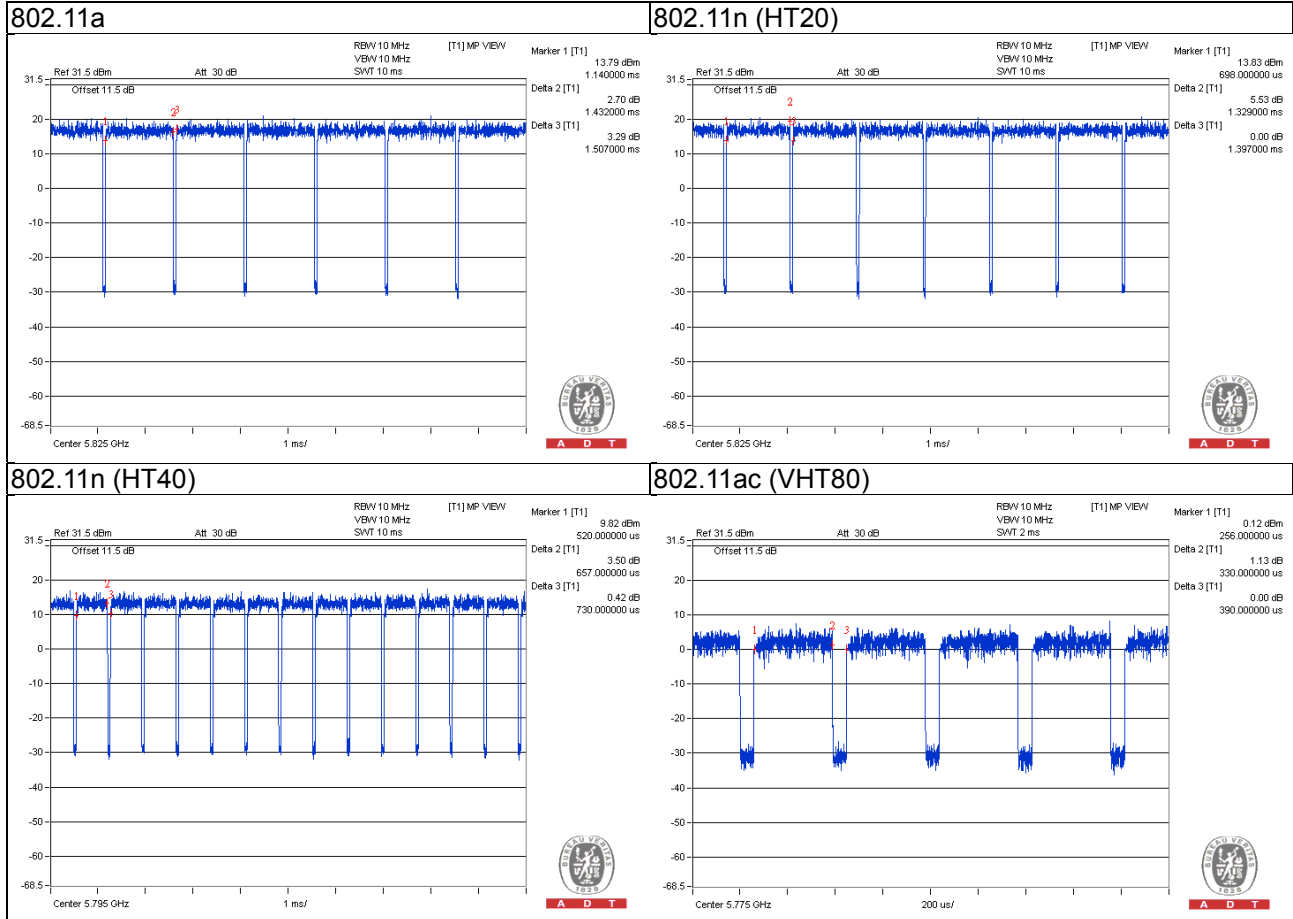

3.4 Description of Support Units

The EUT has been tested as an independent unit together with other necessary accessories or support units. The following support units or accessories were used to form a representative test configuration during the tests.

ID	Product	Brand	Model No.	Serial No.	FCC ID	Remarks
A.	Power Supply	Topward	6603D	700637	NA	-
B.	Convertible board	NA	NA	NA	NA	-

Note:

1. All power cords of the above support units are non-shielded (1.8m).

ID	Descriptions	Qty.	Length (m)	Shielding (Yes/No)	Cores (Qty.)	Remarks
1.	DC	1	1.8	-	0	-

3.4.1 Configuration of System under Test

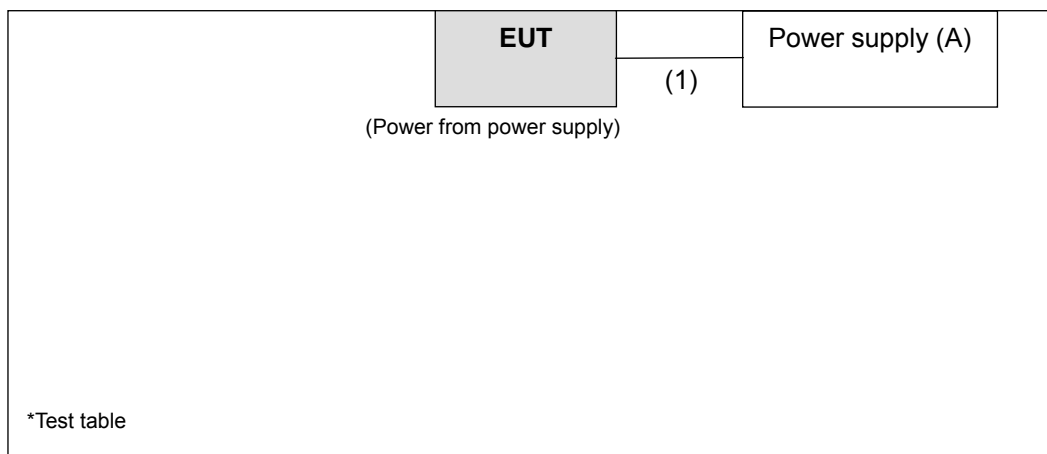

3.5 General Description of Applied Standards

The EUT is a RF Product. According to the specifications of the manufacturer, it must comply with the requirements of the following standards:

FCC Part 15, Subpart E (15.407)

789033 D02 General UNII Test Procedure New Rules v01

ANSI C63.10-2013

All test items have been performed and recorded as per the above standards.

Note: The EUT has been verified to comply with the requirements of FCC Part 15, Subpart B, Class B (DoC). The test report has been issued separately.

4 Test Types and Results

4.1 Radiated Emission and Bandedge Measurement

4.1.1 Limits of Radiated Emission and Bandedge Measurement

Radiated emissions which fall in the restricted bands must comply with the radiated emission limits specified as below table.

Frequencies (MHz)	Field Strength (microvolts/meter)	Measurement Distance (meters)
0.009 ~ 0.490	2400/F(kHz)	300
0.490 ~ 1.705	24000/F(kHz)	30
1.705 ~ 30.0	30	30
30 ~ 88	100	3
88 ~ 216	150	3
216 ~ 960	200	3
Above 960	500	3

Note:

1. The lower limit shall apply at the transition frequencies.
2. Emission level (dBuV/m) = 20 log Emission level (uV/m).
3. For frequencies above 1000MHz, the field strength limits are based on average detector, however, the peak field strength of any emission shall not exceed the maximum permitted average limits, specified above by more than 20dB under any condition of modulation.

LIMITS OF UNWANTED EMISSION OUT OF THE RESTRICTED BANDS

APPLICABLE TO	LIMIT	
789033 D02 General UNII Test Procedures New Rules v01	FIELD STRENGTH AT 3m	
	PK:74 (dBµV/m)	AV:54 (dBµV/m)
APPLICABLE TO	EIRP LIMIT	EQUIVALENT FIELD STRENGTH AT 3m
15.407(b)(1)	PK:-27 (dBm/MHz)	PK:68.2(dBµV/m)
15.407(b)(2)		
15.407(b)(3)		
15.407(b)(4)	PK:-27 (dBm/MHz) ^{*1} PK:-17 (dBm/MHz) ^{*2}	PK: 68.2(dBµV/m) ^{*1} PK:78.2 (dBµV/m) ^{*2}

Note: ^{*1} beyond 10MHz of the band edge ^{*2} within 10 MHz of band edge

The following formula is used to convert the equipment isotropic radiated power (eirp) to field strength:

$$E = \frac{1000000\sqrt{30P}}{3} \mu\text{V/m, where P is the eirp (Watts).}$$

4.1.2 Test Instruments

Description & Manufacturer	Model No.	Serial No.	Date Of Calibration	Due Date Of Calibration
Test Receiver ROHDE & SCHWARZ	ESCI	100424	Oct. 06, 2014	Oct. 05, 2015
Spectrum Analyzer ROHDE & SCHWARZ	FSP40	100040	Jul. 08, 2015	Jul. 07, 2016
BILOG Antenna SCHWARZBECK	VULB9168	9168-155	Feb. 06, 2015	Feb. 05, 2016
HORN Antenna SCHWARZBECK	BBHA 9120D	9120D-1170	Feb. 05, 2015	Feb. 04, 2016
HORN Antenna SCHWARZBECK	BBHA 9170	BBHA9170241	Feb. 09, 2015	Feb. 08, 2016
Preamplifier Agilent	8449B	3008A01960	Aug. 09, 2014	Aug. 08, 2015
			Aug. 09, 2015	Aug. 08, 2016
Preamplifier Agilent	8447D	2944A10631	Aug. 09, 2014	Aug. 08, 2015
			Aug. 09, 2015	Aug. 08, 2016
RF signal cable HUBER+SUHNNER	SUCOFLEX 104	309220/4	Aug. 09, 2014	Aug. 08, 2015
			Aug. 09, 2015	Aug. 08, 2016
RF signal cable HUBER+SUHNNER	SUCOFLEX 104	250724/4	Aug. 09, 2014	Aug. 08, 2015
			Aug. 09, 2015	Aug. 08, 2016
RF signal cable HUBER+SUHNNER	SUCOFLEX 104	295012/4	Aug. 09, 2014	Aug. 08, 2015
			Aug. 09, 2015	Aug. 08, 2016
Software BV ADT	ADT_Radiated_ V7.6.15.9.4	NA	NA	NA
Antenna Tower inn-co GmbH	MA 4000	010303	NA	NA
Antenna Tower Controller BV ADT	AT100	AT93021703	NA	NA
Turn Table BV ADT	TT100	TT93021703	NA	NA
Turn Table Controller BV ADT	SC100.	SC93021703	NA	NA
High Speed Peak Power Meter	ML2495A	0824011	Jul. 09, 2015	Jul. 08, 2016
Power Sensor	MA2411B	0738171	Jul. 09, 2015	Jul. 08, 2016

- Note:**
1. The calibration interval of the above test instruments is 12 months and the calibrations are traceable to NML/ROC and NIST/USA.
 2. The test was performed in HwaYa Chamber 4.
 3. The horn antenna and HP preamplifier (model: 8449B) are used only for the measurement of emission frequency above 1GHz if tested.
 4. The FCC Site Registration No. is 460141.
 5. The IC Site Registration No. is IC7450F-4.

4.1.3 Test Procedures

- a. The EUT was placed on the top of a rotating table 0.8 meters (for below 1GHz) / 1.5 meters (for above 1GHz) above the ground at 3 meter chamber room for test. The table was rotated 360 degrees to determine the position of the highest radiation.
- b. The EUT was set 3 meters away from the interference-receiving antenna, which was mounted on the top of a variable-height antenna tower.
- c. The height of antenna is varied from one meter to four meters above the ground to determine the maximum value of the field strength. Both horizontal and vertical polarizations of the antenna are set to make the measurement.
- d. For each suspected emission, the EUT was arranged to its worst case and then the antenna was tuned to heights from 1 meter to 4 meters and the rotatable table was turned from 0 degrees to 360 degrees to find the maximum reading.
- e. The test-receiver system was set to quasi-peak detect function and specified bandwidth with maximum hold mode when the test frequency is below 1 GHz.
- f. The test-receiver system was set to peak and average detect function and specified bandwidth with maximum hold mode when the test frequency is above 1 GHz. If the peak reading value also meets average limit, measurement with the average detector is unnecessary.

Note:

1. The resolution bandwidth and video bandwidth of test receiver/spectrum analyzer is 120kHz for Quasi-peak detection (QP) at frequency below 1GHz.
2. The resolution bandwidth of test receiver/spectrum analyzer is 1 MHz and the video bandwidth is 3 MHz for Peak detection (PK) at frequency above 1GHz.
3. The resolution bandwidth of test receiver/spectrum analyzer is 1MHz and the video bandwidth is 3MHz for RMS Average (Duty cycle < 98%) for Average detection (AV) at frequency above 1GHz, then the measurement results was added to a correction factor ($10 \log(1/\text{duty cycle})$).
4. The resolution bandwidth of test receiver/spectrum analyzer is 1MHz and the video bandwidth is 10Hz (Duty cycle $\geq 98\%$) for Average detection (AV) at frequency above 1GHz.
5. All modes of operation were investigated and the worst-case emissions are reported.

4.1.4 Deviation from Test Standard

No deviation.

4.1.5 Test Set Up

<Frequency Range below 1GHz>

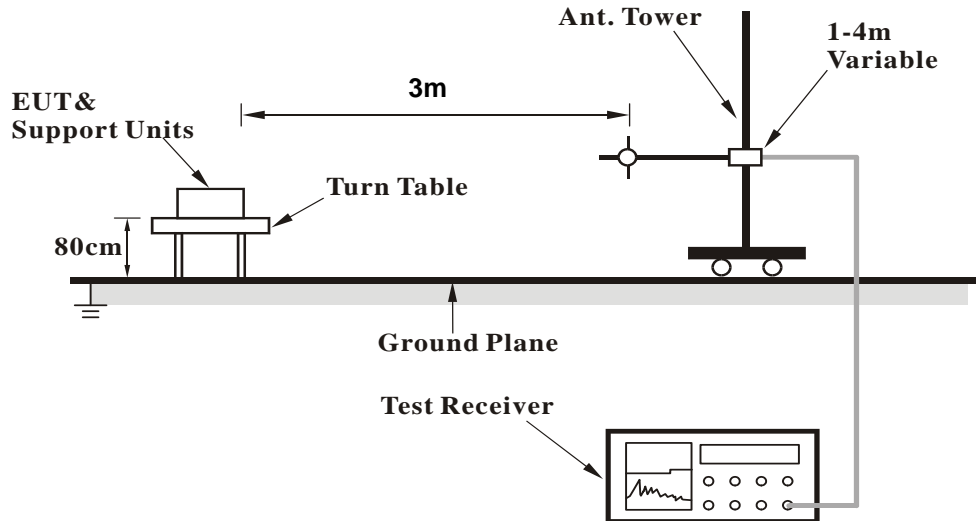

<Frequency Range above 1GHz>

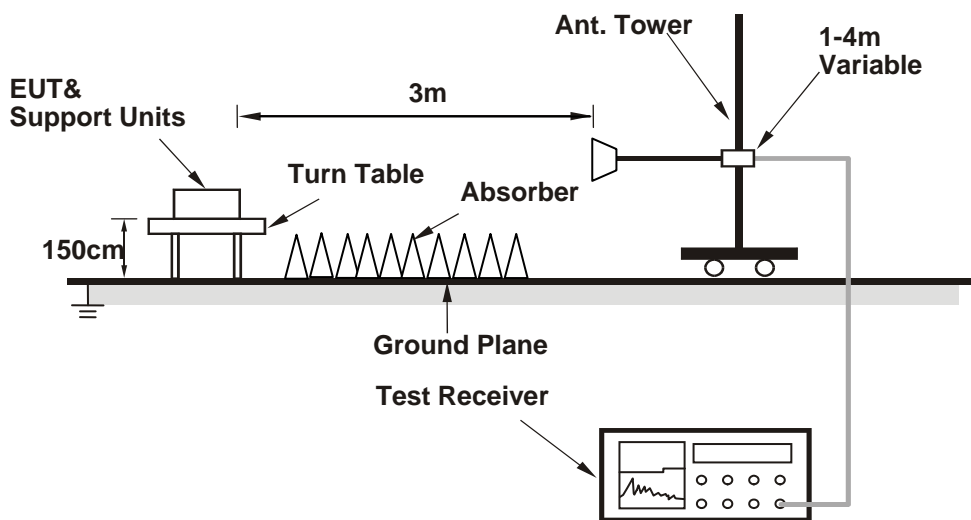

For the actual test configuration, please refer to the attached file (Test Setup Photo)

4.1.6 EUT Operating Conditions

Set the EUT under transmission condition continuously at specific channel frequency.

4.1.7 Test Results

Above 1GHz Data

802.11a

CHANNEL	TX Channel 36	DETECTOR FUNCTION	Peak (PK)
FREQUENCY RANGE	1GHz ~ 40GHz		Average (AV)

ANTENNA POLARITY & TEST DISTANCE: HORIZONTAL AT 3 M

NO.	FREQ. (MHz)	EMISSION LEVEL (dBuV/m)	LIMIT (dBuV/m)	MARGIN (dB)	ANTENNA HEIGHT (m)	TABLE ANGLE (Degree)	RAW VALUE (dBuV)	CORRECTION FACTOR (dB/m)
1	5150.00	64.2 PK	74.0	-9.8	1.25 H	201	58.90	5.30
2	5150.00	47.8 AV	54.0	-6.2	1.25 H	201	42.50	5.30
3	*5180.00	101.5 PK			1.20 H	199	62.30	39.20
4	*5180.00	92.0 AV			1.20 H	199	52.80	39.20
5	#10360.00	59.2 PK	74.0	-14.8	1.15 H	41	40.80	18.40
6	#10360.00	48.1 AV	54.0	-5.9	1.15 H	41	29.70	18.40

ANTENNA POLARITY & TEST DISTANCE: VERTICAL AT 3 M

NO.	FREQ. (MHz)	EMISSION LEVEL (dBuV/m)	LIMIT (dBuV/m)	MARGIN (dB)	ANTENNA HEIGHT (m)	TABLE ANGLE (Degree)	RAW VALUE (dBuV)	CORRECTION FACTOR (dB/m)
1	5150.00	68.5 PK	74.0	-5.5	1.80 V	180	63.20	5.30
2	5150.00	52.6 AV	54.0	-1.4	1.80 V	180	47.30	5.30
3	*5180.00	104.3 PK			1.84 V	189	65.10	39.20
4	*5180.00	93.5 AV			1.84 V	189	54.30	39.20
5	#10360.00	61.1 PK	74.0	-12.9	1.47 V	267	42.70	18.40
6	#10360.00	49.0 AV	54.0	-5.0	1.47 V	267	30.60	18.40

Remarks:

1. Emission Level(dBuV/m) = Raw Value(dBuV) + Correction Factor(dB/m)
2. Correction Factor(dB/m) = Antenna Factor(dB/m) + Cable Factor(dB)
3. The other emission levels were very low against the limit.
4. Margin value = Emission Level – Limit value
5. " * ": Fundamental frequency.
6. " # ": The radiated frequency is out of the restricted band.

CHANNEL	TX Channel 40	DETECTOR	Peak (PK)
FREQUENCY RANGE	1GHz ~ 40GHz	FUNCTION	Average (AV)

ANTENNA POLARITY & TEST DISTANCE: HORIZONTAL AT 3 M

NO.	FREQ. (MHz)	EMISSION LEVEL (dBuV/m)	LIMIT (dBuV/m)	MARGIN (dB)	ANTENNA HEIGHT (m)	TABLE ANGLE (Degree)	RAW VALUE (dBuV)	CORRECTION FACTOR (dB/m)
1	*5200.00	103.3 PK			1.43 H	192	64.00	39.30
2	*5200.00	93.5 AV			1.43 H	192	54.20	39.30
3	#10400.00	58.2 PK	74.0	-15.8	1.55 H	230	40.00	18.20
4	#10400.00	47.2 AV	54.0	-6.8	1.55 H	230	29.00	18.20

ANTENNA POLARITY & TEST DISTANCE: VERTICAL AT 3 M

NO.	FREQ. (MHz)	EMISSION LEVEL (dBuV/m)	LIMIT (dBuV/m)	MARGIN (dB)	ANTENNA HEIGHT (m)	TABLE ANGLE (Degree)	RAW VALUE (dBuV)	CORRECTION FACTOR (dB/m)
1	*5200.00	104.0 PK			1.22 V	173	64.70	39.30
2	*5200.00	93.7 AV			1.22 V	173	54.40	39.30
3	#10400.00	60.5 PK	74.0	-13.5	1.26 V	305	42.30	18.20
4	#10400.00	48.6 AV	54.0	-5.4	1.26 V	305	30.40	18.20

Remarks:

1. Emission Level(dBuV/m) = Raw Value(dBuV) + Correction Factor(dB/m)
2. Correction Factor(dB/m) = Antenna Factor(dB/m) + Cable Factor(dB)
3. The other emission levels were very low against the limit.
4. Margin value = Emission Level – Limit value
5. " * ": Fundamental frequency.
6. " # ": The radiated frequency is out of the restricted band.

CHANNEL	TX Channel 48	DETECTOR FUNCTION	Peak (PK)
FREQUENCY RANGE	1GHz ~ 40GHz		Average (AV)

ANTENNA POLARITY & TEST DISTANCE: HORIZONTAL AT 3 M								
NO.	FREQ. (MHz)	EMISSION LEVEL (dBuV/m)	LIMIT (dBuV/m)	MARGIN (dB)	ANTENNA HEIGHT (m)	TABLE ANGLE (Degree)	RAW VALUE (dBuV)	CORRECTION FACTOR (dB/m)
1	*5240.00	103.2 PK			1.50 H	193	63.90	39.30
2	*5240.00	92.7 AV			1.50 H	193	53.40	39.30
3	5350.00	55.6 PK	74.0	-18.4	1.60 H	200	50.00	5.60
4	5350.00	44.3 AV	54.0	-9.7	1.60 H	200	38.70	5.60
5	#10480.00	58.1 PK	74.0	-15.9	1.13 H	205	40.50	17.60
6	#10480.00	46.6 AV	54.0	-7.4	1.13 H	205	29.00	17.60
ANTENNA POLARITY & TEST DISTANCE: VERTICAL AT 3 M								
NO.	FREQ. (MHz)	EMISSION LEVEL (dBuV/m)	LIMIT (dBuV/m)	MARGIN (dB)	ANTENNA HEIGHT (m)	TABLE ANGLE (Degree)	RAW VALUE (dBuV)	CORRECTION FACTOR (dB/m)
1	*5240.00	107.2 PK			1.00 V	263	67.90	39.30
2	*5240.00	97.8 AV			1.00 V	263	58.50	39.30
3	5350.00	56.6 PK	74.0	-17.4	1.05 V	270	51.00	5.60
4	5350.00	44.6 AV	54.0	-9.4	1.05 V	270	39.00	5.60
5	#10480.00	59.1 PK	74.0	-14.9	1.06 V	332	41.50	17.60
6	#10480.00	47.6 AV	54.0	-6.4	1.06 V	332	30.00	17.60

Remarks:

1. Emission Level(dBuV/m) = Raw Value(dBuV) + Correction Factor(dB/m)
2. Correction Factor(dB/m) = Antenna Factor(dB/m) + Cable Factor(dB)
3. The other emission levels were very low against the limit.
4. Margin value = Emission Level – Limit value
5. " * ": Fundamental frequency.
6. " # ": The radiated frequency is out of the restricted band.

CHANNEL	TX Channel 52	DETECTOR FUNCTION	Peak (PK)
FREQUENCY RANGE	1GHz ~ 40GHz		Average (AV)

ANTENNA POLARITY & TEST DISTANCE: HORIZONTAL AT 3 M								
NO.	FREQ. (MHz)	EMISSION LEVEL (dBuV/m)	LIMIT (dBuV/m)	MARGIN (dB)	ANTENNA HEIGHT (m)	TABLE ANGLE (Degree)	RAW VALUE (dBuV)	CORRECTION FACTOR (dB/m)
1	5150.00	55.3 PK	74.0	-18.7	1.55 H	203	50.00	5.30
2	5150.00	45.0 AV	54.0	-9.0	1.55 H	203	39.70	5.30
3	*5260.00	103.0 PK			1.49 H	193	63.70	39.30
4	*5260.00	92.8 AV			1.49 H	193	53.50	39.30
5	#10520.00	58.0 PK	74.0	-16.0	1.47 H	54	40.60	17.40
6	#10520.00	47.1 AV	54.0	-6.9	1.47 H	54	29.70	17.40
ANTENNA POLARITY & TEST DISTANCE: VERTICAL AT 3 M								
NO.	FREQ. (MHz)	EMISSION LEVEL (dBuV/m)	LIMIT (dBuV/m)	MARGIN (dB)	ANTENNA HEIGHT (m)	TABLE ANGLE (Degree)	RAW VALUE (dBuV)	CORRECTION FACTOR (dB/m)
1	5150.00	57.3 PK	74.0	-16.7	1.60 V	340	52.00	5.30
2	5150.00	45.8 AV	54.0	-8.2	1.60 V	340	40.50	5.30
3	*5260.00	107.0 PK			1.52 V	337	67.70	39.30
4	*5260.00	97.7 AV			1.52 V	337	58.40	39.30
5	#10520.00	59.2 PK	74.0	-14.8	1.23 V	95	41.80	17.40
6	#10520.00	47.4 AV	54.0	-6.6	1.23 V	95	30.00	17.40

Remarks:

1. Emission Level(dBuV/m) = Raw Value(dBuV) + Correction Factor(dB/m)
2. Correction Factor(dB/m) = Antenna Factor(dB/m) + Cable Factor(dB)
3. The other emission levels were very low against the limit.
4. Margin value = Emission Level – Limit value
5. " * ": Fundamental frequency.
6. " # ": The radiated frequency is out of the restricted band.

CHANNEL	TX Channel 60	DETECTOR FUNCTION	Peak (PK)
FREQUENCY RANGE	1GHz ~ 40GHz		Average (AV)

ANTENNA POLARITY & TEST DISTANCE: HORIZONTAL AT 3 M								
NO.	FREQ. (MHz)	EMISSION LEVEL (dBuV/m)	LIMIT (dBuV/m)	MARGIN (dB)	ANTENNA HEIGHT (m)	TABLE ANGLE (Degree)	RAW VALUE (dBuV)	CORRECTION FACTOR (dB/m)
1	*5300.00	99.5 PK			1.46 H	251	60.10	39.40
2	*5300.00	90.2 AV			1.46 H	251	50.80	39.40
3	10600.00	57.7 PK	74.0	-16.3	1.47 H	85	40.30	17.40
4	10600.00	46.1 AV	54.0	-7.9	1.47 H	85	28.70	17.40
ANTENNA POLARITY & TEST DISTANCE: VERTICAL AT 3 M								
NO.	FREQ. (MHz)	EMISSION LEVEL (dBuV/m)	LIMIT (dBuV/m)	MARGIN (dB)	ANTENNA HEIGHT (m)	TABLE ANGLE (Degree)	RAW VALUE (dBuV)	CORRECTION FACTOR (dB/m)
1	*5300.00	106.2 PK			1.43 V	334	66.80	39.40
2	*5300.00	96.8 AV			1.43 V	334	57.40	39.40
3	10600.00	58.9 PK	74.0	-15.1	1.05 V	23	41.50	17.40
4	10600.00	47.3 AV	54.0	-6.7	1.05 V	23	29.90	17.40

Remarks:

1. Emission Level(dBuV/m) = Raw Value(dBuV) + Correction Factor(dB/m)
2. Correction Factor(dB/m) = Antenna Factor(dB/m) + Cable Factor(dB)
3. The other emission levels were very low against the limit.
4. Margin value = Emission Level – Limit value
5. " * ": Fundamental frequency.

CHANNEL	TX Channel 64	DETECTOR FUNCTION	Peak (PK)
FREQUENCY RANGE	1GHz ~ 40GHz		Average (AV)

ANTENNA POLARITY & TEST DISTANCE: HORIZONTAL AT 3 M

NO.	FREQ. (MHz)	EMISSION LEVEL (dBuV/m)	LIMIT (dBuV/m)	MARGIN (dB)	ANTENNA HEIGHT (m)	TABLE ANGLE (Degree)	RAW VALUE (dBuV)	CORRECTION FACTOR (dB/m)
1	*5320.00	100.4 PK			1.46 H	195	61.00	39.40
2	*5320.00	90.2 AV			1.46 H	195	50.80	39.40
3	5350.00	64.5 PK	74.0	-9.5	1.50 H	185	58.90	5.60
4	5350.00	47.5 AV	54.0	-6.5	1.50 H	185	41.90	5.60
5	10640.00	57.2 PK	74.0	-16.8	1.15 H	217	40.00	17.20
6	10640.00	45.9 AV	54.0	-8.1	1.15 H	217	28.70	17.20

ANTENNA POLARITY & TEST DISTANCE: VERTICAL AT 3 M

NO.	FREQ. (MHz)	EMISSION LEVEL (dBuV/m)	LIMIT (dBuV/m)	MARGIN (dB)	ANTENNA HEIGHT (m)	TABLE ANGLE (Degree)	RAW VALUE (dBuV)	CORRECTION FACTOR (dB/m)
1	*5320.00	107.4 PK			2.10 V	284	68.00	39.40
2	*5320.00	97.0 AV			2.10 V	284	57.60	39.40
3	5350.00	70.8 PK	74.0	-3.2	2.23 V	291	65.20	5.60
4	5350.00	52.9 AV	54.0	-1.1	2.23 V	291	47.30	5.60
5	10640.00	58.7 PK	74.0	-15.3	1.15 V	74	41.50	17.20
6	10640.00	46.9 AV	54.0	-7.1	1.15 V	74	29.70	17.20

Remarks:

1. Emission Level(dBuV/m) = Raw Value(dBuV) + Correction Factor(dB/m)
2. Correction Factor(dB/m) = Antenna Factor(dB/m) + Cable Factor(dB)
3. The other emission levels were very low against the limit.
4. Margin value = Emission Level – Limit value
5. " * ": Fundamental frequency.

CHANNEL	TX Channel 100	DETECTOR FUNCTION	Peak (PK)
FREQUENCY RANGE	1GHz ~ 40GHz		Average (AV)

ANTENNA POLARITY & TEST DISTANCE: HORIZONTAL AT 3 M

NO.	FREQ. (MHz)	EMISSION LEVEL (dBuV/m)	LIMIT (dBuV/m)	MARGIN (dB)	ANTENNA HEIGHT (m)	TABLE ANGLE (Degree)	RAW VALUE (dBuV)	CORRECTION FACTOR (dB/m)
1	5460.00	60.7 PK	74.0	-13.3	1.60 H	210	54.00	6.70
2	5460.00	46.6 AV	54.0	-7.4	1.60 H	210	39.90	6.70
3	#5470.00	64.4 PK	74.0	-9.6	1.60 H	210	57.70	6.70
4	#5470.00	49.6 AV	54.0	-4.4	1.60 H	210	42.90	6.70
5	*5500.00	102.4 PK			1.54 H	199	61.90	40.50
6	*5500.00	92.2 AV			1.54 H	199	51.70	40.50
7	11000.00	59.1 PK	74.0	-14.9	1.06 H	87	41.00	18.10
8	11000.00	47.1 AV	54.0	-6.9	1.06 H	87	29.00	18.10

ANTENNA POLARITY & TEST DISTANCE: VERTICAL AT 3 M

NO.	FREQ. (MHz)	EMISSION LEVEL (dBuV/m)	LIMIT (dBuV/m)	MARGIN (dB)	ANTENNA HEIGHT (m)	TABLE ANGLE (Degree)	RAW VALUE (dBuV)	CORRECTION FACTOR (dB/m)
1	5460.00	65.2 PK	74.0	-8.8	1.82 V	167	58.50	6.70
2	5460.00	48.3 AV	54.0	-5.7	1.82 V	167	41.60	6.70
3	#5470.00	70.5 PK	74.0	-3.5	1.82 V	167	63.80	6.70
4	#5470.00	53.0 AV	54.0	-1.0	1.82 V	167	46.30	6.70
5	*5500.00	105.6 PK			1.01 V	42	65.10	40.50
6	*5500.00	95.5 AV			1.01 V	42	55.00	40.50
7	11000.00	61.1 PK	74.0	-12.9	1.29 V	87	43.00	18.10
8	11000.00	48.5 AV	54.0	-5.5	1.29 V	87	30.40	18.10

Remarks:

1. Emission Level(dBuV/m) = Raw Value(dBuV) + Correction Factor(dB/m)
2. Correction Factor(dB/m) = Antenna Factor(dB/m) + Cable Factor(dB)
3. The other emission levels were very low against the limit.
4. Margin value = Emission Level – Limit value
5. " * ": Fundamental frequency.
6. " # ": The radiated frequency is out of the restricted band.

CHANNEL	TX Channel 116	DETECTOR FUNCTION	Peak (PK)
FREQUENCY RANGE	1GHz ~ 40GHz		Average (AV)

ANTENNA POLARITY & TEST DISTANCE: HORIZONTAL AT 3 M

NO.	FREQ. (MHz)	EMISSION LEVEL (dBuV/m)	LIMIT (dBuV/m)	MARGIN (dB)	ANTENNA HEIGHT (m)	TABLE ANGLE (Degree)	RAW VALUE (dBuV)	CORRECTION FACTOR (dB/m)
1	*5580.00	69.2 PK			1.79 H	202	62.60	6.60
2	*5580.00	58.8 AV			1.79 H	202	52.20	6.60
3	11160.00	60.1 PK	74.0	-13.9	1.47 H	87	41.00	19.10
4	11160.00	47.8 AV	54.0	-6.2	1.47 H	87	28.70	19.10

ANTENNA POLARITY & TEST DISTANCE: VERTICAL AT 3 M

NO.	FREQ. (MHz)	EMISSION LEVEL (dBuV/m)	LIMIT (dBuV/m)	MARGIN (dB)	ANTENNA HEIGHT (m)	TABLE ANGLE (Degree)	RAW VALUE (dBuV)	CORRECTION FACTOR (dB/m)
1	*5580.00	106.1 PK			1.00 V	338	65.60	40.50
2	*5580.00	96.1 AV			1.00 V	338	55.60	40.50
3	11160.00	62.0 PK	74.0	-12.0	1.32 V	98	42.90	19.10
4	11160.00	49.5 AV	54.0	-4.5	1.32 V	98	30.40	19.10

Remarks:

1. Emission Level(dBuV/m) = Raw Value(dBuV) + Correction Factor(dB/m)
2. Correction Factor(dB/m) = Antenna Factor(dB/m) + Cable Factor(dB)
3. The other emission levels were very low against the limit.
4. Margin value = Emission Level – Limit value
5. " * ": Fundamental frequency.

CHANNEL	TX Channel 140	DETECTOR FUNCTION	Peak (PK)
FREQUENCY RANGE	1GHz ~ 40GHz		Average (AV)

ANTENNA POLARITY & TEST DISTANCE: HORIZONTAL AT 3 M

NO.	FREQ. (MHz)	EMISSION LEVEL (dBuV/m)	LIMIT (dBuV/m)	MARGIN (dB)	ANTENNA HEIGHT (m)	TABLE ANGLE (Degree)	RAW VALUE (dBuV)	CORRECTION FACTOR (dB/m)
1	*5700.00	99.6 PK			1.00 H	255	58.80	40.80
2	*5700.00	89.4 AV			1.00 H	255	48.60	40.80
3	#5725.00	63.6 PK	74.0	-10.4	1.05 H	270	56.70	6.90
4	#5725.00	49.5 AV	54.0	-4.5	1.05 H	270	42.60	6.90
5	11400.00	59.2 PK	74.0	-14.8	1.23 H	54	41.00	18.20
6	11400.00	46.9 AV	54.0	-7.1	1.23 H	54	28.70	18.20

ANTENNA POLARITY & TEST DISTANCE: VERTICAL AT 3 M

NO.	FREQ. (MHz)	EMISSION LEVEL (dBuV/m)	LIMIT (dBuV/m)	MARGIN (dB)	ANTENNA HEIGHT (m)	TABLE ANGLE (Degree)	RAW VALUE (dBuV)	CORRECTION FACTOR (dB/m)
1	*5700.00	104.6 PK			2.24 V	299	63.80	40.80
2	*5700.00	94.1 AV			2.24 V	299	53.30	40.80
3	#5725.00	69.0 PK	74.0	-5.0	2.30 V	310	62.10	6.90
4	#5725.00	53.0 AV	54.0	-1.0	2.30 V	310	46.10	6.90
5	11400.00	60.8 PK	74.0	-13.2	1.23 V	96	42.60	18.20
6	11400.00	48.3 AV	54.0	-5.7	1.23 V	96	30.10	18.20

Remarks:

1. Emission Level(dBuV/m) = Raw Value(dBuV) + Correction Factor(dB/m)
2. Correction Factor(dB/m) = Antenna Factor(dB/m) + Cable Factor(dB)
3. The other emission levels were very low against the limit.
4. Margin value = Emission Level – Limit value
5. " * ": Fundamental frequency.
6. " # ": The radiated frequency is out of the restricted band.

CHANNEL	TX Channel 149	DETECTOR FUNCTION	Peak (PK)
FREQUENCY RANGE	1GHz ~ 40GHz		Average (AV)

ANTENNA POLARITY & TEST DISTANCE: HORIZONTAL AT 3 M

NO.	FREQ. (MHz)	EMISSION LEVEL (dBuV/m)	LIMIT (dBuV/m)	MARGIN (dB)	ANTENNA HEIGHT (m)	TABLE ANGLE (Degree)	RAW VALUE (dBuV)	CORRECTION FACTOR (dB/m)
1	#5714.00	62.3 PK	74.0	-11.7	1.25 H	75	56.00	6.30
2	#5714.00	48.2 AV	54.0	-5.8	1.25 H	75	41.90	6.30
3	#5722.00	67.2 PK	78.2	-11.0	1.23 H	75	60.90	6.30
4	#5725.00	61.1 PK	78.2	-17.1	1.23 H	74	54.80	6.30
5	*5745.00	100.5 PK			1.21 H	72	60.20	40.30
6	*5745.00	90.2 AV			1.21 H	72	49.90	40.30
7	11490.00	58.2 PK	74.0	-15.8	1.55 H	201	41.00	17.20
8	11490.00	45.3 AV	54.0	-8.7	1.55 H	201	28.10	17.20

ANTENNA POLARITY & TEST DISTANCE: VERTICAL AT 3 M

NO.	FREQ. (MHz)	EMISSION LEVEL (dBuV/m)	LIMIT (dBuV/m)	MARGIN (dB)	ANTENNA HEIGHT (m)	TABLE ANGLE (Degree)	RAW VALUE (dBuV)	CORRECTION FACTOR (dB/m)
1	#5714.00	65.8 PK	74.0	-8.2	1.00 V	168	59.50	6.30
2	#5714.00	51.9 AV	54.0	-2.1	1.00 V	168	45.60	6.30
3	#5722.00	72.3 PK	78.2	-5.9	1.05 V	170	66.00	6.30
4	#5725.00	65.8 PK	78.2	-12.4	1.02 V	164	59.50	6.30
5	*5745.00	105.5 PK			1.00 V	167	65.20	40.30
6	*5745.00	95.8 AV			1.00 V	167	55.50	40.30
7	11490.00	60.2 PK	74.0	-13.8	1.08 V	45	43.00	17.20
8	11490.00	47.6 AV	54.0	-6.4	1.08 V	45	30.40	17.20

Remarks:

1. Emission Level(dBuV/m) = Raw Value(dBuV) + Correction Factor(dB/m)
2. Correction Factor(dB/m) = Antenna Factor(dB/m) + Cable Factor(dB)
3. The other emission levels were very low against the limit.
4. Margin value = Emission Level – Limit value
5. " * ": Fundamental frequency.
6. " # ": The radiated frequency is out of the restricted band.

CHANNEL	TX Channel 157	DETECTOR FUNCTION	Peak (PK)
FREQUENCY RANGE	1GHz ~ 40GHz		Average (AV)

ANTENNA POLARITY & TEST DISTANCE: HORIZONTAL AT 3 M

NO.	FREQ. (MHz)	EMISSION LEVEL (dBuV/m)	LIMIT (dBuV/m)	MARGIN (dB)	ANTENNA HEIGHT (m)	TABLE ANGLE (Degree)	RAW VALUE (dBuV)	CORRECTION FACTOR (dB/m)
1	*5785.00	101.1 PK			1.56 H	20	60.70	40.40
2	*5785.00	91.0 AV			1.56 H	20	50.60	40.40
3	11570.00	57.6 PK	74.0	-16.4	1.28 H	97	40.30	17.30
4	11570.00	46.0 AV	54.0	-8.0	1.28 H	97	28.70	17.30

ANTENNA POLARITY & TEST DISTANCE: VERTICAL AT 3 M

NO.	FREQ. (MHz)	EMISSION LEVEL (dBuV/m)	LIMIT (dBuV/m)	MARGIN (dB)	ANTENNA HEIGHT (m)	TABLE ANGLE (Degree)	RAW VALUE (dBuV)	CORRECTION FACTOR (dB/m)
1	*5785.00	105.9 PK			1.00 V	179	65.50	40.40
2	*5785.00	95.1 AV			1.00 V	179	54.70	40.40
3	11570.00	60.3 PK	74.0	-13.7	1.23 V	96	43.00	17.30
4	11570.00	47.5 AV	54.0	-6.5	1.23 V	96	30.20	17.30

Remarks:

1. Emission Level(dBuV/m) = Raw Value(dBuV) + Correction Factor(dB/m)
2. Correction Factor(dB/m) = Antenna Factor(dB/m) + Cable Factor(dB)
3. The other emission levels were very low against the limit.
4. Margin value = Emission Level – Limit value
5. " * ": Fundamental frequency.

CHANNEL	TX Channel 165	DETECTOR FUNCTION	Peak (PK)
FREQUENCY RANGE	1GHz ~ 40GHz		Average (AV)

ANTENNA POLARITY & TEST DISTANCE: HORIZONTAL AT 3 M

NO.	FREQ. (MHz)	EMISSION LEVEL (dBuV/m)	LIMIT (dBuV/m)	MARGIN (dB)	ANTENNA HEIGHT (m)	TABLE ANGLE (Degree)	RAW VALUE (dBuV)	CORRECTION FACTOR (dB/m)
1	*5825.00	101.3 PK			1.51 H	207	60.80	40.50
2	*5825.00	91.4 AV			1.51 H	207	50.90	40.50
3	#5850.00	57.6 PK	78.2	-20.6	1.49 H	204	51.00	6.60
4	#5853.00	68.4 PK	78.2	-9.8	1.55 H	202	61.80	6.60
5	#5861.00	67.8 PK	74.0	-6.2	1.52 H	210	61.20	6.60
6	#5861.00	48.9 AV	54.0	-5.1	1.52 H	210	42.30	6.60
7	11650.00	58.4 PK	74.0	-15.6	1.07 H	41	40.70	17.70
8	11650.00	46.4 AV	54.0	-7.6	1.07 H	41	28.70	17.70

ANTENNA POLARITY & TEST DISTANCE: VERTICAL AT 3 M

NO.	FREQ. (MHz)	EMISSION LEVEL (dBuV/m)	LIMIT (dBuV/m)	MARGIN (dB)	ANTENNA HEIGHT (m)	TABLE ANGLE (Degree)	RAW VALUE (dBuV)	CORRECTION FACTOR (dB/m)
1	*5825.00	106.1 PK			1.00 V	166	65.60	40.50
2	*5825.00	96.5 AV			1.00 V	166	56.00	40.50
3	#5850.00	61.3 PK	78.2	-16.9	1.05 V	171	54.70	6.60
4	#5853.00	69.7 PK	78.2	-8.5	1.01 V	171	63.10	6.60
5	#5861.00	69.2 PK	74.0	-4.8	1.00 V	170	62.60	6.60
6	#5861.00	49.2 AV	54.0	-4.8	1.00 V	170	42.60	6.60
7	11650.00	60.7 PK	74.0	-13.3	1.02 V	64	43.00	17.70
8	11650.00	47.7 AV	54.0	-6.3	1.02 V	64	30.00	17.70

Remarks:

1. Emission Level(dBuV/m) = Raw Value(dBuV) + Correction Factor(dB/m)
2. Correction Factor(dB/m) = Antenna Factor(dB/m) + Cable Factor(dB)
3. The other emission levels were very low against the limit.
4. Margin value = Emission Level – Limit value
5. " * ": Fundamental frequency.
6. " # ": The radiated frequency is out of the restricted band.

802.11n (HT20)

CHANNEL	TX Channel 36	DETECTOR FUNCTION	Peak (PK)
FREQUENCY RANGE	1GHz ~ 40GHz		Average (AV)

ANTENNA POLARITY & TEST DISTANCE: HORIZONTAL AT 3 M								
NO.	FREQ. (MHz)	EMISSION LEVEL (dBuV/m)	LIMIT (dBuV/m)	MARGIN (dB)	ANTENNA HEIGHT (m)	TABLE ANGLE (Degree)	RAW VALUE (dBuV)	CORRECTION FACTOR (dB/m)
1	5150.00	62.5 PK	74.0	-11.5	1.60 H	200	57.20	5.30
2	5150.00	48.0 AV	54.0	-6.0	1.60 H	200	42.70	5.30
3	*5180.00	102.0 PK			1.52 H	194	62.80	39.20
4	*5180.00	91.9 AV			1.52 H	194	52.70	39.20
5	#10360.00	58.5 PK	74.0	-15.5	1.32 H	69	40.10	18.40
6	#10360.00	47.4 AV	54.0	-6.6	1.32 H	69	29.00	18.40
ANTENNA POLARITY & TEST DISTANCE: VERTICAL AT 3 M								
NO.	FREQ. (MHz)	EMISSION LEVEL (dBuV/m)	LIMIT (dBuV/m)	MARGIN (dB)	ANTENNA HEIGHT (m)	TABLE ANGLE (Degree)	RAW VALUE (dBuV)	CORRECTION FACTOR (dB/m)
1	5150.00	67.0 PK	74.0	-7.0	1.37 V	93	61.70	5.30
2	5150.00	52.4 AV	54.0	-1.6	1.37 V	93	47.10	5.30
3	*5180.00	104.1 PK			1.41 V	100	64.90	39.20
4	*5180.00	94.1 AV			1.41 V	100	54.90	39.20
5	#10380.00	59.8 PK	74.0	-14.2	1.23 V	69	41.60	18.20
6	#10380.00	48.2 AV	54.0	-5.8	1.23 V	69	30.00	18.20

Remarks:

1. Emission Level(dBuV/m) = Raw Value(dBuV) + Correction Factor(dB/m)
2. Correction Factor(dB/m) = Antenna Factor(dB/m) + Cable Factor(dB)
3. The other emission levels were very low against the limit.
4. Margin value = Emission Level – Limit value
5. " * ": Fundamental frequency.
6. " # ": The radiated frequency is out of the restricted band.

CHANNEL	TX Channel 40	DETECTOR	Peak (PK)
FREQUENCY RANGE	1GHz ~ 40GHz	FUNCTION	Average (AV)

ANTENNA POLARITY & TEST DISTANCE: HORIZONTAL AT 3 M

NO.	FREQ. (MHz)	EMISSION LEVEL (dBuV/m)	LIMIT (dBuV/m)	MARGIN (dB)	ANTENNA HEIGHT (m)	TABLE ANGLE (Degree)	RAW VALUE (dBuV)	CORRECTION FACTOR (dB/m)
1	*5200.00	103.3 PK			1.52 H	195	64.00	39.30
2	*5200.00	92.6 AV			1.52 H	195	53.30	39.30
3	#10400.00	58.4 PK	74.0	-15.6	1.47 H	85	40.20	18.20
4	#10400.00	47.2 AV	54.0	-6.8	1.47 H	85	29.00	18.20

ANTENNA POLARITY & TEST DISTANCE: VERTICAL AT 3 M

NO.	FREQ. (MHz)	EMISSION LEVEL (dBuV/m)	LIMIT (dBuV/m)	MARGIN (dB)	ANTENNA HEIGHT (m)	TABLE ANGLE (Degree)	RAW VALUE (dBuV)	CORRECTION FACTOR (dB/m)
1	*5200.00	107.4 PK			1.01 V	283	68.10	39.30
2	*5200.00	97.3 AV			1.01 V	283	58.00	39.30
3	#10400.00	60.1 PK	74.0	-13.9	1.32 V	69	41.90	18.20
4	#10400.00	48.4 AV	54.0	-5.6	1.32 V	69	30.20	18.20

Remarks:

1. Emission Level(dBuV/m) = Raw Value(dBuV) + Correction Factor(dB/m)
2. Correction Factor(dB/m) = Antenna Factor(dB/m) + Cable Factor(dB)
3. The other emission levels were very low against the limit.
4. Margin value = Emission Level – Limit value
5. " * ": Fundamental frequency.
6. " # ": The radiated frequency is out of the restricted band.

CHANNEL	TX Channel 48	DETECTOR FUNCTION	Peak (PK)
FREQUENCY RANGE	1GHz ~ 40GHz		Average (AV)

ANTENNA POLARITY & TEST DISTANCE: HORIZONTAL AT 3 M

NO.	FREQ. (MHz)	EMISSION LEVEL (dBuV/m)	LIMIT (dBuV/m)	MARGIN (dB)	ANTENNA HEIGHT (m)	TABLE ANGLE (Degree)	RAW VALUE (dBuV)	CORRECTION FACTOR (dB/m)
1	*5240.00	103.6 PK			1.48 H	194	64.30	39.30
2	*5240.00	92.9 AV			1.48 H	194	53.60	39.30
3	5350.00	55.6 PK	74.0	-18.4	1.56 H	204	50.00	5.60
4	5350.00	43.7 AV	54.0	-10.3	1.56 H	204	38.10	5.60
5	#10480.00	57.9 PK	74.0	-16.1	1.55 H	224	40.30	17.60
6	#10480.00	46.4 AV	54.0	-7.6	1.55 H	224	28.80	17.60

ANTENNA POLARITY & TEST DISTANCE: VERTICAL AT 3 M

NO.	FREQ. (MHz)	EMISSION LEVEL (dBuV/m)	LIMIT (dBuV/m)	MARGIN (dB)	ANTENNA HEIGHT (m)	TABLE ANGLE (Degree)	RAW VALUE (dBuV)	CORRECTION FACTOR (dB/m)
1	*5240.00	105.3 PK			1.00 V	19	66.00	39.30
2	*5240.00	96.3 AV			1.00 V	19	57.00	39.30
3	5350.00	56.8 PK	74.0	-17.2	1.05 V	26	51.20	5.60
4	5350.00	45.5 AV	54.0	-8.5	1.05 V	26	39.90	5.60
5	#10480.00	60.5 PK	74.0	-13.5	1.36 V	98	42.90	17.60
6	#10480.00	47.7 AV	54.0	-6.3	1.36 V	98	30.10	17.60

Remarks:

1. Emission Level(dBuV/m) = Raw Value(dBuV) + Correction Factor(dB/m)
2. Correction Factor(dB/m) = Antenna Factor(dB/m) + Cable Factor(dB)
3. The other emission levels were very low against the limit.
4. Margin value = Emission Level – Limit value
5. " * ": Fundamental frequency.
6. " # ": The radiated frequency is out of the restricted band.

CHANNEL	TX Channel 52	DETECTOR FUNCTION	Peak (PK)
FREQUENCY RANGE	1GHz ~ 40GHz		Average (AV)

ANTENNA POLARITY & TEST DISTANCE: HORIZONTAL AT 3 M								
NO.	FREQ. (MHz)	EMISSION LEVEL (dBuV/m)	LIMIT (dBuV/m)	MARGIN (dB)	ANTENNA HEIGHT (m)	TABLE ANGLE (Degree)	RAW VALUE (dBuV)	CORRECTION FACTOR (dB/m)
1	5150.00	55.7 PK	74.0	-18.3	1.52 H	201	50.40	5.30
2	5150.00	44.3 AV	54.0	-9.7	1.52 H	201	39.00	5.30
3	*5260.00	103.0 PK			1.48 H	194	63.70	39.30
4	*5260.00	93.2 AV			1.48 H	194	53.90	39.30
5	10640.00	57.5 PK	74.0	-16.5	1.07 H	41	40.30	17.20
6	10640.00	45.9 AV	54.0	-8.1	1.07 H	41	28.70	17.20
ANTENNA POLARITY & TEST DISTANCE: VERTICAL AT 3 M								
NO.	FREQ. (MHz)	EMISSION LEVEL (dBuV/m)	LIMIT (dBuV/m)	MARGIN (dB)	ANTENNA HEIGHT (m)	TABLE ANGLE (Degree)	RAW VALUE (dBuV)	CORRECTION FACTOR (dB/m)
1	5150.00	56.6 PK	74.0	-17.4	1.05 V	340	51.30	5.30
2	5150.00	45.4 AV	54.0	-8.6	1.05 V	340	40.10	5.30
3	*5260.00	107.7 PK			1.00 V	338	68.40	39.30
4	*5260.00	98.0 AV			1.00 V	338	58.70	39.30
5	10640.00	58.7 PK	74.0	-15.3	1.55 V	226	41.50	17.20
6	10640.00	47.1 AV	54.0	-6.9	1.55 V	226	29.90	17.20

Remarks:

1. Emission Level(dBuV/m) = Raw Value(dBuV) + Correction Factor(dB/m)
2. Correction Factor(dB/m) = Antenna Factor(dB/m) + Cable Factor(dB)
3. The other emission levels were very low against the limit.
4. Margin value = Emission Level – Limit value
5. " * ": Fundamental frequency.
6. " # ": The radiated frequency is out of the restricted band.

CHANNEL	TX Channel 60	DETECTOR FUNCTION	Peak (PK)
FREQUENCY RANGE	1GHz ~ 40GHz		Average (AV)

ANTENNA POLARITY & TEST DISTANCE: HORIZONTAL AT 3 M

NO.	FREQ. (MHz)	EMISSION LEVEL (dBuV/m)	LIMIT (dBuV/m)	MARGIN (dB)	ANTENNA HEIGHT (m)	TABLE ANGLE (Degree)	RAW VALUE (dBuV)	CORRECTION FACTOR (dB/m)
1	*5300.00	100.2 PK			1.47 H	251	60.80	39.40
2	*5300.00	90.4 AV			1.47 H	251	51.00	39.40
3	10600.00	57.7 PK	74.0	-16.3	1.07 H	41	40.30	17.40
4	10600.00	46.1 AV	54.0	-7.9	1.07 H	41	28.70	17.40

ANTENNA POLARITY & TEST DISTANCE: VERTICAL AT 3 M

NO.	FREQ. (MHz)	EMISSION LEVEL (dBuV/m)	LIMIT (dBuV/m)	MARGIN (dB)	ANTENNA HEIGHT (m)	TABLE ANGLE (Degree)	RAW VALUE (dBuV)	CORRECTION FACTOR (dB/m)
1	*5300.00	105.9 PK			1.00 V	335	66.50	39.40
2	*5300.00	97.0 AV			1.00 V	335	57.60	39.40
3	10600.00	59.7 PK	74.0	-14.3	1.57 V	41	42.30	17.40
4	10600.00	47.3 AV	54.0	-6.7	1.57 V	41	29.90	17.40

Remarks:

1. Emission Level(dBuV/m) = Raw Value(dBuV) + Correction Factor(dB/m)
2. Correction Factor(dB/m) = Antenna Factor(dB/m) + Cable Factor(dB)
3. The other emission levels were very low against the limit.
4. Margin value = Emission Level – Limit value
5. " * ": Fundamental frequency.

CHANNEL	TX Channel 64	DETECTOR FUNCTION	Peak (PK)
FREQUENCY RANGE	1GHz ~ 40GHz		Average (AV)

ANTENNA POLARITY & TEST DISTANCE: HORIZONTAL AT 3 M								
NO.	FREQ. (MHz)	EMISSION LEVEL (dBuV/m)	LIMIT (dBuV/m)	MARGIN (dB)	ANTENNA HEIGHT (m)	TABLE ANGLE (Degree)	RAW VALUE (dBuV)	CORRECTION FACTOR (dB/m)
1	*5320.00	100.2 PK			1.46 H	194	60.80	39.40
2	*5320.00	90.0 AV			1.46 H	194	50.60	39.40
3	5350.00	63.1 PK	74.0	-10.9	1.50 H	190	57.50	5.60
4	5350.00	48.3 AV	54.0	-5.7	1.50 H	190	42.70	5.60
5	10640.00	57.9 PK	74.0	-16.1	1.55 H	214	40.70	17.20
6	10640.00	45.9 AV	54.0	-8.1	1.55 H	214	28.70	17.20
ANTENNA POLARITY & TEST DISTANCE: VERTICAL AT 3 M								
NO.	FREQ. (MHz)	EMISSION LEVEL (dBuV/m)	LIMIT (dBuV/m)	MARGIN (dB)	ANTENNA HEIGHT (m)	TABLE ANGLE (Degree)	RAW VALUE (dBuV)	CORRECTION FACTOR (dB/m)
1	*5320.00	105.0 PK			1.10 V	290	65.60	39.40
2	*5320.00	94.8 AV			1.10 V	290	55.40	39.40
3	5350.00	68.8 PK	74.0	-5.2	1.05 V	289	63.20	5.60
4	5350.00	52.7 AV	54.0	-1.3	1.05 V	289	47.10	5.60
5	10640.00	58.8 PK	74.0	-15.2	1.07 V	11	41.60	17.20
6	10640.00	46.9 AV	54.0	-7.1	1.07 V	11	29.70	17.20

Remarks:

1. Emission Level(dBuV/m) = Raw Value(dBuV) + Correction Factor(dB/m)
2. Correction Factor(dB/m) = Antenna Factor(dB/m) + Cable Factor(dB)
3. The other emission levels were very low against the limit.
4. Margin value = Emission Level – Limit value
5. " * ": Fundamental frequency.

CHANNEL	TX Channel 100	DETECTOR FUNCTION	Peak (PK)
FREQUENCY RANGE	1GHz ~ 40GHz		Average (AV)

ANTENNA POLARITY & TEST DISTANCE: HORIZONTAL AT 3 M

NO.	FREQ. (MHz)	EMISSION LEVEL (dBuV/m)	LIMIT (dBuV/m)	MARGIN (dB)	ANTENNA HEIGHT (m)	TABLE ANGLE (Degree)	RAW VALUE (dBuV)	CORRECTION FACTOR (dB/m)
1	5460.00	64.6 PK	74.0	-9.4	1.10 H	340	57.90	6.70
2	5460.00	62.0 PK	74.0	-12.0	1.10 H	340	55.30	6.70
3	5460.00	50.7 AV	54.0	-3.3	1.10 H	340	44.00	6.70
4	5460.00	46.7 AV	54.0	-7.3	1.10 H	340	40.00	6.70
5	*5500.00	101.2 PK			1.00 H	331	60.70	40.50
6	*5500.00	91.6 AV			1.00 H	331	51.10	40.50
7	11000.00	59.1 PK	74.0	-14.9	1.23 H	64	41.00	18.10
8	11000.00	46.5 AV	54.0	-7.5	1.23 H	64	28.40	18.10

ANTENNA POLARITY & TEST DISTANCE: VERTICAL AT 3 M

NO.	FREQ. (MHz)	EMISSION LEVEL (dBuV/m)	LIMIT (dBuV/m)	MARGIN (dB)	ANTENNA HEIGHT (m)	TABLE ANGLE (Degree)	RAW VALUE (dBuV)	CORRECTION FACTOR (dB/m)
1	5460.00	67.2 PK	74.0	-6.8	1.02 V	285	60.50	6.70
2	5460.00	48.3 AV	54.0	-5.7	1.02 V	285	41.60	6.70
3	#5470.00	71.3 PK	74.0	-2.7	1.02 V	285	64.60	6.70
4	#5470.00	53.0 AV	54.0	-1.0	1.02 V	285	46.30	6.70
5	*5500.00	105.9 PK			1.10 V	280	65.40	40.50
6	*5500.00	95.8 AV			1.10 V	280	55.30	40.50
7	11000.00	61.0 PK	74.0	-13.0	1.05 V	66	42.90	18.10
8	11000.00	48.1 AV	54.0	-5.9	1.05 V	66	30.00	18.10

Remarks:

1. Emission Level(dBuV/m) = Raw Value(dBuV) + Correction Factor(dB/m)
2. Correction Factor(dB/m) = Antenna Factor(dB/m) + Cable Factor(dB)
3. The other emission levels were very low against the limit.
4. Margin value = Emission Level – Limit value
5. " * ": Fundamental frequency.
6. " # ": The radiated frequency is out of the restricted band.

CHANNEL	TX Channel 116	DETECTOR FUNCTION	Peak (PK)
FREQUENCY RANGE	1GHz ~ 40GHz		Average (AV)

ANTENNA POLARITY & TEST DISTANCE: HORIZONTAL AT 3 M

NO.	FREQ. (MHz)	EMISSION LEVEL (dBuV/m)	LIMIT (dBuV/m)	MARGIN (dB)	ANTENNA HEIGHT (m)	TABLE ANGLE (Degree)	RAW VALUE (dBuV)	CORRECTION FACTOR (dB/m)
1	*5580.00	100.2 PK			1.75 H	4	59.70	40.50
2	*5580.00	89.3 AV			1.75 H	4	48.80	40.50
3	11160.00	60.1 PK	74.0	-13.9	1.26 H	97	41.00	19.10
4	11160.00	47.8 AV	54.0	-6.2	1.26 H	97	28.70	19.10

ANTENNA POLARITY & TEST DISTANCE: VERTICAL AT 3 M

NO.	FREQ. (MHz)	EMISSION LEVEL (dBuV/m)	LIMIT (dBuV/m)	MARGIN (dB)	ANTENNA HEIGHT (m)	TABLE ANGLE (Degree)	RAW VALUE (dBuV)	CORRECTION FACTOR (dB/m)
1	*5580.00	105.6 PK			1.00 V	285	65.10	40.50
2	*5580.00	95.7 AV			1.00 V	285	55.20	40.50
3	11160.00	62.1 PK	74.0	-11.9	1.23 V	69	43.00	19.10
4	11160.00	49.3 AV	54.0	-4.7	1.23 V	69	30.20	19.10

Remarks:

1. Emission Level(dBuV/m) = Raw Value(dBuV) + Correction Factor(dB/m)
2. Correction Factor(dB/m) = Antenna Factor(dB/m) + Cable Factor(dB)
3. The other emission levels were very low against the limit.
4. Margin value = Emission Level – Limit value
5. " * ": Fundamental frequency.

CHANNEL	TX Channel 140	DETECTOR FUNCTION	Peak (PK)
FREQUENCY RANGE	1GHz ~ 40GHz		Average (AV)

ANTENNA POLARITY & TEST DISTANCE: HORIZONTAL AT 3 M								
NO.	FREQ. (MHz)	EMISSION LEVEL (dBuV/m)	LIMIT (dBuV/m)	MARGIN (dB)	ANTENNA HEIGHT (m)	TABLE ANGLE (Degree)	RAW VALUE (dBuV)	CORRECTION FACTOR (dB/m)
1	*5700.00	99.6 PK			1.00 H	211	58.80	40.80
2	*5700.00	89.3 AV			1.00 H	211	48.50	40.80
3	#5725.00	66.7 PK	74.0	-7.3	1.05 H	220	59.80	6.90
4	#5725.00	50.7 AV	54.0	-3.3	1.05 H	220	43.80	6.90
5	11440.00	59.1 PK	74.0	-14.9	1.33 H	224	41.00	18.10
6	11440.00	46.8 AV	54.0	-7.2	1.33 H	224	28.70	18.10
ANTENNA POLARITY & TEST DISTANCE: VERTICAL AT 3 M								
NO.	FREQ. (MHz)	EMISSION LEVEL (dBuV/m)	LIMIT (dBuV/m)	MARGIN (dB)	ANTENNA HEIGHT (m)	TABLE ANGLE (Degree)	RAW VALUE (dBuV)	CORRECTION FACTOR (dB/m)
1	*5700.00	104.3 PK			2.24 V	299	63.50	40.80
2	*5700.00	94.6 AV			2.24 V	299	53.80	40.80
3	#5725.00	70.1 PK	74.0	-3.9	2.30 V	310	63.20	6.90
4	#5725.00	53.0 AV	54.0	-1.0	2.30 V	310	46.10	6.90
5	11440.00	60.4 PK	74.0	-13.6	1.32 V	105	42.30	18.10
6	11440.00	48.2 AV	54.0	-5.8	1.32 V	105	30.10	18.10

Remarks:

1. Emission Level(dBuV/m) = Raw Value(dBuV) + Correction Factor(dB/m)
2. Correction Factor(dB/m) = Antenna Factor(dB/m) + Cable Factor(dB)
3. The other emission levels were very low against the limit.
4. Margin value = Emission Level – Limit value
5. " * ": Fundamental frequency.
6. " # ": The radiated frequency is out of the restricted band.

CHANNEL	TX Channel 149	DETECTOR FUNCTION	Peak (PK)
FREQUENCY RANGE	1GHz ~ 40GHz		Average (AV)

ANTENNA POLARITY & TEST DISTANCE: HORIZONTAL AT 3 M								
NO.	FREQ. (MHz)	EMISSION LEVEL (dBuV/m)	LIMIT (dBuV/m)	MARGIN (dB)	ANTENNA HEIGHT (m)	TABLE ANGLE (Degree)	RAW VALUE (dBuV)	CORRECTION FACTOR (dB/m)
1	#5714.00	69.7 PK	74.0	-4.3	1.40 H	201	63.40	6.30
2	#5714.00	52.0 AV	54.0	-2.0	1.40 H	201	45.70	6.30
3	#5722.00	77.0 PK	78.2	-1.2	1.35 H	198	70.70	6.30
4	#5725.00	61.2 PK	78.2	-17.0	1.40 H	213	54.90	6.30
5	*5745.00	101.2 PK			1.08 H	252	60.90	40.30
6	*5745.00	91.2 AV			1.08 H	252	50.90	40.30
7	11490.00	58.1 PK	74.0	-15.9	1.23 H	64	40.90	17.20
8	11490.00	45.9 AV	54.0	-8.1	1.23 H	64	28.70	17.20

ANTENNA POLARITY & TEST DISTANCE: VERTICAL AT 3 M								
NO.	FREQ. (MHz)	EMISSION LEVEL (dBuV/m)	LIMIT (dBuV/m)	MARGIN (dB)	ANTENNA HEIGHT (m)	TABLE ANGLE (Degree)	RAW VALUE (dBuV)	CORRECTION FACTOR (dB/m)
1	#5714.00	67.7 PK	74.0	-6.3	1.10 V	280	61.40	6.30
2	#5714.00	52.5 AV	54.0	-1.5	1.10 V	280	46.20	6.30
3	#5722.00	76.6 PK	78.2	-1.6	1.05 V	274	70.30	6.30
4	#5725.00	68.1 PK	78.2	-10.1	1.07 V	280	61.80	6.30
5	*5745.00	105.5 PK			1.02 V	276	65.20	40.30
6	*5745.00	95.9 AV			1.02 V	276	55.60	40.30
7	11490.00	59.5 PK	74.0	-14.5	1.25 V	74	42.30	17.20
8	11490.00	47.2 AV	54.0	-6.8	1.25 V	74	30.00	17.20

Remarks:

1. Emission Level(dBuV/m) = Raw Value(dBuV) + Correction Factor(dB/m)
2. Correction Factor(dB/m) = Antenna Factor(dB/m) + Cable Factor(dB)
3. The other emission levels were very low against the limit.
4. Margin value = Emission Level – Limit value
5. " * ": Fundamental frequency.
6. " # ": The radiated frequency is out of the restricted band.

CHANNEL	TX Channel 157	DETECTOR FUNCTION	Peak (PK)
FREQUENCY RANGE	1GHz ~ 40GHz		Average (AV)

ANTENNA POLARITY & TEST DISTANCE: HORIZONTAL AT 3 M

NO.	FREQ. (MHz)	EMISSION LEVEL (dBuV/m)	LIMIT (dBuV/m)	MARGIN (dB)	ANTENNA HEIGHT (m)	TABLE ANGLE (Degree)	RAW VALUE (dBuV)	CORRECTION FACTOR (dB/m)
1	*5785.00	101.3 PK			1.00 H	209	60.90	40.40
2	*5785.00	91.7 AV			1.00 H	209	51.30	40.40
3	11570.00	58.2 PK	74.0	-15.8	1.23 H	98	40.90	17.30
4	11570.00	46.0 AV	54.0	-8.0	1.23 H	98	28.70	17.30

ANTENNA POLARITY & TEST DISTANCE: VERTICAL AT 3 M

NO.	FREQ. (MHz)	EMISSION LEVEL (dBuV/m)	LIMIT (dBuV/m)	MARGIN (dB)	ANTENNA HEIGHT (m)	TABLE ANGLE (Degree)	RAW VALUE (dBuV)	CORRECTION FACTOR (dB/m)
1	*5785.00	104.1 PK			1.00 V	136	63.70	40.40
2	*5785.00	93.6 AV			1.00 V	136	53.20	40.40
3	11570.00	58.3 PK	74.0	-15.7	1.25 V	96	41.00	17.30
4	11570.00	46.0 AV	54.0	-8.0	1.25 V	96	28.70	17.30

Remarks:

1. Emission Level(dBuV/m) = Raw Value(dBuV) + Correction Factor(dB/m)
2. Correction Factor(dB/m) = Antenna Factor(dB/m) + Cable Factor(dB)
3. The other emission levels were very low against the limit.
4. Margin value = Emission Level – Limit value
5. " * " : Fundamental frequency.

CHANNEL	TX Channel 165	DETECTOR FUNCTION	Peak (PK)
FREQUENCY RANGE	1GHz ~ 40GHz		Average (AV)

ANTENNA POLARITY & TEST DISTANCE: HORIZONTAL AT 3 M								
NO.	FREQ. (MHz)	EMISSION LEVEL (dBuV/m)	LIMIT (dBuV/m)	MARGIN (dB)	ANTENNA HEIGHT (m)	TABLE ANGLE (Degree)	RAW VALUE (dBuV)	CORRECTION FACTOR (dB/m)
1	*5825.00	101.3 PK			1.36 H	62	60.80	40.50
2	*5825.00	90.6 AV			1.36 H	62	50.10	40.50
3	#5850.00	58.1 PK	78.2	-20.1	1.38 H	65	51.50	6.60
4	#5853.00	69.8 PK	78.2	-8.4	1.40 H	70	63.20	6.60
5	#5861.00	66.1 PK	74.0	-7.9	1.40 H	65	59.50	6.60
6	#5861.00	49.1 AV	54.0	-4.9	1.40 H	65	42.50	6.60
7	11650.00	59.2 PK	74.0	-14.8	1.23 H	65	41.50	17.70
8	11650.00	46.1 AV	54.0	-7.9	1.23 H	65	28.40	17.70

ANTENNA POLARITY & TEST DISTANCE: VERTICAL AT 3 M								
NO.	FREQ. (MHz)	EMISSION LEVEL (dBuV/m)	LIMIT (dBuV/m)	MARGIN (dB)	ANTENNA HEIGHT (m)	TABLE ANGLE (Degree)	RAW VALUE (dBuV)	CORRECTION FACTOR (dB/m)
1	*5825.00	105.2 PK			1.01 V	274	64.70	40.50
2	*5825.00	95.8 AV			1.01 V	274	55.30	40.50
3	#5850.00	67.1 PK	78.2	-11.1	1.03 V	281	60.50	6.60
4	#5853.00	76.7 PK	78.2	-1.5	1.05 V	280	70.10	6.60
5	#5861.00	73.0 PK	74.0	-1.0	1.03 V	280	66.40	6.60
6	#5861.00	50.5 AV	54.0	-3.5	1.03 V	280	43.90	6.60
7	11650.00	60.4 PK	74.0	-13.6	1.06 V	98	42.70	17.70
8	11650.00	47.8 AV	54.0	-6.2	1.06 V	98	30.10	17.70

Remarks:

1. Emission Level(dBuV/m) = Raw Value(dBuV) + Correction Factor(dB/m)
2. Correction Factor(dB/m) = Antenna Factor(dB/m) + Cable Factor(dB)
3. The other emission levels were very low against the limit.
4. Margin value = Emission Level – Limit value
5. " * ": Fundamental frequency.
6. " # ": The radiated frequency is out of the restricted band.

802.11n (HT40)

CHANNEL	TX Channel 38	DETECTOR FUNCTION	Peak (PK)
FREQUENCY RANGE	1GHz ~ 40GHz		Average (AV)

ANTENNA POLARITY & TEST DISTANCE: HORIZONTAL AT 3 M

NO.	FREQ. (MHz)	EMISSION LEVEL (dBuV/m)	LIMIT (dBuV/m)	MARGIN (dB)	ANTENNA HEIGHT (m)	TABLE ANGLE (Degree)	RAW VALUE (dBuV)	CORRECTION FACTOR (dB/m)
1	5150.00	64.4 PK	74.0	-9.6	1.80 H	12	59.10	5.30
2	5150.00	48.4 AV	54.0	-5.6	1.80 H	12	43.10	5.30
3	*5190.00	97.9 PK			1.89 H	0	58.70	39.20
4	*5190.00	87.2 AV			1.89 H	0	48.00	39.20
5	#10380.00	58.5 PK	74.0	-15.5	1.07 H	14	40.30	18.20
6	#10380.00	46.9 AV	54.0	-7.1	1.07 H	14	28.70	18.20

ANTENNA POLARITY & TEST DISTANCE: VERTICAL AT 3 M

NO.	FREQ. (MHz)	EMISSION LEVEL (dBuV/m)	LIMIT (dBuV/m)	MARGIN (dB)	ANTENNA HEIGHT (m)	TABLE ANGLE (Degree)	RAW VALUE (dBuV)	CORRECTION FACTOR (dB/m)
1	5150.00	71.5 PK	74.0	-2.5	1.53 V	173	66.20	5.30
2	5150.00	53.0 AV	54.0	-1.0	1.53 V	173	47.70	5.30
3	*5190.00	99.8 PK			1.60 V	180	60.60	39.20
4	*5190.00	89.4 AV			1.60 V	180	50.20	39.20
5	#10380.00	60.5 PK	74.0	-13.5	1.03 V	65	42.30	18.20
6	#10380.00	48.3 AV	54.0	-5.7	1.03 V	65	30.10	18.20

Remarks:

1. Emission Level(dBuV/m) = Raw Value(dBuV) + Correction Factor(dB/m)
2. Correction Factor(dB/m) = Antenna Factor(dB/m) + Cable Factor(dB)
3. The other emission levels were very low against the limit.
4. Margin value = Emission Level – Limit value
5. " * ": Fundamental frequency.
6. " # ": The radiated frequency is out of the restricted band.

CHANNEL	TX Channel 46	DETECTOR FUNCTION	Peak (PK)
FREQUENCY RANGE	1GHz ~ 40GHz		Average (AV)

ANTENNA POLARITY & TEST DISTANCE: HORIZONTAL AT 3 M								
NO.	FREQ. (MHz)	EMISSION LEVEL (dBuV/m)	LIMIT (dBuV/m)	MARGIN (dB)	ANTENNA HEIGHT (m)	TABLE ANGLE (Degree)	RAW VALUE (dBuV)	CORRECTION FACTOR (dB/m)
1	*5230.00	100.7 PK			1.60 H	356	61.40	39.30
2	*5230.00	90.4 AV			1.60 H	356	51.10	39.30
3	5350.00	55.6 PK	74.0	-18.4	1.55 H	345	50.00	5.60
4	5350.00	44.6 AV	54.0	-9.4	1.55 H	345	39.00	5.60
5	#10460.00	58.2 PK	74.0	-15.8	1.13 H	204	40.50	17.70
6	#10460.00	46.4 AV	54.0	-7.6	1.13 H	204	28.70	17.70
ANTENNA POLARITY & TEST DISTANCE: VERTICAL AT 3 M								
NO.	FREQ. (MHz)	EMISSION LEVEL (dBuV/m)	LIMIT (dBuV/m)	MARGIN (dB)	ANTENNA HEIGHT (m)	TABLE ANGLE (Degree)	RAW VALUE (dBuV)	CORRECTION FACTOR (dB/m)
1	*5230.00	104.0 PK			1.45 V	332	64.70	39.30
2	*5230.00	93.8 AV			1.45 V	332	54.50	39.30
3	5350.00	57.2 PK	74.0	-16.8	1.55 V	340	51.60	5.60
4	5350.00	45.6 AV	54.0	-8.4	1.55 V	340	40.00	5.60
5	#10460.00	59.3 PK	74.0	-14.7	1.45 V	20	41.60	17.70
6	#10460.00	47.6 AV	54.0	-6.4	1.45 V	20	29.90	17.70

Remarks:

1. Emission Level(dBuV/m) = Raw Value(dBuV) + Correction Factor(dB/m)
2. Correction Factor(dB/m) = Antenna Factor(dB/m) + Cable Factor(dB)
3. The other emission levels were very low against the limit.
4. Margin value = Emission Level – Limit value
5. " * ": Fundamental frequency.
6. " # ": The radiated frequency is out of the restricted band.

CHANNEL	TX Channel 54	DETECTOR FUNCTION	Peak (PK)
FREQUENCY RANGE	1GHz ~ 40GHz		Average (AV)

ANTENNA POLARITY & TEST DISTANCE: HORIZONTAL AT 3 M								
NO.	FREQ. (MHz)	EMISSION LEVEL (dBuV/m)	LIMIT (dBuV/m)	MARGIN (dB)	ANTENNA HEIGHT (m)	TABLE ANGLE (Degree)	RAW VALUE (dBuV)	CORRECTION FACTOR (dB/m)
1	5150.00	55.3 PK	74.0	-18.7	1.56 H	206	50.00	5.30
2	5150.00	44.3 AV	54.0	-9.7	1.56 H	206	39.00	5.30
3	*5270.00	101.2 PK			1.49 H	194	61.90	39.30
4	*5270.00	90.0 AV			1.49 H	194	50.70	39.30
5	#10540.00	57.4 PK	74.0	-16.6	1.15 H	206	40.00	17.40
6	#10540.00	46.1 AV	54.0	-7.9	1.15 H	206	28.70	17.40

ANTENNA POLARITY & TEST DISTANCE: VERTICAL AT 3 M								
NO.	FREQ. (MHz)	EMISSION LEVEL (dBuV/m)	LIMIT (dBuV/m)	MARGIN (dB)	ANTENNA HEIGHT (m)	TABLE ANGLE (Degree)	RAW VALUE (dBuV)	CORRECTION FACTOR (dB/m)
1	5150.00	56.8 PK	74.0	-17.2	1.60 V	340	51.50	5.30
2	5150.00	43.7 AV	54.0	-10.3	1.60 V	340	38.40	5.30
3	*5270.00	104.7 PK			1.52 V	337	65.40	39.30
4	*5270.00	94.9 AV			1.52 V	337	55.60	39.30
5	#10540.00	59.4 PK	74.0	-14.6	1.07 V	41	42.00	17.40
6	#10540.00	47.1 AV	54.0	-6.9	1.07 V	41	29.70	17.40

Remarks:

1. Emission Level(dBuV/m) = Raw Value(dBuV) + Correction Factor(dB/m)
2. Correction Factor(dB/m) = Antenna Factor(dB/m) + Cable Factor(dB)
3. The other emission levels were very low against the limit.
4. Margin value = Emission Level – Limit value
5. " * ": Fundamental frequency.
6. " # ": The radiated frequency is out of the restricted band.

CHANNEL	TX Channel 62	DETECTOR FUNCTION	Peak (PK)
FREQUENCY RANGE	1GHz ~ 40GHz		Average (AV)

ANTENNA POLARITY & TEST DISTANCE: HORIZONTAL AT 3 M

NO.	FREQ. (MHz)	EMISSION LEVEL (dBuV/m)	LIMIT (dBuV/m)	MARGIN (dB)	ANTENNA HEIGHT (m)	TABLE ANGLE (Degree)	RAW VALUE (dBuV)	CORRECTION FACTOR (dB/m)
1	*5310.00	94.1 PK			1.33 H	247	54.70	39.40
2	*5310.00	84.1 AV			1.33 H	247	44.70	39.40
3	5350.00	64.6 PK	74.0	-9.4	1.36 H	250	59.00	5.60
4	5350.00	47.5 AV	54.0	-6.5	1.36 H	250	41.90	5.60
5	10620.00	57.3 PK	74.0	-16.7	1.55 H	174	40.00	17.30
6	10620.00	45.7 AV	54.0	-8.3	1.55 H	174	28.40	17.30

ANTENNA POLARITY & TEST DISTANCE: VERTICAL AT 3 M

NO.	FREQ. (MHz)	EMISSION LEVEL (dBuV/m)	LIMIT (dBuV/m)	MARGIN (dB)	ANTENNA HEIGHT (m)	TABLE ANGLE (Degree)	RAW VALUE (dBuV)	CORRECTION FACTOR (dB/m)
1	*5310.00	101.4 PK			1.10 V	300	62.00	39.40
2	*5310.00	91.5 AV			1.10 V	300	52.10	39.40
3	5350.00	69.4 PK	74.0	-4.6	1.00 V	291	63.80	5.60
4	5350.00	52.8 AV	54.0	-1.2	1.00 V	291	47.20	5.60
5	10620.00	58.8 PK	74.0	-15.2	1.52 V	64	41.50	17.30
6	10620.00	47.0 AV	54.0	-7.0	1.52 V	64	29.70	17.30

Remarks:

1. Emission Level(dBuV/m) = Raw Value(dBuV) + Correction Factor(dB/m)
2. Correction Factor(dB/m) = Antenna Factor(dB/m) + Cable Factor(dB)
3. The other emission levels were very low against the limit.
4. Margin value = Emission Level – Limit value
5. " * ": Fundamental frequency.

CHANNEL	TX Channel 102	DETECTOR FUNCTION	Peak (PK)
FREQUENCY RANGE	1GHz ~ 40GHz		Average (AV)

ANTENNA POLARITY & TEST DISTANCE: HORIZONTAL AT 3 M								
NO.	FREQ. (MHz)	EMISSION LEVEL (dBuV/m)	LIMIT (dBuV/m)	MARGIN (dB)	ANTENNA HEIGHT (m)	TABLE ANGLE (Degree)	RAW VALUE (dBuV)	CORRECTION FACTOR (dB/m)
1	5460.00	62.1 PK	74.0	-11.9	2.00 H	210	55.40	6.70
2	5460.00	47.2 AV	54.0	-6.8	2.00 H	210	40.50	6.70
3	#5470.00	66.7 PK	74.0	-7.3	2.00 H	210	60.00	6.70
4	#5470.00	49.6 AV	54.0	-4.4	2.00 H	210	42.90	6.70
5	*5510.00	97.4 PK			1.92 H	200	56.90	40.50
6	*5510.00	86.2 AV			1.92 H	200	45.70	40.50
7	11020.00	59.2 PK	74.0	-14.8	1.47 H	77	41.00	18.20
8	11020.00	46.9 AV	54.0	-7.1	1.47 H	77	28.70	18.20

ANTENNA POLARITY & TEST DISTANCE: VERTICAL AT 3 M								
NO.	FREQ. (MHz)	EMISSION LEVEL (dBuV/m)	LIMIT (dBuV/m)	MARGIN (dB)	ANTENNA HEIGHT (m)	TABLE ANGLE (Degree)	RAW VALUE (dBuV)	CORRECTION FACTOR (dB/m)
1	5460.00	65.7 PK	74.0	-8.3	1.10 V	80	59.00	6.70
2	5460.00	48.8 AV	54.0	-5.2	1.10 V	80	42.10	6.70
3	#5470.00	71.2 PK	74.0	-2.8	1.08 V	71	64.50	6.70
4	#5470.00	53.0 AV	54.0	-1.0	1.08 V	71	46.30	6.70
5	*5510.00	99.4 PK			1.02 V	286	58.90	40.50
6	*5510.00	89.3 AV			1.02 V	286	48.80	40.50
7	11020.00	60.8 PK	74.0	-13.2	1.23 V	98	42.60	18.20
8	11020.00	48.4 AV	54.0	-5.6	1.23 V	98	30.20	18.20

Remarks:

1. Emission Level(dBuV/m) = Raw Value(dBuV) + Correction Factor(dB/m)
2. Correction Factor(dB/m) = Antenna Factor(dB/m) + Cable Factor(dB)
3. The other emission levels were very low against the limit.
4. Margin value = Emission Level – Limit value
5. " * ": Fundamental frequency.
6. " # ": The radiated frequency is out of the restricted band.

CHANNEL	TX Channel 110	DETECTOR FUNCTION	Peak (PK)
FREQUENCY RANGE	1GHz ~ 40GHz		Average (AV)

ANTENNA POLARITY & TEST DISTANCE: HORIZONTAL AT 3 M

NO.	FREQ. (MHz)	EMISSION LEVEL (dBuV/m)	LIMIT (dBuV/m)	MARGIN (dB)	ANTENNA HEIGHT (m)	TABLE ANGLE (Degree)	RAW VALUE (dBuV)	CORRECTION FACTOR (dB/m)
1	*5550.00	99.5 PK			1.74 H	198	59.00	40.50
2	*5550.00	88.6 AV			1.74 H	198	48.10	40.50
3	11100.00	59.6 PK	74.0	-14.4	1.06 H	31	41.00	18.60
4	11100.00	47.3 AV	54.0	-6.7	1.06 H	31	28.70	18.60

ANTENNA POLARITY & TEST DISTANCE: VERTICAL AT 3 M

NO.	FREQ. (MHz)	EMISSION LEVEL (dBuV/m)	LIMIT (dBuV/m)	MARGIN (dB)	ANTENNA HEIGHT (m)	TABLE ANGLE (Degree)	RAW VALUE (dBuV)	CORRECTION FACTOR (dB/m)
1	*5550.00	101.5 PK			1.06 V	69	61.00	40.50
2	*5550.00	92.0 AV			1.06 V	69	51.50	40.50
3	11100.00	61.2 PK	74.0	-12.8	1.05 V	97	42.60	18.60
4	11100.00	48.7 AV	54.0	-5.3	1.05 V	97	30.10	18.60

Remarks:

1. Emission Level(dBuV/m) = Raw Value(dBuV) + Correction Factor(dB/m)
2. Correction Factor(dB/m) = Antenna Factor(dB/m) + Cable Factor(dB)
3. The other emission levels were very low against the limit.
4. Margin value = Emission Level – Limit value
5. " * ": Fundamental frequency.

CHANNEL	TX Channel 134	DETECTOR FUNCTION	Peak (PK)
FREQUENCY RANGE	1GHz ~ 40GHz		Average (AV)

ANTENNA POLARITY & TEST DISTANCE: HORIZONTAL AT 3 M								
NO.	FREQ. (MHz)	EMISSION LEVEL (dBuV/m)	LIMIT (dBuV/m)	MARGIN (dB)	ANTENNA HEIGHT (m)	TABLE ANGLE (Degree)	RAW VALUE (dBuV)	CORRECTION FACTOR (dB/m)
1	*5670.00	99.3 PK			1.02 H	212	58.50	40.80
2	*5670.00	88.6 AV			1.02 H	212	47.80	40.80
3	#5725.00	67.2 PK	74.0	-6.8	1.10 H	220	60.30	6.90
4	#5725.00	51.8 AV	54.0	-2.2	1.10 H	220	44.90	6.90
5	11340.00	60.2 PK	74.0	-13.8	1.05 H	98	41.30	18.90
6	11340.00	47.0 AV	54.0	-7.0	1.05 H	98	28.10	18.90
ANTENNA POLARITY & TEST DISTANCE: VERTICAL AT 3 M								
NO.	FREQ. (MHz)	EMISSION LEVEL (dBuV/m)	LIMIT (dBuV/m)	MARGIN (dB)	ANTENNA HEIGHT (m)	TABLE ANGLE (Degree)	RAW VALUE (dBuV)	CORRECTION FACTOR (dB/m)
1	*5670.00	98.2 PK			2.10 V	180	57.40	40.80
2	*5670.00	88.2 AV			2.10 V	180	47.40	40.80
3	#5725.00	66.8 PK	74.0	-7.2	2.03 V	172	59.90	6.90
4	#5725.00	52.8 AV	54.0	-1.2	2.03 V	172	45.90	6.90
5	11340.00	61.5 PK	74.0	-12.5	1.23 V	98	42.60	18.90
6	11340.00	49.1 AV	54.0	-4.9	1.23 V	98	30.20	18.90

Remarks:

1. Emission Level(dBuV/m) = Raw Value(dBuV) + Correction Factor(dB/m)
2. Correction Factor(dB/m) = Antenna Factor(dB/m) + Cable Factor(dB)
3. The other emission levels were very low against the limit.
4. Margin value = Emission Level – Limit value
5. " * ": Fundamental frequency.
6. " # ": The radiated frequency is out of the restricted band.

CHANNEL	TX Channel 151	DETECTOR FUNCTION	Peak (PK)
FREQUENCY RANGE	1GHz ~ 40GHz		Average (AV)

ANTENNA POLARITY & TEST DISTANCE: HORIZONTAL AT 3 M								
NO.	FREQ. (MHz)	EMISSION LEVEL (dBuV/m)	LIMIT (dBuV/m)	MARGIN (dB)	ANTENNA HEIGHT (m)	TABLE ANGLE (Degree)	RAW VALUE (dBuV)	CORRECTION FACTOR (dB/m)
1	#5714.00	66.7 PK	74.0	-7.3	1.65 H	210	60.40	6.30
2	#5714.00	49.0 AV	54.0	-5.0	1.65 H	210	42.70	6.30
3	#5722.00	68.8 PK	78.2	-9.4	1.63 H	210	62.50	6.30
4	#5725.00	60.3 PK	78.2	-17.9	1.67 H	204	54.00	6.30
5	*5755.00	96.7 PK			1.61 H	202	56.40	40.30
6	*5755.00	86.2 AV			1.61 H	202	45.90	40.30
7	11510.00	58.0 PK	74.0	-16.0	1.03 H	65	40.90	17.10
8	11510.00	45.1 AV	54.0	-8.9	1.03 H	65	28.00	17.10

ANTENNA POLARITY & TEST DISTANCE: VERTICAL AT 3 M								
NO.	FREQ. (MHz)	EMISSION LEVEL (dBuV/m)	LIMIT (dBuV/m)	MARGIN (dB)	ANTENNA HEIGHT (m)	TABLE ANGLE (Degree)	RAW VALUE (dBuV)	CORRECTION FACTOR (dB/m)
1	#5714.00	72.2 PK	74.0	-1.8	1.03 V	156	65.90	6.30
2	#5714.00	53.0 AV	54.0	-1.0	1.03 V	156	46.70	6.30
3	#5722.00	73.2 PK	78.2	-5.0	1.05 V	151	66.90	6.30
4	#5725.00	64.4 PK	78.2	-13.8	1.06 V	161	58.10	6.30
5	*5755.00	102.6 PK			2.71 V	292	62.30	40.30
6	*5755.00	93.3 AV			2.71 V	292	53.00	40.30
7	11510.00	59.4 PK	74.0	-14.6	1.23 V	65	42.30	17.10
8	11510.00	47.1 AV	54.0	-6.9	1.23 V	65	30.00	17.10

Remarks:

1. Emission Level(dBuV/m) = Raw Value(dBuV) + Correction Factor(dB/m)
2. Correction Factor(dB/m) = Antenna Factor(dB/m) + Cable Factor(dB)
3. The other emission levels were very low against the limit.
4. Margin value = Emission Level – Limit value
5. " * ": Fundamental frequency.
6. " # ": The radiated frequency is out of the restricted band.

CHANNEL	TX Channel 159	DETECTOR FUNCTION	Peak (PK)
FREQUENCY RANGE	1GHz ~ 40GHz		Average (AV)

ANTENNA POLARITY & TEST DISTANCE: HORIZONTAL AT 3 M

NO.	FREQ. (MHz)	EMISSION LEVEL (dBuV/m)	LIMIT (dBuV/m)	MARGIN (dB)	ANTENNA HEIGHT (m)	TABLE ANGLE (Degree)	RAW VALUE (dBuV)	CORRECTION FACTOR (dB/m)
1	*5795.00	96.9 PK			1.01 H	7	56.50	40.40
2	*5795.00	87.5 AV			1.01 H	7	47.10	40.40
3	#5850.00	59.2 PK	78.2	-19.0	1.11 H	11	52.60	6.60
4	#5853.00	62.6 PK	78.2	-15.6	1.08 H	15	56.00	6.60
5	#5861.00	62.1 PK	74.0	-11.9	1.06 H	10	55.50	6.60
6	#5861.00	47.1 AV	54.0	-6.9	1.06 H	10	40.50	6.60
7	11590.00	57.3 PK	74.0	-16.7	1.06 H	31	40.10	17.20
8	11590.00	45.3 AV	54.0	-8.7	1.06 H	31	28.10	17.20

ANTENNA POLARITY & TEST DISTANCE: VERTICAL AT 3 M

NO.	FREQ. (MHz)	EMISSION LEVEL (dBuV/m)	LIMIT (dBuV/m)	MARGIN (dB)	ANTENNA HEIGHT (m)	TABLE ANGLE (Degree)	RAW VALUE (dBuV)	CORRECTION FACTOR (dB/m)
1	*5795.00	101.3 PK			1.02 V	277	60.90	40.40
2	*5795.00	91.6 AV			1.02 V	277	51.20	40.40
3	#5850.00	65.3 PK	78.2	-12.9	1.06 V	274	58.70	6.60
4	#5853.00	67.5 PK	78.2	-10.7	1.03 V	275	60.90	6.60
5	#5861.00	67.4 PK	74.0	-6.6	1.08 V	285	60.80	6.60
6	#5861.00	49.5 AV	54.0	-4.5	1.08 V	285	42.90	6.60
7	11590.00	59.5 PK	74.0	-14.5	1.26 V	34	42.30	17.20
8	11590.00	47.3 AV	54.0	-6.7	1.26 V	34	30.10	17.20

Remarks:

1. Emission Level(dBuV/m) = Raw Value(dBuV) + Correction Factor(dB/m)
2. Correction Factor(dB/m) = Antenna Factor(dB/m) + Cable Factor(dB)
3. The other emission levels were very low against the limit.
4. Margin value = Emission Level – Limit value
5. " * ": Fundamental frequency.
6. " # ": The radiated frequency is out of the restricted band.

802.11ac (VHT80)

CHANNEL	TX Channel 42	DETECTOR FUNCTION	Peak (PK)
FREQUENCY RANGE	1GHz ~ 40GHz		Average (AV)

ANTENNA POLARITY & TEST DISTANCE: HORIZONTAL AT 3 M

NO.	FREQ. (MHz)	EMISSION LEVEL (dBuV/m)	LIMIT (dBuV/m)	MARGIN (dB)	ANTENNA HEIGHT (m)	TABLE ANGLE (Degree)	RAW VALUE (dBuV)	CORRECTION FACTOR (dB/m)
1	5150.00	62.9 PK	74.0	-11.1	1.60 H	200	57.60	5.30
2	5150.00	47.5 AV	54.0	-6.5	1.60 H	200	42.20	5.30
3	*5210.00	89.3 PK			1.53 H	196	50.00	39.30
4	*5210.00	78.1 AV			1.53 H	196	38.80	39.30
5	#10420.00	58.3 PK	74.0	-15.7	1.57 H	41	40.30	18.00
6	#10420.00	47.0 AV	54.0	-7.0	1.57 H	41	29.00	18.00

ANTENNA POLARITY & TEST DISTANCE: VERTICAL AT 3 M

NO.	FREQ. (MHz)	EMISSION LEVEL (dBuV/m)	LIMIT (dBuV/m)	MARGIN (dB)	ANTENNA HEIGHT (m)	TABLE ANGLE (Degree)	RAW VALUE (dBuV)	CORRECTION FACTOR (dB/m)
1	5150.00	66.8 PK	74.0	-7.2	1.00 V	116	61.50	5.30
2	5150.00	52.5 AV	54.0	-1.5	1.00 V	116	47.20	5.30
3	*5210.00	92.3 PK			1.00 V	123	53.00	39.30
4	*5210.00	81.8 AV			1.00 V	123	42.50	39.30
5	#10420.00	60.6 PK	74.0	-13.4	1.55 V	227	42.60	18.00
6	#10420.00	47.9 AV	54.0	-6.1	1.55 V	227	29.90	18.00

Remarks:

1. Emission Level(dBuV/m) = Raw Value(dBuV) + Correction Factor(dB/m)
2. Correction Factor(dB/m) = Antenna Factor(dB/m) + Cable Factor(dB)
3. The other emission levels were very low against the limit.
4. Margin value = Emission Level – Limit value
5. " * ": Fundamental frequency.
6. " # ": The radiated frequency is out of the restricted band.

CHANNEL	TX Channel 58	DETECTOR FUNCTION	Peak (PK)
FREQUENCY RANGE	1GHz ~ 40GHz		Average (AV)

ANTENNA POLARITY & TEST DISTANCE: HORIZONTAL AT 3 M								
NO.	FREQ. (MHz)	EMISSION LEVEL (dBuV/m)	LIMIT (dBuV/m)	MARGIN (dB)	ANTENNA HEIGHT (m)	TABLE ANGLE (Degree)	RAW VALUE (dBuV)	CORRECTION FACTOR (dB/m)
1	*5290.00	90.9 PK			1.49 H	196	51.60	39.30
2	*5290.00	78.9 AV			1.49 H	196	39.60	39.30
3	5350.00	61.6 PK	74.0	-12.4	1.51 H	206	56.00	5.60
4	5350.00	47.0 AV	54.0	-7.0	1.51 H	206	41.40	5.60
5	#10580.00	57.3 PK	74.0	-16.7	1.16 H	302	40.00	17.30
6	#10580.00	45.4 AV	54.0	-8.6	1.16 H	302	28.10	17.30

ANTENNA POLARITY & TEST DISTANCE: VERTICAL AT 3 M								
NO.	FREQ. (MHz)	EMISSION LEVEL (dBuV/m)	LIMIT (dBuV/m)	MARGIN (dB)	ANTENNA HEIGHT (m)	TABLE ANGLE (Degree)	RAW VALUE (dBuV)	CORRECTION FACTOR (dB/m)
1	*5290.00	94.3 PK			1.90 V	280	55.00	39.30
2	*5290.00	82.6 AV			1.90 V	280	43.30	39.30
3	5350.00	68.8 PK	74.0	-5.2	1.95 V	289	63.20	5.60
4	5350.00	53.0 AV	54.0	-1.0	1.95 V	289	47.40	5.60
5	#10580.00	59.2 PK	74.0	-14.8	1.23 V	64	41.90	17.30
6	#10580.00	47.1 AV	54.0	-6.9	1.23 V	64	29.80	17.30

Remarks:

1. Emission Level(dBuV/m) = Raw Value(dBuV) + Correction Factor(dB/m)
2. Correction Factor(dB/m) = Antenna Factor(dB/m) + Cable Factor(dB)
3. The other emission levels were very low against the limit.
4. Margin value = Emission Level – Limit value
5. " * ": Fundamental frequency.
6. " # ": The radiated frequency is out of the restricted band.

CHANNEL	TX Channel 106	DETECTOR FUNCTION	Peak (PK)
FREQUENCY RANGE	1GHz ~ 40GHz		Average (AV)

ANTENNA POLARITY & TEST DISTANCE: HORIZONTAL AT 3 M

NO.	FREQ. (MHz)	EMISSION LEVEL (dBuV/m)	LIMIT (dBuV/m)	MARGIN (dB)	ANTENNA HEIGHT (m)	TABLE ANGLE (Degree)	RAW VALUE (dBuV)	CORRECTION FACTOR (dB/m)
1	5460.00	64.1 PK	74.0	-9.9	1.85 H	180	57.40	6.70
2	5460.00	49.1 AV	54.0	-4.9	1.85 H	180	42.40	6.70
3	#5470.00	60.9 PK	74.0	-13.1	1.85 H	180	54.20	6.70
4	#5470.00	46.8 AV	54.0	-7.2	1.85 H	180	40.10	6.70
5	*5530.00	88.6 PK			1.91 H	173	48.10	40.50
6	*5530.00	77.2 AV			1.91 H	173	36.70	40.50
7	11060.00	59.3 PK	74.0	-14.7	1.00 H	45	41.00	18.30
8	11060.00	46.4 AV	54.0	-7.6	1.00 H	45	28.10	18.30

ANTENNA POLARITY & TEST DISTANCE: VERTICAL AT 3 M

NO.	FREQ. (MHz)	EMISSION LEVEL (dBuV/m)	LIMIT (dBuV/m)	MARGIN (dB)	ANTENNA HEIGHT (m)	TABLE ANGLE (Degree)	RAW VALUE (dBuV)	CORRECTION FACTOR (dB/m)
1	5460.00	67.9 PK	74.0	-6.1	1.00 V	148	61.20	6.70
2	5460.00	52.5 AV	54.0	-1.5	1.00 V	148	45.80	6.70
3	#5470.00	66.1 PK	74.0	-7.9	1.00 V	148	59.40	6.70
4	#5470.00	49.7 AV	54.0	-4.3	1.00 V	148	43.00	6.70
5	*5530.00	92.6 PK			1.01 V	341	52.10	40.50
6	*5530.00	82.1 AV			1.01 V	341	41.60	40.50
7	11060.00	60.9 PK	74.0	-13.1	1.05 V	98	42.60	18.30
8	11060.00	48.3 AV	54.0	-5.7	1.05 V	98	30.00	18.30

Remarks:

1. Emission Level(dBuV/m) = Raw Value(dBuV) + Correction Factor(dB/m)
2. Correction Factor(dB/m) = Antenna Factor(dB/m) + Cable Factor(dB)
3. The other emission levels were very low against the limit.
4. Margin value = Emission Level – Limit value
5. " * ": Fundamental frequency.
6. " # ": The radiated frequency is out of the restricted band.

CHANNEL	TX Channel 155	DETECTOR FUNCTION	Peak (PK)
FREQUENCY RANGE	1GHz ~ 40GHz		Average (AV)

ANTENNA POLARITY & TEST DISTANCE: HORIZONTAL AT 3 M								
NO.	FREQ. (MHz)	EMISSION LEVEL (dBuV/m)	LIMIT (dBuV/m)	MARGIN (dB)	ANTENNA HEIGHT (m)	TABLE ANGLE (Degree)	RAW VALUE (dBuV)	CORRECTION FACTOR (dB/m)
1	*5775.00	91.5 PK			1.58 H	204	51.10	40.40
2	*5775.00	80.0 AV			1.58 H	204	39.60	40.40
3	#5850.00	59.6 PK	78.2	-18.6	1.66 H	213	53.00	6.60
4	#5853.00	68.3 PK	78.2	-9.9	1.64 H	210	61.70	6.60
5	#5861.00	66.1 PK	74.0	-7.9	1.65 H	210	59.50	6.60
6	#5861.00	49.8 AV	54.0	-4.2	1.65 H	210	43.20	6.60
7	11550.00	57.3 PK	74.0	-16.7	1.33 H	221	40.20	17.10
8	11550.00	45.2 AV	54.0	-8.8	1.33 H	221	28.10	17.10

ANTENNA POLARITY & TEST DISTANCE: VERTICAL AT 3 M								
NO.	FREQ. (MHz)	EMISSION LEVEL (dBuV/m)	LIMIT (dBuV/m)	MARGIN (dB)	ANTENNA HEIGHT (m)	TABLE ANGLE (Degree)	RAW VALUE (dBuV)	CORRECTION FACTOR (dB/m)
1	*5775.00	93.8 PK			1.01 V	276	53.40	40.40
2	*5775.00	82.7 AV			1.01 V	276	42.30	40.40
3	#5850.00	61.2 PK	78.2	-17.0	1.09 V	281	54.60	6.60
4	#5853.00	70.9 PK	78.2	-7.3	1.06 V	280	64.30	6.60
5	#5861.00	68.1 PK	74.0	-5.9	1.01 V	275	61.50	6.60
6	#5861.00	52.6 AV	54.0	-1.4	1.01 V	275	46.00	6.60
7	11550.00	60.0 PK	74.0	-14.0	1.03 V	64	42.90	17.10
8	11550.00	47.1 AV	54.0	-6.9	1.03 V	64	30.00	17.10

Remarks:

1. Emission Level(dBuV/m) = Raw Value(dBuV) + Correction Factor(dB/m)
2. Correction Factor(dB/m) = Antenna Factor(dB/m) + Cable Factor(dB)
3. The other emission levels were very low against the limit.
4. Margin value = Emission Level – Limit value
5. " * ": Fundamental frequency.
6. " # ": The radiated frequency is out of the restricted band.

Below 1GHz Data: 802.11a

CHANNEL	TX Channel 36	DETECTOR FUNCTION	Quasi-Peak (QP)
FREQUENCY RANGE	30MHz ~ 1GHz		

ANTENNA POLARITY & TEST DISTANCE: HORIZONTAL AT 3 M								
NO.	FREQ. (MHz)	EMISSION LEVEL (dBuV/m)	LIMIT (dBuV/m)	MARGIN (dB)	ANTENNA HEIGHT (m)	TABLE ANGLE (Degree)	RAW VALUE (dBuV)	CORRECTION FACTOR (dB/m)
1	88.11	32.3 QP	43.5	-11.2	1.99 H	230	51.80	-19.50
2	167.67	34.7 QP	43.5	-8.8	1.24 H	84	48.70	-14.00
3	231.70	33.9 QP	46.0	-12.1	1.24 H	78	49.80	-15.90
4	497.54	33.0 QP	46.0	-13.0	1.24 H	126	42.00	-9.00
5	697.40	33.6 QP	46.0	-12.4	1.24 H	171	39.00	-5.40
6	899.20	37.0 QP	46.0	-9.0	1.49 H	70	38.50	-1.50
ANTENNA POLARITY & TEST DISTANCE: VERTICAL AT 3 M								
NO.	FREQ. (MHz)	EMISSION LEVEL (dBuV/m)	LIMIT (dBuV/m)	MARGIN (dB)	ANTENNA HEIGHT (m)	TABLE ANGLE (Degree)	RAW VALUE (dBuV)	CORRECTION FACTOR (dB/m)
1	62.89	39.0 QP	40.0	-1.0	1.01 V	76	54.10	-15.10
2	142.44	30.4 QP	43.5	-13.1	1.01 V	12	44.60	-14.20
3	470.37	35.7 QP	46.0	-10.3	1.01 V	12	45.20	-9.50
4	598.44	38.1 QP	46.0	-7.9	1.01 V	313	44.90	-6.80
5	798.30	39.3 QP	46.0	-6.7	1.01 V	76	42.50	-3.20
6	899.20	41.3 QP	46.0	-4.7	1.01 V	273	42.80	-1.50

Remarks:

1. Emission Level(dBuV/m) = Raw Value(dBuV) + Correction Factor(dB/m)
2. Correction Factor(dB/m) = Antenna Factor(dB/m) + Cable Factor(dB)
3. The other emission levels were very low against the limit.
4. Margin value = Emission Level – Limit value

4.2 Conducted Emission Measurement

4.2.1 Limits of Conducted Emission Measurement

Frequency (MHz)	Conducted Limit (dBuV)	
	Quasi-peak	Average
0.15 - 0.5	66 - 56	56 - 46
0.50 - 5.0	56	46
5.0 - 30.0	60	50

- Note:** 1. The lower limit shall apply at the transition frequencies.
 2. The limit decreases in line with the logarithm of the frequency in the range of 0.15 to 0.50MHz.

4.2.2 Test Instruments

Tested Date: Sep. 01, 2015

Description & Manufacturer	Model No.	Serial No.	Date Of Calibration	Due Date Of Calibration
Test Receiver ROHDE & SCHWARZ	ESCI	100613	Nov. 11, 2014	Nov. 10, 2015
RF signal cable (with 10dB PAD) Woken	5D-FB	Cable-cond1-01	Dec. 26, 2014	Dec. 25, 2015
LISN ROHDE & SCHWARZ (EUT)	ESH3-Z5	835239/001	Feb. 26, 2015	Feb. 25, 2016
LISN ROHDE & SCHWARZ (Peripheral)	ESH3-Z5	100311	Jul. 24, 2015	Jul. 23, 2016
Software ADT	BV ADT_Cond_ V7.3.7.3	NA	NA	NA

- Note:** 1. The calibration interval of the above test instruments is 12 months and the calibrations are traceable to NML/ROC and NIST/USA.
 2. The test was performed in HwaYa Shielded Room 1.
 3. The VCCI Site Registration No. is C-2040.

4.2.3 Test Procedures

- The EUT was placed 0.4 meters from the conducting wall of the shielded room with EUT being connected to the power mains through a line impedance stabilization network (LISN). Other support units were connected to the power mains through another LISN. The two LISNs provide 50 ohm/ 50uH of coupling impedance for the measuring instrument.
- Both lines of the power mains connected to the EUT were checked for maximum conducted interference.
- The frequency range from 150kHz to 30MHz was searched. Emission levels under (Limit - 20dB) was not recorded.

Note: The resolution bandwidth and video bandwidth of test receiver is 9kHz for quasi-peak detection (QP) and average detection (AV) at frequency 0.15MHz-30MHz.

4.2.4 Deviation from Test Standard

No deviation.

4.2.5 Test Setup

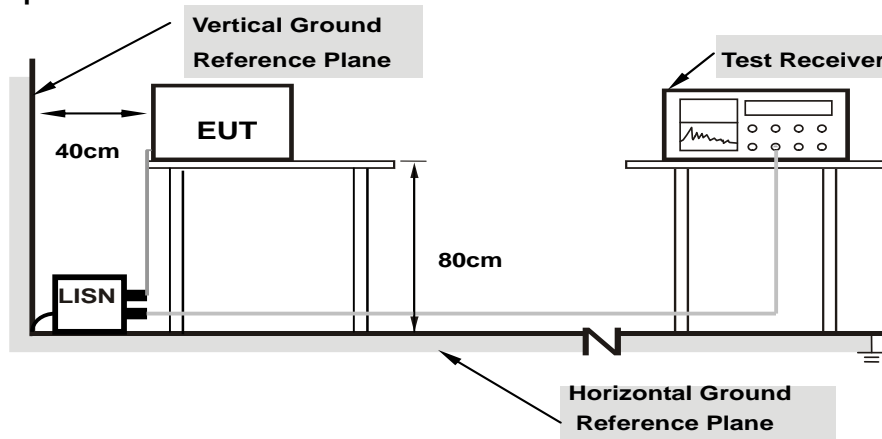

Note: 1.Support units were connected to second LISN.

For the actual test configuration, please refer to the attached file (Test Setup Photo).

4.2.6 EUT Operating Conditions

Same as 4.1.6.

4.2.7 Test Results

802.11a

Phase	Line (L)	Detector Function	Quasi-Peak (QP) / Average (AV)
Channel	Channel 36		

No	Freq. [MHz]	Corr. Factor (dB)	Reading Value [dB (uV)]		Emission Level [dB (uV)]		Limit [dB (uV)]		Margin (dB)	
			Q.P.	AV.	Q.P.	AV.	Q.P.	AV.	Q.P.	AV.
			1	0.15782	0.09	46.13	19.91	46.22	20.00	65.58
2	0.16955	0.09	42.59	13.36	42.68	13.45	64.98	54.98	-22.30	-41.53
3	0.23993	0.11	33.48	5.90	33.59	6.01	62.10	52.10	-28.51	-46.09
4	0.29076	0.12	24.90	1.41	25.02	1.53	60.50	50.50	-35.48	-48.97
5	0.49408	0.14	14.20	-2.32	14.34	-2.18	56.10	46.10	-41.75	-48.27
6	8.72854	0.53	-0.71	-5.36	-0.18	-4.83	60.00	50.00	-60.18	-54.83

Remarks:

1. Q.P. and AV. are abbreviations of quasi-peak and average individually.
2. The emission levels of other frequencies were very low against the limit.
3. Margin value = Emission level - Limit value
4. Correction factor = Insertion loss + Cable loss
5. Emission Level = Correction Factor + Reading Value.

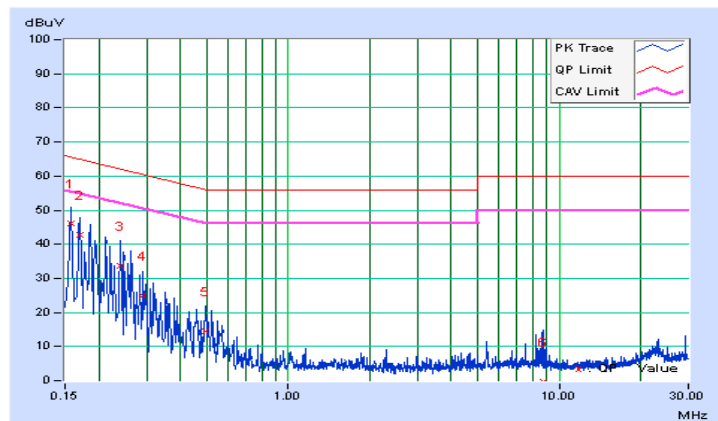

Phase	Neutral (N)	Detector Function	Quasi-Peak (QP) / Average (AV)
Channel	Channel 36		

No	Freq. [MHz]	Corr. Factor (dB)	Reading Value [dB (uV)]		Emission Level [dB (uV)]		Limit [dB (uV)]		Margin (dB)	
			Q.P.	AV.	Q.P.	AV.	Q.P.	AV.	Q.P.	AV.
	1	0.15000	0.08	46.24	24.58	46.32	24.66	66.00	56.00	-19.68
2	0.18508	0.09	35.02	8.22	35.11	8.31	64.25	54.25	-29.15	-45.95
3	0.25557	0.10	28.69	4.31	28.79	4.41	61.57	51.57	-32.78	-47.16
4	0.39635	0.14	11.44	-2.44	11.58	-2.30	57.93	47.93	-46.35	-50.23
5	8.66207	0.50	-0.91	-5.60	-0.41	-5.10	60.00	50.00	-60.41	-55.10
6	29.14656	1.13	12.83	5.28	13.96	6.41	60.00	50.00	-46.04	-43.59

Remarks:

1. Q.P. and AV. are abbreviations of quasi-peak and average individually.
2. The emission levels of other frequencies were very low against the limit.
3. Margin value = Emission level - Limit value
4. Correction factor = Insertion loss + Cable loss
5. Emission Level = Correction Factor + Reading Value.

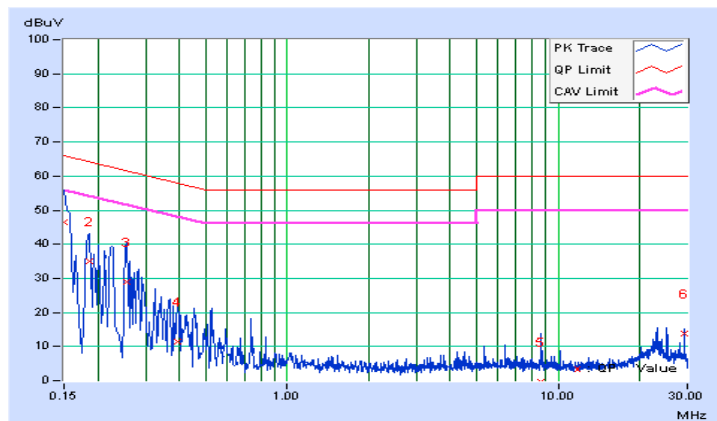

4.3 Transmit Power Measurement

4.3.1 Limits of Transmit Power Measurement

Operation Band	EUT Category		LIMIT
U-NII-1		Outdoor Access Point	1 Watt (30 dBm) (Max. e.i.r.p \leq 125mW(21 dBm) at any elevation angle above 30 degrees as measured from the horizon)
		Fixed point-to-point Access Point	1 Watt (30 dBm)
		Indoor Access Point	1 Watt (30 dBm)
	√	Mobile and Portable client device	250mW (24 dBm)
U-NII-2A		√	250mW (24 dBm) or 11 dBm+10 log B*
U-NII-2C		√	250mW (24 dBm) or 11 dBm+10 log B*
U-NII-3		√	1 Watt (30 dBm)

*B is the 26 dB emission bandwidth in megahertz

4.3.2 Test Setup

For Power Output Measurement

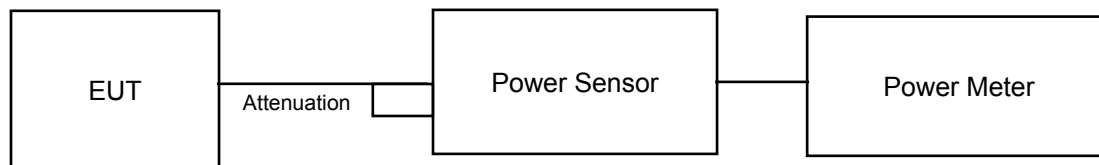

For 26dB and Occupied Bandwidth

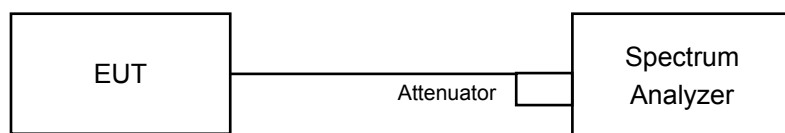

4.3.3 Test Instruments

Refer to section 4.1.2 to get information of above instrument.

4.3.4 Test Procedure

For Average Power Measurement

For 802.11a, 802.11n (HT20), 802.11n (HT40)

Method PM is used to perform output power measurement, trigger and gating function of wide band power meter is enabled to measure max output power of TX on burst. Duty factor is not added to measured value.

For 802.11ac (VHT80)

- a. Set span to encompass the entire 26 dB EBW (or, alternatively, the entire 99% occupied bandwidth) of the signal.
- b. Set sweep trigger to "free run".
- c. Set RBW = 1 MHz.
- d. Set VBW \geq 3 MHz
- e. Number of points in sweep \geq 2 Span / RBW.
- f. Sweep time \leq (number of points in sweep) * T
- g. Using emission bandwidth to determine the frequency span for integration the channel bandwidth.
- h. Detector = RMS.
- i. Trace mode = max hold.
- j. Allow max hold to run for at least 60 seconds, or longer as needed to allow the trace to stabilize.

4.3.5 Deviation from Test Standard

No deviation.

4.3.6 EUT Operating Conditions

The software provided by client to enable the EUT under transmission condition continuously at lowest, middle and highest channel frequencies individually.

4.3.7 Test Result

Power Output:

802.11a

Chan.	Freq. (MHz)	Maximum Conducted Power (mW)	Maximum Conducted Power (dBm)	Power Limit (dBm)	Pass / Fail
36	5180	22.439	13.51	24	Pass
40	5200	21.330	13.29	24	Pass
48	5240	20.989	13.22	24	Pass
52	5260	19.634	12.93	24	Pass
60	5300	19.364	12.87	24	Pass
64	5320	19.999	13.01	24	Pass
100	5500	17.219	12.36	24	Pass
116	5580	17.620	12.46	24	Pass
140	5700	19.679	12.94	24	Pass
149	5745	19.364	12.87	30	Pass
157	5785	20.045	13.02	30	Pass
165	5825	20.941	13.21	30	Pass

Note:

For U-NII-2A, U-NII-2C Band:

1. $11\text{dBm} + 10\log(20.13) = 24.04 > 24\text{dBm}$
2. $11\text{dBm} + 10\log(20.00) = 24.01 > 24\text{dBm}$
3. $11\text{dBm} + 10\log(20.00) = 24.01 > 24\text{dBm}$
4. $11\text{dBm} + 10\log(20.22) = 24.06 > 24\text{dBm}$
5. $11\text{dBm} + 10\log(20.09) = 24.03 > 24\text{dBm}$
6. $11\text{dBm} + 10\log(19.99) = 24.01 > 24\text{dBm}$

802.11n (HT20)

Chan.	Freq. (MHz)	Maximum Conducted Power (mW)	Maximum Conducted Power (dBm)	Power Limit (dBm)	Pass / Fail
36	5180	20.512	13.12	24	Pass
40	5200	21.135	13.25	24	Pass
48	5240	20.230	13.06	24	Pass
52	5260	20.749	13.17	24	Pass
60	5300	17.947	12.54	24	Pass
64	5320	18.535	12.68	24	Pass
100	5500	16.749	12.24	24	Pass
116	5580	17.219	12.36	24	Pass
140	5700	17.947	12.54	24	Pass
149	5745	20.606	13.14	30	Pass
157	5785	20.941	13.21	30	Pass
165	5825	20.845	13.19	30	Pass

Note:

For U-NII-2A, U-NII-2C Band:

1. $11\text{dBm} + 10\log(20.45) = 24.11 > 24\text{dBm}$
2. $11\text{dBm} + 10\log(20.33) = 24.08 > 24\text{dBm}$
3. $11\text{dBm} + 10\log(20.35) = 24.09 > 24\text{dBm}$
4. $11\text{dBm} + 10\log(20.21) = 24.06 > 24\text{dBm}$
5. $11\text{dBm} + 10\log(20.48) = 24.11 > 24\text{dBm}$
6. $11\text{dBm} + 10\log(20.49) = 24.12 > 24\text{dBm}$

802.11n (HT40)

Chan.	Freq. (MHz)	Maximum Conducted Power (mW)	Maximum Conducted Power (dBm)	Power Limit (dBm)	Pass / Fail
38	5190	16.069	12.06	24	Pass
46	5230	15.740	11.97	24	Pass
54	5270	16.558	12.19	24	Pass
62	5310	17.219	12.36	24	Pass
102	5510	16.711	12.23	24	Pass
110	5550	16.255	12.11	24	Pass
134	5670	16.444	12.16	24	Pass
151	5755	16.749	12.24	30	Pass
159	5795	17.298	12.38	30	Pass

Note:

For U-NII-2A, U-NII-2C Band:

1. $11\text{dBm} + 10\log(42.02) = 27.23 > 24\text{dBm}$
2. $11\text{dBm} + 10\log(41.80) = 27.21 > 24\text{dBm}$
3. $11\text{dBm} + 10\log(42.56) = 27.29 > 24\text{dBm}$
4. $11\text{dBm} + 10\log(41.94) = 27.23 > 24\text{dBm}$
5. $11\text{dBm} + 10\log(41.91) = 27.22 > 24\text{dBm}$

802.11ac (VHT80)

Chan.	Freq. (MHz)	Maximum Conducted Power (mW)	Maximum Conducted Power (dBm)	Power Limit (dBm)	Pass / Fail
42	5210	5.284	7.23	24	Pass
58	5290	5.585	7.47	24	Pass
106	5530	5.636	7.51	24	Pass
155	5775	5.534	7.43	30	Pass

Note:

For U-NII-2A, U-NII-2C Band:

1. $11\text{dBm} + 10\log(83.70) = 30.23 > 24\text{dBm}$
2. $11\text{dBm} + 10\log(83.61) = 30.22 > 24\text{dBm}$

26dB Bandwidth:
802.11a

Chan.	Freq. (MHz)	26dBc Bandwidth (MHz)	Pass / Fail
36	5180	20.13	Pass
40	5200	20.13	Pass
48	5240	20.02	Pass
52	5260	20.13	Pass
60	5300	20.00	Pass
64	5320	20.00	Pass
100	5500	20.22	Pass
116	5580	20.09	Pass
140	5700	19.99	Pass

802.11n (HT20)

Chan.	Freq. (MHz)	26dBc Bandwidth (MHz)	Pass / Fail
36	5180	20.32	Pass
40	5200	20.24	Pass
48	5240	20.20	Pass
52	5260	20.45	Pass
60	5300	20.33	Pass
64	5320	20.35	Pass
100	5500	20.21	Pass
116	5580	20.48	Pass
140	5700	20.49	Pass

802.11n (HT40)

Chan.	Freq. (MHz)	26dBc Bandwidth (MHz)	Pass / Fail
38	5190	49.84	Pass
46	5230	42.88	Pass
54	5270	42.02	Pass
62	5310	41.80	Pass
102	5510	42.56	Pass
110	5550	41.94	Pass
134	5670	41.91	Pass

802.11ac (VHT80)

Chan.	Freq. (MHz)	26dBc Bandwidth (MHz)	Pass / Fail
42	5210	84.17	Pass
58	5290	83.70	Pass
106	5530	83.61	Pass

Spectrum Plot of Worst Value

802.11a

802.11n (HT20)

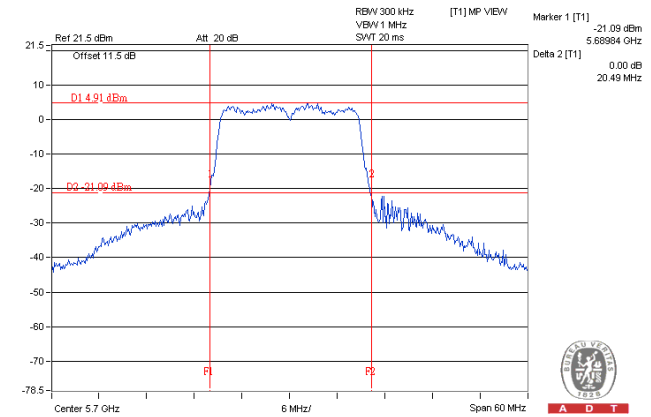
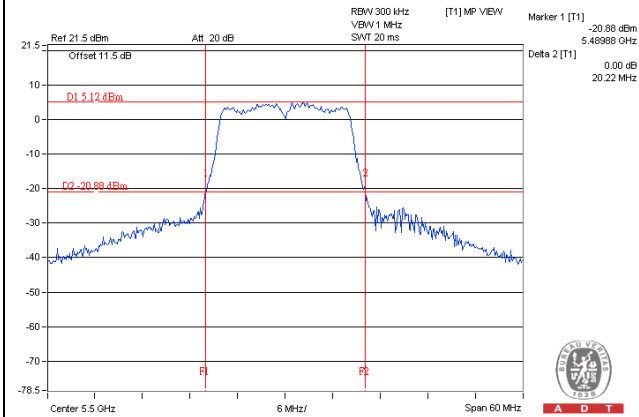

802.11n (HT40)

802.11ac (VHT80)

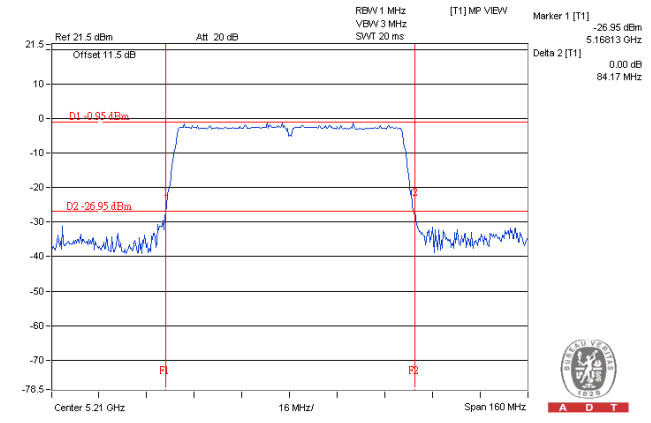
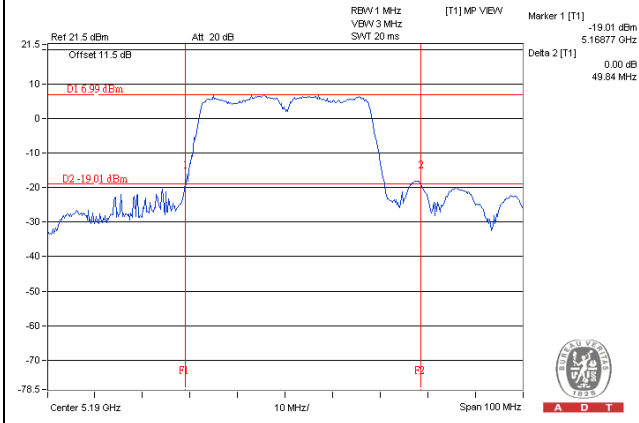

Occupied Bandwidth:

802.11a

Chan.	Freq. (MHz)	Occupied Bandwidth (MHz)
36	5180	16.68
40	5200	16.68
48	5240	16.80
52	5260	16.68
60	5300	16.68
64	5320	16.68
100	5500	16.80
116	5580	16.68
140	5700	16.68
149	5745	16.78
157	5785	16.80
165	5825	16.80

802.11n (HT20)

Chan.	Freq. (MHz)	Occupied Bandwidth (MHz)
36	5180	17.76
40	5200	17.64
48	5240	17.64
52	5260	17.64
60	5300	17.64
64	5320	17.64
100	5500	17.76
116	5580	17.64
140	5700	17.64
149	5745	17.64
157	5785	17.76
165	5825	17.76

802.11n (HT40)

Chan.	Freq. (MHz)	Occupied Bandwidth (MHz)
38	5190	36.36
46	5230	36.36
54	5270	36.48
62	5310	36.36
102	5510	36.48
110	5550	36.48
134	5670	36.36
151	5755	36.48
159	5795	36.48

802.11ac (VHT80)

Chan.	Freq. (MHz)	Occupied Bandwidth (MHz)
42	5210	76.32
58	5290	76.08
106	5530	76.35
155	5775	76.32

Spectrum Plot of Worst Value

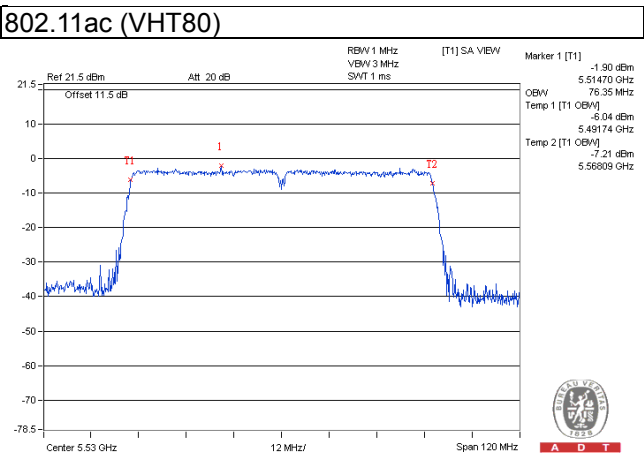
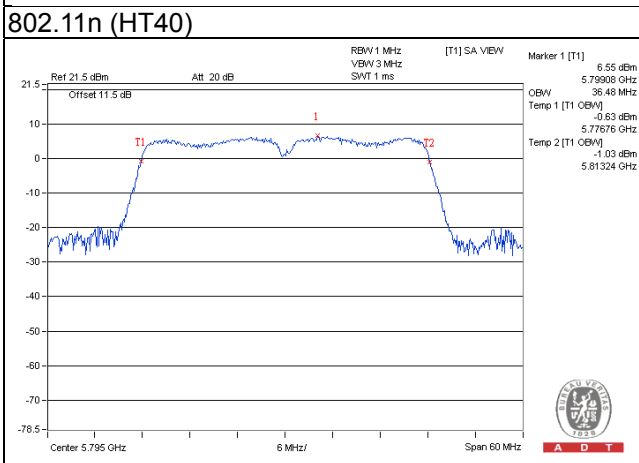
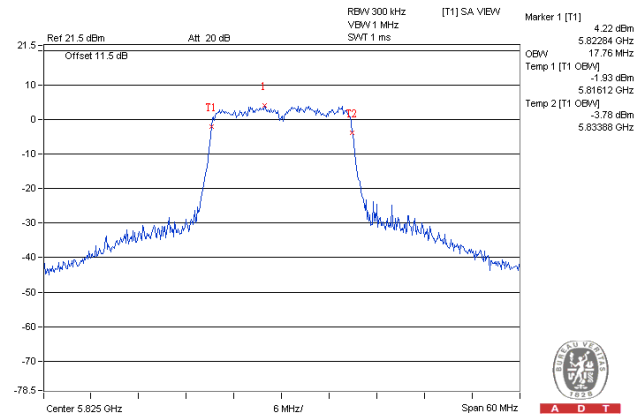
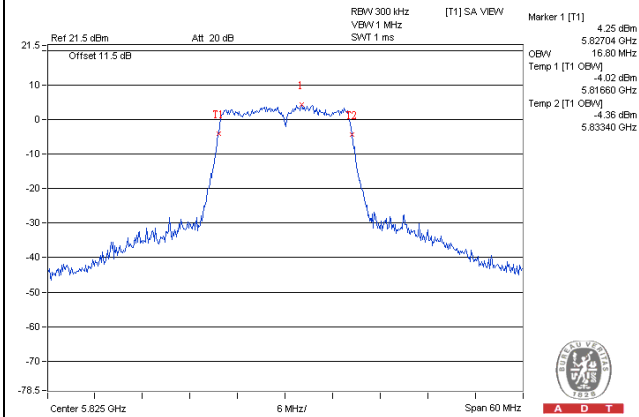

EUT MAXIMUM CONDUCTED POWER
802.11a

Frequency Band (MHz)	Max. Power	
	Output Power (mW)	Output Power (dBm)
5250~5350	19.999	13.01
5470~5725	19.679	12.94

Note: Manufacturer provides Transmit Power Control description to meet this requirement.

802.11n (HT20)

Frequency Band (MHz)	Max. Power	
	Output Power (mW)	Output Power (dBm)
5250~5350	20.749	13.17
5470~5725	17.947	12.54

Note: Manufacturer provides Transmit Power Control description to meet this requirement.

802.11n (HT40)

Frequency Band (MHz)	Max. Power	
	Output Power (mW)	Output Power (dBm)
5250~5350	17.219	12.36
5470~5725	16.711	12.23

Note: Manufacturer provides Transmit Power Control description to meet this requirement.

802.11ac (VHT80)

Frequency Band (MHz)	Max. Power	
	Output Power (mW)	Output Power (dBm)
5250~5350	5.585	7.47
5470~5725	5.636	7.51

Note: Manufacturer provides Transmit Power Control description to meet this requirement.

4.4 Peak Power Spectral Density Measurement

4.4.1 Limits of Peak Power Spectral Density Measurement

Operation Band	EUT Category		LIMIT
U-NII-1		Outdoor Access Point	17dBm/ MHz
		Fixed point-to-point Access Point	
		Indoor Access Point	
	√	Mobile and Portable client device	11dBm/ MHz
U-NII-2A		√	11dBm/ MHz
U-NII-2C		√	11dBm/ MHz
U-NII-3		√	30dBm/ 500kHz

4.4.2 Test Setup

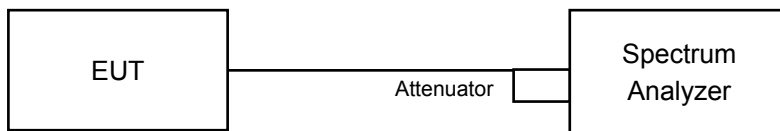

4.4.3 Test Instruments

Refer to section 4.1.2 to get information of above instrument.

4.4.4 Test Procedures

For U-NII-1, U-NII-2A, U-NII-2C band:

Using method SA-2

- Set span to encompass the entire emission bandwidth (EBW) of the signal.
- Set RBW = 1 MHz, Set VBW ≥ 3 MHz, Detector = RMS
- Sweep time = auto, trigger set to “free run”.
- Trace average at least 100 traces in power averaging mode.
- Record the max value and add 10 log (1/duty cycle)

For U-NII-3 band:

- Set span to encompass the entire emission bandwidth (EBW) of the signal.
- Set RBW = 300 kHz, Set VBW ≥ 1 MHz, Detector = RMS
- Use the peak marker function to determine the maximum power level in any 300 kHz band segment within the fundamental EBW.
- Scale the observed power level to an equivalent value in 500 kHz by adjusting (reducing) the measured power by a bandwidth correction factor (BWCF) where $BWCF = 10\log(500\text{ kHz}/300\text{ kHz})$
- Sweep time = auto, trigger set to “free run”.
- Trace average at least 100 traces in power averaging mode.
- Record the max value and add 10 log (1/duty cycle)

4.4.5 Deviation from Test Standard

No deviation.

4.4.6 EUT Operating Conditions

Same as Item 4.3.6.

4.4.7 Test Results

For U-NII-1, U-NII-2A, U-NII-2C Band

802.11a

Chan.	Freq. (MHz)	PSD w/o duty factor (dBm)	Duty factor	PSD with duty factor (dBm)	Max. Limit (dBm)	Pass / Fail
36	5180	0.75	0.22	0.97	11.00	Pass
40	5200	1.00	0.22	1.22	11.00	Pass
48	5240	0.78	0.22	1.00	11.00	Pass
52	5260	0.92	0.22	1.14	11.00	Pass
60	5300	0.60	0.22	0.82	11.00	Pass
64	5320	0.32	0.22	0.54	11.00	Pass
100	5500	0.29	0.22	0.51	11.00	Pass
116	5580	0.20	0.22	0.42	11.00	Pass
140	5700	0.27	0.22	0.49	11.00	Pass

802.11n (HT20)

Chan.	Freq. (MHz)	PSD w/o duty factor (dBm)	Duty factor	PSD with duty factor (dBm)	Max. Limit (dBm)	Pass / Fail
36	5180	0.70	0.22	0.92	11.00	Pass
40	5200	0.41	0.22	0.63	11.00	Pass
48	5240	0.23	0.22	0.45	11.00	Pass
52	5260	0.41	0.22	0.63	11.00	Pass
60	5300	0.18	0.22	0.40	11.00	Pass
64	5320	0.26	0.22	0.48	11.00	Pass
100	5500	0.08	0.22	0.30	11.00	Pass
116	5580	-0.31	0.22	-0.09	11.00	Pass
140	5700	-0.21	0.22	0.01	11.00	Pass

802.11n (HT40)

Chan.	Freq. (MHz)	PSD w/o duty factor (dBm)	Duty factor	PSD with duty factor (dBm)	Max. Limit (dBm)	Pass / Fail
38	5190	-3.79	0.46	-3.33	11.00	Pass
46	5230	-3.86	0.46	-3.40	11.00	Pass
54	5270	-3.90	0.46	-3.44	11.00	Pass
62	5310	-4.39	0.46	-3.93	11.00	Pass
102	5510	-4.32	0.46	-3.86	11.00	Pass
110	5550	-4.61	0.46	-4.15	11.00	Pass
134	5670	-4.29	0.46	-3.83	11.00	Pass

802.11ac (VHT80)

Chan.	Freq. (MHz)	PSD w/o duty factor (dBm)	Duty factor	PSD with duty factor (dBm)	Max. Limit (dBm)	Pass / Fail
42	5210	-13.00	0.73	-12.28	11.00	Pass
58	5290	-12.97	0.73	-12.24	11.00	Pass
106	5530	-13.52	0.73	-12.79	11.00	Pass

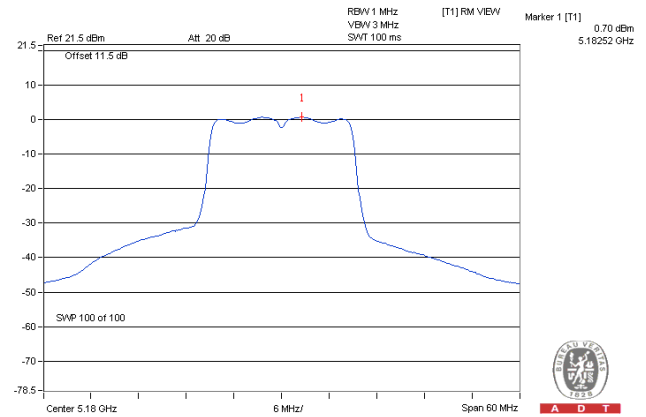
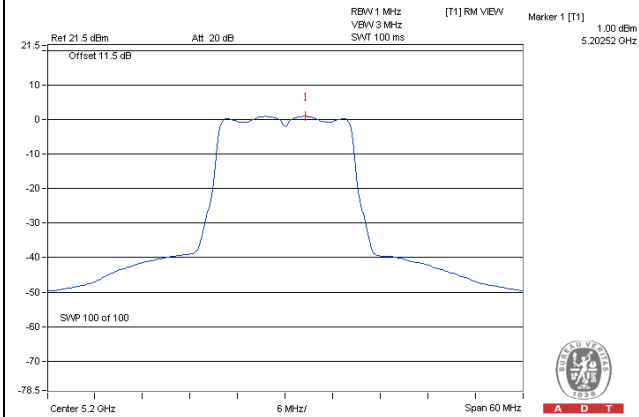
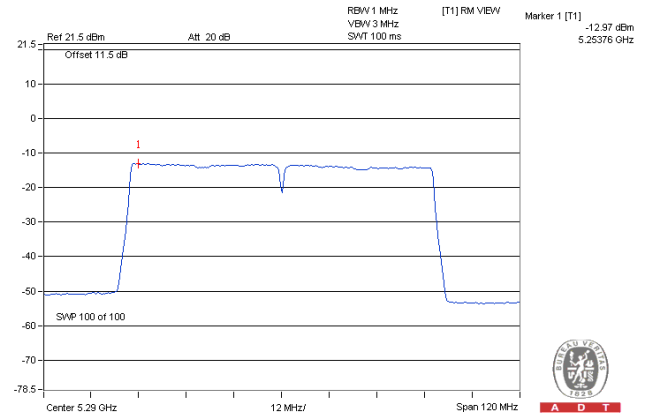
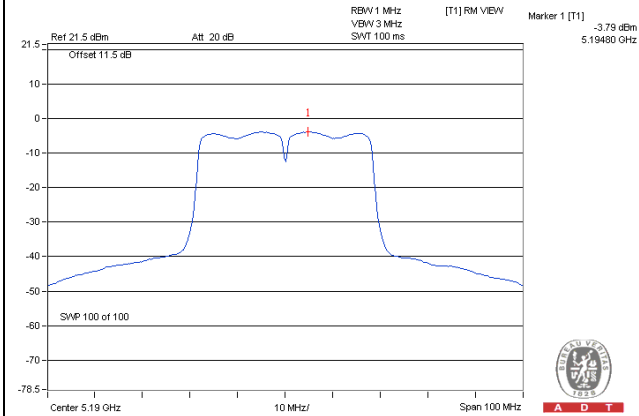
Spectrum Plot of Worst Value**802.11a****802.11n (HT20)****802.11n (HT40)****802.11ac (VHT80)**

For U-NII-3 Band
802.11a

Chan.	Freq. (MHz)	PSD (dBm/300k Hz)	PSD (dBm/500k Hz)	Duty factor	Total PSD (dBm/500k Hz)	Limit (dBm/500k Hz)	Pass / Fail
149	5745	-8.10	-5.88	0.22	-5.66	30.00	Pass
157	5785	-7.65	-5.43	0.22	-5.21	30.00	Pass
165	5825	-7.75	-5.53	0.22	-5.31	30.00	Pass

802.11n (HT20)

Chan.	Freq. (MHz)	PSD (dBm/300k Hz)	PSD (dBm/500k Hz)	Duty factor	Total PSD (dBm/500k Hz)	Limit (dBm/500k Hz)	Pass / Fail
149	5745	-8.08	-5.86	0.22	-5.64	30.00	Pass
157	5785	-8.11	-5.89	0.22	-5.67	30.00	Pass
165	5825	-7.89	-5.67	0.22	-5.45	30.00	Pass

802.11n (HT40)

Chan.	Freq. (MHz)	PSD (dBm/300k Hz)	PSD (dBm/500k Hz)	Duty factor	Total PSD (dBm/500k Hz)	Limit (dBm/500k Hz)	Pass / Fail
151	5755	-12.82	-10.60	0.46	-10.14	30.00	Pass
159	5795	-12.27	-10.05	0.46	-9.59	30.00	Pass

802.11ac (VHT80)

Chan.	Freq. (MHz)	PSD (dBm/300k Hz)	PSD (dBm/500k Hz)	Duty factor	Total PSD (dBm/500k Hz)	Limit (dBm/500k Hz)	Pass / Fail
155	5775	-21.60	-19.38	0.73	-18.65	30.00	Pass

Spectrum Plot of Worst Value

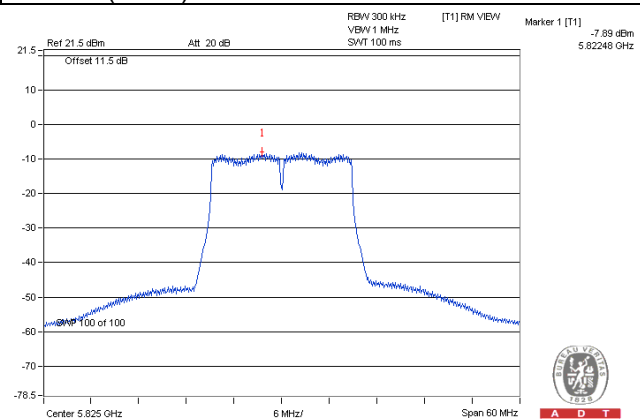
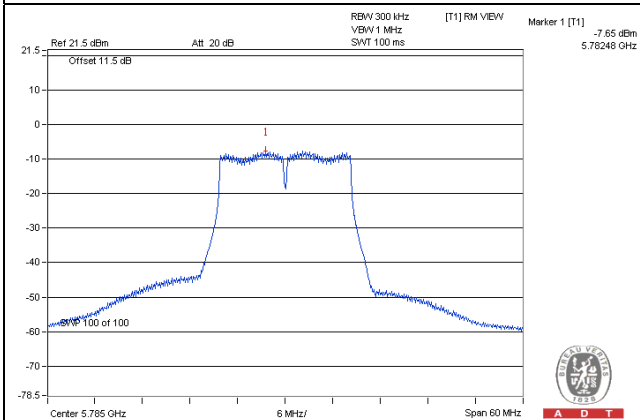
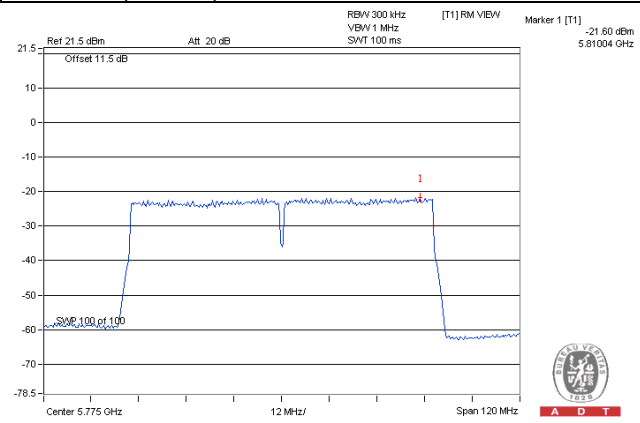
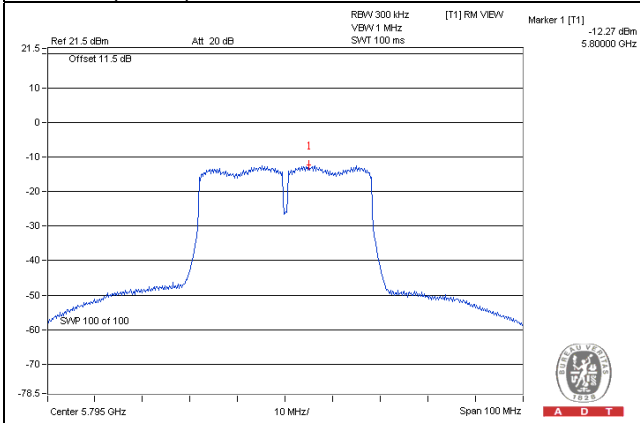
802.11a**802.11n (HT20)****802.11n (HT40)****802.11ac (VHT80)**

4.5 Frequency Stability

4.5.1 Limits of Frequency Stability Measurement

The frequency of the carrier signal shall be maintained within band of operation

4.5.2 Test Setup

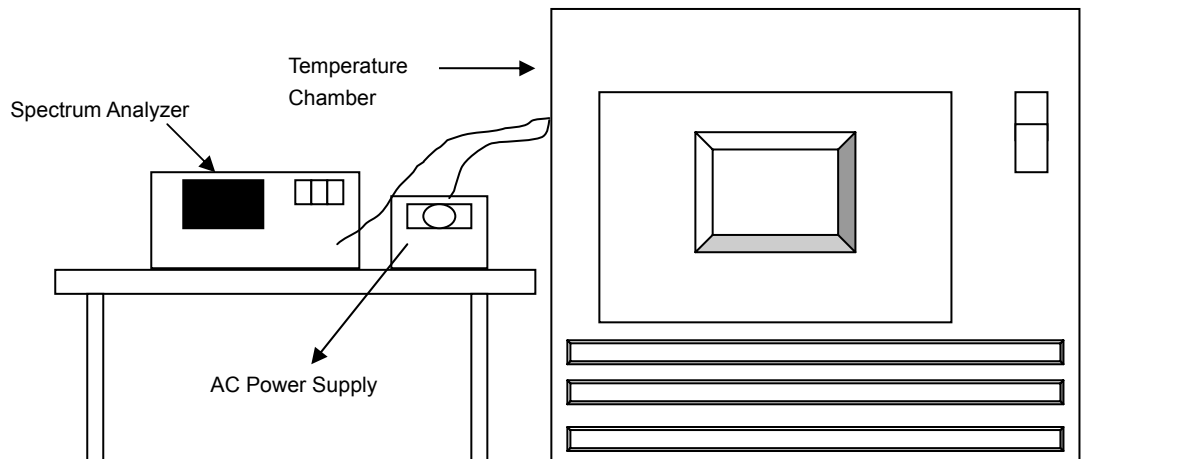

4.5.3 Test Instruments

Refer to section 4.1.2 to get information of above instrument.

4.5.4 Test Procedure

- The EUT was placed inside the environmental test chamber and powered by nominal AC voltage.
- Turn the EUT on and couple its output to a spectrum analyzer.
- Turn the EUT off and set the chamber to the highest temperature specified.
- Allow sufficient time (approximately 30 min) for the temperature of the chamber to stabilize, turn the EUT on and measure the operating frequency after 2, 5, and 10 minutes.
- Repeat step 2 and 3 with the temperature chamber set to the lowest temperature.
- The test chamber was allowed to stabilize at +20 degree C for a minimum of 30 minutes. The supply voltage was then adjusted on the EUT from 85% to 115% and the frequency record.

4.5.5 Deviation from Test Standard

No deviation.

4.5.6 EUT Operating Condition

Set the EUT transmit at un-modulation mode to test frequency stability.

4.5.7 Test Results

Frequency Stability Versus Temp.									
Operating Frequency: 5180MHz									
Temp. (°C)	Power Supply (Vac)	0 Minute		2 Minute		5 Minute		10 Minute	
		Measured Frequency (MHz)	Frequency Drift (%)	Measured Frequency (MHz)	Frequency Drift (%)	Measured Frequency (MHz)	Frequency Drift (%)	Measured Frequency (MHz)	Frequency Drift (%)
50	120	5180.0042	0.00008	5180.0016	0.00003	5180.0039	0.00008	5180.0026	0.00005
40	120	5180.0255	0.00049	5180.0239	0.00046	5180.0279	0.00054	5180.0245	0.00047
30	120	5180.0123	0.00024	5180.0119	0.00023	5180.0133	0.00026	5180.0163	0.00031
20	120	5180.0100	0.00019	5180.0055	0.00011	5180.0076	0.00015	5180.0085	0.00016
10	120	5180.0153	0.00030	5180.0173	0.00033	5180.0188	0.00036	5180.0178	0.00034
0	120	5179.9903	-0.00019	5179.9889	-0.00021	5179.9882	-0.00023	5179.9901	-0.00019
-10	120	5180.0236	0.00046	5180.0241	0.00047	5180.0239	0.00046	5180.0228	0.00044
-20	120	5179.9882	-0.00023	5179.9853	-0.00028	5179.9890	-0.00021	5179.9857	-0.00028
-30	120	5179.9945	-0.00011	5179.9953	-0.00009	5179.9949	-0.00010	5179.9953	-0.00009

Frequency Stability Versus Temp.									
Operating Frequency: 5180MHz									
Temp. (°C)	Power Supply (Vac)	0 Minute		2 Minute		5 Minute		10 Minute	
		Measured Frequency (MHz)	Frequency Drift (%)	Measured Frequency (MHz)	Frequency Drift (%)	Measured Frequency (MHz)	Frequency Drift (%)	Measured Frequency (MHz)	Frequency Drift (%)
20	138	5180.0104	0.00020	5180.0050	0.00010	5180.0073	0.00014	5180.0091	0.00018
	120	5180.0100	0.00019	5180.0055	0.00011	5180.0076	0.00015	5180.0085	0.00016
	102	5180.0096	0.00019	5180.0064	0.00012	5180.0074	0.00014	5180.0075	0.00014

4.6 6dB Bandwidth Measurement

4.6.1 Limits of 6dB Bandwidth Measurement

The minimum of 6dB Bandwidth Measurement is 0.5MHz.

4.6.2 Test Setup

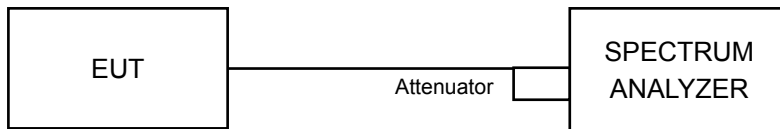

4.6.3 Test Instruments

Refer to section 4.1.2 to get information of above instrument.

4.6.4 Test Procedure

MEASUREMENT PROCEDURE REF

- Set resolution bandwidth (RBW) = 100kHz
- Set the video bandwidth (VBW) $\geq 3 \times$ RBW, Detector = Peak.
- Trace mode = max hold.
- Sweep = auto couple.
- Measure the maximum width of the emission that is constrained by the frequencies associated with the two amplitude points (upper and lower) that are attenuated by 6 dB relative to the maximum level measured in the fundamental emission

4.6.5 Deviation from Test Standard

No deviation.

4.6.6 EUT Operating Condition

The software provided by client to enable the EUT under transmission condition continuously at lowest, middle and highest channel frequencies individually.

4.6.7 Test Results

802.11a

Channel	Frequency (MHz)	6dB Bandwidth (MHz)	Minimum Limit (MHz)	Pass / Fail
149	5745	16.37	0.5	Pass
157	5785	16.39	0.5	Pass
165	5825	16.40	0.5	Pass

802.11n (HT20)

Channel	Frequency (MHz)	6dB Bandwidth (MHz)	Minimum Limit (MHz)	Pass / Fail
149	5745	17.34	0.5	Pass
157	5785	17.33	0.5	Pass
165	5825	17.57	0.5	Pass

802.11n (HT40)

Channel	Frequency (MHz)	6dB Bandwidth (MHz)	Minimum Limit (MHz)	Pass / Fail
151	5755	35.55	0.5	Pass
159	5795	35.56	0.5	Pass

802.11ac (VHT80)

Channel	Frequency (MHz)	6dB Bandwidth (MHz)	Minimum Limit (MHz)	Pass / Fail
155	5775	76.53	0.5	Pass

Spectrum Plot of Worst Value

802.11a

802.11n (HT20)

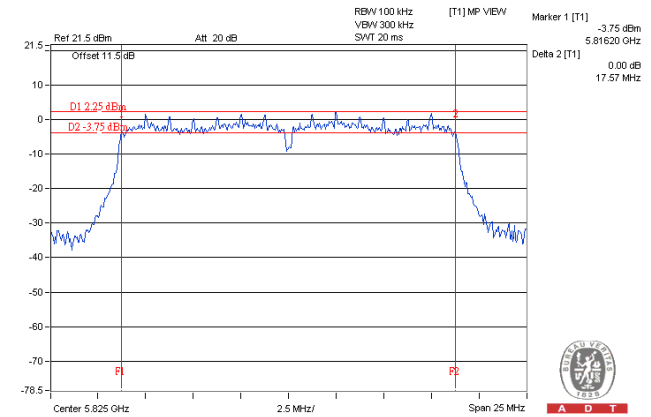
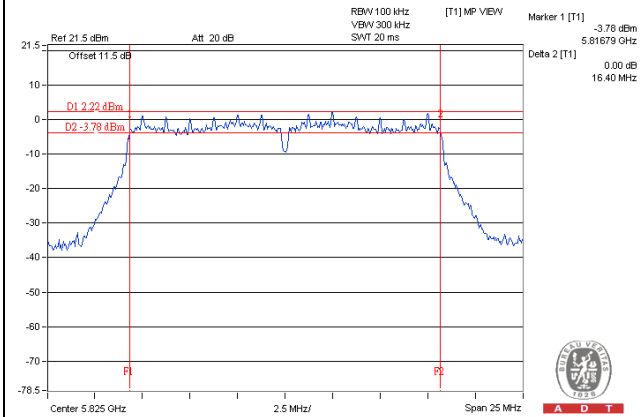

802.11n (HT40)

802.11ac (VHT80)

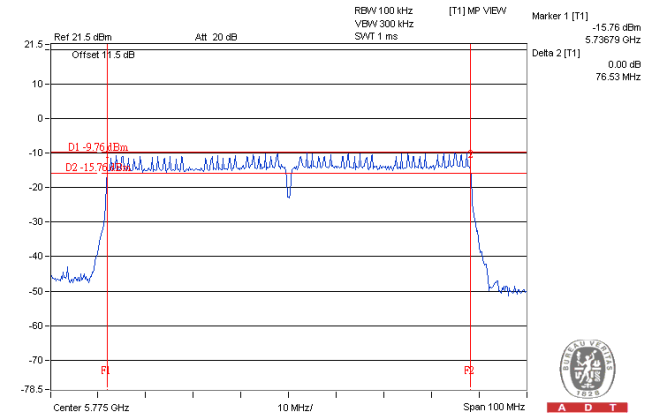
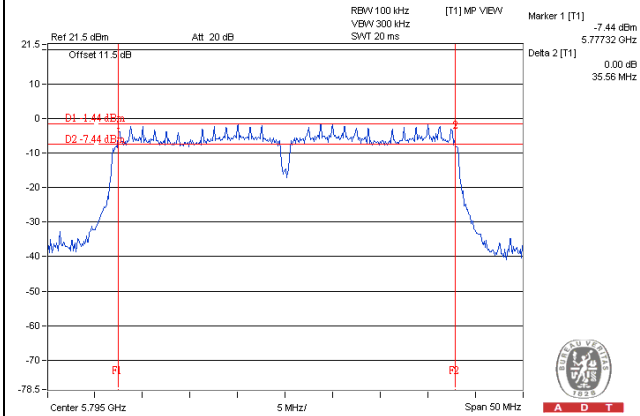

5 Pictures of Test Arrangements

Please refer to the attached file (Test Setup Photo).



Appendix – Information on the Testing Laboratories

We, Bureau Veritas Consumer Products Services (H.K.) Ltd., Taoyuan Branch, were founded in 1988 to provide our best service in EMC, Radio, Telecom and Safety consultation. Our laboratories are accredited and approved according to ISO/IEC 17025.

If you have any comments, please feel free to contact us at the following:

Linko EMC/RF Lab

Tel: 886-2-26052180

Fax: 886-2-26051924

Hsin Chu EMC/RF/Telecom Lab

Tel: 886-3-5935343

Fax: 886-3-5935342

Hwa Ya EMC/RF/Safety Lab

Tel: 886-3-3183232

Fax: 886-3-3270892

Email: service.adt@tw.bureauveritas.com

Web Site: www.bureauveritas-adt.com

The address and road map of all our labs can be found in our web site also.

--- END ---