

TEST REPORT  
No.: 6-0668-15-3-13d

According to:  
**FCC Regulations**  
Part 15.407







**IC-Regulations**  
RSS-Gen, Issue 4  
RSS-247, Issue 1

for

ACTIA Nordic AB

Telematic unit for automotive use  
ACUII-06

**FCC-ID:** 2AGKKACUII-06  
**IC:** 20839-ACUII06  
**PMN:** ACUII-06  
**HVIN:** ACUII-06

Laboratory Accreditation and Listings			
 <p><b>DAkKS</b> Deutsche Akkreditierungsstelle D-PL-12047-01-01</p>	 <p>FEDERAL COMMUNICATIONS COMMISSION <b>FC</b> USA • NOISE MRA US-EU 0003</p>	 <p>Industry Canada Reg. No.: 3462D-1 Reg. No.: 3462D-2 Reg. No.: 3462D-3</p>	 <p>Voluntary Controls for Electromagnetic Emissions Reg. No.: R-2666 C-2914, T-1967, G-301</p>
 <p><b>WiFi</b> ALLIANCE AUTHORIZED RF LABORATORY</p>	 <p><b>ctia</b> Authorized<sup>TM</sup> Test Lab Lab Code: 20011130-00</p>		
accredited according to DIN EN ISO/IEC 17025			
<p><b>CETECOM GmbH</b> Laboratory Radio Communications &amp; Electromagnetic Compatibility Im Teelbruch 116 • 45219 Essen • Germany Registered in Essen, Germany, Reg. No.: HRB Essen 8984 Tel.: + 49 (0) 20 54 / 95 19-954 • Fax: + 49 (0) 20 54 / 95 19-964 E-mail: info@cetecom.com • Internet: www.cetecom.com</p>			

## Table of contents

<b>1. SUMMARY OF TEST RESULTS</b> .....	<b>3</b>
1.1. Tests measurement overview according of US CFR Title 47, Subpart 15C and Canada RSS-Standards: .....	3
1.2. Attestation:.....	4
<b>2. ADMINISTRATIVE DATA</b> .....	<b>5</b>
2.1. Identification of the testing laboratory .....	5
2.2. Test location .....	5
2.3. Organizational items .....	5
2.4. Applicant’s details .....	5
2.5. Manufacturer’s details .....	5
<b>3. EQUIPMENT UNDER TEST (EUT)</b> .....	<b>6</b>
3.1. IEEE 802.11 OVERVIEW: MODULATION AND DATA RATES .....	7
3.2. EUT: Type, S/N etc. and short descriptions used in this test report .....	7
3.3. Auxiliary Equipment (AE): Type, S/N etc. and short descriptions .....	8
3.4. EUT set-ups .....	10
3.5. EUT operating modes .....	10
3.6. Configuration of cables used for testing .....	11
<b>4. DESCRIPTION OF TEST SYSTEM SET-UP’S</b> .....	<b>12</b>
4.1. Test system set-up for conducted measurements on antenna port .....	12
4.2. Test system set-up for radiated magnetic field measurements below 30 MHz .....	13
4.3. Test system set-up for radiated electric field measurement 30 MHz to 1 GHz .....	14
4.4. Test system set-up for radiated electric field measurement above 1 GHz .....	15
<b>5. MEASUREMENTS</b> .....	<b>16</b>
5.1. RF-Parameter - Transmitter Peak output power (conducted and radiated).....	16
5.2. General Limit - Radiated field strength emissions below 30 MHz.....	18
5.3. General Limit - Radiated field strength emissions, 30 MHz - 1 GHz.....	20
5.4. General Limit - Radiated emissions, above 1 GHz.....	22
5.5. <b>General Limit - Band-edge compliance measurements</b> .....	24
5.6. Measurement uncertainties .....	26
<b>6. ABBREVIATIONS USED IN THIS REPORT</b> .....	<b>26</b>
<b>7. ACCREDITATION DETAILS OF CETECOM’S LABORATORIES AND TEST SITES</b> .....	<b>27</b>
<b>8. INSTRUMENTS AND ANCILLARY</b> .....	<b>28</b>
8.1. Test software and firmware of equipment .....	28
8.2. Single instruments and test systems.....	29
<b>9. VERSIONS OF TEST REPORTS (CHANGE HISTORY)</b> .....	<b>31</b>

## Table of annex

### Total pages

Annex 1: Measurement diagrams - separate document TR6-0668-15-3-13d –Annex1	50
Annex 2: External EUT photographs - separate document TR6-0668-15-3-13-Annex2	12
Annex 3: Internal EUT photographs - separate document TR6-0668-15-3-13-Annex3	6
Annex 4: Test set-up photographs - separate document TR6-0668-15-3-13-Annex4	7

The listed attachments are an integral part of this report.

## 1. Summary of test results

The test results apply exclusively to the test samples as presented in this Report. The CETECOM GmbH does not assume responsibility for any conclusions and generalizations taken in conjunction with other specimens or samples of the type of the item presented to tests.

**The test results apply exclusively to the test samples as presented in this Report. The CETECOM GmbH does not assume responsibility for any conclusions and generalizations taken in conjunction with other specimens or samples of the type of the item presented to tests. Also we refer on special conditions which the applicant should fulfill according §2.927 to §2.948, special focus regarding modification of the equipment and availability of sample equipment for market surveillance tests.**

The presented Equipment Under Test (in this report, hereinafter referred as EUT) supports radiofrequency technologies with WLAN technology and operating frequency range at 5150 to 5850 GHz according to IEEE 802.11 a/ac. Other implemented wireless technologies were not considered within this test report.

**The build-in W-LAN module is already approved with FCC-ID VPYLB1ES and IC 772C-LB1ES.**

Following test cases have been performed to show compliance with valid Part 15.209/15.407 of the FCC CFR Title 47 Rules, Edition 4<sup>th</sup> November 2016 and IC RSS-247 Issue 1/RSS-Gen Issue 4 standards.

### 1.1. Tests measurement overview according of US CFR Title 47, Subpart 15C and Canada RSS-Standards:

Test cases	Port	References and Limits			EUT set-up	EUT op. mode	Result
		FCC Standard	RSS-Standard	Test limit			
TX-Mode							
99% occupied bandwidth	Antenna terminal (conducted)	2.1049(h)	RSS-Gen, Issue 4	99% Power bandwidth	--	--	No tested within this test report, remark 1
Duty-Cycle	Antenna terminal (conducted)	--	--	No pass/fail criteria To be reported accord. KDB789033 or ANSI C63.10:2013	--	--	No tested within this test report, remark 1
Maximum output power	Antenna terminal (conducted)	§15.407(a) (1)(2)(3)	RSS-247, Issue 1 chapter 6.2.1(1) 6.2.2(1) 6.2.3(1) 6.2.4(1)	(1) lesser of 200mW or 10dBm+10logB (2): lesser of 250mW or 11dBm+10logB (3): lesser of 250mW or 11dBm+10logB	3	1+2	pass
Peak Power Spectral density	Antenna terminal (conducted)	§15.407(a) (1)(2)(3)	RSS-247, Issue 1 chapter 6.2.1(1) 6.2.2(1) 6.2.3(1) 6.2.4(1)	(1): 10dBm/MHz (2): 11dBm/MHz (3): 11dBm/MHz	--	--	No tested within this test report, remark 1
Antenna gain information	Antenna terminal (conducted)	§15.407(a) (1)(2)(3)	RSS-247, Issue 1 chapter 6.2.1(1) 6.2.2(1) 6.2.3(1) 6.2.4(1)	< 6dBi or reduction of power/power density	--	--	Applicant declaration

General field strength emissions within restricted bands	Enclosure + Inter-connecting cables (radiated)	§15.407(6) §15.407(b) §15.205 §15.209	RSS-247, Issue 1 chapter 6.2.1(2) 6.2.2(2) 6.2.3(2) 6.2.4(2)	FCC/IC: Emissions in restricted bands must meet the general field-strength radiated limits IC: Chapter 8.9 Table 4+5+6	1+2	1+2	passed
Band-Edge compliance radiated	Enclosure + Inter-connecting cables (radiated)	§15.205 §15.209	RSS-Gen., Issue 4	Emissions in restricted bands must meet the general field-strength radiated limits chapter 8.9 Table 6	1+2	1+2	passed
		§15.407(b)		Out-of-band emission EIRP < -27dBm/MHz or -17dBm/MHz If applicable (EIRP>200mW): Elevation Mask of radiation pattern	1+2	1+2	Passed
Dynamic frequency selection (DFS)	Antenna terminal (conducted)	§15.407	RSS-247, Issue 1 chapter 6.3	IC: A9.3 (a) General (b) Operational requirements --	--	--	See separate test report
AC-Power Lines Conducted Emissions	AC-Power lines	§15.207	RSS-Gen, Issue 4: Chapter 8.8, Table 3	FCC §15.107 class B limits §15.207 limits IC: Table 3	--	--	Not applicable – DC powered equipment

Remark 1: see test reports RF150713C14-1 and IC150713C14-1

RF-Exposure Evaluation (separation distance user to RF-radiating element greater 20cm)							
Test cases	Port	References & Limits			EUT set-up	EUT operating mode	Result
		FCC Standard	RSS Section	Test Limit			
Radio frequency radiation exposure requirements	Cabinet + Inter-connecting cables (radiated)	§1.1310(b) §2.1091 §2.1093	RSS-102 Issue 5	RF-Field Strength Limits: FCC: "general population/uncontrolled" environment Table 1 IC: Table 4	1+2	1+2	See separate test report/evaluation

Remark: --

**1.2. Attestation:**

I declare that all measurements were performed by me or under my supervision and that all measurements have been performed and are correct to my best knowledge and belief to Industry Canada standards. All requirements as shown in above table are met in accordance with enumerated standards.

.....  
Dipl.-Ing. Rachid Acharkaoui  
Responsible for test section



.....  
Dipl.-Ing. Christian Lorenz  
Responsible for test report

## 2. Administrative Data

### 2.1. Identification of the testing laboratory

Company name:	CETECOM GmbH
Address:	Im Teelbruch 116 45219 Essen - Kettwig Germany
Responsible for testing laboratory:	Dipl.-Ing. Rachid Acharkaoui
Deputy:	Dipl.-Ing. Niels Jeß

### 2.2. Test location

#### 2.2.1. Test laboratory "CTC"

Company name:	see chapter 2.1. Identification of the testing laboratory
---------------	---

### 2.3. Organizational items

Responsible for test report and project leader:	Dipl.-Ing. C. Lorenz
Receipt of EUT:	2015-10-13
Date(s) of test:	2015-12-28 to 2016-02-26
Date of report:	2015-04-20
-----	
Version of template:	13.02

### 2.4. Applicant's details

Applicant's name:	ACTIA Nordic AB
Address:	Hammarbacken 4a 19149 Linköping  Sweden
Contact person:	Mr. Nicklas Andersson

### 2.5. Manufacturer's details

Manufacturer's name:	ACTIA Automotive
Address:	10 Avenue Edouard Serres Parc Aeronautique BP 60112 31772 Colomiers France

### 3. Equipment under test (EUT)

#### 3.1. Technical 5GHz W-LAN data of main EUT declared by applicant

Frequency range and channels	U-NII 1 (5150-5250MHz)	<input checked="" type="checkbox"/> Ch. 36 to Ch. 48 (Nominal 20MHz signal bandwidth)	
		<input checked="" type="checkbox"/> Ch. 38 to Ch. 46 (Nominal 40MHz signal bandwidth)	
	U-NII2A (5250-5350MHz)	<input checked="" type="checkbox"/> Ch. 52 to Ch. 64 (Nominal 20MHz signal bandwidth)	
		<input checked="" type="checkbox"/> Ch. 54 to Ch. 62 (Nominal 40MHz signal bandwidth)	
	U-NII 2C (5470-5725MHz)	<input checked="" type="checkbox"/> Ch. 100 to 140 (Nominal 20MHz signal bandwidth)	
		<input checked="" type="checkbox"/> Ch. 102 to 134 (Nominal 40MHz signal bandwidth)	
	U-NII-3	<input checked="" type="checkbox"/> Ch. 149 to 165 (Nominal 20MHz signal bandwidth)	
		<input checked="" type="checkbox"/> Ch. 151 to 159 (Nominal 40MHz signal bandwidth)	
Type of modulation (packet types)	<input checked="" type="checkbox"/> BPSK <input checked="" type="checkbox"/> QPSK <input checked="" type="checkbox"/> 16-QAM <input checked="" type="checkbox"/> 64-QAM <input checked="" type="checkbox"/> 256-QAM		
Number of channels (USA/Canada -bands)	<input checked="" type="checkbox"/> 20MHz bandwidth: 36/40/44/48/52/56/60/64/100/104/108/112/116/132/136/138/140/149/153/157/161/165 <input checked="" type="checkbox"/> 40MHz bandwidth: 38/46/54/62/102/110/118/134/151/159		
Antenna Type	<input type="checkbox"/> Integrated <input type="checkbox"/> External, no RF- connector <input checked="" type="checkbox"/> External, separate RF-connector		
Antenna Gain	<u>From data sheet WiFi internal antenna variant 7:</u> 5150 to 5250 MHz: 8.25 dBi 5250 to 5350 MHz: 7.5 dBi 5470 to 5700 MHz: 7.2 dBi 5725 to 5850 MHz: 7.0 dBi		
Installed options	<input checked="" type="checkbox"/> Cellular telephone: GSM/(E)-GPRS/W-CDMA/LTE (not tested within this test report) <input checked="" type="checkbox"/> GPS (not tested within this test report)		
Power supply	<input type="checkbox"/> Internal battery Li-Io, range 3.2V to 4.2 V (nominal 3.7 V) <input type="checkbox"/> over AC/DC adapter: 120V/60 Hz <input checked="" type="checkbox"/> DC power only: 13.8V DC		
Special EMI components	--		
EUT sample type	<input type="checkbox"/> Production	<input checked="" type="checkbox"/> Pre-Production	<input type="checkbox"/> Engineering
Firmware	<input type="checkbox"/> for normal use		<input checked="" type="checkbox"/> Special version for test execution
FCC label attached	<input type="checkbox"/> yes	<input checked="" type="checkbox"/> no	

Pls. see applicants document ACUII-06 Technical description, Rev. 1.2, dated 2015-12-22 for further details

### 3.2. IEEE 802.11 OVERVIEW: MODULATION AND DATA RATES

The modulations and data rates defined for 802.11 b/g/n transmitters are identified in the table below. Also it shows which operational mode is possible for the device under test (EUT) according applicant's information.

802.11b-Mode (DSSS System)		
Data rate [Mbps]	Modulation type	Supported by EUT
1	DBPSK (Differential binary phase shift keying)	YES
2	DQPSK (Differential quadrature phase shift keying)	YES
5.5 / 11	CCK/PBCC (8-chip complementary code keying)	YES
22	ERP-PBCC (Packet binary convolutional coding)	YES

802.11g-Mode (OFDM system)		
Brutto data rate [Mbps]	Modulation type of subcarriers	Supported by EUT
6 / 9	BPSK	YES
12 / 18	QPSK	YES
24 / 36	16-QAM	YES
48 / 54	64-QAM	YES

Remark: 52 sub-carriers which can be modulated at different data-rates.

802.11n-Mode (OFDM)		
Brutto data rate [Mbps]	Modulation type	Supported by EUT
7.2/14.4/21.7/28.9/43.3/57.8/65/72.2 Mbps	HT20 (MCS0..MCS7)	Yes
14.444/28.889/43.333/57.778/86.667/115.556/130/144.444 Mbps	HT20 (MCS8..MCS15)	No
15/30/45/60/90/120/135/150 Mbps	HT40 (MCS0..MCS7)	Yes
30/60 Mbps	HT40 (MCS8..MCS9)	Yes
90/120/180/240/270/300 Mbps	HT40 (MCS10..MCS15)	No

### 3.3. EUT: Type, S/N etc. and short descriptions used in this test report

Short description*)	EUT	Type	S/N serial number	HW hardware status	SW software status
EUT A	Telematic unit for automotive use VCM High LTE US	ACUII-06	21790250902642	C	13
EUT B	Telematic unit for automotive use VCM High LTE US	ACUII-06	21790250902643	C	13
EUT C	Multiband Antenna 434-WLAN-GNSS- SDARS-LTE	VCC-Number: 31438105	SDARS Modified #1	15W421 (Portugal AD801)	--

\*) EUT short description is used to simplify the identification of the EUT in this test report

### 3.4. Auxiliary Equipment (AE): Type, S/N etc. and short descriptions

AE short description *)	Auxiliary Equipment	Type	S/N serial number	HW hardware status	SW software status
AE 1	Main harness	1007-141-06	--	Rev A1.1 1535 Long branch : 2.03 m length Short branch: 0.68m length	--
AE 2	external SIM card holder	31324668	435614470037	826 14W47 1535	--
AE 3	Alps SOS/ 2 button device	Type: 19206 30710477	06W35T	One button <i>SOS</i> One button <i>ON CALL</i>	--
AE 4	DLC Ethernet cable + Power Supply White Wire	Maxxtro Patch cable FTP CAT. 5E 26AWG Huber + Suhner Radox 125	1007-142-01	Rev.B1.0 (Length:1.97 m) 0.34 MM2 (Length: 1.85 m)	--
AE 5	Mikrophone /Louspeaker unit	Integrated in Volvo C99ZA	39841393AA	--	--
AE 6	Antenna power supply cable (Twisted red cable 3-pin MQS)	Huber + Suhner Radox 125	--	0.50 MM2 (Length:2.1 m)	--



AE 7	WLAN antenna cable (Orange Fakra connectors)	Huber + Suhner Enviroflex 400	--	E111025 AWM 522787 (Length: 2m)	--
AE 8	GNSS antenna cable (Blue Fakra connectors)	Huber + Suhner Enviroflex 400	--	E111025 AWM 522787 (Length: 2m)	--
AE 9	2G/3G/4G antenna cable (Violet/Bordeaux Fakra connectors)	Huber + Suhner Enviroflex 400	--	E111025 AWM 522787 (Length: 2m)	--
AE 10	3G/4G Diversity antenna cable (Pink Fakra connectors)	Huber + Suhner Enviroflex 400	--	E111025 AWM 522787 (Length: 2m)	--
AE 11	IHU Ethernet Termination (Navy Blue Fakra connectors)	--	--	(Length :0.096 m)	--
AE 12	Notebook	Dell Latitude E5440	CTC432012	--	Windows 7 + ACTIA PC_Application -V1.1.0.17
AE 13	Flexray/CAN terminations	3 pieces	--	--	--
AE 14	Speaker Termination	1 piece	--	--	--
AE 15	USB cable Termination	resistive	--	--	--
AE 16	UART cable Termination	3 Wired resistive	--	--	--
AE 17	Apple USB-Ethernet adapter	A1277	--	(Length:0.20 m)	--

\*) AE short description is used to simplify the identification of the auxiliary equipment in this test report.  
AE 5/AE17 not used for tests

### 3.5. EUT set-ups

EUT set-up no.*)	Combination of EUT and AE	Remarks
set. 1	EUT A + EUT C + AE 1 + AE 2 + AE 3 + AE 4 + AE6 + AE 7 + AE 8 + AE 9 + AE10 + AE11+ AE12+ AE 13 + AE14 + AE 15 + AE 16	Radiated measurements, Downward antenna (internal antenna). Pls. see applicants document <i>ACUII Test Setup for certification Testing, Rev.1.2</i> , dated 2015-12-22. Test software 1.1.0.13 used.
set. 2	EUT A + EUT C + AE 1 + AE 2 + AE 3 + AE 4 + AE6 + AE 7 + AE 8 + AE 9 + AE10 + AE11+ AE12+ AE 13 + AE14 + AE 15 + AE 16	Radiated measurements, Upward antenna (external antenna). Pls. see applicants document <i>ACUII Test Setup for certification Testing, Rev.1.2</i> , dated 2015-12-22. Test software 1.1.0.13 used.
set. 3	EUT A + AE 1 + AE 2 + AE 3 + AE 4 + AE11+ AE12+ AE13+AE14+AE15+AE16	Conducted RF measurements

\*) EUT set-up no. is used to simplify the identification of the EUT set-up in this test report.

### 3.6. EUT operating modes

EUT operating mode no.*)	Description of operating modes	Additional information
op. 1	WLAN Continuous TX-Mode a-Mode, HT20	The EUT was put to continuous transmissions mode with help of a special firmware software. b-Mode Modulation scheme. For spurious emission tests 6MBit as worst-case from modules test report chosen. Power verification was performed on all modulations data rates. Test software version 1.1.0.13
op. 2	WLAN Continuous TX-Mode ac-Mode, HT40	The EUT was put to continuous transmissions mode with help of a special firmware software. g-Mode Modulation scheme. For spurious emission tests MCS0 as worst-case from modules test report chosen. Power verification was performed on all modulations data rates. Test software version 1.1.0.13

\*) EUT operating mode no. is used to simplify the test report

**3.7. Configuration of cables used for testing**

Cable number	Item	Type	S/N serial number	HW hardware status	Cable length
Cable 1	Main harness (AE1)	--	1007-141-06	Rev A1.1 (Length : 2.03 m)	--
Cable 2	DLC ethernet cable (AE4)	Maxxtro Patch cable FTP CAT. 5E 26AWG	1007-142-01	Rev.B1.0 (Length:1.97 m)	
Cable 3	Antenna power supply cable (Twisted red cable 3-pin MQS)	Huber + Suhner Radox 125	--	0.50 MM2 (Length:2.1 m)	
Cable 4	WLAN antenna cable (Orange Fakra connectors)	Huber + Suhner Enviroflex 400	--	E111025 AWM 522787 (Length: 2m)	
Cable 5	GNSS antenna cable (Blue Fakra connectors)	Huber + Suhner Enviroflex 400	--	E111025 AWM 522787 (Length: 2m)	
Cable 6	2G/3G/4G antenna cable (Violet/Bordeaux Fakra connectors)	Huber + Suhner Enviroflex 400	--	E111025 AWM 522787 (Length: 2m)	--
Cable 7	3G/4G Diversity antenna cable (Pink Fakra connectors)	Huber + Suhner Enviroflex 400	--	E111025 AWM 522787 (Length: 2m)	--

## 4. Description of test system set-up's

### 4.1. Test system set-up for conducted measurements on antenna port

#### Conducted Set-up W1

##### W-LAN conducted RF-Setup 1 (W1 Set-up)

#### General description:

The EUT's RF-signal is coupled out by a suitable antenna coupling connector (1). The signal is first attenuated (2) then connected to the power meter (3) for conducted power measurements. The specific attenuation loss is determined prior to the measurement within a set-up attenuation measurement. These are then taken into account by correcting the measurement readings.

#### Schematic:

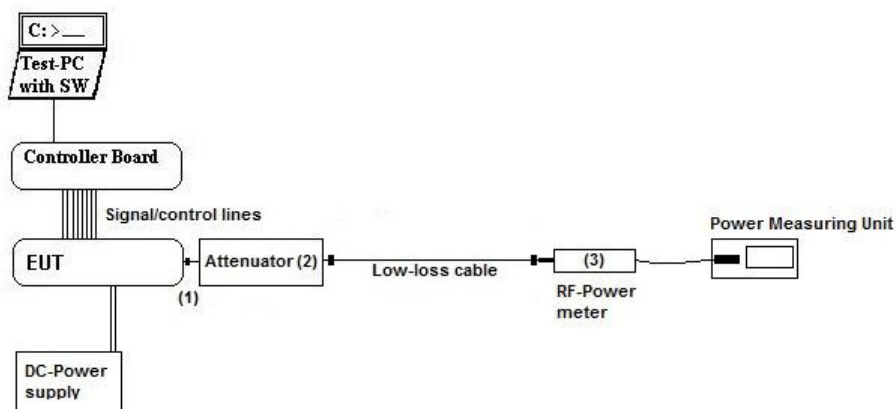

#### Testing method:

ANSI C63.10: 2013 Chapter 12.3.3.1+ FCC KDB 789033

#### Used Equipment

Passive Elements	Test Equipment	Remark:
<input checked="" type="checkbox"/> 20 dB Attenuator	<input checked="" type="checkbox"/> Power Meter	See List of equipment under each test case and chapter 8 for calibration info
<input checked="" type="checkbox"/> Low loss RF-cables	<input checked="" type="checkbox"/> DC-Power Supply	
	<input checked="" type="checkbox"/> Spectrum-Analyser	

#### Measurement uncertainty

See chapter 5.6

## 4.2. Test system set-up for radiated magnetic field measurements below 30 MHz

**Specification:** ANSI C63.10-2013 chapter 6.4 (§6.4.4.2)

**General Description:** Evaluating the radiated field emissions are done first by an exploratory emission measurement and a final measurement for most critical frequencies determined.

The loop antenna was placed at 1 m height above ground plane and 3 m measurement distance from set-up for investigations. Because of reduced measurement distance, correction data were applied, as stated in chapter “General Limit - Radiated field strength emissions below 30 MHz“. The tests are performed in the semi anechoic room recognized by the regulatory commission.

**Schematic:**

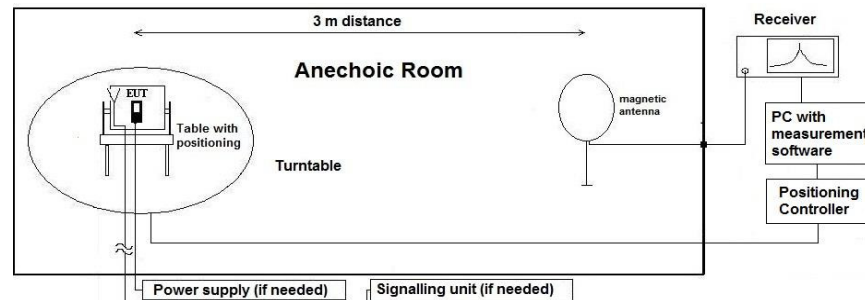

**Testing method:**

### Exploratory, preliminary measurement

The EUT and its associated accessories are placed on a non-conductive position manipulator (tipping device) of 0.8 m height which is placed on the turntable. By rotating the turntable (step 90°, range 0° to 360°) and the EUT itself either on 3-orthogonal axis (portable equipment) or 2-orthogonal axis (defined operational position of EUT), the emission spectrum was recorded. The loop antenna was moved at least to 2-perpendicular axes (antenna vector in direction of EUT and parallel to EUT) in order to maximize the emissions. The results are documented in a diagram. Critical frequencies (low margin to limit) are saved within a data reduction table for further investigations. If various operating modes are supported, further investigations are made to find the worst-case. Also the interconnection cables and equipment position were varied in order to maximize the emissions.

### Final measurement on critical frequencies

Based on the exploratory measurements, the most critical frequencies are re-measured by maintaining the EUT’s worst-case operation mode, cable position, etc.

First a frequency zoom around the critical frequency is done to locate the frequency more precisely. After this step, for all identified critical frequencies, the maximum peak was determined.

Following parameters were varied: the turntable angle continuously in the range 0 to 360 degree, the EUT itself either over 3-orthogonal axis (not defined usage position) or 2-orthogonal axis (defined usage position).

On the determined worst-case position, a final measurement with necessary bandwidth and detector according standard has been carried out.

**Formula:**

$$E_C = E_R + AF + C_L + D_F - G_A$$

$$M = L_T - E_C$$

AF = Antenna factor

C<sub>L</sub> = Cable loss

D<sub>F</sub> = Distance correction factor

E<sub>C</sub> = Electrical field – corrected value

E<sub>R</sub> = Receiver reading

G<sub>A</sub> = Gain of pre-amplifier (if used)

L<sub>T</sub> = Limit

M = Margin

All units are dB-units, positive margin means value is below limit.

**Distance correction:**

Reference for applied correction (extrapolating) factors due to reduced measurement distance:

ANSI C63.10:2013, §6.4.4.2 - Equations (2) + (3) + (4)

### 4.3. Test system set-up for radiated electric field measurement 30 MHz to 1 GHz

**Specification:** ANSI C63.4-2014 chapter 8.2.3, ANSI C63.10-2013 chapter 6.5

**General Description:** Evaluating the field emissions have to be done first by an exploratory emissions measurement and a final measurement for most critical frequencies. The tests are performed in a NSA-compliant semi anechoic room (SAR) recognized by the regulatory commissions.

**Schematic:**

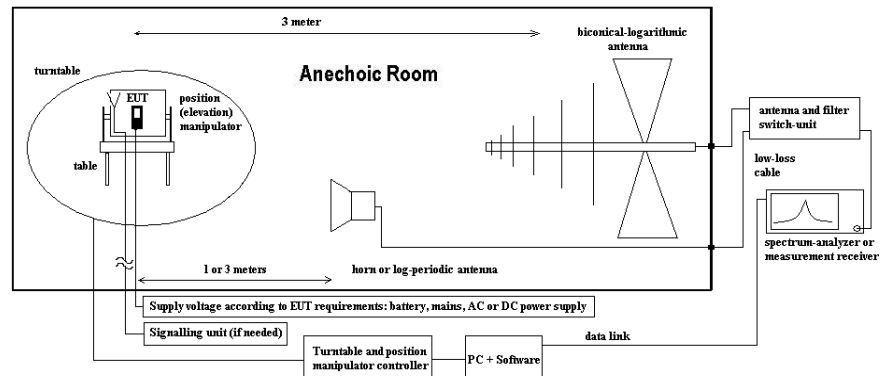

**Testing method:**

**Exploratory, preliminary measurements**

The EUT and its associated accessories are placed on a non-conductive position manipulator (tipping device) of 0.8 m height which is placed on the turntable. By rotating the turntable (range 0° to 360°, step 90°) and the EUT itself either on 3-orthogonal axis (portable equipment) or 2-orthogonal axis (defined operational position of EUT) the emission spectrum and its characteristics was recorded with an EMI-receiver, broadband antenna and software.

Measurement antenna: horizontal and vertical, heights: 1,0 m and 1,82 m as worst-case determined by an exploratory emission measurements. The results are documented in a diagram. Critical frequencies (low margin to limit) are saved within a table for further investigations. If various operating modes are supported, further investigations are made to find the worst-case of them. Also the interconnection cables and equipment position were varied in order to maximize the emissions.

**Final measurement on critical frequencies**

Based on the exploratory measurements, the most critical frequencies are re-measured by maintaining the EUT’s worst-case operation mode, cable position, etc. either on 10m OATS or 3m semi-anechoic room.

First a frequency zoom around the critical frequency is done to locate the frequency more precisely. After this step, for all identified critical frequencies, the maximum peak was determined.

Following parameters were varied: the turntable angle continuously in the range 0 to 360 degree, the EUT itself either over 3-orthogonal axis (not defined usage position) or 2-orthogonal axis (defined usage position). The measurement antenna height between 1 m and 4 m.

On the determined worst-case position, a final measurement with necessary bandwidth and detector according standard has been carried out.

**Formula:**

$$E_C = E_R + AF + C_L + D_F - G_A \quad (1)$$

$$M = L_T - E_C \quad (2)$$

- AF = Antenna factor
- C<sub>L</sub> = Cable loss
- D<sub>F</sub> = Distance correction factor (if used)
- E<sub>C</sub> = Electrical field – corrected value
- E<sub>R</sub> = Receiver reading
- G<sub>A</sub> = Gain of pre-amplifier (if used)
- L<sub>T</sub> = Limit
- M = Margin

All units are dB-units, positive margin means value is below limit.

#### 4.4. Test system set-up for radiated electric field measurement above 1 GHz

**Specification:** ANSI C63.4-2014 chapter 8.3, ANSI C63.10-2013 chapter 6.6.3.3 & 6.6.4

**General Description:** Evaluating the emissions have to be done first by an exploratory emissions measurement and a final measurement for most critical frequencies. The tests are performed in a CISPR 16-1-4:2010 compliant fully anechoic room (FAR) recognized by the regulatory commission. The measurement distance was set to 3 meter for frequencies up to 18 GHz and 2 meter above 18 GHz. A logarithmic periodic antenna is used for the frequency range 30 MHz to 1 GHz. Horn antennas are used for frequency range 1 GHz to 40 GHz. The EUT is aligned within 3 dB beam width of the measurement antenna with three orthogonal axis measurements on the EUT.

**Schematic:**

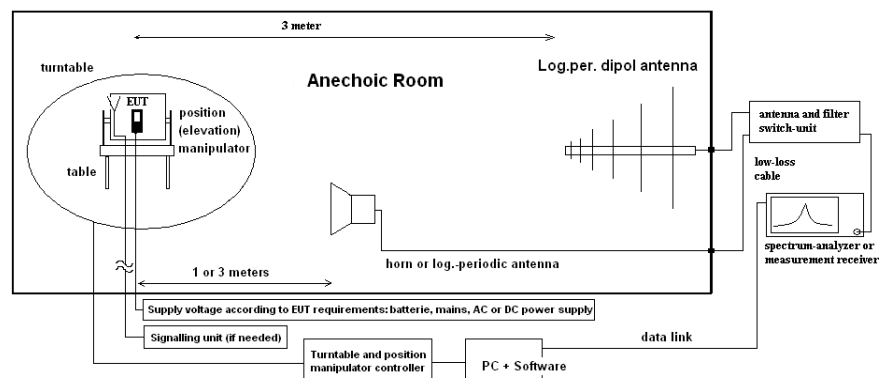

**Testing method:**

**Exploratory, preliminary measurements**

The EUT and its associated accessories are placed on a non-conductive position manipulator (tipping device) of 1.55 m height which is placed on the turntable. By rotating the turntable (range 0° to 360°, step 15°) and the EUT itself either on 3-orthogonal axis (portable equipment) or 2-orthogonal axis (defined operational position of EUT) the emission spectrum and its characteristics was recorded with an EMI-receiver, broadband antenna and software.

The measurements are performed in horizontal and vertical polarization of the measurement antennas. The results are documented in a diagram. Critical frequencies (low margin to limit) are saved within a table for further investigations. If various operating modes are supported, further investigations are made to find the worst-case of them. Also the interconnection cables and equipment position were varied in order to maximize the emissions.

**Final measurement on critical frequencies**

Based on the exploratory measurements, the most critical frequencies are re-measured by maintaining the EUT's worst-case operation mode, cable position, etc.

First a frequency zoom around the critical frequency is done to locate the frequency more precisely. After this step, for all identified critical frequencies, the maximum peak was determined. Following parameters were varied: the turntable angle continuously in the range 0 to 360 degree, the EUT itself over 3-orthogonal axis and the height for EUT with large dimensions.

On the determined worst-case position, a final measurement with necessary bandwidth and detector according standard has been carried out. On the determined worst-case position, a final measurement with necessary bandwidth and detector according standard has been carried out.

**Formula:**

$$E_C = E_R + AF + C_L + D_F - G_A \quad (1)$$

$$M = L_T - E_C \quad (2)$$

$E_C$  = Electrical field – corrected value

$E_R$  = Receiver reading

$M$  = Margin

$L_T$  = Limit

$AF$  = Antenna factor

$C_L$  = Cable loss

$D_F$  = Distance correction factor (if used)

$G_A$  = Gain of pre-amplifier (if used)

All units are dB-units, positive margin means value is below limit.

## 5. Measurements

### 5.1. RF-Parameter - Transmitter Peak output power (conducted and radiated)

#### 5.1.1. Test location and equipment (for reference numbers please see chapter 'List of test equipment')

test location	<input checked="" type="checkbox"/> CETECOM Essen (Chapter. 2.2.1)	<input checked="" type="checkbox"/> 443 System CTC-FAR-EMI-	<input type="checkbox"/> Please see Chapter. 2.2.3
test site	<input type="checkbox"/> 441 EMI SAR	<input type="checkbox"/> 487 SAR NSA	<input type="checkbox"/> 337 OATS
receiver	<input type="checkbox"/> 377 ESCS30	<input type="checkbox"/> 001 ESS	<input type="checkbox"/> 489 ESU 40
otherwise	<input checked="" type="checkbox"/> 600 NRVD	<input checked="" type="checkbox"/> 357 NRV-Z1	<input checked="" type="checkbox"/> 693 TS8997
spectr. analys.	<input type="checkbox"/> 215 FSU	<input type="checkbox"/> 120 FSEM	<input type="checkbox"/> 264 FSEK
power supply	<input type="checkbox"/> 456 EA 3013A	<input type="checkbox"/> 457 EA 3013A	<input type="checkbox"/> 459 EA 2032-50
otherwise	<input type="checkbox"/> 693 TS8997	<input type="checkbox"/> 248 6 dB Attenuator	<input type="checkbox"/> 529 Power divider
line voltage	<input checked="" type="checkbox"/> 13.8V DC	<input type="checkbox"/> 60 120 V 60 Hz	<input type="checkbox"/> via PAS 5000

#### 5.1.2. Reference:

FCC	<input checked="" type="checkbox"/> Part 15 Subpart C, §15.407(a)(1)(2)(3)
IC	<input checked="" type="checkbox"/> RSS-247, Issue 1
ANSI	<input checked="" type="checkbox"/> C63.10-2013
KDB Guidance no.	<input checked="" type="checkbox"/> 789033 D02 General UNII test procedures v01r02: Subchapter E, <b>Method PM (3)(a)</b>
Limits	<input checked="" type="checkbox"/> U-NII 1: 5.15-5.25 GHz: <b>FCC Outdoor access point:</b> 1W + antenna gain max. 6dBi + Elevation > 30° 21 dBm EIRP <b>FCC Indoor Access Point:</b> 1W + antenna gain max. 6dBi <b>FCC Mobile &amp; Portable client:</b> 250mW + antenna gain max. 6dBi  <b>IC:</b> E.I.R.P. max. 200mW or 10+10log <sub>10</sub> (B) whichever power less
	<input type="checkbox"/> U-NII2: 5.25-5.35 GHz: <b>FCC:</b> 250mW or 11dBm+10log <sub>10</sub> (B) <b>IC:</b> 250mW or 11dBm+10log <sub>10</sub> (B) + EIRP Elevation Mask requirements if max. EIRP>200mW Max. EIRP 1Watt or 17+10log <sub>10</sub> (B) whichever power less
	<input type="checkbox"/> U-NII2extension: 5.470-5.725 GHz: <b>FCC/IC:</b> Lesser of: 250mW or 11dBm+10log <sub>10</sub> (B) whichever power less Max. EIRP 1Watt or 17+10log <sub>10</sub> (B) whichever power less
	<input checked="" type="checkbox"/> U-NII2extension: 5.475-5.85 GHz: <b>FCC/IC:</b> Max. EIRP 1Watt

Remark: --

#### 5.1.3. Antenna characteristics:

According §15.407(a)(1)(2):

- directional gain < 6 dBi (measured: difference between measured conducted and radiated eirp. power)  
 directional gain > 6 dBi (measured / applicant's declaration) -> conducted power reduction necessary

- Maximum declared antenna gain [isotropic]: 8.25 dBi
- Due long cables to antenna a path loss of 4.9 dB is considered
- Internal loss: 2.5dB is considered too.
- Total gain of antenna (effective): 8.25dBi-(4.9dB+2.5dB)=0.85dBi (<6dBi as permitted)

#### 5.1.4. EUT settings:

The EUT was instructed to send with maximum power (if adjustable) according applicants instructions. Different modulation characteristics have been checked, e.g. data rates which EUT can operate. Different frequencies within each operating band have been selected.

#### 5.1.5. Measurement method:

The power was also checked for different data rates, modulation scheme or packet types if applicable.



### 5.1.6. Conducted power measurement and EIRP calculation

- Duty cycle and correction factor (please refer at annex 1, chpt. 1):  
 ➔ None, because negligible near 100% (0.09dB)

Max. Peak Power (conducted) [dBm]				
Set-up no: 3 Op-Mode: Tx-continuous	U-NII 1 (5150-5250MHz)	U-NII-A (5250-5350MHz)	U-NII2C (5470-5725MHz)	U-NII-3 (5725-5825MHz)
Measured Level a-Mode	12.98	12.71	12.65	11.07
Measured Level HT20-Mode	12.95	12.71	12.48	11.28
Measured Level HT40-Mode	10.51	10.40	9.40	8.27
Measured Max. Level	12.98	12.71	12.65	11.28
Conducted Limit [dBm]:	23.98 <small>(21.0 dBm e.i.r.p. for azimuth angles &gt; 30° over horizon)</small>	23.98	23.98	30.0

Remark: tests performed with certification software version 1.1.0.8

### 5.1.7. Verdict: Passed

## 5.2. General Limit - Radiated field strength emissions below 30 MHz

### 5.2.1. Test location and equipment

test location	<input checked="" type="checkbox"/> CETECOM Essen (Chapter. 2.2.1)	<input type="checkbox"/> Please see Chapter. 2.2.2	<input type="checkbox"/> Please see Chapter. 2.2.3
test site	<input checked="" type="checkbox"/> 441 EMI SAR	<input type="checkbox"/> 487 SAR NSA	<input type="checkbox"/> 347 Radio.lab.
receiver	<input type="checkbox"/> 377 ESCS30	<input checked="" type="checkbox"/> 001 ESS	<input type="checkbox"/>
spectr. analys.	<input type="checkbox"/> 584 FSU	<input type="checkbox"/> 120 FSEM	<input type="checkbox"/> 264 FSEK
antenna	<input type="checkbox"/> 574 BTA-L	<input type="checkbox"/> 133 EMCO3115	<input type="checkbox"/> 302 BBHA9170
signaling	<input type="checkbox"/> 392 MT8820A	<input type="checkbox"/> 371 CBT32	<input type="checkbox"/> 547 CMU
otherwise	<input type="checkbox"/> 400 FTC40x15E	<input type="checkbox"/> 401 FTC40x15E	<input type="checkbox"/> 110 USB LWL
DC power	<input type="checkbox"/> 456 EA 3013A	<input type="checkbox"/> 457 EA 3013A	<input type="checkbox"/> 459 EA 2032-50
line voltage	<input checked="" type="checkbox"/> 13.8V DC	<input type="checkbox"/> 060 120 V 60 Hz	via PAS 5000

### 5.2.2. Requirements

FCC	Part 15, Subpart C, §15.205 & §15.209			
IC	RSS-Gen: Issue 4: §8.9 Table 5			
ANSI	C63.10-2013			
Frequency [MHz]	Field strength limit		Distance [m]	Remarks
	[ $\mu$ V/m]	[dB $\mu$ V/m]		
0.009 – 0.490	2400/f (kHz)	67.6 – 20Log(f) (kHz)	300	Correction factor used due to measurement distance of 3 m
0.490 – 1.705	24000/f (kHz)	87.6 – 20Log(f) (kHz)	30	Correction factor used due to measurement distance of 3 m
1.705 – 30	30	29.5	30	Correction factor used due to measurement distance of 3 m

### 5.2.3. Test condition and test set-up

Signal link to test system (if used):	<input type="checkbox"/> air link	<input type="checkbox"/> cable connection	<input checked="" type="checkbox"/> none
EUT-grounding	<input checked="" type="checkbox"/> none	<input type="checkbox"/> with power supply	<input type="checkbox"/> additional connection
Equipment set up	<input checked="" type="checkbox"/> table top	<input type="checkbox"/> floor standing	
Climatic conditions	Temperature: (22 $\pm$ 3 $^{\circ}$ C)		Rel. humidity: (40 $\pm$ 20)%
EMI-Receiver or Analyzer Settings	Scan data	<input checked="" type="checkbox"/> 9 – 150 kHz RBW/VBW = 200 Hz Scan step = 80 Hz <input checked="" type="checkbox"/> 150 kHz – 30 MHz RBW/VBW = 9 kHz Scan step = 4 kHz <input type="checkbox"/> other:	
	Scan-Mode Detector Mode: Sweep-Time	<input checked="" type="checkbox"/> 6 dB EMI-Receiver Mode <input type="checkbox"/> 3dB Spectrum analyser Mode Peak (pre-measurement) and Quasi-PK/Average (final if applicable) Repetitive-Scan, max-hold Coupled – calibrated display if continuous signal otherwise adapted to EUT’s individual transmission duty-cycle	
General measurement procedures	Please see chapter “Test system set-up radiated magnetic field measurements below 30 MHz”		

### 5.2.4. Measurement Results

The results are presented below in summary form only. For more information please consult the diagrams included in annex 1.

The EUT is put on operation on middle channel only. If critical peaks are found (Margin <10 dB) the lowest and highest channels will be performed too. For more information please see the diagrams.

#### Table of measurement results:

Diagram No.	Carrier Channel		Frequency range	Set-up no.	OP-mode no.	Remark	Used detector			Result
	Range	No.					PK	AV	QP	
2.02 Dwn	Low	36	9 kHz-30 MHz	1	1	Downward antenna, 6Mbit, 13dBm	<input checked="" type="checkbox"/>	<input type="checkbox"/>	<input type="checkbox"/>	passed
2.02 Up	Low	36	9 kHz-30 MHz	2	1	Upward antenna, 6Mbit, 13dBm	<input checked="" type="checkbox"/>	<input type="checkbox"/>	<input type="checkbox"/>	passed
2.03 Dwn	High	159	9 kHz-30 MHz	1	2	Downward antenna, MCS0, 8dBm	<input checked="" type="checkbox"/>	<input type="checkbox"/>	<input type="checkbox"/>	passed
2.03 Up	High	159	9 kHz-30 MHz	2	2	Upward antenna, MCS0, 8dBm	<input checked="" type="checkbox"/>	<input type="checkbox"/>	<input type="checkbox"/>	passed

**5.2.5. Correction factors due to reduced meas. distance (f< 30 MHz)**

The used correction factors when the measurement distance is reduced compared to regulatory measurement distance, are calculated according Extrapolation formulas valid for EUT's with maximum dimension of 0.625xLambda. Formula 2+3+4 as presented in ANSI C63.10, Chapter 6.4.4 are used for the calculations of proper extrapolation factors.

Frequency Range	f [kHz/MHz]	Lambda [m]	Far-Field Point [m]	Distance Limit accord. 15.209 [m]	1st Condition (d <sub>meas</sub> < D <sub>near-field</sub> )	2te Condition (Limit distance bigger d <sub>near-field</sub> )	Distance Correction accord. Formula
kHz	9,00E+03	33333,33	5305,17	300	fulfilled	not fulfilled	-80,00
	1,00E+04	30000,00	4774,65		not fulfilled	-80,00	
	2,00E+04	15000,00	2387,33		not fulfilled	-80,00	
	3,00E+04	10000,00	1591,55		not fulfilled	-80,00	
	4,00E+04	7500,00	1193,66		not fulfilled	-80,00	
	5,00E+04	6000,00	954,93		not fulfilled	-80,00	
	6,00E+04	5000,00	795,78		not fulfilled	-80,00	
	7,00E+04	4285,71	682,09		not fulfilled	-80,00	
	8,00E+04	3750,00	596,83		not fulfilled	-80,00	
	9,00E+04	3333,33	530,52		not fulfilled	-80,00	
	1,00E+05	3000,00	477,47		not fulfilled	-80,00	
	1,25E+05	2400,00	381,97		not fulfilled	-80,00	
	2,00E+05	1500,00	238,73		fulfilled	fulfilled	-78,02
	3,00E+05	1000,00	159,16		fulfilled	fulfilled	-74,49
	4,00E+05	750,00	119,37		fulfilled	fulfilled	-72,00
	4,90E+05	612,24	97,44		fulfilled	fulfilled	-70,23
	5,00E+05	600,00	95,49		fulfilled	not fulfilled	-40,00
	6,00E+05	500,00	79,58		fulfilled	not fulfilled	-40,00
7,00E+05	428,57	68,21	fulfilled	not fulfilled	-40,00		
8,00E+05	375,00	59,68	fulfilled	not fulfilled	-40,00		
9,00E+05	333,33	53,05	fulfilled	not fulfilled	-40,00		
MHz	1,00	300,00	47,75	30	fulfilled	not fulfilled	-40,00
	1,59	188,50	30,00		fulfilled	not fulfilled	-40,00
	2,00	150,00	23,87		fulfilled	fulfilled	-38,02
	3,00	100,00	15,92		fulfilled	fulfilled	-34,49
	4,00	75,00	11,94		fulfilled	fulfilled	-32,00
	5,00	60,00	9,55		fulfilled	fulfilled	-30,06
	6,00	50,00	7,96		fulfilled	fulfilled	-28,47
	7,00	42,86	6,82		fulfilled	fulfilled	-27,13
	8,00	37,50	5,97		fulfilled	fulfilled	-25,97
	9,00	33,33	5,31		fulfilled	fulfilled	-24,95
	10,00	30,00	4,77		fulfilled	fulfilled	-24,04
	10,60	28,30	4,50		fulfilled	fulfilled	-23,53
	11,00	27,27	4,34		fulfilled	fulfilled	-23,21
	12,00	25,00	3,98		fulfilled	fulfilled	-22,45
	13,56	22,12	3,52		fulfilled	fulfilled	-21,39
	15,00	20,00	3,18		fulfilled	fulfilled	-20,51
	15,92	18,85	3,00		fulfilled	fulfilled	-20,00
	17,00	17,65	2,81		not fulfilled	fulfilled	-20,00
	18,00	16,67	2,65		not fulfilled	fulfilled	-20,00
	20,00	15,00	2,39		not fulfilled	fulfilled	-20,00
	21,00	14,29	2,27		not fulfilled	fulfilled	-20,00
23,00	13,04	2,08	not fulfilled	fulfilled	-20,00		
25,00	12,00	1,91	not fulfilled	fulfilled	-20,00		
27,00	11,11	1,77	not fulfilled	fulfilled	-20,00		
29,00	10,34	1,65	not fulfilled	fulfilled	-20,00		
30,00	10,00	1,59	not fulfilled	fulfilled	-20,00		

### 5.3. General Limit - Radiated field strength emissions, 30 MHz - 1 GHz

#### 5.3.1. Test location and equipment

test location	<input checked="" type="checkbox"/> CETECOM Essen (Chapter. 2.2.1)	<input type="checkbox"/> Please see Chapter. 2.2.2	<input type="checkbox"/> Please see Chapter. 2.2.3
test site	<input checked="" type="checkbox"/> 441 EMI SAR <input checked="" type="checkbox"/> 487 SAR NSA		
receiver	<input type="checkbox"/> 377 ESCS30 <input checked="" type="checkbox"/> 001 ESS	<input type="checkbox"/> 489 ESU 40	<input type="checkbox"/> 620 ESU 26
spectr. analys.	<input type="checkbox"/> 584 FSU <input type="checkbox"/> 120 FSEM	<input type="checkbox"/> 264 FSEK	
antenna	<input checked="" type="checkbox"/> 574 BTA-L <input type="checkbox"/> 133 EMCO3115	<input type="checkbox"/> 302 BBHA9170	<input type="checkbox"/> 289 CBL 6141 <input type="checkbox"/> 030 HFH-Z2 <input type="checkbox"/> 477 GPS
signaling	<input type="checkbox"/> 392 MT8820A <input type="checkbox"/> 371 CBT32	<input type="checkbox"/> 547 CMU	<input type="checkbox"/> 594 CMW
otherwise	<input type="checkbox"/> 400 FTC40x15E <input type="checkbox"/> 401 FTC40x15E	<input type="checkbox"/> 110 USB LWL	<input checked="" type="checkbox"/> 482 Filter Matrix
DC power	<input type="checkbox"/> 456 EA 3013A <input type="checkbox"/> 457 EA 3013A	<input type="checkbox"/> 459 EA 2032-50	<input type="checkbox"/> 268 EA- 3050 <input type="checkbox"/> 494 AG6632A <input type="checkbox"/> 498 NGPE
line voltage	<input checked="" type="checkbox"/> 13.8V DC	<input checked="" type="checkbox"/> 060 120 V 60 Hz via PAS 5000	

#### 5.3.2. Requirements/Limits

<b>FCC</b>		<input type="checkbox"/> Part 15 Subpart B, §15.109, class B <input checked="" type="checkbox"/> Part 15 Subpart C, §15.209 @ frequencies defined in §15.205	
<b>IC</b>		<input checked="" type="checkbox"/> RSS-Gen., Issue 4, Chapter 8.9, Table 4+6 (licence-exempt radio apparatus) <input type="checkbox"/> RSS-Gen., Issue 4, Chapter 7.1.2, Table 2 (receiver) <input type="checkbox"/> ICES-003, Issue 6, Table 5 (Class B) <input type="checkbox"/> RSS-247, Issue 1, Chapter 5	
<b>ANSI</b>		<input checked="" type="checkbox"/> C63.4-2014 <input type="checkbox"/> C63.10-2013	
<b>Limit</b>	Frequency [MHz]	Radiated emissions limits, 3 meters	
		QUASI Peak [ $\mu$ V/m]	QUASI-Peak [dB $\mu$ V/m]
	30 - 88	100	40.0
	88 - 216	150	43.5
	216 - 960	200	46.0
	above 960	500	54.0

#### 5.3.3. Restricted bands of operation (FCC §15.205/ RSS-Gen, Issue 4 Chapter 8.9, Table 4)

MHz	MHz	MHz	GHz
0.090-0.110	16.42-16.423	399.9-410	4.5-5.15
0.495-0.505	16.69475-16.69525	608-614	5.35-5.46
2.1735-2.1905	16.80425-16.80475	960-1240	7.25-7.75
4.125-4.128	25.5-25.67	1300-1427	8.025-8.5
4.20725-4.20775	37.5-38.25	1645.5-1646.5	9.3-9.5
6.215-6.218	73-74.6	1660-1710	10.6-12.7
6.26775-6.26825	74.8-75.2	1718.8-1722.2	13.25-13.4
6.31175-6.31225	108-121.94	2200-2300	14.47-14.5
8.291-8.294	123-138	2310-2390	15.35-16.2
8.362-8.366	149.9-150.05	2483.5-2500	17.7-21.4
8.37625-8.38675	156.52475-156.52525	2690-2900	22.01-23.12
8.41425-8.41475	156.7-156.9	3260-3267	23.6-24.0
12.29-12.293	162.0125-167.17	3332-3339	31.2-31.8
12.51975-12.52025	167.72-173.2	3345.8-3358	36.43-36.5
12.57675-12.57725	240-285	3600-4400	--
13.36-13.41	322-335.4	--	--

Remark: only spurious emissions are allowed within these frequency bands not exceeding the limits per §15.209

### 5.3.4. Test condition and measurement test set-up

Signal link to test system (if used):		<input type="checkbox"/> air link	<input type="checkbox"/> cable connection	<input type="checkbox"/> none
EUT-grounding		<input checked="" type="checkbox"/> none	<input type="checkbox"/> with power supply	<input type="checkbox"/> additional connection
Equipment set up		<input checked="" type="checkbox"/> table top 0.8m height		<input type="checkbox"/> floor standing
Climatic conditions		Temperature: (22±3°C)		Rel. humidity: (40±20)%
EMI-Receiver (Analyzer) Settings	Scan frequency range:	<input checked="" type="checkbox"/> 30 – 1000 MHz <input type="checkbox"/> other:		
	Scan-Mode	<input checked="" type="checkbox"/> 6 dB EMI-Receiver Mode <input type="checkbox"/> 3 dB spectrum analyser mode		
	Detector	Peak / Quasi-peak		
	RBW/VBW	100 kHz/300 kHz		
	Mode:	Repetitive-Scan, max-hold		
Scan step	80 kHz			
Sweep-Time	Coupled – calibrated display if continuous tx-signal otherwise adapted to EUT's individual duty-cycle			
General measurement procedures		Please see chapter "Test system set-up for electric field measurement in the range 30 MHz to 1 GHz"		

### 5.3.5. MEASUREMENT RESULTS

The results are presented below in summary form only. For more information please consult the diagrams included in annex 1.

Table of measurement results:

Diagram no.	Carrier Channel		Frequency range	Set-up no.	OP-mode no.	Remark	Used detector			Result
	Range	No.					PK	AV	QP	
3.02 Dwn	Low	36	30 MHz – 1 GHz	1	1	Downward antenna, 6Mbit, power level=13dBm	<input checked="" type="checkbox"/>	<input type="checkbox"/>	<input checked="" type="checkbox"/>	passed
3.02 Up	Low	36	30 MHz – 1 GHz	2	1	Upward antenna, 6Mbit, power level=13dBm	<input checked="" type="checkbox"/>	<input type="checkbox"/>	<input checked="" type="checkbox"/>	passed
3.04_Dwn	High	159	30 MHz – 1 GHz	1	2	Downward antenna, MCS0, power level=8dBm	<input checked="" type="checkbox"/>	<input type="checkbox"/>	<input checked="" type="checkbox"/>	passed
03.04 Up	High	159	30 MHz – 1 GHz	2	2	Upward antenna, MCS0, power level=8dBm	<input checked="" type="checkbox"/>	<input type="checkbox"/>	<input checked="" type="checkbox"/>	passed

Remark:

### 5.4. General Limit - Radiated emissions, above 1 GHz

#### 5.4.1. Test location and equipment FAR

test site	<input type="checkbox"/> 441 EMI SAR	<input type="checkbox"/> 348 EMI cond.	<input checked="" type="checkbox"/> 443 EMI FAR	<input type="checkbox"/> 347 Radio.lab.	<input type="checkbox"/> 337 OATS	<input type="checkbox"/>
spectr. analys.	<input type="checkbox"/> 584 FSU	<input type="checkbox"/> 120 FSEM	<input type="checkbox"/> 264 FSEK	<input checked="" type="checkbox"/> 489 ESU 40	<input type="checkbox"/>	<input type="checkbox"/>
antenna meas	<input type="checkbox"/> 574 BTA-L	<input type="checkbox"/> 289 CBL 6141	<input type="checkbox"/> 608 HL 562	<input checked="" type="checkbox"/> 549 HL025	<input checked="" type="checkbox"/> 302 BBHA9170	<input type="checkbox"/> 477 GPS
antenna meas	<input type="checkbox"/> 123 HUF-Z2	<input type="checkbox"/> 132 HUF-Z3	<input type="checkbox"/> 030 HFH-Z2	<input checked="" type="checkbox"/> 376 BBHA9120E		<input type="checkbox"/>
antenna subst	<input type="checkbox"/> 071 HUF-Z2	<input type="checkbox"/> 020 EMCO3115	<input type="checkbox"/> 063 LP 3146	<input type="checkbox"/> 303 BBHA9170	<input type="checkbox"/>	<input type="checkbox"/>
multimeter	<input type="checkbox"/> 341 Fluke 112	<input type="checkbox"/>	<input type="checkbox"/>	<input type="checkbox"/>	<input type="checkbox"/>	<input type="checkbox"/>
signaling	<input type="checkbox"/> 392 MT8820A	<input type="checkbox"/> 371 CBT32	<input type="checkbox"/> 547 CMU	<input type="checkbox"/> 594 CMW		
DCpower	<input type="checkbox"/> 086 LNG50-10	<input type="checkbox"/> 087 EA3013	<input type="checkbox"/> 354 NGPE 40	<input type="checkbox"/> 349 car battery	<input type="checkbox"/> 350 Car battery	<input type="checkbox"/>
line voltage	<input checked="" type="checkbox"/> 13.8V DC		<input checked="" type="checkbox"/> 060 120 V 60 Hz via PAS 5000			

#### 5.4.2. Requirements/Limits (CLASS B equipment)

<b>FCC</b>	<input type="checkbox"/> Part 15 Subpart B, §15.109 class B <input checked="" type="checkbox"/> Part 15 Subpart C, §15.209 for frequencies defined in §15.205 <input checked="" type="checkbox"/> Part 15 Subpart C, §15.407(b)(1)(2)(3) 9			
<b>IC</b>	<input checked="" type="checkbox"/> RSS-Gen., Issue 4, Chapter 8.9, Table 4+6 (transmitter licence exempt) <input type="checkbox"/> RSS-Gen., Issue 4, Chapter 8.9, Table 2 (receiver) <input type="checkbox"/> ICES-003, Issue 6, Chapter 6.2.2, Table 7 (class B) <input checked="" type="checkbox"/> RSS-247, Issue 1, Chapter 6			
<b>ANSI</b>	<input type="checkbox"/> C63.4-2014 <input checked="" type="checkbox"/> C63.10-2013			
	Limits			
Frequency [MHz]	AV [µV/m]	AV [dBµV/m]	Peak [µV/m]	Peak [dBµV/m] or [dBm/MHz]
above 1 GHz for frequencies as defined in §15.205 or RSS-Gen., Issue 4, §8.10 - Table 6	500	54.0	5000	74.0 dBµV/m
§15.407(b) Or RSS-247, Issue 1	--	--	--	-27dBm/MHz (68.5 dBµV/m) or -17dBm/MHz (78.5 dBµV/m)

#### 5.4.3. Test condition and measurement test set-up

Signal link to test system (if used):	<input type="checkbox"/> air link	<input type="checkbox"/> cable connection	<input checked="" type="checkbox"/> none
EUT-grounding	<input checked="" type="checkbox"/> none	<input type="checkbox"/> with power supply	<input type="checkbox"/> additional connection
Equipment set up	<input checked="" type="checkbox"/> table top 1.5m height		<input type="checkbox"/> floor standing
Climatic conditions	Temperature: (22±3°C)		Rel. humidity: (40±20)%
Spectrum-Analyzer settings	Scan frequency range: <input checked="" type="checkbox"/> 1 – 18 GHz <input type="checkbox"/> 18 – 25 GHz <input type="checkbox"/> 18 – 40 GHz <input type="checkbox"/> other: <input checked="" type="checkbox"/> 6 dB EMI-Receiver Mode <input type="checkbox"/> 3 dB Spectrum analyser Mode Peak and Average 1 MHz / 3 MHz Repetitive-Scan, max-hold 400 kHz Coupled – calibrated display if CW signal otherwise adapted to EUT’s individual duty-cycle		
General measurement procedures	Please see chapter “Test system set-up for radiated electric field measurements above 1 GHz”		

#### 5.4.4. Measurement Results

The results are presented below in summary form only. For more information please consult the diagrams included in annex 1.

Diagram no.	Carrier Channel		Frequency range	Set-up no.	OP-mode no.	Remark	Used detector			Result
	Range	No.					PK	AV	QP	
4.08_Dwn	Low	36	1-7GHz	1	1	Downward antenna, 6Mbit	<input checked="" type="checkbox"/>	<input checked="" type="checkbox"/>	<input type="checkbox"/>	passed
4.09_Dwn	Low	36	7-18GHz	1	1	Downward antenna, 6Mbit	<input checked="" type="checkbox"/>	<input checked="" type="checkbox"/>	<input type="checkbox"/>	passed
4.12_Down	Low	36	18-40GHz	1	1	Downward antenna, 6Mbit	<input checked="" type="checkbox"/>	<input checked="" type="checkbox"/>	<input type="checkbox"/>	passed
4.08_Up	Low	36	1-7GHz	2	1	Upward antenna, 6Mbit	<input checked="" type="checkbox"/>	<input checked="" type="checkbox"/>	<input type="checkbox"/>	passed
4.09_Up	Low	36	7-18GHz	2	1	Upward antenna, 6Mbit	<input checked="" type="checkbox"/>	<input checked="" type="checkbox"/>	<input type="checkbox"/>	passed
2.12_Up	Low	36	18-40GHz	2	1	Upward antenna, 6Mbit	<input checked="" type="checkbox"/>	<input checked="" type="checkbox"/>	<input type="checkbox"/>	passed
4.10_Dwn	High	159	1-7GHz	1	2	Downward antenna, MCS0, HT40	<input checked="" type="checkbox"/>	<input checked="" type="checkbox"/>	<input type="checkbox"/>	passed
4.11_Dwn	High	159	7-18GHz	1	2	Downward antenna, MCS0, HT40	<input checked="" type="checkbox"/>	<input checked="" type="checkbox"/>	<input type="checkbox"/>	passed
4.13_Down	High	159	18-40GHz	1	2	Downward antenna, MCS0, HT40	<input checked="" type="checkbox"/>	<input checked="" type="checkbox"/>	<input type="checkbox"/>	passed
4.10_Up	High	159	1-7GHz	2	2	Upward antenna, MCS0, HT40	<input checked="" type="checkbox"/>	<input checked="" type="checkbox"/>	<input type="checkbox"/>	passed
4.11_Up	High	159	7-18GHz	2	2	Upward antenna, MCS0, HT40	<input checked="" type="checkbox"/>	<input checked="" type="checkbox"/>	<input type="checkbox"/>	passed
4.13_Up	High	159	18-25GHz	2	2	Upward antenna, MCS0, HT40	<input checked="" type="checkbox"/>	<input checked="" type="checkbox"/>	<input type="checkbox"/>	passed

**Remark:** see diagrams in annex 1 for more details

## 5.5. General Limit - Band-edge compliance measurements

### 5.5.1. Test location and equipment FAR

test site	<input type="checkbox"/> 441 EMI SAR	<input type="checkbox"/> 348 EMI cond.	<input checked="" type="checkbox"/> 443 EMI FAR	<input type="checkbox"/> 347 Radio.lab.	<input type="checkbox"/> 337 OATS	<input type="checkbox"/>
spectr. analys.	<input type="checkbox"/> 584 FSU	<input type="checkbox"/> 120 FSEM	<input type="checkbox"/> 264 FSEK	<input checked="" type="checkbox"/> 489 ESU 40	<input type="checkbox"/>	<input type="checkbox"/>
antenna meas	<input type="checkbox"/> 574 BTA-L	<input type="checkbox"/> 289 CBL 6141	<input type="checkbox"/> 608 HL 562	<input checked="" type="checkbox"/> 549 HL025	<input type="checkbox"/> 302 BBHA9170	<input type="checkbox"/> 477 GPS
antenna meas	<input type="checkbox"/> 123 HUF-Z2	<input type="checkbox"/> 132 HUF-Z3	<input type="checkbox"/> 030 HFH-Z2	<input type="checkbox"/>	<input type="checkbox"/>	<input type="checkbox"/>
antenna subst	<input type="checkbox"/> 071 HUF-Z2	<input type="checkbox"/> 020 EMCO3115	<input type="checkbox"/> 063 LP 3146	<input type="checkbox"/> 303 BBHA9170	<input type="checkbox"/>	<input type="checkbox"/>
multimeter	<input type="checkbox"/> 341 Fluke 112	<input type="checkbox"/>	<input type="checkbox"/>	<input type="checkbox"/>	<input type="checkbox"/>	<input type="checkbox"/>
signaling	<input type="checkbox"/> 392 MT8820A	<input type="checkbox"/> 371 CBT32	<input type="checkbox"/> 547 CMU	<input type="checkbox"/> 594 CMW	<input type="checkbox"/>	<input type="checkbox"/>
DC power	<input type="checkbox"/> 086 LNG50-10	<input type="checkbox"/> 087 EA3013	<input type="checkbox"/> 354 NGPE 40	<input type="checkbox"/> 349 car battery	<input type="checkbox"/> 350 Car battery	<input type="checkbox"/>
line voltage	<input checked="" type="checkbox"/> 13.8V DC		<input type="checkbox"/> 060 120 V 60 Hz via PAS 5000			

### 5.5.2. Test condition and measurement test set-up

Signal ink to test system (if used):	<input type="checkbox"/> air link	<input type="checkbox"/> cable connection	<input checked="" type="checkbox"/> none
EUT-grounding	<input checked="" type="checkbox"/> none	<input type="checkbox"/> with power supply	<input type="checkbox"/> additional connection
Equipment set up	<input checked="" type="checkbox"/> table top 1.5m height		<input type="checkbox"/> floor standing
Climatic conditions	Temperature: (22±3°C)		Rel. humidity: (40±20)%
Spectrum-Analyzer settings	Scan frequency range: Scan-Mode Detector RBW/VBW  Mode: Scan step Sweep-Time	<input type="checkbox"/> 1 – 18 GHz <input type="checkbox"/> 18 – 25 GHz <input type="checkbox"/> 18 – 40 GHz <input checked="" type="checkbox"/> other: see diagrams <input type="checkbox"/> 6 dB EMI-Receiver Mode <input checked="" type="checkbox"/> 3 dB Spectrum analyser Mode Peak and Average Band-edge: 1 MHz / 3 MHz Repetitive-Scan, max-hold 40kHz or 400 kHz Coupled – calibrated display if CW signal otherwise adapted to EUT’s individual duty-cycle	
General measurement procedures	Please see chapter “Test system set-up for radiated electric field measurements above 1 GHz” for general measurements procedures in anechoic chamber.		

### 5.5.3. Requirements/ Limits

FCC	<input checked="" type="checkbox"/> Part 15 Subpart C, §15.407(b)(1)(2)(3) <input checked="" type="checkbox"/> Part 15 subpart C, §15.209 @ frequencies defined in §15.205			
IC	<input checked="" type="checkbox"/> RSS-247, Issue 1, Chapter 5.5; RSS-Gen: Issue 4: §8.9 Table 4+5+6 <input checked="" type="checkbox"/> RSS-Gen: Issue 4: §8.9, Table 4+6			
ANSI	<input type="checkbox"/> C63.10-2009 for TX-mode <input checked="" type="checkbox"/> C63.10-2013, Chapter 6.10.6			
KDB Guidance no.	<input checked="" type="checkbox"/> 789033 D01 General UNII test procedures v01r02: G(2)(c)(d), G(3)(d)			
Limits accord. §15.205	Above 1GHz	AV [dBµV/m]	Peak [dBµV/m]	
		54.0	74.0	
Limits accord. §15.407	Carrier operating frequency band [MHz]	EIRP – limit for outside operating frequency band		
		Peak [dBm] 30 MHz to 40 GHz	Peak [dBµV/m] <sup>1.)</sup> 30 MHz to 40 GHz@3m	
		5.15 – 5.25 GHz	-27.0	68.2
		5.25 – 5.35 GHz	-27.0	68.2
		5.47 – 5.725 GHz	-27.0	68.2
	5.725 – 5.825 GHz	-27.0 (10 MHz greater above/below band edge) -17.0 (within 10 MHz offset to band-edge)	68.2 (10 MHz greater above/below band edge) 78.2 (within 10 MHz offset to band-edge)	

Remark: 1.) Conversion formula between EIRP and field strength used (Please read measurement method).

### 5.5.4. Measurement method

For uncritical results where a measurement bandwidth of 1MHz can clearly show the compliance without influencing the results, a field strength measurement was performed only.

For critical results a Marker-Delta marker method was used for showing compliance to restricted bands according §15.205. The method is according ANSI 63.10:2013 “Marker-Delta method”, §6.9.3. The method consists of three independent steps:

1. Step: Prior to the measurement the fundamental radiated In-Band field strength was performed. The determined value is used as reference value.



2. Step: Second step consist of finding the relative attenuation between the fundamental emission and the maximum local out-of-band emission (within 2 MHz range around the band edge either on the band-edge directly or some modulation product if the level is greater than that on the band-edge) when measured with lower resolution bandwidth.
3. Step: The delta value recorded in step 2 will be subtracted from value recorded in step 1, thus giving the required field strength at the band-edge. This value must fulfil the requirements for radiated spurious emissions in restricted bands in §15.205 with the general limits of §15.209.

The formula  $EIRP[dBm] = E [dB\mu V/m] - 95.2$  for radiated measurements, which used field strength at 3 meters to convert the value in dBm.

### 5.5.5. EUT settings

The EUT was instructed to send with maximum intended power levels according to applicants instructions.

### 5.5.6. Results:

#### 5.5.6.1. Non-restricted bands near-by - limits according FCC §15.407 and RSS-247, Issue 1, Chapter 5.5

Diagram no.	Channel no.	Restricted band ?	Fundamental Value [dBuV/m]		Peak-Value at Band-Edge [dBuV/m]	Limit [dBuV/m@3m]	Margin [dB]	Verdict	Remark:
			Peak -Value	Average -Value					
9.10a_Dwn	100	no	101,68	94,69	55,9	68,5	12,6	PASS	PWR-Level 13 dBm used 6-Mbit Downward antenna
9.10b_Up	100	no	97,27	89,35	52,38	68,5	16,12	PASS	PWR-Level 13 dBm used, 6-Mbit Upward antenna
9.11a_Dwn	140	no	101,70	94,35	63,7	68,5	4,8	PASS	PWR-Level 13 dBm used 6-Mbit Downward antenna
9.11b_Up	140	no	96,10	88,36	61,1	68,5	7,4	PASS	PWR-Level 13 dBm used, 6-Mbit Upward antenna
9.08a_Dwn	149	no	99,14	91,32	58,5	68,5	10	PASS	PWR-Level 13 dBm used 6-Mbit Downward antenna
9.08b_Up	149	no	93,52	86,76	55,9	68,5	12,6	PASS	PWR-Level 13 dBm used, 6-Mbit Upward antenna
9.09_Dwn	165	no	93,01	74,00	62,5	68,5	6,0	PASS	PWR-Level 13 dBm used 6-Mbit Downward antenna
9.09_Up	165	no	89,97	70,38	55,0	68,5	13,5	PASS	PWR-Level 13 dBm used, 6-Mbit Upward antenna
9.14_Dwn	102	no	83,39	69,58	64,07	68,5	4,43	PASS	PWR-Level 8dBm used MCS0 Downward antenna
9.14_Up	102	no	81,3	71,97	60,31	68,5	8,19	PASS	PWR-Level 8dBm used MCS0 Upward antenna
9.15_Dwn	134	no	91,70	82,42	57,5	68,5	11	PASS	PWR-Level 8dBm used MCS0 Downward antenna
9.15_Up	134	no	83,34	75,36	56,0	68,5	12,5	PASS	PWR-Level 8dBm used MCS0 Upward antenna

#### 5.5.6.2. Restricted bands near-by

(§15.205 with limits accord. FCC §15.209) and (RSS-Gen, Issue 4, Chapter 8.10)

Diagram no.	Channel no.	Restricted band ?	Fundamental Value [dBuV/m]		Value at Band-Edge [dBuV/m]		Limits [dBuV/m]		Margin [dB]		Verdict	Remark:
			Peak -Value	Average -Value	Peak -Value	Average -Value	Peak -Value	Average -Value	Peak	Average		
9.06_Down	36	yes	101,03	91,43	55,0	45,0	74	54	19,0	9,0	PASS	PWR-Level 13 dBm used, 6-Mbit Downward antenna
9.06_Up	36	yes	92,92	87,5	58,0	46,0	74	54	16,0	8,0	PASS	PWR-Level 13 dBm used, 6-Mbit Upward antenna
9.07_Down	64	yes	104,48	97,0	55,05	45	74	54	18,95	9	PASS	PWR-Level 13 dBm used, 6-Mbit Downward antenna
9.07_Up	64	yes	94,13	87,5	54,0	43,0	74	54	20	11	PASS	PWR-Level 13 dBm used, 6-Mbit Upward antenna
9.15_Dwn	38	yes	97,15	89,27	55,39	46,76	74	54	18,61	7,24	PASS	PWR-Level 8dBm used, MCS0 Downward antenna
9.12_Up	38	yes	85,64	77,47	52,44	42,15	74	54	21,56	11,85	PASS	PWR-Level 8dBm used, MCS0 Upward antenna
9.16_Dwn	62	yes	96,88	88,6	56,11	44,2	74	54	17,89	9,8	PASS	PWR-Level 8dBm used, MCS0 Downward antenna
9.13_Up	62	yes	83,69	73,5	62	52,24	74	54	12	1,76	PASS	PWR-Level 8dBm used, MCS0 Upward antenna

### 5.5.7. Verdict: passed

### 5.6. Measurement uncertainties

The reported uncertainties are calculated based on the standard uncertainty multiplied with the appropriate coverage factor **k**, such that a confidence level of approximately 95% is achieved.

For uncertainty determination, each component used in the concrete measurement set-up was taken in account and it's contribution to the overall uncertainty according it's statistical distribution calculated.

Following table shows expectable uncertainties for each measurement type performed.

RF-Measurement	Reference	Frequency range	Calculated uncertainty based on a confidence level of 95%						Remarks
Conducted emissions (U <sub>CISPR</sub> )	CISPR 16-2-1	9 kHz - 150 kHz	4.0 dB						-
		150 kHz - 30 MHz	3.6 dB						
Radiated emissions Enclosure	CISPR 16-2-3	30 MHz - 1 GHz	4.2 dB						E-Field
		1 GHz - 18 GHz	5.1 dB						
Disturbance power	CISPR 16-2-2	30 MHz - 300 MHz	-						-
Power Output radiated	-	30 MHz - 4 GHz	3.17 dB						Substitution method
Power Output conducted	-	Set-up No.	Cel-C1	Cel-C2	BT1	W1	W2	--	-
		9 kHz - 12.75 GHz	N/A	0.60	0.7	0.25	N/A	--	
		12.75 - 26.5GHz	N/A	0.82	--	N/A	N/A	--	
Conducted emissions on RF-port	-	9 kHz - 2.8 GHz	0.70	N/A	0.70	N/A	0.69	--	N/A - not applicable
		2.8 GHz - 12.75GHz	1.48	N/A	1.51	N/A	1.43	--	
		12.75 GHz - 18GHz	1.81	N/A	1.83	N/A	1.77	--	
		18 GHz - 26.5GHz	1.83	N/A	1.85	N/A	1.79	--	
Occupied bandwidth	-	9 kHz - 4 GHz	0.1272 ppm (Delta Marker)						Frequency error
			1.0 dB						Power
Emission bandwidth	-	9 kHz - 4 GHz	0.1272 ppm (Delta Marker)						Frequency error
			See above: 0.70 dB						Power
Frequency stability	-	9 kHz - 20 GHz	0.0636 ppm						-
Radiated emissions Enclosure	-	150 kHz - 30 MHz	5.0 dB						Magnetic field E-field Substitution
		30 MHz - 1 GHz	4.2 dB						
		1 GHz - 20 GHz	3.17 dB						

**Table: measurement uncertainties, valid for conducted/radiated measurements**

### 6. Abbreviations used in this report

The abbreviations	
ANSI	American National Standards Institute
AV , AVG, CAV	Average detector
EIRP	Equivalent isotropically radiated power, determined within a separate measurement
EGPRS	Enhanced General Packet Radio Service
EUT	Equipment Under Test
FCC	Federal Communications Commission, USA
IC	Industry Canada
n.a.	not applicable
Op-Mode	Operating mode of the equipment
PK	Peak

RBW	resolution bandwidth
RF	Radio frequency
RSS	Radio Standards Specification, Dokuments from Industry Canada
Rx	Receiver
TCH	Traffic channel
Tx	Transmitter
QP	Quasi peak detector
VBW	Video bandwidth
ERP	Effective radiated power

## 7. Accreditation details of CETECOM's laboratories and test sites

Ref.-No.	Accreditation Certificate	Valid for laboratory area or test site	Accreditation Body
-	D-PL-12047-01-01	All laboratories and test sites of CETECOM GmbH, Essen	DAkkS, Deutsche Akkreditierungsstelle GmbH
337 487 558 348 348	MRA US-EU 0003	Radiated Measurements 30 MHz to 1 GHz, 3 m / 10 m (OATS) Radiated Measurements 30 MHz to 1 GHz, 3 m (SAR) Radiated Measurements above 1 GHz, 3 m (FAR) Mains Ports Conducted Interference Measurements Telecommunication Ports Conducted Interference Measurment.	FCC, Federal Communications Commission Laboratory Division, USA (MRA US-EU 0003)
337 487 550 558	3462D-1 3462D-2 3462D-2 3462D-3	Radiated Measurements 30 MHz to 1 GHz, 3 m / 10 m (OATS) Radiated Measurements 30 MHz to 1 GHz, 3 m (SAR) Radiated Measurements 1 GHz to 6 GHz, 3 m (SAR) Radiated Measurements above 1 GHz, 3 m (FAR)	IC, Industry Canada Certification and Engineering Bureau
487 550 348 348	R-2666 G-301 C-2914 T-1967	Radiated Measurements 30 MHz to 1 GHz, 3 m (SAR) Radiated Measurements 1 GHz to 6 GHz, 3 m (SAR) Mains Ports Conducted Interference Measurements Telecommunication Ports Conducted Interference Measurment.	VCCI, Voluntary Control Council for Interference by Information Technology Equipment, Japan

OATS = Open Area Test Site, SAR = Semi Anechoic Room, FAR = Fully Anechoic Room

## 8. Instruments and Ancillary

The “Ref.-No” in the left column of the following tables allows the clear identification of the laboratory equipment.

### 8.1. Test software and firmware of equipment

Ref.-No.	Equipment	Type	Serial-No.	Version of Firmware or Software during the test
001	EMI Test Receiver	ESS	825132/017	Firm.= 1.21 , OTP=2.0, GRA=2.0
012	Signal Generator (EMS-cond.)	SMY 01	839069/027	Firm.= V 2.02
013	Power Meter (EMS cond.)	NRVD	839111/003	Firm.= V 1.51
017	Digital Radiocommunication Tester	CMD 60 M	844365/014	Firmware = V 3.52 .22.01.99, DECT = D2.87 13.01.99
053	Audio Analyzer	UPA3	860612/022	Firm. V 4.3
119	RT Harmonics Analyzer dig. Flickermeter	B10	G60547	Firm.= V 3.1DHG
140	Signal Generator	SMHU	831314/006	Firm.= 3.21
261	Thermal Power Sensor	NRV-Z55	825083/0008	EPROM-Datum 02.12.04, SE EE 1 B
262	Power Meter	NRV-S	825770/0010	Firm.= 2.6
263	Signal Generator	SMP 04	826190/0007	Firm.=3.21
264	Spectrum Analyzer	FSEK 30	826939/005	Bios=2.1, Analyzer= 3.20
295	Racal Digital Radio Test Set	6103	1572	UNIT Firmware= 4.04, SW-Main=4.04, SW-BBP=1.04, SW-DSP=1.02, Hardboot=1.02, Softboot=2.02
298	Univ. Radio Communication Tester	CMU 200	832221/091	R&S Test Firmware =3.53 /3.54 (current Testsoftw. f. all band used
323	Digital Radiocommunication Tester	CMD 55	825878/0034	Firm.= 3.52 .22.01.99
331	Climatic Test Chamber -40/+80 Grad	HC 4055	43146	TSI 1.53
335	CTC-EMS-Conducted	System EMS Conducted	-	EMC 32 V 8.52
340	Digital Radiocommunication Tester	CMD 55	849709/037	Firm.= 3.52 .22.01.99
355	Power Meter	URV 5	891310/027	Firm.= 1.31
365	10V Insertion Unit 50 Ohm	URV5-Z2	100880	Eprom Data = 31.03.08
366	Ultra Compact Simulator	UCS 500 M4	V0531100594	Firm. UCS 500=001925/3.06a02, rc=ISMIEC 4.10
371	Bluetooth Tester	CBT32	100153	CBT V5.30+ SW-Option K55, K57
377	EMI Test Receiver	ESCS 30	100160	Firm.= 2.30, OTP= 02.01, GRA= 02.36
378	Broadband RF Field Monitor	RadiSense III	03D00013SNO-08	Firm.= V.03D13
389	Digital Multimeter	Keithley 2000	0583926	Firm. = A13 (Mainboard) A02 (Display)
392	Radio Communication Tester	MT8820A	6K00000788	Firm.= 4.50 #005, IPL=4.01#001, OS=4.02#001, GSM=4.41#013, W-CDMA= 4.54#004, scenario= 4.52#002
436	Univ. Radio Communication Tester	CMU 200	103083	R&S Test Firmware Base=5.14, Mess-Software= GSM:5.14 WCDMA:5.14 (current Testsoftw. F. all band
441	CTC-SAR-EMI Cable Loss	System EMI field (SAR)	-	EMC 32 Version 8.52
442	CTC-SAR-EMS	System EMS field (SAR)	-	EMC 32 Version 8.40
443	CTC-FAR-EMI-RSE	System CTC-FAR-EMI-RSE	-	EMC 32 Ver. 9.15.00
444	CTC-FAR-EMS field	System-EMS-Field (FAR)	-	EMC 32 Version 9.15.00
460	Univ. Radio Communication Tester	CMU 200	108901	R&S Test Firmware Base=5.14, GSM=5.14 WCDMA=5.14 (current Testsoftw.,f. all band to be used,
489	EMI Test Receiver	ESU40	1000-30	Firmware=4.43 SP3, Bios=V5.1-16-3, Spec. =01.00
491	ESD Simulator dito	ESD dito	dit0307022	V 2.30
524	Voltage Drop Simulator	VDS 200	0196-16	Software Nr: 000037 Version V4.20a01
526	Burst Generator	EFT 200 A	0496-06	Software Nr. 000034 Version V2.32
527	Micro Pulse Generator	MPG 200 B	0496-05	Software-Nr. 000030 Version V2.43
528	Load Dump Simulator	LD 200B	0496-06	Software-Nr. 000031 Version V2.35a01
546	Univ. Radio Communication Tester	CMU 200	106436	R&S Test Firmware Base=5.14, GSM=5.14 WCDMA=5.14 (current Testsoftw.,f. all band to be used
547	Univ. Radio Communication Tester	CMU 200	835390/014	R&S Test Firmware Base=V5.1403 (current Testsoftw., f. all band used, GSM = 5.14 WCDMA: = 5.14
584	Spectrum Analyzer	FSU 8	100248	2.82_SP3
597	Univ. Radio Communication Tester	CMU 200	100347	R&S Test Firmware Base=5.01, GSM=5.02 WCDMA= not installed, Mainboard= µP1=V.850
598	Spectrum Analyzer	FSEM 30 (Reserve)	831259/013	Firmware Bios 3.40 , Analyzer 3.40 Sp 2
620	EMI Test Receiver	ESU 26	100362	4.43_SP3
642	Wideband Radio Communication Tester	CMW 500	126089	Setup V03.26, Test programm component V03.02.20
692	Bluetooth Tester	CBT 32	100236	CBT V 5.40, FW: V.2.41 (FPGA Digital, V. 3.09 FPGA RF)

## 8.2. Single instruments and test systems

Ref.-No.	Equipment	Type	Serial-No.	Manufacturer	Interval of calibration	Remark	Cal due
001	EMI Test Receiver	ESS	825132/017	Rohde & Schwarz	12 M	-	31.05.2016
005	AC - LISN (50 Ohm/50µH, test site 1)	ESH2-Z5	861741/005	Rohde & Schwarz	12 M	-	31.05.2016
007	Single-Line V-Network (50 Ohm/5µH)	ESH3-Z6	892563/002	Rohde & Schwarz	12 M	-	31.05.2016
009	Power Meter (EMS-radiated)	NRV	863056/017	Rohde & Schwarz	24 M	-	30.04.2017
016	Line Impedance Simulating Network	Op. 24-D	B6366	Spitzenberger+Spies	36 M	-	31.05.2016
020	Horn Antenna 18 GHz (Subst 1)	3115	9107-3699	EMCO	36/12 M	-	31.03.2017
021	Loop Antenna (H-Field)	6502	9206-2770	EMCO	36 M	-	30.04.2018
030	Loop Antenna (H-field)	HFH-Z2	879604/026	Rohde & Schwarz	36 M	-	30.04.2018
033	RF-current probe (100kHz-30MHz)	ESH2-Z1	879581/18	Rohde & Schwarz	24 M	-	30.04.2017
057	relay-switch-unit (EMS system)	RSU	494440/002	Rohde & Schwarz	pre-m	1a	
060	power amplifier (DC-2kHz)	PAS 5000	B6363	Spitzenberger+Spies	-	3	
086	DC - power supply, 0 -10 A	LNG 50-10	-	Heinzinger Electronic	pre-m	2	
087	DC - power supply, 0 -5 A	EA-3013 S	-	Elektro Automatik	pre-m	2	
091	USB-LWL-Converter	OLS-1	007/2006	Ing. Büro Scheiba	-	4	
099	passive voltage probe	ESH2-Z3	299.7810.52	Rohde & Schwarz	36 M	-	30.04.2018
100	passive voltage probe	Probe TK 9416	without	Schwarzbeck	36 M	-	30.04.2018
110	USB-LWL-Converter	OLS-1	-	Ing. Büro Scheiba	-	4	
119	RT Harmonics Analyzer dig. Flickermeter	B10	G60547	BOCONSULT	36 M	-	31.05.2016
136	adjustable dipole antenna (Dipole 1)	3121C-DB4	9105-0697	EMCO	36 M	-	30.04.2018
140	Signal Generator	SMHU	831314/006	Rohde & Schwarz	24 M	-	31.05.2016
248	attenuator	SMA 6dB 2W	-	Radiall	pre-m	2	
249	attenuator	SMA 10dB 10W	-	Radiall	pre-m	2	
252	attenuator	N 6dB 12W	-	Radiall	pre-m	2	
256	attenuator	SMA 3dB 2W	-	Radiall	pre-m	2	
257	hybrid	4031C	04491	Narda	pre-m	2	
260	hybrid coupler	4032C	11342	Narda	pre-m	2	
261	Thermal Power Sensor	NRV-Z55	825083/0008	Rohde & Schwarz	24 M	-	31.05.2016
262	Power Meter	NRV-S	825770/0010	Rohde & Schwarz	24 M	-	31.05.2016
263	Signal Generator	SMP 04	826190/0007	Rohde & Schwarz	36 M	-	31.05.2016
264	Spectrum Analyzer	FSEK 30	826939/005	Rohde & Schwarz	12 M	-	31.05.2016
265	peak power sensor	NRV-Z33, Model 04	840414/009	Rohde & Schwarz	24 M	-	31.05.2016
266	Peak Power Sensor	NRV-Z31, Model 04	843383/016	Rohde & Schwarz	24 M	-	31.05.2016
267	notch filter GSM 850	WRCA 800/960-6EEK	9	Wainwright GmbH	pre-m	2	
270	termination	1418 N	BB6935	Weinschel	pre-m	2	
271	termination	1418 N	BE6384	Weinschel	pre-m	2	
272	attenuator (20 dB) 50 W	Model 47	BF6239	Weinschel	pre-m	2	
273	attenuator (10 dB) 100 W	Model 48	BF9229	Weinschel	pre-m	2	
274	attenuator (10 dB) 50 W	Model 47 (10 dB) 50 W	BG0321	Weinschel	pre-m	2	
275	DC-Block	Model 7003 (N)	C5129	Weinschel	pre-m	2	
276	DC-Block	Model 7006 (SMA)	C7061	Weinschel	pre-m	2	
279	power divider	1515 (SMA)	LH855	Weinschel	pre-m	2	
298	Univ. Radio Communication Tester	CMU 200	832221/091	Rohde & Schwarz	pre-m	3	
300	AC LISN (50 Ohm/50µH, 1-phase)	ESH3-Z5	892 239/020	Rohde & Schwarz	12 M	-	31.05.2016
301	attenuator (20 dB) 50W, 18GHz	47-20-33	AW0272	Lucas Weinschel	pre-m	2	
302	horn antenna 40 GHz (Meas 1)	BBHA9170	155	Schwarzbeck	36 M	-	31.03.2017
303	horn antenna 40 GHz (Subst 1)	BBHA9170	156	Schwarzbeck	36 M	-	31.03.2017
331	Climatic Test Chamber -40/+80 Grad	HC 4055	43146	Heraeus Vötsch	24 M	-	30.12.2016
341	Digital Multimeter	Fluke 112	81650455	Fluke	24 M	-	31.05.2016
342	Digital Multimeter	Voltcraft M-4660A	IB 255466	Voltcraft	24 M	-	30.04.2017
347	laboratory site	radio lab.	-	-	-	5	
348	laboratory site	EMI conducted	-	-	-	5	
354	DC - Power Supply 40A	NGPE 40/40	448	Rohde & Schwarz	pre-m	2	
355	Power Meter	URV 5	891310/027	Rohde & Schwarz	24 M	-	31.05.2016
357	power sensor	NRV-Z1	861761/002	Rohde & Schwarz	24 M	-	30.04.2017
371	Bluetooth Tester	CBT32	100153	R&S	24 M	-	31.05.2016
373	Single-Line V-Network (50 Ohm/5µH)	ESH3-Z6	100535	Rohde & Schwarz	24 M	-	30.04.2017
377	EMI Test Receiver	ESCS 30	100160	Rohde & Schwarz	12 M	-	31.05.2016
389	Digital Multimeter	Keithley 2000	0583926	Keithley	24 M	-	30.04.2017
392	Radio Communication Tester	MT8820A	6K00000788	Anritsu	12 M	-	31.05.2016
431	Model 7405	Near-Field Probe Set	9305-2457	EMCO	-	4	
436	Univ. Radio Communication Tester	CMU 200	103083	Rohde & Schwarz	12 M	-	31.05.2016
439	UltraLog-Antenna	HL 562	100248	Rohde & Schwarz	36 M	-	31.03.2017
441	CTC-SAR-EMI Cable Loss	System EMI field (SAR) Cable	-	CETECOM	12 M	5	30.01.2016
443	CTC-FAR-EMI-RSE	System CTC-FAR-EMI-RSE	-	ETS-Lindgren / CETECOM	12 M	5	30.09.2016
454	Oscilloscope	HM 205-3	9210 P 29661	Hameg	-	4	
456	DC-Power supply 0-5 A	EA 3013 S	207810	Elektro Automatik	pre-m	2	
459	DC -Power supply 0-5 A , 0-32 V	EA-PS 2032-50	910722	Elektro Automatik	pre-m	2	

Ref.-No.	Equipment	Type	Serial-No.	Manufacturer	Interval of calibration	Remark	Cal due
460	Univ. Radio Communication Tester	CMU 200	108901	Rohde & Schwarz	12 M	-	31.05.2016
463	Universal source	HP3245A	2831A03472	Agilent	-	4	
466	Digital Multimeter	Fluke 112	89210157	Fluke USA	24 M	-	31.05.2016
467	Digital Multimeter	Fluke 112	89680306	Fluke USA	36 M	-	30.04.2018
468	Digital Multimeter	Fluke 112	90090455	Fluke USA	36 M	-	30.04.2018
477	ReRadiating GPS-System	AS-47	-	Automotive Cons. Fink	-	3	
480	power meter (Fula)	NRVS	838392/031	Rohde & Schwarz	24 M	-	30.04.2017
482	filter matrix	Filter matrix SAR 1	-	CETECOM (Brl)	-	Id	
484	pre-amplifier 2,5 - 18 GHz	AMF-5D-02501800-25-10P	1244554	Miteq	12 M	-	30.09.2016
487	System CTC NSA-Verification SAR-EMI	System EMI field (SAR) NSA	-	ETS Lindgren / CETECOM	24 M	-	31.07.2017
489	EMI Test Receiver	ESU40	1000-30	Rohde & Schwarz	12 M	-	31.05.2016
502	band reject filter	WRCG 1709/1786-1699/1796-	SN 9	Wainwright	pre-m	2	
503	band reject filter	WRCG 824/849-814/859-	SN 5	Wainwright	pre-m	2	
517	relais switch matrix	HF Relais Box Keithley	SE 04	Keithley	pre-m	2	
523	Digital Multimeter	L4411A	MY46000154	Agilent	24 M	-	30.04.2017
529	6 dB Broadband resistive power divider	Model 1515	LH 855	Weinschel	pre-m	2	
530	10 dB Broadband resistive power divider	R 416110000	LOT 9828	-	pre-m	2	
546	Univ. Radio Communication Tester	CMU 200	106436	R&S	12 M	-	31.05.2016
547	Univ. Radio Communication Tester	CMU 200	835390/014	Rohde & Schwarz	12 M	-	31.05.2016
548	Digital-Barometer	GBP 2300	without	Greisinger GmbH	-	-	
549	Log.Per-Antenna	HL025	1000060	Rohde & Schwarz	36 M	-	31.07.2018
552	high pass filter 2,8-18GHz	WHKX 2.8/18G-10SS	4	Wainwright	12 M	1c	30.09.2016
574	Biconilog Hybrid Antenna	BTA-L	980026L	Frankonia	36/12 M	-	31.05.2016
584	Spectrum Analyzer	FSU 8	100248	Rohde & Schwarz	pre-m	-	
594	Wideband Radio Communication Tester	CMW 500	101757	Rohde & Schwarz	12 M	-	31.05.2016
597	Univ. Radio Communication Tester	CMU 200	100347	Rohde & Schwarz	36 M	-	31.05.2016
598	Spectrum Analyzer	FSEM 30 (Reserve)	831259/013	Rohde & Schwarz	24 M	-	30.04.2017
600	power meter	NRVD (Reserve)	834501/018	Rohde & Schwarz	24 M	-	30.04.2017
601	medium-sensitivity diode sensor	NRV-Z5 (Reserve)	8435323/003	Rohde & Schwarz	24 M	-	30.04.2017
602	peak power sensor	NRV-Z32 (Reserve)	835080	Rohde & Schwarz	24 M	-	
611	DC power supply	E3632A	KR 75305854	Agilent	pre-m	2	
612	DC power supply	E3632A	MY 40001321	Agilent	pre-m	2	
613	Attenuator	R416120000 20dB 10W	Lot. 9828	Radiall	pre-m	2	
616	Digitalmultimeter	Fluke 177	88900339	Fluke	24 M	-	31.05.2016
617	Power Splitter/Combiner	ZFSC-2-2-S+	S F987001108	Mini Circuits	-	2	
618	Power Splitter/Combiner	50PD-634	600994	JFW Industries USA	-	2	
619	Power Splitter/Combiner	50PD-634	600995	JFW Industries, USA	-	3	
621	Step Attenuator 0-139 dB	RSP	100017	Rohde & Schwarz	pre-m	2	
625	Generic Test Load USB	Generic Test Load USB	-	CETECOM	-	2	
627	data logger	OPUS 1	201.0999.9302.6.4.1.4 3	G. Lufft GmbH	24 M	-	30.04.2017
634	Spectrum Analyzer	FSM (HF-Unit)	826188/010	Rohde & Schwarz	pre-m	2	
637	High Speed HDMI with Ethernet 1m	HDMI cable with Ethernet 1m	-	Kogilink	-	2	
638	HDMI Kabel with Ethernet 1,5 m flach	HDMI cable with Ethernet	-	Reichelt	-	2	
640	HDMI cable 2m rund	HDMI cable 2m rund	-	Reichelt	-	2	
641	HDMI cable with Ethernet	Certified HDMI cable with	-	PureLink	-	2	
642	Wideband Radio Communication Tester	CMW 500	126089	Rohde&Schwarz	12 M	-	31.05.2016
644	Amplifierer	ZX60-2534M+	SN865701299	Mini-Circuits	-	-	
670	Univ. Radio Communication Tester	CMU 200	106833	Rohde & Schwarz	24 M	-	31.05.2016
671	DC-power supply 0-5 A	EA-3013S	-	Elektro Automatik	pre-m	2	
678	Power Meter	NRP	101638	Rohde&Schwarz	pre-m	-	
683	Spectrum Analyzer	FSU 26	200571	Rohde & Schwarz	12 M	-	31.05.2016
686	Field Analyzer	EHP-200A	160WX30702	Narda Safety Test Solutions	24 M	-	30.04.2017
687	Signal Generator	SMF 100A	102073	Rohde&Schwarz	12 M	-	31.05.2016
688	Pre Amp	JS-18004000-40-8P	1750117	Miteq	pre-m	-	
692	Bluetooth Tester	CBT 32	100236	Rohde & Schwarz	24 M	-	31.05.2016
697	Power Splitter	ZN4PD-642W-S+	165001445	Mini-Circuits	-	2	

### 8.2.1. Legend

Note / remarks	Calibrated during system calibration:	
1a	System CTC-SAR-EMS (Ref.-No. 442)	
1b	System-CTC-EMS-Conducted (Ref.-No. 335)	
1c	System CTC-FAR-EMI-RSE (Ref.-No. 443)	
1d	System CTC-SAR-EMI (Ref.-No. 441)	
1e	System CTC-OATS (EMI radiated) (Ref.-No. 337)	
1 f	System CTC-CTIA-OTA (Ref.-No. 420)	
1 g	System CTC-FAR-EMS (Ref.-No. 444)	
2	Calibration or equipment check immediately before measurement	
3	Regulatory maintained equipment for functional check or support purpose	
4	Ancillary equipment without calibration e.g. mechanical equipment or monitoring equipment	
5	Test System	

Interval of calibration	12 M	12 month
	24 M	24 month
	36 M	36 month
	24/12 M	Calibration every 24 months, between this every 12 months internal validation
	36/12 M	Calibration every 36 months, between this every 12 months internal validation
	Pre-m	Check before starting the measurement
	-	Without calibration

## 9. Versions of test reports (change history)

Version	Applied changes	Date of release
--	Initial release	2016-04-20
--	--	--