

TESTED SAMPLES:	S/01
TESTED CONDITIONS MODES:	TC#03
TEST RESULTS:	PASS

WCDMA Modulation

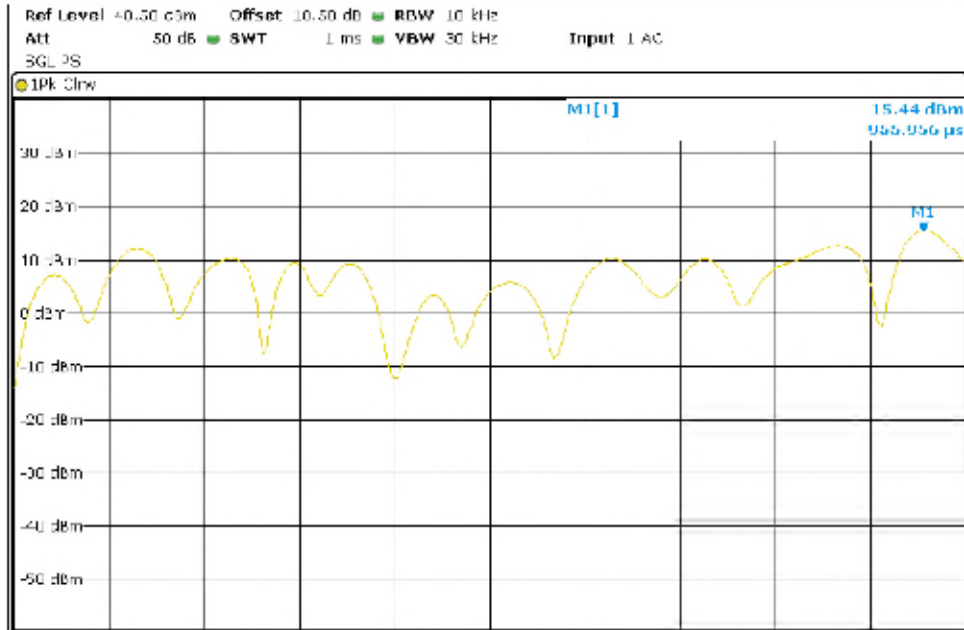

TEST A3: FREQUENCY STABILITY

LIMITS:	Product standard:	FCC Part 22 / IC RSS-132
	Test standard:	FCC §2.1055 and § 22.355 / RSS-132 Clause 5.3

LIMITS

The frequency stability shall be enough to ensure that the fundamental emissions stay within the authorized bands of operation.

TEST SETUP

The frequency tolerance measurements over temperature variations were made over the temperature range of -30°C to $+50^{\circ}\text{C}$. The EUT was placed inside a climatic chamber and the temperature was raised hourly in 10°C steps from -30°C up to $+50^{\circ}\text{C}$.

The supply voltage was varied between 85% and 115% of nominal voltage.

The EUT was set in "call mode" in the middle channel using the Universal Radio Communication Tester R&S CMW500 and the maximum frequency error was measured using the built-in calibrated frequency meter.

For LTE mode the QPSK modulation was used for the test as it is the worst case for conducted power.

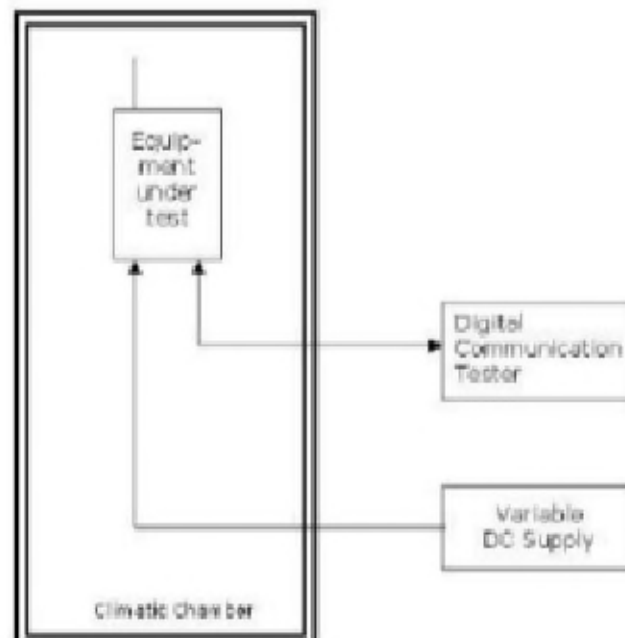

TESTED SAMPLES:	S/01
TESTED CONDITIONS MODES:	TC#01
TEST RESULTS:	PASS

LTE QPSK MODULATION. BW = 3 MHz

Frequency stability over temperature variations

Temperature (°C)	Frequency Error (Hz)	Frequency Error (ppm)	Frequency Error (%)
50	2.03	0.0024	0.00000024
40	-2.33	-0.0028	-0.00000028
30	0.83	0.0010	0.00000010
20	1.82	0.0022	0.00000022
10	1.54	0.0018	0.00000018
0	3.96	0.0047	0.00000047
-10	0.82	0.0010	0.00000010
-20	1.34	0.0016	0.00000016
-30	5.08	0.0061	0.00000061

Frequency stability over voltage variations

Battery Supply voltage	Voltage (V)	Frequency Error (Hz)	Frequency Error (ppm)	Frequency Error (%)
Vmax	4.37	-4.49	-0.0054	-0.00000054
Vmin	3.23	-4.42	-0.0053	-0.00000053

TESTED SAMPLES:	S/01
TESTED CONDITIONS MODES:	TC#02
TEST RESULTS:	PASS

GPRS MODULATION

Frequency stability over temperature variations

Temperature (°C)	Frequency Error (Hz)	Frequency Error (ppm)	Frequency Error (%)
50	20.1	0.0240	0.00000240
40	17.34	0.0207	0.00000207
30	22.22	0.0266	0.00000266
20	16.75	0.0224	0.00000224
10	21.57	0.0258	0.00000258
0	16.35	0.0195	0.00000195
-10	21.1	0.0252	0.00000252
-20	20.96	0.0251	0.00000251
-30	23.27	0.0278	0.00000278

Frequency stability over voltage variations

Battery Supply voltage	Voltage (V)	Frequency Error (Hz)	Frequency Error (ppm)	Frequency Error (%)
Vmax	4.37	15.35	0.0183	0.00000183
Vmin	3.23	14.01	0.0167	0.00000167

TESTED SAMPLES:	S/01
TESTED CONDITIONS MODES:	TC#03
TEST RESULTS:	PASS

WCDMA MODULATION

Frequency stability over temperature variations

Temperature (°C)	Frequency Error (Hz)	Frequency Error (ppm)	Frequency Error (%)
50	-0.58	0.0145	0.00000145
40	-1.27	0.0133	0.00000133
30	-1.18	0.0108	0.00000108
20	2.65	0.0108	0.00000108
10	0.09	0.0129	0.00000128
0	0.24	-0.0143	-0.00000143
-10	1.56	-0.0062	-0.00000062
-20	-0.94	0.0236	0.00000236
-30	0.46	0.0159	0.00000159

Frequency stability over voltage variations

Battery Supply voltage	Voltage (V)	Frequency Error (Hz)	Frequency Error (ppm)	Frequency Error (%)
Vmax	4.37	0.49	-0.0087	-0.00000087
Vmin	3.23	1.1	0.0147	0.00000147

TEST A4: OCCUPIED BANDWIDTH

LIMITS:	Product standard:	FCC Part 22 / IC RSS-132
	Test standard:	FCC § 2.1049/ RSS-132 Clause 5.1

LIMITS

Reference only.

TEST SETUP

The occupied bandwidth measurement was performed at the output terminals of the EUT using an attenuator, power splitter and spectrum analyzer. The EUT was controlled via the Universal Radio Communication Tester R&S CMW500 selecting maximum transmission power of the EUT and different modes of modulation. The 99% occupied bandwidth and the -26 dBc bandwidth were measured directly using the built-in bandwidth measuring option of spectrum analyzer.

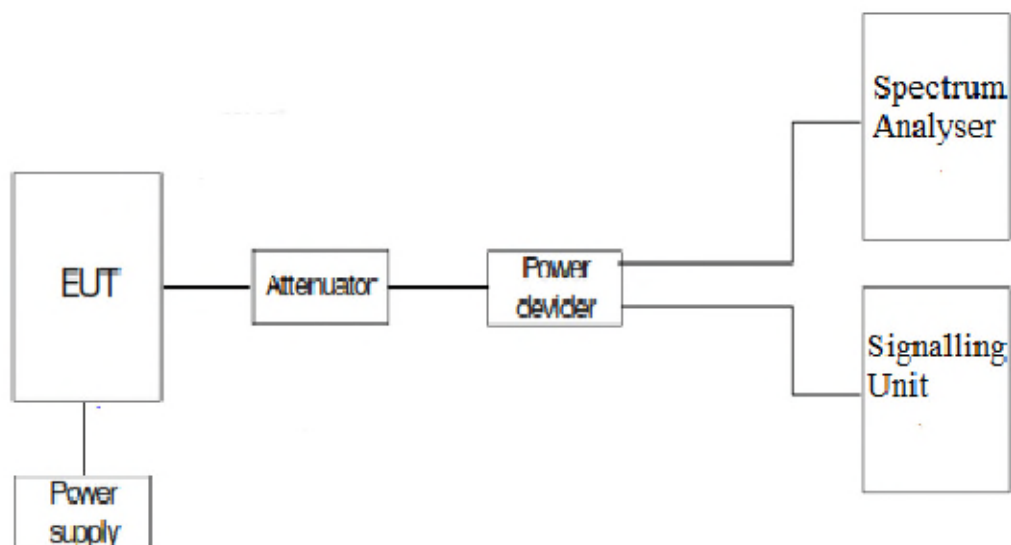

TESTED SAMPLES:	S/01
TESTED CONDITIONS MODES:	TC#01
TEST RESULTS:	PASS

LTE QPSK MODULATION. BW = 1.4 MHz

Channel	Lowest	Middle	Highest
99% Occupied bandwidth (MHz)	1.11	1.12	1.11
-26 dBc bandwidth (MHz)	1.28	1.28	1.27

LTE 16QAM MODULATION. BW = 1.4 MHz

Channel	Lowest	Middle	Highest
99% Occupied bandwidth (MHz)	1.10	1.11	1.11
-26 dBc bandwidth (MHz)	1.27	1.28	1.28

LTE QPSK MODULATION. BW = 3 MHz

Channel	Lowest	Middle	Highest
99% Occupied bandwidth (MHz)	2.74	2.74	2.74
-26 dBc bandwidth (MHz)	3.12	3.08	3.08

LTE 16QAM MODULATION. BW = 3 MHz

Channel	Lowest	Middle	Highest
99% Occupied bandwidth (MHz)	2.74	2.73	2.73
-26 dBc bandwidth (MHz)	3.11	3.09	3.08

LTE QPSK MODULATION. BW = 5 MHz

Channel	Lowest	Middle	Highest
99% Occupied bandwidth (MHz)	4.58	4.57	4.58
-26 dBc bandwidth (MHz)	5.18	5.15	5.15

TEST RESULTS (Cont):

LTE 16QAM MODULATION. BW = 5 MHz

Channel	Lowest	Middle	Highest
99% Occupied bandwidth (MHz)	4.58	4.57	4.58
-26 dBc bandwidth (MHz)	5.15	5.15	5.17

LTE QPSK MODULATION. BW = 10 MHz

Channel	Lowest	Middle	Highest
99% Occupied bandwidth (MHz)	8.98	8.98	9.02
-26 dBc bandwidth (MHz)	9.96	9.87	9.96

LTE 16QAM MODULATION. BW = 10 MHz

Channel	Lowest	Middle	Highest
99% Occupied bandwidth (MHz)	8.98	8.98	8.98
-26 dBc bandwidth (MHz)	9.96	9.90	9.87

LTE QPSK MODULATION. BW = 1.4 MHz

Lowest Channel 99% Occupied Bandwidth

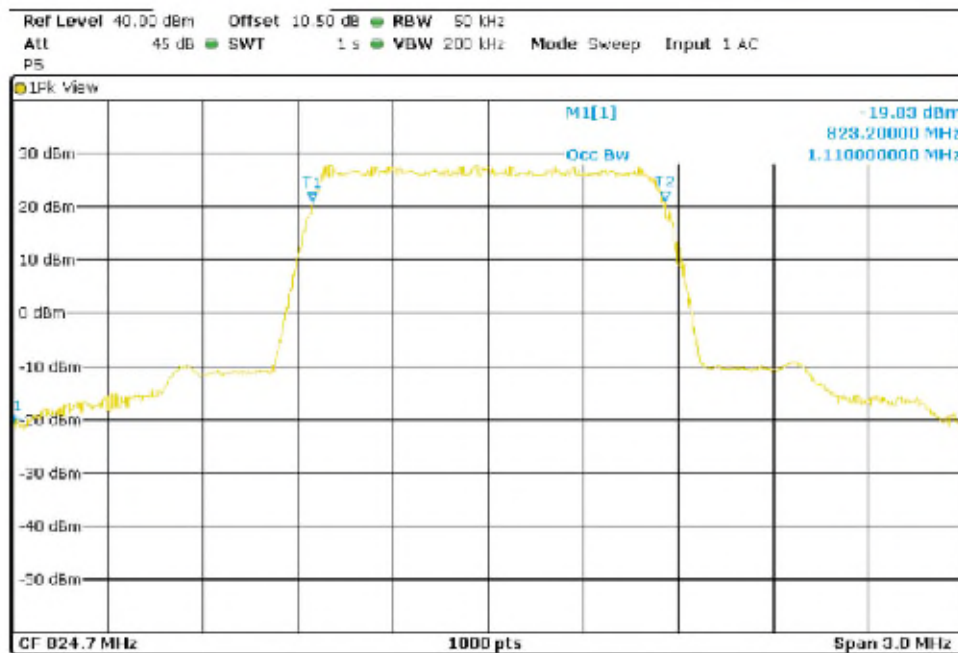

TEST RESULTS (Cont):

Lowest Channel -26dBc Bandwidth kHz

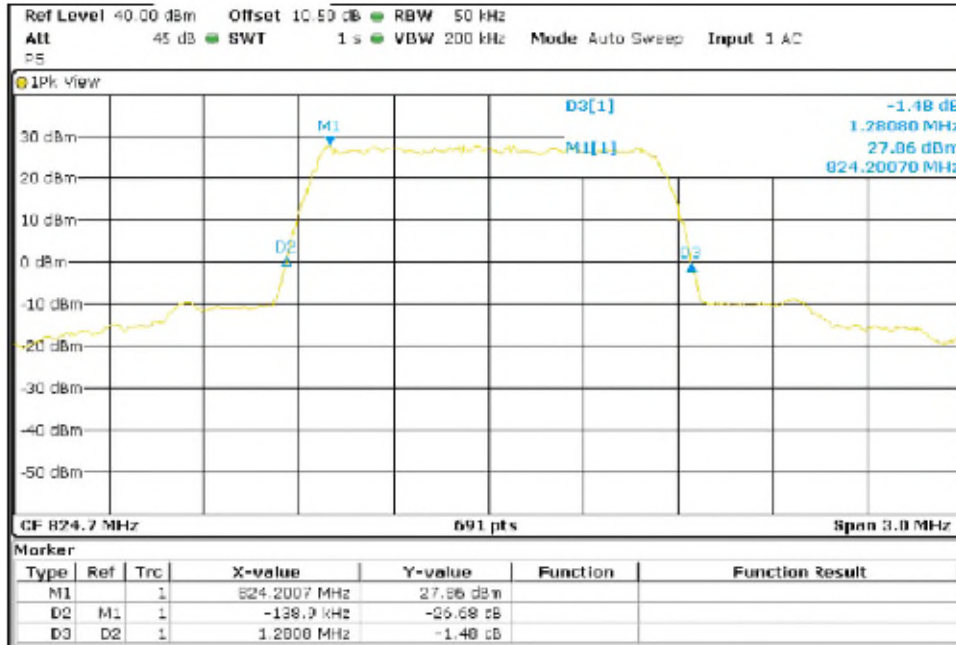

Middle Channel 88% Occupied Bandwidth

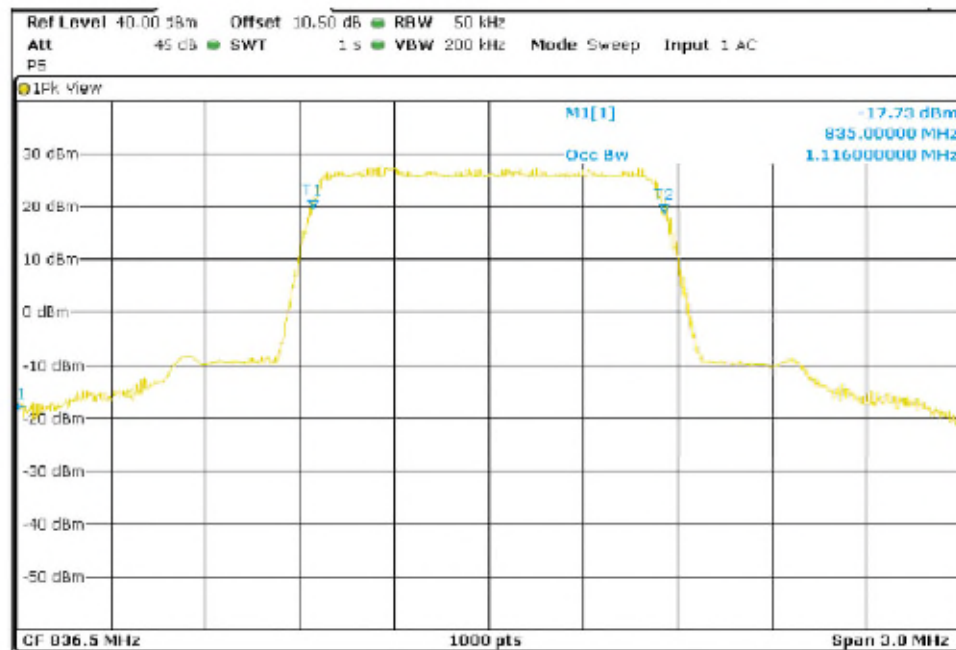

TEST RESULTS (Conf):

Middle Channel 26dBc Bandwidth kHz

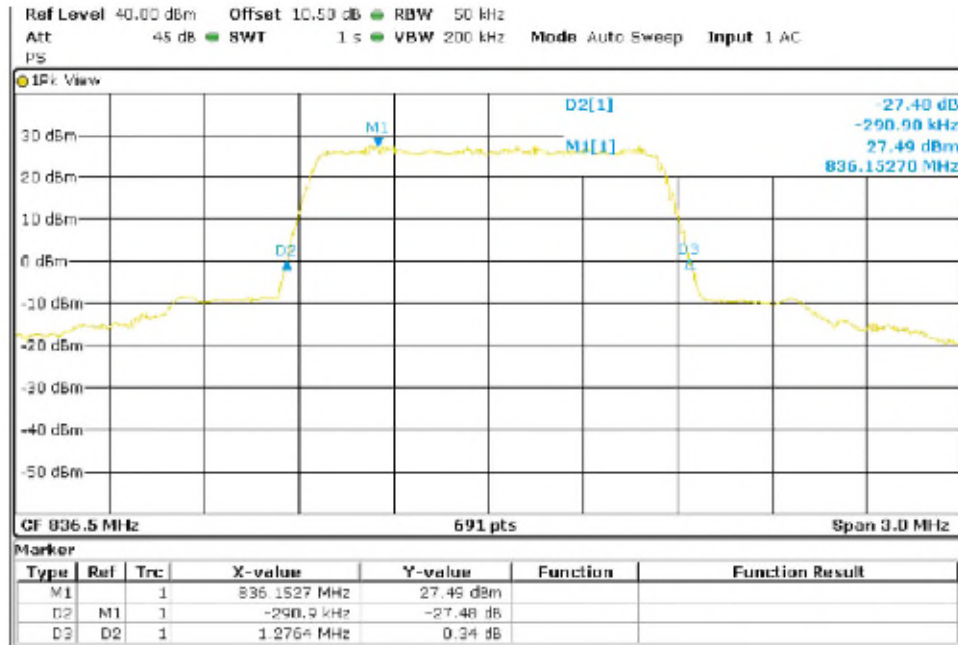

Highest Channel 99% Occupied Bandwidth

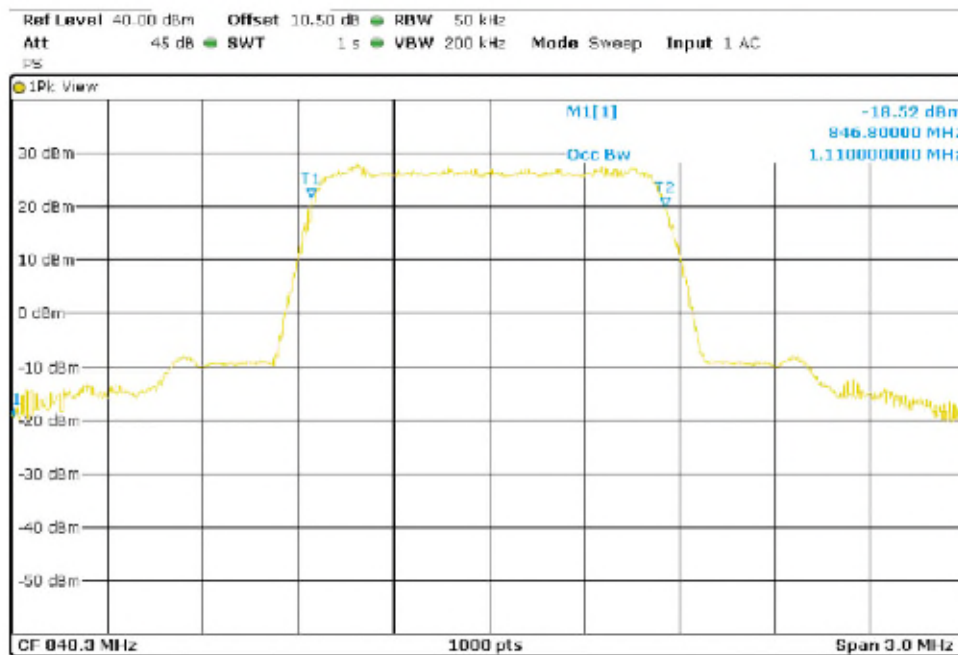

TEST RESULTS (Cont):

Highest Channel 26dBc Bandwidth kHz

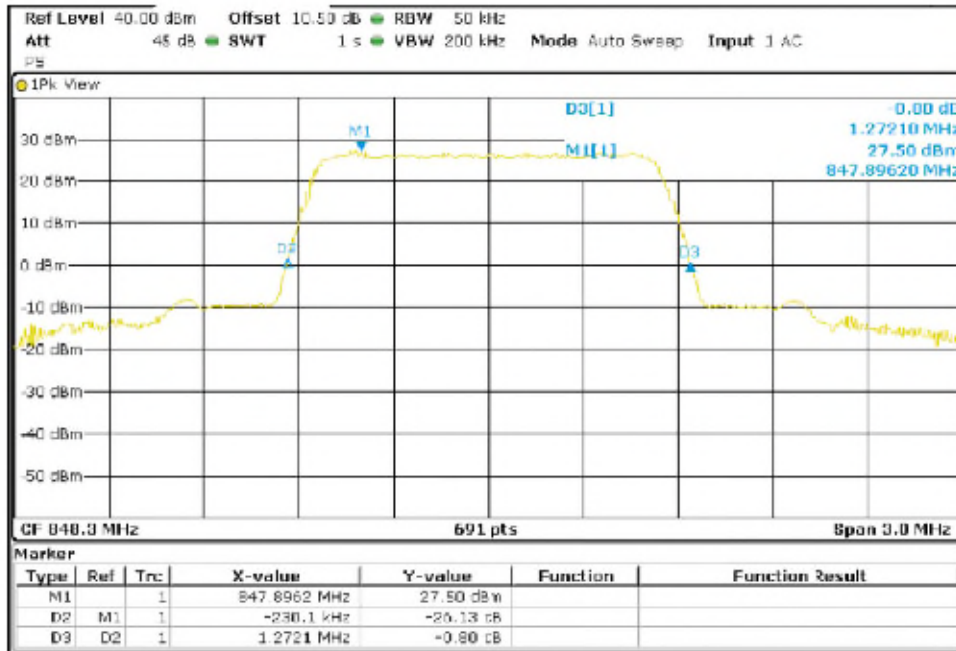

LTE 16QAM MODULATION. BW = 1.4 MHz

Lowest Channel 99% Occupied Bandwidth

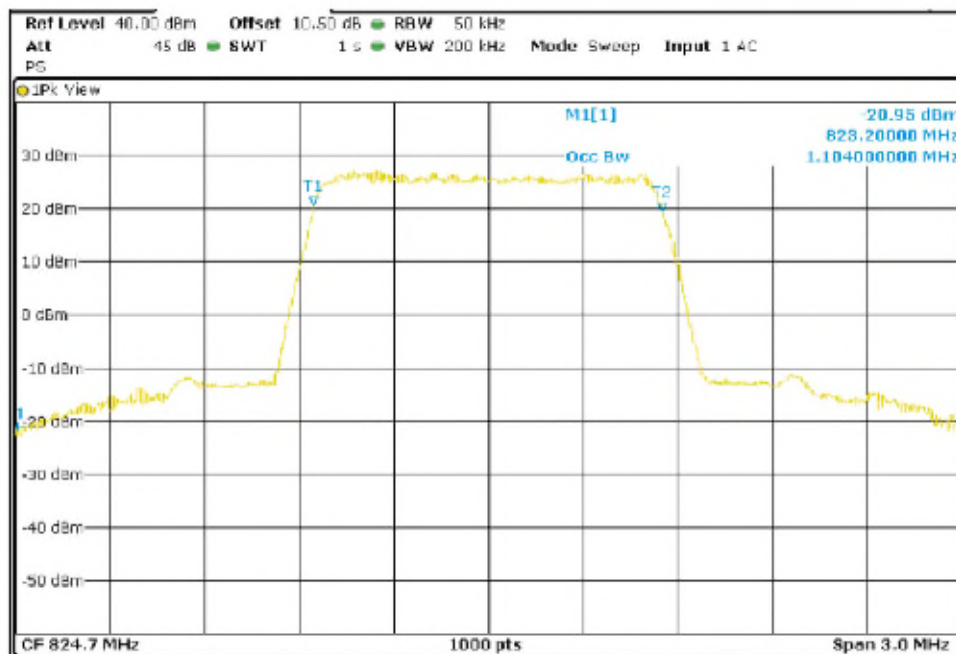

TEST RESULTS (Cont):

Lowest Channel -26dBc Bandwidth kHz

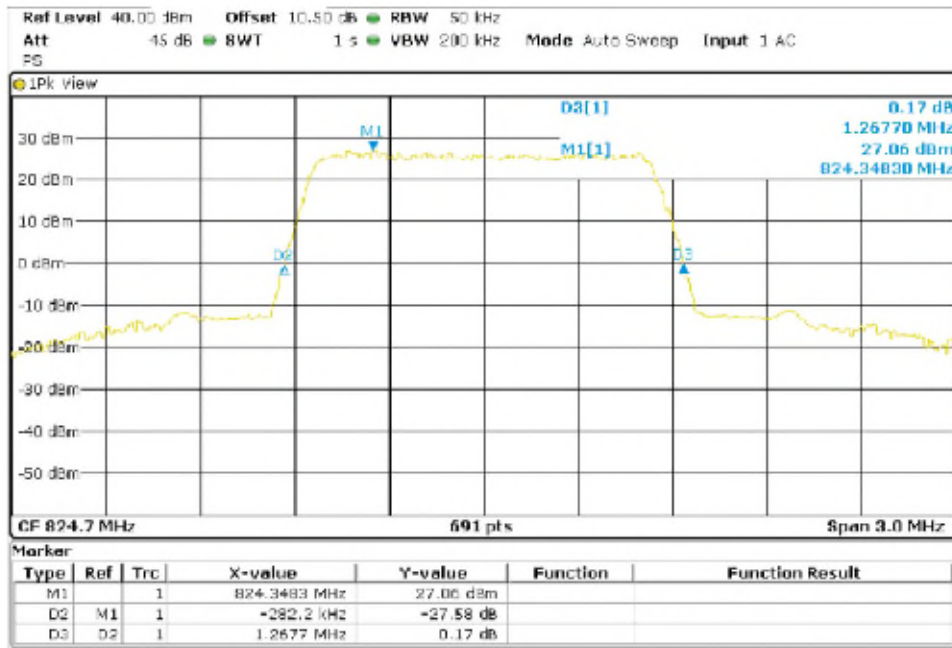

Middle Channel 99% Occupied Bandwidth

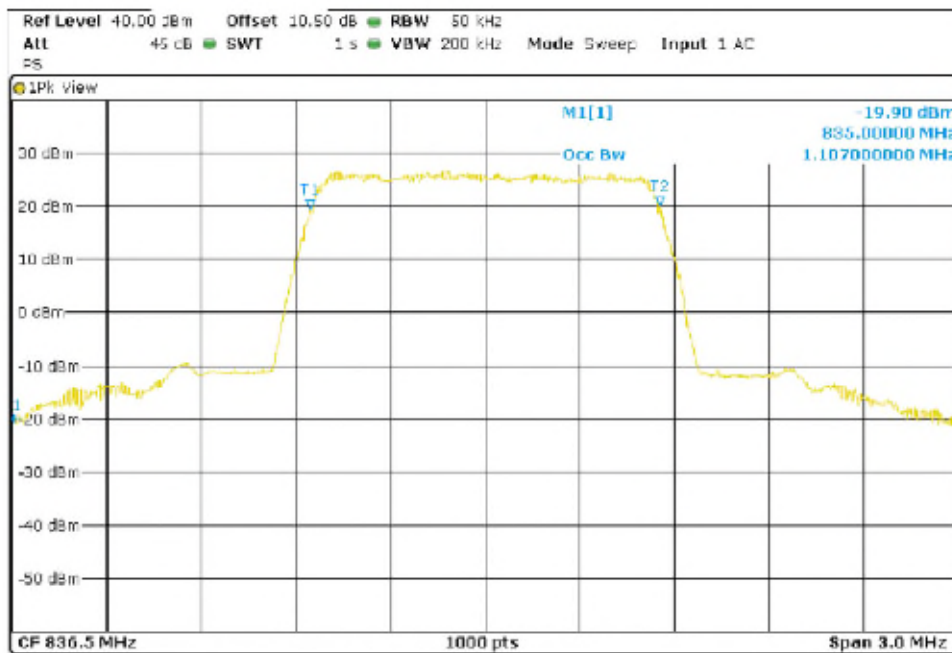

TEST RESULTS (Cont):

Middle Channel 26dBc Bandwidth kHz

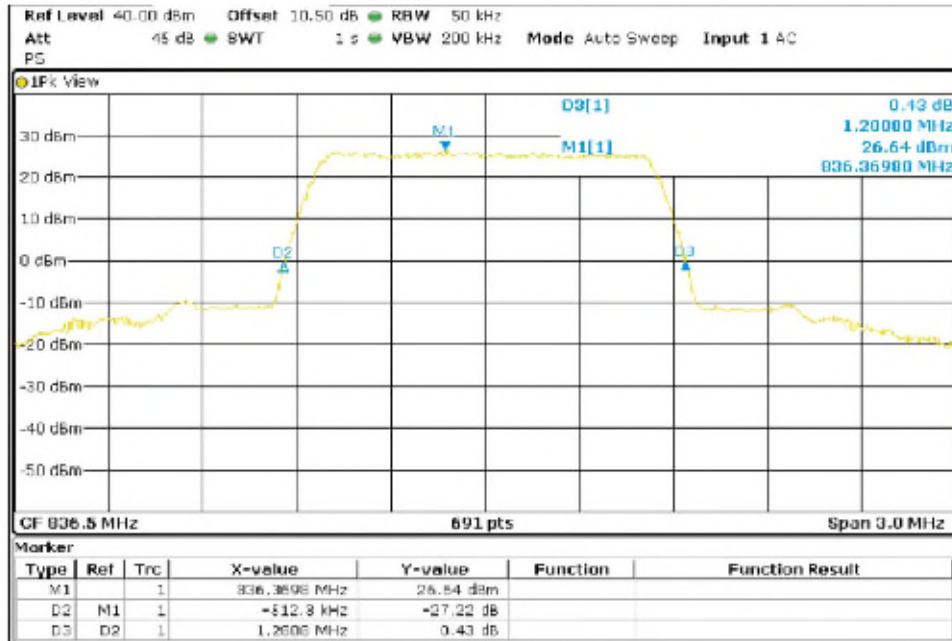

Highest Channel 99% Occupied Bandwidth

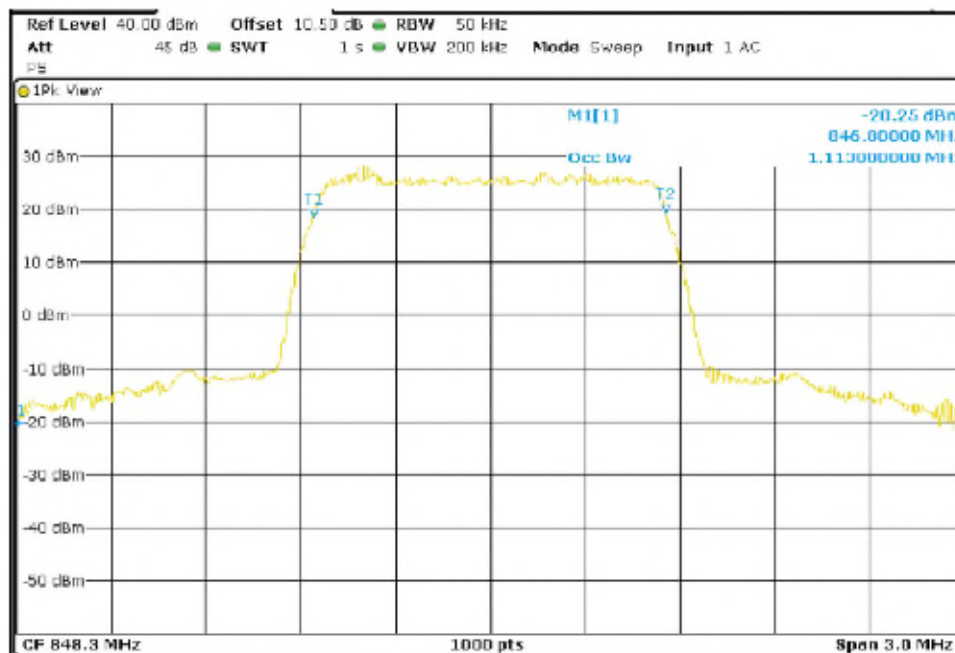

TEST RESULTS (Cont):

Highest Channel 26dBc Bandwidth kHz

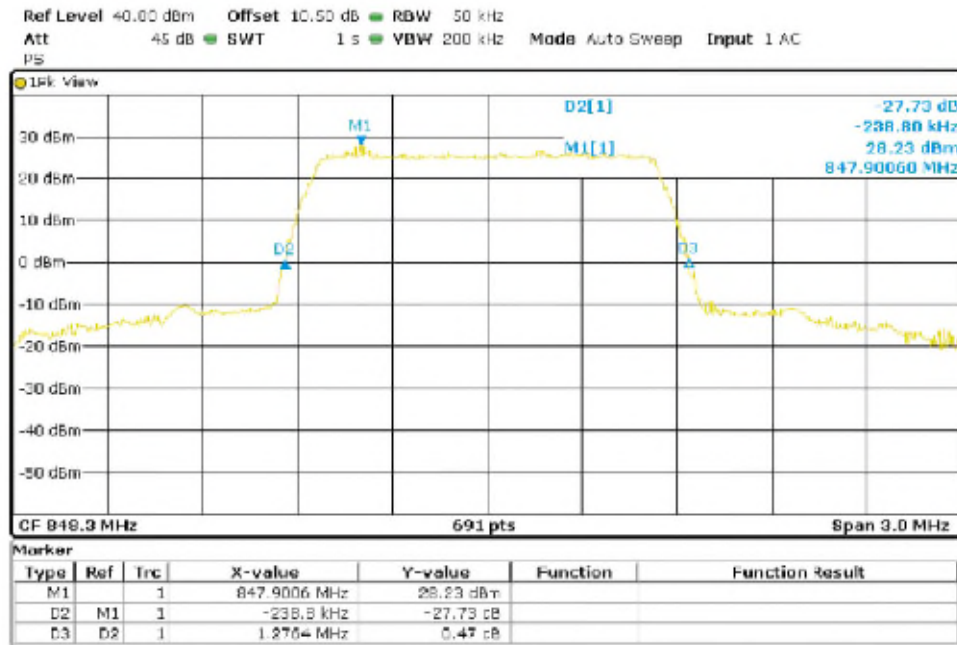

LTE QPSK MODULATION. BW = 3 MHz

Lowest Channel 99% Occupied Bandwidth

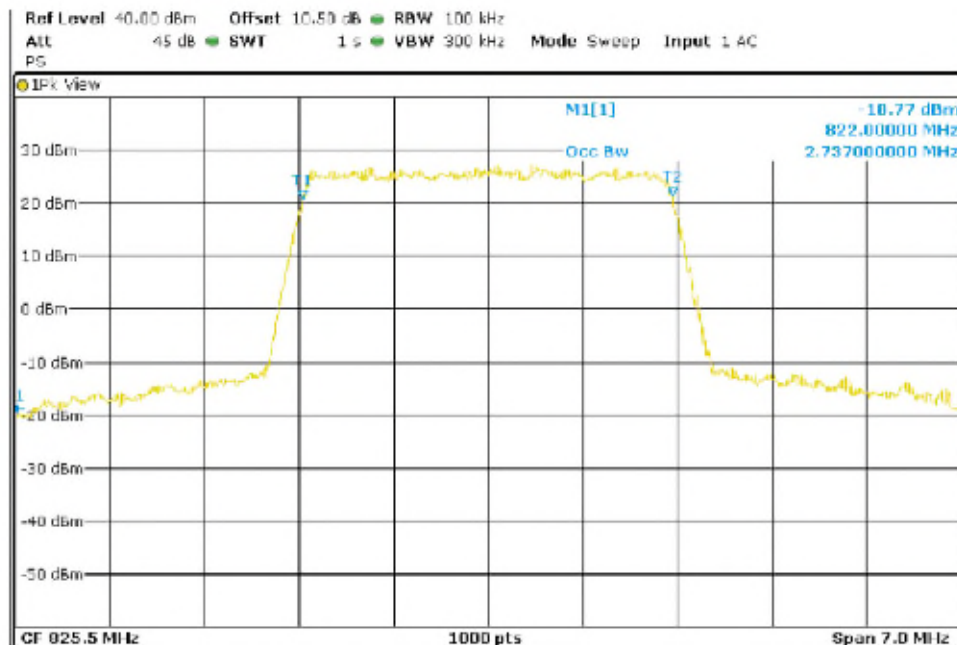

TEST RESULTS (Cont):

Lowest Channel -26dBc Bandwidth kHz

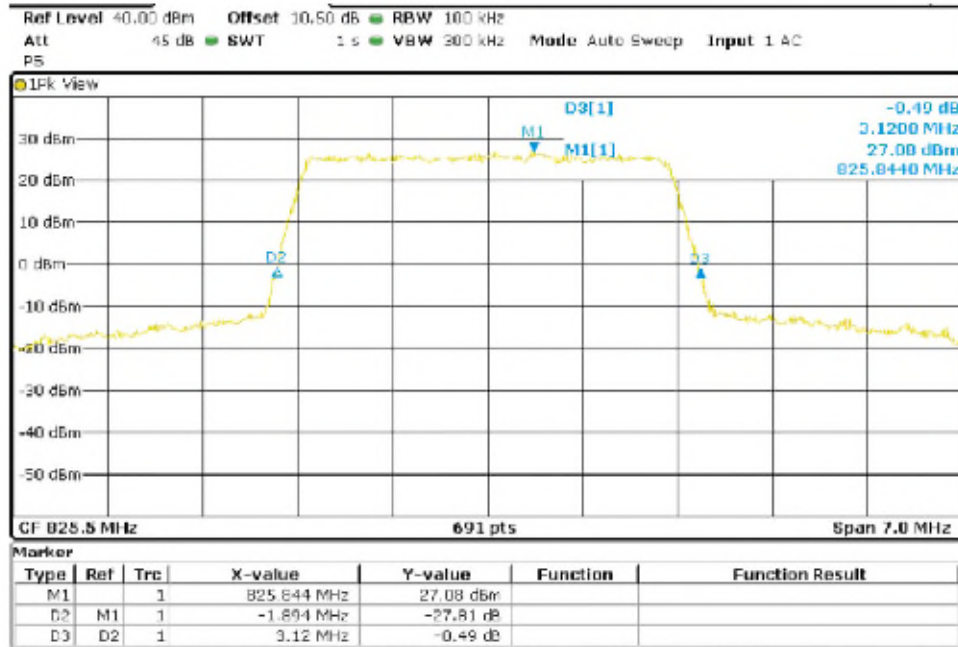

Middle Channel 99% Occupied Bandwidth

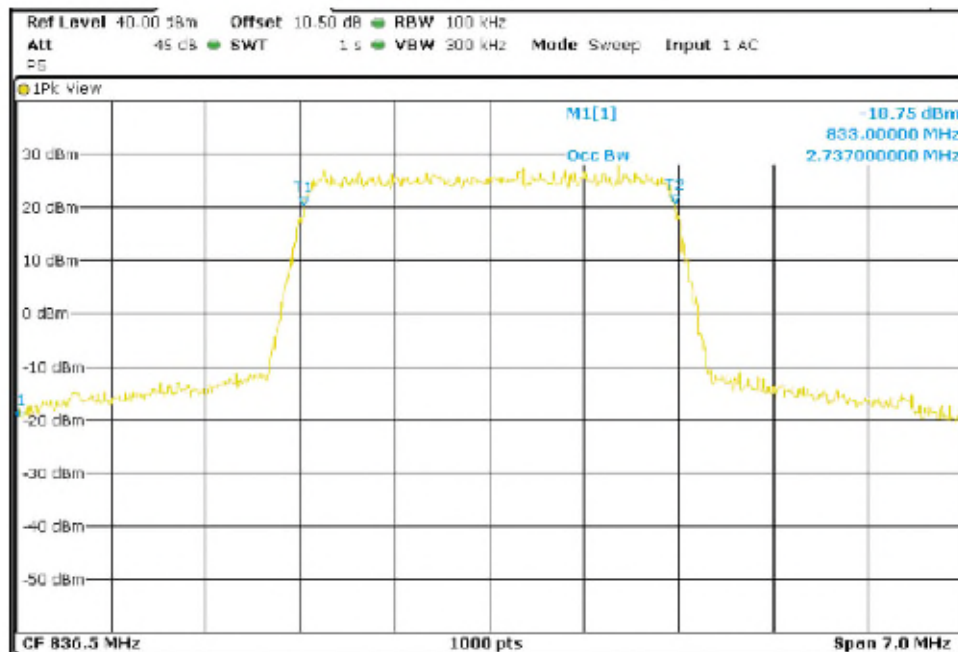

TEST RESULTS (Cont):

Middle Channel 26dBc Bandwidth kHz

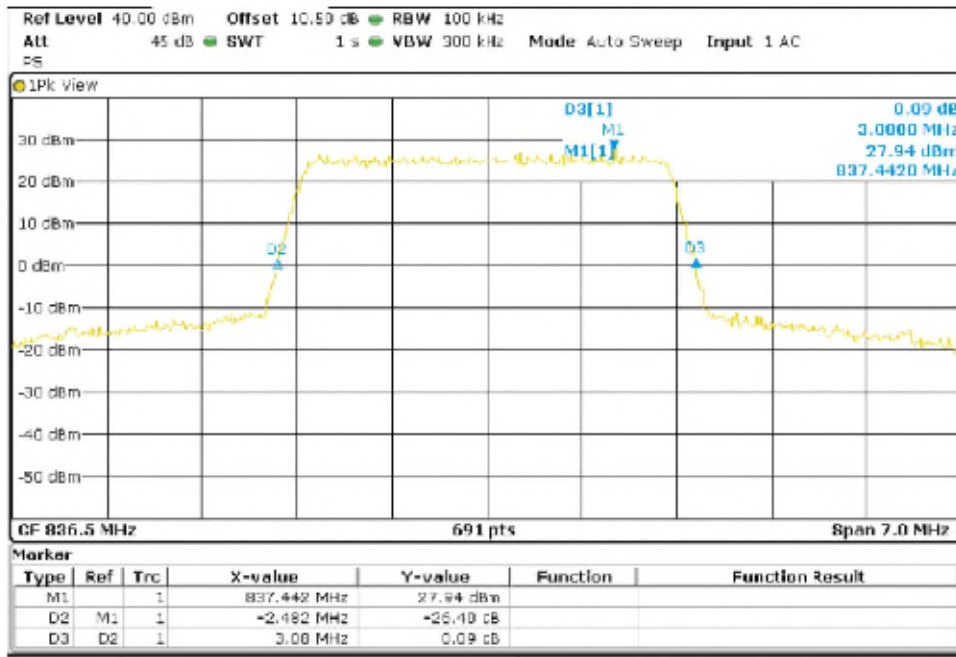

Highest Channel 99% Occupied Bandwidth

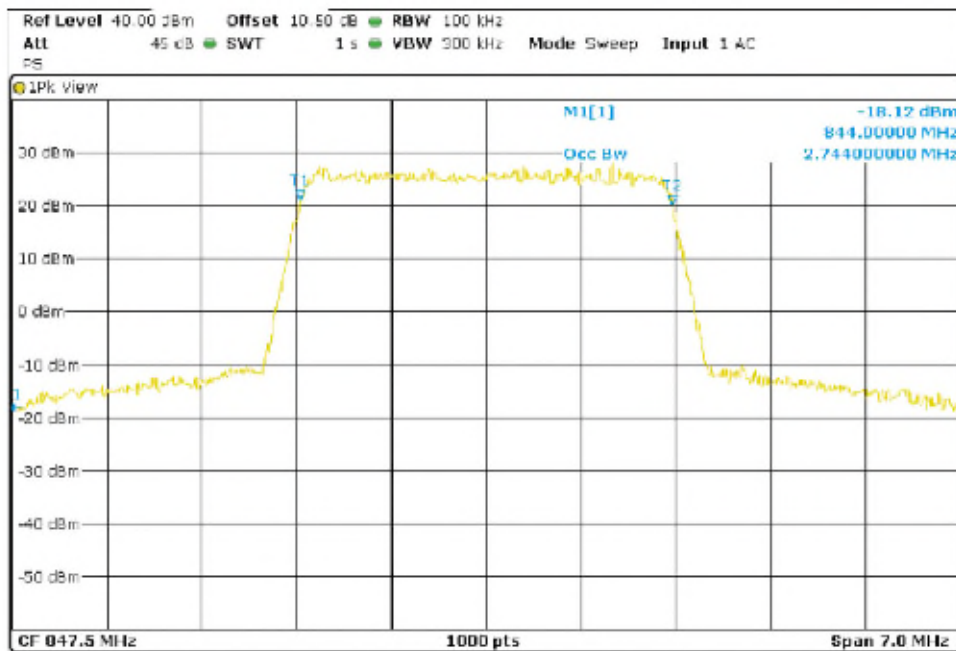

TEST RESULTS (Cont):

Highest Channel 26dBc Bandwidth kHz

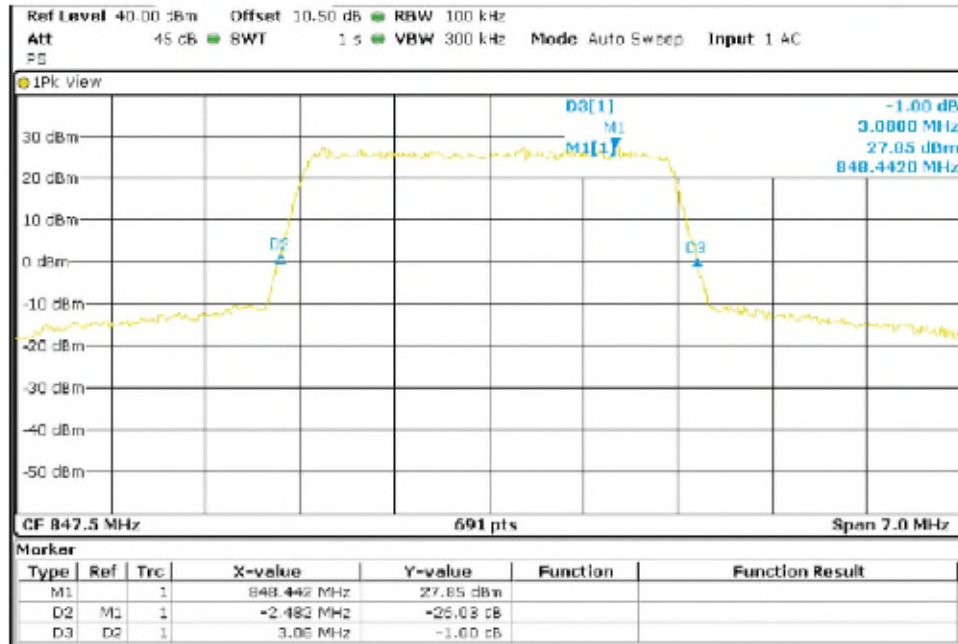

LTE 16QAM MODULATION. BW = 3 MHz

Lowest Channel 99% Occupied Bandwidth

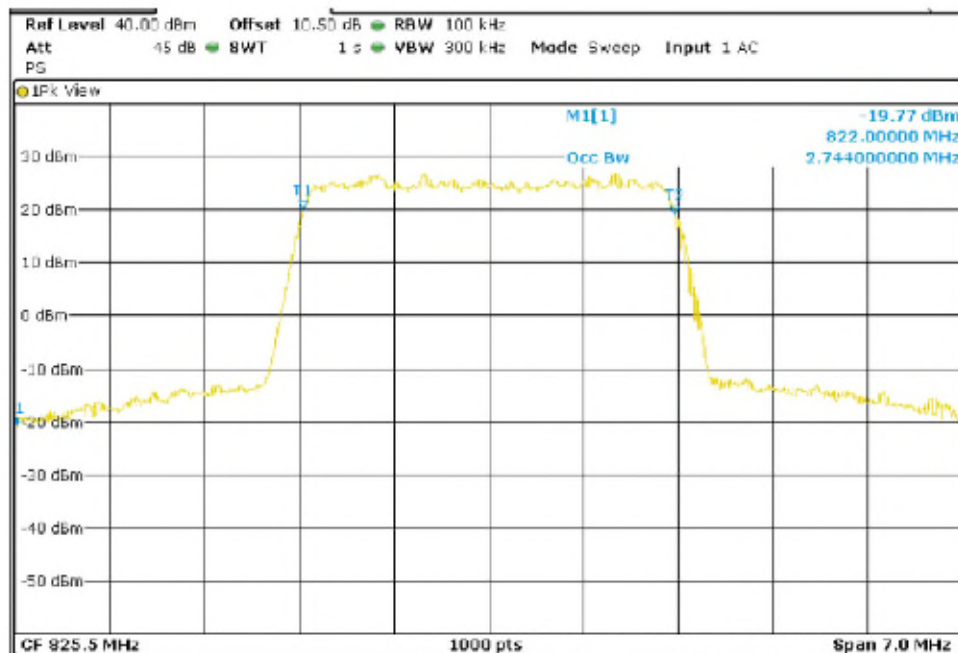

TEST RESULTS (Cont):

Lowest Channel 26dBc Bandwidth kHz

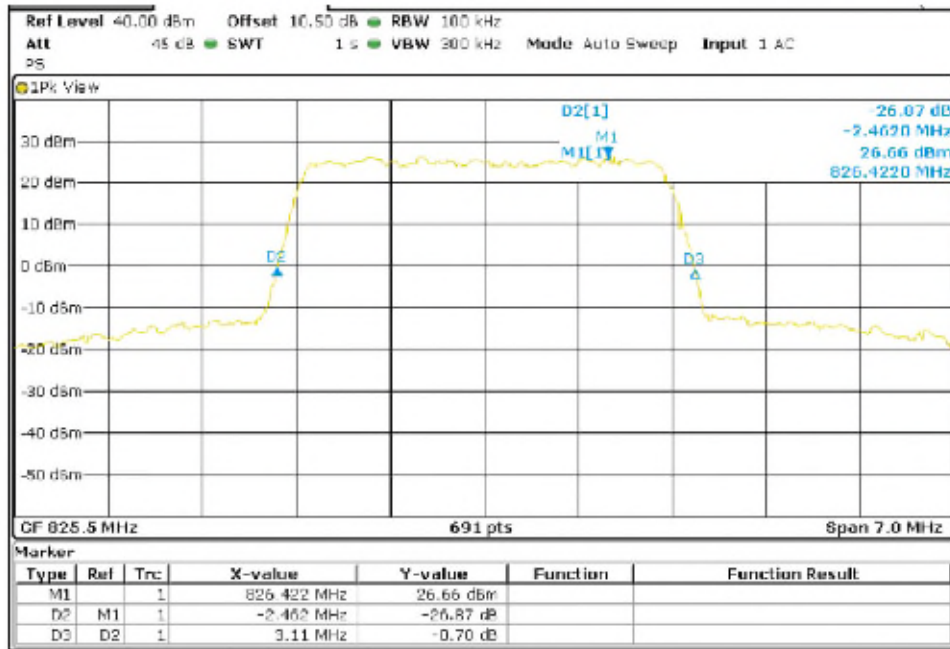

Middle Channel 99% Occupied Bandwidth

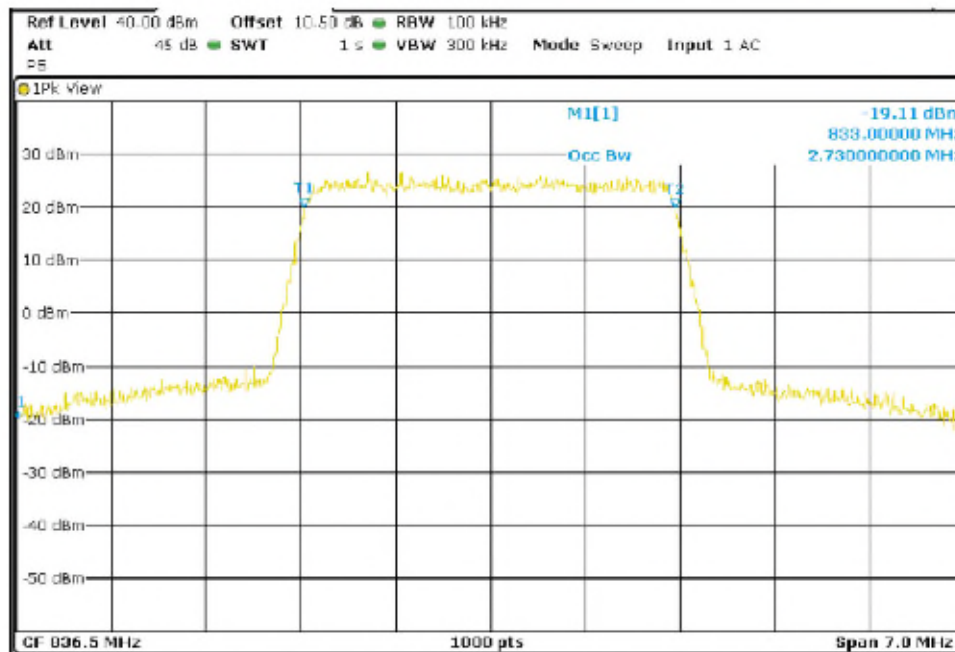

TEST RESULTS (Cont):

Middle Channel 26dBc Bandwidth kHz

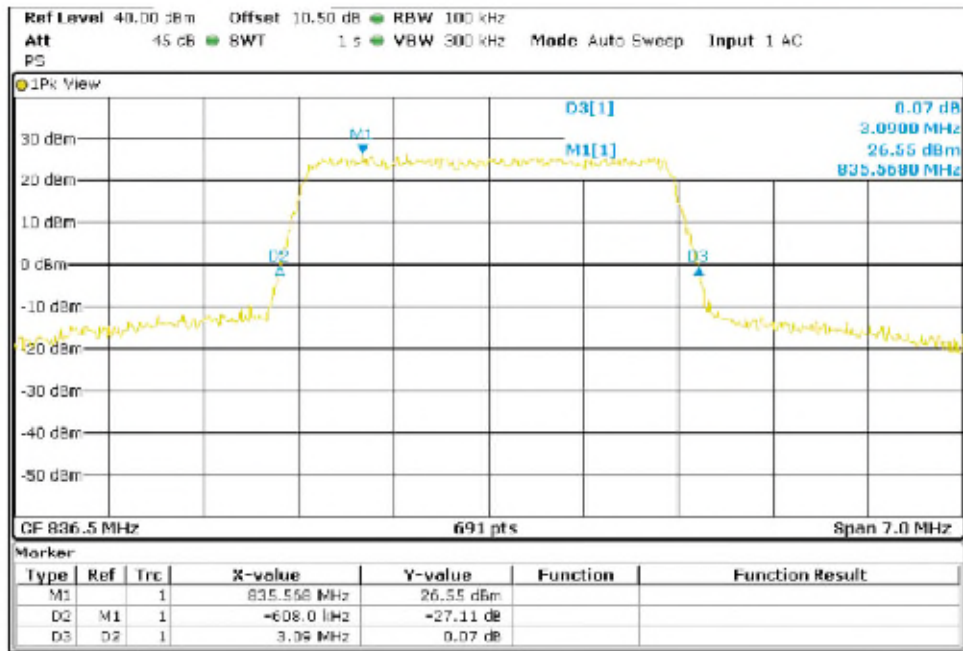

Highest Channel 99% Occupied Bandwidth

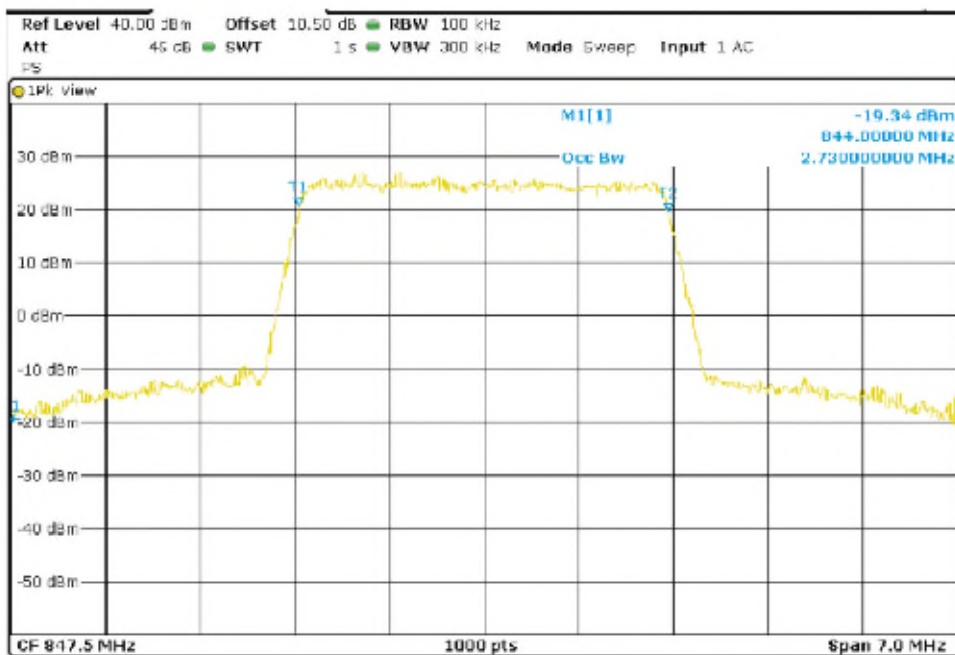

TEST RESULTS (Cont):

Highest Channel 26dBc Bandwidth kHz

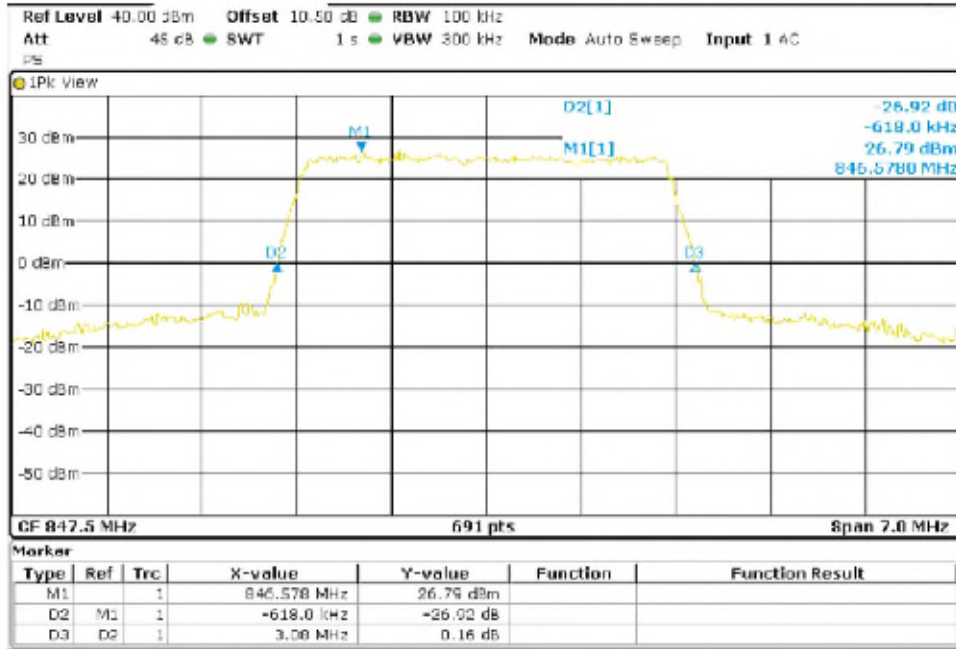

LTE QPSK MODULATION. BW = 5 MHz

Lowest Channel 99% Occupied Bandwidth

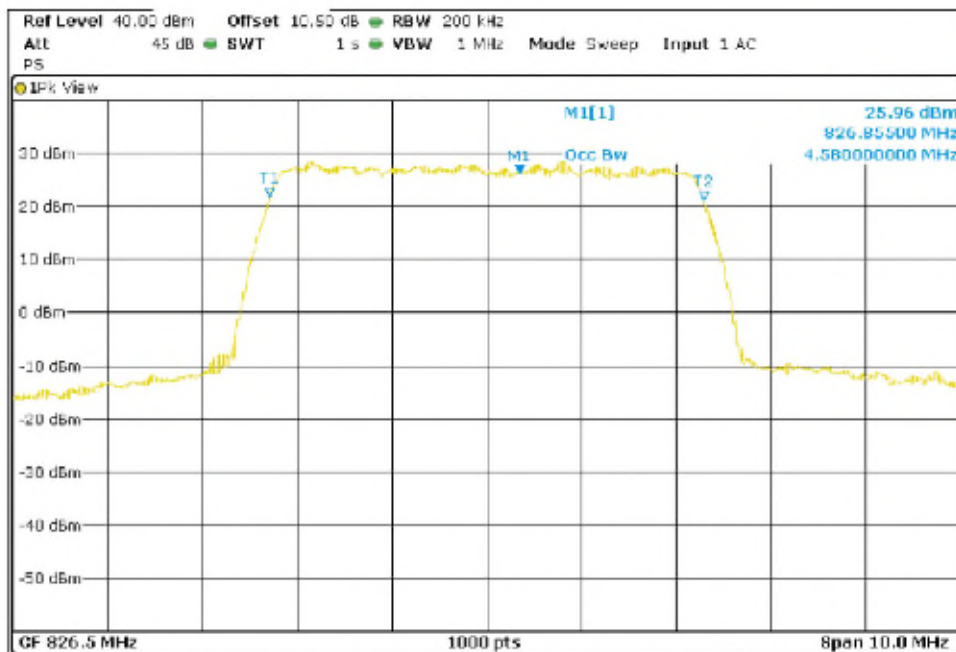

TEST RESULTS (Cont):

Lowest Channel 26dBc Bandwidth kHz

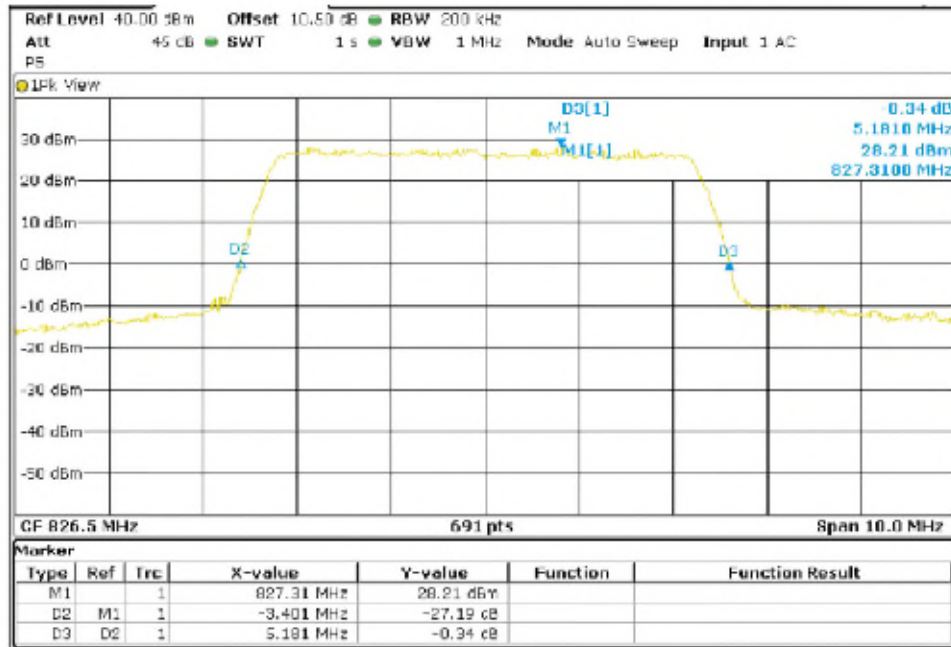

Middle Channel 99% Occupied Bandwidth



TEST RESULTS (Cont):

Middle Channel 20dBc Bandwidth kHz

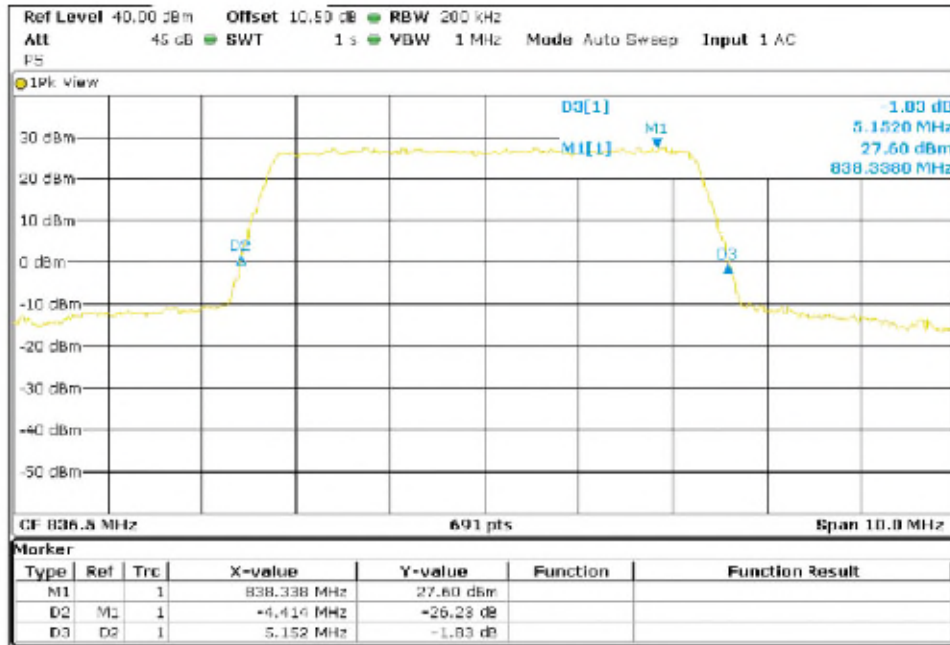

Highest Channel 99% Occupied Bandwidth

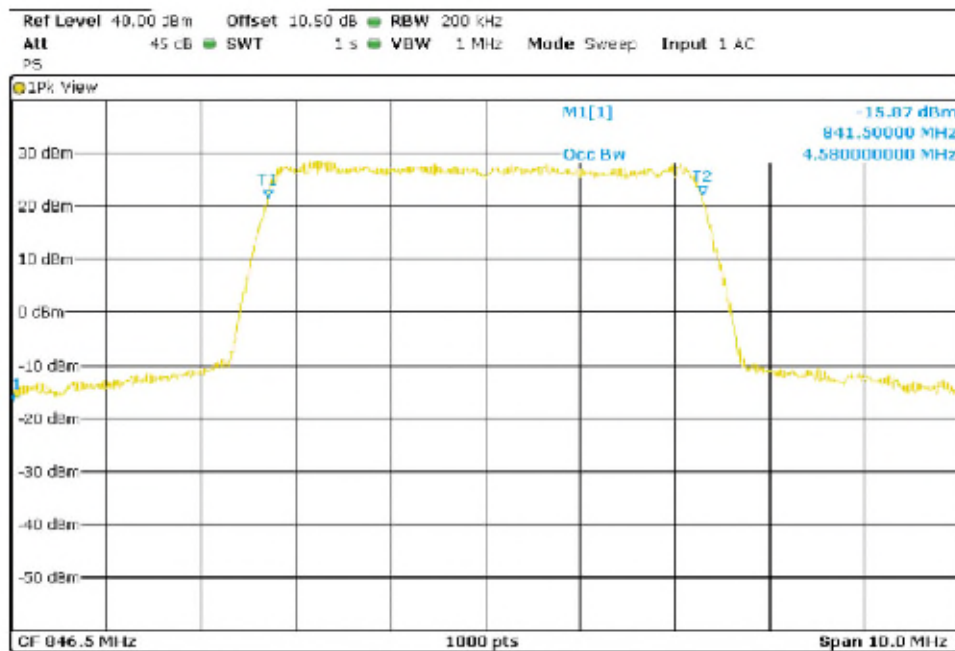

TEST RESULTS (Cont):

Highest Channel 26dBc Bandwidth kHz

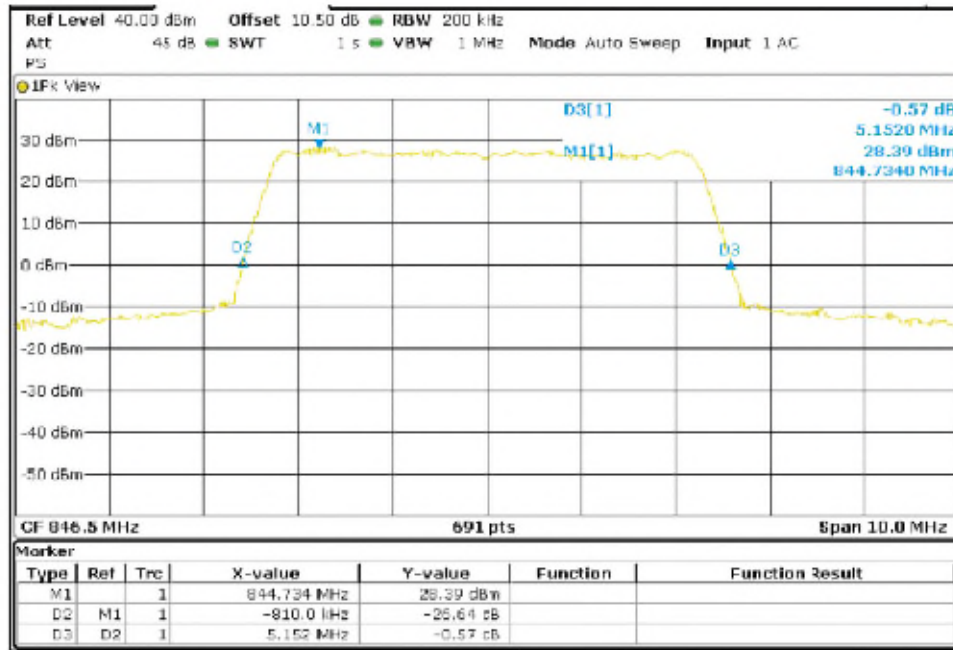

LTE 16QAM MODULATION. BW = 5 MHz

Lowest Channel 99% Occupied Bandwidth

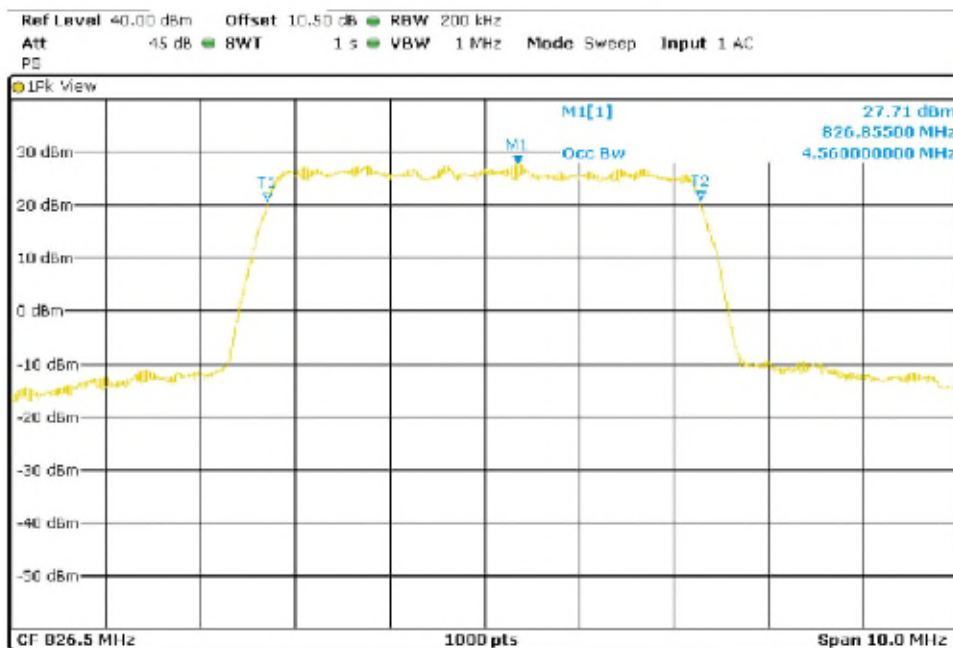

TEST RESULTS (Cont):

Lowest Channel 26dBc Bandwidth kHz

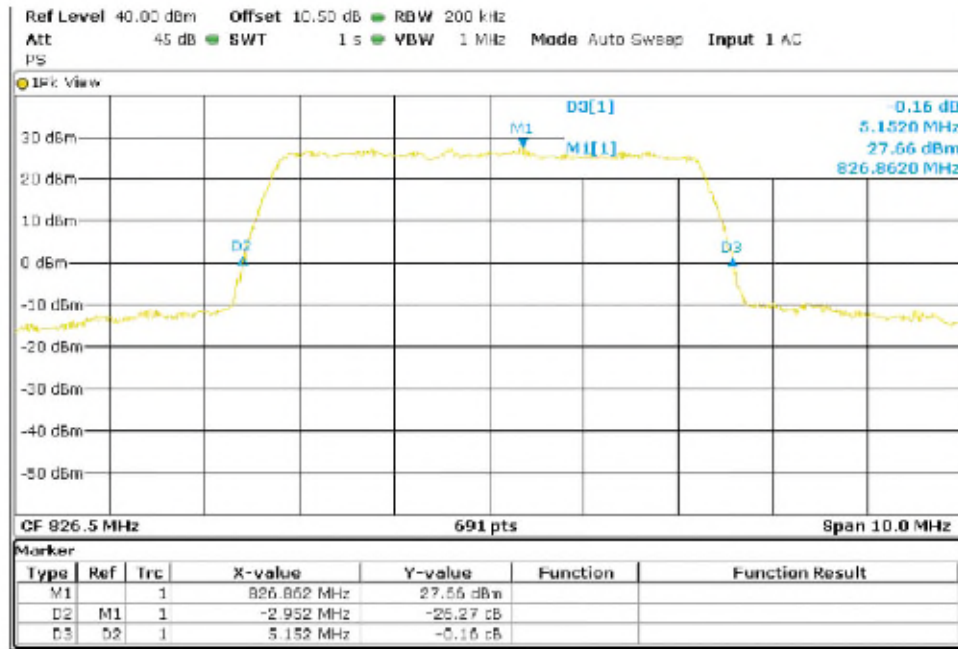

Middle Channel 88% Occupied Bandwidth

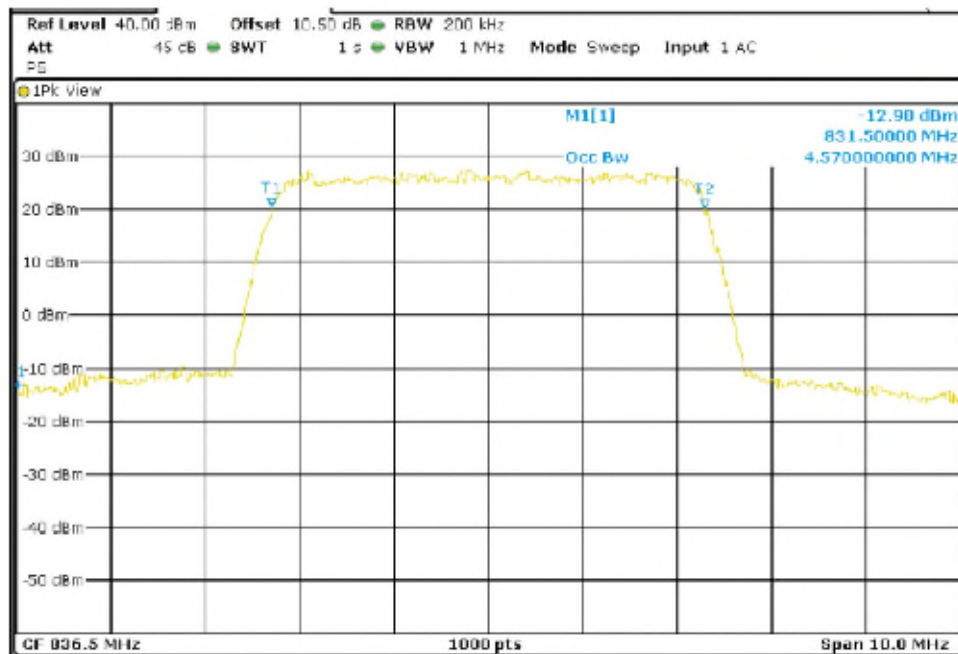

TEST RESULTS (Cont):

Middle Channel 20dBc Bandwidth kHz

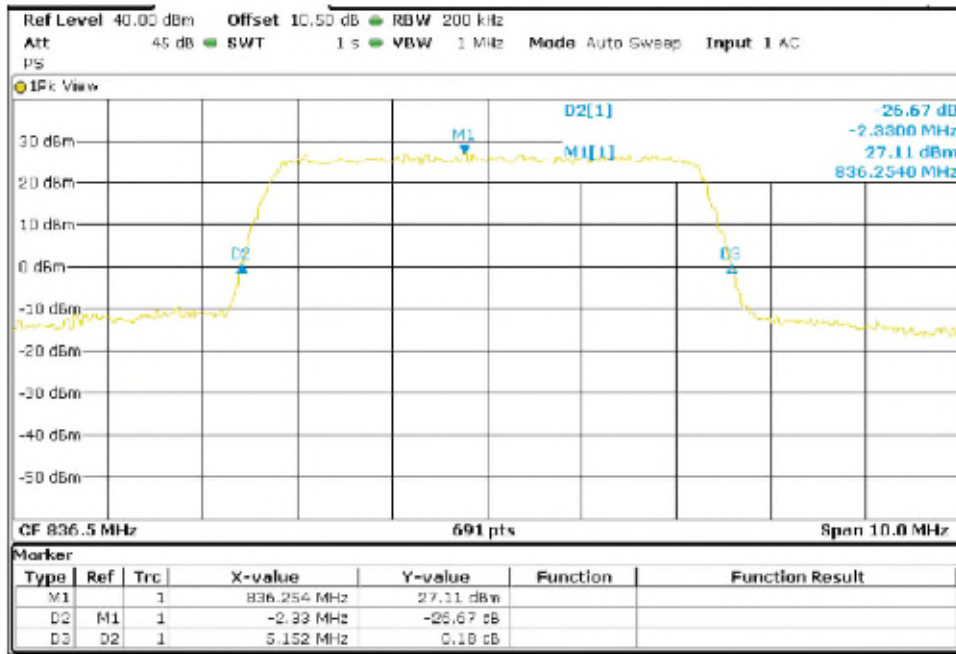

Highest Channel 99% Occupied Bandwidth

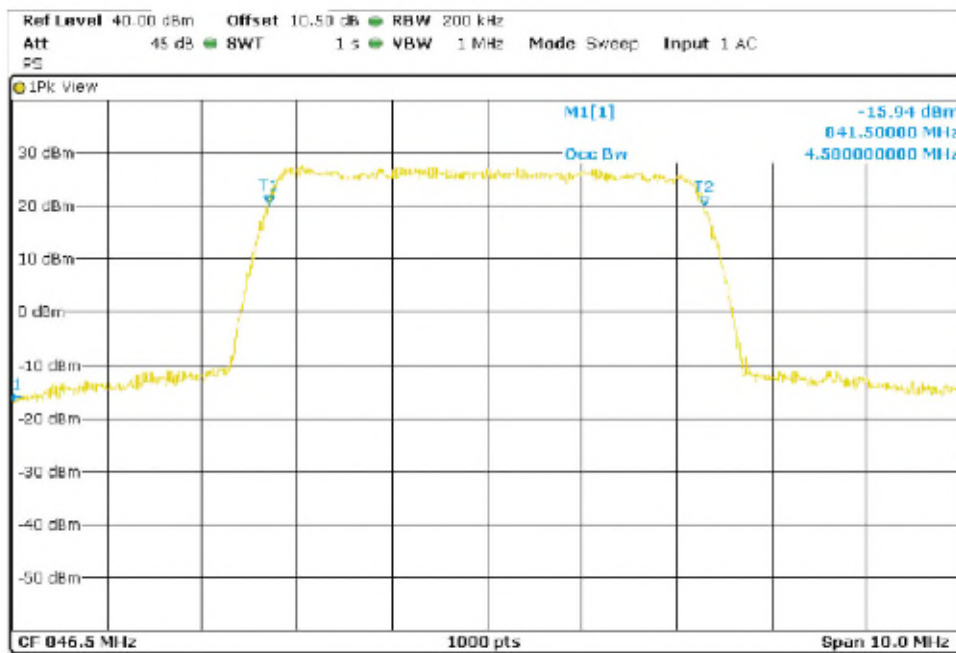

TEST RESULTS (Cont):

Highest Channel 26dBc Bandwidth kHz

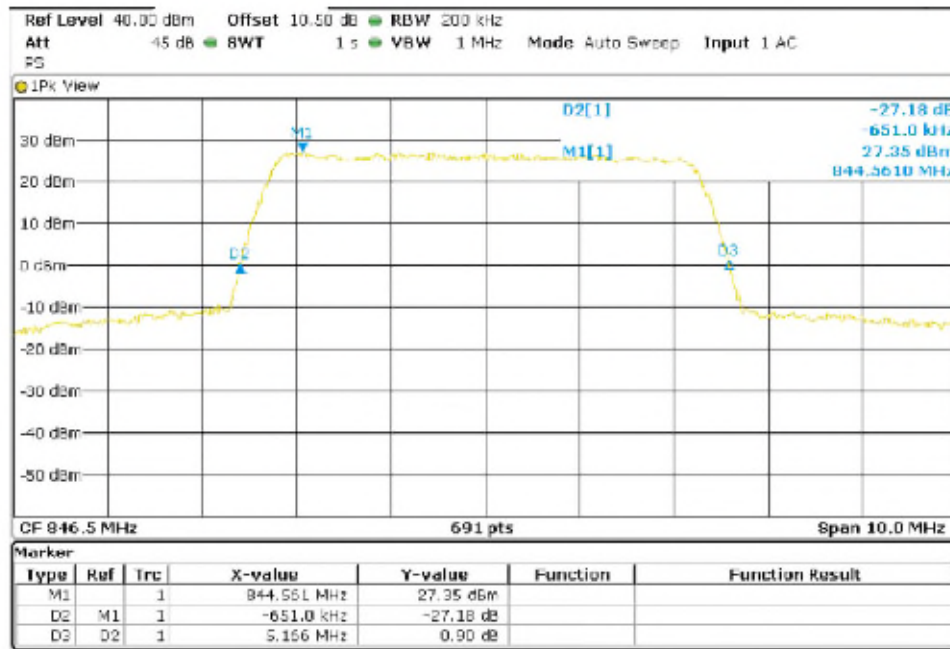

LTE QPSK MODULATION. BW = 10 MHz

Lowest Channel 99% Occupied Bandwidth

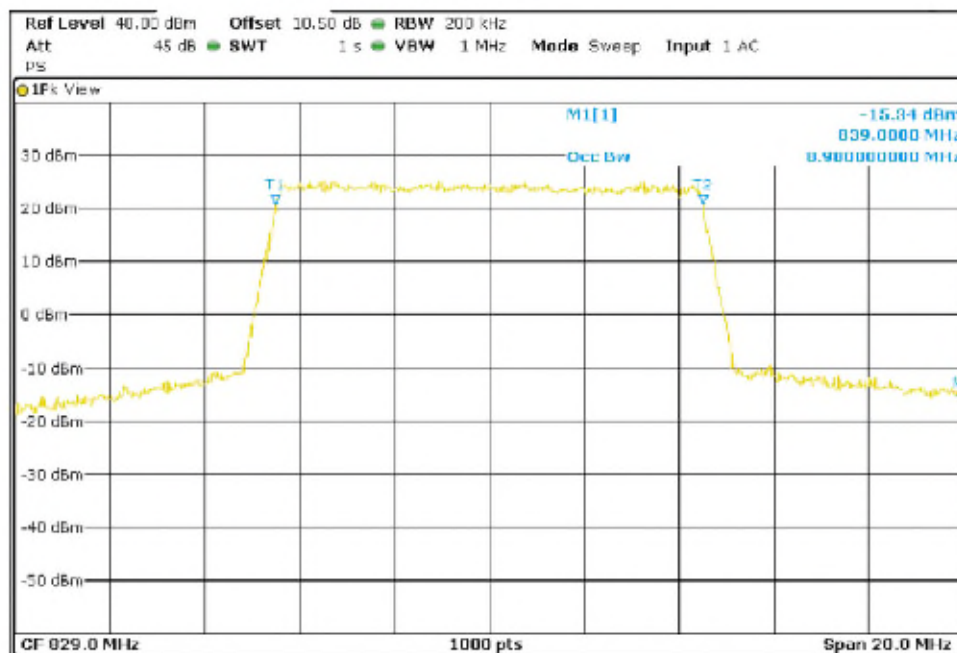

TEST RESULTS (Cont):

Lowest Channel 26dBc Bandwidth kHz

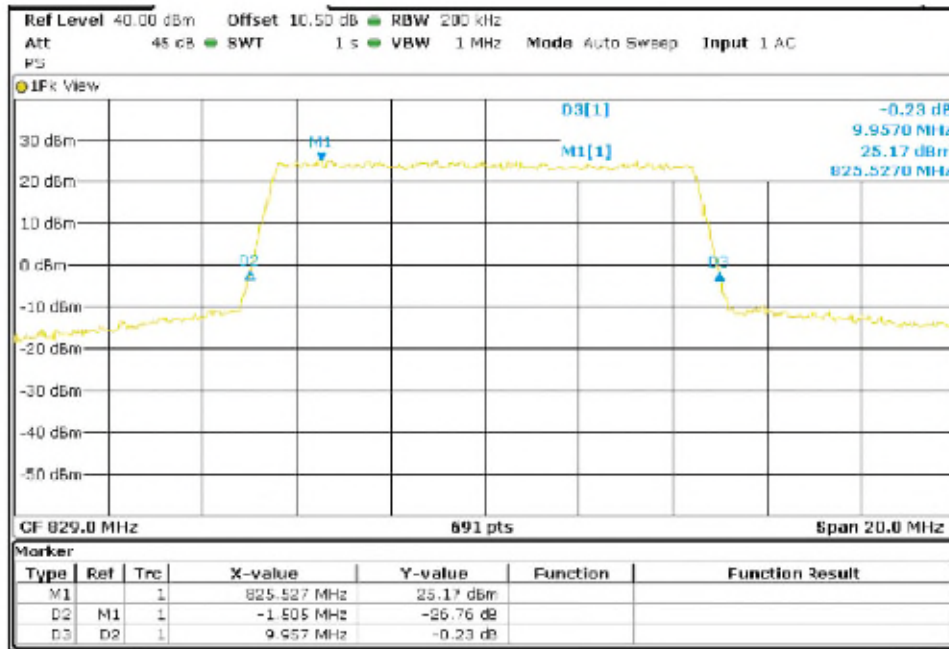

Middle Channel 88% Occupied Bandwidth

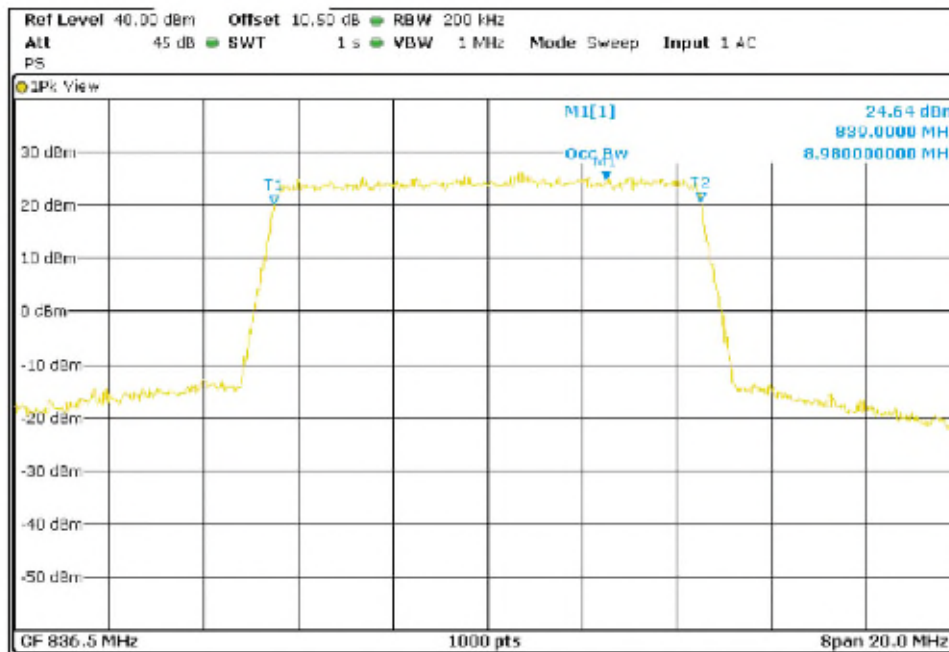

TEST RESULTS (Cont):

Middle Channel 26dBc Bandwidth kHz

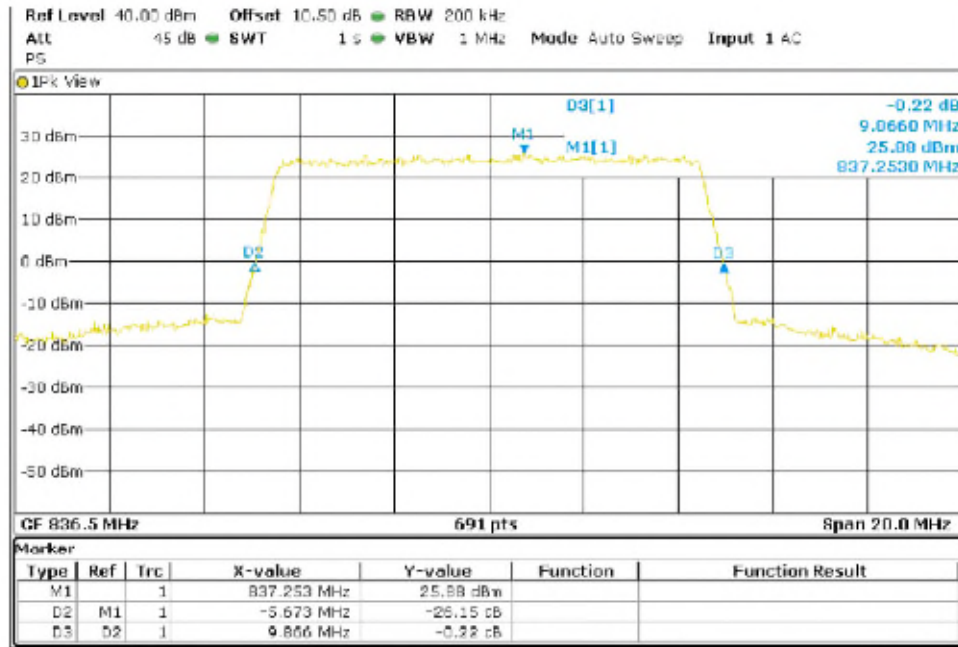

Highest Channel 99% Occupied Bandwidth

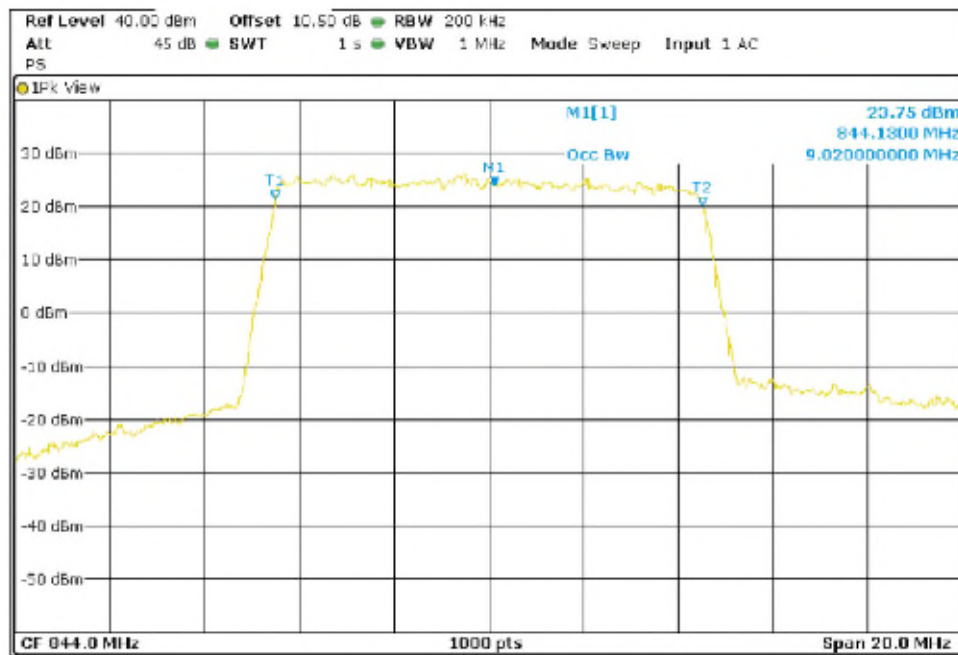

TEST RESULTS (Cont):

Highest Channel 26dBc Bandwidth kHz

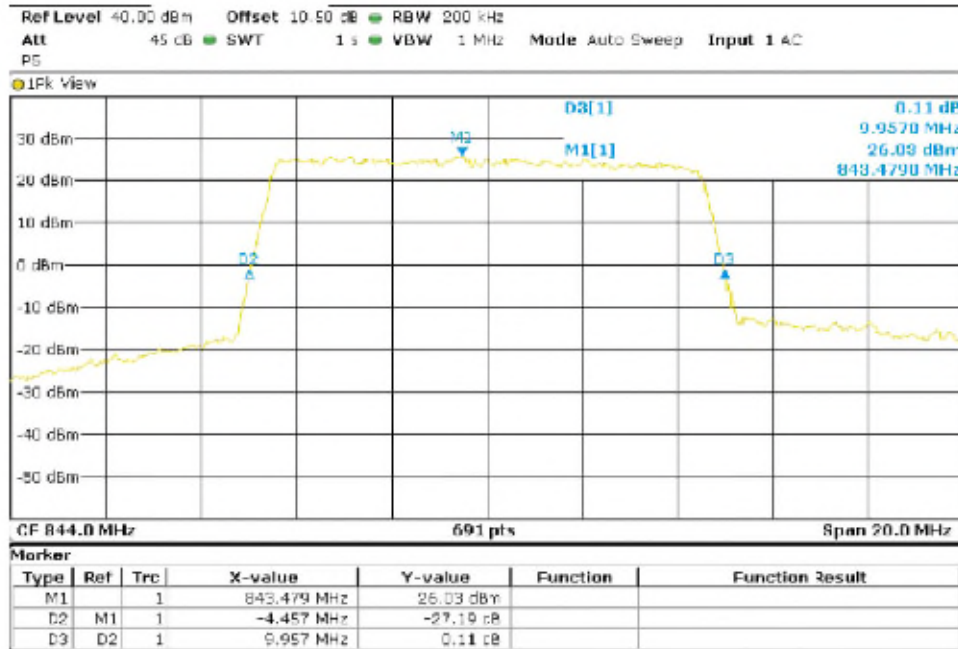

LTE 16QAM MODULATION. BW = 10 MHz

Lowest Channel 99% Occupied Bandwidth

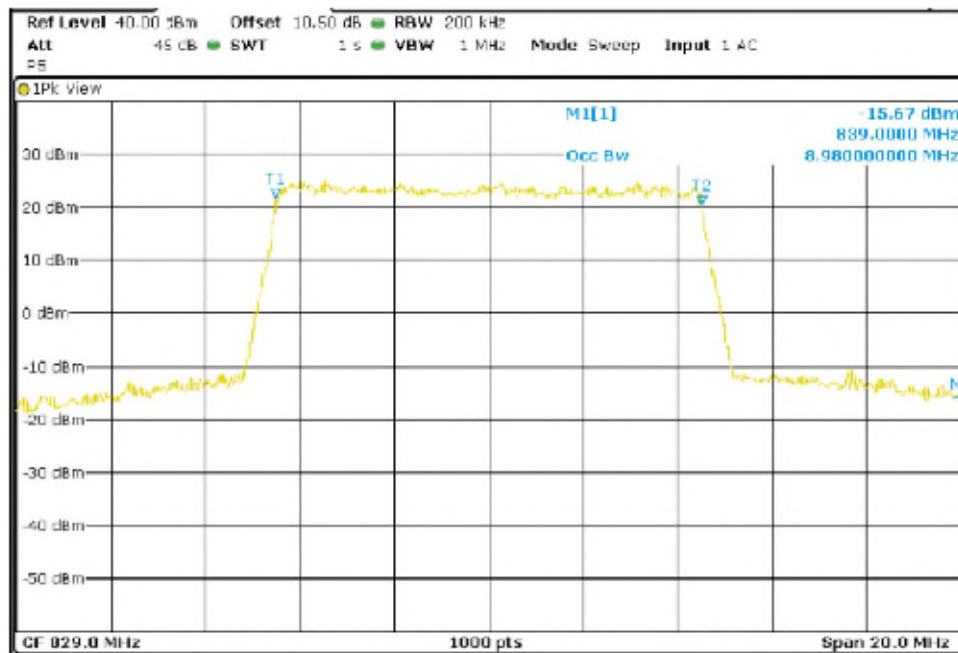

TEST RESULTS (Cont):

Lowest Channel 26dBc Bandwidth kHz

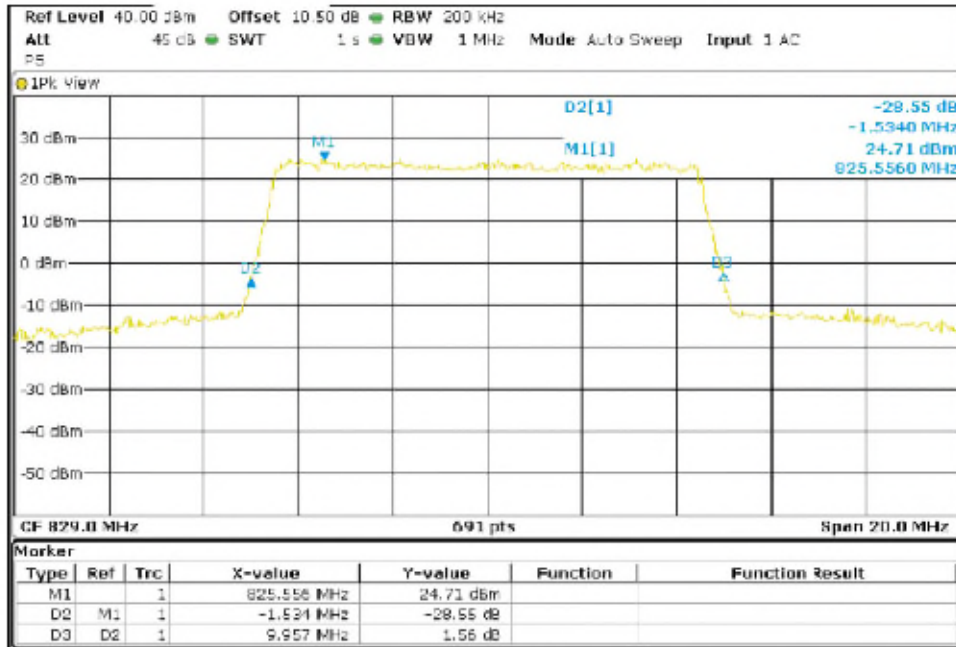

Middle Channel 88% Occupied Bandwidth

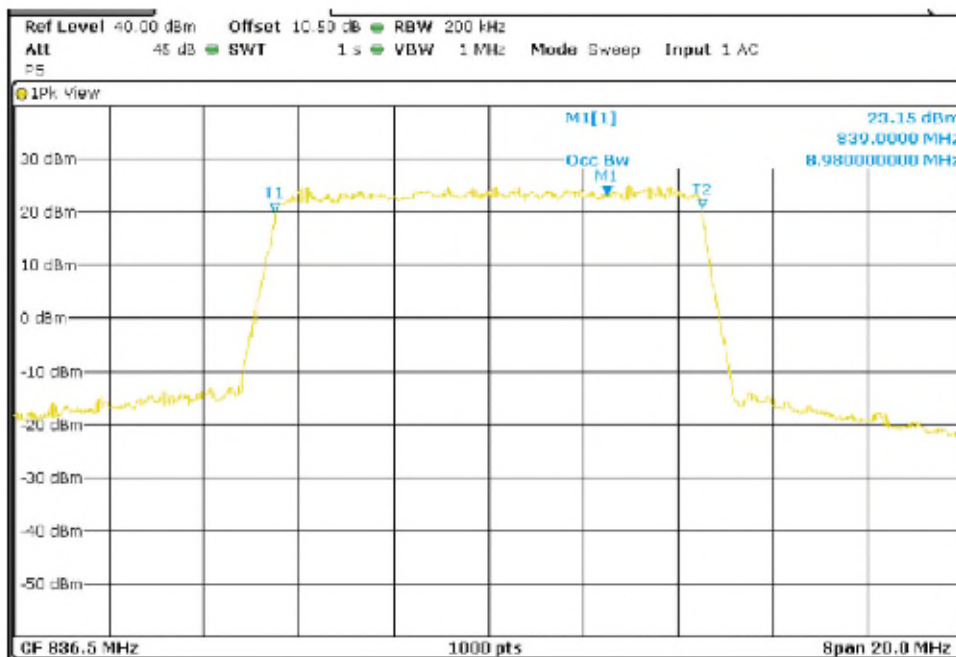

TEST RESULTS (Cont):

Middle Channel 20dBc Bandwidth kHz

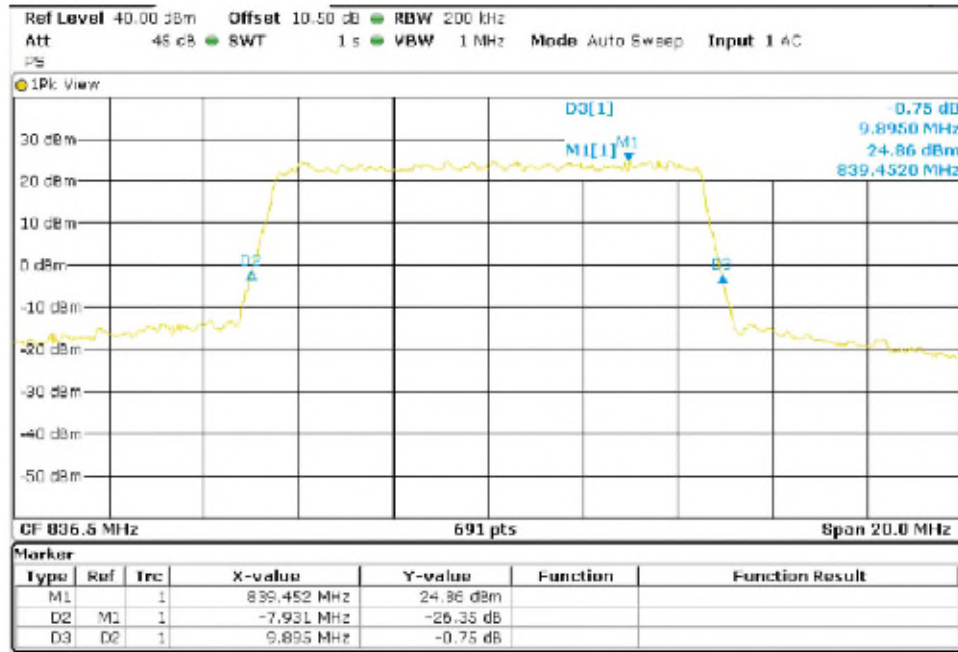

Highest Channel 99% Occupied Bandwidth

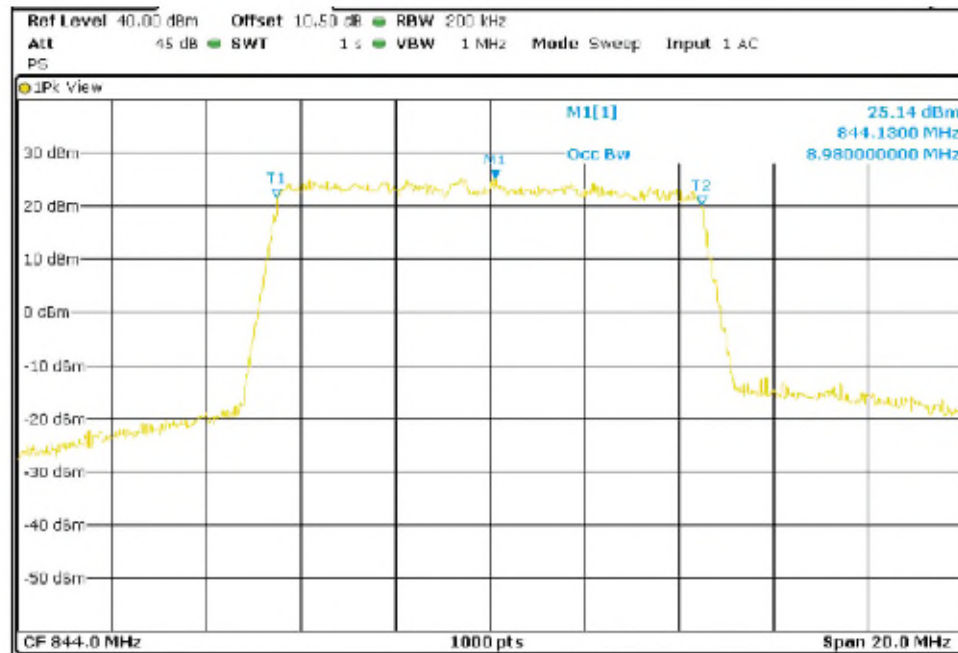

TEST RESULTS (Cont):

Highest Channel 26dBc Bandwidth kHz

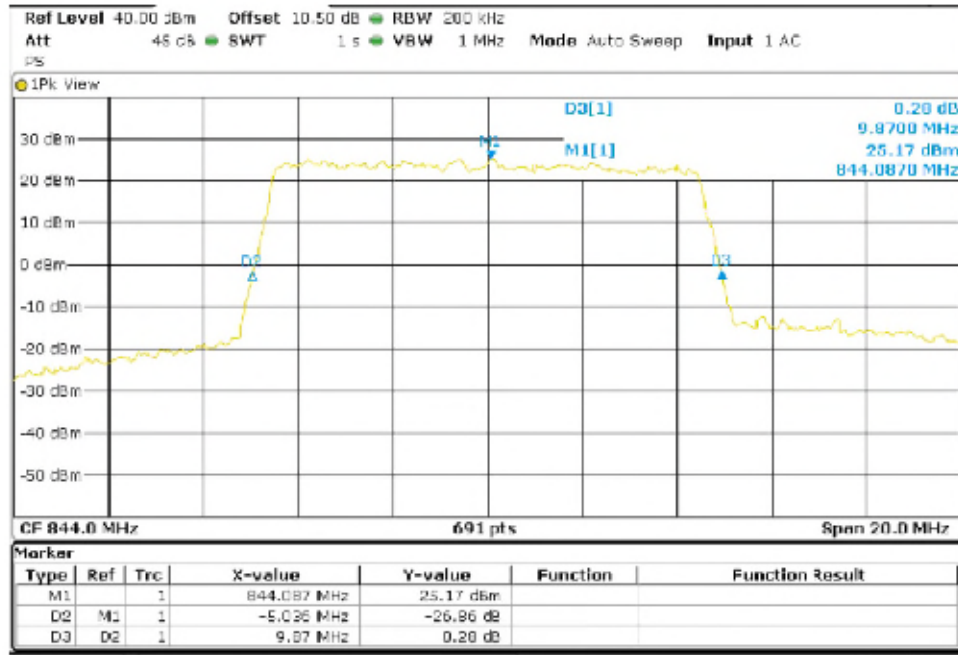

TESTED SAMPLES:	S/01
TESTED CONDITIONS MODES:	TC#02
TEST RESULTS:	PASS

GPRS MODULATION

Channel	Lowest	Middle	Highest
99% Occupied bandwidth (kHz)	245.00	245.00	243.33
-26 dBc bandwidth (kHz)	318.40	318.40	315.50

EDGE MODULATION

Channel	Lowest	Middle	Highest
99% Occupied bandwidth (kHz)	245.00	243.33	243.33
-26 dBc bandwidth (kHz)	314.00	322.70	319.80

TEST RESULTS (Cont):

GPRS MODULATION

Lowest Channel 99% Occupied Bandwidth

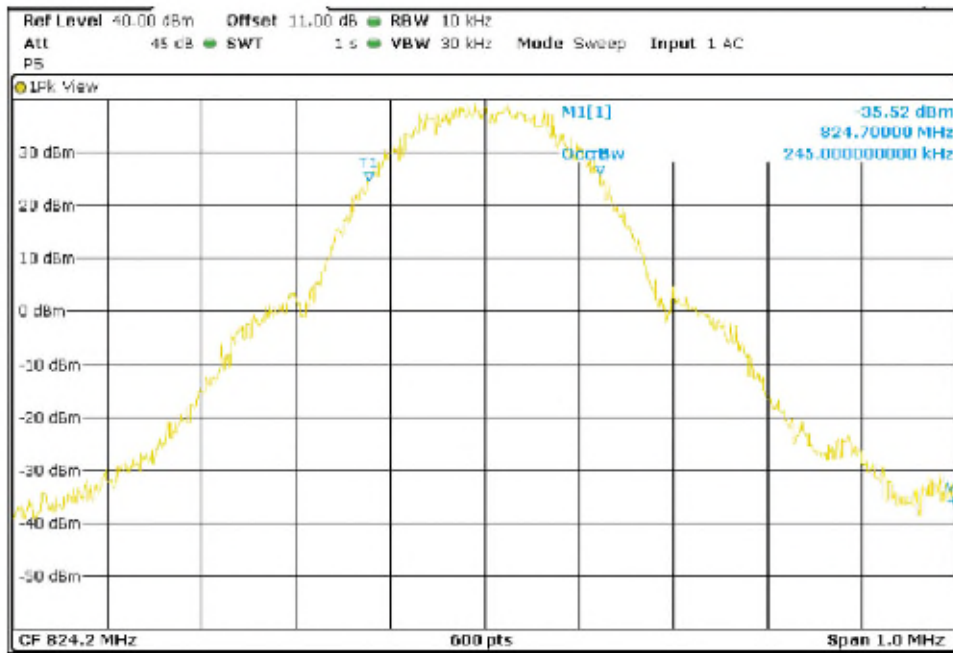

Lowest Channel 26dBc Bandwidth kHz

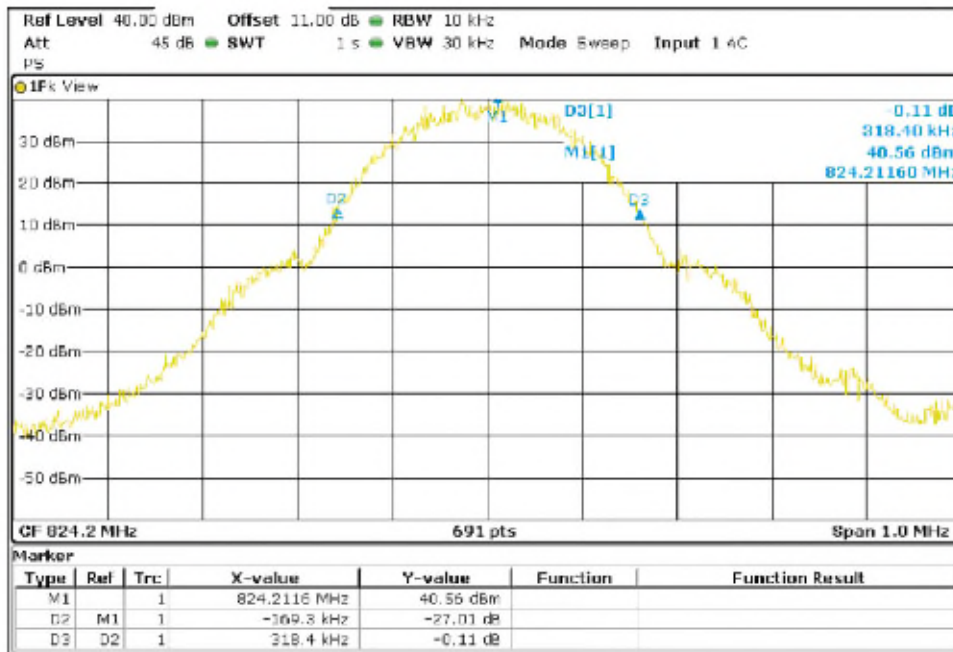

TEST RESULTS (Cont):

Middle Channel 99% Occupied Bandwidth

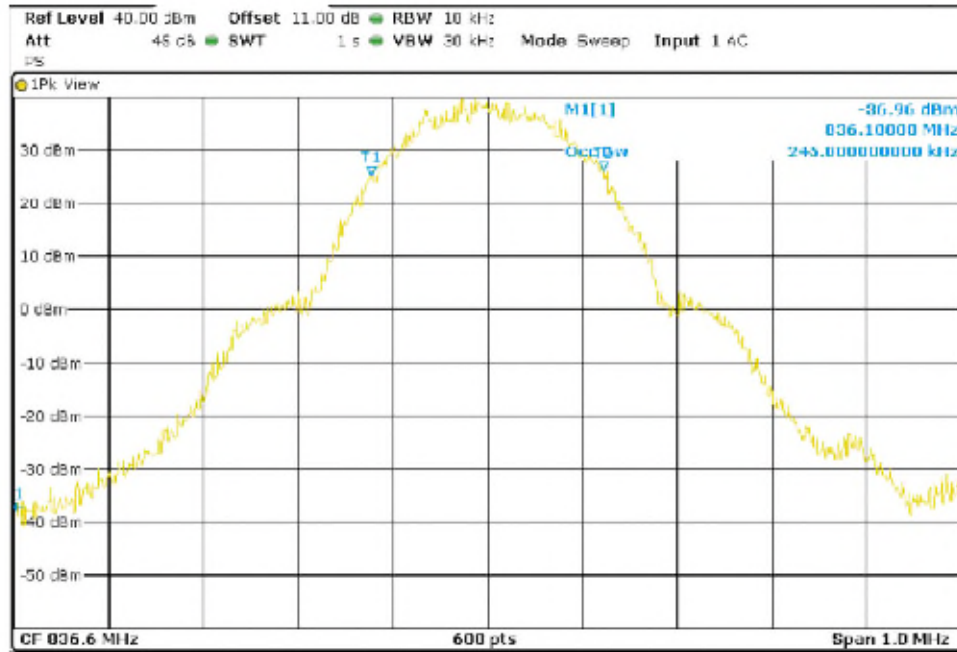

Middle Channel 26dBc Bandwidth kHz

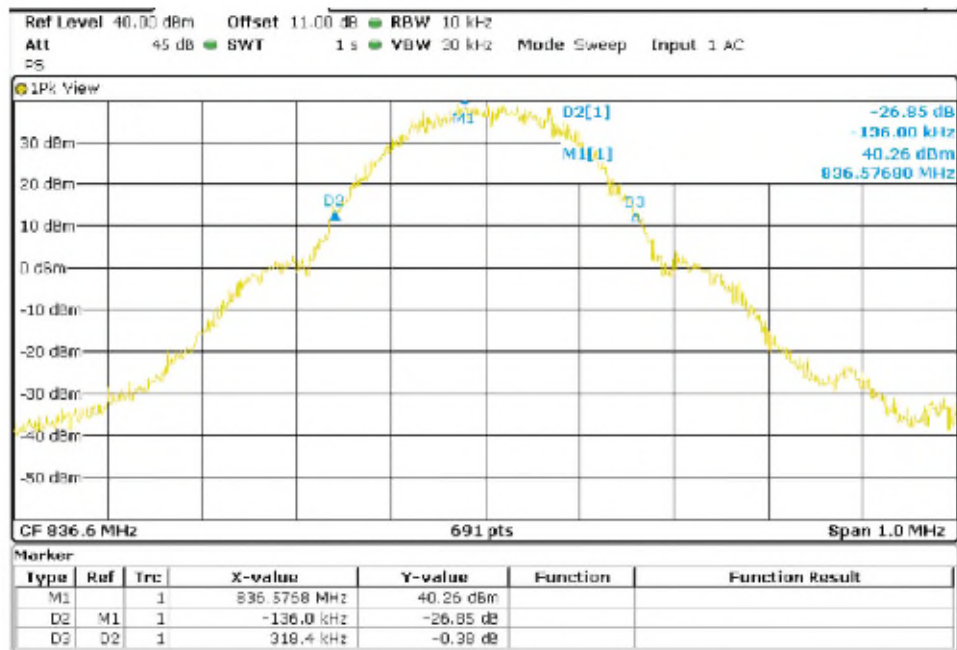

TEST RESULTS (Cont):

Highest Channel 99% Occupied Bandwidth

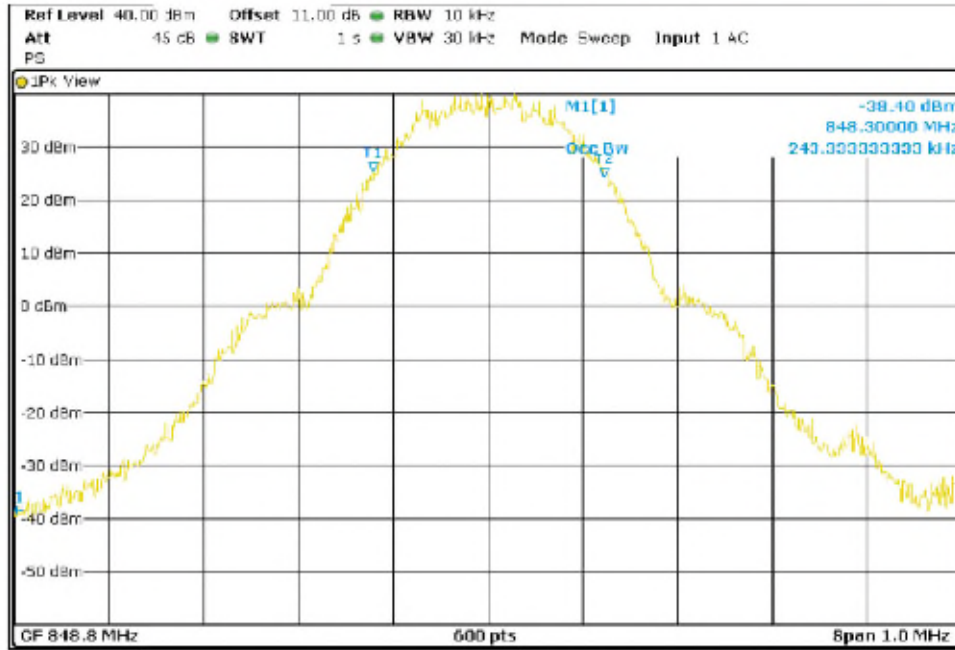

Highest Channel 26dBc Bandwidth kHz

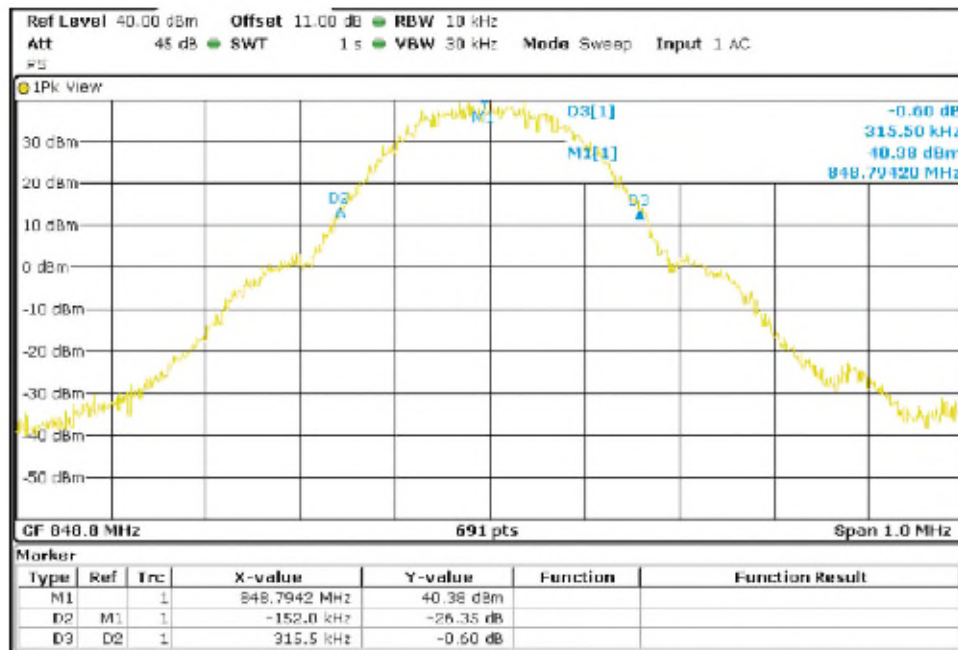

TEST RESULTS (Cont):

EDGE MODULATION

Lowest Channel 99% Occupied Bandwidth

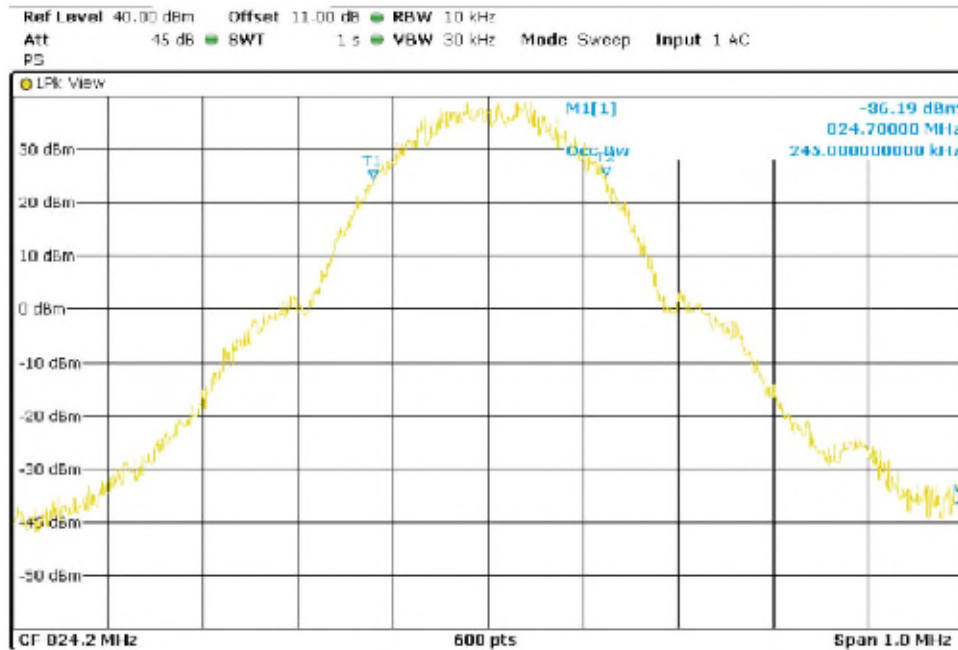

Lowest Channel 26dBc Bandwidth kHz

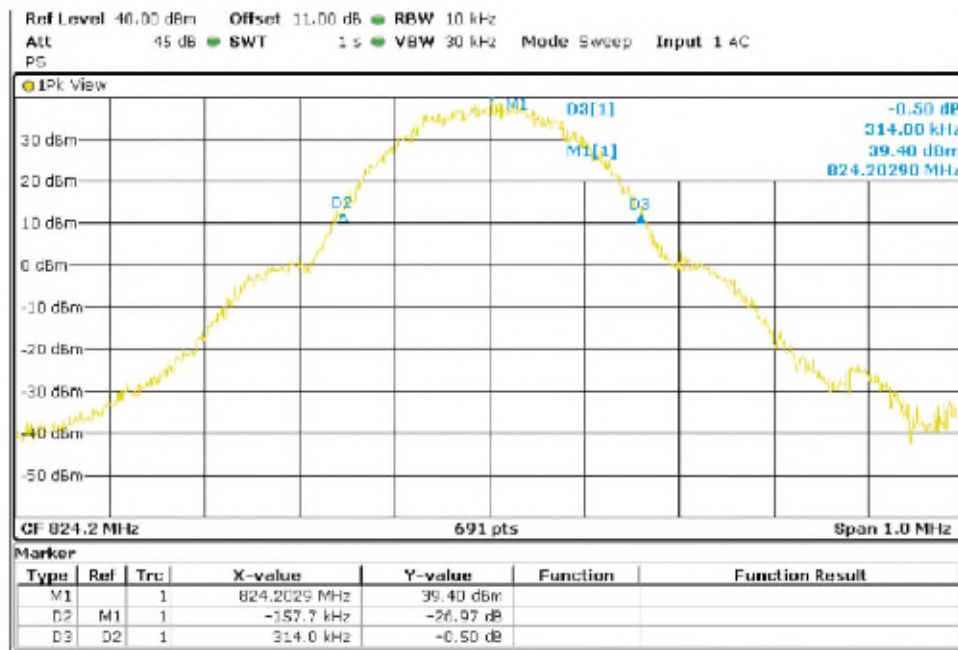

TEST RESULTS (Cont):

Middle Channel 99% Occupied Bandwidth

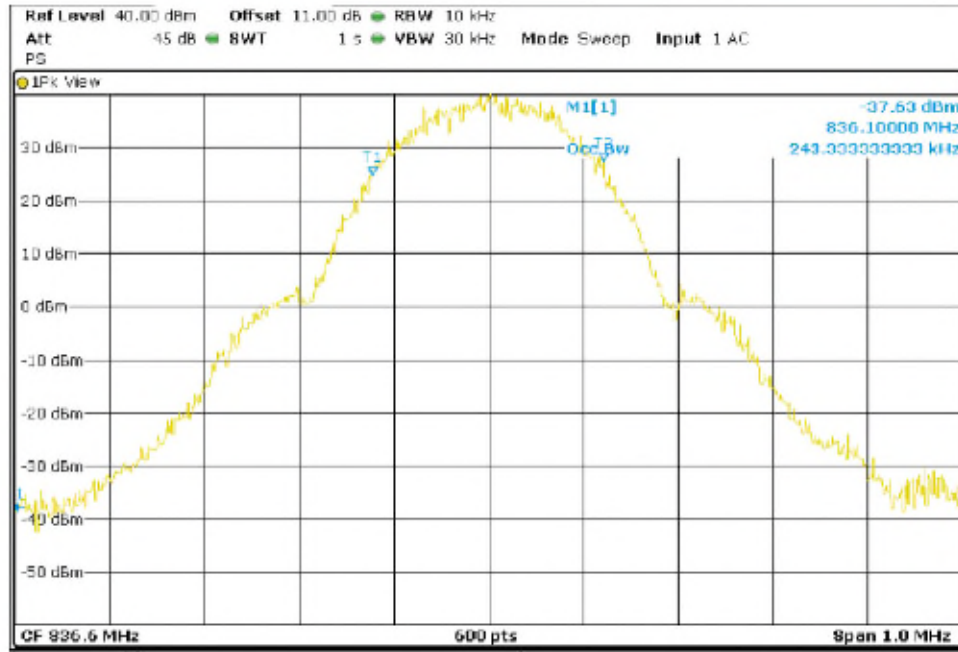

Middle Channel 26dBc Bandwidth kHz

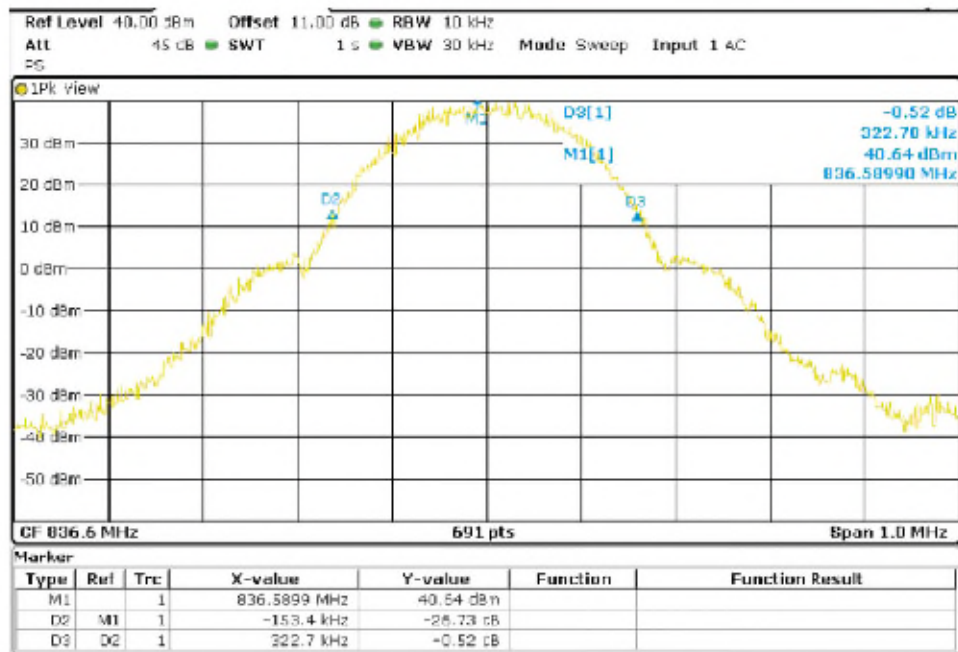

TEST RESULTS (Cont):

Highest Channel 99% Occupied Bandwidth

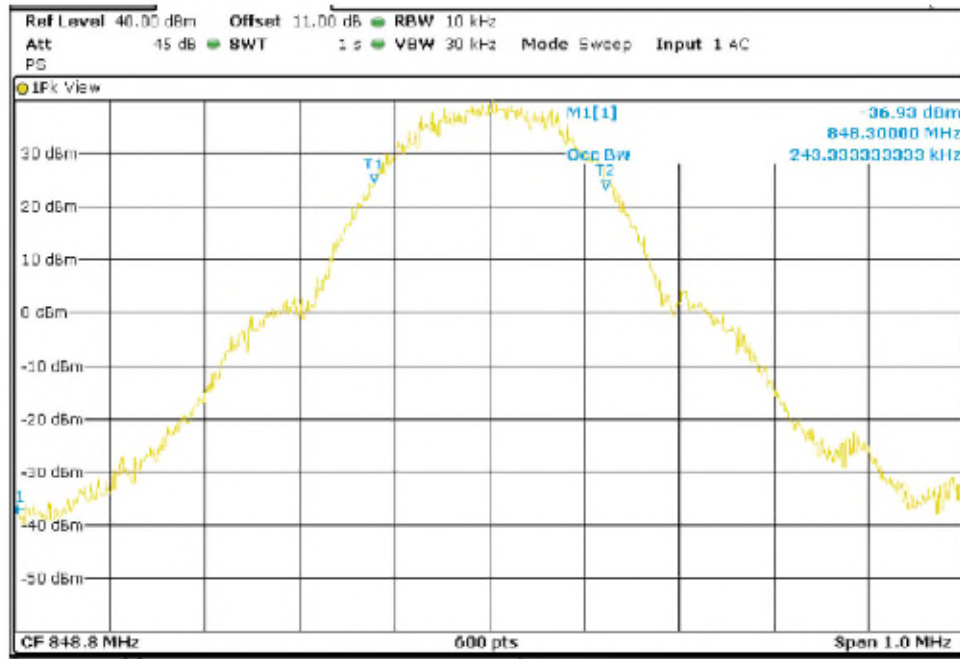

Highest Channel 26dBc Bandwidth kHz

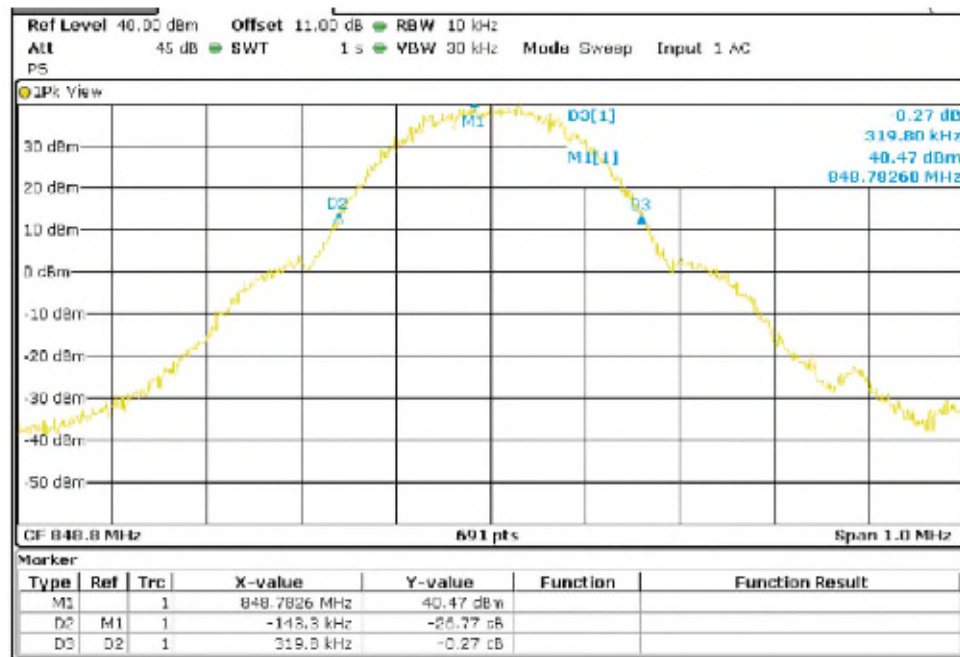

TESTED SAMPLES:	S/01
TESTED CONDITIONS MODES:	TC#03
TEST RESULTS:	PASS

WCDMA MODULATION

Channel	Lowest	Middle	Highest
99% Occupied bandwidth (MHz)	4.13	4.15	4.15
-26 dBc bandwidth (MHz)	4.72	4.72	4.72

TEST RESULTS (Cont):

WCDMA Modulation

Low Channel 99% Occupied Bandwidth

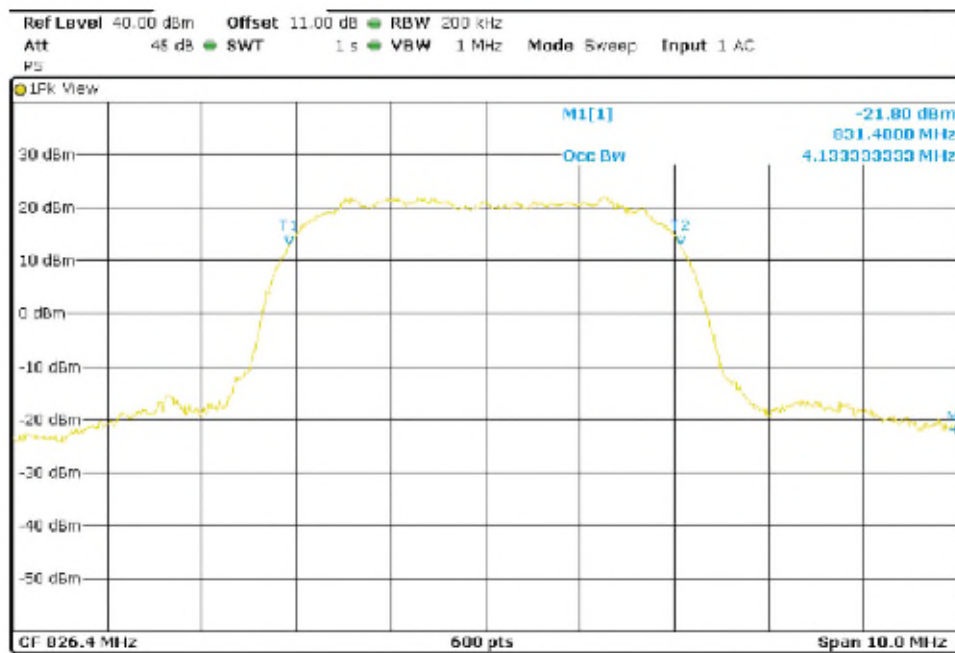

Low Channel 26dBc Bandwidth kHz

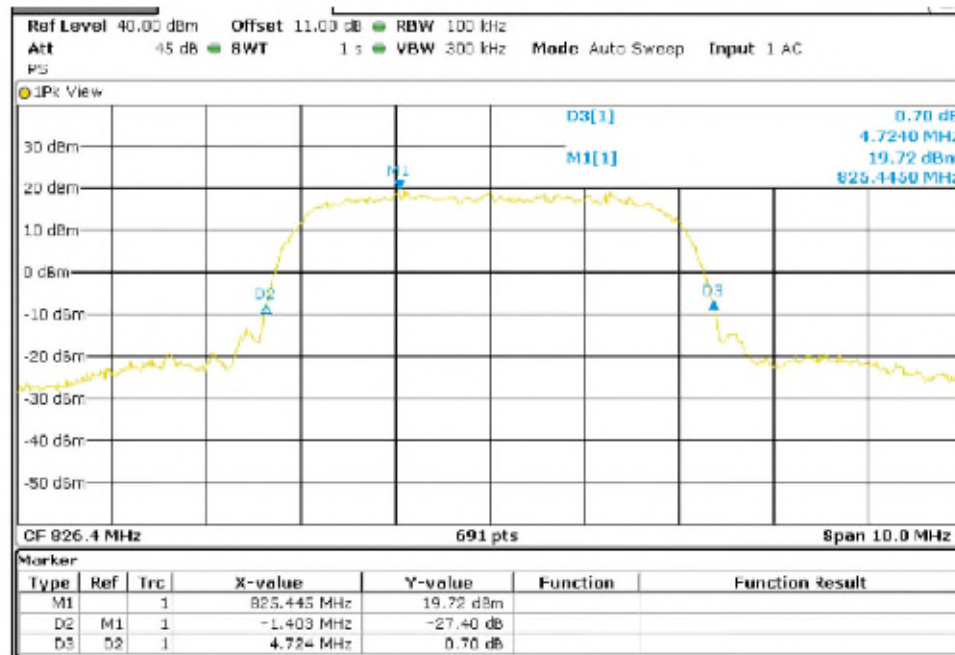

TEST RESULTS (Cont):

Middle Channel 99% Occupied Bandwidth



Middle Channel 26dBc Bandwidth kHz

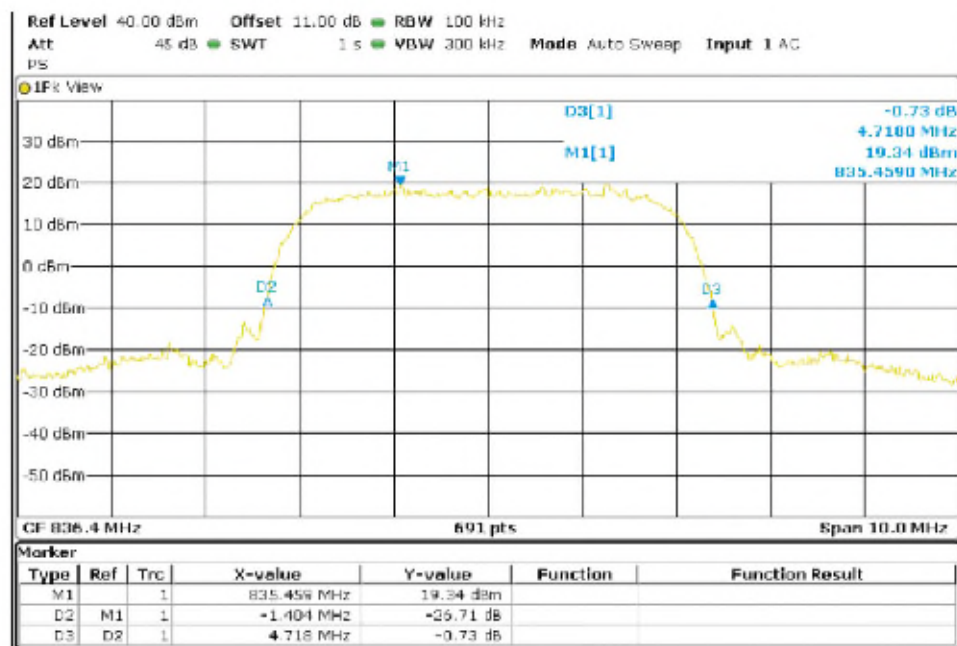

TEST RESULTS (Cont):

High Channel 99% Occupied Bandwidth

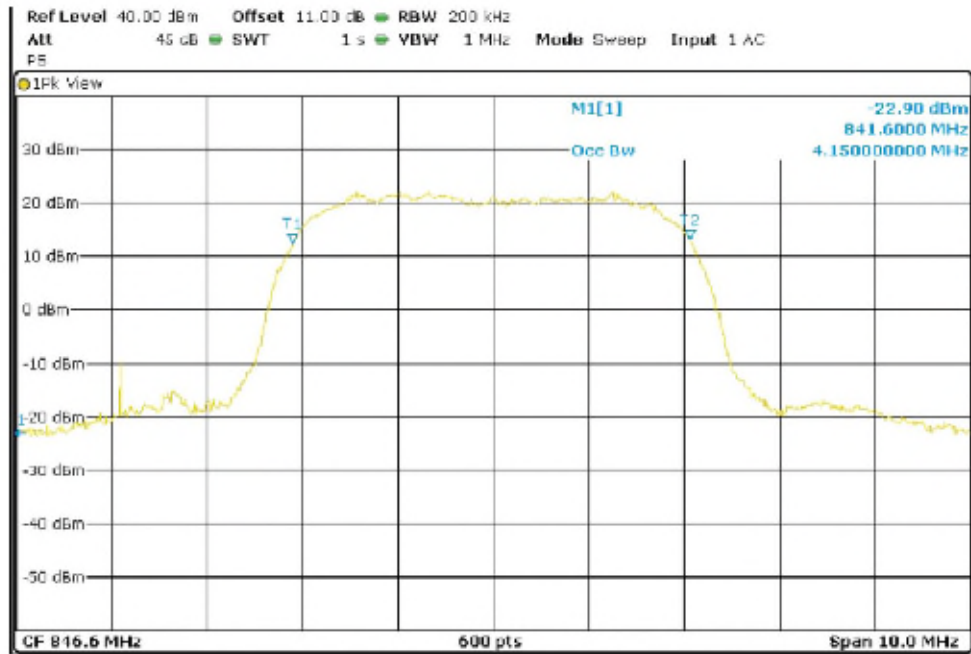

High Channel 26dBc Bandwidth kHz

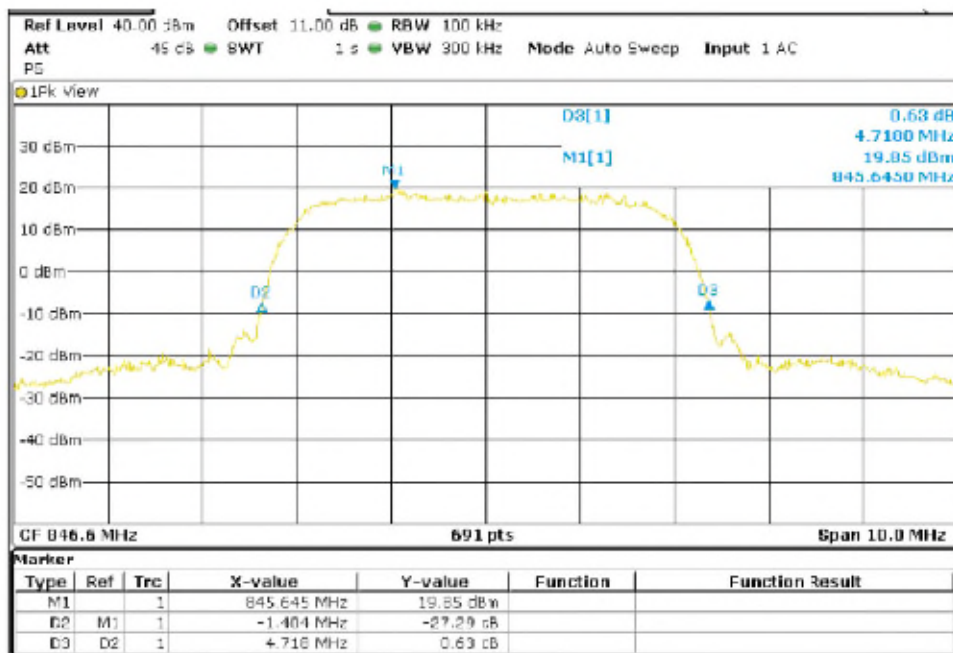

TEST A5: SPURIOUS EMISSIONS AT ANTENNA TERMINALS

LIMITS:	Product standard:	FCC Part 22 / IC RSS-132
	Test standard:	FCC §2.1051 and § 22.917 / RSS-132 Clause 5.5

LIMITS

According to specification, the power of emissions shall be attenuated below the transmitter power (P) by a factor of at least $43 + 10 \log(P)$ dB. P in watts.

At P_0 transmitting power of 2 watts (33 dBm), the specified minimum attenuation becomes $43 + 10 \log(P_0)$ and the level in dBm relative to P_0 becomes:

$$P_0 \text{ (dBm)} - [43 + 10 \log(P_0 \text{ in watts})] = -13 \text{ dBm}$$

TEST SETUP

The EUTRF output connector was connected to a spectrum analyzer and to the Universal Radio Communication Tester R&S CMW500 (selecting maximum transmission power of the EUT and different modes of modulation) using a 50-ohm attenuator and a power splitter.

The spectrum was investigated from 9 kHz to 18 GHz for LTE Band V.

The spectrum was investigated from 9 kHz to 18 GHz for 2G GPRS Band 850.

The spectrum was investigated from 9 kHz to 18 GHz for WCDMA and HSUPA Band V.

The reading of the spectrum analyzer is corrected with the attenuation loss of connection between output terminal of EUT and input of the spectrum analyzer.

For LTE mode the configuration of Resource Blocks and modulation which is the worst case for conducted power was used.

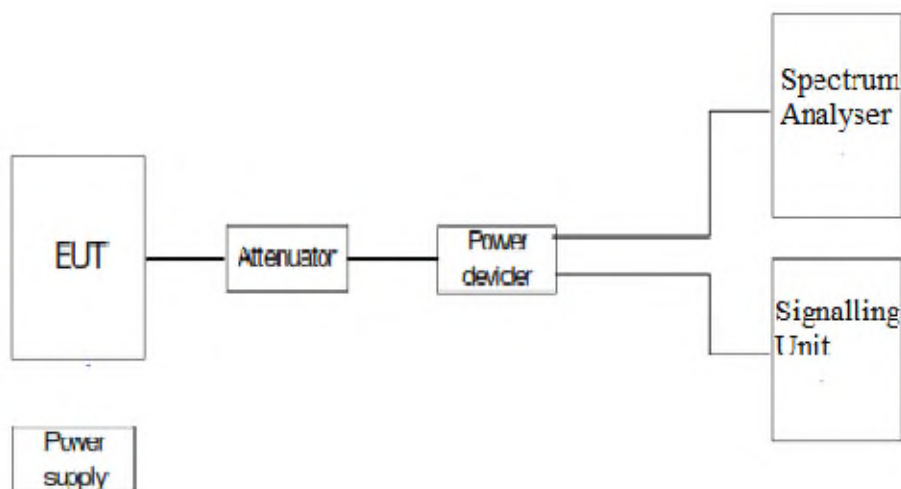

TESTED SAMPLES:	S/01
TESTED CONDITIONS MODES:	TC#01
TEST RESULTS:	PASS

Frequency range 9 kHz – 20 GHz

LTE QPSK MODULATION. BW = 1.4 MHz

Lowest Channel

No spurious signal was found at less than 10 dB respect to the limit in the frequency range.

Middle Channel

No spurious signal was found at less than 10 dB respect to the limit in the frequency range.

Highest Channel

Spurious frequency (MHz)	Level (dBm)	Measurement uncertainty (dB)
893.41	-28.8	< ± 1.20

LTE QPSK MODULATION. BW = 3 MHz

Lowest Channel

Spurious frequency (MHz)	Level (dBm)	Measurement uncertainty (dB)
870.28	-28.09	< ± 1.20

Middle Channel

Spurious frequency (MHz)	Level (dBm)	Measurement uncertainty (dB)
881.59	-25.88	< ± 1.20

Highest Channel

No spurious signal was found at less than 10 dB respect to the limit in the frequency range.

LTE QPSK MODULATION. BW = 5 MHz

Lowest Channel

Spurious frequency (MHz)	Level (dBm)	Measurement uncertainty (dB)
872.18	-23.3	< ± 1.20

TEST RESULTS (Cont):

Middle Channel

No spurious signal was found at less than 10 dB respect to the limit in the frequency range.

Highest Channel

Spurious frequency (MHz)	Level (dBm)	Measurement uncertainty (dB)
890.91	-23.04	< ± 1.20

LTE QPSK MODULATION. BW = 10 MHz

Lowest Channel

Spurious frequency (MHz)	Level (dBm)	Measurement uncertainty (dB)
871.53	-25.64	< ± 1.20

Middle Channel

Spurious frequency (MHz)	Level (dBm)	Measurement uncertainty (dB)
877.78	-31.3	< ± 1.20

Highest Channel

Spurious frequency (MHz)	Level (dBm)	Measurement uncertainty (dB)
892.16	-30.93	< ± 1.20

TEST RESULTS (Cont):

LTE QPSK MODULATION. BW = 1.4MHz

Lowest Channel

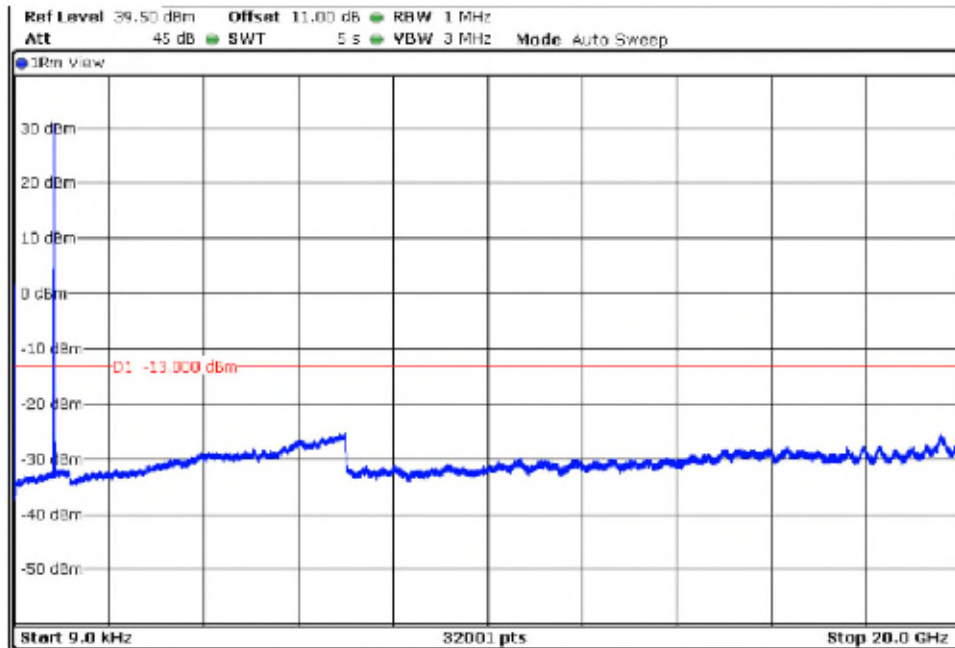

Middle Channel

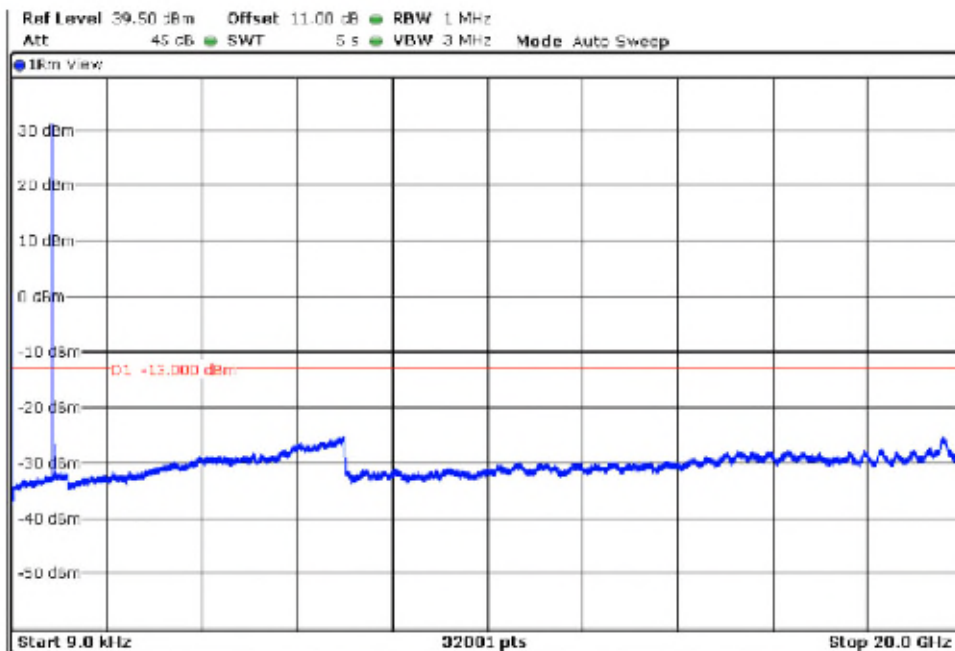

TEST RESULTS (Cont):

Highest Channel

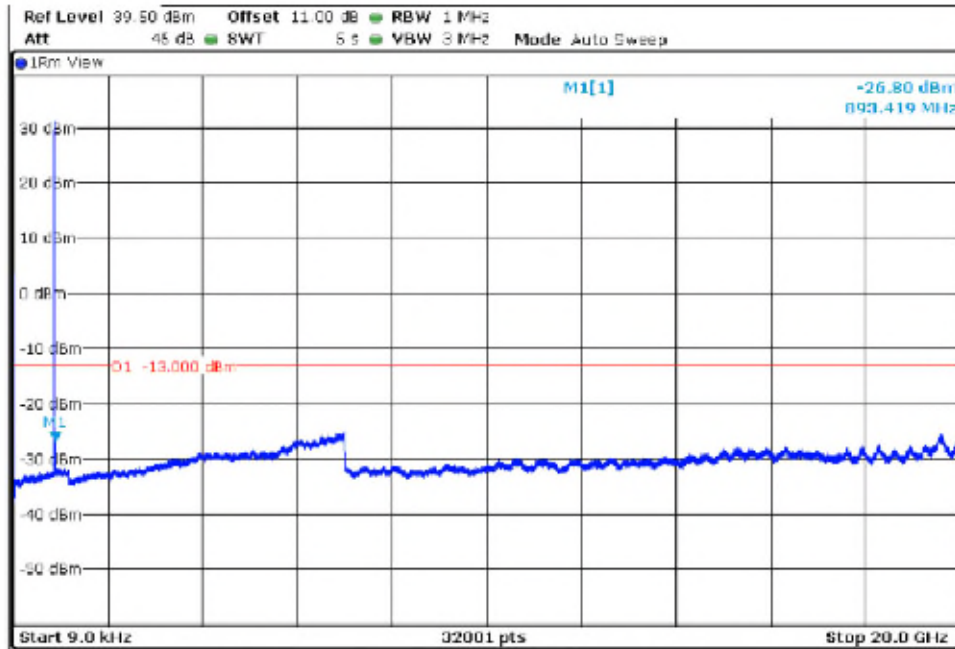

LTE QPSK MODULATION. BW = 3 MHz

Lowest Channel

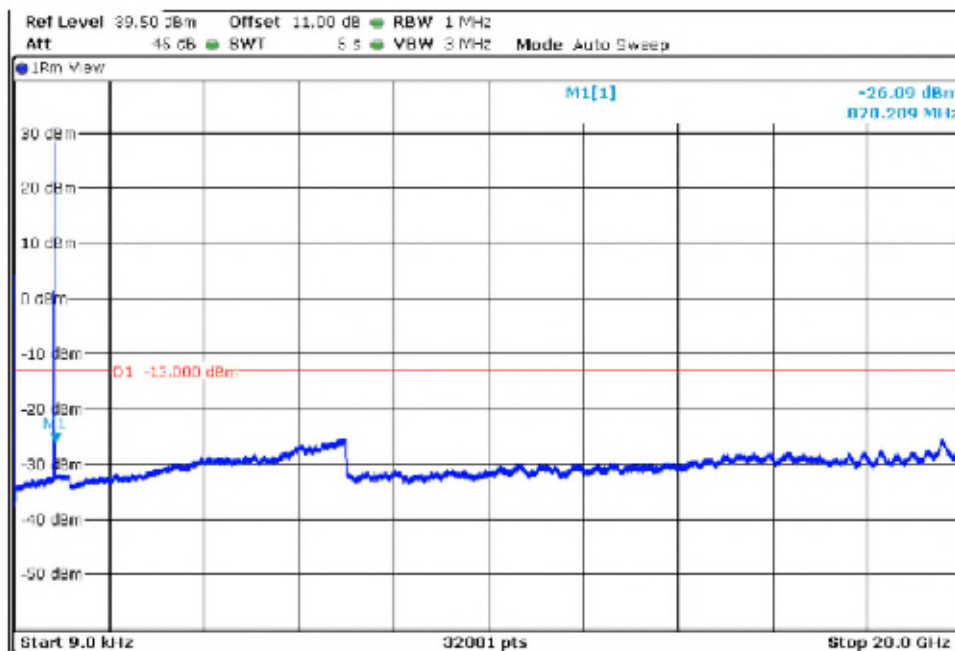

TEST RESULTS (Cont):

Middle Channel

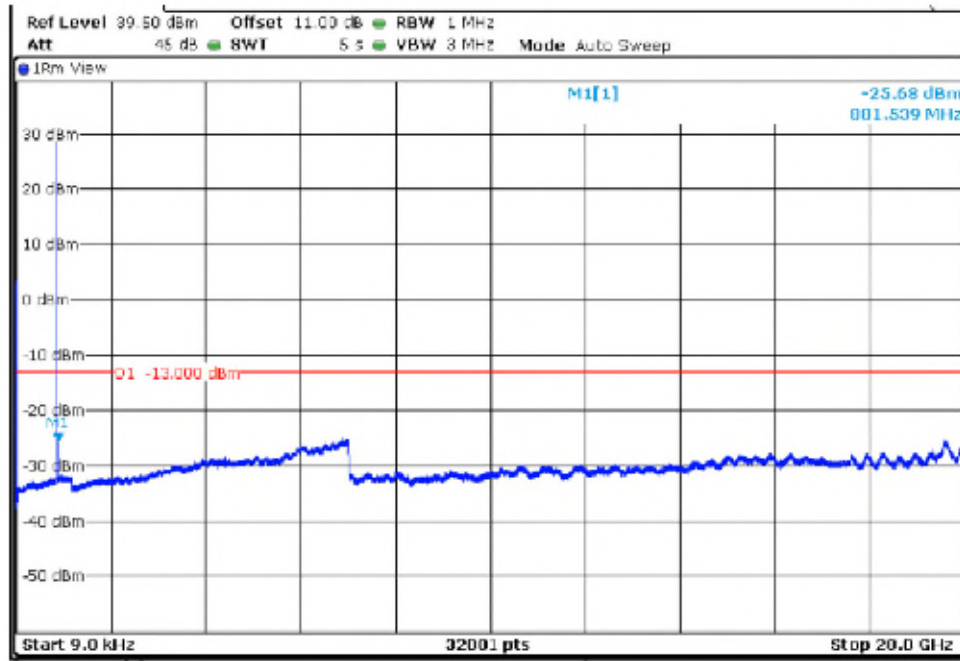

Highest Channel

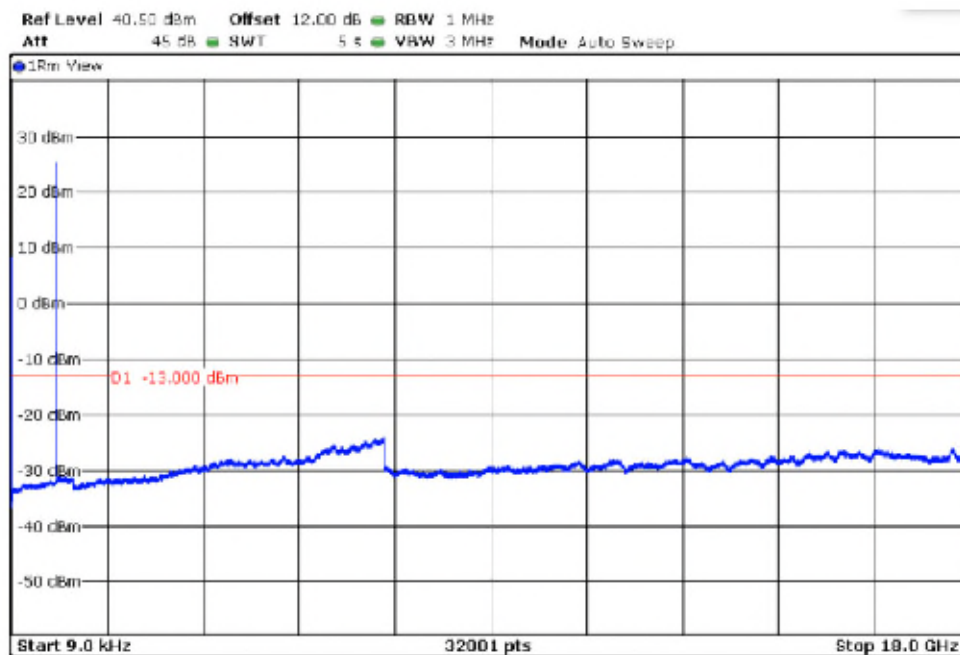

TEST RESULTS (Cont):

LTE QPSK MODULATION. BW = 5 MHz

Lowest Channel

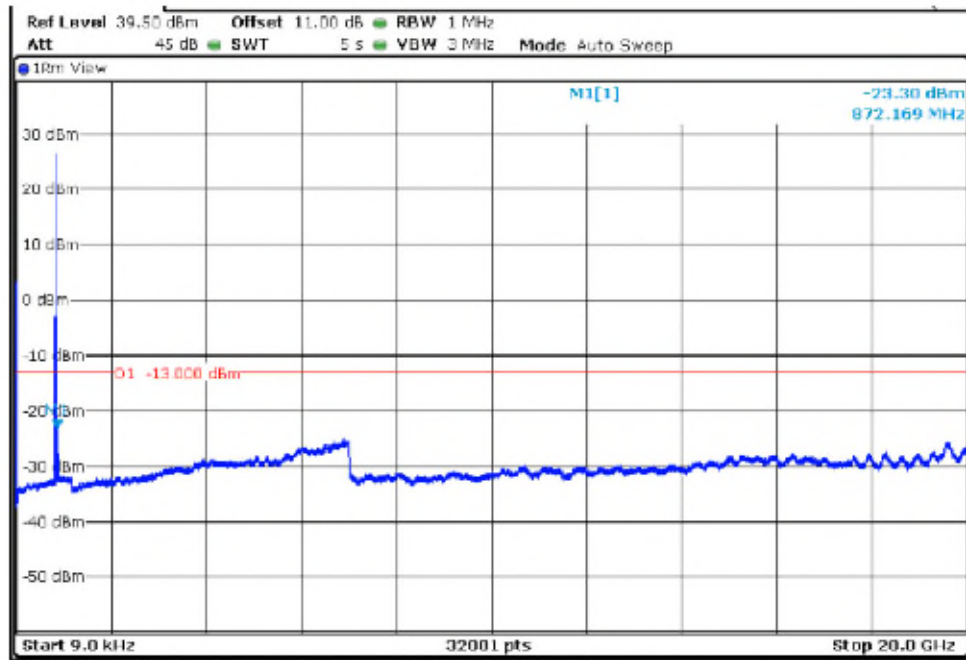

Middle Channel

