



FCC LISTED, REGISTRATION
 NUMBER: 2764.01

ISED LISTED REGISTRATION
 NUMBER: 23595-1

Test report No:
 2456ERM.011

Test report

REFERENCE STANDARD:
 USA FCC Part 22
 CANADA ISED RSS-132

Identification of item tested	Wireless Module
Trademark	Cinterion ALAS5-AM
Model and /or type reference	ALAS5-AM
Other identification of the product	FCC ID: QIPALAS5-AM IC: 7830A-ALAS5AM
Features	Wireless Module supporting 2G, 3G and 4G Cellular Technologies
Manufacturer	Gemalto M2M GmbH Werinherstr. 81, 81541 Munich, Germany.
Test method requested, standard	USA FCC Part 22 10-1-18 Edition CANADA IC RSS-132 Issue 3, Jan. 2013. Measurement Guidance 971168 D01 v02r02 for certification of Licensed Digital Transmitters. ANSI C63.26 – 2015.
Summary	IN COMPLIANCE
Approved by (name / position & signature)	<div style="display: flex; align-items: center;"> <div style="flex: 1;"> <p>Domingo Galvez EMC&RF Lab Manager</p> </div> <div style="flex: 0.5; text-align: center;">  </div> <div style="flex: 1; font-size: 8px; font-family: sans-serif;"> <p>Digitally signed by Domingo Galvez DN: cn=Domingo Galvez, o=DEKRA Certification Inc., ou=Regulatory Lab, email=dgalvez@dekra.com, c=US Date: 2019.07.25 19:29:23 -04'00'</p> </div> </div>
Date of issue	05-16-2019
Report template No	FDT08_21

Index

Competences and guarantees.....	3
General conditions	3
Uncertainty	3
Data provided by the client.....	4
Usage of samples	4
Test sample description.....	5
Identification of the client.....	6
Testing period and place	6
Document history	6
Environmental conditions	7
Remarks and comments.....	8
Testing verdicts.....	8
Summary	8
List of equipment used during the test.....	9
Appendix A: Test Results for FCC Part 22/ IC RSS-132.....	10

Competences and guarantees

DEKRA Certification Inc. is a testing laboratory accredited by A2LA (The American Association for Laboratory Accreditation), to perform the tests indicated in the Certificate 2764.01.

DEKRA Certification Inc. is a testing laboratory competent to carry out the tests described in this report.

In order to assure the traceability to other national and international laboratories, DEKRA Certification Inc. has a calibration and maintenance program for its measurement equipment.

DEKRA Certification Inc. guarantees the reliability of the data presented in this report, which is the result of the measurements and the tests performed to the item under test on the date and under the conditions stated on the report and, it is based on the knowledge and technical facilities available at DEKRA Certification at the time of performance of the test.

DEKRA Certification Inc. is liable to the client for the maintenance of the confidentiality of all information related to the item under test and the results of the test.

The results presented in this Test Report apply only to the particular item under test established in this document.

IMPORTANT: No parts of this report may be reproduced or quoted out of context, in any form or by any means, except in full, without the previous written permission of DEKRA Certification Inc.

General conditions

1. This report is only referred to the item that has undergone the test.
2. This report does not constitute or imply on its own an approval of the product by the Certification Bodies or competent Authorities.
3. This document is only valid if complete; no partial reproduction can be made without previous written permission of DEKRA Certification Inc.
4. This test report cannot be used partially or in full for publicity and/or promotional purposes without previous written permission of DEKRA Certification Inc. and the Accreditation Bodies.

Uncertainty

Uncertainty (factor $k=2$) was calculated according to the DEKRA Certification internal document PODT000.

Frequency (MHz)	U(k=2)	Units
30-180	3.82	dB
180-1000	2.61	dB
1000-18000	2.92	dB
18000-40000	2.15	dB

Data provided by the client

Wireless Module supporting 2G,3G and 4G Cellular Technologies.

DEKRA declines any responsibility with respect to the information provided by the client and that may affect the validity of results.

Usage of samples

Samples undergoing test have been selected by: The client.

Sample S/01 is composed of the following elements:

Control N°	Description	Model	Serial N°	Date of reception
2456.08	Cinterion® ALAS5	ALAS5-AM	004401083051280	3/25/2019
2456.10	Cinterion® ALAS5	ALAS5-AM	004401083051652	3/25/2019
2456.05	Antenna	Panorama_LPBEM-7-27	-	2/7/2019
2456.06	Antenna	Panorama_LPBEM-7-27	-	2/7/2019

1. Sample S/01 was used for the following test(s):

All conducted and radiated tests indicated in appendix A.

Test sample description

Ports..... :	Port name and description		Cable				
			Specified length [m]	Attached during test		Shielded	
	No Data Provided			<input type="checkbox"/>		<input type="checkbox"/>	
				<input type="checkbox"/>		<input type="checkbox"/>	
				<input type="checkbox"/>		<input type="checkbox"/>	
				<input type="checkbox"/>		<input type="checkbox"/>	
Supplementary information to the ports..... :	No Data Provided						
Rated power supply..... :	Voltage and Frequency			Reference poles			
				L1	L2	L3	N
	<input type="checkbox"/>	AC: 230Vac / 50Hz.	<input type="checkbox"/>	<input type="checkbox"/>	<input type="checkbox"/>	<input type="checkbox"/>	<input type="checkbox"/>
	<input type="checkbox"/>	AC:	<input type="checkbox"/>	<input type="checkbox"/>	<input type="checkbox"/>	<input type="checkbox"/>	<input type="checkbox"/>
	<input checked="" type="checkbox"/>	DC: 3.3 to 4.2V					
<input checked="" type="checkbox"/>	DC: 3.8V						
Rated Power..... :	No Data Provided						
Clock frequencies..... :	No Data Provided						
Other parameters..... :	No Data Provided						
Software version..... :	Rev. 1.1.4b						
Hardware version..... :	Rev 00.052						
Dimensions in cm (L x W x D) ... :	No Data Provided						
Mounting position..... :	<input type="checkbox"/>	Table top equipment					
	<input type="checkbox"/>	Wall/Ceiling mounted equipment					
	<input type="checkbox"/>	Floor standing equipment					
	<input type="checkbox"/>	Hand-held equipment					
	<input type="checkbox"/>	Other:					
Modules/parts..... :	Module/parts of test item		Type		Manufacturer		
	No Data provided						

Accessories (not part of the test item)..... :	Description	Type	Manufacturer
Documents as provided by the applicant..... :	Description	File name	Issue date
	Equipment declaration data	FDT30_15_Declaration_Equipment_Data_Gemalto_ALAS5-AM_signed	2019-05-16

Copy of marking plate:



Identification of the client

Gemalto M2M GmbH
 Werinherstr. 81, 81541 Munich, Germany

Testing period and place

Test Location	DEKRA Certification, Inc.
Date (start)	04-04-2019
Date (finish)	05-06-2019

Document history

Report number	Date	Description
2456ERM.011	05-16-2019	First release

Environmental conditions

In the control chamber, the following limits were not exceeded during the test:

Temperature	Min. = 15 °C Max. = 35 °C
Relative humidity	Min. = 30 % Max. = 75 %
Air pressure	Min. = 860 mbar Max. = 1060 mbar

In the semi anechoic chamber, the following limits were not exceeded during the test.

Temperature	Min. = 15 °C Max. = 35 °C
Relative humidity	Min. = 30 % Max. = 75 %
Air pressure	Min. = 860 mbar Max. = 1060 mbar

In the chamber for conducted measurements, the following limits were not exceeded during the test:

Temperature	Min. = 15 °C Max. = 35 °C
Relative humidity	Min. = 30 % Max. = 60 %
Air pressure	Min. = 860 mbar Max. = 1060 mbar

Remarks and comments

The tests have been performed by the technical personnel: Sravani Gollamudi and Poojitha Bhattu.

Testing verdicts

Not applicable :	N/A
Pass :	P
Fail :	F
Not measured :	N/M

Summary

FCC PART 22 / IC RSS-132 PARAGRAPH					
Report Section	FCC Spec Clause	RSS Spec Clause	Test Description	Verdict	Remark
A.1	§2.1046 and §22.913	RSS-132 Clause 5.4	RF Output power	P	N/A
A.2	§2.1047	RSS-132 Clause 5.2	Modulation characteristics	P	N/A
A.3	§2.1055 and §22.355	RSS-132 Clause 5.3	Frequency stability	P	N/A
A.4	§2.1049	RSS-132 Clause 5.1	Occupied Bandwidth	P	N/A
A.5	§2.1051 and §22.917	RSS-132 Clause 5.5	Spurious emissions at antenna terminals	P	N/A
A.6	§22.917	RSS-132 Clause 5.5	Spurious emissions at antenna terminals at Block edges	P	N/A
A.7	§2.1053 and §22.917	RSS-132 Clause 5.5	Radiated emissions	P	N/A
<u>Supplementary information and remarks:</u>					
N/A					

List of equipment used during the test

Conducted Measurements

CONTROL NUMBER	DESCRIPTION	LAST CALIBRATION	NEXT CALIBRATION
1039	Signal analyzer Rohde & Schwarz FSV40	2018/10	2020/10
1149	Wideband Radio Communication Tester Rohde & Schwarz CMW 500	2018/07	2020/07
1041	EMI Test Receiver Rohde & Schwarz ESR 7	2017/04	2019/08
101	Climatic chamber Espec	2019/10	2020/10

Radiated Measurements

CONTROL NUMBER	DESCRIPTION	LAST CALIBRATION	NEXT CALIBRATION
1179	Semi anechoic Absorber Lined Chamber Frankonia SAC 3 plus "L"	N/A	N/A
1064	Biconical Log antenna ETS LINDGREN 3142E	2017/03	2020/03
1057	Double-ridge Waveguide Horn antenna 1-18 GHz	2017/03	2020/03
1012	Spectrum analyzer Rohde & Schwarz ESR26	2018/09	2020/09
1039	Spectrum analyzer Rohde & Schwarz FSV40	2018/10	2020/10
1015, 1017, 1019, 1020	Rohde & Schwarz EMC32 software	N/A	N/A

Appendix A: Test Results for FCC Part 22/ IC RSS-132

Appendix A Content

PRODUCT INFORMATION	12
DESCRIPTION OF TEST CONDITIONS	13
TEST A.1: RF OUTPUT POWER	15
TEST A.2: MODULATION CHARACTERISTICS.....	39
TEST A.3: FREQUENCY STABILITY	43
TEST A.4: OCCUPIED BANDWIDTH	47
TEST A.5: SPURIOUS EMISSIONS AT ANTENNA TERMINALS.....	85
TEST A.6: SPURIOUS EMISSIONS AT ANTENNA TERMINALS AT BLOCK EDGES.....	98
TEST A.7: RADIATED EMISSIONS.....	111

PRODUCT INFORMATION

The following information is provided by the client

Information	Description
Modulation	LTE: QPSK, QAM 2G: GPRS, EDGE 3G: WCDMA
Maximum RF Output Power	LTE: 25 dBm 2G: 30 dBm 3G: 25 dBm
Operation mode:	
- Operating Frequency Range	LTE: Band 5 2G: 850 MHz 3G: Band V
- Nominal Channel Bandwidth	LTE Band 5: 1.4/ 3/ 5/ 10 MHz
Extreme operating conditions	
- Temperature range	$T_{nom} = +15$ to $+35$ $T_{min} = -30$ $T_{max} = +50$
Antenna type	External attachable Antenna.
Antenna gain	3 dBi
Nominal Voltage	
- Supply Voltage	3.8 Vdc
- Type of power source	DC voltage from power supply.

DESCRIPTION OF TEST CONDITIONS

The worst case was found when positioned as the table below. Following channel(s) was (were) selected for the final test as listed below:

TEST CONDITIONS	DESCRIPTION												
<p>TC#01 LTE Band 5</p>	<p><u>Power supply (V):</u> $V_{\text{nominal}} = 3.8 \text{ Vdc}$</p> <p><u>Test Frequencies for Conducted tests:</u></p> <p><u>1.4 MHz Bandwidth:</u> -Lowest Channel: 20407 (824.7 MHz) -Middle Channel: 20525 (836.5 MHz) -Highest Channel: 20643 (848.3 MHz)</p> <p><u>3 MHz Bandwidth:</u> -Lowest Channel: 20415 (825.5 MHz) -Middle Channel: 20525 (836.5 MHz) -Highest Channel: 20635 (847.5 MHz)</p> <p><u>5 MHz Bandwidth:</u> -Lowest Channel: 20425 (826.5 MHz) -Middle Channel: 20525 (836.5 MHz) -Highest Channel: 20625 (846.5 MHz)</p> <p><u>10 MHz Bandwidth:</u> -Lowest Channel: 20450 (829 MHz) -Middle Channel: 20525 (836.5 MHz) -Highest Channel: 20600 (844 MHz)</p> <p><u>Test Frequencies for Radiated tests:</u></p> <table border="1" data-bbox="416 1619 1337 1901"> <thead> <tr> <th>Available Frequencies</th> <th>Tested Frequency</th> <th>Channel Bandwidth</th> <th>Modulation</th> <th>Mode</th> </tr> </thead> <tbody> <tr> <td rowspan="3">824 to 849 MHz</td> <td>825.5 MHz</td> <td rowspan="3">3 MHz</td> <td rowspan="3">QPSK</td> <td rowspan="3">1 RB</td> </tr> <tr> <td>836.5 MHz</td> </tr> <tr> <td>847.5 MHz</td> </tr> </tbody> </table> <p>Note: This device was tested under all bandwidths, RB configurations and modulations. The worst case found in QPSK modulation.</p>	Available Frequencies	Tested Frequency	Channel Bandwidth	Modulation	Mode	824 to 849 MHz	825.5 MHz	3 MHz	QPSK	1 RB	836.5 MHz	847.5 MHz
Available Frequencies	Tested Frequency	Channel Bandwidth	Modulation	Mode									
824 to 849 MHz	825.5 MHz	3 MHz	QPSK	1 RB									
	836.5 MHz												
	847.5 MHz												

TEST CONDITIONS	DESCRIPTION										
<p>TC#02 2G Band 850</p>	<p><u>Power supply (V):</u> $V_{\text{nominal}} = 3.8 \text{ Vdc}$</p> <p><u>Test Frequencies for Conducted tests:</u> <u>GPRS/EDGE:</u> -Lowest Channel: 128 (824.2 MHz) -Middle Channel: 190 (836.6 MHz) -Highest Channel: 251 (848.8 MHz)</p> <p><u>Test Frequencies for Radiated tests:</u></p> <table border="1" data-bbox="411 815 1222 1102"> <thead> <tr> <th>Available Frequencies</th> <th>Tested Frequency</th> <th>Channel Bandwidth</th> <th>Modulation</th> </tr> </thead> <tbody> <tr> <td rowspan="3">824 to 849 MHz</td> <td>824.2 MHz</td> <td rowspan="3">300 KHz</td> <td rowspan="3">GPRS</td> </tr> <tr> <td>836.6 MHz</td> </tr> <tr> <td>848.8 MHz</td> </tr> </tbody> </table> <p>Note: This device was tested under all modulations. The worst case found in GPRS modulation.</p>	Available Frequencies	Tested Frequency	Channel Bandwidth	Modulation	824 to 849 MHz	824.2 MHz	300 KHz	GPRS	836.6 MHz	848.8 MHz
Available Frequencies	Tested Frequency	Channel Bandwidth	Modulation								
824 to 849 MHz	824.2 MHz	300 KHz	GPRS								
	836.6 MHz										
	848.8 MHz										
<p>TC#03 3G Band V</p>	<p><u>Power supply (V):</u> $V_{\text{nominal}} = 3.8 \text{ Vdc}$</p> <p><u>Test Frequencies for Conducted tests:</u> <u>WCDMA:</u> -Lowest Channel: 4132 (826.4 MHz) -Middle Channel: 4182 (836.4 MHz) -Highest Channel: 4233 (846.6 MHz)</p> <p><u>Test Frequencies for Radiated tests:</u></p> <table border="1" data-bbox="411 1644 1222 1930"> <thead> <tr> <th>Available Frequencies</th> <th>Tested Frequency</th> <th>Channel Bandwidth</th> <th>Modulation</th> </tr> </thead> <tbody> <tr> <td rowspan="3">824 to 849 MHz</td> <td>826.4 MHz</td> <td rowspan="3">5 MHz</td> <td rowspan="3">WCDMA</td> </tr> <tr> <td>836.4 MHz</td> </tr> <tr> <td>846.6 MHz</td> </tr> </tbody> </table> <p>Note: This device was tested under all modulations. The worst case found in WCDMA modulation.</p>	Available Frequencies	Tested Frequency	Channel Bandwidth	Modulation	824 to 849 MHz	826.4 MHz	5 MHz	WCDMA	836.4 MHz	846.6 MHz
Available Frequencies	Tested Frequency	Channel Bandwidth	Modulation								
824 to 849 MHz	826.4 MHz	5 MHz	WCDMA								
	836.4 MHz										
	846.6 MHz										

TEST A.1: RF OUTPUT POWER

LIMITS:	Product standard:	FCC Part 22 / IC RSS-132
	Test standard:	FCC §2.1046 and §22.913 / RSS-132 Clause 5.4

LIMITS

The ERP of mobile transmitters and auxiliary test transmitters must not exceed 7 Watts.

The peak-to-average ratio (PAR) of the transmission shall not exceed 13 dB.

RSS-132 Clause 5.4

The transmitter output power shall be measured in terms of average power. The equivalent isotropically radiated power (e.i.r.p.) for mobile equipment shall not exceed 11.5 watts. Refer to SRSP-503 for base station e.i.r.p. limits. In addition, the peak-to-average power ratio (PAPR) of the transmitter shall not exceed 13 dB for more than 0.1% of the time using a signal corresponding to the highest PAPR during periods of continuous transmission.

TEST SETUP

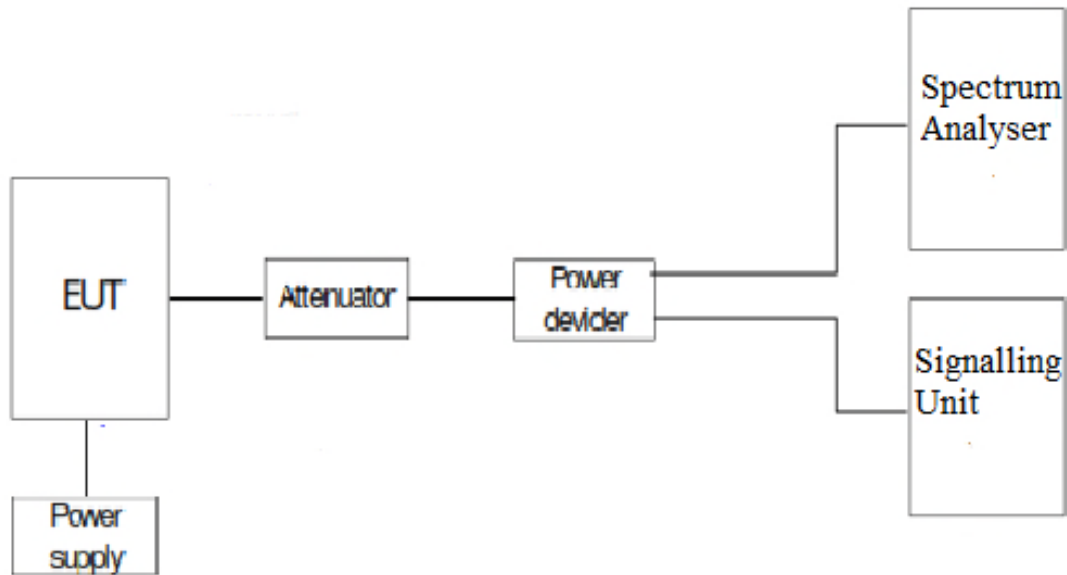

TESTED SAMPLES:	S/01
TESTED CONDITIONS MODES:	TC#01
TEST RESULTS:	PASS

LTE QPSK AND 16QAM MODULATION. Bandwidth = 1.4 MHz

Channel	Average power at antenna port (dBm)	Maximum declared antenna gain (dBi)	Maximum E.I.R.P. average power (dBm)	PAPR (dB)
Lowest	23.02	3.0	26.02	5.54
Middle	23.04	3.0	26.04	5.88
Highest	23.05	3.0	26.05	6
Measurement uncertainty (dB)			<±0.95	

LTE QPSK AND 16QAM MODULATION. Bandwidth = 3 MHz

Channel	Average power at antenna port (dBm)	Maximum declared antenna gain (dBi)	Maximum E.I.R.P. average power (dBm)	PAPR (dB)
Lowest	23.02	3.0	26.02	5.39
Middle	23.19	3.0	26.19	5.86
Highest	23.16	3.0	26.16	5.51
Measurement uncertainty (dB)			<±0.95	

LTE QPSK AND 16QAM MODULATION. Bandwidth = 5 MHz

Channel	Average power at antenna port (dBm)	Maximum declared antenna gain (dBi)	Maximum E.I.R.P. average power (dBm)	PAPR (dB)
Lowest	23.08	3.0	26.08	5.51
Middle	23.11	3.0	26.11	5.86
Highest	23.09	3.0	26.09	5.54
Measurement uncertainty (dB)			<±0.95	

LTE QPSK AND 16QAM MODULATION. Bandwidth = 10 MHz

Channel	Average power at antenna port (dBm)	Maximum declared antenna gain (dBi)	Maximum E.I.R.P. average power (dBm)	PAPR (dB)
Lowest	23.05	3.0	26.05	5.30
Middle	23.04	3.0	26.04	5.80
Highest	23.06	3.0	26.06	5.25
Measurement uncertainty (dB)			<±0.95	

TEST RESULTS (Cont):						
BANDWIDTH (MHz)	CHANNEL FREQUENCY (MHz)	MODULATION	RB SIZE	RB OFFSET	AVERAGE POWER (dBm)	PAPR (dB)
1.4	Low 20407 824.7	QPSK	1	0	22.87	4.67
			1	2	22.97	
			1	5	22.9	
			3	0	22.99	
			3	2	23.02	
			6	0	21.9	
	16-QAM	1	0	21.81	5.54	
		1	2	21.87		
		1	5	21.85		
		3	0	21.86		
		3	2	21.9		
		6	0	20.97		
	Middle 20525 836.5	QPSK	1	0	23.00	4.93
			1	2	23.03	
			1	5	22.96	
			3	0	23.01	
			3	2	23.04	
			6	0	22	
	16-QAM	1	0	22.23	5.88	
		1	2	22.27		
		1	5	22.23		
		3	0	22.01		
		3	2	22.03		
		6	0	21.02		
High 20643 848.3	QPSK	1	0	22.94	5.04	
		1	2	23.02		
		1	5	22.9		
		3	0	23		
		3	2	23.05		
		6	0	21.95		
16-QAM	1	0	22.21	6		
	1	2	22.24			
	1	5	22.17			
	3	0	21.93			
	3	2	22			
	6	0	21.08			

TEST RESULTS (Cont):						
BANDWIDTH (MHz)	CHANNEL FREQUENCY (MHz)	MODULATION	RB SIZE	RB OFFSET	AVERAGE POWER (dBm)	PAPR (dB)
3	Low 20415 825.5	QPSK	1	0	22.97	4.49
			1	7	23.02	
			1	14	22.94	
			8	0	21.97	
			8	7	21.99	
			15	0	21.97	
		16-QAM	1	0	22.19	5.39
			1	7	22.27	
			1	14	22.15	
			8	0	21.19	
			8	7	21.15	
			15	0	20.99	
	Middle 20525 836.5	QPSK	1	0	23.1	4.84
			1	7	23.19	
			1	14	23.04	
			8	0	22.08	
			8	7	22.02	
			15	0	22.04	
		16-QAM	1	0	22.36	5.86
			1	7	22.45	
			1	14	22.29	
			8	0	21.22	
			8	7	21.21	
			15	0	21.09	
High 20635 847.5	QPSK	1	0	23.06	4.52	
		1	7	23.16		
		1	14	23.02		
		8	0	22.03		
		8	7	22.01		
		15	0	22.07		
	16-QAM	1	0	22.29	5.51	
		1	7	22.34		
		1	14	22.25		
		8	0	21.17		
		8	7	21.15		
		15	0	21.07		

TEST RESULTS (Cont):						
BANDWIDTH (MHz)	CHANNEL FREQUENCY (MHz)	MODULATION	RB SIZE	RB OFFSET	AVERAGE POWER (dBm)	PAPR (dB)
5	Low 20425 826.5	QPSK	1	0	23.03	4.46
			1	12	22.99	
			1	24	23.08	
			12	0	21.99	
			12	11	22.06	
			25	0	21.96	
		16-QAM	1	0	22.11	5.51
			1	12	22.1	
			1	24	22.24	
			12	0	21.05	
			12	11	21.15	
			25	0	20.96	
	Middle 20525 836.5	QPSK	1	0	23.11	4.81
			1	12	23.06	
			1	24	23.09	
			12	0	22.08	
			12	11	22.08	
			25	0	22.08	
		16-QAM	1	0	22.21	5.86
			1	12	22.16	
			1	24	22.12	
			12	0	21.18	
			12	11	21.19	
			25	0	21.1	
High 20625 846.5	QPSK	1	0	23.09	4.75	
		1	12	23.05		
		1	24	23.04		
		12	0	22.11		
		12	11	22.06		
		25	0	22.08		
	16-QAM	1	0	22.5	5.54	
		1	12	22.46		
		1	24	22.48		
		12	0	21		
		12	11	21		
		25	0	21.06		

TEST RESULTS (Cont):						
BANDWIDTH (MHz)	CHANNEL FREQUENCY (MHz)	MODULATION	RB SIZE	RB OFFSET	AVERAGE POWER (dBm)	PAPR (dB)
10	Low 20450 829	QPSK	1	0	22.95	4.49
			1	24	23.01	
			1	49	23.05	
			25	0	22.02	
			25	24	22.01	
			50	0	22.05	
		16-QAM	1	0	22.17	5.3
			1	24	22.21	
			1	49	22.29	
			25	0	21.03	
	25		24	21.12		
	50		0	21.1		
	Middle 20525 836.5	QPSK	1	0	23.04	4.84
			1	24	23.04	
			1	49	22.98	
			25	0	22.11	
			25	24	22.05	
			50	0	22.08	
		16-QAM	1	0	22.25	5.8
			1	24	22.33	
			1	49	22.27	
			25	0	21.12	
	25		24	21.09		
	50		0	21.03		
High 20600 844	QPSK	1	0	23.02	4.52	
		1	24	23.06		
		1	49	23		
		25	0	22.04		
		25	24	22.09		
		50	0	22.15		
		16-QAM	1	0		22.23
	1		24	22.27		
	1		49	22.26		
	25		0	21.1		
	25		24	21.26		
	50		0	21.13		

TEST RESULTS (Cont):

PAPR

Bandwidth = 1.4 MHz. Modulation QPSK. RB Size: 1. RB Offset: 0.

Lowest channel

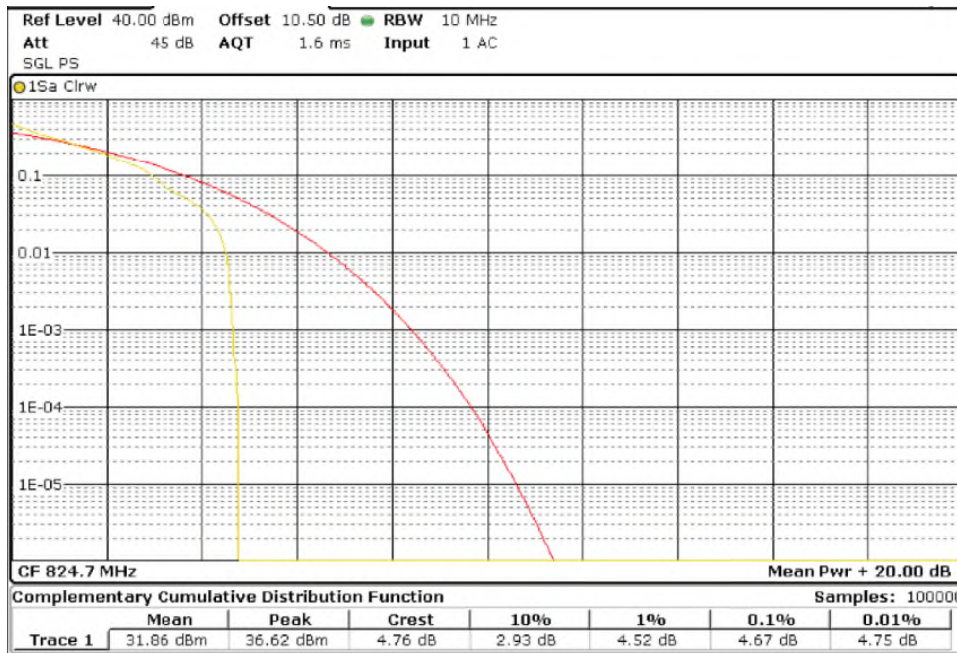

Middle channel



TEST RESULTS (Cont):

Highest channel

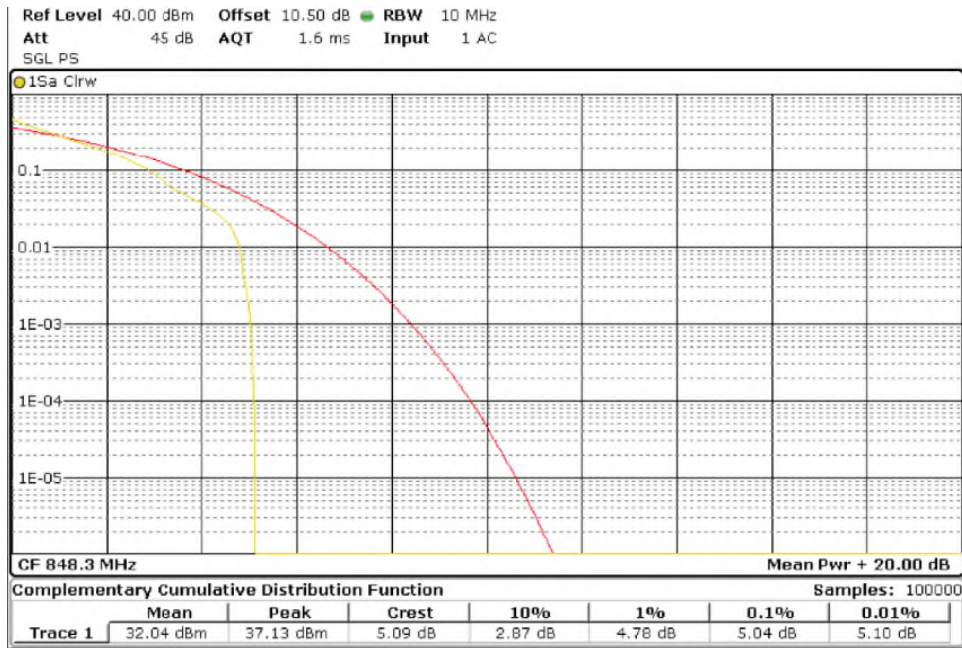

PAPR

Bandwidth = 1.4 MHz. Modulation 16QAM. RB Size: 1. RB Offset: 0.

Lowest channel

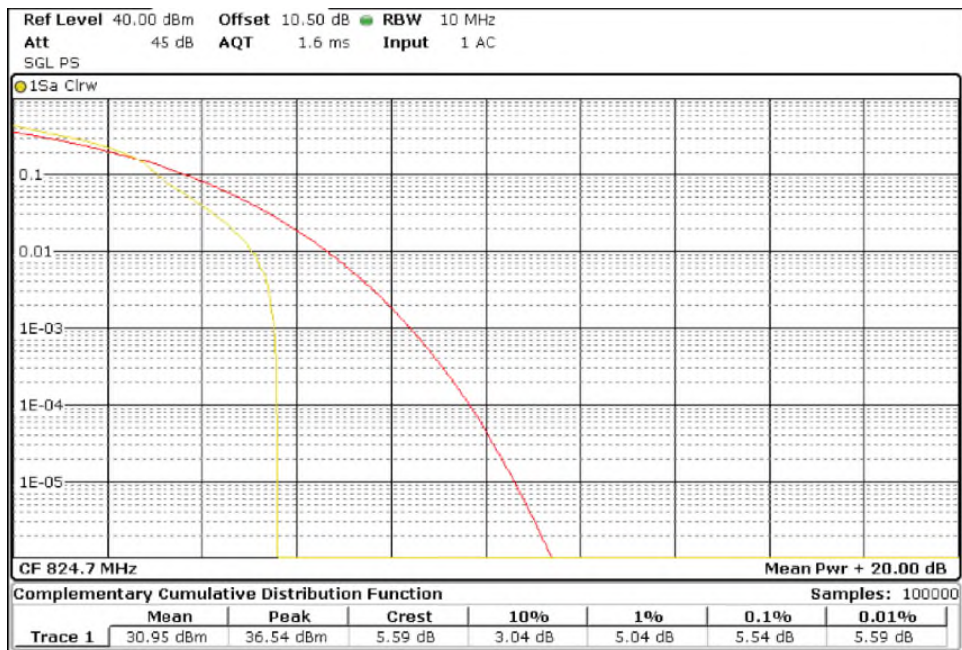

TEST RESULTS (Cont):

Middle channel

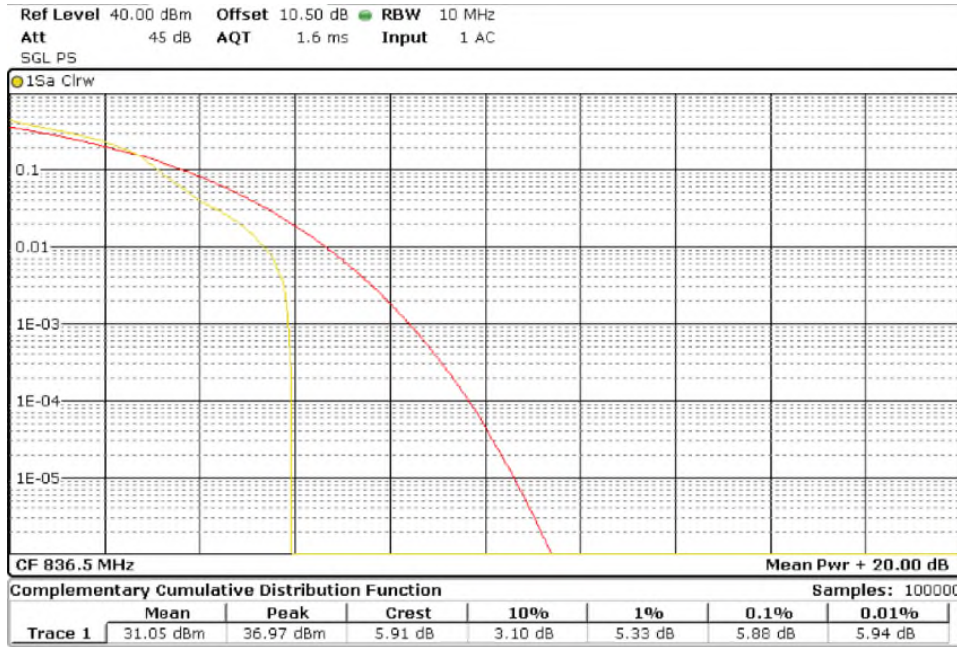

Highest channel

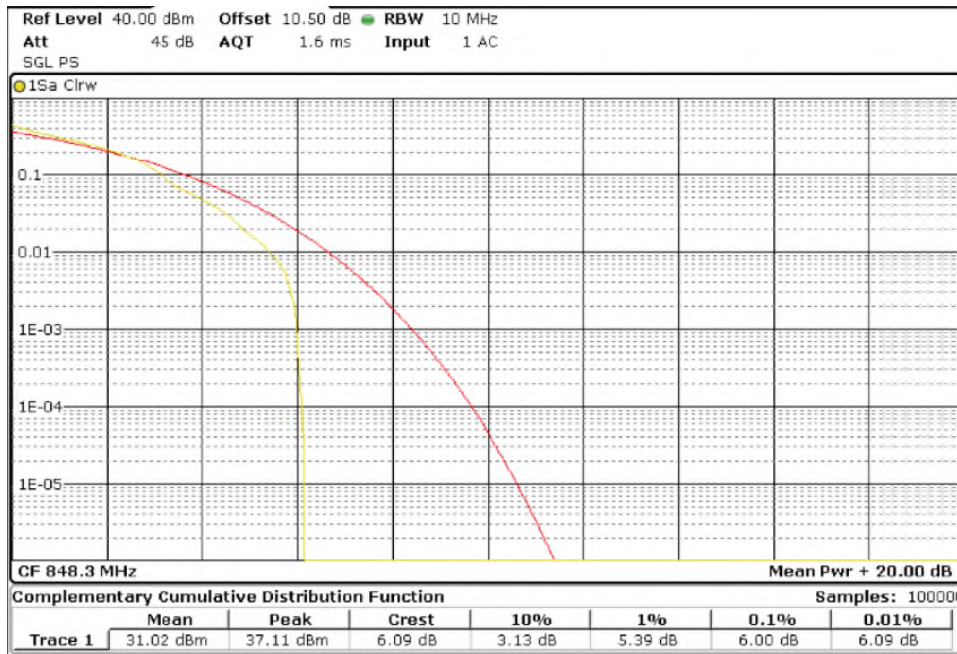

TEST RESULTS (Cont):

PAPR

Bandwidth = 3 MHz. Modulation QPSK. RB Size: 1. RB Offset: 0.

Lowest channel

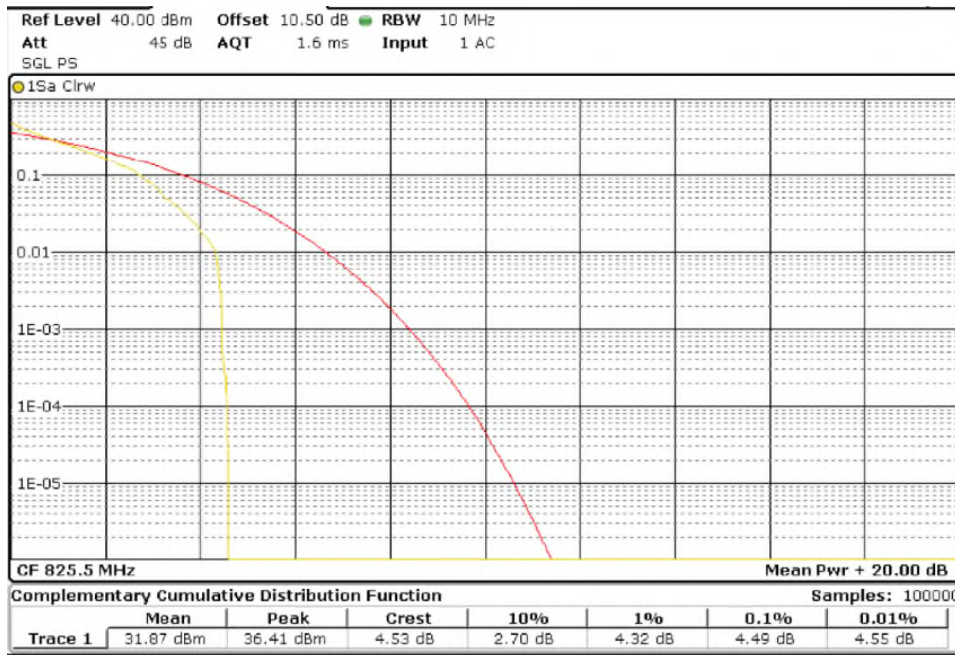

Middle channel

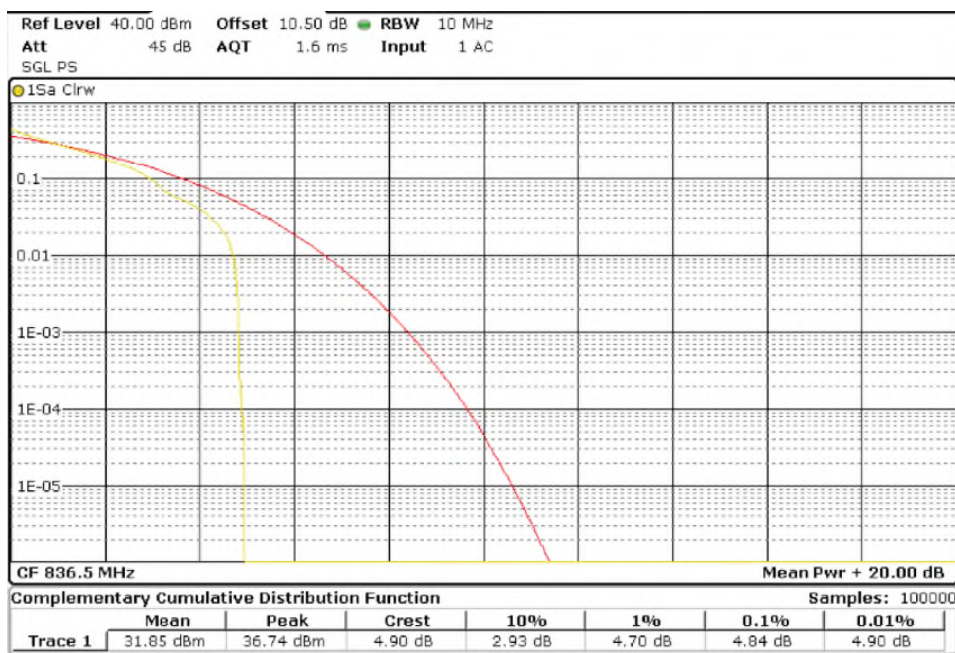

TEST RESULTS (Cont):

Highest channel

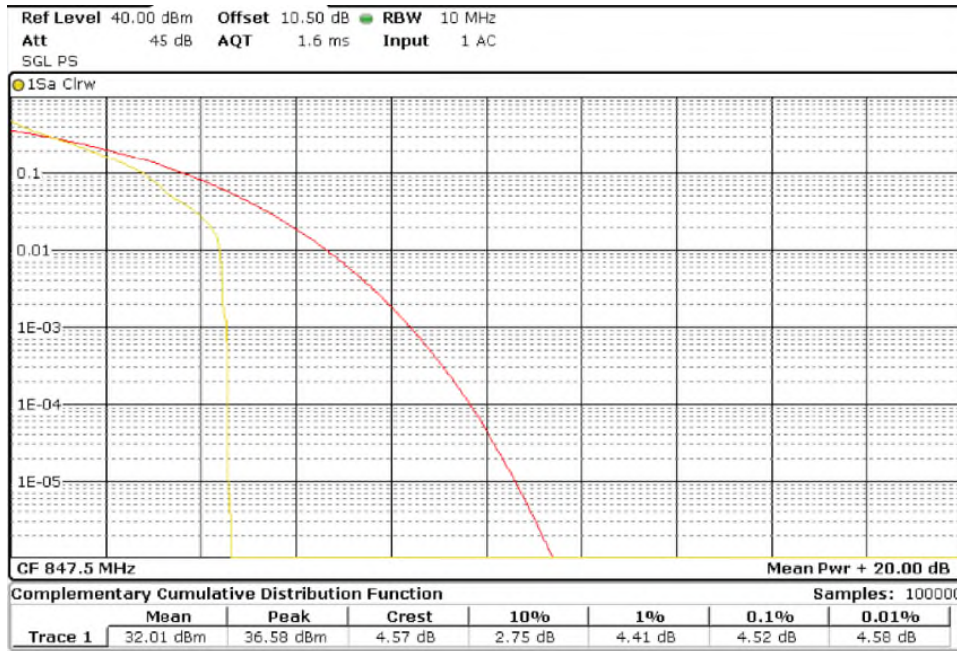

PAPR

Bandwidth = 3 MHz. Modulation 16QAM. RB Size: 1. RB Offset: 0.

Lowest channel

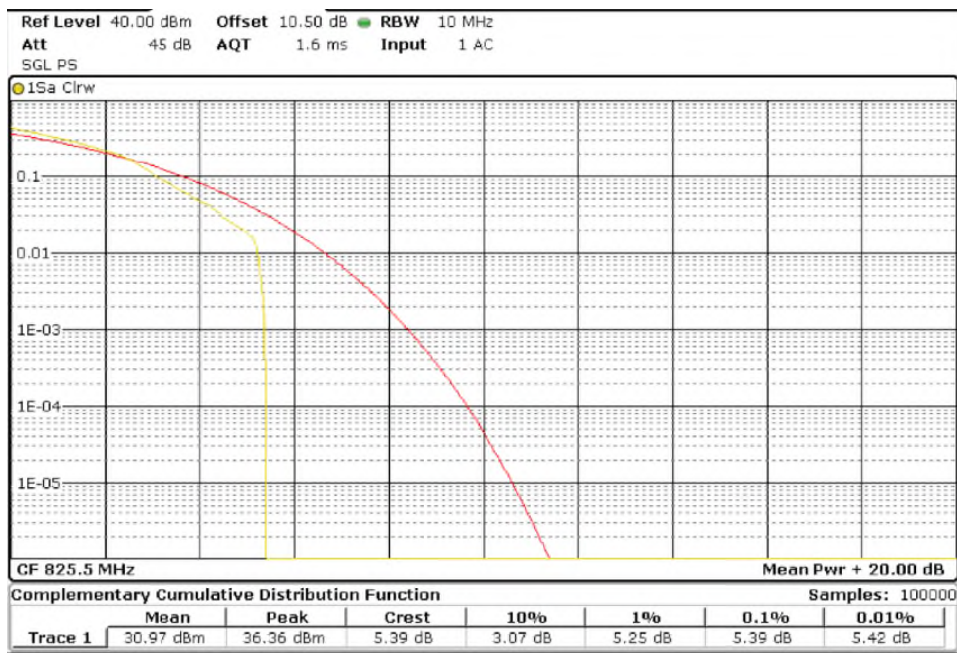

TEST RESULTS (Cont):

Middle channel

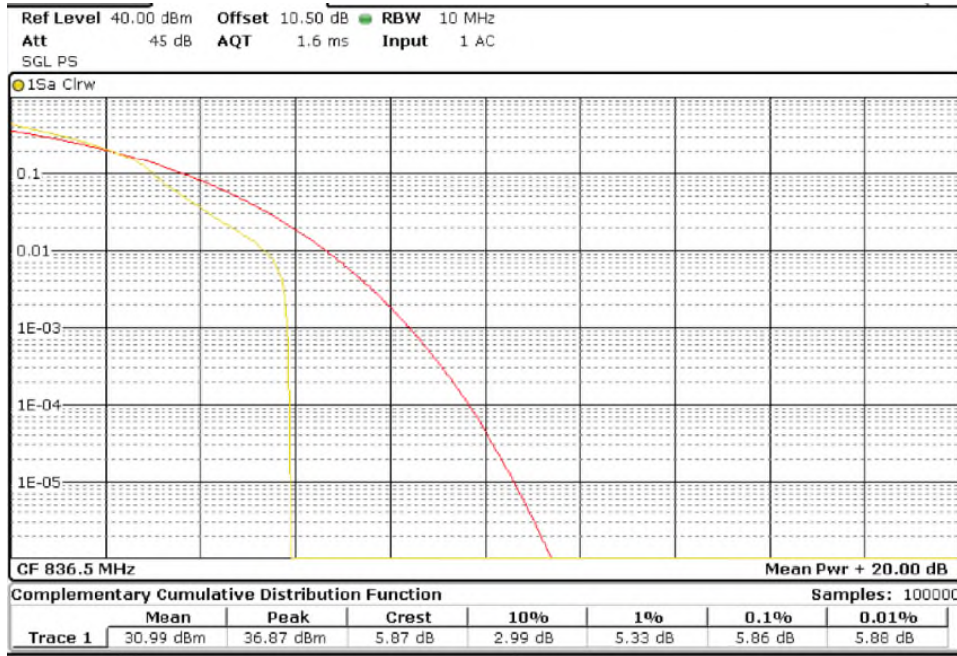

Highest channel

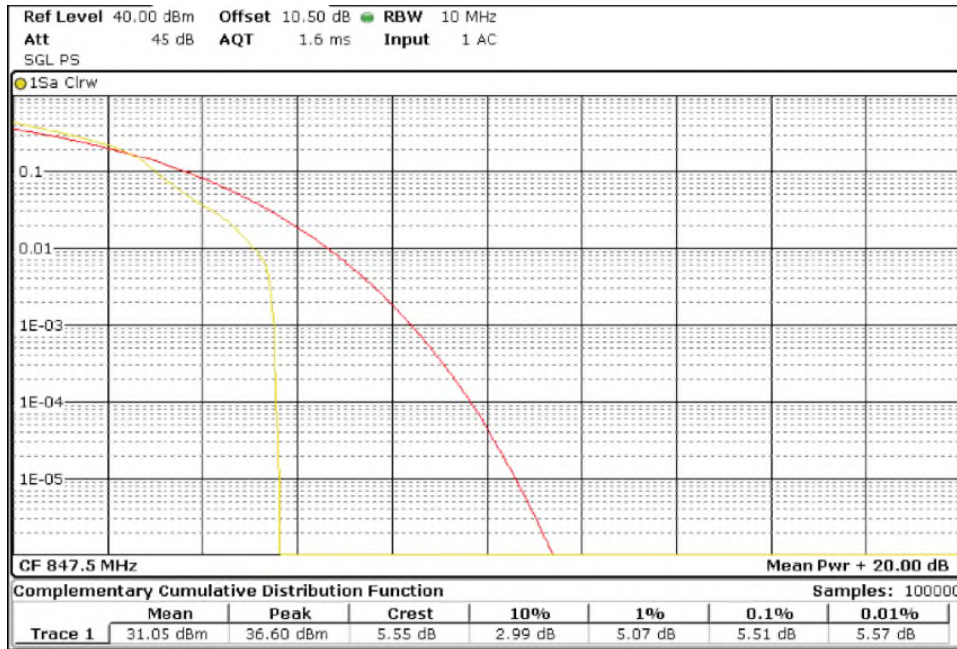

TEST RESULTS (Cont):

PAPR

Bandwidth = 5 MHz Modulation QPSK. RB Size: 1. RB Offset: 0.

Lowest channel

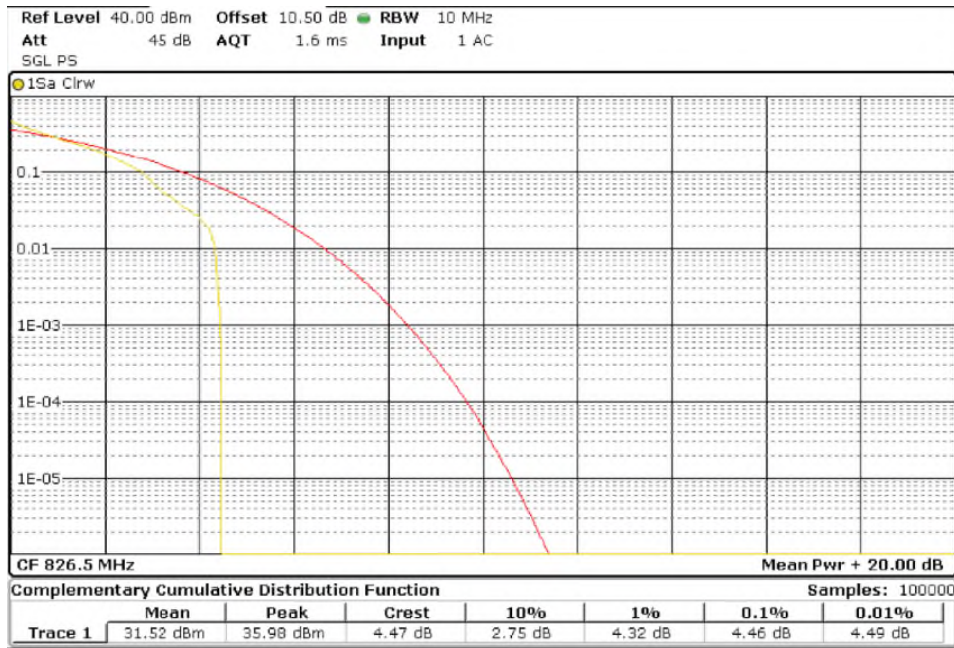

Middle channel

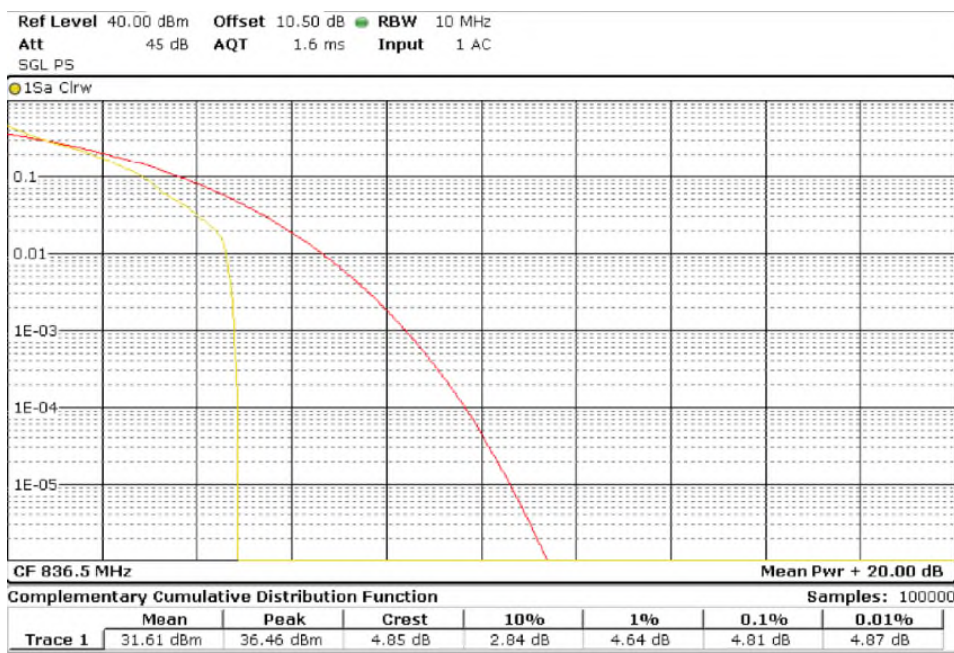

TEST RESULTS (Cont):

Highest channel

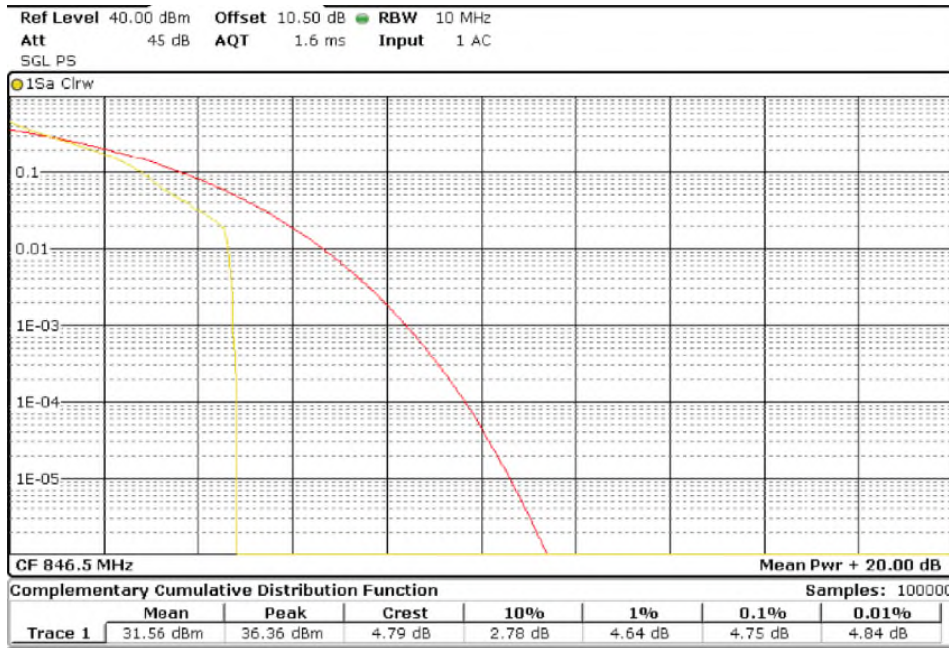

Bandwidth = 5 MHz Modulation 16QAM. RB Size: 1. RB Offset: 0.

Lowest channel

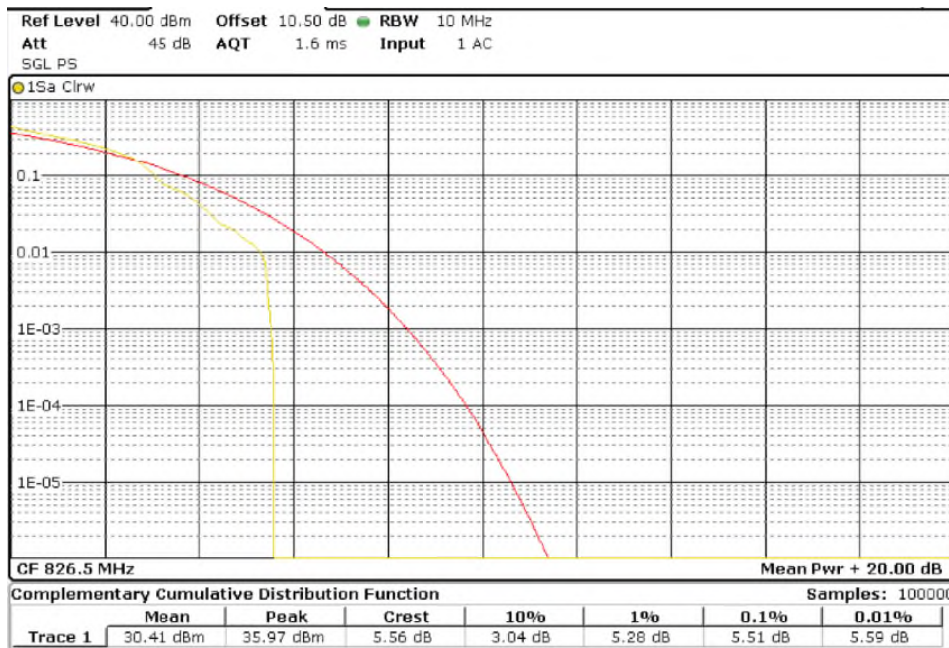

TEST RESULTS (Cont):

Middle channel

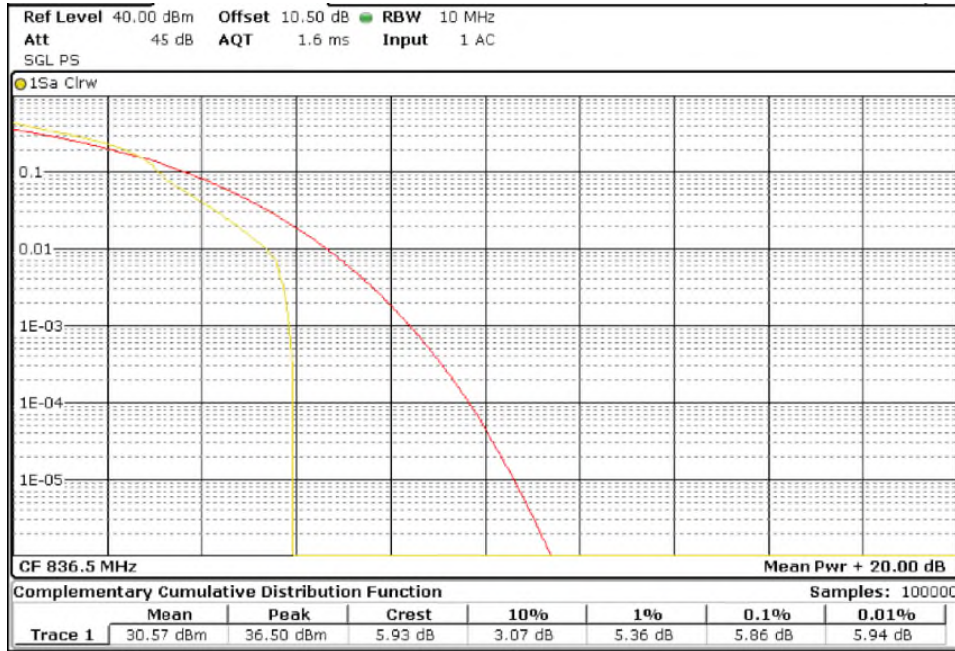

Highest channel

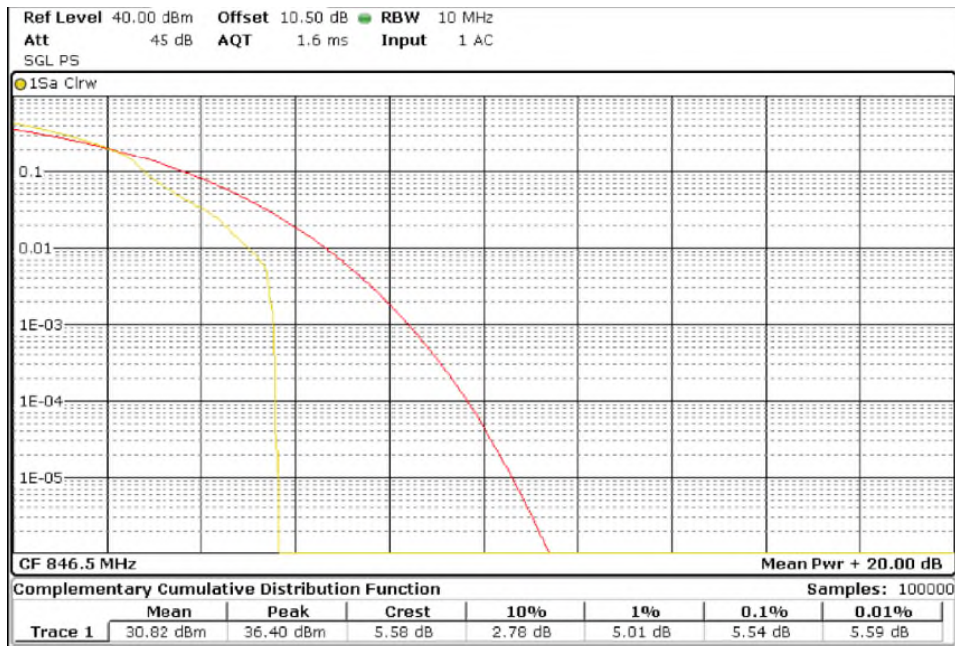

TEST RESULTS (Cont):

Bandwidth = 10 MHz Modulation QPSK. RB Size: 1. RB Offset: 0.

Lowest channel

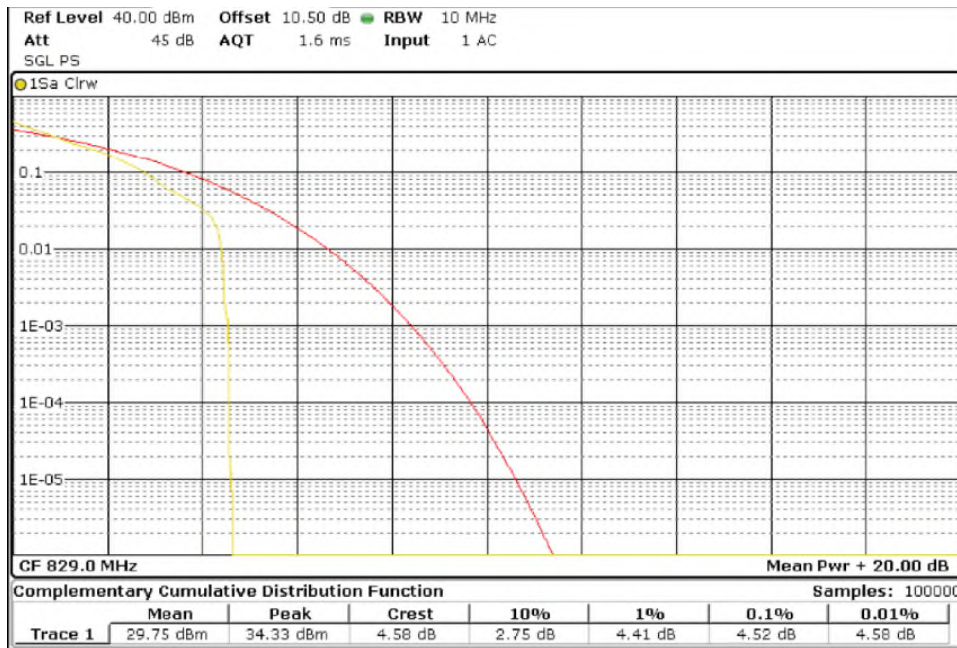

Middle channel

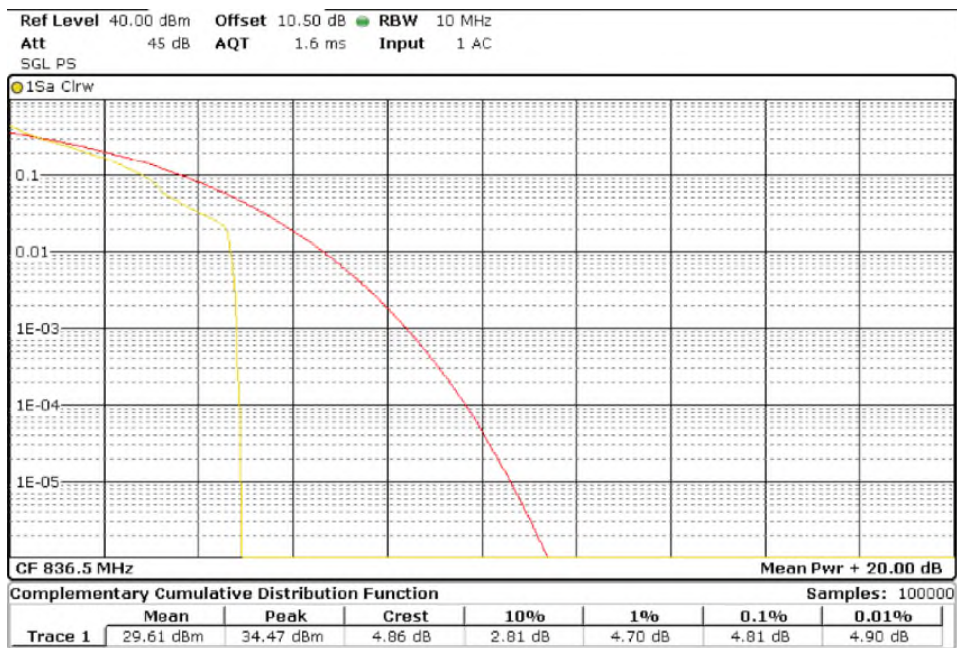

TEST RESULTS (Cont):

Highest channel

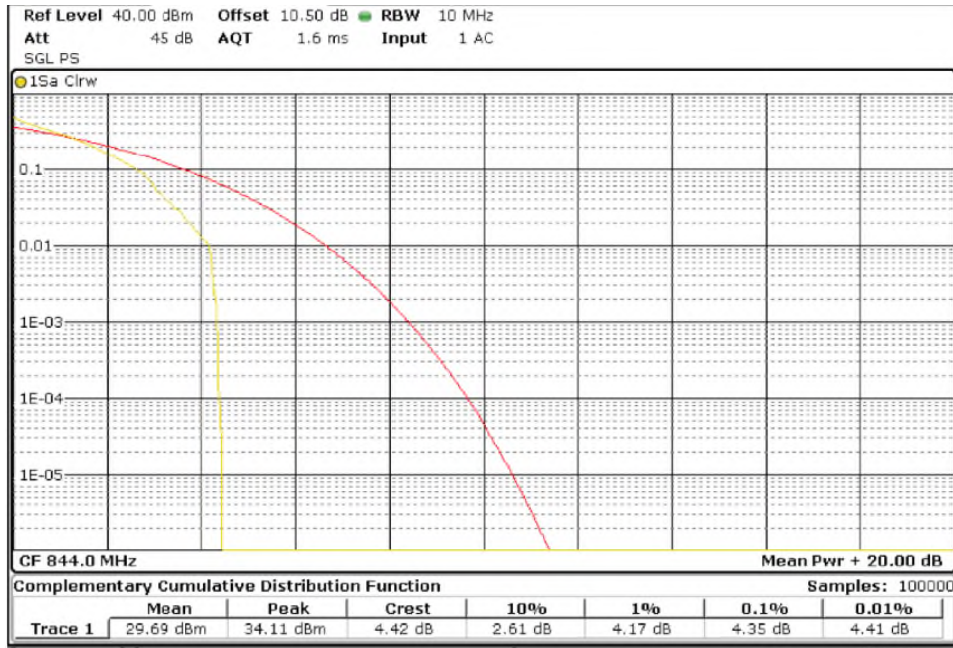

Bandwidth = 10 MHz Modulation 16QAM. RB Size: 1. RB Offset: 0.

Lowest channel

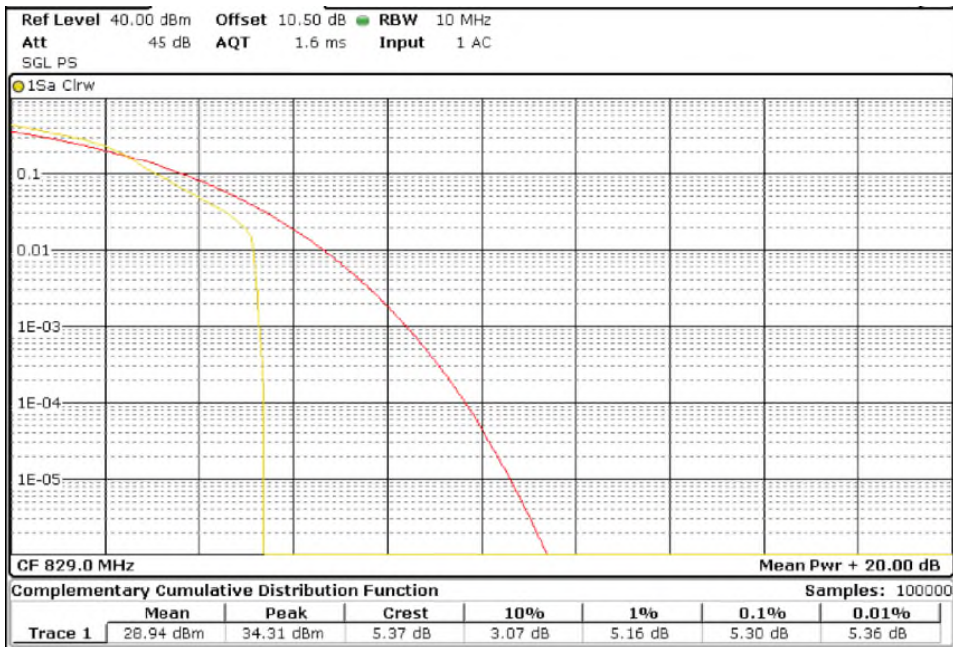

TEST RESULTS (Cont):

Middle channel

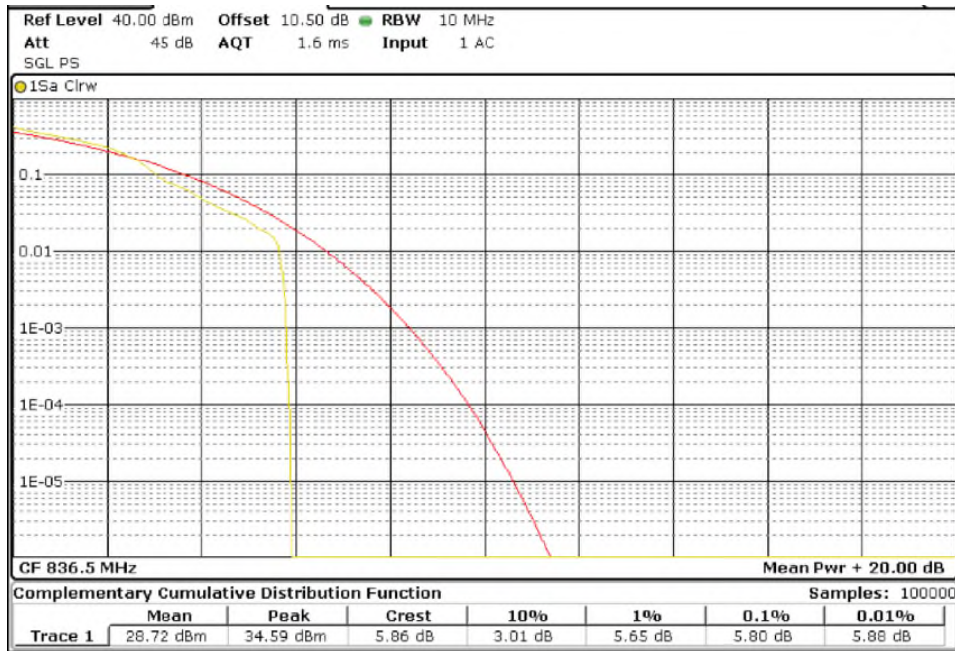

Highest channel

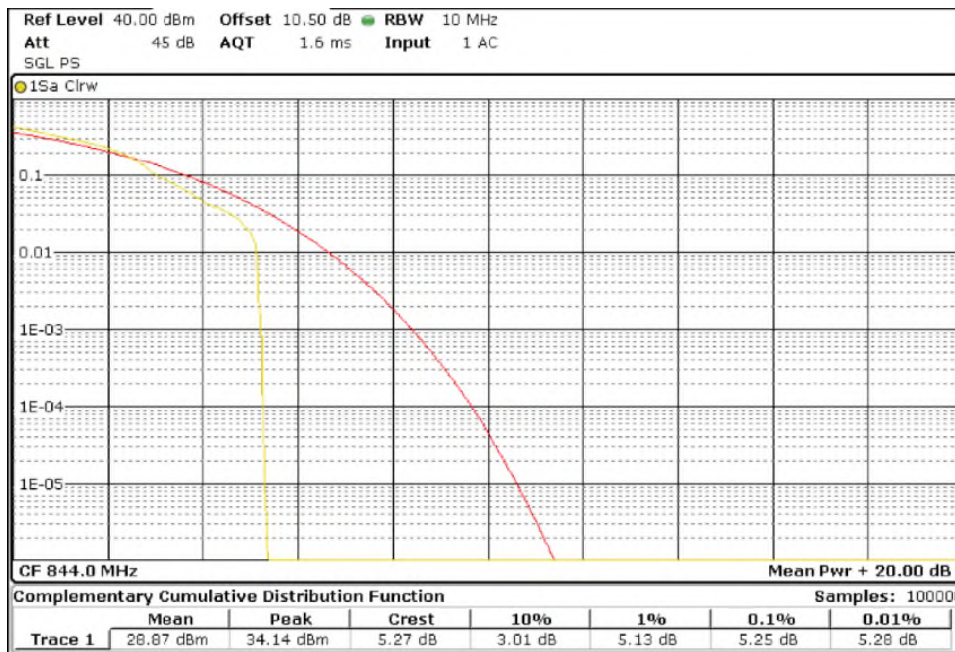

TESTED SAMPLES:	S/01
TESTED CONDITIONS MODES:	TC#02
TEST RESULTS	PASS

2G:

GPRS MODULATION.

Channel	Average power at antenna port (dBm)	Maximum declared antenna gain (dBi)	Maximum E.I.R.P. average power (dBm)	PAPR (dB)
Lowest	32.38	3.0	35.38	9.91
Middle	32.21	3.0	35.21	8.46
Highest	32.38	3.0	35.38	8.52
Measurement uncertainty (dB)			<±0.95	

EDGE MODULATION.

Channel	Average power at antenna port (dBm)	Maximum declared antenna gain (dBi)	Maximum E.I.R.P. average power (dBm)	PAPR (dB)
Lowest	26.22	3.0	29.22	6.81
Middle	26.34	3.0	29.34	8.87
Highest	26.39	3.0	29.39	10.93
Measurement uncertainty (dB)			<±0.95	

TEST RESULTS (Cont):

GPRS:

Lowest channel

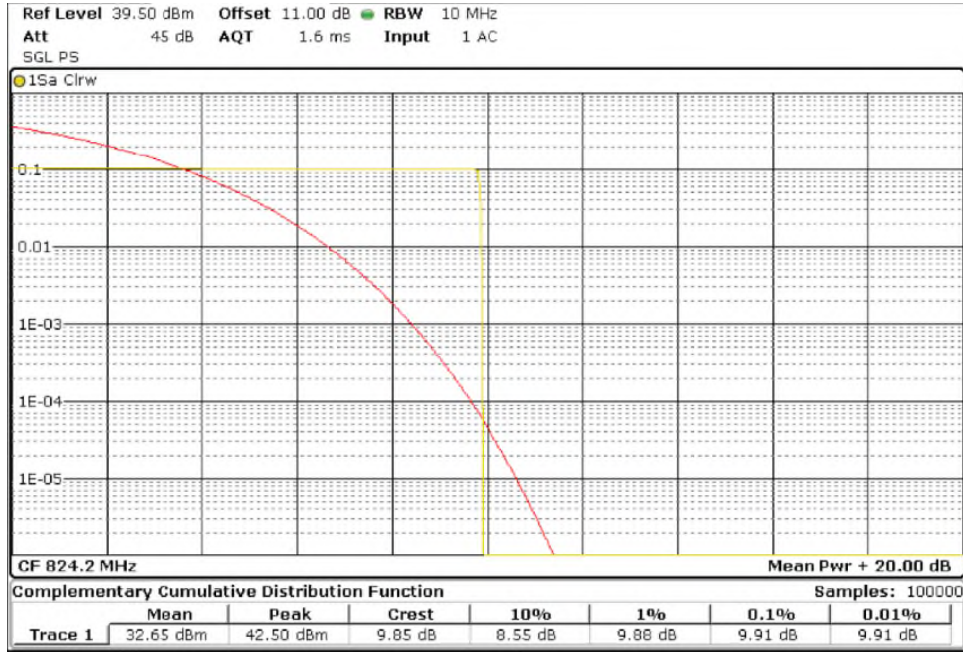

Middle channel

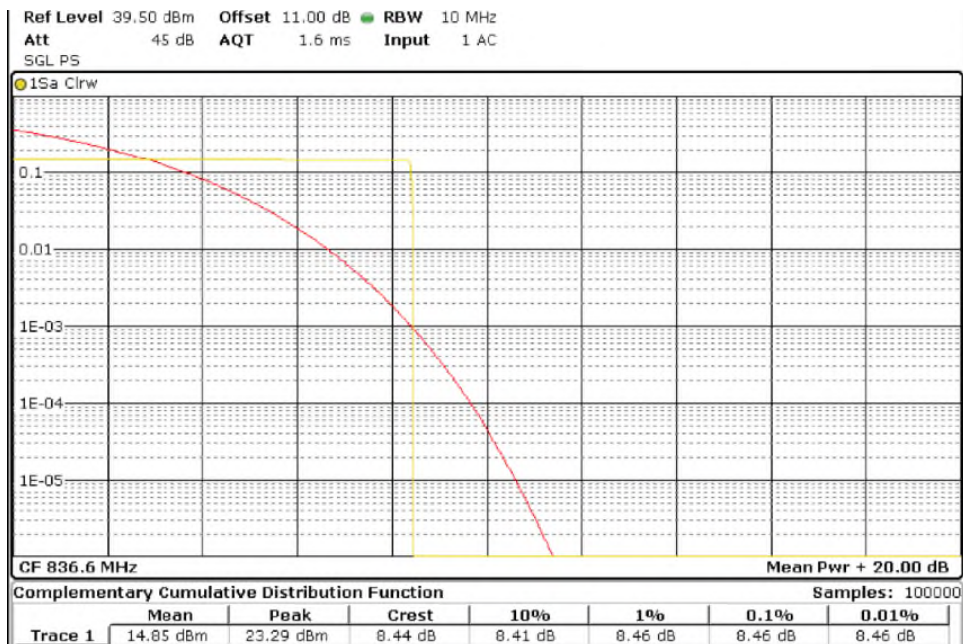

TEST RESULTS (Cont):

High channel

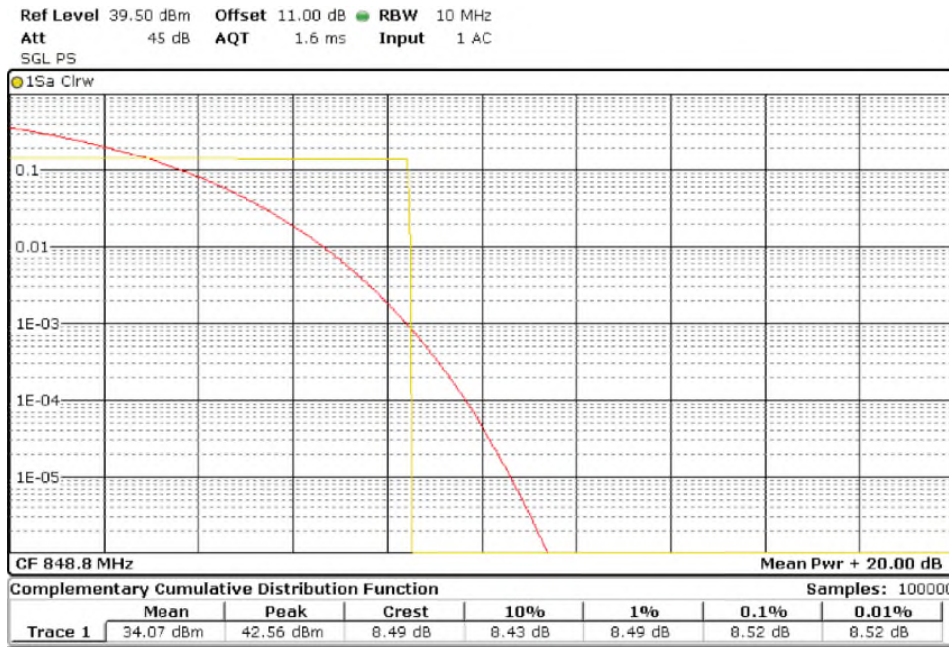

EDGE:

Lowest channel

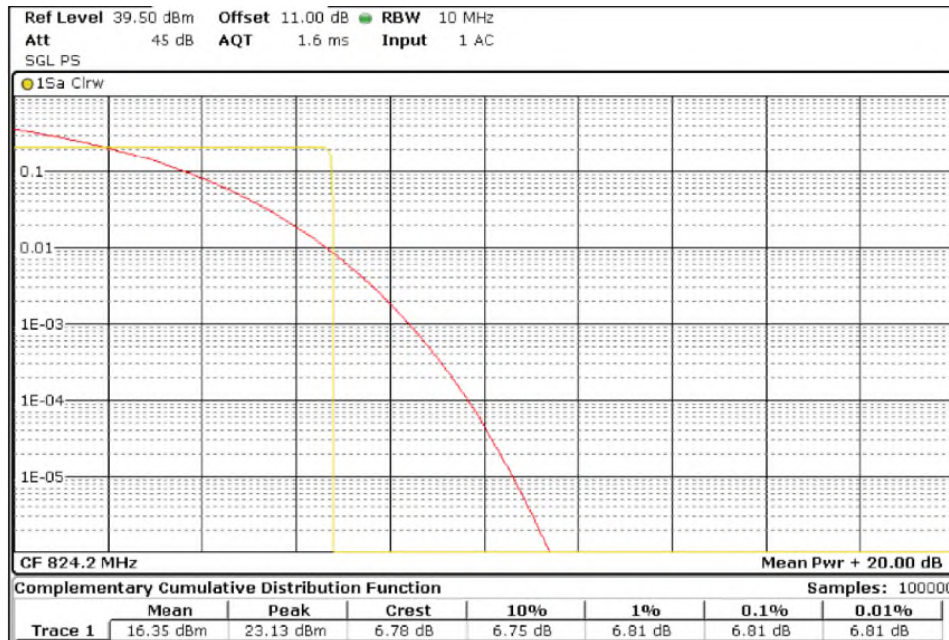

TEST RESULTS (Cont):

Middle channel

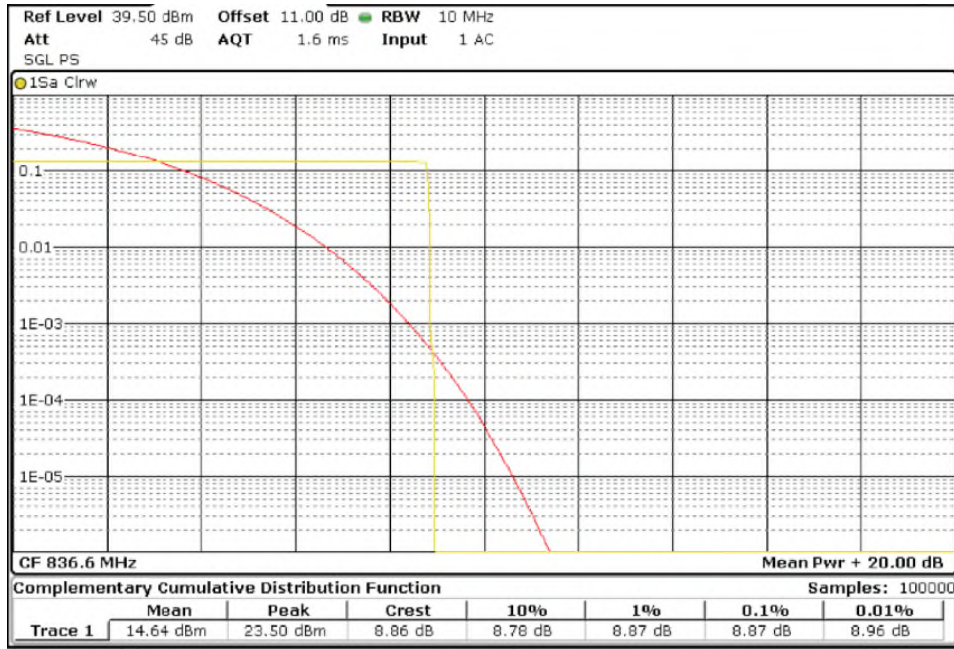

High channel

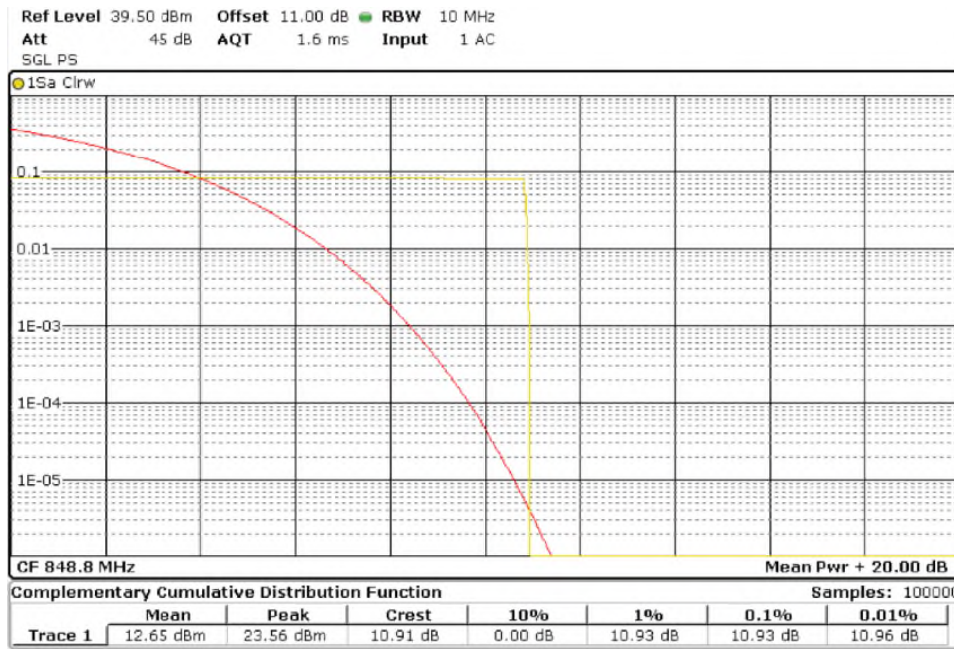

TESTED SAMPLES:	S/01
TESTED CONDITIONS MODES:	TC#03
TEST RESULTS	PASS

3G:

WCDMA MODULATION.

Channel	Average power at antenna port (dBm)	Maximum declared antenna gain (dBi)	Maximum E.I.R.P. average power (dBm)	PAPR (dB)
Lowest	24.24	3.0	27.24	3.3
Middle	24.28	3.0	27.28	3.25
Highest	24.41	3.0	27.41	3.28
Measurement uncertainty (dB)			<±0.95	

HSUPA MODULATION.

Channel	Average power at antenna port (dBm)	Maximum declared antenna gain (dBi)	Maximum E.I.R.P. average power (dBm)
Lowest	23.55	3.0	26.55
Middle	23.70	3.0	26.70
Highest	23.53	3.0	26.53
Measurement uncertainty (dB)		<±0.95	

Lowest channel

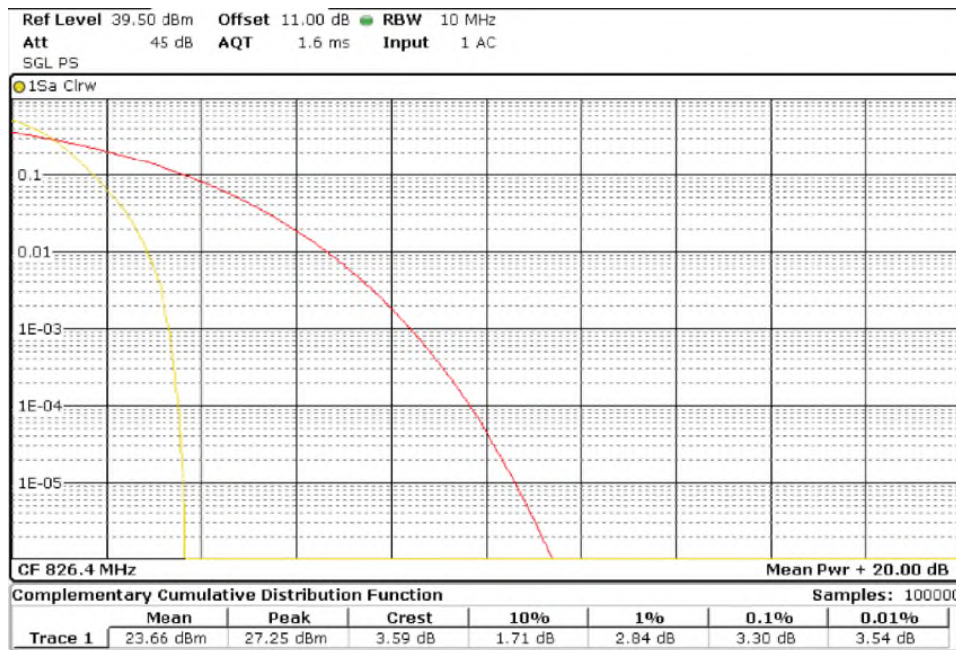

TEST RESULTS (Cont):

Middle channel

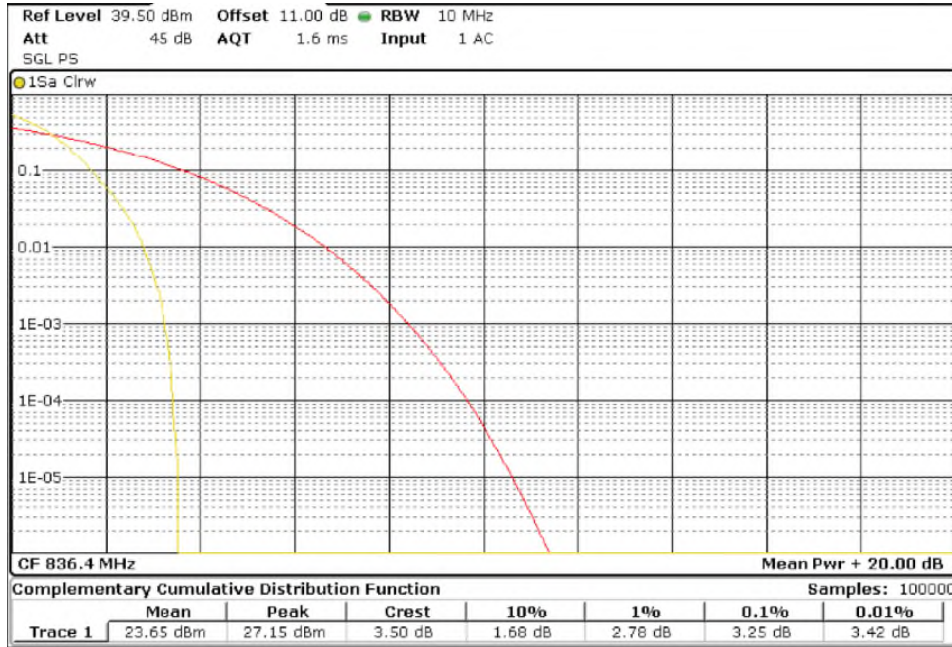

Highest channel

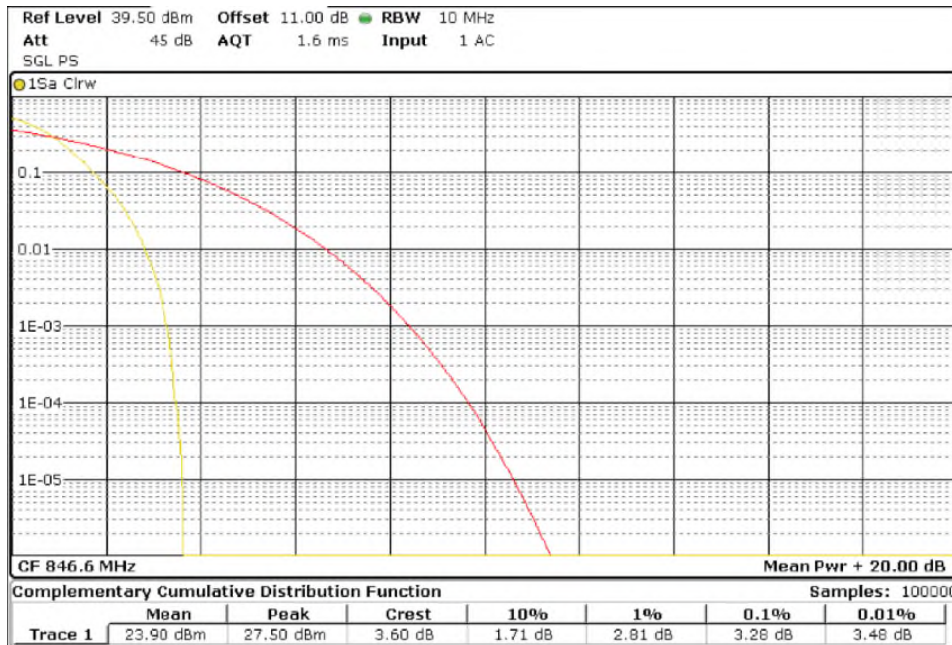

TEST A2: MODULATION CHARACTERISTICS

LIMITS:	Product standard:	FCC Part 22 / IC RSS-132
	Test standard:	FCC §2.1047 / RSS-132 Clause 5.2

LIMITS

A curve or equivalent data which shows that the equipment will meet the modulation requirements of the rules under which the equipment is to be licensed.

TEST SETUP

For LTE the EUT operates with QPSK and 16QAM modulation modes in which the information is digitized and coded into a bit stream. The RF transmission is multiplexed using Orthogonal Frequency Division Multiplexing (OFDM) using different possible arrangement of subcarriers (Resource Blocks RB).

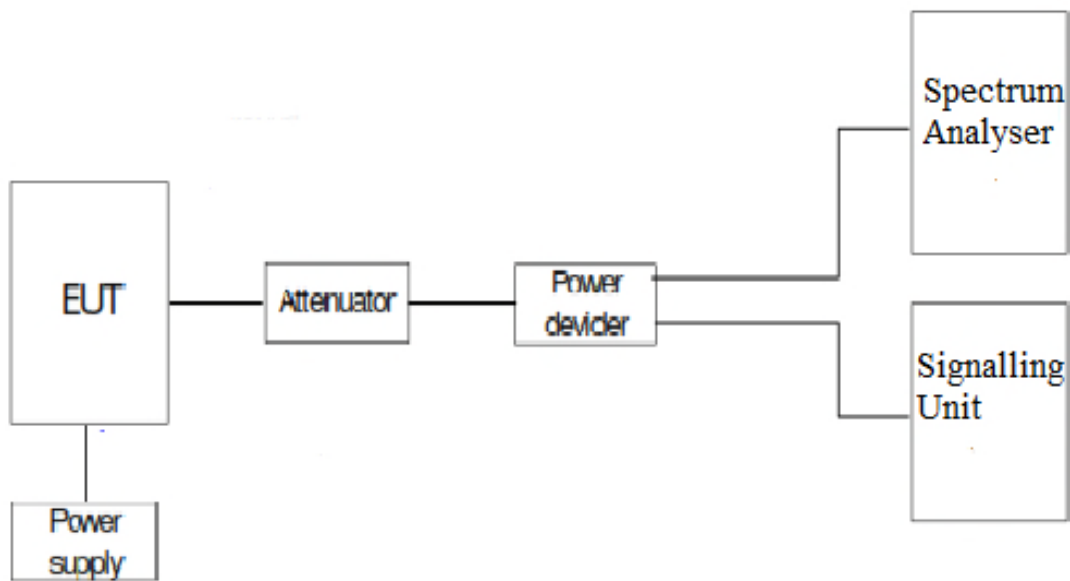

TESTED SAMPLES:	S/01
TESTED CONDITIONS MODES:	TC#01
TEST RESULTS:	PASS

QPSK Modulation

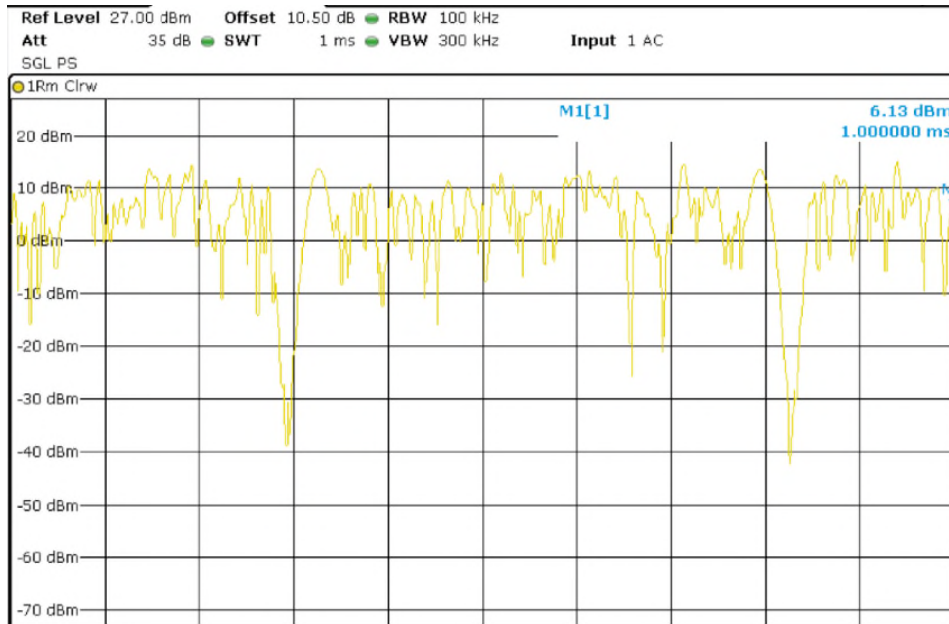

16QAM Modulation

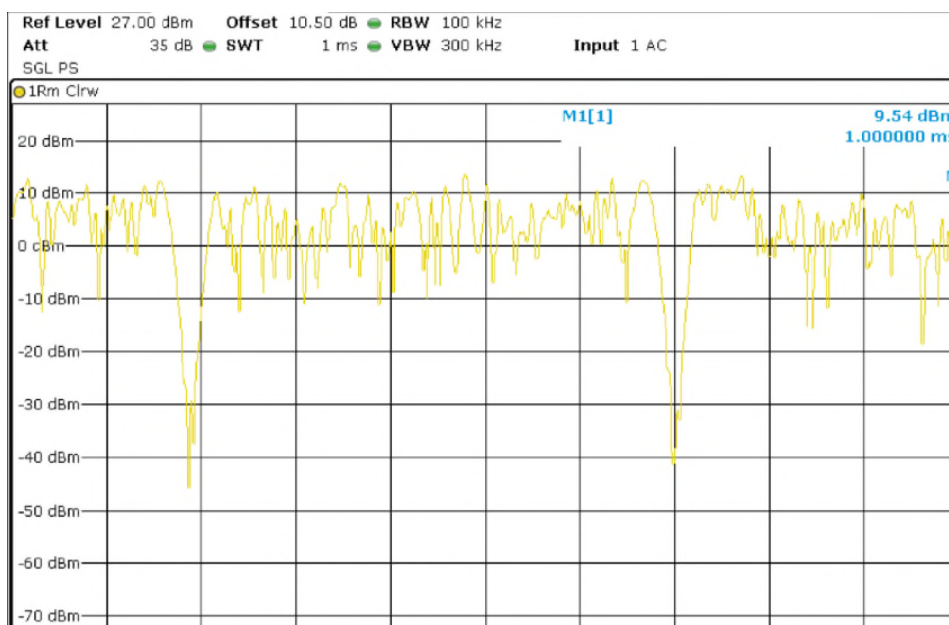

TESTED SAMPLES:	S/01
TESTED CONDITIONS MODES:	TC#02
TEST RESULTS:	PASS

GPRS Modulation

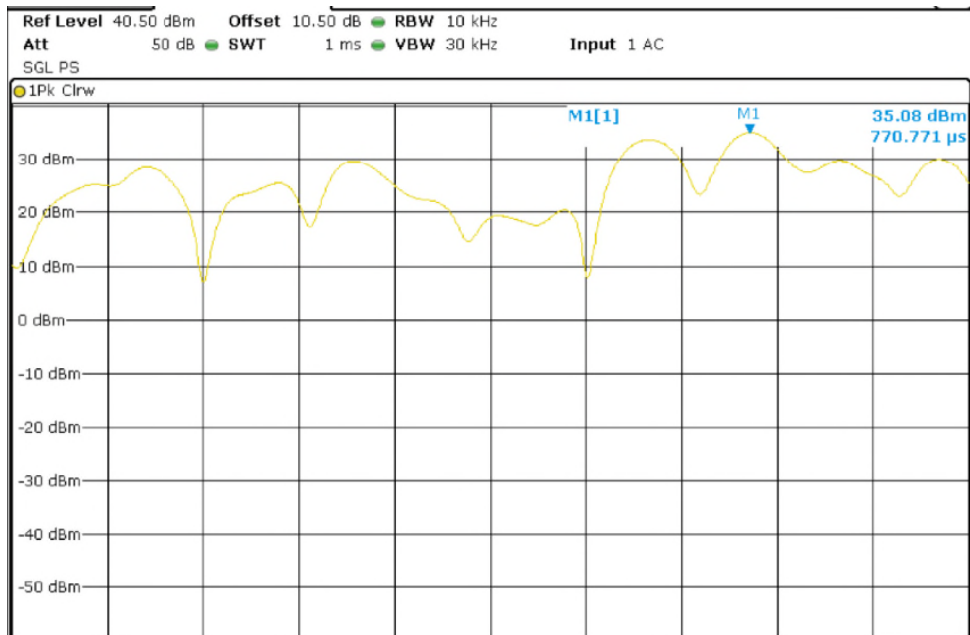

EDGE Modulation

