

MEECOOL®

KM2 PLUS DELUXE

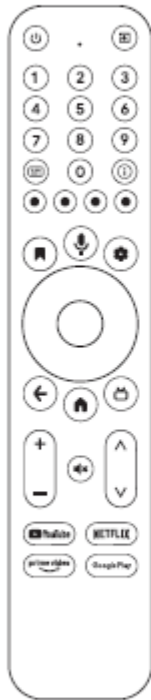



Voice Remote

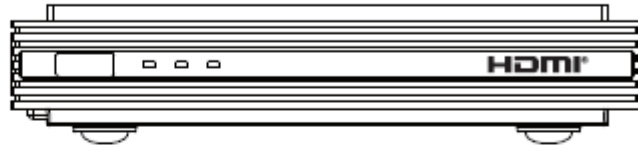

Media Palyer

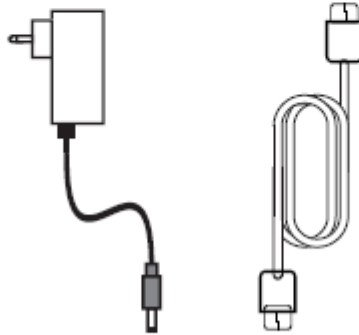

Power Adapter

HDMI Cable

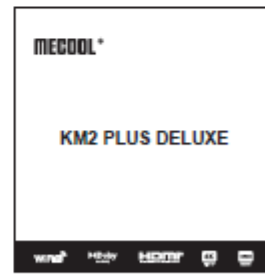

User Manual

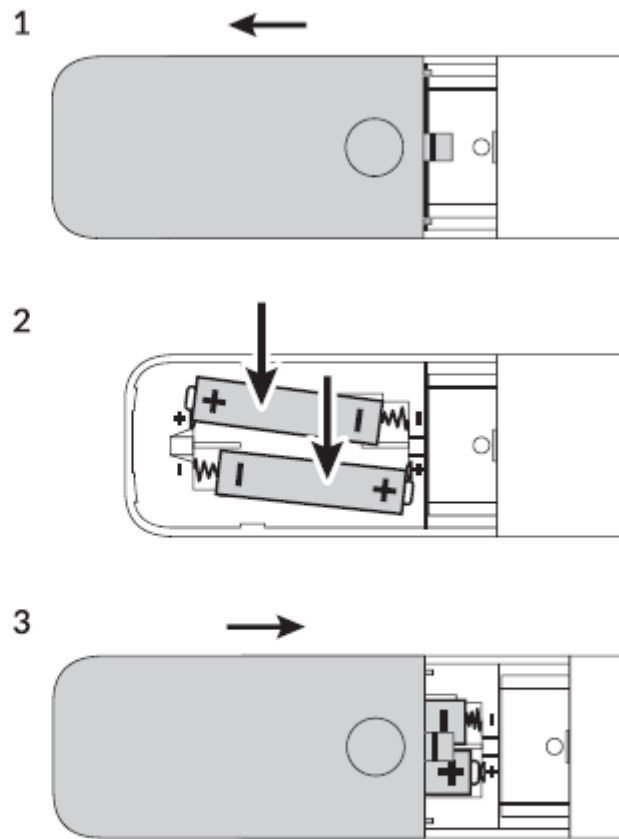
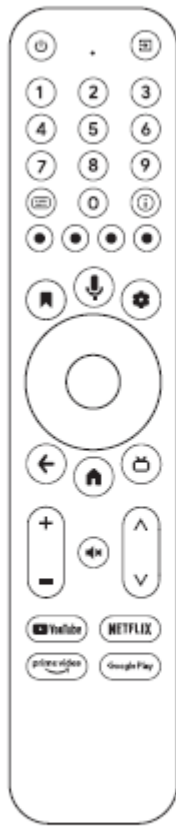

Note: Accessories do not include batteries.

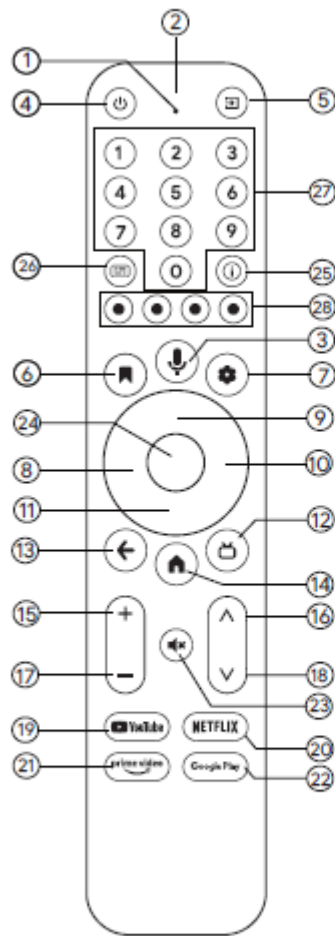

- ① Microphone
- ② Indicator Light
- ③ Voice Control
- ④ Power On / Off
- ⑤ TV Input Switch
- ⑥ Bookmark
- ⑦ Settings
- ⑧ Navigate to Left
- ⑨ Navigate to Up
- ⑩ Navigate to Right
- ⑪ Navigate to Down
- ⑫ Live TV
- ⑬ Return
- ⑭ Shortcut Key to Home Page
- ⑮ Volume Up
- ⑯ PAGE+
- ⑰ Volume Down
- ⑱ PAGE -
- ⑲ Quick one-click access to YouTube
- ⑳ Quick one-click access to NETFLIX
- ㉑ Quick one-click access to Prime Video
- ㉒ Quick one-click access to Google Play
- ㉓ Mute
- ㉔ Press to Confirm
- ㉕ User Profiles
- ㉖ Info
- ㉗ Press to input Arabic number
- ㉘ Composite function keys

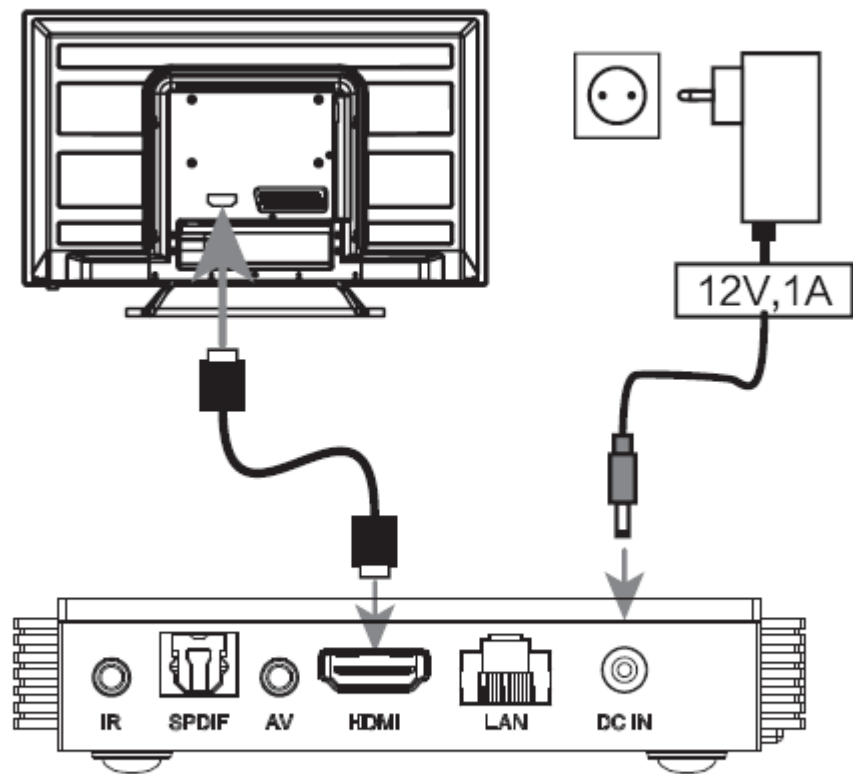



4

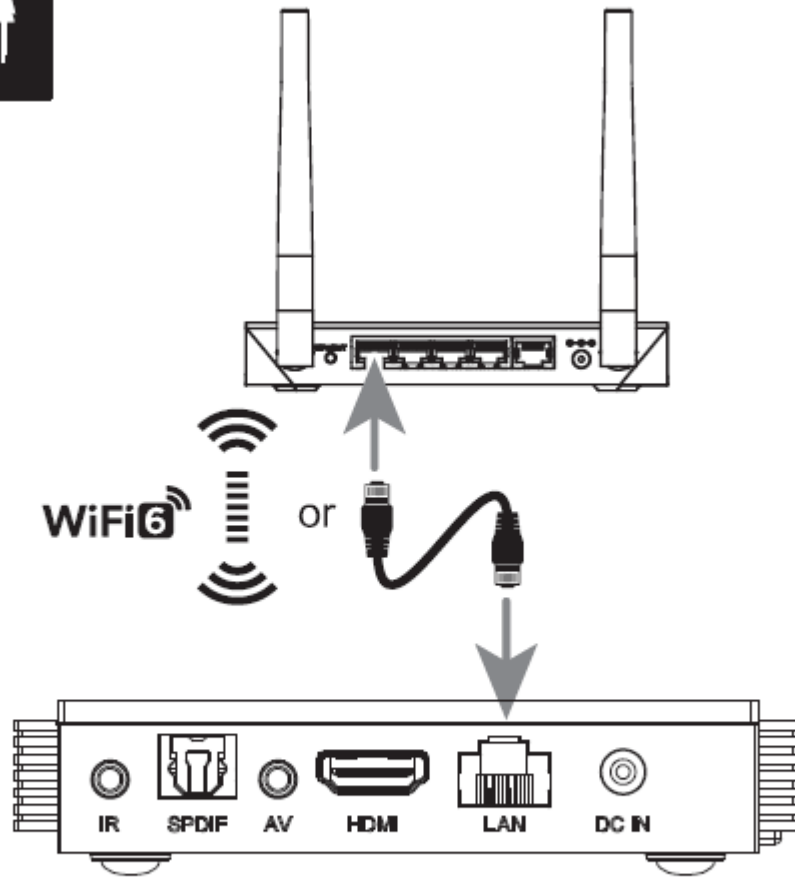

0 ~ +45°C (in operation)



Wi-Fi: 2T2R 802.11 a/b/g/n/ac/ax, 2.4G&5G

1. Press and hold  and  on remote control until LED flashes quickly.

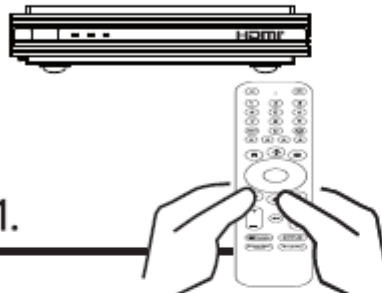

2. Welcome

English

German

French

Italian

Spanish



3. Set up your TV with an Android™ phone or tablet?

Yes

Skip



4. Google Quick Setup



1. On your Android phone, open the pre-installed app "Google"
2. Type or say, "Ok Google, set up my device"
3. Tap 4K AndroL... (529) on the list

Press Back to cancel

Terms of service

Accept

View Google Terms of Service
View Google Privacy Policy
View Google play Terms of Service

5.



Location

Yes

No

6.



Help improve Android performance

Yes

Skip

7.



Press the Google Assistant button on your remote to talk to Google.



Download of Apps

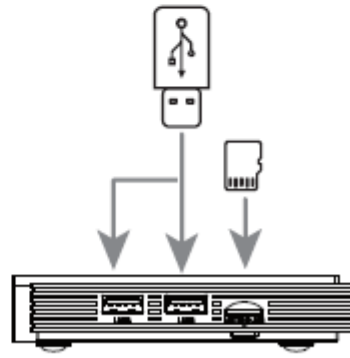
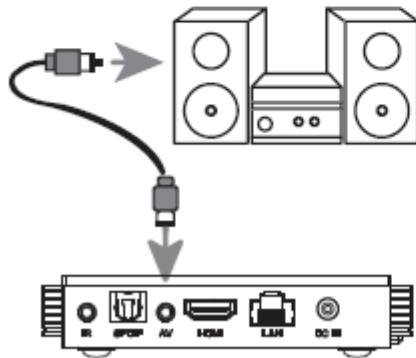
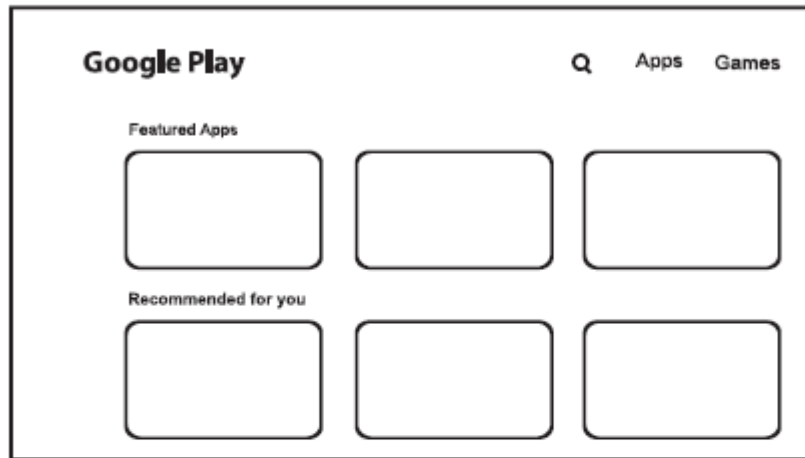

8

Licenses

This product contains one or more programs protected under international and U.S. copyright laws as unpublished works. They are confidential and proprietary to Dolby Laboratories. Their reproduction or disclosure, in whole or in part, or the production of derivative works therefrom without the express permission of Dolby Laboratories is prohibited. Copyright 2003-2009 by Dolby Laboratories. All rights reserved.

Declaration

Subject to alterations. In consequence of continuous research and development technical specifications, design and appearance of products may change. Google, Android, YouTube, Android TV and other marks are trademarks of Google LLC. The terms HDMI and HDMI High-Definition Multimedia Interface, and the HDMI logo are trademarks or registered trademarks of HDMI Licensing Administrator, Inc in the United States and other countries. Manufactured under licence from Dolby Laboratories. Dolby Audio and the double-D symbol are registered trademarks of Dolby Laboratories. All other product names are trademarks or registered trademarks of the irrelative owners. © VIDEOSTRONG 2021. All rights reserved.

Attribution statement

Google, Google Play, YouTube, Android TV and other marks are trademarks of Google LLC.

Data Protection

Please be aware that VIDEOSTRONG, its manufacturing partners, the application providers and the providers of the services may collect and use technical data and related information, including but not limited to technical information about this device, system and application software and peripherals. VIDEOSTRONG, its manufacturing partners, the application providers and the providers of the services may use such information to improve its products or to provide services or technologies to you, as long as it is in a form that does not personally identify you. Additionally, please keep in mind that some services provided - already in the device or installed by you - may request a registration for which you have to provide personal data. Beside that, please be aware that some services which are not pre-installed but can be installed may collect personal data even without providing additional warnings and that VIDEOSTRONG can not be held liable for a possible breach of data protection by services not pre-installed.

FCC Statement

This equipment has been tested and found to comply with the limits for a Class B digital device, pursuant to part 15 of the FCC rules. These limits are designed to provide reasonable protection against harmful interference in a residential installation. This equipment generates, uses and can radiate radio frequency energy and, if not installed and used in accordance with the instructions, may cause harmful interference to radio communications. However, there is no guarantee that interference will not occur in a particular installation.

If this equipment does cause harmful interference to radio or television reception, which can be determined by turning the equipment off and on, the user is encouraged to try to correct the interference by one or more of the following measures:

- Reorient or relocate the receiving antenna,
- Increase the separation between the equipment and receiver
- Connect the equipment into an outlet on a circuit different from that to which the receiver is connected.
- Consult the dealer or an experienced radio/TV technician for help. To assure continued compliance, any changes or modifications not expressly approved by the party responsible for compliance could void the user's authority to operate this equipment. (Example-use only shielded interface cables when connecting to computer or peripheral devices) This equipment complies with Part 15 of the FCC Rules. Operation is subject to the following two conditions:

- (1) This device may not cause harmful interference, and
- (2) This device must accept any interference received, including interference that may cause undesired operation.

FCC Radiation Exposure Statement: The equipment complies with FCC Radiation exposure limits set forth for uncontrolled environment. This equipment should be installed and operated with minimum distance 20cm between the radiator and your body.

DE

drücken und halten  und  auf der Fernbedienung, bis die LED schnell blinkt.



1.

Welcome

English

German

French

Italian

Spanish

2.



Richten Sie Ihren Fernseher mit ein ein Android™-Telefon oder -Tablet?

Ja

Überspringen

3.



Google

Schnelle Einrichtung

1. Öffnen Sie auf Ihrem Android-Telefon die vorinstallierte App „Google“
2. Geben Sie ein oder sagen Sie „Ok Google, richte mein Gerät ein“
3. Tippen Sie in der Liste auf 4K Andro... (529).

Drücken Sie Zurück, um abzubrechen

4.



Nutzungsbedingungen**Annehmen**

Sehen Sie sich die Nutzungsbedingungen von Google an
Google-Datenschutzrichtlinie anzeigen
Sehen Sie sich die Nutzungsbedingungen von Google Play an

5.



Ort

Ja

Nein

6.

**Helfen Sie mit, Android zu verbessern Leistung****Ja**

Überspringen

7.



Drücken Sie die Google Assistant-Taste auf Ihrer Fernbedienung, um mit Google zu sprechen.



Lizenzen

Dieses Produkt enthält ein oder mehrere Programme, die durch internationale und US-amerikanische Urheberrechtsgesetze als unveröffentlichte Werke geschützt sind. Sie sind vertraulich und Eigentum von Dolby Laboratories. Ihre Vervielfältigung oder Offenlegung, ganz oder teilweise, oder die Herstellung abgeleiteter Werke davon ohne die ausdrückliche Genehmigung von Dolby Laboratories ist untersagt. Copyright 2003–2009 von Dolby Laboratories. Alle Rechte vorbehalten.

Erklärung

Änderungen vorbehalten. Aufgrund ständiger Forschung und Entwicklung können sich technische Daten, Design und Aussehen der Produkte ändern. Google, Android, YouTube, Android TV und andere Marken sind Marken von Google LLC. Die Begriffe HDMI und HDMI High-Definition Multimedia Interface sowie das HDMI-Logo sind Warenzeichen oder eingetragene Warenzeichen von HDMI Licensing Administrator, Inc in den Vereinigten Staaten und anderen Ländern. Hergestellt unter Lizenz von Dolby Laboratories. Dolby Audio und das Doppel-D-Symbol sind eingetragene Warenzeichen von Dolby Laboratories. Alle anderen Produktnamen sind Warenzeichen oder eingetragene Warenzeichen der jeweiligen Eigentümer. © VIDEOSTRONG 2021. Alle Rechte vorbehalten.



Zuschreibungserklärung

Google, Google Play, YouTube, Android TV und andere Marken sind Marken von Google LLC.

Datenschutz

Bitte beachten Sie, dass VIDEOSTRONG, seine Herstellungspartner, die Anwendungsanbieter und die Anbieter der Dienste technische Daten und zugehörige Informationen sammeln und verwenden können, einschließlich, aber nicht beschränkt auf technische Informationen über dieses Gerät, System und Anwendungssoftware und Peripheriegeräte. VIDEOSTRONG, seine Herstellungspartner, die Anwendungsanbieter und die Anbieter der Dienste können diese Informationen verwenden, um ihre Produkte zu verbessern oder Dienste bereitzustellen oder Technologien an Sie, solange es in einer Form vorliegt, die Sie nicht persönlich identifiziert. Bitte beachten Sie außerdem, dass einige bereitgestellte Dienste – bereits auf dem Gerät oder von Ihnen installiert – möglicherweise eine Registrierung erfordern, für die Sie personenbezogene Daten angeben müssen. Bitte beachten Sie außerdem, dass einige Dienste, die nicht vorinstalliert sind, aber installiert werden können, auch ohne zusätzliche Warnungen personenbezogene Daten erfassen können und dass VIDEOSTRONG nicht für eine mögliche Verletzung des Datenschutzes durch nicht vorinstallierte Dienste haftbar gemacht werden kann.

FR

appuyez et maintenez  et  sur la télécommande jusqu'à ce que la LED clignote rapidement.

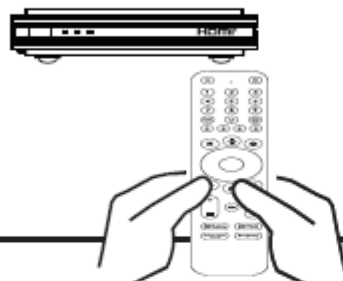

1.

Welcome

English
German
French
Italian
Spanish



2.

Configurer votre téléviseur avec un téléphone ou une tablette Android™ ?

Ja

Überspringen



3.

Google

Schnelle Einrichtung



1. Öffnen Sie auf Ihrem Android-Telefon die vorinstallierte App „Google“
2. Geben Sie ein oder sagen Sie „Ok Google, richte mein Gerät ein“
3. Tippen Sie in der Liste auf 4K AndroL.. (529).

Drücken Sie Zurück, um abbrechen

4.

Conditions d'utilisation

Accepter

Vérifiez les conditions d'utilisation de Google
Afficher la politique de confidentialité de Google
Vérifiez les conditions d'utilisation depuis Google Play

5.



emplacement

oui

non

6.



Helfen Sie mit, Android zu verbessern Leistung

oui

Sauter

7.



Appuyez sur le bouton Assistant Google sur votre télécommande pour google parler.



licences

Ce produit contient un ou plusieurs programmes protégés en tant qu'œuvres non publiées par les lois internationales et américaines sur le droit d'auteur. Ils sont confidentiels et exclusifs à Dolby Laboratories. Leur reproduction ou divulgation, en tout ou en partie, ou la création d'œuvres dérivées de ceux-ci sans l'autorisation expresse de Dolby Laboratories est interdite. Copyright 2003-2009 par Dolby Laboratories. Tous les droits sont réservés.

Explication

Sous réserve de modifications. En raison de la recherche et du développement en cours, les spécifications, la conception et l'apparence des produits sont susceptibles d'être modifiées. Google, Android, YouTube, Android TV et d'autres marques sont des marques déposées de Google LLC. Les termes HDMI et HDMI High-Definition Multimedia Interface, ainsi que le logo HDMI sont des marques ou des marques déposées de HDMI Licensing Administrator, Inc aux États-Unis et dans d'autres pays. Fabriqué sous licence de Dolby Laboratories. Dolby Audio et le symbole double-D sont des marques déposées de Dolby Laboratories. Tous les autres noms de produits sont des marques ou des marques déposées de leurs propriétaires respectifs. © VIDEOSTRONG 2021. Tous droits réservés.



déclaration d'attribution

Google, Google Play, YouTube, Android TV et d'autres marques sont des marques déposées de Google LLC.

intimité

Veillez noter que VIDEOSTRONG, ses partenaires de fabrication, les fournisseurs d'applications et les fournisseurs de services peuvent collecter et utiliser des données techniques et des informations connexes, y compris, mais sans s'y limiter, des informations techniques sur cet appareil, le système et les logiciels d'application et les périphériques. VIDEOSTRONG, ses partenaires fabricants, les fournisseurs d'applications et les fournisseurs de services peuvent utiliser ces informations pour améliorer leurs produits ou pour fournir des services ou La technologie à vous, tant qu'elle est sous une forme qui ne vous identifie pas personnellement. Veuillez également noter que certains services fournis - déjà installés sur l'appareil ou installés par vous - peuvent nécessiter un enregistrement, pour lequel vous devez fournir des données personnelles. Veuillez également noter que certains services qui ne sont pas préinstallés mais qui peuvent être installés peuvent collecter des données personnelles même sans avertissements supplémentaires et que VIDEOSTRONG ne peut être tenu responsable d'une éventuelle violation de la vie privée causée par des services non préinstallés.

IT

1. tieni premuto  e  sul telecomando fino a quando il LED non lampeggia rapidamente...

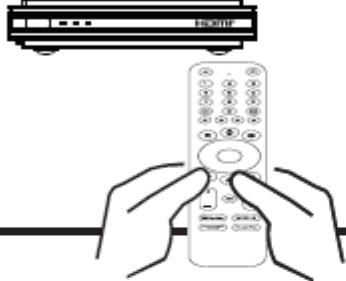

2. Welcome

English
German
French
Italian
Spanish



3. Configurare la TV con un telefono o tablet Android?

Sì

Saltare



4. Google

Configurazione veloce

1. Apri l'app "Google" preinstallata sul tuo telefono Android
2. Digita o pronuncia "Ok Google, configura il mio dispositivo"
3. Da **elenco**, toccare 4K Android... (529).

Previ. richiesto per alcuni dati.



Premi **Indietro** per annullare

Accettare

Controlla i Termini di servizio di Google
Visualizza l'informativa sulla privacy di Google
Controlla i Termini di servizio da Google Play

5.



Posizione

si

non

6.



Aiutaci Android per migliorare le prestazioni

si

Saltare

7.



Premi il pulsante dell'Assistente Google sul telecomando per parlare con Google.



licenze

Questo prodotto contiene uno o più programmi protetti come opere non pubblicate dalle leggi sul copyright internazionali e statunitensi. Sono riservati e di proprietà di Dolby Laboratories. È vietata la loro riproduzione o divulgazione, in tutto o in parte, o la creazione di opere derivate dalle stesse senza l'espresso consenso di Dolby Laboratories. Copyright 2003-2009 di Dolby Laboratories. Tutti i diritti riservati.

Spiegazione

Soggetto a modifiche. A causa della continua ricerca e sviluppo, le specifiche del prodotto, il design e l'aspetto sono soggetti a modifiche. Google, Android, YouTube, Android TV e altri marchi sono marchi di Google LLC. I termini HDMI e HDMI High-Definition Multimedia Interface e il logo HDMI sono marchi o marchi registrati di HDMI Licensing Administrator, Inc negli Stati Uniti e in altri paesi. Prodotto su licenza di Dolby Laboratories. Dolby Audio e il simbolo della doppia D sono marchi registrati di Dolby Laboratories. Tutti gli altri nomi di prodotti sono marchi o marchi registrati dei rispettivi proprietari. © VIDEOSTRONG 2021. Tutti i diritti riservati.

dichiarazione del premio

Google, Google Play, YouTube, Android TV e altri marchi sono marchi di Google LLC.

privacy

Si prega di notare che VIDEOSTRONG, i suoi partner di produzione, fornitori di applicazioni e fornitori di servizi possono raccogliere e utilizzare dati tecnici e informazioni correlate, incluse ma non limitate a informazioni tecniche su questo dispositivo, il sistema, il software applicativo e le periferiche. VIDEOSTRONG, i suoi partner di produzione, fornitori di applicazioni e fornitori di servizi possono utilizzare queste informazioni per migliorare i propri prodotti o per fornire servizi o La tecnologia per te, purché sia in una forma che non ti identifichi personalmente. Ti ricordiamo inoltre che alcuni servizi forniti - già installati sul dispositivo o da te installati - potrebbero richiedere la registrazione, per la quale è necessario fornire i dati personali. Si ricorda inoltre che alcuni servizi non preinstallati ma installabili possono raccogliere dati personali anche senza ulteriori avvertenze e VIDEOSTRONG non può essere ritenuta responsabile per eventuali violazioni della privacy causate da servizi non preinstallati.

ES

1. aguanta  y  sigue control remoto hasta que el LED parpadee rápidamente..



2. Welcome

English
German
French
Italian
Spanish



3. Configurar el televisor con un teléfono o tableta ¿Android™?

Sí

Salto



4. Google

Configuración rápida

1. Abra la aplicación "Google" preinstalada en su teléfono Android
2. Escriba o diga "Ok Google, configure mi dispositivo"
3. En la lista, toque Android 4K... (529).



Presione Atrás para cancelar

Presiona Atrás para cancelar

Aceptar

Consulta las Condiciones de servicio de Google
Ver la política de privacidad de Google
Consulte los Términos de servicio de Google Play

5.



Posición

Sí

no

6.



Ayuda Android para mejorar el rendimiento

Sí

Salto

7.



Presiona el botón Asistente de Google en el Mando a distancia para hablar con Google.



licencias

Este producto contiene uno o más programas que están protegidos como trabajos no publicados según las leyes de derechos de autor de EE. UU. e internacionales. Son confidenciales y propiedad de Dolby Laboratories. Queda prohibida su reproducción o divulgación, total o parcial, o la creación de obras derivadas de los mismos sin el consentimiento expreso de Dolby Laboratories. Copyright 2003-2009 de Dolby Laboratories. Reservados todos los derechos.

Explicación

Sujeto a modificaciones. Debido a la investigación y el desarrollo continuos, las especificaciones, el diseño y la apariencia del producto están sujetos a cambios. Google, Android, YouTube, Android TV y otras marcas son marcas comerciales de Google LLC. Los términos HDMI e Interfaz multimedia de alta definición HDMI, y el logotipo de HDMI son marcas comerciales o marcas comerciales registradas de HDMI Licensing Administrator, Inc en los Estados Unidos y otros países. Fabricado bajo licencia de Dolby Laboratories. Dolby Audio y el símbolo de la doble D son marcas registradas de Dolby Laboratories. Todos los demás nombres de productos son marcas comerciales o marcas comerciales registradas de sus respectivos propietarios. © VIDEOSTRONG 2021. Todos los derechos reservados.



declaración de adjudicación

Google, Google Play, YouTube, Android TV y otras marcas son marcas comerciales de Google LLC.

privacidad

Si prega di notare che VIDEOSTRONG, i suoi partner di produzione, fornitori di applicazioni e fornitori di servizi possono raccogliere e utilizzare dati tecnici e informazioni correlate, incluse ma non limitate a informazioni tecniche su questo dispositivo, il sistema, il software applicativo e le periferiche. VIDEOSTRONG, i suoi partner di produzione, fornitori di applicazioni e fornitori di servizi possono utilizzare queste informazioni per migliorare i propri prodotti o per fornire servizi o La tecnologia per te, purché sia in una forma che non ti identifichi personalmente. Ti ricordiamo inoltre che alcuni servizi forniti - già installati sul dispositivo o da te installati - potrebbero richiedere la registrazione, per la quale è necessario fornire i dati personali. Si ricorda inoltre che alcuni servizi non preinstallati ma installabili possono raccogliere dati personali anche senza ulteriori avvertenze e VIDEOSTRONG non può essere ritenuta responsabile per eventuali violazioni della privacy causate da servizi non preinstallati.

PT

Pressione e segure  +  no controle remoto até que o LED pisque rapidamente.

1.



Welcome

English

Português

French

Italian

Spanish

2.



Configure sua TV com um telefone ou tablet Android.

Sim

Pular

3.



Google

Configuração rápida.

1. seu telefone Android, abra o aplicativo pré-instalado "Google"
2. Type ou diga: "Ok Google, configure meu dispositivo"
3. TAP 4K Android ... (529) na lista

4.



Detalhes do botão, as abreviações

Termos de serviço

Aceitar

Ver Termos de Serviço do Google
Veja a Política de Privacidade do Google
Veja os termos de serviço do Google Play

5.



6. Localização

Sim

Não

6.



Ajuda a melhorar o desempenho do Android

Sim

Pular

7.



Pressione o botão Google Assistant no controle remoto para falar com o Google.



Licenças

Este produto contém um ou mais programas protegidos pelas leis de direitos autorais internacionais e dos EUA como trabalhos não publicados. Eles são confidenciais e de propriedade da Dolby Laboratories. É proibida a sua reprodução ou divulgação, no todo ou em parte, ou a produção de trabalhos derivados sem a permissão expressa da Dolby Laboratories. Copyright 2003-2009 da Dolby Laboratories. Todos os direitos reservados.

Declaração

Sujeito a alterações. Em consequência da pesquisa e desenvolvimento contínuos, as especificações técnicas, design e aparência dos produtos podem mudar. Google, Android, YouTube, Android TV e outras marcas são marcas comerciais da Google LLC. Os termos HDMI e HDMI High-Definition Multimedia Interface e o logotipo HDMI são marcas comerciais ou marcas registradas da HDMI Licensing Administrator, Inc nos Estados Unidos e em outros países. Fabricado sob licença da Dolby Laboratories. Dolby Audio e o símbolo de duplo D são marcas registradas da Dolby Laboratories. Todos os outros nomes de produtos são marcas comerciais ou marcas registradas de seus respectivos proprietários. @VIDEOSTRONG 2021. Todos os direitos reservados.

Declaração de atribuição

Google, Google Play, YouTube, Android TV and outras marcas são marcas registradas de Google LLC.

Proteção de dados

Esteja ciente de que a VIDEOSTRONG, seus parceiros fabricantes, os provedores de aplicativos e os provedores de serviços podem coletar e usar dados técnicos e informações relacionadas, incluindo, entre outros, informações técnicas sobre este dispositivo, sistema, software aplicativo e periféricos. A VIDEOSTRONG, seus parceiros fabricantes, os provedores de aplicativos e os provedores de serviços podem usar essas informações para melhorar seus produtos ou fornecer serviços ou tecnologias a você, desde que estejam em um formato que não o identifique pessoalmente. Adicionalmente, tenha em atenção que alguns serviços prestados - já no dispositivo ou instalados por si - podem requerer um registro para o qual terá de fornecer dados pessoais. Além disso, esteja ciente de que alguns serviços que não são pré-instalados, mas podem ser instalados, podem coletar dados pessoais mesmo sem fornecer avisos adicionais e que a VIDEOSTRONG não pode ser responsabilizada por uma possível violação da proteção de dados por serviços não pré-instalados.

CUSTOMER SUPPORT

MECOOL is committed to providing a better shopping experience for every customer. Feel free to contact us anytime. We will always be here for you.

To contact a Marketplace seller after placing an order:

Go to Your Orders .

Next to the relevant order, select Contact seller. Your message will be sent to the seller via the Seller Communication Centre. They'll respond to you by email.



The terms HDMI, HDMI High-Definition Multimedia Interface, and the HDMI Logo are trademarks or registered trademarks of HDMI Licensing Administrator, Inc.

Customer Service Email

service@meecool.com

