

FCC 47 CFR PART 15 SUBPART C

Product Type : Element Cardio Band
Applicant : FINIS INC.
Address : 7085 Las Positas Road, Suite E, Livermore, CA, 94551, USA
Trade Name : FINIS
Model Number : 1.30.046
Test Specification : FCC 47 CFR PART 15 SUBPART C: 2016
ANSI C63.10:2013
Receive Date : 01 Mar, 2016
Test Period : 03 Mar, 2016 to 28 Mar, 2016
Issue Date : 29 Mar, 2016

Issue by

A Test Lab Techno Corp.
No. 140-1, Changan Street, Bade City,
Taoyuan County 334, Taiwan R.O.C.
Tel : +886-3-2710188 / Fax : +886-3-2710190



Taiwan Accreditation Foundation accreditation number: 1330

Note: This report shall not be reproduced except in full, without the written approval of A Test Lab Techno Corp. This document may be altered or revised by A Test Lab Techno Corp. personnel only, and shall be noted in the revision section of the document. The client should not use it to claim product endorsement by TAF, or any government agencies. The test results in the report only apply to the tested sample.



Revision History

Rev.	Issue Date	Revisions	Revised By
00	29 Mar, 2016	Initial Issue	



Certification of Compliance

Issued Date: 2016/03/29

Product Type : Element Cardio Band
 Applicant : FINIS INC.
 Address : 7085 Las Positas Road, Suite E, Livermore, CA, 94551, USA
 Trade Name : FINIS
 Model Number : 1.30.046
 FCC ID : 2AGJZBW130046V1
 EUT Rated Voltage : DC 3.7V
 Test Voltage : DC 3.7V
 Applicable Standard : FCC 47 CFR PART 15 SUBPART C: 2016
 ANSI C63.10:2013
 Test Result : Complied
 Test Laboratory : Site 1

A Test Lab Techno Corp.
 No. 140-1, Changan Street, Bade City,
 Taoyuan County 334, Taiwan R.O.C.
 Tel : +886-3-2710188 / Fax : +886-3-2710190
 Taiwan Accreditation Foundation accreditation number: 1330

Site 2:
 Shenzhen Academy of Metrology and Quality Inspection
 No.4 TongFa Road, Xili Town Nanshan District, Shenzhen,
 China

The above equipment was tested by A Test Lab Techno Corp. The test data, data evaluation, test procedures, and equipment configurations shown in this report were made in accordance with the procedures given in ANSI C63.10: 2013 and the energy emitted by the sample tested as described in this report is in compliance with the requirements of FCC Rules Part 15.207, 15.209, 15.247 .The test results of this report relate only to the tested sample identified in this report.

Approved By : Fly Lu Reviewed By : Eric Ou Yang
 (Manager) (Fly Lu) (Testing Engineer) (Eric Ou Yang)



TABLE OF CONTENTS

1 General Information6

2 Test Summary.....7

3 Measurement Uncertainty.....8

4 EUT Description.....9

5 Test Methodology.....10

 5.1. Mode of Operation 10

 5.2. EUT Exercise Software..... 10

 5.3. Configuration of Test System Details11

 5.4. Test Site Environment..... 12

6 Conducted Emission Measurement.....13

 6.1. Limit..... 13

 6.2. Test Instruments 13

 6.3. Test Setup..... 13

 6.4. Test Procedure..... 14

 6.5. Test Result..... 15

7 Radiated Emission Measurement17

 7.1. Limit..... 17

 7.2. Test Instruments 17

 7.3. Setup..... 18

 7.4. Test Procedure..... 19

 7.5. Test Result..... 21

8 Maximum Conducted Output Power Measurement.....25

 8.1. Limit..... 25

 8.2. Test Setup..... 25

 8.3. Test Instruments 25

 8.4. Test Procedure..... 25

 8.5. Test Result..... 26

9 6dB RF Bandwidth and 99 % Occupied Bandwidth Measurement.....27

 9.1. Limit..... 27

 9.2. Test Setup..... 27

 9.3. Test Instruments 27

 9.4. Test Procedure..... 27

 9.5. Test Result..... 28

 9.6. Test Graphs 29

10 Maximum Power Density Measurement30



- 10.1. Limit..... 30
- 10.2. Test Setup..... 30
- 10.3. Test Instruments 30
- 10.4. Test Procedure..... 31
- 10.5. Test Result..... 31
- 10.6. Test Graphs 32
- 11 Out of Band Conducted Emissions Measurement33**
- 11.1. Limit..... 33
- 11.2. Test Setup..... 33
- 11.3. Test Instruments 33
- 11.4. Test Procedure..... 33
- 11.5. Test Graphs 34
- 12 Band Edges Measurement.....40**
- 12.1. Limit..... 40
- 12.2. Test Setup..... 40
- 12.3. Test Instruments 41
- 12.4. Test Procedure..... 41
- 12.5. Test Result..... 42
- 13 Antenna Requirement45**
- 13.1. Limit..... 45
- 13.2. Refer to statement below for compliance 45
- 13.3. Antenna Connector Construction..... 45
- 14 Exemption from Routine Evaluation Limits for FCC – SAR Evaluation.....46**



1 General Information

1.1 Applied Standard

Applied Rules: FCC 47 CFR PART 15 SUBPART C:2016
ANSI C63.10:2013

1.2 Test Location

TestLocation1: A Test Lab Techno Corp.
No. 140-1, Changan Street, Bade City, Taoyuan County 334, Taiwan R.O.C.
Taiwan Accreditation Foundation accreditation number: 1330

TestLocation2: Shenzhen Academy of Metrology and Quality Inspection
No.4 TongFa Road, Xili Town Nanshan District, Shenzhen, China

1.3 Test Environment Condition

Ambient Temperature: 19.5to 25°C
Ambient Relative Humidity:40 to 55 %
Atmospheric Pressure: Not applicable

2 Test Summary

Test Item	FCC Part No.	Requirements	Verdict
DTS (6 dB) Bandwidth	15.247(a)(2)	≥ 500 kHz.	PASS
Maximum Peak Conducted Output Power	15.247(b)(3)	For directional gain:< 30dBm – (G[dBi] –6 [dB]),peak; Other wise :< 30dBm, peak.	PASS
Maximum Power Spectral Density Level	15.247(e)	For directional gain :< 8dBm/3 kHz – (G[dBi] –6[dB]), peak. Other wise :< 8dBm/3 kHz, peak.	PASS
Band Edges Compliance	15.247(d)	< -20dBm/100 kHz if total peak power ≤power limit.	PASS
Unwanted Emissions into Non-Restricted Frequency Bands	15.247(d)	< -20dBm/100 kHz if total peak power ≤power limit.	PASS
Unwanted Emissions into Restricted Frequency Bands(Conducted)	15.247(d) 15.209	< -20dBm/100 kHz if total peak power ≤power limit.	PASS
Unwanted Emissions into Restricted Frequency Bands(Radiated)	15.247(d) 15.209	FCC Part 15.209 field strength limit;	PASS
AC Power Line Conducted Emissions	15.207	FCC Part 15.207 conducted limit;	PASS

3 Measurement Uncertainty

Test Item	Frequency Range	Uncertainty (dB)	
Conducted Emission	9kHz ~ 30MHz	± 2.02	
Radiated Emission	9kHz ~ 30MHz	± 3.14	
	30MHz ~ 1000MHz	Horizontal	± 3.98
		Vertical	± 3.62
	1000MHz ~ 18000MHz	Horizontal	± 3.11
		Vertical	± 3.07
	18000MHz ~ 40000MHz	Horizontal	± 3.66
Vertical		± 3.54	

4 EUT Description

Product Type	Element Cardio Band
Trade Name	FINIS
Model No.	1.30.046
Applicant	FINIS INC. 7085 Las Positas Road, Suite E, Livermore, CA, 94551, USA
Manufacturer	Berway Technology Ltd Unit 1301-03, 13/F., No. 88 Kwai Cheong Road, Kwai Chung, N. T., Hong Kong
FCC ID	2AGJZBW130046V1
Frequency Range	Bluetooth v4.0 LE: 2402 ~ 2480 MHz
Modulation Type	Bluetooth v4.0 LE: GFSK
Antenna Type	Chip Antenna
Antenna Gain	Bluetooth: 2.0 dBi
Hardware Version	V6
Software Version	V25
RF Output Power (PK)	Bluetooth v4.0 LE: -1.411dBm / 0.723mW
99 % Occupied Bandwidth	Bluetooth v4.0 LE: 1.0725 MHz

5 Test Methodology

5.1. Mode of Operation

Decision of Test ATL has verified the construction and function in typical operation. All the test modes were carried out with the EUT in normal operation, which was shown in this test report and defined as:

Test Mode
Mode 1: Normal Operation Mode
Mode 2: Bluetooth v4.0 LE TX Mode(Fixed channel)

Software used to control the EUT for staying in continuous transmitting mode was programmed.

After verification, all tests were carried out with the worst case test modes as shown. For radiated spurious emission the worst case was in Mode 2. For power line conducted emissions the worst case was in Mode 1. And the duty cycle is 100% during the test.

By preliminary testing and verifying three axis (X, Y and Z) position of EUT transmitted status, it was found that "X axis" position was the worst, then the final test was executed the worst condition and test data were recorded in this report.

The EUT is in fully-charged battery state test

5.2. EUT Exercise Software

1	Setup the EUT and assistant equipment as shown on 5.3
2	Turn on the power of all equipment.
3	Make EUT into continue transmitting mode or receiving mode under the help of PC software.

5.3. Configuration of Test System Details

Conducted Emissions

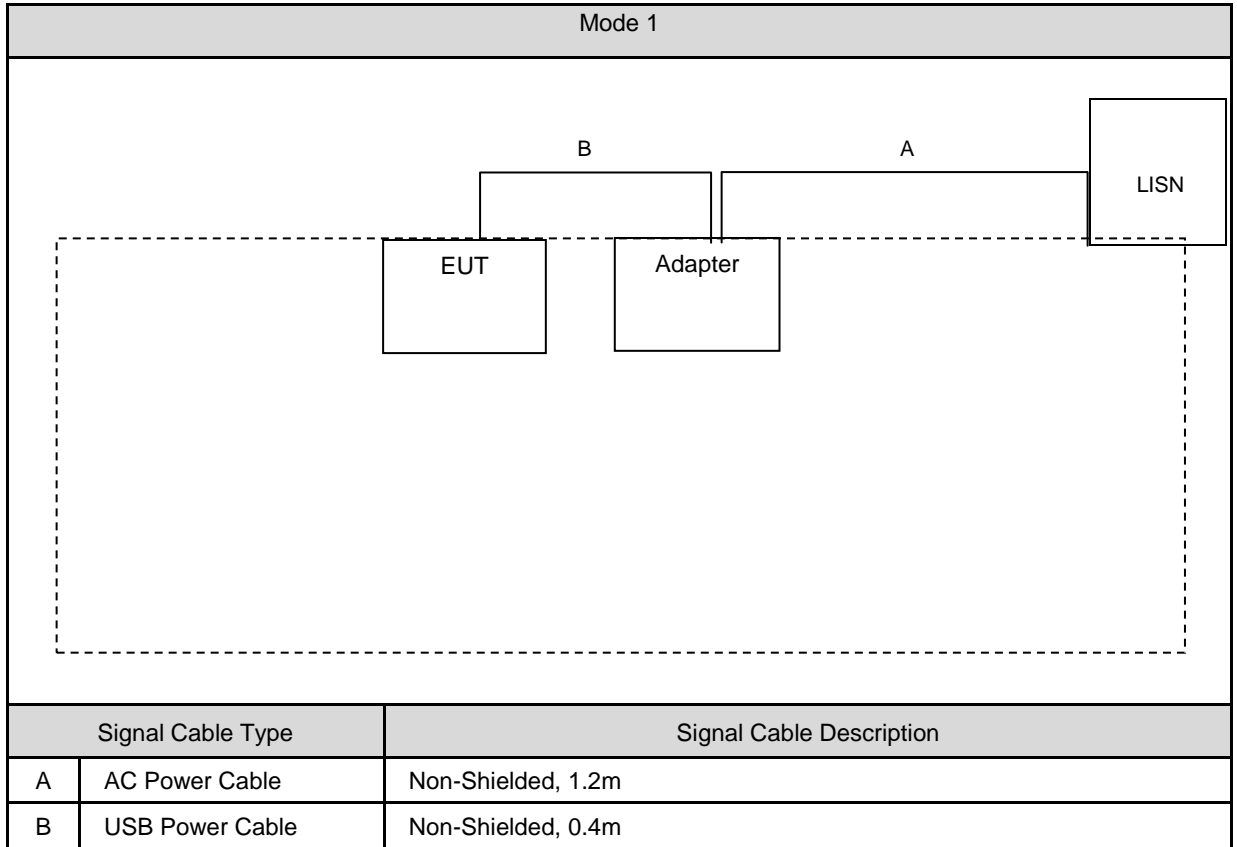

Auxiliary equipment description				
	Product	Manufacturer	Model Number	S/N
(1)	Power Adapter	Sony	AC-0400-JP	3513W51304150
--	--	--	--	--

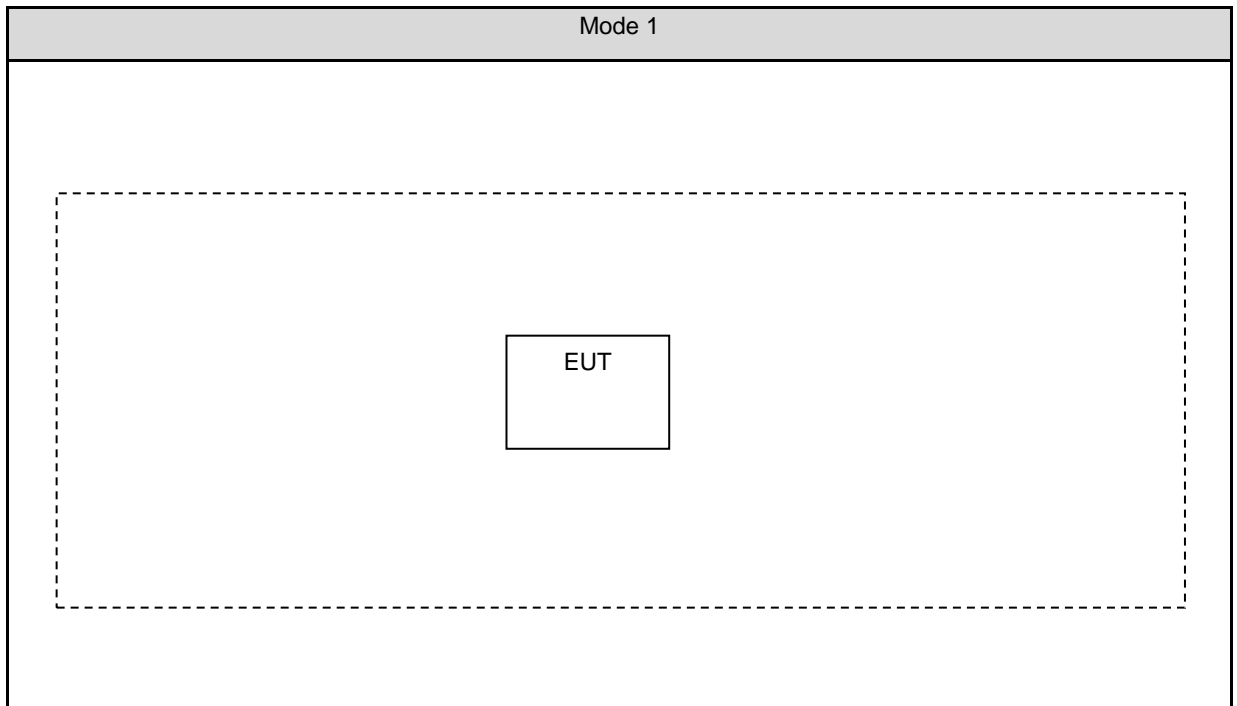
Radiated Emissions

5.4. Test Site Environment

Items	Required (IEC 60068-1)	Actual
Temperature (°C)	15-35	26
Humidity (%RH)	25-75	60
Barometric pressure (mbar)	860-1060	950

6 Conducted Emission Measurement

6.1. Limit

Frequency (MHz)	Quasi-peak	Average
0.15 - 0.5	66 to 56	56 to 46
0.50 - 5.0	56	46
5.0 - 30.0	60	50

6.2. Test Instruments

Describe	Manufacturer	Model Number	Serial Number	Cal. Date	Remark
Test Receiver	R&S	ESCI	100367	06/06/2015	(1)
LISN	R&S	ENV216	101040	03/07/2016	(1)
LISN	R&S	ENV216	101041	03/07/2016	(1)
Test Site	ATL	TE05	TE05	N.C.R.	-----
RF cable	WOKEN	---	C.10-07-04	10/24/2015	(1)
RF cable	WOKEN	---	C.10-07-05	10/24/2015	(1)

Remark: (1) Calibration period 1 year. (2) Calibration period 2 years. (3) Calibration period 3 years.

Note: N.C.R. = No Calibration Request. All the RF cables apply to 9 KHz to 40GHz.

6.3. Test Setup

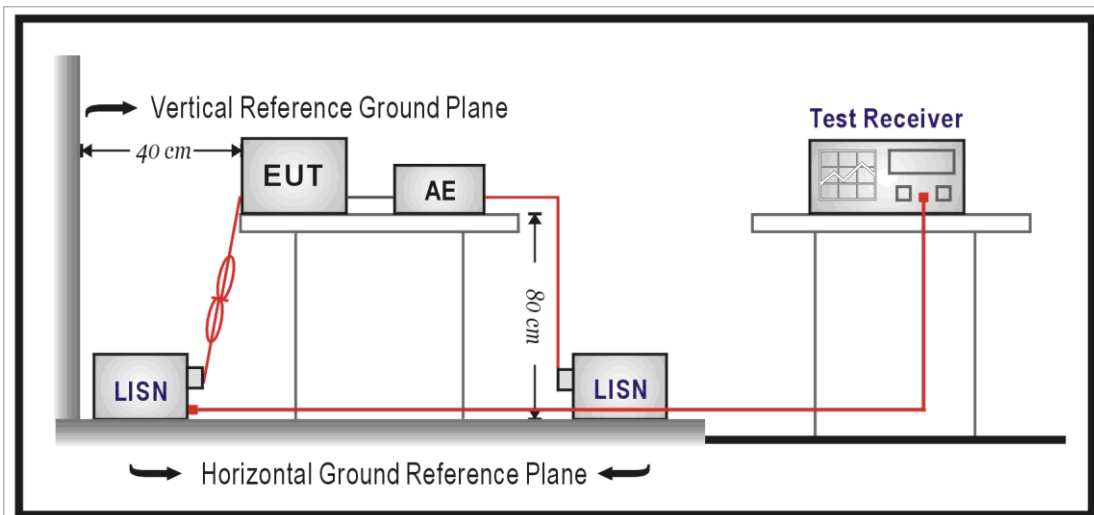

6.4. Test Procedure

The power line conducted emission measurements were performed in a shielded enclosure. The EUT was assembled on a wooden table which is 80 centimeters high, was placed 40 centimeters from the back wall and at least 1 meter from the sidewall.

Power was fed to the EUT from the public utility power grid through a line filter and EMCO Model ENV216 SH Line Impedance Stabilization Networks (LISN). The LISN housing, measuring instrumentation case, ground plane, etc., were electrically bonded together at the same RF potential. The Spectrum analyzer was connected to the AC line through an isolation transformer. The 50-ohm output of the LISN was connected to the spectrum analyzer directly. Conducted emission levels were in the CISPR quasi-peak detection mode. The analyzer's 6 dB bandwidth was set to 9 KHz. No post-detector video filter was used.

The spectrum was scanned from 150 KHz to 30 MHz. The physical arrangement of the test system and associated cabling was varied (within the scope of arrangements likely to be encountered in actual use) to determine the effect on the unit's emanations in amplitude and frequency. All spurious emission frequencies were observed. The highest emission amplitudes relative to the appropriate limit were measured and have been recorded in paragraph 4.1.

Note : After verification, EUT connects to the PC or AC adapter were carried out with the worst case test modes as shown, it is EUT connects to the AC adapter.

6.5. Test Result

Standard:	FCC Class B Conduction(QP)	Line:	L1
Test item:	Conducted Emission	Power:	AC 120V/60Hz
Model Number:	1.30.046	Temp.(°C)/Hum.(%RH):	26(°C)/60%RH
Mode:	BT Mode	Date:	2016/03/08
Description:			

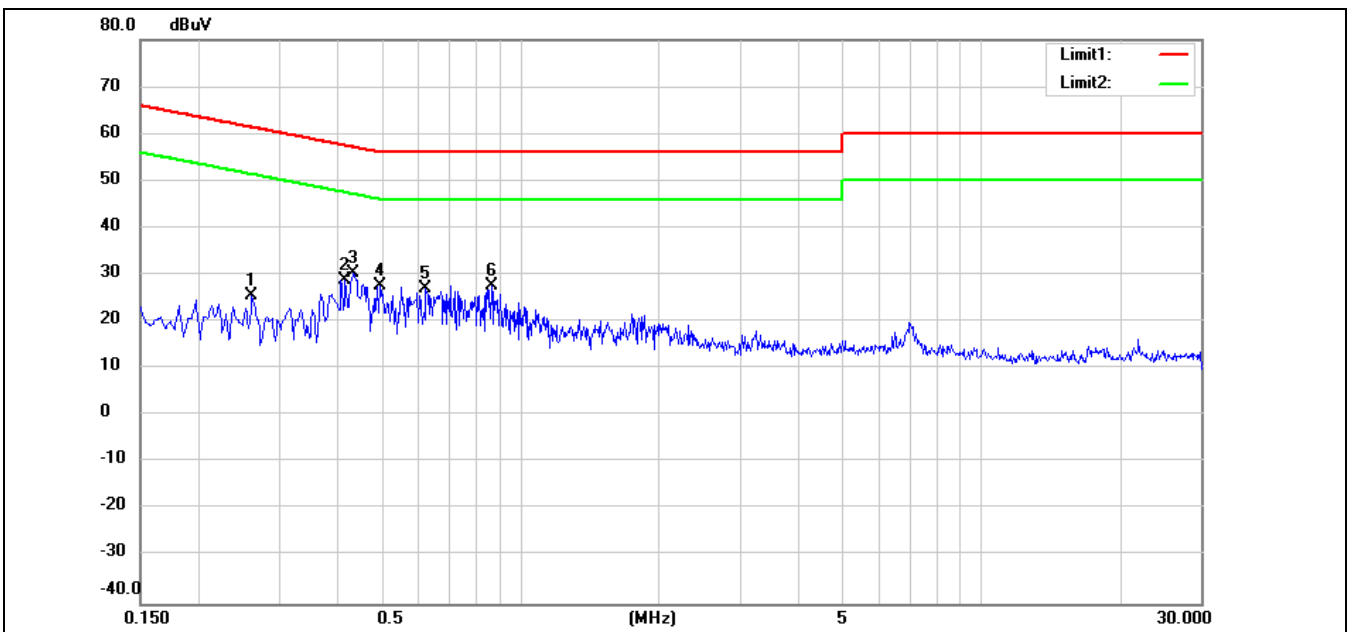

No.	Frequency (MHz)	QP Reading (dBuV)	AVG Reading (dBuV)	Correction Factor (dB)	QP Result (dBuV)	AVG Result (dBuV)	QP Limit (dBuV)	AVG Limit (dBuV)	QP Margin (dB)	AVG Margin (dB)	Remark
1	0.2620	14.39	5.91	0.32	14.71	6.23	61.37	51.37	-46.66	-45.14	Pass
2	0.4180	18.99	12.18	0.35	19.34	12.53	57.49	47.49	-38.15	-34.96	Pass
3	0.4340	19.59	12.83	0.35	19.94	13.18	57.18	47.18	-37.24	-34.00	Pass
4	0.4980	16.86	9.67	0.35	17.21	10.02	56.03	46.03	-38.82	-36.01	Pass
5	0.6260	16.42	8.84	0.38	16.80	9.22	56.00	46.00	-39.20	-36.78	Pass
6	0.8700	15.90	9.00	0.40	16.30	9.40	56.00	46.00	-39.70	-36.60	Pass

Note:1. Result (dBuV) = Correction factor (dB) + Reading(dBuV).

2. Correction factor (dB/m) = Antenna Factor (dB/m) + Cable loss (dB) – Pre-Amplifier gain (dB).



Standard:	FCC Class B Conduction(QP)	Line:	N
Test item:	Conducted Emission	Power:	AC 120V/60Hz
Model Number:	1.30.046	Temp.(°C)/Hum.(%RH):	26(°C)/60%RH
Mode:	BT Mode	Date:	2016/03/08
Description:			

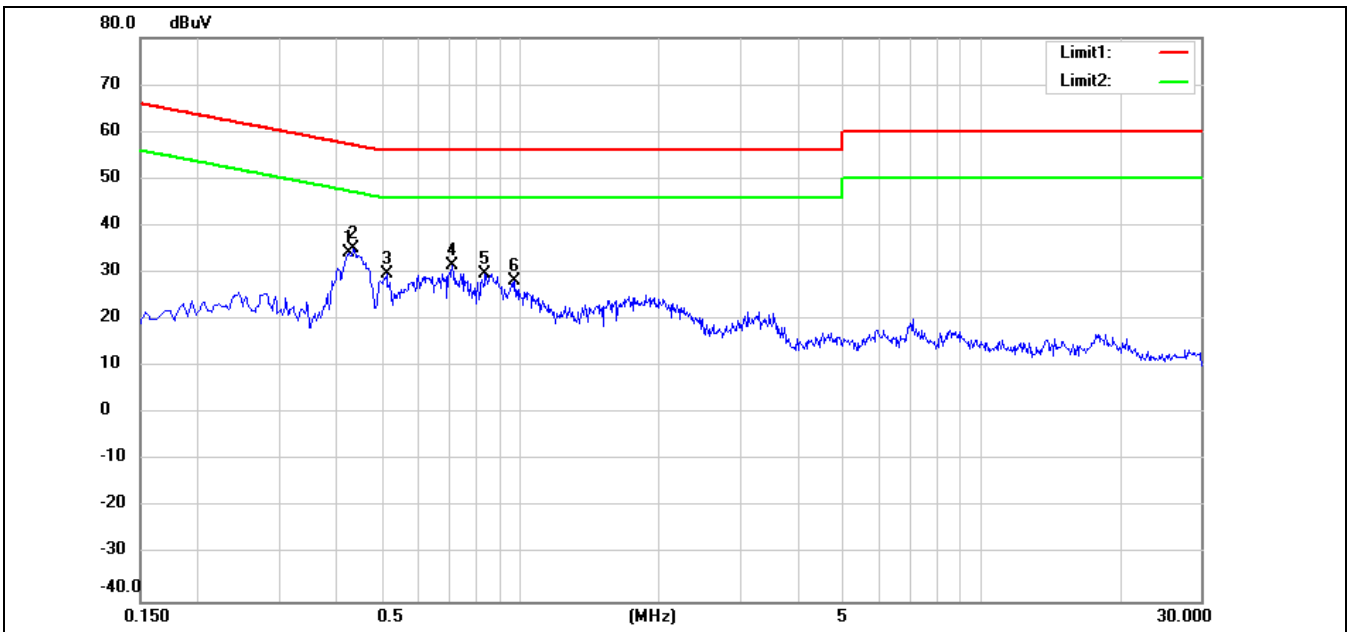

No.	Frequency (MHz)	QP Reading (dBuV)	AVG Reading (dBuV)	Correction Factor (dB)	QP Result (dBuV)	AVG Result (dBuV)	QP Limit (dBuV)	AVG Limit (dBuV)	QP Margin (dB)	AVG Margin (dB)	Remark
1	0.4193	29.34	18.40	0.35	29.69	18.75	57.46	47.46	-27.77	-28.71	Pass
2	0.4340	30.38	19.52	0.35	30.73	19.87	57.18	47.18	-26.45	-27.31	Pass
3	0.5140	23.78	13.40	0.35	24.13	13.75	56.00	46.00	-31.87	-32.25	Pass
4	0.7020	26.01	15.47	0.39	26.40	15.86	56.00	46.00	-29.60	-30.14	Pass
5	0.8420	25.29	15.05	0.40	25.69	15.45	56.00	46.00	-30.31	-30.55	Pass
6	0.9740	22.74	12.89	0.38	23.12	13.27	56.00	46.00	-32.88	-32.73	Pass

Note:1. Result (dBuV) = Correction factor (dB) + Reading(dBuV).

2. Correction factor (dB/m) = Antenna Factor (dB/m) + Cable loss (dB) – Pre-Amplifier gain (dB).

7 Radiated Emission Measurement

7.1. Limit

According to §15.209(a), except as provided elsewhere in this subpart, the emissions from an intentional radiator shall not exceed the field strength levels specified in the following table:

Frequency (MHz)	Field Strength ($\mu\text{V}/\text{m}$ at meter)	Measurement Distance (meters)
0.009 – 0.490	2400 / F (kHz)	300
0.490 – 1.705	24000 / F (kHz)	30
1.705 – 30.0	30	30
30 - 88	100**	3
88-216	150**	3
216-960	200**	3
Above 960	500	3

** Except as provided in paragraph (g), fundamental emissions from intentional radiators operating under this Section shall not be located in the frequency bands 54-72 MHz, 76-88 MHz, 174-216 MHz or 470-806 MHz. However, operation within these frequency bands is permitted under other sections of this Part, e.g., Sections 15.231 and 15.241.

7.2. Test Instruments

3 Meter Chamber					
Model No.	Equipment	Manufacturer	Serial Number	Cal. Date	Remark
ESCS30	EMI Test Receiver	Rohde & Schwarz	830245/009	Dec.29, 2015	1 Year
VULB9163	Bilog Antenna	Schwarzbeck	264	Jan.19, 2016	1 Year
9X6X6	3m Semi-anechoic chamber	Albatross Projects	SB3450/01	Oct.12, 2015	1 year
HF907	Horn Antenna	Rohde & Schwarz	100309	May.15,2015	1 year
FMZB1516	Loop Antenna	Schwarzbeck	113	Jan 21,2016	1 year
3160-09	Horn antenna	ETS	8501/10	May.15.2015	1 year
SCU26	Pre Amplifier	Rohde & Schwarz	10020	May.15.2015	1 year
SCU40	Pre Amplifier	Rohde & Schwarz	10015	May.15.2015	1 year
ESU40	Test Receiver	Rohde & Schwarz	100263	May.15.2015	1 year
---	RF cable	WOKEN	S02-1404-09-065	May.11.2015	1 year
---	RF cable	WOKEN	S02-1404-09-047	May.11.2015	1 year
---	RF cable	WOKEN	S02-1404-09-052	May.11.2015	1 year

Remark: (1) Calibration period 1 year. (2) Calibration period 2 years. (3) Calibration period 3 years.

Note: N.C.R. = No Calibration Request. All the RF cables apply to 9 KHz to 40GHz.

7.3. Setup

9KHz-30MHz

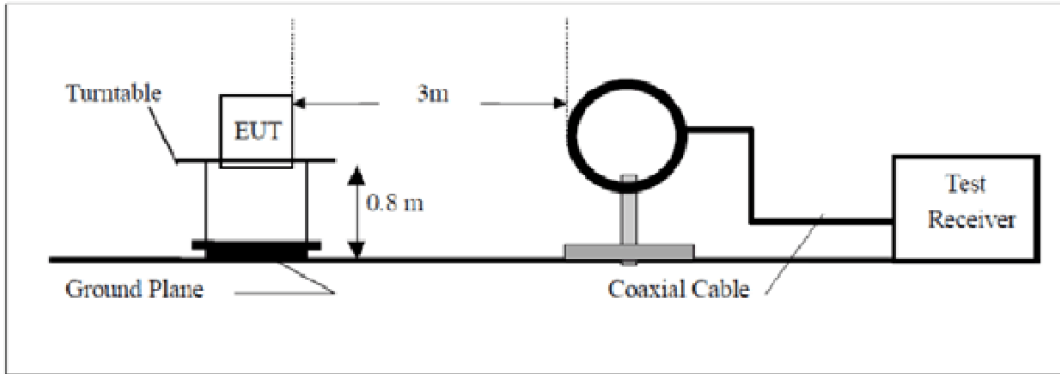

30MHz-1 GHz

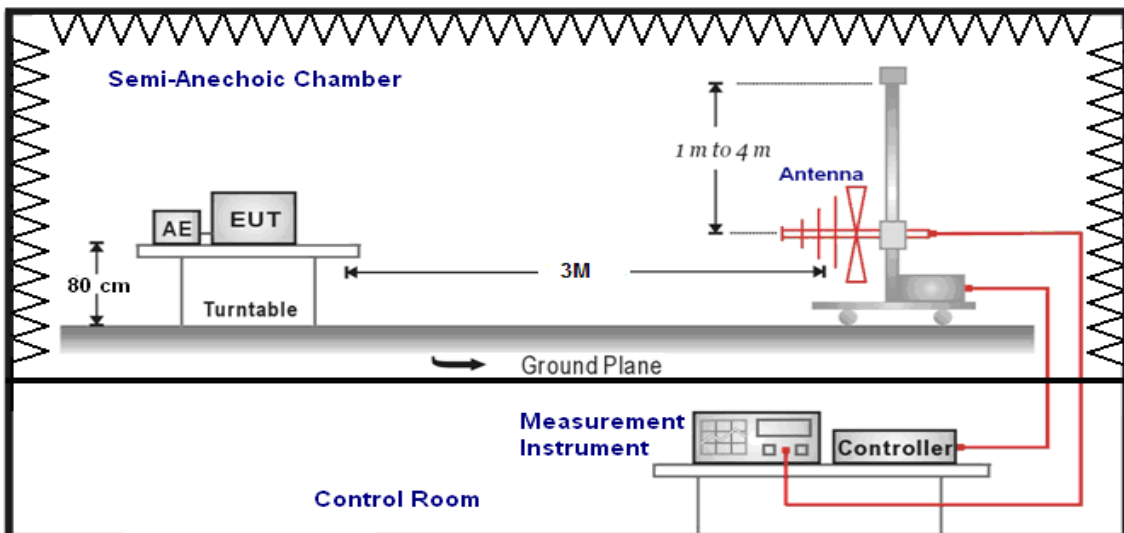

Above 1GHz

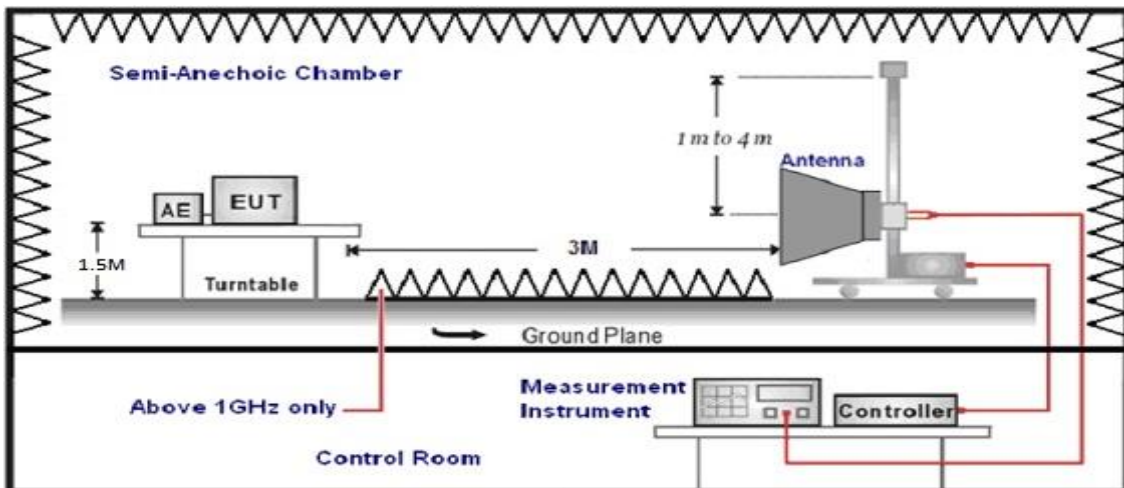

7.4. Test Procedure

Final radiation measurements were made on a three-meter, Semi Anechoic Chamber. The EUT system was placed on a nonconductive turntable which is 0.8 meters height for below 1GHz and 1.5 meters height for above 1GHz, top surface 1.0 x 1.5 meter. The spectrum was examined from 9 KHz to 26.5 GHz in order to cover the whole spectrum below 10th harmonic which could generate from the EUT. During the test, EUT was set to transmit continuously & Measurements spectrum range from 9 kHz to 26.5 GHz is investigated.

For measurements below 1 GHz the resolution bandwidth is set to 100 kHz for peak detection measurements or 120 kHz for quasi-peak detection measurements. Peak detection is used unless otherwise noted as quasi-peak.

For measurements above 1 GHz the resolution bandwidth is set to 1 MHz, and then the video bandwidth is set to 1 MHz for peak measurements and 10 Hz for average measurements.

A nonconductive material surrounded the EUT to supporting the EUT for standing on three orthogonal planes. At each condition, the EUT was rotated 360 degrees, and the antenna was raised and lowered from one to four meters to find the maximum emission levels. Measurements were taken using both horizontal and vertical antenna polarization.

SCHWARZBECK MESS-ELEKTRONIK Biconilog Antenna (mode VULB9163) at 3 Meter and the SCHWARZBECK Double Ridged Guide Antenna (model FH907&3160) was used in frequencies 1 – 26.5 GHz at a distance of 1 meter. All test results were extrapolated to equivalent signal at 3 meters utilizing an inverse linear distance extrapolation Factor (20dB/decade).

For testing above 1GHz, the emission level of the EUT in peak mode was 20dB lower than average limit (that means the emission level in peak mode also complies with the limit in average mode), then testing will be stopped and peak values of EUT will be reported, otherwise, the emissions will be measured in average mode again and reported.

Appropriate preamplifiers were used for improving sensitivity and precautions were taken to avoid overloading or desensitizing the spectrum analyzer. No post – detector video filters were used in the test.

For the radiated emission test above 1GHz:

Place the measurement antenna away from each area of the EUT determined to be a source of emissions at the specified measurement distance, while keeping the measurement antenna aimed at the source of emissions at each frequency of significant emissions, with polarization oriented for maximum response. The measurement antenna may have to be higher or lower than the EUT, depending on the radiation pattern of the emission and staying aimed at the emission source for receiving the maximum signal. The final measurement antenna elevation shall be that which maximizes the emissions. The measurement antenna elevation for maximum emissions shall be restricted to a range of heights of from 1 m to 4 m above the ground or reference ground plane.

The spectrum analyzer's 6 dB bandwidth was set to 1 MHz, and the analyzer was operated in the peak detection mode, for frequencies both below and up 1 GHz. The average levels were obtained by subtracting the duty cycle correction factor from the peak readings.

The following procedures were used to convert the emission levels measured in decibels referenced to 1 microvolt (dBuV) into field intensity in micro volts pre meter (uV/m).

The actual field intensity in decibels referenced to 1 microvolt in to field intensity in micro volts per meter (dBuV/m).

The actual field intensity in decibels referenced to 1 microvolt per meter (dBuV/m) is determined by algebraically adding the measured reading in dBuV, the antenna factor (dB), and cable loss (dB) and Subtracting the gain of preamplifier (dB) is auto calculate in spectrum analyzer.

$$(1) \text{ Amplitude (dBuV/m)} = \text{FI (dBuV)} + \text{AF (dBuV)} + \text{CL (dBuV)} - \text{Gain (dB)}$$

FI= Reading of the field intensity.

AF= Antenna factor.

CL= Cable loss.

P.S Amplitude is auto calculate in spectrum analyzer.

(2) Actual Amplitude (dBuV/m) = Amplitude (dBuV)-Dis(dB)

The FCC specified emission limits were calculated according the EUT operating frequency and by following linear interpolation equations:

(a) For fundamental frequency : Transmitter Output < +30dBm

(b) For spurious frequency : Spurious emission limits = fundamental emission limit /10

Data of measurement within this frequency range without mark in the table above means the reading of emissions are attenuated more than 20dB below the permissible limits or the field strength is too small to be measured.

7.5. Test Result

Below 1GHz

Standard:	FCC Class B 3M Radiation	Test Distance:	3m
Test item:	Radiated Emission	Power:	DC 3.7V
Model Number:	1.30.046	Temp.(°C)/Hum.(%RH):	26(°C)/60%RH
Mode:	2	Date:	2016/03/18
Frequency:	2402MHz		

Frequency (MHz)	Reading (dBuV)	Correct Factor (dB/m)	Result (dBuV/m)	Limit (dBuV/m)	Margin (dB)	Remark	Ant.Polar. H / V
--	--	--	--	--	--	QP	H
--	--	--	--	--	--	QP	H
--	--	--	--	--	--	QP	H
--	--	--	--	--	--	QP	V
--	--	--	--	--	--	QP	V
--	--	--	--	--	--	QP	V

Note: No emission found between lowest internal used/generated frequencies to 30MHz (9 kHz~30MHz). And only the worst case is recorded here for 30MHz to 1GHz.

Horizontal & Vertical

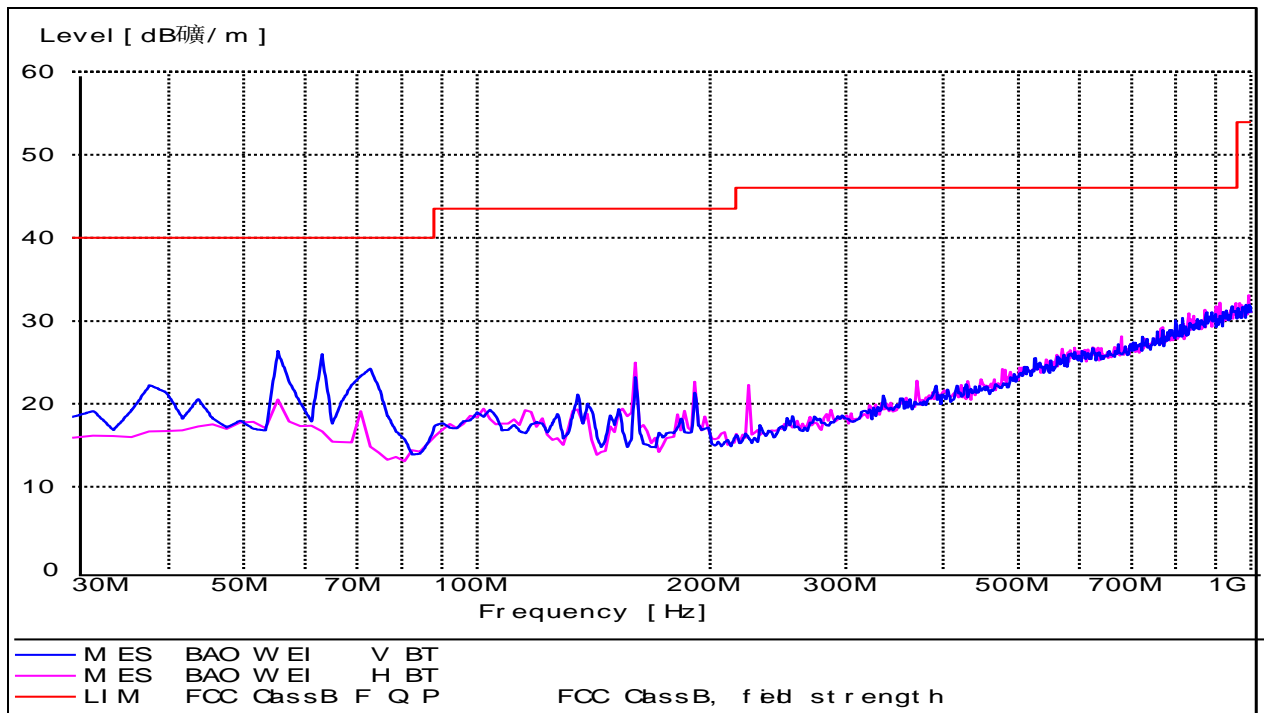



Above 1GHz

Standard:	FCC Class B 3M Radiation	Test Distance:	3m
Test item:	Radiated Emission	Power:	DC 3.7V
Model Number:	1.30.046	Temp.(°C)/Hum.(%RH):	26(°C)/60%RH
Mode:	2	Date:	2016/03/18
Frequency:	2402MHz		

Frequency (MHz)	Reading (dBuV)	Correct Factor (dB/m)	Result (dBuV/m)	Limit (dBuV/m)	Margin (dB)	Remark	Ant.Polar H / V
4804.00	40.74	6.92	47.66	74.00	26.34	peak	H
--	--	--	--	--	--	peak	H
--	--	--	--	--	--	peak	H
4804.00	40.79	6.92	47.71	74.00	26.29	peak	V
--	--	--	--	--	--	peak	V
--	--	--	--	--	--	peak	V

Horizontal

Electric Field Strength FCC 15.247 1-18GHz

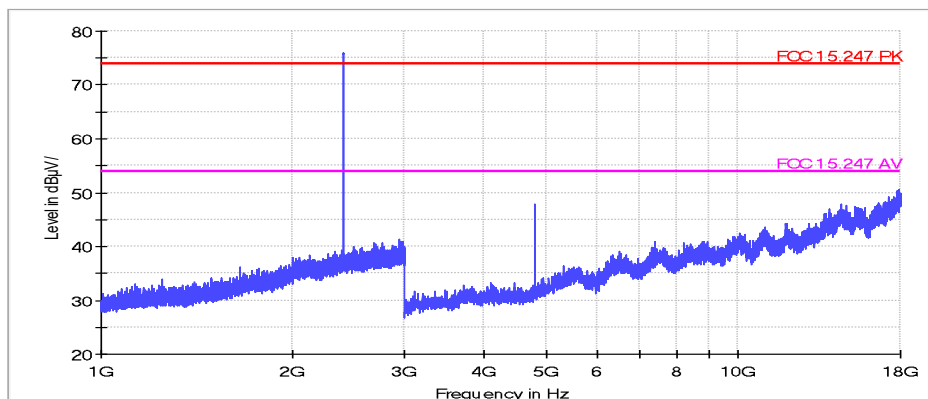

Vertical

Electric Field Strength FCC 15.247 1-18GHz

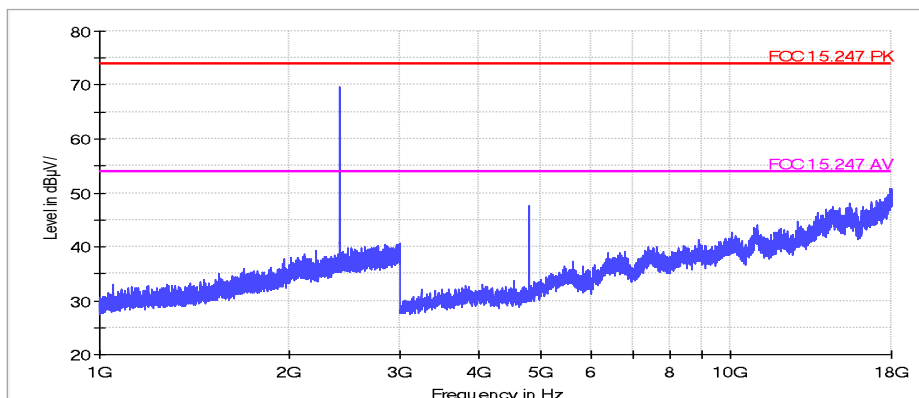



Standard:	FCC Class B 3M Radiation	Test Distance:	3m
Test item:	Radiated Emission	Power:	DC 3.7V
Model Number:	1.30.046	Temp.(°C)/Hum.(%RH):	26(°C)/60%RH
Mode:	2	Date:	2016/03/18
Frequency:	2440MHz		

Frequency (MHz)	Reading (dBuV)	Correct Factor (dB/m)	Result (dBuV/m)	Limit (dBuV/m)	Margin (dB)	Remark	Ant.Polar. H / V
4880.000	45.72	7.51	53.23	74.00	20.77	peak	H
--	--	--	--	--	--	peak	H
--	--	--	--	--	--	peak	H
4880.000	45.91	7.51	53.42	74.00	20.58	peak	V
--	--	--	--	--	--	peak	V
--	--	--	--	--	--	peak	V

Horizontal

Electric Field Strength FCC 15.247 1-18GHz

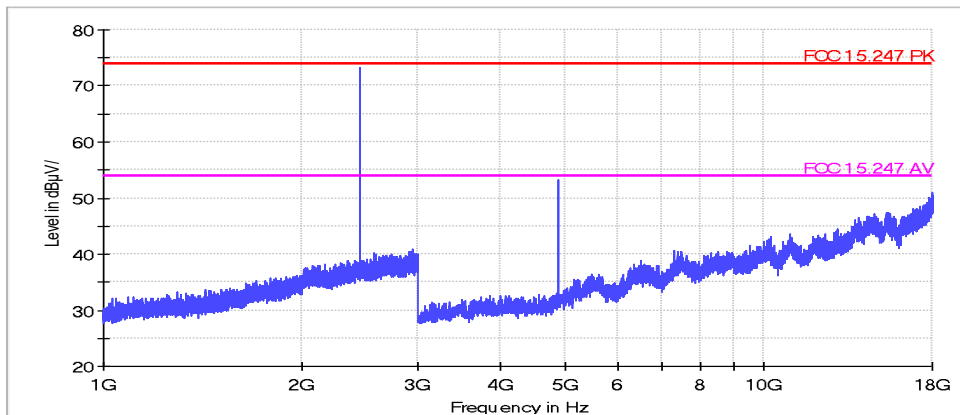

Vertical

Electric Field Strength FCC 15.247 1-18GHz

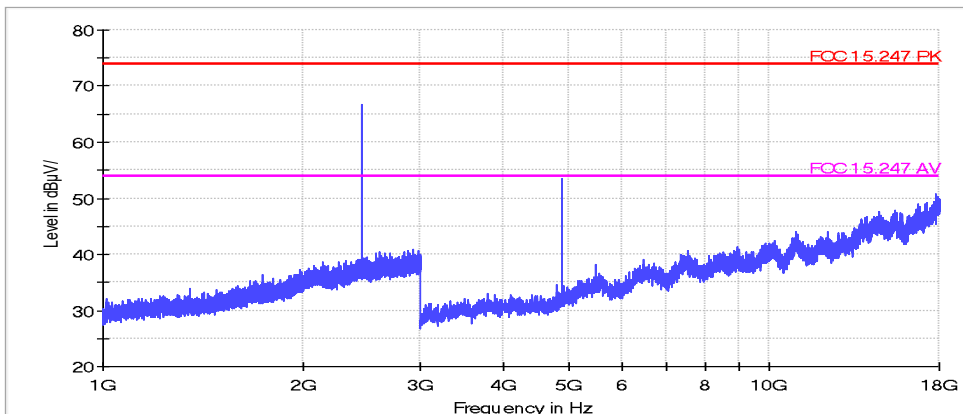

Standard:	FCC Class B 3M Radiation	Test Distance:	3m
Test item:	Radiated Emission	Power:	DC 3.7V
Model Number:	1.30.046	Temp.(°C)/Hum.(%RH):	26(°C)/60%RH
Mode:	2	Date:	2016/03/18
Frequency:	2480MHz		

Frequency (MHz)	Reading (dBuV)	Correct Factor (dB/m)	Result (dBuV/m)	Limit (dBuV/m)	Margin (dB)	Remark	Ant.Polar. H / V
4960.000	32.69	7.92	40.61	74.00	33.39	peak	H
--	--	--	--	--	--	peak	H
--	--	--	--	--	--	peak	H
4960.000	32.71	7.92	40.63	74.00	33.37	peak	V
--	--	--	--	--	--	peak	V
--	--	--	--	--	--	peak	V

Horizontal

Electric Field Strength FCC 15.247 1-18GHz

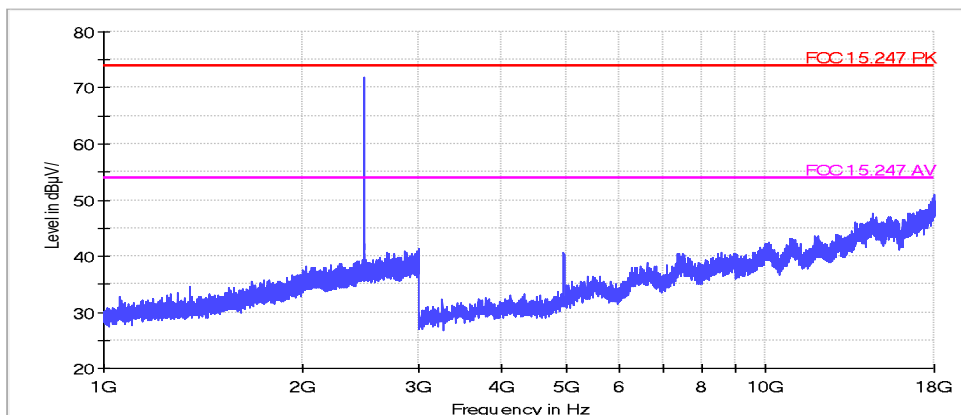

Vertical

Electric Field Strength FCC 15.247 1-18GHz

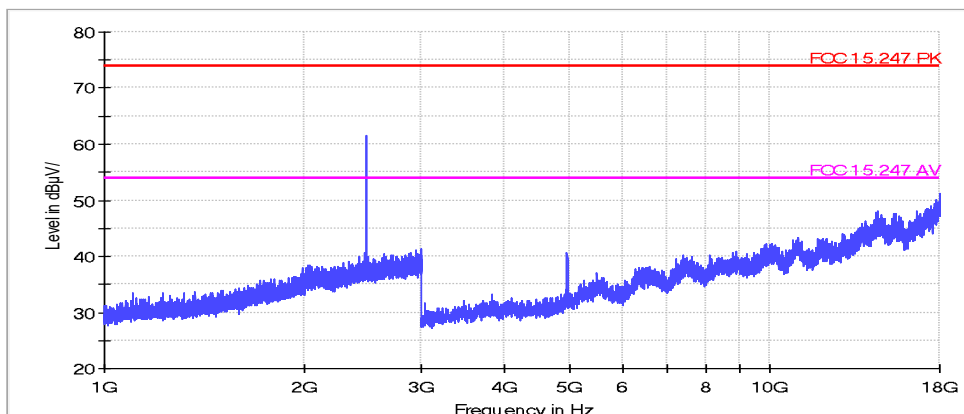

8 Maximum Conducted Output Power Measurement

8.1. Limit

For systems using digital modulation in the 2400-2483.5MHz, the limit for peak output power is 30dBm.

8.2. Test Setup

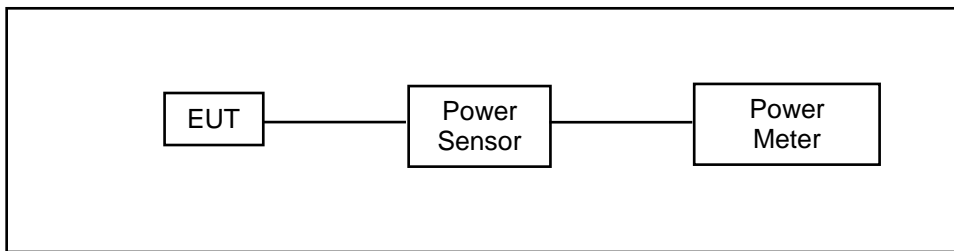

8.3. Test Instruments

Equipment	Manufacturer	Model Number	Serial Number	Cal. Date	Remark
Single Channel PK Power Sensor	Agilent	N1911A	MY45101619	12/15/2015	(1)
Wideband Power Meter	Agilent	N1921A	MY45241957	12/15/2015	(1)
Test Site	ATL	TE02	TE02	N.C.R.	-----
RF cable	WOKEN	---	C.10-07-02	10/24/2015	(1)
RF cable	WOKEN	---	C.10-07-03	10/24/2015	(1)
Temporary antenna connector	---	---	A01-224	05/24/2015	(1)

Remark: (1) Calibration period 1 year.

NOTE: N.C.R. = No Calibration Request.

All the RF cables apply to 9 KHz to 40GHz. The temporary antenna connector is soldered on the PCB board in order to perform conducted tests and this temporary antenna connector is listed in the equipment list.

8.4. Test Procedure

The tests below are run with the EUT's transmitter set at high power in TX mode. The EUT is needed to force selection of output power level and channel number. While testing, EUT was set to transmit continuously. Remove the Subjective device's antenna and connect the RF output port to power sensor. The maximum peak output power shall not exceed 1 watt.

Use a direct connection between the antenna port of transmitter and the power sensor, for prevent the power sensor input attenuation 40-50 dB. Set the RBW Bandwidth of the emission or use a channel power meter mode.

For antennas with gains of 6 dBi or less, maximum allowed transmitter output is 1 watt (+30 dBm). For antennas with gains greater than 6 dBi, transmitter output level must be decreased by an amount equal to (GAIN - 6)/3 dBm.

The antenna port of the EUT was connected to the input of a power sensor. Power was read directly and cable loss correction was added to the reading to obtain power at the EUT antenna terminals.

8.5. Test Result

Model Number	1.30.046		
Test Item	Maximum Conducted Output Power		
Test Mode	Mode 2		
Date of Test	2016/03/25	Test Site	TE05
Frequency (MHz)	Peak Power		Limit (dBm)
	(dBm)	(mW)	
2402	-1.411	0.723	< 30
2440	-2.502	0.562	< 30
2480	-3.933	0.404	< 30

9 6dB RF Bandwidth and 99 % Occupied Bandwidth Measurement

9.1. Limit

6dB RF Bandwidth: Systems using digital modulation techniques may operate in the 2400–2483.5 MHz bands. The minimum 6 dB band-width shall be at least 500 kHz.

99 % Occupied Bandwidth: N/A

9.2. Test Setup

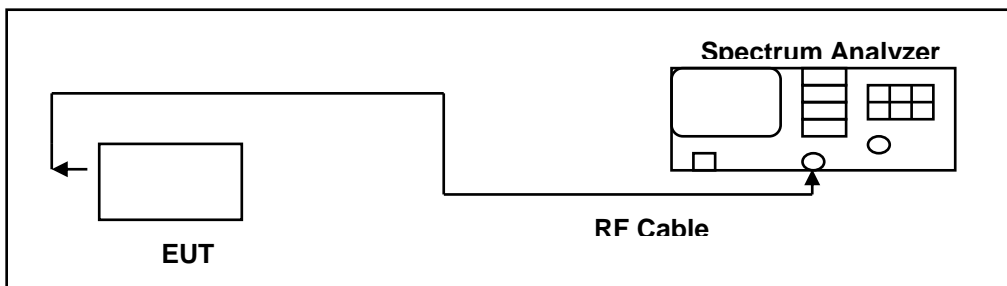

9.3. Test Instruments

Equipment	Manufacturer	Model Number	Serial Number	Cal. Date	Remark
Spectrum Analyzer	Agilent	N9020A	MY53420615	05/12/2015	(1)
Test Site	ATL	TE05	TE05	N.C.R.	-----
RF cable	WOKEN	---	C.10-07-02	10/24/2015	(1)
RF cable	WOKEN	---	C.10-07-03	10/24/2015	(1)
Temporary antenna connector	---	---	A01-224	05/24/2015	(1)

Remark: (1) Calibration period 1 year. (2) Calibration period 2 years.

NOTE: N.C.R. = No Calibration Request.

All the RF cables apply to 9 KHz to 40GHz. The temporary antenna connector is soldered on the PCB board in order to perform conducted tests and this temporary antenna connector is listed in the equipment list.

9.4. Test Procedure

The EUT was setup to ANSI C63.10:2013; tested for compliance to FCC 47CFR 15.247 requirements.

6dB RF Bandwidth: The antenna port of the EUT was connected to the input of a spectrum analyzer. Analyzer RES BW was set to 100 kHz. For each RF output channel investigated, the spectrum analyzer center frequency was set to the channel carrier. A peak output reading was taken, a DISPLAY line was drawn 6 dB lower than peak level. The 6 dB bandwidth was determined from where the channel output spectrum intersected the display line.

The test was performed at 3 channels (Channel low, middle, high)

99 % Occupied Bandwidth: The transmitter shall be operated at its maximum carrier power measured under normal test conditions.



The video bandwidth shall be set to 3 times the resolution bandwidth. Video averaging is not permitted. Where practical, a sampling detector shall be used since a peak or, peak hold, may produce a wider bandwidth than actual.

The trace data points are recovered and are directly summed in linear terms. The recovered amplitude data points, beginning at the lowest frequency, are placed in a running sum until 0.5% of the total is reached and that frequency recorded. The process is repeated for the highest frequency data points. This frequency is recorded.

9.5. Test Result

Model Number	1.30.046		
Test Item	6dB RF Bandwidth & 99 % Occupied Bandwidth		
Test Mode	Mode 2		
Date of Test	2016/03/25	Test Site	TE05
Frequency (MHz)	6dB Bandwidth (kHz)	99% Occupied Bandwidth (MHz)	Limit (kHz)
2402	660.8	1.0706	≥500
2440	670.0	1.0641	≥500
2480	663.8	1.0725	≥500

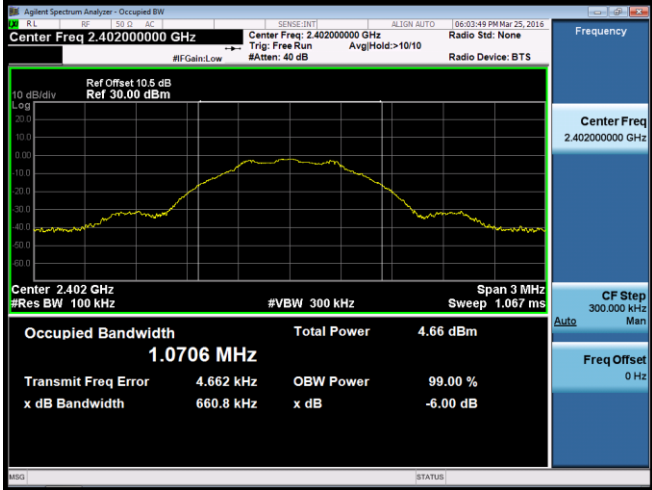
9.6. Test Graphs

Mode 2	
2402	 <p>Agilent Spectrum Analyzer - Occupied BW</p> <p>Center Freq: 2.402000000 GHz</p> <p>Center Freq: 2.402000000 GHz</p> <p>Ref Offset: 10.5 dB, Ref: 30.00 dBm</p> <p>Center: 2.402 GHz, Res BW: 100 kHz, #VBW: 300 kHz, Span: 3 MHz, Sweep: 1.067 ms</p> <p>Occupied Bandwidth: 1.0706 MHz</p> <p>Total Power: 4.66 dBm</p> <p>Transmit Freq Error: 4.662 kHz, OBW Power: 99.00 %</p> <p>x dB Bandwidth: 660.8 kHz, x dB: -6.00 dB</p>
2440	 <p>Agilent Spectrum Analyzer - Occupied BW</p> <p>Center Freq: 2.440000000 GHz</p> <p>Center Freq: 2.440000000 GHz</p> <p>Ref Offset: 10.45 dB, Ref: 30.00 dBm</p> <p>Center: 2.44 GHz, Res BW: 100 kHz, #VBW: 300 kHz, Span: 3 MHz, Sweep: 1.067 ms</p> <p>Occupied Bandwidth: 1.0641 MHz</p> <p>Total Power: 3.53 dBm</p> <p>Transmit Freq Error: 4.799 kHz, OBW Power: 99.00 %</p> <p>x dB Bandwidth: 670.0 kHz, x dB: -6.00 dB</p>
2480	 <p>Agilent Spectrum Analyzer - Occupied BW</p> <p>Center Freq: 2.480000000 GHz</p> <p>Center Freq: 2.480000000 GHz</p> <p>Ref Offset: 10.45 dB, Ref: 30.00 dBm</p> <p>Center: 2.48 GHz, Res BW: 100 kHz, #VBW: 300 kHz, Span: 3 MHz, Sweep: 1.067 ms</p> <p>Occupied Bandwidth: 1.0725 MHz</p> <p>Total Power: 2.02 dBm</p> <p>Transmit Freq Error: 4.881 kHz, OBW Power: 99.00 %</p> <p>x dB Bandwidth: 663.8 kHz, x dB: -6.00 dB</p>

10 Maximum Power Density Measurement

10.1.Limit

For digitally modulated systems, the power spectral density conducted from the intentional radiator to the antenna shall not be greater than 8 dBm in any 3 kHz band during any time interval of continuous transmission.

10.2.Test Setup

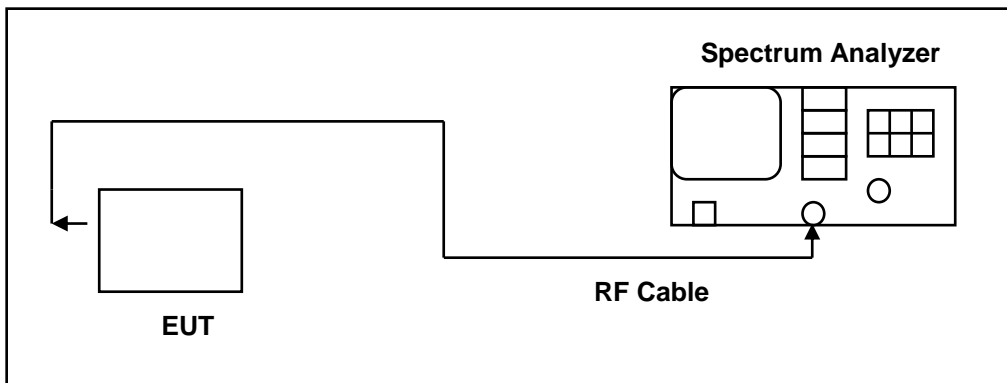

10.3.Test Instruments

Equipment	Manufacturer	Model Number	Serial Number	Cal. Date	Remark
Spectrum Analyzer	Agilent	N9020A	MY53420615	05/12/2015	(1)
Test Site	ATL	TE05	TE05	N.C.R.	-----
RF cable	WOKEN	---	C.10-07-02	10/24/2015	(1)
RF cable	WOKEN	---	C.10-07-03	10/24/2015	(1)
Temporary antenna connector	---	---	A01-224	05/24/2015	(1)

Remark: (1) Calibration period 1 year. (2) Calibration period 2 years.

NOTE: N.C.R. = No Calibration Request.

All the RF cables apply to 9 KHz to 40GHz. The temporary antenna connector is soldered on the PCB board in order to perform conducted tests and this temporary antenna connector is listed in the equipment list.

10.4. Test Procedure

The EUT was setup to ANSI C63.10:2013; tested for compliance to FCC 47CFR 15.247 requirements.

1. Set analyzer center frequency to DTS channel center frequency.
2. Set the span to 1.5 times the DTS bandwidth.
3. Set the RBW to: $3 \text{ kHz} \leq \text{RBW} \leq 100 \text{ kHz}$.
4. Set the VBW $\geq 3 \times \text{RBW}$.
5. Detector = peak.
6. Sweep time = auto couple.
7. Trace mode = max hold.
8. Allow trace to fully stabilize.
9. Use the peak marker function to determine the maximum amplitude level within the RBW.
10. If measured value exceeds limit, reduce RBW (no less than 3 kHz) and repeat.

10.5. Test Result

Model Number	1.30.046		
Test Item	Maximum Power Density		
Test Mode	Mode 2		
Date of Test	2016/03/25	Test Site	TE05
Frequency (MHz)	Reading (dBm/3KHz)		Limit (dBm/3kHz)
2402	-12.784		< 8
2440	-14.410		< 8
2480	-16.204		< 8

10.6. Test Graphs

Mode 2	
2402	<p>Agilent Spectrum Analyzer - Sweep SA Center Freq 2.402000000 GHz Ref Offset 10.6 dB Ref 30.00 dBm Mkr1 2.401 994 375 GHz -12.784 dBm #Avg Type: RMS Avg/Hold: 20/100 #Res BW 3.0 kHz #VBW 10 kHz Span 5.000 MHz Sweep 158.9 ms (8001 pts)</p>
2440	<p>Agilent Spectrum Analyzer - Sweep SA Center Freq 2.440000000 GHz Ref Offset 10.45 dB Ref 30.00 dBm Mkr1 2.439 994 375 GHz -14.410 dBm #Avg Type: RMS Avg/Hold: 20/100 #Res BW 3.0 kHz #VBW 10 kHz Span 5.000 MHz Sweep 158.9 ms (8001 pts)</p>
2480	<p>Agilent Spectrum Analyzer - Sweep SA Center Freq 2.480000000 GHz Ref Offset 10.45 dB Ref 30.00 dBm Mkr1 2.479 993 750 GHz -16.204 dBm #Avg Type: RMS Avg/Hold: 24/100 #Res BW 3.0 kHz #VBW 10 kHz Span 5.000 MHz Sweep 158.9 ms (8001 pts)</p>

11 Out of Band Conducted Emissions Measurement

11.1.Limit

In any 100 kHz bandwidth outside the frequency band in which the spread spectrum or digitally modulated intentional radiator is operating, the radio frequency power that is produced by the intentional radiator shall be at least 20 dB below that in the 100 kHz bandwidth within the band that contains the highest level of the desired power

11.2.Test Setup

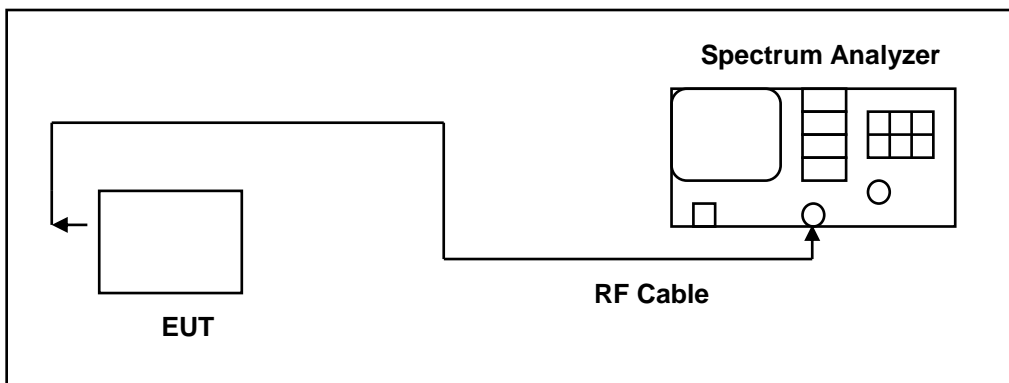

11.3.Test Instruments

Equipment	Manufacturer	Model Number	Serial Number	Cal. Date	Remark
Spectrum Analyzer	Agilent	N9020A	MY53420615	05/12/2015	(1)
Test Site	ATL	TE05	TE05	N.C.R.	-----
RF cable	WOKEN	---	C.10-07-02	10/24/2015	(1)
RF cable	WOKEN	---	C.10-07-03	10/24/2015	(1)
Temporary antenna connector	---	---	A01-224	05/24/2015	(1)

Remark: (1) Calibration period 1 year. (2) Calibration period 2 years.

NOTE: N.C.R. = No Calibration Request.

All the RF cables apply to 9 KHz to 40GHz. The temporary antenna connector is soldered on the PCB board in order to perform conducted tests and this temporary antenna connector is listed in the equipment list.

11.4.Test Procedure

In any 100 kHz bandwidth outside the EUT pass band, the RF power produced by the modulation products of the spreading sequence, the information sequence, and the carrier frequency shall be at least 20 dB below that of the maximum in-band 100 kHz emission, antenna output of the EUT was coupled directly to spectrum analyzer; if an external attenuator and/or cable was used, these losses are compensated for with the analyzer OFFSET function.

All other types of emissions from the EUT shall meet the general limits for radiated frequencies outside the pass band.

The test was performed at 3 channels.

11.5. Test Graphs

Reference level

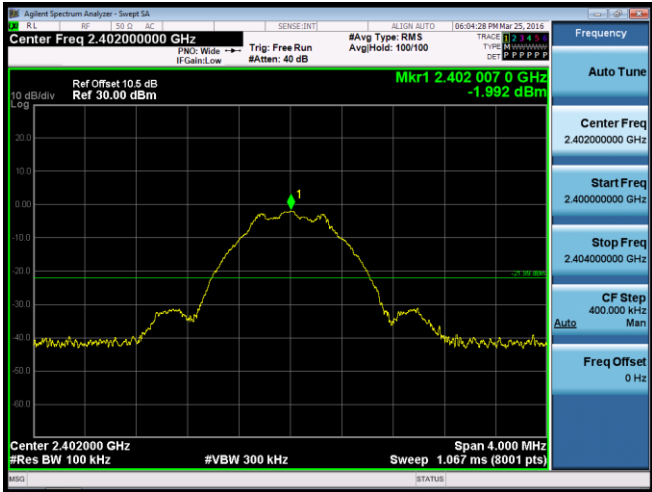
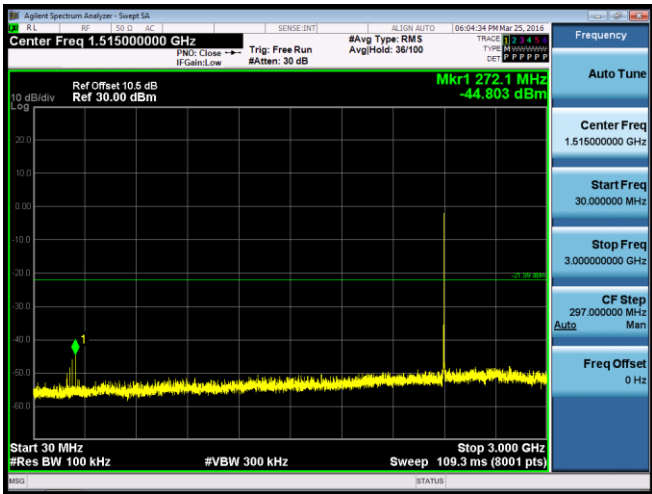
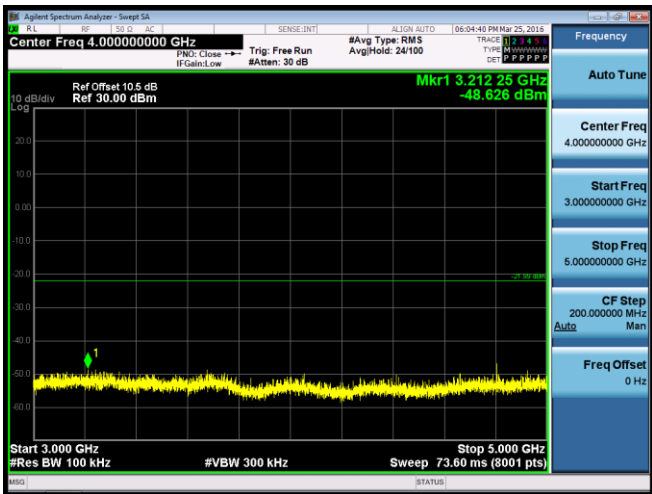
Mode 2	
2402	
	
	

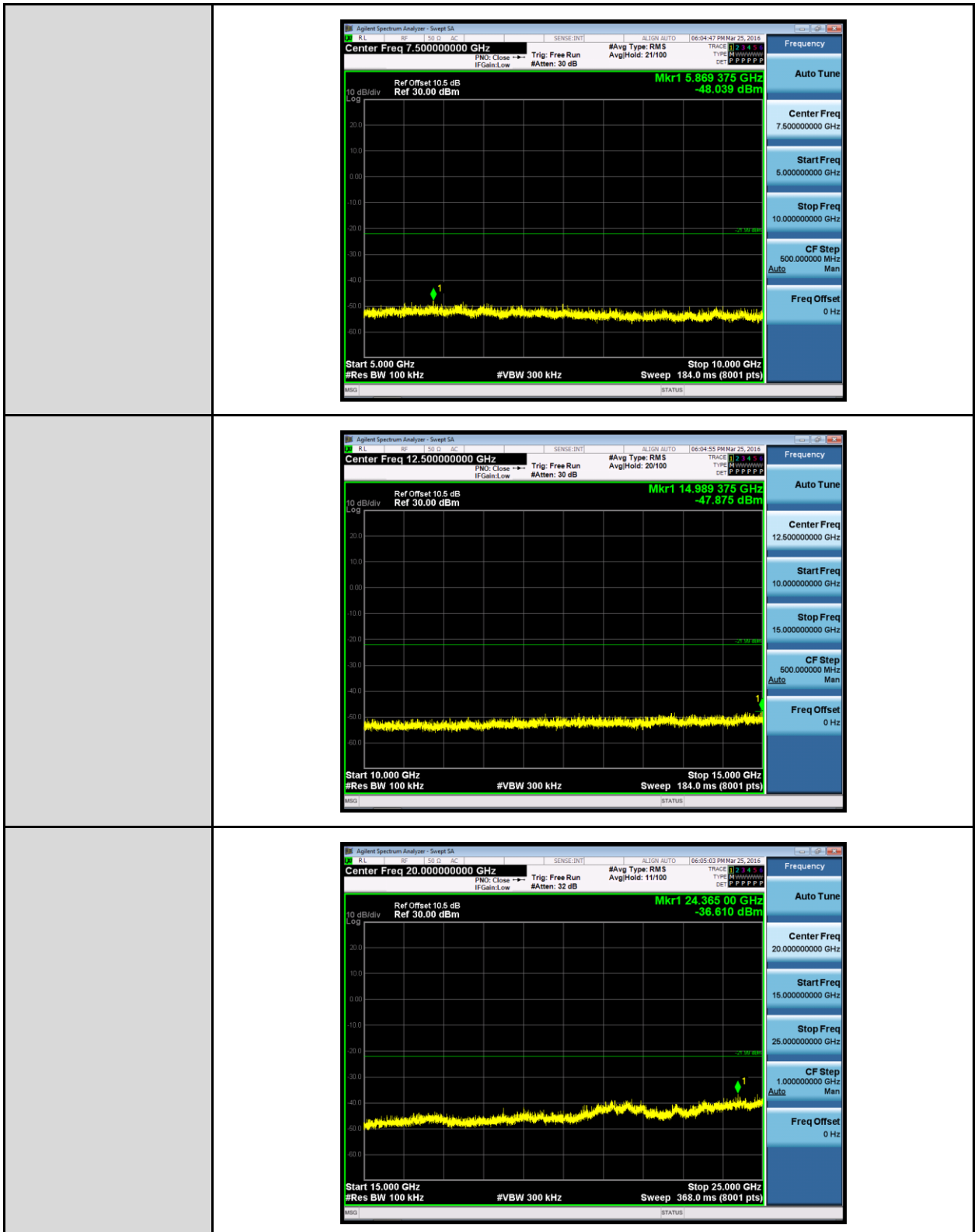

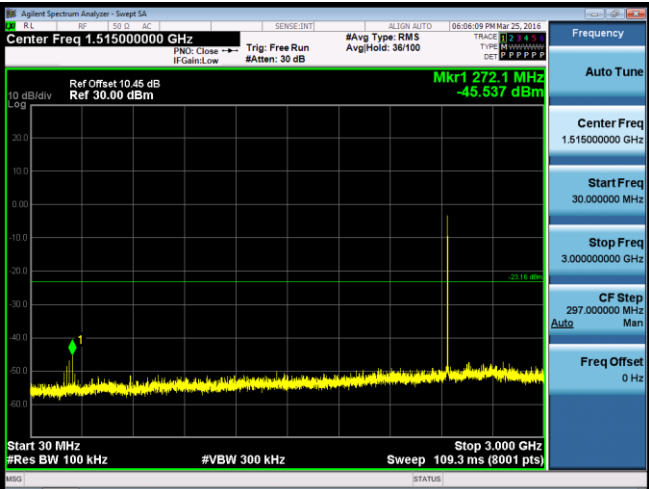
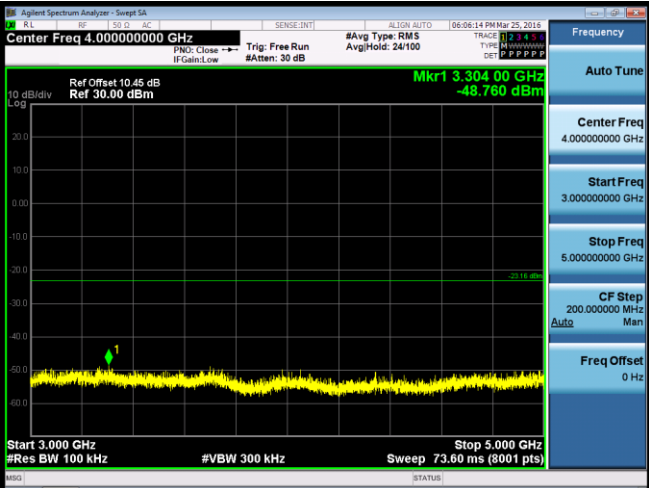
<p>2440</p>	
	
	

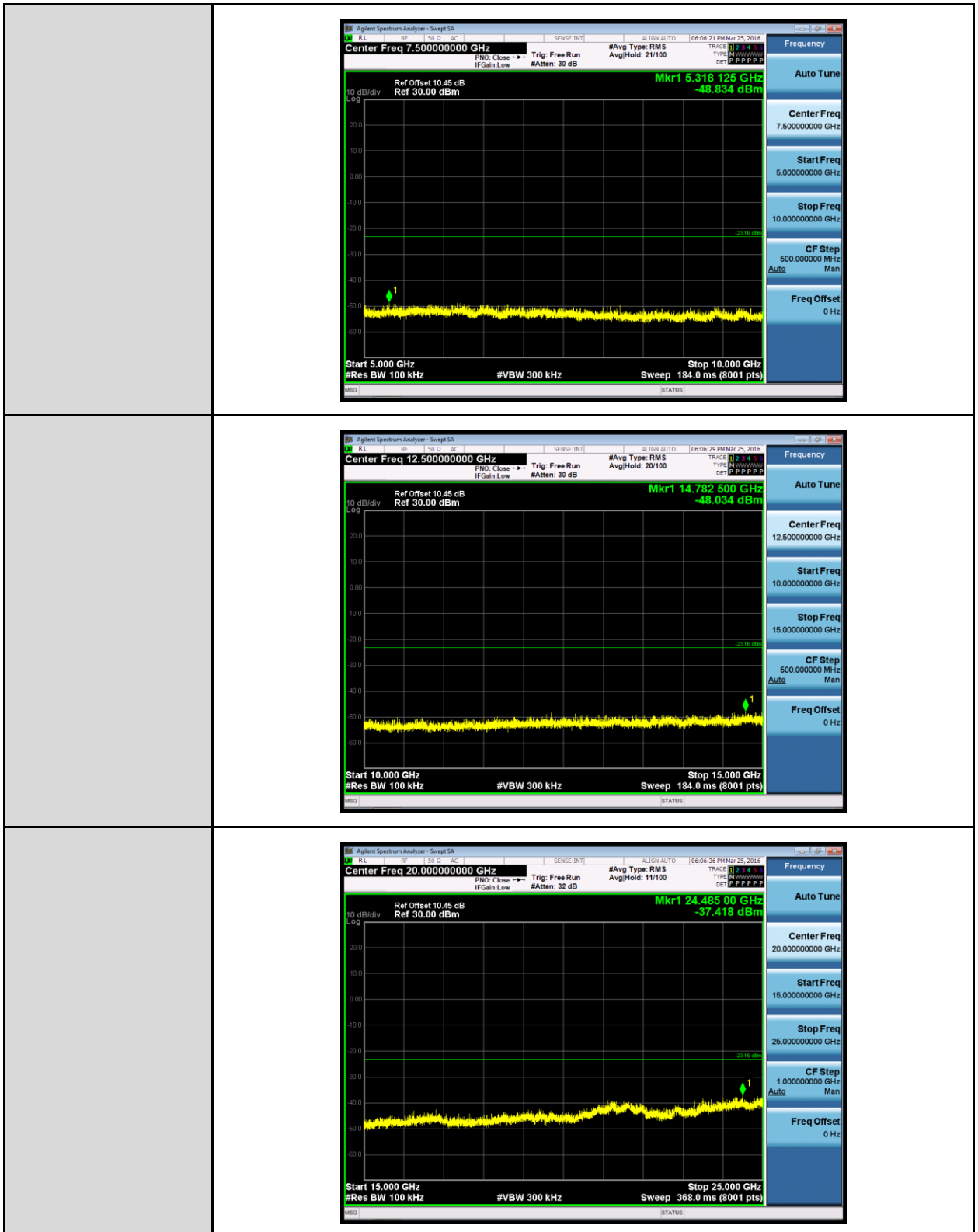

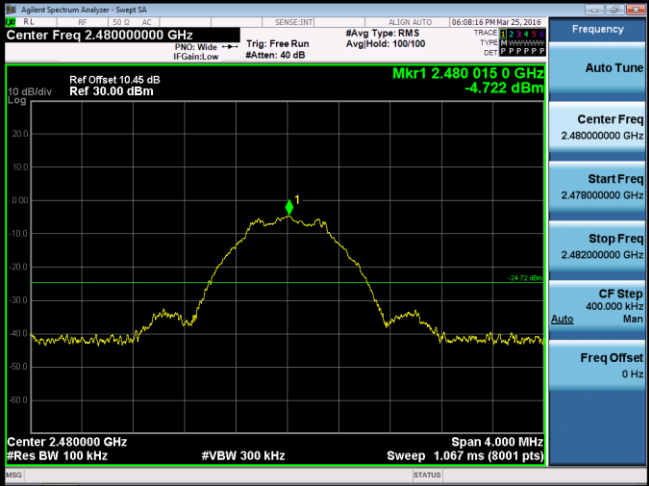
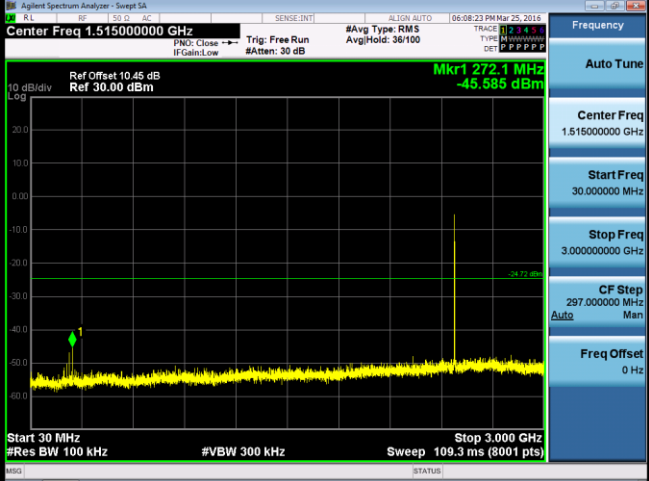
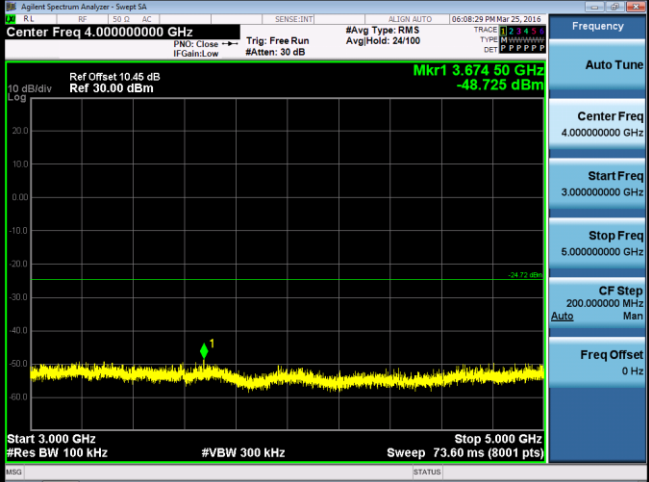
<p>2480</p>	
	
	

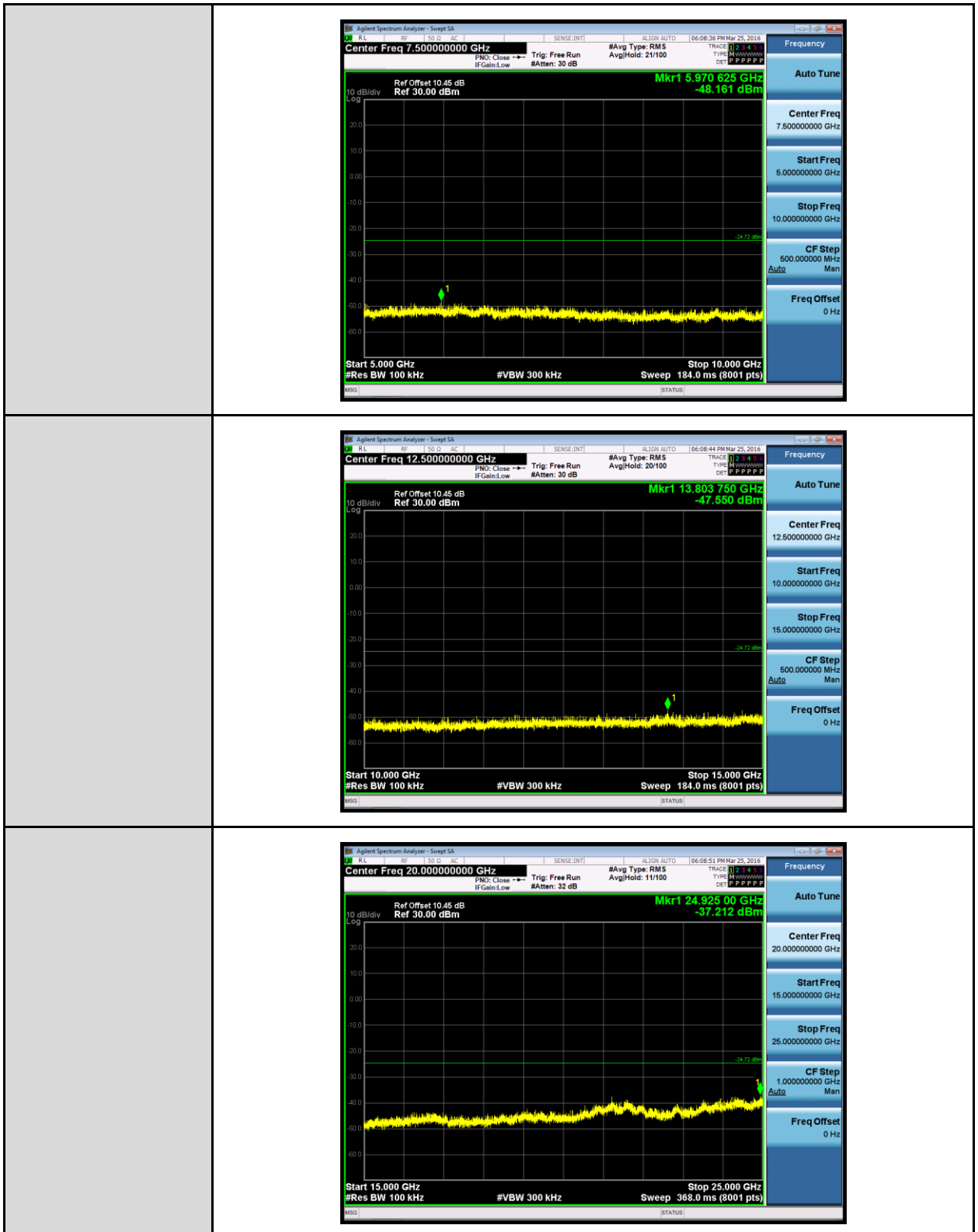

12 Band Edges Measurement

12.1.Limit

In any 100 kHz bandwidth outside the intentional radiation frequency band, the radio frequency power shall be at least 20 dB below the highest level of the radiated power. In addition, radiated emissions which fall in the restricted bands must also comply with the radiated emission limits.

12.2.Test Setup

radiated method

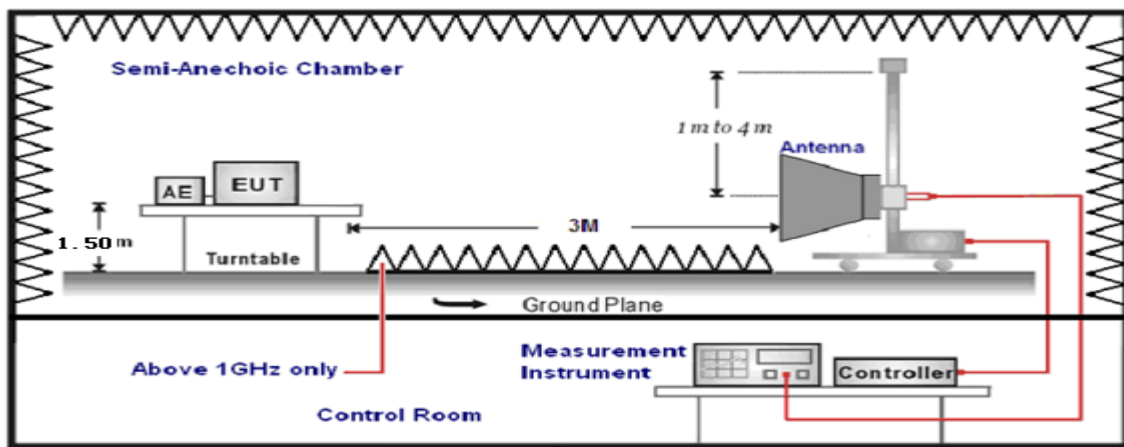

conducted method

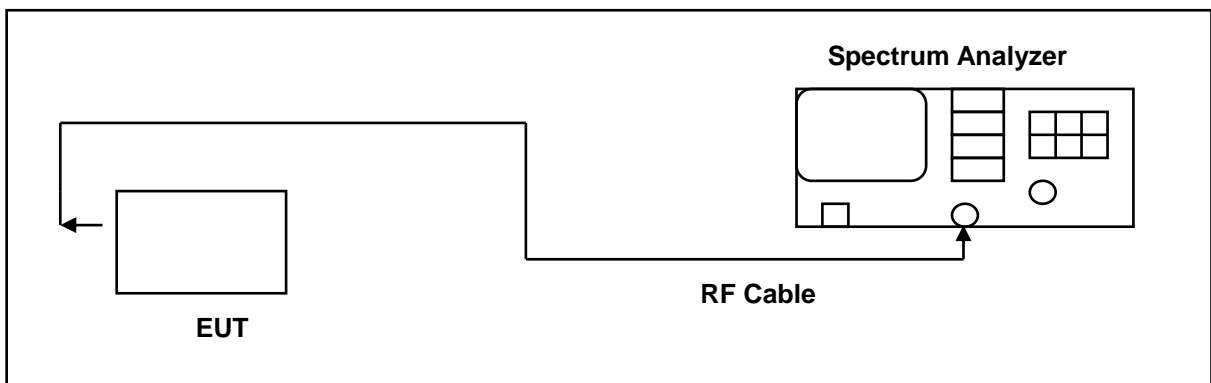

12.3. Test Instruments

3 Meter Chamber					
Model No.	Equipment	Manufacturer	Serial Number	Cal. Date	Remark
9X6X6	3m Semi-anechoic chamber	Albatross Projects	SB3450/01	Oct.12, 2015	1 year
HF907	Horn Antenna	Rohde & Schwarz	100309	May.15,2015	1 Year
SCU26	Pre Amplifier	Rohde & Schwarz	10020	May.15.2015	1 year
SCU40	Pre Amplifier	Rohde & Schwarz	10015	May.15.2015	1 year
ESU40	Test Receiver	Rohde & Schwarz	100263	May.15.2015	1 year
---	RF cable	WOKEN	S02-1404-09-065	May.11.2015	1 year
---	RF cable	WOKEN	S02-1404-09-047	May.11.2015	1 year
---	RF cable	WOKEN	S02-1404-09-052	May.11.2015	1 year

For Conducted

Equipment	Manufacturer	Model Number	Serial Number	Cal. Date	Remark
Spectrum Analyzer	Agilent	N9020A	MY53420615	05/12/2015	(1)
Test Site	ATL	TE05	TE05	N.C.R.	-----
RF cable	WOKEN	---	C.10-07-02	10/24/2015	(1)
RF cable	WOKEN	---	C.10-07-03	10/24/2015	(1)
Temporary antenna connector	---	---	A01-224	05/24/2015	(1)

Remark: (1) Calibration period 1 year. (2) Calibration period 2 years.

NOTE: N.C.R. = No Calibration Request.

All the RF cables apply to 9 KHz to 40GHz. The temporary antenna connector is soldered on the PCB board in order to perform conducted tests and this temporary antenna connector is listed in the equipment list.

12.4. Test Procedure

The EUT was setup to ANSI C63.10:2013; tested for compliance to FCC 47CFR 15.247 requirements.

The emissions on the harmonics frequencies, the limits, and the margin of compliance are presented. These tests were made when the transmitter was in full radiated power. The additional test was performed to show compliance with the requirement at the band-edge frequency 2483.5 MHz and up to 2500 MHz and at 2390.0 MHz.

The transmitter was configured with the worst case antenna and setup to transmit at the highest channel. Then the field strength was measured at 2483.5 MHz.

The transmitter was then configured with the worst case antenna and setup to transmit at the lowest channel. Then the field strength was measured at 2390.0 MHz.

For the restricted band the resolution bandwidth is set to 1 MHz, and then the video bandwidth is set to 1 MHz for peak measurements and 10 Hz for average measurements.

For the non-restricted band the resolution bandwidth is set to 100 KHz, and then the video bandwidth is set to 300 KHz for peak measurements.

12.5. Test Result

Conducted Band Edge

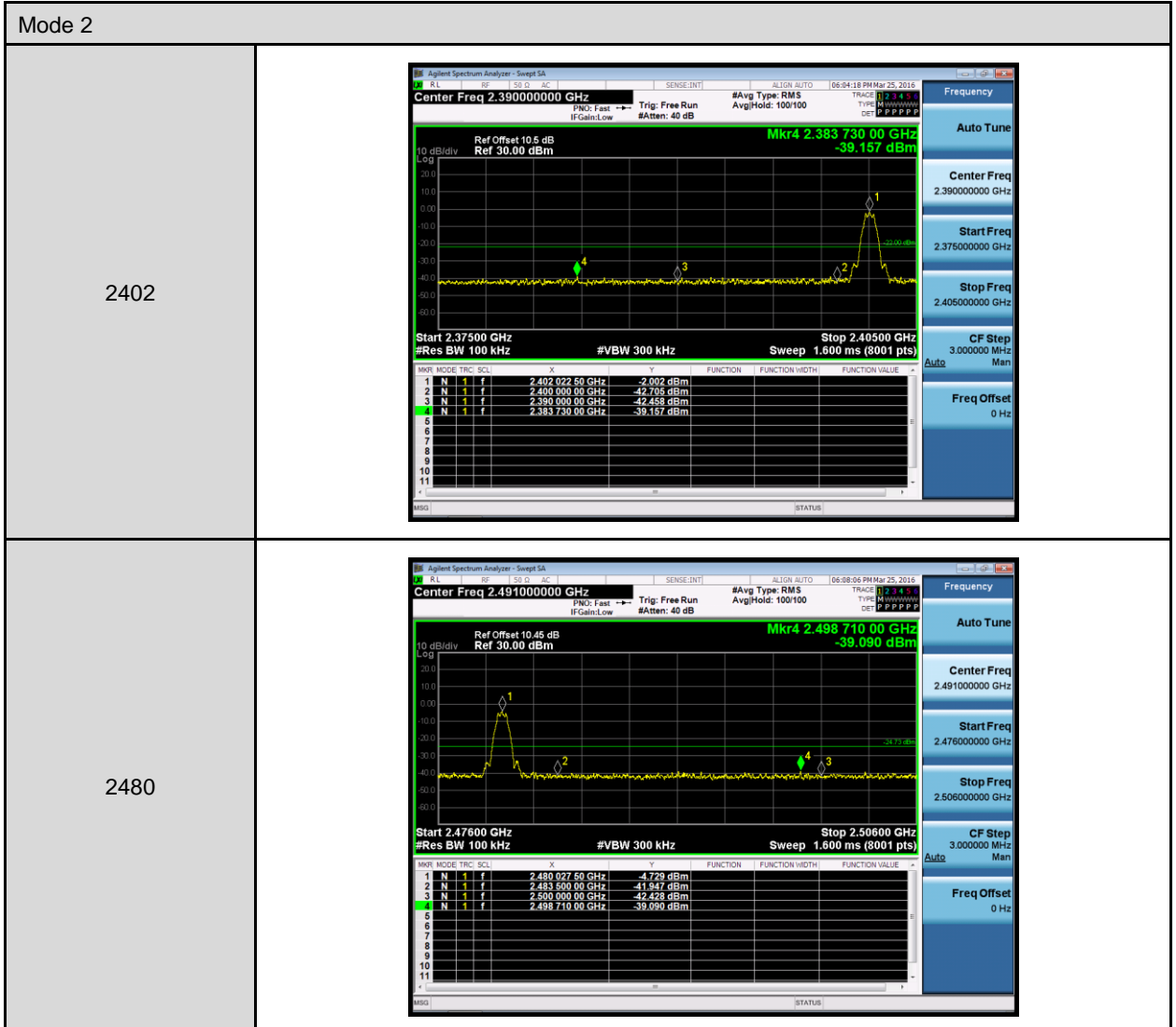

Radiated Band Edge spurious emission

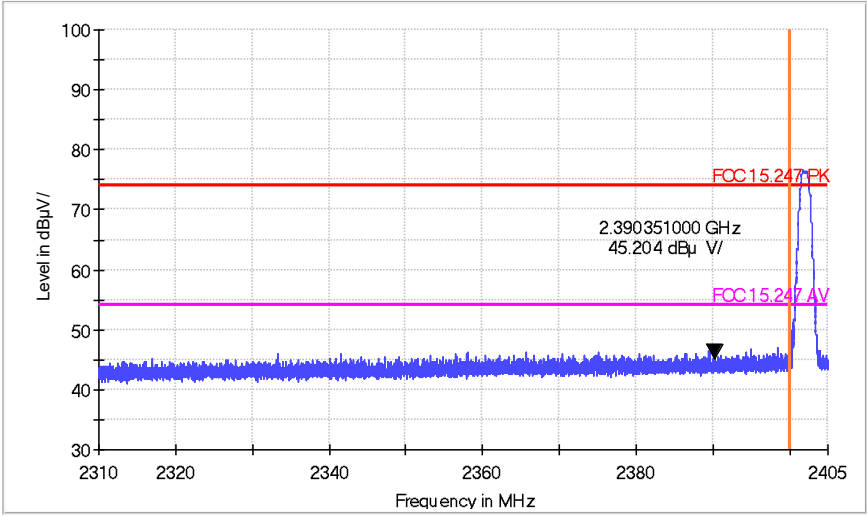
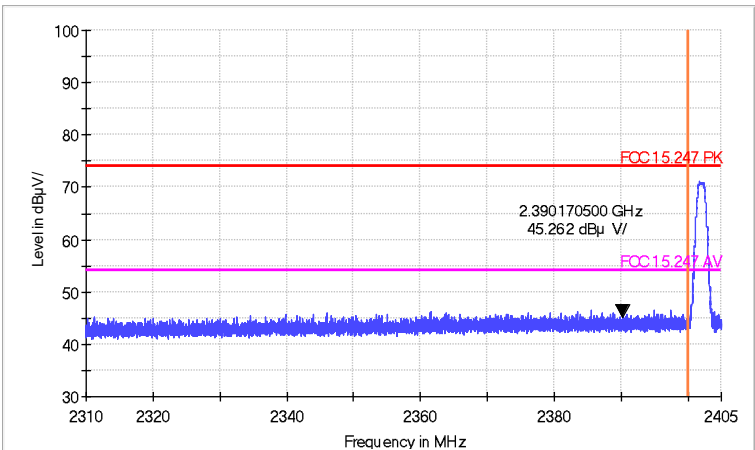
Mode 2																			
2402/H	<p style="text-align: center;">FCC Electric Field Strength 2.4GHz Bandedge-PK</p>  <p style="text-align: center;">2.390351000 GHz 45.204 dBu V/</p>																		
2402/V	<p style="text-align: center;">FCC Electric Field Strength 2.4GHz Bandedge-PK</p>  <p style="text-align: center;">2.390170500 GHz 45.262 dBu V/</p>																		
	<table border="1" style="width: 100%; border-collapse: collapse;"> <thead> <tr> <th>Frequency (MHz)</th> <th>Result (dBuV/m)</th> <th>Limit (dBuV/m)</th> <th>Margin (dB)</th> <th>Antenna</th> <th>Remark</th> </tr> </thead> <tbody> <tr> <td>2390.351</td> <td>45.20</td> <td>74.00</td> <td>28.80</td> <td>H</td> <td>Peak</td> </tr> <tr> <td>2390.171</td> <td>45.26</td> <td>74.00</td> <td>28.74</td> <td>V</td> <td>Peak</td> </tr> </tbody> </table>	Frequency (MHz)	Result (dBuV/m)	Limit (dBuV/m)	Margin (dB)	Antenna	Remark	2390.351	45.20	74.00	28.80	H	Peak	2390.171	45.26	74.00	28.74	V	Peak
Frequency (MHz)	Result (dBuV/m)	Limit (dBuV/m)	Margin (dB)	Antenna	Remark														
2390.351	45.20	74.00	28.80	H	Peak														
2390.171	45.26	74.00	28.74	V	Peak														



Mode 2

2480/H

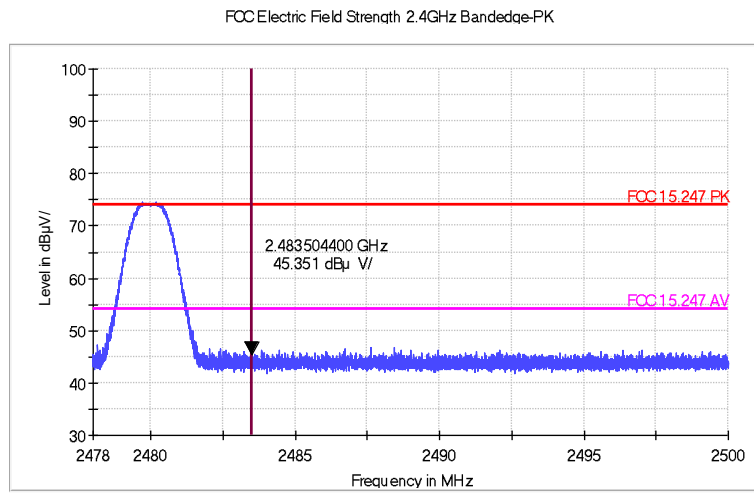

2480/V

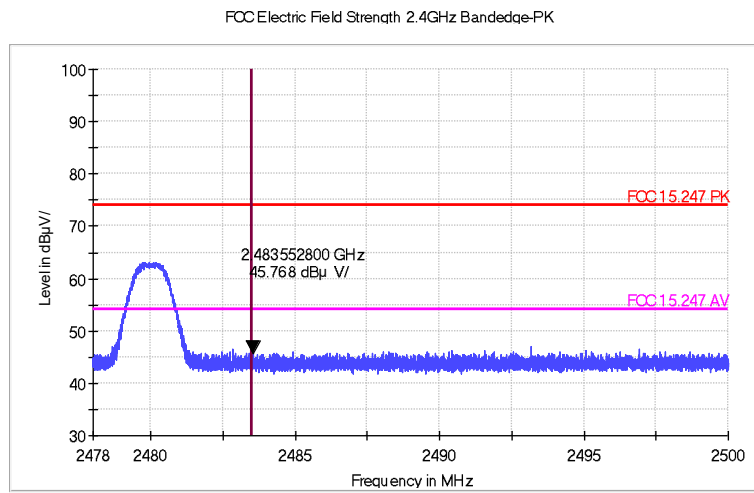

Frequency (MHz)	Result (dBuV/m)	Limit (dBuV/m)	Margin (dB)	Antenna	Remark
2483.504	45.35	74.00	28.65	H	Peak
2483.553	45.77	74.00	28.23	V	Peak



13 Antenna Requirement

13.1.Limit

For intentional device, according to 15.203, an intentional radiator shall be designed to ensure that no antenna other than that furnished by the responsible party shall be used with the device.

And According to 15.247 (b), if transmitting antennas of directional gain greater than 6 dBi are used, the power shall be reduced by the amount in dB that the directional gain of the antenna exceeds 6dBi.

13.2.Refer to statement below for compliance

The manufacturer may design the unit so that the user can replace a broken antenna, but the use of a standard antenna jack or electrical connector is prohibited. Further, this requirement does not apply to intentional radiators that must be professionally installed.

13.3.Antenna Connector Construction

The antenna used in this product is Chip Antenna. And the maximum Gain of this antenna is as below:

Bluetooth: 2.0 dBi

14 Exemption from Routine Evaluation Limits for FCC – SAR Evaluation

FCC ID: 2AGJZBW130046V1

Exposure category: General population/uncontrolled environment

EUT Type: Production Unit

Device Type: Portable Device

Refer Standard: KDB 447498 D01 General RF Exposure Guidance v06

FCC Part 2 §2.1093

Evaluation method

According to KDB447498 D01 General RF Exposure Guidance v06 Section 4.3.1 Standalone SAR test exclusion considerations: “ Unless specifically required by the published RF exposure KDB procedures, standalone 1-g head or body and 10-g extremity SAR evaluation for general population exposure conditions, by measurement or numerical simulation, is not required when the corresponding SAR Test Exclusion Threshold condition, listed below, is satisfied. These test exclusion conditions are based on source-based time-averaged maximum conducted output power of the RF channel requiring evaluation, adjusted for tune-up tolerance, and the minimum test separation distance required for the exposure conditions.²² The minimum test separation distance is determined by the smallest distance from the antenna and radiating structures or outer surface of the device, according to the host form factor, exposure conditions and platform requirements, to any part of the body or extremity of a user or bystander (see 5) of section 4.1). To qualify for SAR test exclusion, the test separation distances applied must be fully explained and justified by the operating configurations and exposure conditions of the transmitter and applicable host platform requirements, typically in the SAR measurement or SAR analysis report, according to the required published RF exposure KDB procedures. When no other RF exposure testing or reporting is required, a statement of justification and compliance must be included in the equipment approval, in lieu of the SAR report, to qualify for the SAR test exclusion. When required, the device specific conditions described in the other published RF exposure KDB procedures must be satisfied before applying these SAR test exclusion provisions; for example, handheld PTT two-way radios, handsets, laptops & tablets etc.²³ “

$$[(\text{max. power of channel, including tune-up tolerance, mW}) / (\text{min. test separation distance, mm})] \cdot [\sqrt{f} \text{ (GHz)}] \leq 3.0$$
 for 1-g SAR and ≤ 7.5 for 10-g extremity SAR, where:

- f (GHz) is the RF channel transmit frequency in GHz
- Power and distance are rounded to the nearest mW and mm before calculation
- The result is rounded to one decimal place for comparison
- 3.0 and 7.5 are referred to as the numeric thresholds in the step 2 below

The test exclusions are applicable only when the minimum test separation distance is ≤ 50 mm and for transmission frequencies between 100 MHz and 6 GHz. When the minimum test separation distance is < 5 mm, a distance of 5 mm according to 5) in section 4.1 is applied to determine SAR test exclusion.

Conducted Power Results
Bluetooth

Mode	Channel	Frequency (MHz)	Peak Conducted Output Power (dBm)
GFSK-BLE	00	2402	-1.411
	19	2440	-2.502
	39	2480	-3.933

Manufacturing tolerance
Bluetooth

GFSK-BLE (Peak)			
Channel	Channel 00	Channel 19	Channel 39
Target (dBm)	-1.411	-2.502	-3.933
Tolerance \pm (dB)	1.0	1.0	1.0

Evaluation Results

Band/Mode	f (GHz)	Antenna Distance (mm)	RF output power (including tune-up tolerance)		SAR Test Exclusion Threshold	SAR Test Exclusion
			dBm	mW		
BT*	2.402	5	-0.411	0.91	0.28<3.0	Yes

BT*-BT including BLE (lower power BT)

Conclusion

The measurement results comply with the FCC Limit per 47 CFR 2.1093 for the uncontrolled RF Exposure and SAR Exclusion Threshold per KDB 447498 v06.

.....**End of Report**.....