

AUTOMATE™ C 1.2

MTACRFDR-50KG - ARC DRAPERY MOTOR



**433 MHZ
BI-DIRECTIONAL**



**ELECTRONIC
LIMIT**



**FAVORITE
POSITION**



**LEVEL
CONTROL**



SOFT TOUCH



**QUIET
OPERATION**

AUTOMATE™ | ARC™ drapery motor is compatible with popular drapery track systems for easy incorporation of draperies into the ARC motorized platform. The Soft Touch feature enables manual operation when needed.

Leveling Control allows for precise positioning of individual or multiple drapes ensuring perfect alignment every time.

Additionally, a favorite position can be pre-set and recalled at any time.

FEATURES:

- Electronic Torque sensing "Autoset" Limits
- 433 MHz Bi-Directional RF Communication
- Leveling Control
- Favorite Position
- Soft start / stop
- Soft touch control
- Top exit option for power cord

CONTENTS

1	ASSEMBLY	5
2	P1 BUTTON FUNCTIONS	6
2.1	Motor State Test	6
2.2	Motor Configuration Options	6
3	INITIAL SET-UP	7
3.1	Pair motor with controller	7
3.2	Check motor direction	7
3.3	Set limits	8
4	ADJUSTING LIMITS	9
4.1	Adjust upper/open limit	9
4.2	Adjust lower/close limit	9
5	ADDING OR REMOVING CONTROLLERS AND CHANNELS	10
5.1	Using motor P1 button	10
5.2	Using a pre-existing controller	10
6	FAVORITE POSITIONING	11
6.1	Set a favorite position	11
6.2	Send shade to favorite position	11
6.3	Delete favorite position	12
7	ADJUSTING MOTOR SPEED	12
7.1	Increase or decrease motor speed	12
8	SLEEP MODE	13
8.1	Enter sleep mode	13
8.2	Exit sleep mode	13
9	TROUBLESHOOTING	14

SAFETY INSTRUCTIONS

WARNING: Important safety instructions to be read before installation.

Incorrect installation can lead to serious injury and will void manufacturer's liability and warranty.

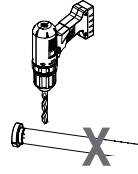
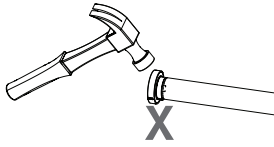

CAUTION

- Do not expose to moisture or extreme temperatures.
- Do not allow children to play with this device.
- Use or modification outside the scope of this instruction manual will void warranty.
- Installation and programming to be performed by a suitably qualified installer.
- For use within tubular blinds.
- Ensure correct crown and drive adaptors are used for the intended system.
- Keep antenna straight and clear from metal objects
- Do not cut the antenna.
- Use only Rollease Acmeda hardware.
- Before installation, remove any unnecessary cords and disable any equipment not needed for powered operation.
- Ensure torque and operating time is compatible with end application.
- Do not expose the motor to water or install in humid or damp environments.
- Motor is to be installed in horizontal application only.
- Do not drill into motor body.
- The routing of cable through walls shall be protected by isolating bushes or grommets.
- Ensure power cable and aerial is clear and protected from moving parts.
- If cable or power connector is damaged do not use.

Important safety instructions to be read prior to operation.

- It is important for the safety of persons to follow the enclosed instructions. Save these instructions for future reference.
- Persons (including children) with reduced physical, sensory or mental capabilities, or lack of experience and knowledge should not be allowed to use this product.
- Keep remote controls away from children.
- Frequently inspect for improper operation. Do not use if repair or adjustment is necessary.
- Keep motor away from acid and alkali.
- Do not force the motor drive.
- Keep clear when in operation.



Do not dispose of in general waste.



1 ASSEMBLY

The Automate ARC Drapery motor works with most major drapery track systems. Follow the below instructions to simply retrofit with the Drive Pulley* to an existing track *Drive Pulley Available Separately

NOTE: DISASSEMBLE EXISTING DRAPERY TRACK PRIOR TO FOLLOWING ASSEMBLY STEPS

STEP 1

Install drapery drive belt into new drive housing & assemble drive housing components.

It is recommended that both pulleys be replaced to allow for installation of motor on either end.

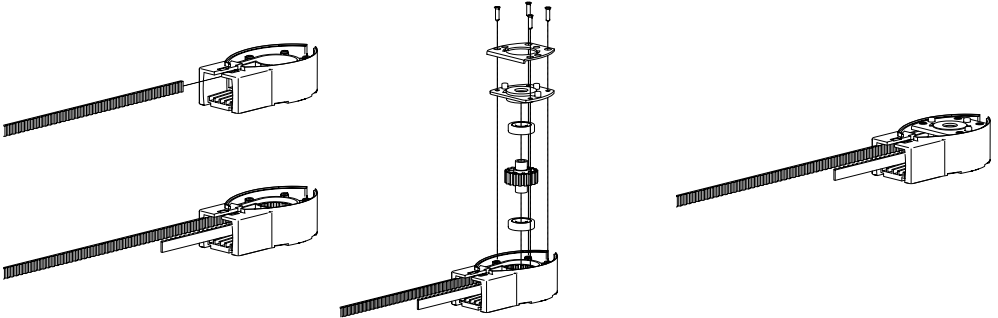

STEP 2:

Assemble drive belt attachments and attach drive housing to track.

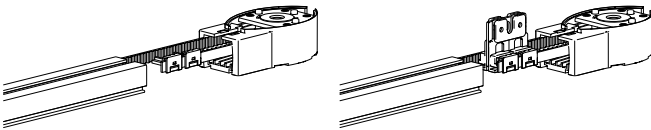

Repeat steps 1-2 for Idler Side

STEP 3:

Assemble Brackets, Runners, Stoppers & Idler Drive Unit Cover.

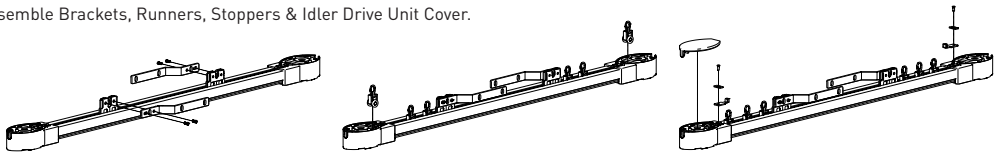

STEP 4:

Assemble Drapery Motor to drive housing.

Ensure Fixing Pin is engaged securely and motor is secured to housing.

STEP 5:

Plug motor into wall receptacle

NOTE: Motor power cable may be shortened and/or routed through the motor body to exit the top of the track. This requires using a field installed plug to replace the motor grounding plug.

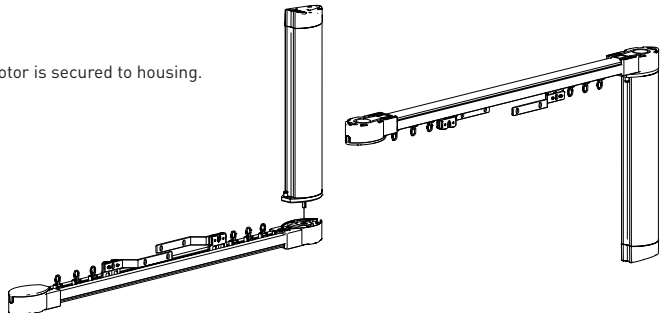

2 P1 BUTTON FUNCTIONS

2.1 Motor State Test

This table describes the function of a short **P1** button press/release (<2 seconds) depending on current motor configuration.

P1 Press	Condition	Function Achieved	Visual Feedback	Audible Feedback	Function Described
Short Press then Release (<2 sec)	If limit is NOT set	None	No Action	None	No Action
	If limits are set	Operational control of motor, run to limit. Stop if running	Motor runs	None	Operational control of motor after pairing and limit setting is completed first time
	If motor is in "Sleep Mode" & limits are set (Refer to Sec.10)	Wake and control	Motor wakes and runs in a direction	None	Motor is restored from Sleep mode and RF control is active

2.2 Motor Configuration Options

The **P1** Button is utilized to administer motor configuration as described below and beginning in Section 4.

Activate Pairing Mode

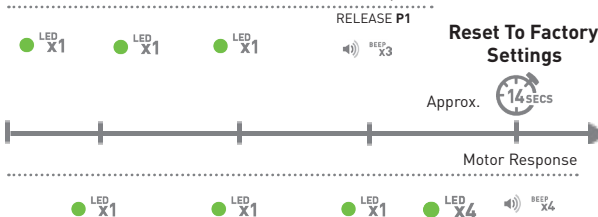
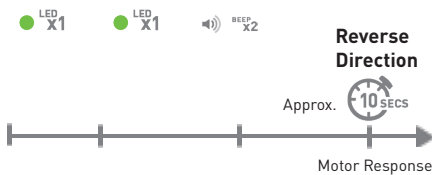
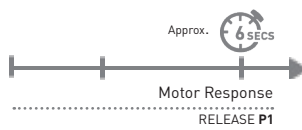
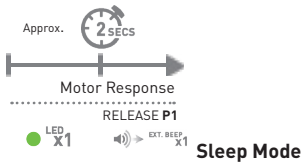

Hold P1

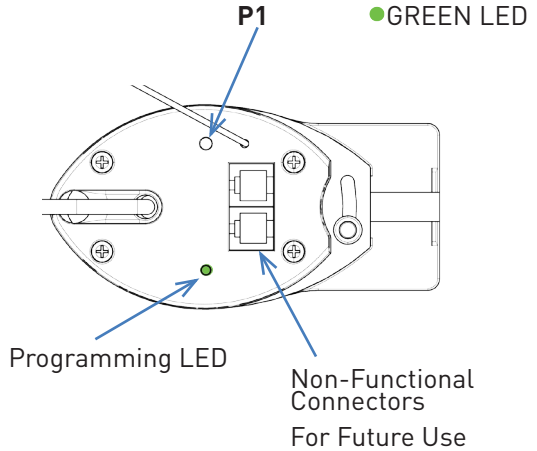

3 INITIAL SET-UP

3.1 Pair motor with controller

Select channel on controller.

(Disregard if using single channel controller)



Hold **P1** button on motor

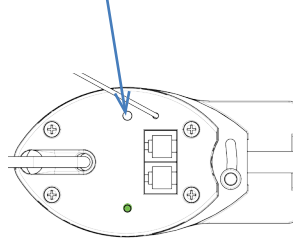

Hold **STOP** on controller



IMPORTANT

Motor Response

LED **x1** RELEASE **P1**



Consult user manual for your controller for information on selecting channel.

Motor Response

Approx. BEEP **x3**



Motor is now in setup mode and ready for setting limits.

3.2 Check motor direction

For correct operation **UP** should open Drapery and **DOWN** should close.

To check travel direction of shade, press **UP** or **DOWN** on controller.

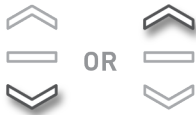

Quick Press = Step

Long Press = Continuous Travel

To reverse shade direction, hold both **UP** and **DOWN** until motor responds



Motor Response



Reversing motor direction using this method is only possible during initial set-up, prior to first time limit setting, or after a re-set of motor

3.3 Set limits

The AUTOMATE drapery motor features automatic limit detection. Once the motor is attached to a fabricated, installed track, limits can be set with a few simple actions.

Press the **UP** or **DOWN** buttons on controller.
Carrier will run to the end of the track.

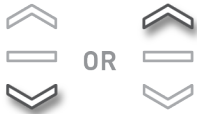

When carrier has reached the end of the track, it will automatically set limit there.
Repeat for opposite end.



IMPORTANT

To verify limits were successfully set, press up or down to run to limit. Motor should now function with slow start/slow stop feature.



Initial set-up is now complete

4 ADJUSTING LIMITS

4.1 Adjust upper/open limit

Press & hold **UP/OPEN** and **STOP** on Controller until the motor responds.

Move shade to the desired upper position by pressing the **UP/OPEN** or **DOWN** button.

To save upper limit, hold **UP/OPEN** and **STOP** until the motor responds.

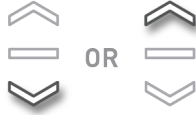

Motor Response



Motor Response



4.2 Adjust lower/close limit

Hold **DOWN/CLOSE** and **STOP** on controller.

Move shade to the desired lowest position by pressing the **UP** or **DOWN/CLOSE** button

To save lower limit, hold **DOWN/CLOSE** and **STOP**.



Motor Response



Motor Response



5 ADDING OR REMOVING CONTROLLERS AND CHANNELS

5.1 Using motor P1 button

Hold **P1** button on motor head.

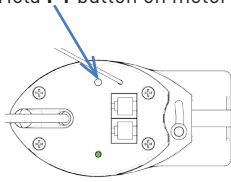

Hold **STOP** on controller to add or remove



Motor Response

LED X1 RELEASE P1

EXT. BEEP X1

Motor Response

BEEP X3

Approx. 2 SECS

LED X5

5.2 Using a pre-existing controller

A= Existing controller or channel (to keep)

B= Controller or channel to add or remove

Press **P2** on existing controller.



Motor Response

BEEP X1

LED X1

Press **P2** on existing controller.



Motor Response

BEEP X1

LED X1

Press **P2** on new controller.



Motor Response

BEEP X3

LED X5



IMPORTANT

Consult user manual for your controller or sensor.

6 FAVORITE POSITIONING

6.1 Set a favorite position

Move shade to the desired position by pressing the **UP** or **DOWN** button on the controller.

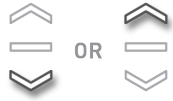

Press **P2** on controller.



Press **STOP** on controller.



Press **STOP** controller.



Motor Response



Motor Response



Motor Response



6.2 Send shade to favorite position

Hold **STOP** on controller until motor begins moving, then release.



Approx.  2 SECS

6.3 Delete favorite position

Press **P2** on controller.



Press **STOP** on controller.



Press **STOP** on controller.



Motor Response



Motor Response



Motor Response



7 ADJUSTING MOTOR SPEED

7.1 Increase or decrease motor speed

Press **P2** on controller.



To increase speed.

Press **UP**



Press **UP**



Motor Response



To decrease speed.

Press **DOWN**



Press **DOWN**



Motor Response



Motor Response



IMPORTANT

If motor does not react to speed adjustment, the maximum or minimum speed has already been reached.

8 SLEEP MODE

8.1 Enter sleep mode

Sleep mode is used to disable the Radio in the motor, thus it will not react to radio commands when this mode is activated. This feature is useful for administering motor programming functions when the motor is paired to the same channel as other motors.

Hold **P1** button on motor head.

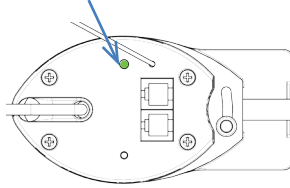

Motor Response

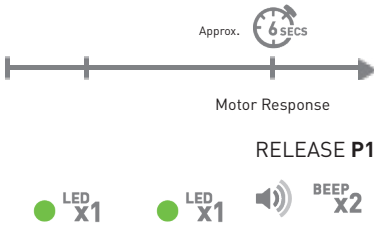

8.2 Exit sleep mode

Exit sleep mode once installation is complete.

- TUG on Drape master carrier to activate the motor
- PRESS & RELEASE **P1** button on motor head.

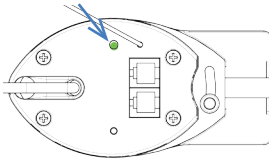

Motor Response

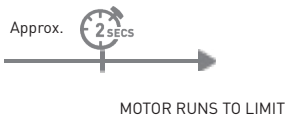

Problem	Cause	Remedy
Motor is not responding	A / C power supply not plugged in.	Check motor to power cable connection and AC plug.
	Transmitter battery is discharged	Replace battery
	Battery is inserted incorrectly into transmitter	Check battery polarity
	Radio interference/shielding	Ensure transmitter is positioned away from metal objects and the aerial on motor or receiver is kept straight and away from metal
	Receiver distance is too far from transmitter	Move transmitter to a closer position
	Power failure	Check power supply to motor is connected and active
	Incorrect wiring	Check that wiring is connected correctly (refer to motor installation instructions)
Cannot program a single Motor (multiple motors respond)	Multiple motors are paired to the same channel.	Always reserve an individual channel for programming functions
		SYSTEM BEST PRACTICE - Provide an extra 15 channel remote in your multi motor projects, that provides individual control for each motor for programming purposes
		Place all other motors into sleep mode (ref to P1 function overview - section 2.2 and section 8)

This device complies with Part 15 of the FCC Rules / Industry Canada licence-exempt RSS standard(s). Operation is subject to the following two conditions: (1) this device may not cause harmful interference, and (2) this device must accept any interference received, including interference that may cause undesired operation.

Le présent appareil est conforme aux CNR d'Industrie Canada applicables aux appareils radio exempts de licence. L'exploitation est autorisée aux deux conditions suivantes : (1) l'appareil ne doit pas produire de brouillage, et (2) l'utilisateur de l'appareil doit accepter tout brouillage radioélectrique subi, même si le brouillage est susceptible d'en compromettre le fonctionnement.

Changes or modifications not expressly approved by the party responsible for compliance could void the user's authority to operate the equipment.

This equipment has been tested and found to comply with the limits for a Class B digital device, pursuant to part 15 of the FCC Rules. These limits are designed to provide reasonable protection against harmful interference in a residential installation. This equipment generates uses and can radiate radio frequency energy and, if not installed and used in accordance with the instructions, may cause harmful interference to radio communications. However, there is no guarantee that interference will not occur in a particular installation. If this equipment does cause harmful interference to radio or television reception, which can be determined by turning the equipment off and on, the user is encouraged to try to correct the interference by one or more of the following measures:

- Reorient or relocate the receiving antenna.
- Increase the separation between the equipment and receiver.
- Connect the equipment into an outlet on a circuit different from that to which the receiver is connected.
- Consult the dealer or an experienced radio/TV technician for help.

ROLLEASE ACMEDA

AUSTRALIA

110 Northcorp Boulevard,
Broadmeadows VIC 3047

T +61 3 9355 0100 | F +61 3 9355 0110

Queensland Branch
Unit 2/62 Borthwick Avenue,
Murarrie QLD 4172

ROLLEASE ACMEDA

USA

200 Harvard Avenue
Stamford, CT 06902 6320

T +1 203 964 1573 | F +1 203 964 0513

ROLLEASE ACMEDA

EUROPE

Via Conca Del Naviglio 18, Milan
(Lombardia) Italy

T +39 02 8982 7317 | F +39 02 8982 7317

info@rolleaseacmeda.com

rolleaseacmeda.com