

AUTOMATE™

Solar Powered Wind & Light Sensor



AUTOMATE™ | Wind-Light sensor is a device for measuring wind speed and light intensity. The information is transmitted to ARC outdoor motorized shades that will move to their top or bottom limits.

FEATURES:

- Measure wind speed as an anemometer
- Measure light intensity as a Lux meter
- LCD display
- ARC compatibility
- Micro-B USB Charging Port
- Solar Charge Panel
- Built-in Lithium Ion battery
- Water proof

SAFETY INSTRUCTIONS

WARNING: Important safety instructions to be read before installation and use.

Incorrect installation or use can lead to serious injury and will void manufacturer's liability and warranty.

It is important for the safety of persons to follow the enclosed instructions. Save these instructions for future reference.

- Do not submerge in water or expose to extreme temperatures.
- Persons (including children) with reduced physical, sensory or mental capabilities, or lack of experience and knowledge should not be allowed to use this product.
- Use or modification outside the scope of this instruction manual will void warranty.
- Installation and programming to be performed by a suitably qualified installer.
- Follow installation instructions.
- For use with motorized shading devices.
- Keep away from children.
- Frequently inspect for improper operation. Do not use if repair or adjustment is necessary.
- Keep clear when in operation.
- Replace battery with correctly specified type.

Rollease Acmeda declares this equipment is in compliance with the essential requirements and other relevant provisions of R&TTE Directive 2014/53/EU

Statement Regarding FCC Compliance

This device complies with Part 15 of the FCC Rules / Innovation, Science and Economic Development Canada's licence-exempt RSS(s). Operation is subject to the following two conditions:

(1) This device may not cause harmful interference, and (2) This device must accept any interference received, including interference that may cause undesired operation.

L'émetteur/récepteur exempt de licence contenu dans le présent appareil est conforme aux CNR d'Innovation, Sciences et Développement économique Canada applicables aux appareils radio exempts de licence. L'exploitation est autorisée aux deux conditions suivantes :

1. L'appareil ne doit pas produire de brouillage; 2. L'appareil doit accepter tout brouillage radioélectrique subi, même si le brouillage est susceptible d'en compromettre le fonctionnement.

Changes or modifications not expressly approved by the party responsible for compliance could void the user's authority to operate the equipment.

Note: This equipment has been tested and found to comply with the limits for a Class B digital device, pursuant to Part 15 of the FCC Rules. These limits are designed to provide reasonable protection against harmful interference in a residential installation. This equipment generates, uses and can radiate radio frequency energy and, if not installed and used in accordance with the instructions, may cause harmful interference to radio communications.

However, there is no guarantee that interference will not occur in a particular installation. If this equipment does cause harmful interference to radio or television reception, which can be determined by turning the equipment off and on, the user is encouraged to try to correct the interference by one or more of the following measures:

- Reorient or relocate the receiving antenna.
- Increase the separation between the equipment and receiver.
- Connect the equipment into an outlet on a circuit different from that to which the receiver is connected.
- Consult the dealer or an experienced radio/TV technician for help.

Any changes or modifications not expressly approved by the party responsible for compliance could void the user's authority to operate the equipment.



Do not dispose of in general waste.
Please recycle batteries and damaged electrical products appropriately.



TECHNICAL DATA / KIT CONTENTS

Technical Specifications

Wind speed range	0-180 km/h [0-112mph]
Light intensity range	0-100 kLux
Frequency	433.92 MHz
Modulation	FSK
Transmitting power	<8dBm
Transmission distance	35 meters indoors, 200 meters open space
	115 ft indoors, 656 ft in open space
Ambient operating temperature	-20 °C - +60 °C
	-4 °F - +140 °F
Battery capacity	220 mAh
Charging current	67 mA by solar energy; 250 mA by USB
Standby electric current consumption	10 uA
Ingress protection	IP54

KIT COMPONENTS

Pack Contents:

- 1 x Wind-Light sensor
- 2 x Screws
- 2 x Screw Wall Plug

Compatible Motors

- MT01-1145-050001 - AUTOMATE | ARC FT Motor [AU]
- MT01-1145-069002 - AUTOMATE | ARC FT SLIM Motor Quiet [US]
- MT01-1145-069003 - AUTOMATE | ARC FT SLIM Motor [US]
- MT01-1145-069004 - AUTOMATE | ARC FT SLIM Motor Quiet - 20' Cord [US]

CONTENTS

1	INSTALLATION	5
2	FUNCTIONAL OVERVIEW	6
2.1	Components	6
2.2	LCD Display	9
2.3	Measure wind speed & light intensity	10
2.4	Display the pre-set threshold value	10
2.5	Change the threshold value	11
2.6	Pair or unpair the sensor to a motor using a pre-paired remote	11
3	WIND & LIGHT CONTROL	13
3.1	Disable or enable the detection of wind and light	13
3.2	Wind speed control	13
3.3	Light control	14
4	TROUBLE SHOOTING	15

1 INSTALLATION

1. Find an appropriate location outdoors
2. Remove the base covers
3. The solar panel must be face up and in direct sunlight
4. Fix the sensor to a suitable surface
5. Re-attach the base covers
6. Ensure the three rotating cups are in an approximately horizontal position

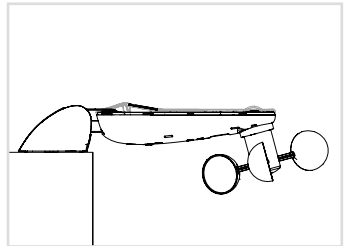
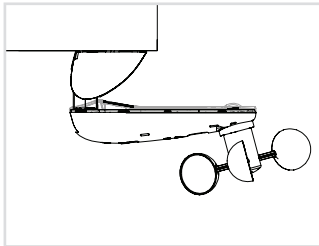
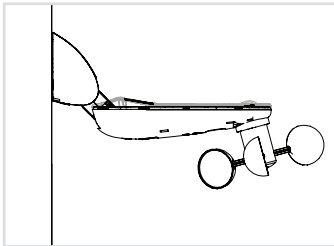
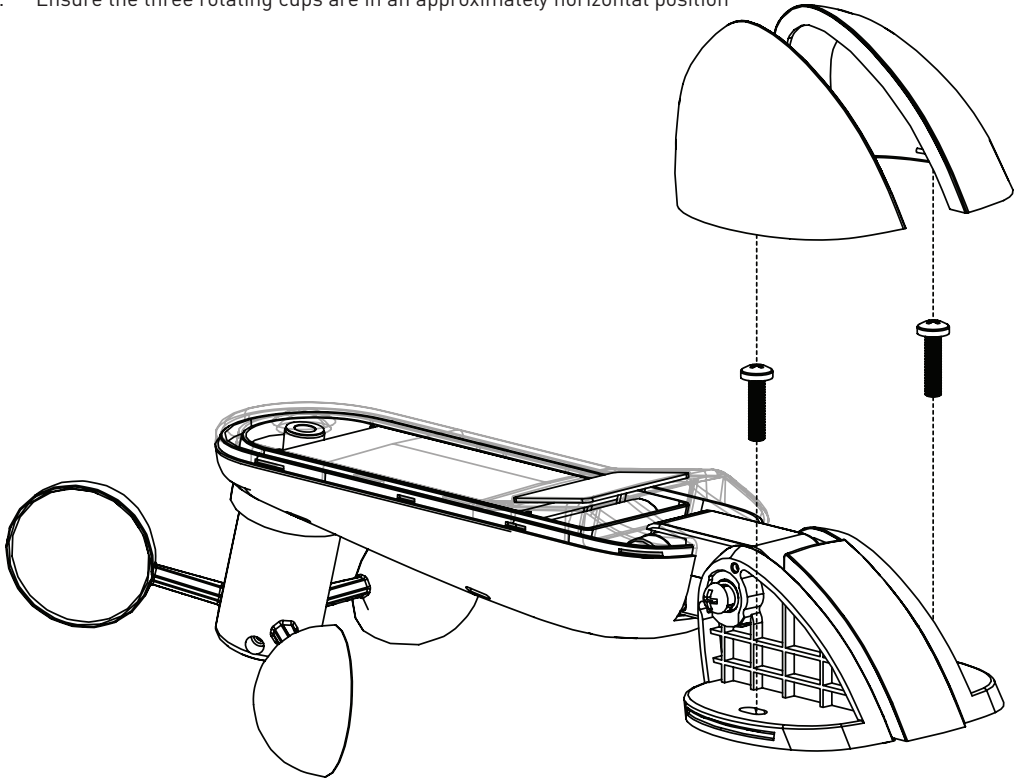

2 FUNCTIONAL OVERVIEW

2.1 Components

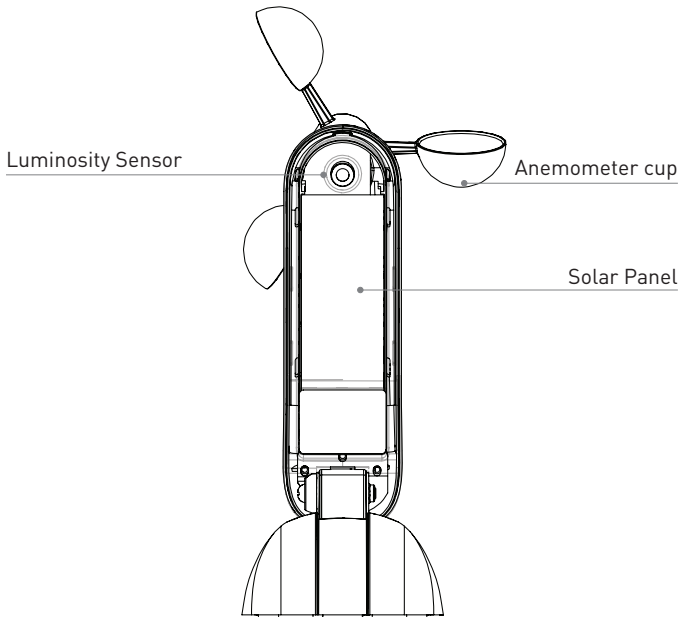
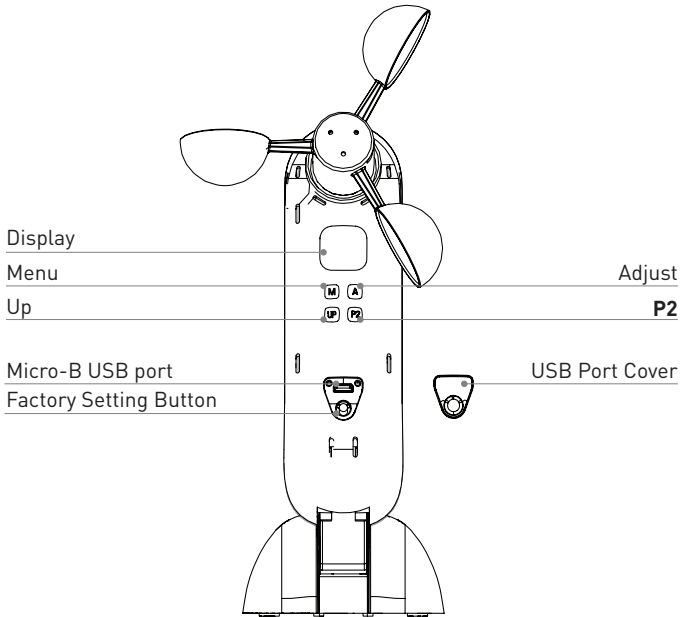

NOTES:

1. Anemometer cups: mounted at one end of the three horizontal arms at equal angles to each other on a vertical shaft. The air flow past the cups in any horizontal direction turns the cups in a manner that is proportional to the wind speed. The wind speed is measured in real-time by counting the turns of the cups over a set time period.
2. Luminosity Sensor: luminance in Lux is measured by a photo-diode and digitized using an empirical formula to approximate the human eye response. The ambient light intensity is measured once every 16 seconds.
3. Solar Panel: convert the sun light energy into electric energy to charge the internal battery.
4. Menu button: loop displays or change the the threshold of wind speed and light intensity.
5. Adjust button:
 - Loop displays of the values of wind speed and light intensity.
 - Press the Adjust key to subtract 1 from the present threshold value in its adjust mode.
 - Press and hold Adjust key to continuously decrease the threshold value in its adjust mode.
6. **UP** Button:
 - Trigger the paired motor to move upward.
 - Press the **UP** button to add 1 to the present threshold value in its adjust mode.
 - Press and hold the **UP** button to continuously increase the threshold value in its adjust mode.
7. **P2** button: used to pair the sensor to a motor.
8. Factory Setting button:
 - Reset the sensor to the factory default setting: Holding down the Menu button and pressing the Factory Reset Button makes the sensor enter the low power factory setting. After the LCD becomes blank, the factory default values have been reloaded to the memory as the pre-set threshold values. Pressing the Factory Setting Button and releasing again returns the sensor to the normal status.
 - Default Factory Settings: Light alarm value is 10kLux, wind speed value is 10km/h [6mph].
 - Display all symbols on the LCD display.

2.1 COMPONENTS CONTINUED

- Can be used to charge the internal battery.
- The Micro-B port should always be covered during the outdoor usage to maintain a waterproof seal.

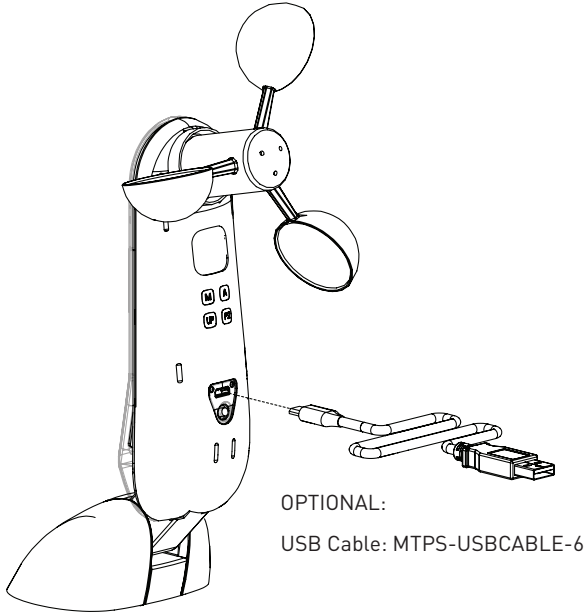

2.2 LCD Display

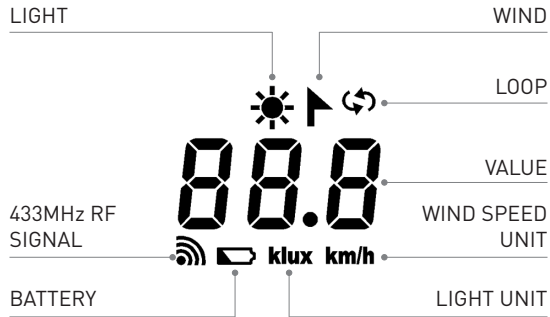

1. While the power is on, the LCD displays all marks and the sensor monitors the command from the USB port for 3 seconds. After that, the sensor enters the normal working state.
2. The LCD screen lighting stays active for 1 minute. If there is no operation, the sensor automatically switches its screen off for energy saving, but the program will keep running for normal detection and command transmissions. When the screen is off, pressing any (non-reset) button triggers the screen to be on again for another minute.
3. Sun icon: indicates the light intensity detection mode.
4. Flag icon: indicates the wind speed detection mode.
5. Battery icon: The voltage of the internal battery is checked by its inner program once every day. The appearance of this battery icon indicates that its voltage is below 3.0V.
6. RF signal icon: displayed when transmitting a signal.

2.3 Measure wind speed & light intensity

In the sleep mode (blank screen), pressing the Adjust key can loop through light intensity or wind speed. When the loop icon,  is present, the system will automatically display them in a cycle (5 seconds). The sequence is light > wind > loop (light).

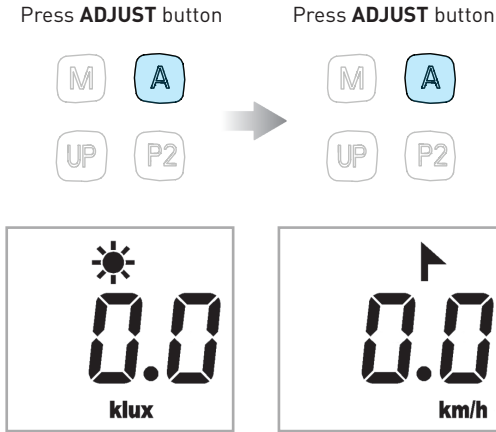

2.4 Display the pre-set threshold value

Press the MENU button repeatedly to display the pre-set threshold values in a cycle, the corresponding icon, , flashes to indicate that the pre-setting value is displayed. Pressing the MENU key again returns to the normal mode. The sequence is: display the light intensity threshold value > display the wind speed threshold value > return to normal mode.

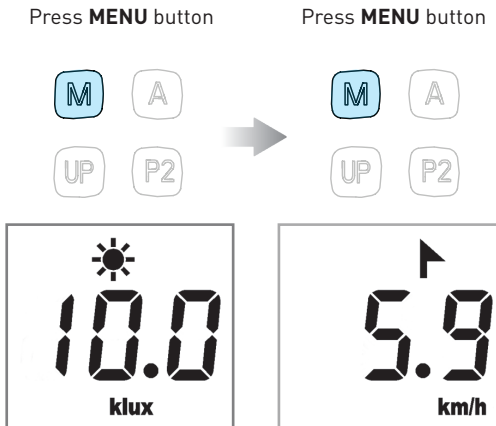

2.5 Change the threshold value

1. Press and hold the Menu button for 2 seconds to enter the setting mode, then press the Menu key to toggle the setting sequence: Set the light threshold value > Set the wind speed threshold value > Exit the setting state.

The flash of the setting number displayed on the screen indicates the setting mode. In this mode, the threshold values can be increased by pressing the **UP** button and decreased by pressing the Adjust button.

After 10 seconds without input, the sensor automatically returns to normal display mode. When settings are completed, the values, including light alarm values and wind speed alarm values are automatically save to the EEPROM. Resetting the sensor or powering down does not change those pre-set values.

2.6 Pair or unpair the sensor to a motor using a pre-paired remote

1. Pair the motor to a remote

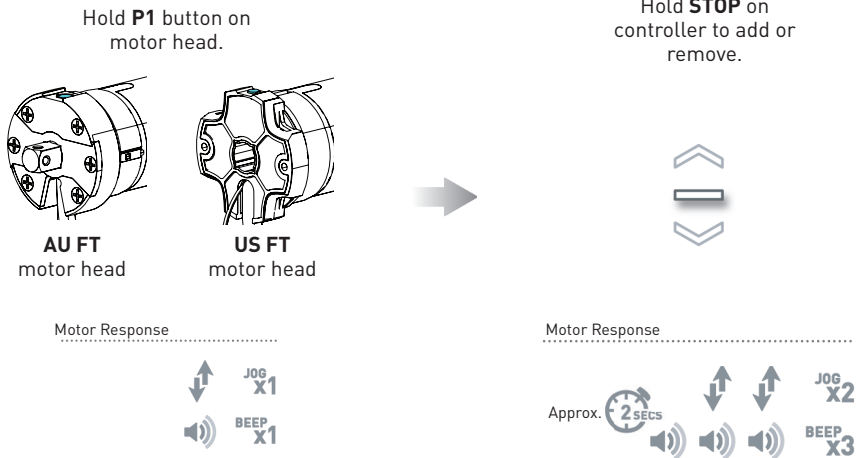

NOTE:

- The sensor can only work well when the motor was configured with the upper and bottom limits.
- The pair relationship is kept even if the motor power is reset or the sensor is reset to its default setting.

2.6 Pair or unpair the sensor to a motor using a pre-paired remote continued

2. Pair or unpair a motor to the sensor using a pre-paired remote

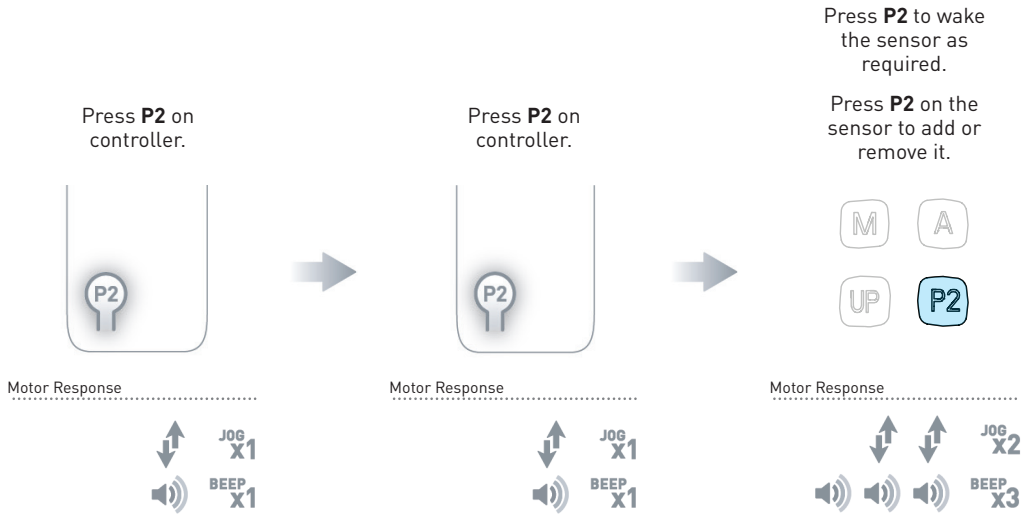

NOTE:

- The motor function should be turned on to detect wind and light before the sensor can initialize the motor movement.
- If the pair is successfully done, the motor can be triggered to move upward by pressing the **UP** button on the sensor.
- After the sensor is paired to a motor, it can independently drive the motor without the remote.
- Ensure the wind and light sensor functionality on the motor is enabled prior to pairing the wind and sun sensor.

3 WIND & LIGHT CONTROL

3.1 Disable or enable the detection of wind and light

- The wind speed control function can be disabled by setting its threshold to ZERO. Other threshold values enable this function.
 - The light intensity function can be disabled by setting its threshold to ZERO. Other threshold values enable this function.
1. Pair the motor with a controller
 2. Once paired to the motor:

Press **P2** on controller.



Press **UP** on controller.



Press **STOP** on controller.



Motor Response



Motor Response



Motor Response



3. Repeating this function disables the wind and sun sensor functionality:

Press **P2** on controller.



Press **UP** on controller.



Press **STOP** on controller.



Motor Response



Motor Response



Motor Response



3.2 Wind speed control













When the wind speed continuously exceeds the threshold value of wind speed (for longer than 3 seconds), the sensor command is executed to control the motor "UP" action. If the wind speed continuously exceeds the threshold, the sensor sends the "UP" command every 1 minute until 14 times. To prevent the motorized shades from frequently opening and closing under a gust, the motor does not operate for next 8 minutes.

3.3 Light control

- If the light control function is turned on, the sensor sends a command to trigger the motor to move **DOWN** when the environmental light intensity is higher than the threshold. After this period, the sensor temporarily disables its light detection for the next 15 minutes.
- If the light control function is on, the sensor drives the motor **UP** when the light intensity continues to be less than the set value for 15 minutes.
- Wind sensor trigger overrides light sensor, and moves motor up into top limit or tension, despite motor having moved down due to strong light.

Factory default threshold:

- wind speed=10km/h
- light intensity=10klux

Summary		 Mostly Sunny		 Mostly Sunny		 Mostly Sunny		 Mostly Sunny	
Temp. Max	°C	26		27		31		28	
	°F	79		81		88		82	
Temp. Min	°C	14		14		16		17	
	°F	58		58		61		63	
Light Intensity		High		High		High		Moderate	
Wind Speed	km/h	3	12	4	12	2	10	9	13
	mp/h	2	8	3	8	1	6	6	8
Motor Direction									
									

Light Definitions:
High >10klux
Moderate <10klux



UP



DOWN



STOP

NOTE:

1. After the sensor is powered on and a motor is paired to it, the sensor transmits an **"UP"** command immediately if the environmental wind speed is detected to be faster than the threshold. After 10 seconds, the sensor repeats the signal transmission ONCE. Its wind detection is disabled for another 3 minutes and the light control function is suspended for 15 minutes. Manual operation of pressing the **"UP"** and **"SET"** keys does not re-send the command transmission.
2. If the sensor detects strong light and wind, it transmits one command at least 5 times. Before its environment changes, the sensor suspends the signal transmission but still operates its normal functions such as the detection of light, wind and LCD functions.

4 TROUBLE SHOOTING

Problem	Cause	Remedy
Motor is not responding	Sensor battery is discharged	Recharge battery with a USB cable
	Radio interference/Shielding	Ensure transmitter is positioned away from metal objects and that the motor aerial/receiver is kept straight and away from metal
	Receiver distance is too far from transmitter	Move transmitter to a closer position
	Power failure	Check the connection from power supply to motor
	Incorrect wiring	Check if wiring is connected correctly
	Pairing error	Press UP button on sensor to verify pairing
	The motor's function of detecting wind/light is off	Turn on the function
Motor extends then constantly retracts unexpectedly	Wind or light threshold is too low	Increase the threshold to reduce sensitivity
	Extend motorized shade is casting shadow onto sensor	Check & reposition sensor if necessary
Motor does not react to wind or light setting	Wind sensitivity is too high or too low	Adjust sensitivity
	Time interval of strong wind is less than 3 minutes	The wind triggering time length must be over 3 minutes
	Time interval of light is less than 15 minutes	The light triggering time length must be over 15 minutes

ROLLEASE ACMEDA | USA

750 East Main Street, 7th Floor
Stamford, CT 06902
T +1 00 552 5100 | F +1 203 64 0513

ROLLEASE ACMEDA | AUSTRALIA

110 Northcorp Boulevard,
Broadmeadows VIC 3047
T +61 3 9355 0100 | F +61 3 9355 0110

ROLLEASE ACMEDA | EUROPE

Via Conca Del Naviglio 18, Milan
(Lombardia) Italy
T +39 02 8982 7317 | F +39 02 8982 7317

info@rolleasemed.com
rolleasemed.com