



Report Number: **709502304149-00B**

FCC/ISED TEST REPORT

Report Number : **709502304149-00B** Date of Issue: July 11, 2023

Model : MT01-1320-069001-S, MT01-1320-069002-S, MT01-1320-069003-S

Product Type : Li-ion 0.5Nm ARC Motor

Applicant : Rollease Acmeda Inc

Address : 7th Floor / 750 East Main Street, Stamford, CT 06902, USA

Production Facility : Ningbo Dooya Mechanic & Electronic Technology Co., Ltd

Address : No.168 Shengguang Road, Luotuo, Zhenhai, 315202 Ningbo, Zhejiang
Province, P.R. China.

Test Result : **Positive** **Negative**

Total pages including
 Appendices : 24



TÜV SÜD Certification and Testing (China) Co., Ltd. Shanghai Branch is a subcontractor to TÜV SÜD Product Service GmbH according to the principles outlined in ISO 17025.

TÜV SÜD Certification and Testing (China) Co., Ltd. Shanghai Branch reports apply only to the specific samples tested under stated test conditions. Construction of the actual test samples has been documented. It is the manufacturer's responsibility to assure that additional production units of this model are manufactured with identical electrical and mechanical components. The manufacturer/importer is responsible to the Competent Authorities in Europe for any modifications made to the production units which result in non-compliance to the relevant regulations. TÜV SÜD Certification and Testing (China) Co., Ltd. Shanghai Branch shall have no liability for any deductions, inferences or generalizations drawn by the client or others from TÜV SÜD Certification and Testing (China) Co., Ltd. Shanghai Branch issued reports.

This report is the confidential property of the client. As a mutual protection to our clients, the public and ourselves, extracts from the test report shall not be reproduced except in full without our written approval.

1 Table of Contents

1	Table of Contents.....	2
2	Details about the Test Laboratory.....	3
3	Description of the Equipment Under Test.....	4
4	Summary of Test Standards.....	5
5	Summary of Test Results.....	6
6	General Remarks.....	7
7	Systems test configuration.....	8
8	Test Setups.....	9
9	Test Methodology.....	11
9.1	Conducted Emission.....	11
9.2	Radiated Emission.....	16
9.3	Bandwidth Measurement.....	20
9.4	Deactivation Time.....	22
10	Test Equipment List.....	23
11	System Measurement Uncertainty.....	24

2 Details about the Test Laboratory

Details about the Test Laboratory

Test Site 1

Company name: TÜV SÜD Certification and Testing (China) Co., Ltd. Shanghai Branch
No.16 Lane, 1951 Du Hui Road,
Shanghai 201108,
P.R. China

Test Firm FCC
Registration
Number: 820234

Designation
number: CN1183

IC Company
Number: 25988

CAB identifier: CN0101

Telephone: +86 21 6141 0123
Fax: +86 21 6140 8600

3 Description of the Equipment Under Test

Product:	Li-ion 0.5Nm ARC Motor
Model no./HVIN/PMN:	MT01-1320-069001-S, MT01-1320-069002-S, MT01-1320-069003-S
FCC ID:	2AGGZ003B9ACA51
IC:	21769-003B9ACA51
Rating:	USB input 5V, Battery 8V
RF Transmission Frequency:	433.92MHz
Modulation:	GFSK
Antenna Type:	line antenna
Antenna Gain:	-7.16dBi
Description of the EUT:	The Equipment Under Test (EUT) was a Li-ion 0.5Nm ARC Motor, transmitter operated at 433. 92MHz. All models are identical in electrical and mechanical construction except for the model number and end-cap adaptor outside view. We chose model MT01-1320-069001-S to perform all tests.
Test sample no.:	SHA-738112-1

4 Summary of Test Standards

Test Standards	
FCC Part 15 Subpart C	PART 15 - RADIO FREQUENCY DEVICES Subpart C - Intentional Radiators
RSS-Gen Issue 5 Amendment 2 February 2021	General Requirements for Compliance of Radio Apparatus
RSS-210 Issue 10 December 2019	RSS-210 — License-exempt Radio Apparatus: Category I Equipment

All the test methods were according to ANSI C63.10-2013.

5 Summary of Test Results

Technical Requirements					
FCC Part 15 Subpart C, RSS-210 Issue 10					
Test Condition			Pages	Test Site	Test Result
§15.207	RSS-GEN A8.8	Conducted emission AC power port	10-15	Shield room	Pass
§15.205, §15.209, 15.35 (c)§15.231(b)	RSS-210 A.1.2	Radiated Emission, 30MHz to 4.5GHz	16-19	3m chamber	Pass
§15.231(c)	RSS-210 A.1.3	Bandwidth Measurement	20-21	Shield room	Pass
§15.231(a)(1)	RSS-210 A.1.1(a)	Deactivation Time	22	Shield room	Pass
§15.203	RSS-Gen 6.	Antenna requirement	--	See Note 2	Pass

Note 1: N/A=Not Applicable. Conducted emission is not apply for battery operated device.

Note 2: The EUT uses a line Antenna, which gain is -7.16dBi. In accordance to §15.203, It is considered sufficiently to comply with the provisions of this section.

6 General Remarks

Remarks

This submittal(s) (test report) is intended for FCC ID: 2AGGZ003B9ACA51, IC: 21769-003B9ACA51 complies with Section 15.207, 15.205, 15.209, 15.231 of the FCC Part 15, Subpart C Rules. RSS-Gen Issue 5 and RSS-210 issue 10.

SUMMARY:

All tests according to the regulations cited on page 5 were

■ - Performed

□ - **Not** Performed

The Equipment Under Test

■ - **Fulfills** the general approval requirements.

□ - **Does not** fulfill the general approval requirements.

Sample Received Date: June 20,2023

Testing Start Date: June 22,2023



Testing End Date: July 05,2023

TÜV SÜD Certification and Testing (China) Co., Ltd. Shanghai Branch

Reviewed by:

Prepared by:

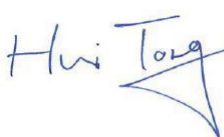
Tested by:





Hui TONG
EMC Section Manager

Jiayi XU
EMC Project Engineer

Cheng Huali
EMC Test Engineer

7 Systems test configuration

Auxiliary Equipment Used during Test:

DESCRIPTION	MANUFACTURER	MODEL NO.(SHIELD)	S/N(LENGTH)
Adapter	MLF	MLF-A260502000UU	--

8 Test Setups

8.1 AC Power Line Conducted Emission test setups

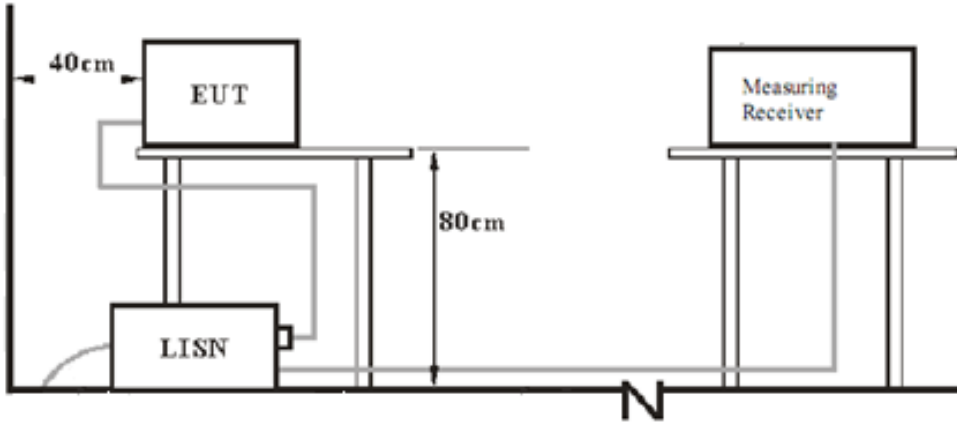

8.2 Radiated test setups

9kHz ~ 30MHz Test Setup:

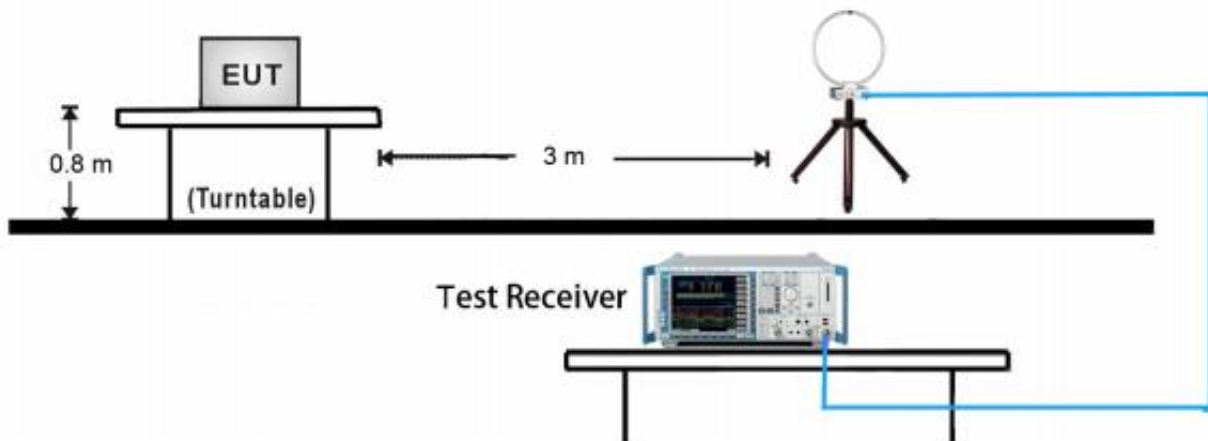

30MHz ~ 1GHz Test- Setup

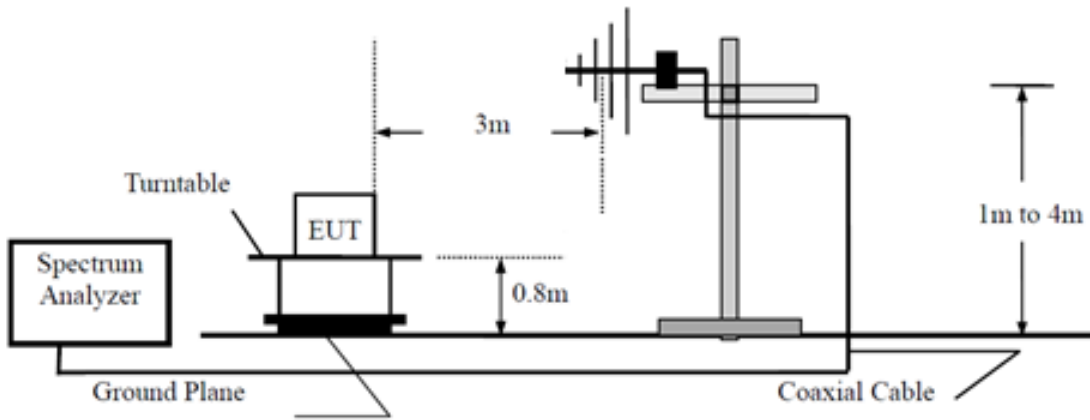

1GHz ~ 18GHz Test Setup:

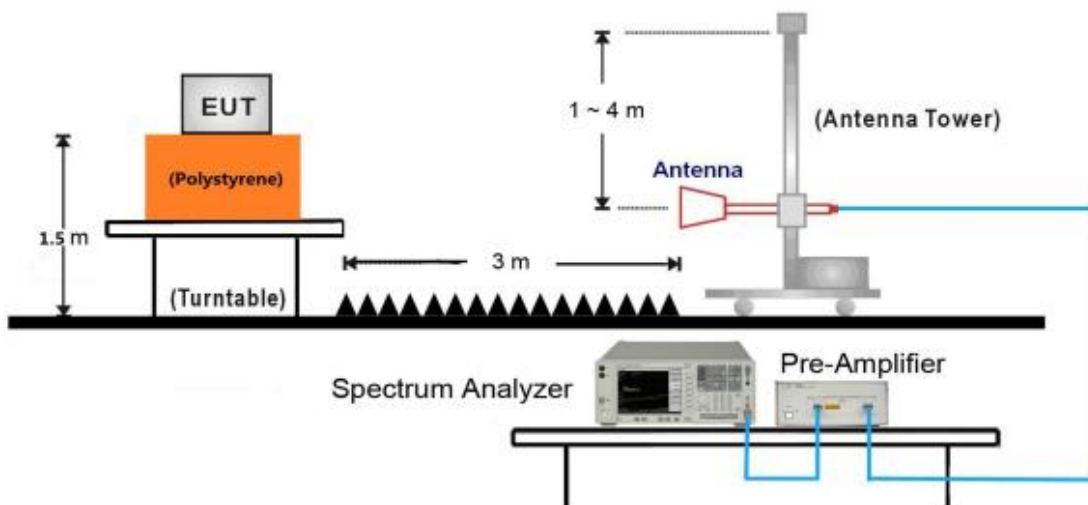

9 Test Methodology

9.1 Conducted Emission

Test Method

1. The EUT was placed on a table, which is 0.8m above ground plane
2. The power line of the EUT is connected to the AC mains through a Artificial Mains Network (A.M.N.).
3. Maximum procedure was performed to ensure EUT compliance
4. A EMI test receiver is used to test the emissions from both sides of AC line

Limit

Frequency MHz	QP Limit dB μ V	AV Limit dB μ V
0.150-0.500	66-56*	56-46*
0.500-5	56	46
5-30	60	50

Decreasing linearly with logarithm of the frequency

Conducted Emission

150k-30MHz Conducted Emission Test

EUT Information

EUT Name: Li-ion 0.5Nm ARC Motor
 Model: MT01-1320-069001-S
 Client: Rollease Acmeda Inc
 Op Cond: Power on, AC 120V/60Hz, T21.3, H56.3%, P100.1kPa
 Operator: Cheng Huali
 Standard: FCC Part 15.207(a),RSS-GEN
 Comment: Phase L
 Sample No.: SHA-738112-1

Scan Setup: Voltage with 2-Line-LISN pre [EMI conducted]

Hardware Setup: Voltage with 2-Line-LISN
 Receiver: [ESR 3]
 Level Unit: dBuV

Subrange	Step Size	Detectors	IF BW	Meas. Time	Preamp
9 kHz - 150 kHz	100 Hz	PK+	200 Hz	0.02 s	0 dB
150 kHz - 30 MHz	4.5 kHz	PK+; AVG	9 kHz	0.01 s	0 dB

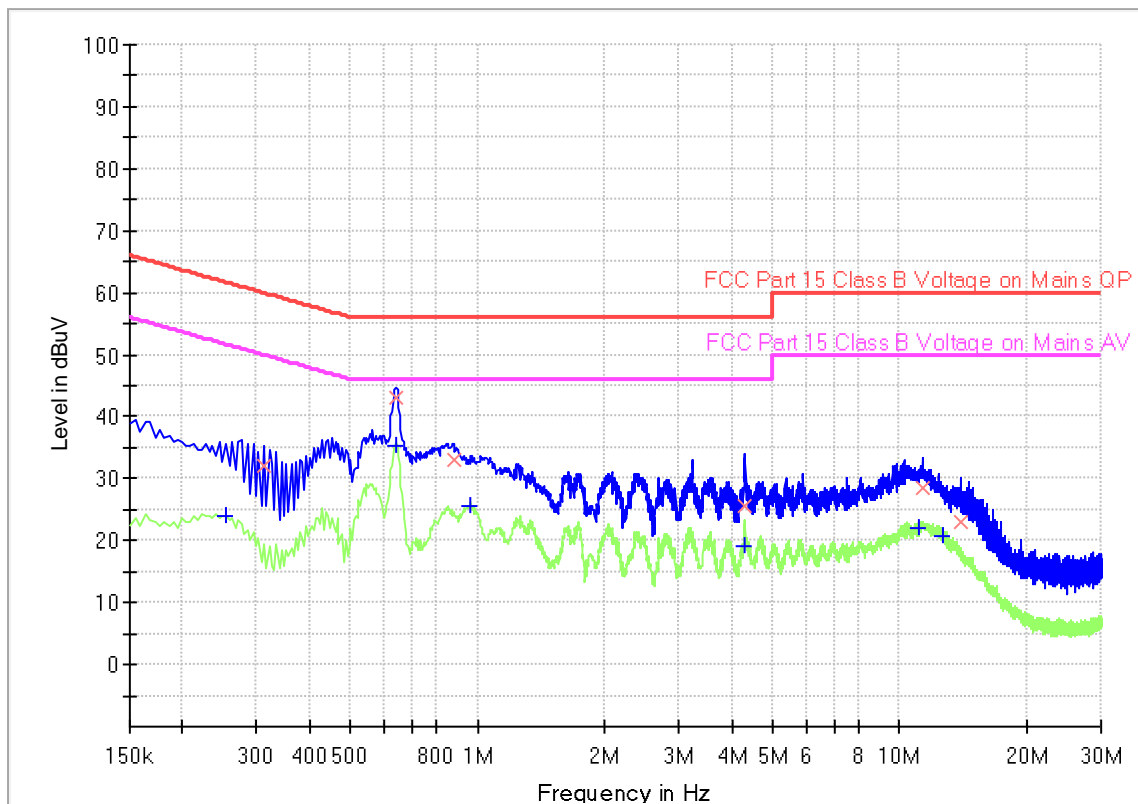

Final Result

Frequency (MHz)	QuasiPeak (dBuV)	CAverage (dBuV)	Limit (dBuV)	Margin (dB)	Meas. Time (ms)	Bandwidth (kHz)	Line	Corr. (dB)
0.253500	---	23.99	51.64	27.65	1000.0	9.000	L1	19.6
0.312000	31.99	---	59.92	27.93	1000.0	9.000	L1	19.6
0.640500	---	35.44	46.00	10.56	1000.0	9.000	L1	19.6
0.640500	42.99	---	56.00	13.01	1000.0	9.000	L1	19.6
0.879000	32.94	---	56.00	23.06	1000.0	9.000	L1	19.6
0.964500	---	25.62	46.00	20.38	1000.0	9.000	L1	19.6
4.294500	25.70	---	56.00	30.30	1000.0	9.000	L1	19.6
4.294500	---	19.27	46.00	26.73	1000.0	9.000	L1	19.6
11.143500	---	21.97	50.00	28.03	1000.0	9.000	L1	19.8
11.292000	28.63	---	60.00	31.37	1000.0	9.000	L1	19.8
12.628500	---	20.66	50.00	29.34	1000.0	9.000	L1	19.8
13.938000	23.12	---	60.00	36.88	1000.0	9.000	L1	19.8

150k-30MHz Conducted Emission Test

EUT Information

EUT Name: Li-ion 0.5Nm ARC Motor
 Model: MT01-1320-069001-S
 Client: Rollease Acmeda Inc
 Op Cond: Power on, AC 120V/60Hz, T21.3, H56.3%, P100.1kPa
 Operator: Cheng Huali
 Standard: FCC Part 15.207(a),RSS-GEN
 Comment: Phase N
 Sample No.: SHA-738112-1

Scan Setup: Voltage with 2-Line-LISN pre [EMI conducted]

Hardware Setup: Voltage with 2-Line-LISN
 Receiver: [ESR 3]
 Level Unit: dBuV

Subrange	Step Size	Detectors	IF BW	Meas. Time	Preamp
9 kHz - 150 kHz	100 Hz	PK+	200 Hz	0.02 s	0 dB
150 kHz - 30 MHz	4.5 kHz	PK+; AVG	9 kHz	0.01 s	0 dB

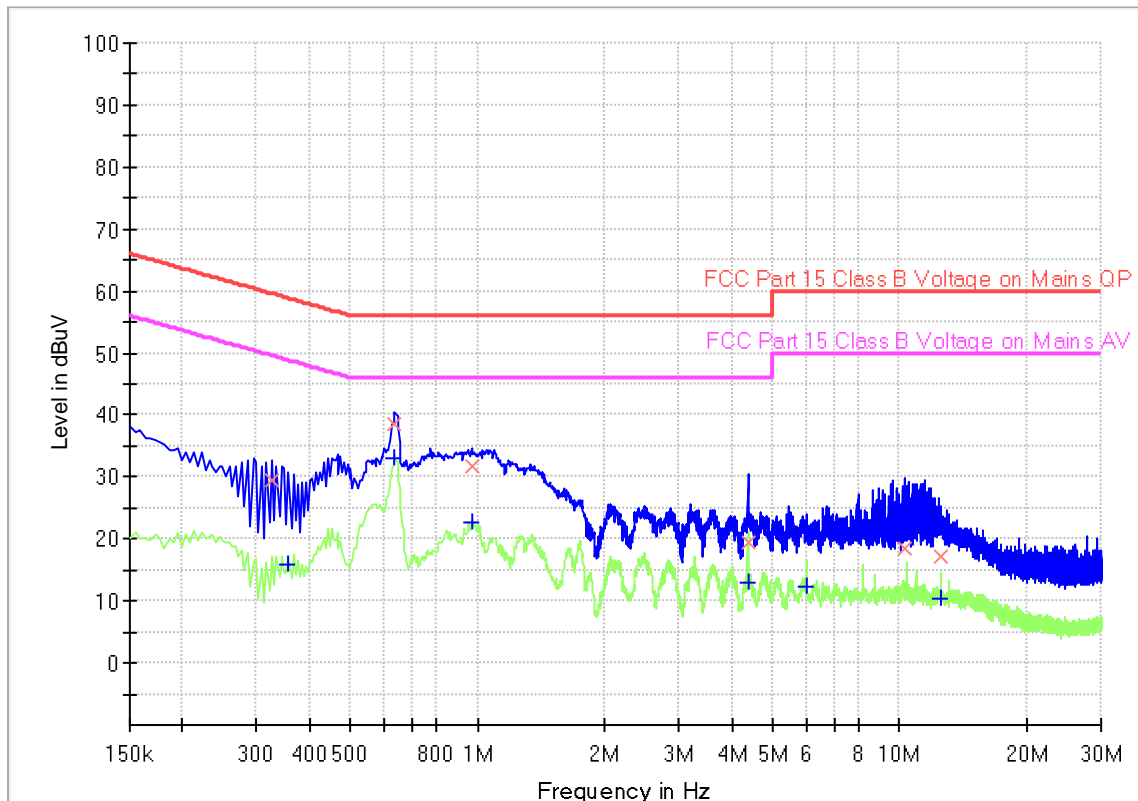

Final Result

Frequency (MHz)	QuasiPeak (dBuV)	CAverage (dBuV)	Limit (dBuV)	Margin (dB)	Meas. Time (ms)	Bandwidth (kHz)	Line	Corr. (dB)
0.325500	29.35	---	59.57	30.22	1000.0	9.000	N	19.6
0.357000	---	15.79	48.80	33.01	1000.0	9.000	N	19.6
0.636000	---	32.97	46.00	13.03	1000.0	9.000	N	19.6
0.636000	38.61	---	56.00	17.39	1000.0	9.000	N	19.6
0.969000	31.77	---	56.00	24.23	1000.0	9.000	N	19.6
0.969000	---	22.71	46.00	23.29	1000.0	9.000	N	19.6
4.366500	---	12.81	46.00	33.19	1000.0	9.000	N	19.7
4.371000	19.35	---	56.00	36.65	1000.0	9.000	N	19.7
6.004500	---	12.27	50.00	37.73	1000.0	9.000	N	19.7
10.288500	18.31	---	60.00	41.69	1000.0	9.000	N	19.9
12.498000	17.23	---	60.00	42.77	1000.0	9.000	N	19.9
12.574500	---	10.48	50.00	39.52	1000.0	9.000	N	19.9

Note 1: Measure Level (dBuV/m) = Reading Level (dBuV) + Factor (dB)
 Factor (dB) = Cable Loss (dB) + LISN Factor (dB) + 10dB Attenuator

9.2 Radiated Emission

Test Method

1. The EUT was placed on a turn table which is 1.5m above ground plane for above 1GHz and 0.8m above ground for below 1GHz at 3 meter chamber room for test. The table was rotated 360 degrees to determine the position of the highest radiation.
2. The EUT was set 3 meters away from the interference – receiving antenna, which was mounted on the top of a variable – height antenna tower.
3. The height of antenna is varied from one meter to four meters above the ground to determine the maximum value of the field strength. Both horizontal and vertical polarizations of the antenna are set to make the measurement.
4. For each suspected emission, the EUT was arranged to its worst case and then the antenna was tuned to heights from 1 meter to 4 meters and the rotatable table was turned from 0 degrees to 360 degrees to find the maximum reading.
5. Use the following spectrum analyzer settings According to C63.10:
For Above 1GHz
Span = wide enough to capture the peak level of the in-band emission and all spurious
RBW = 1MHz, VBW \geq 3RBW for peak measurement, Sweep = auto, Detector function = peak, Trace = max hold.
For Below 1GHz
Use the following spectrum analyzer settings:
Span = wide enough to capture the peak level of the in-band emission and all spurious
RBW = 100 KHz, VBW \geq 3RBW for peak measurement, Sweep = auto, Detector function = peak, Trace = max hold.

Note:

1. The resolution bandwidth and video bandwidth of test receiver/spectrum analyzer is 120 KHz for Quasi-peak detection (QP) at frequency below 1GHz.
2. The resolution bandwidth of test receiver/spectrum analyzer is 1MHz and the video bandwidth is 3MHz for peak detection (PK) at frequency above 1GHz.
3. The resolution bandwidth of test receiver/spectrum analyzer is 1MHz and the video bandwidth is 3MHz for RMS Average (duty cycle \geq 98%) for peak detection at frequency above 1GHz
4. If the emission is pulsed (duty cycle $<$ 98%), modify the unit for continuous operation: use the settings shown above, then correct the reading by subtracting the peak to average duty cycle correction factor $20\log(\text{duty cycle})$, derived from the appropriate duty cycle calculation.

Limit

According to §15.231 (b),RSS-210 the field strength of emissions from intentional radiators operated under this section shall not exceed the following:

Fundamental frequency (MHz)	Field Strength of Fundamental (Microvolts /meter)	Field Strength of spurious emissions ((Microvolts /meter)
40.66-40.70	2,250	225
70-130	1,250	125
130-174	1,250 to 3,370 *	125 to 3750 *
174-260	3,750	375
260-470 √	3,750 to 12, 500*	375 to 1,250*
Above 470	12,500	1,250

Limits for 15.209 and RSS-GEN Radiated emission limits; general requirements

Frequency (MHz)	Field strength (microvolts/meter)	Measurement distance (meters)
0.009-0.490	2400/F(kHz)	300
0.490-1.705	24000/F(kHz)	30
1.705-30.0	30	30
30-88	100	3
88-216	150	3
216-960	200	3
Above 960	500	3

Frequency	Limit at 3m (dBuV/m)
0.009 MHz – 0.490 MHz	128.5 to 93.8 ¹
0.490 MHz – 1.705 MHz	73.8 to 63 ¹
1.705 MHz – 30 MHz	69.5 ¹
30 MHz – 88 MHz	40.0 ¹
88 MHz – 216 MHz	43.5 ¹
216 MHz – 960 MHz	46.0 ¹
Above 960 MHz	54.0 ¹
Above 1000 MHz	54.0 ²
Above 1000 MHz	74.0 ³

¹Limit is with detector with bandwidths as defined in CISPR-16-1-1 except for the frequency bands 9-90 kHz, 110-490 kHz and above 1000 MHz where an Average detector is used.

²Limit is with 1 MHz measurement bandwidth and using an Average detector

³Limit is with 1 MHz measurement bandwidth and using a Peak detector

Spurious radiated emissions for transmitter

Radiated Emission								
Value	Emissions	E-Field	PK	Average	AV	Limit		Emission Type
	Frequency	Polarity	Emission	Factor	Emission		Margin	
	MHz		dBµV/m	dB	dBµV/m	dBµV/m	dB	
Below 1GHz								
PK	433.92	H	80.18	0.00	/	100.80	20.62	Fundamental
AV	433.92	H	80.18	-22.79	57.39	80.80	23.41	Fundamental
PK	433.92	V	74.40	0.00	/	100.80	26.40	Fundamental
AV	433.92	V	74.40	-22.79	51.61	80.80	29.19	Fundamental
PK	867.83	H	43.12	0.00	/	80.80	37.68	Spurious
AV	867.83	H	43.12	-22.79	20.33	60.80	40.47	Spurious
PK	867.80	V	39.23	0.00	/	80.80	41.57	Spurious
AV	867.80	V	39.23	-22.79	16.44	60.80	44.36	Spurious
Above 1GHz								
PK	1301.58	H	33.41	0.00	/	74.00	40.59	Restricted band
AV	1301.58	H	33.41	-22.79	10.62	54.00	43.38	Restricted band
PK	1735.63	H	35.77	0.00	/	80.80	45.03	Spurious
AV	1735.63	H	35.77	-22.79	12.98	60.80	47.82	Spurious
PK	1301.76	V	33.45	0.00	/	74.00	40.55	Restricted band
AV	1301.76	V	33.45	-22.79	10.66	54.00	43.34	Restricted band
PK	2169.23	V	37.11	0.00	/	80.80	43.69	Spurious
AV	2169.23	V	37.11	-22.79	14.32	60.80	46.48	Spurious

Remark:

- Corrected Amplitude = Read level + Corrector factor
 Above 1GHz: Corrector factor = Antenna Factor + Cable Loss- Amplifier Gain
 Below 1GHz: Corrector factor = Antenna Factor + Cable Loss
- Correct Factor = Antenna Factor + Cable Loss (+ Amplifier, for higher than 1GHz)
- Corrected Reading = Original Receiver Reading + Correct Factor
- Only the worst data listed in this report, Other frequency was 20dB below the limit
- AV Emission Level= PK Emission Level+20log(duty cycle),
 Duty Cycle = 7.25/100 =7.25%,
 Duty Cycle Factor =20log (Duty Cycle) =-22.79

Duty Cycle

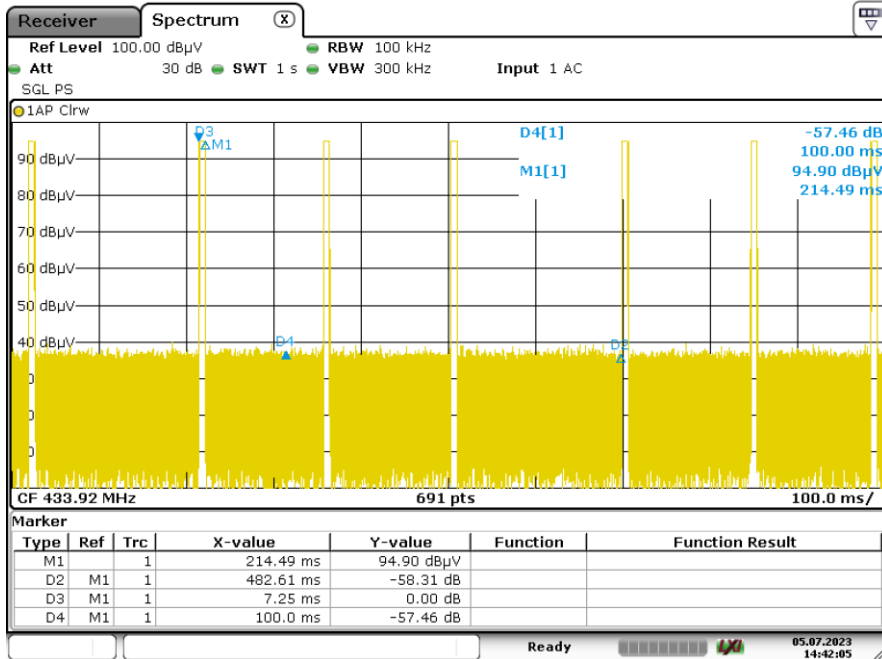

Date: 5.JUL.2023 14:42:06

9.3 Bandwidth Measurement

Test Method

1. Set to the maximum power setting and enable the EUT transmit continuously.
2. Use the following test receiver settings:
Span = approximately 5 times the 20dB bandwidth, centered on a hopping channel
RBW =1% to 5% of the 20dB bandwidth of the emission being measured, VBW \geq RBW,
Sweep = auto, Detector function = peak, Trace = max hold
3. Allow the trace to stabilize. Use the marker-to-peak function to set the marker to the peak of the emission. Measure the frequency difference of two frequencies that were attenuated 20 dB from the reference level. Record the frequency difference as the emission bandwidth. Record the results.
4. Repeat above procedures until all frequencies measured were complete.

Limit

The bandwidth of the emission shall be no wider than 0.25% of the center frequency for devices operating above 70MHz and below 900MHz. For devices operating above 900MHz, the emission shall be no wider than 0.5% of the center frequency. Bandwidth is determined at the points 20dB down from the modulated carrier.

The limit for the EUT = 0.25% * 433.92 MHz = 1084 kHz

Test Result

Channel	20dB Bandwidth (KHz)	Limit (KHz)
433.92MHz	82.042	1084

Channel	99% bandwidth (KHz)	Limit (KHz)
433.92MHz	72.242	N/A

20dB Bandwidth

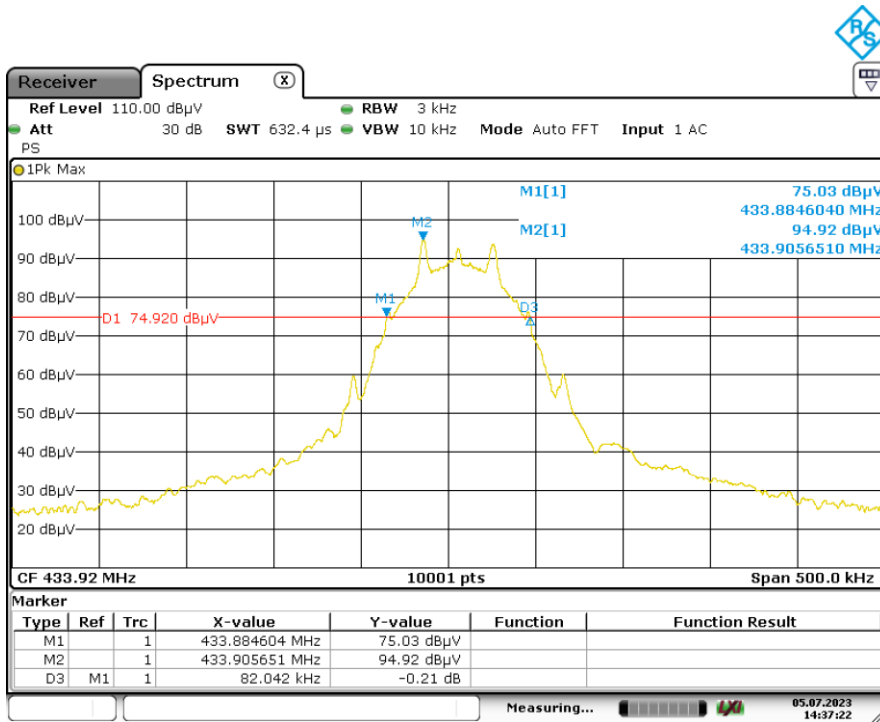

Date: 5.JUL.2023 14:37:22

99% Bandwidth

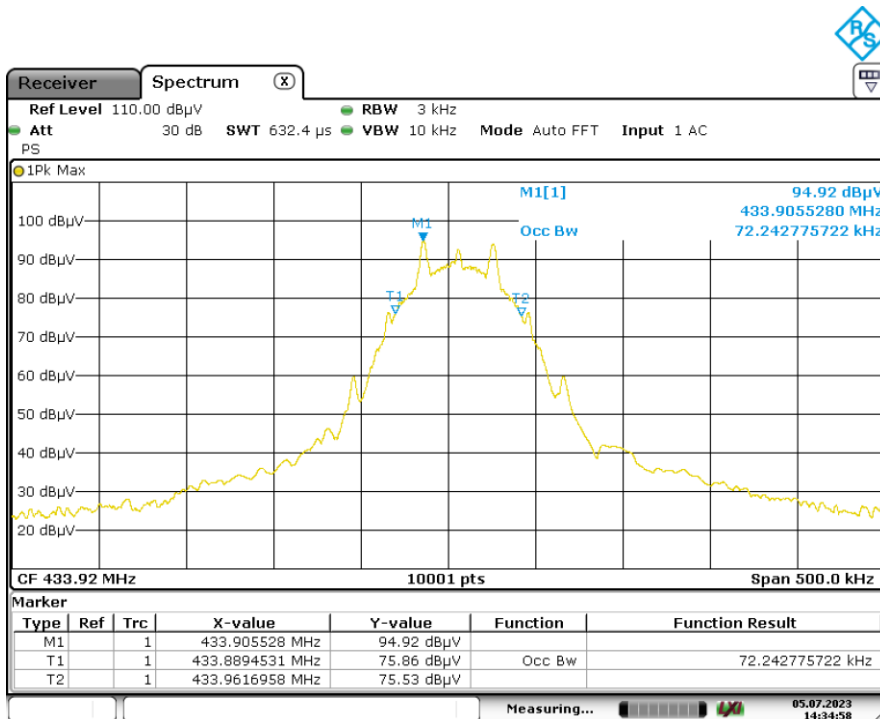

Date: 5.JUL.2023 14:34:58

9.4 Deactivation Time

Test Method

1. Set to the maximum power setting and enable the EUT in transmitting mode.
2. Set center frequency of spectrum analyzer=operating frequency.
3. Set the spectrum analyzer as RBW=120 KHz, VBW=1MHz, Span=0Hz.
4. Repeat above procedures until all frequency measured was complete.

Limit

According to FCC Part 15.231 (a), the transmitter shall be complied the following requirements:

- (1) A manually operated transmitter shall employ a switch that will automatically deactivate the transmitter within not more than 5 seconds of being released.
- (2) A transmitter activated automatically shall cease transmission within 5 seconds after activation.
- (3) Periodic transmissions at regular predetermined intervals are not permitted. However, polling or supervision transmissions, including data, to determine system integrity of transmitters used in security or safety applications are allowed if the total duration of transmissions does not exceed more than two seconds per hour for each transmitter. There is no limit on the number of individual transmissions, provided the total transmission time does not exceed two seconds per hour.

Test Result

Channel	Frequency	Deactivation Time	Result
1	433.92MHz	303.04ms	Pass

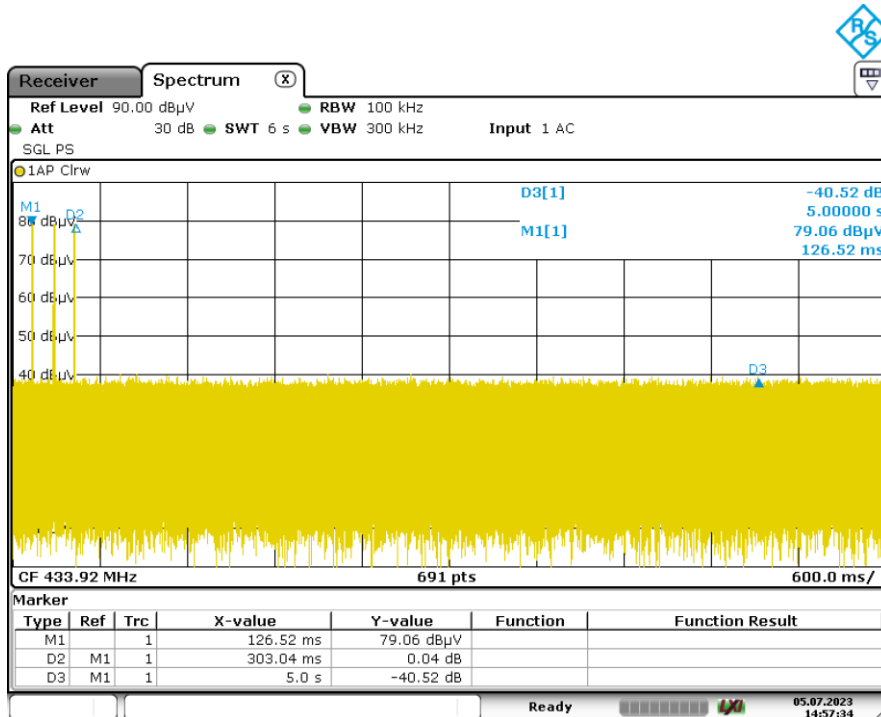

Date: 5 JUL 2023 14:57:35

10 Test Equipment List

List of Test Instruments

RF Test

Description	Manufacturer	Model no.	Serial no.	Calibration Date	Calibration Due
Signal and spectrum analyzer	R&S	FSV40	S1503003-YQ-EMC	2022-8-01	2023-7-31

Conducted Emission

Description	Model no.	Manufacturer	Equipment ID.	Calibration Date	Calibration Due
EMI test receiver	ESR3	R&S	S1503001-YQ-EMC	2022-8-01	2023-7-31
2-Line V-network	ENV216	R & S	S1503103-YQ-EMC	2022-8-01	2023-7-31

Radiated Emission Test

USED	Equipment Name	Model	Manufacturer	Equipment ID.	Calibration Date	Calibration Due
<input checked="" type="checkbox"/>	EMI test receiver	ESR3	R&S	S1503109-YQ-EMC	2022-8-01	2023-7-31
<input checked="" type="checkbox"/>	Trilog super broadband test antenna	SCHWARZBE CK	VULB9168	S1808296-YQ-EMC	2021-9-23	2024-9-22
<input checked="" type="checkbox"/>	Double-ridged waveguide horn antenna	HF907	R&S	S1503009-YQ-EMC	2021-4-13	2024-4-12
<input checked="" type="checkbox"/>	Signal conditioning unit	SCU-18D	R&S	S1503012-YQ-EMC	2022-8-01	2023-7-31
<input checked="" type="checkbox"/>	Signal and spectrum analyzer	FSV40	R&S	S1503003-YQ-EMC	2022-8-01	2023-7-31
<input checked="" type="checkbox"/>	Loop antenna	HFH2-Z2	R&S	S1503013-YQ-EMC	2023-6-15	2024-6-14

11 System Measurement Uncertainty

For a 95% confidence level, the measurement expanded uncertainties for defined systems, in accordance with the recommendations of ISO 17025 were:

Items	Extended Uncertainty
Conducted Disturbance	9kHz to 30MHz, 3.16dB (AMN)
Radiated Disturbance	9kHz to 30MHz, 3.52dB 30MHz to 1GHz, 5.03dB (Horizontal) 5.12dB (Vertical) 1GHz to 18GHz, 5.49dB 18GHz to 40GHz, 5.63dB

Measurement Uncertainty Decision Rule:

Determination of conformity with the specification limits is based on the decision rule according to IEC Guide 115: 2021, clause 4.4.3 and 4.5.1.

-----End of Test Report-----