



Instruction Manual

Digital Breathalyzer AF-50 AD

• KEY FEATURES

- OLED DISPLAY

Helps to read various information including total test number, date, unit and other options

- 100 TEST MEMORIES

Saves the test result including test date and time

- USER-FRIENDLY INTERFACE

Enables to change device setting easily

- GRAPH MODE

Allows to track all test results efficiently

- CALIBRATION REMINDER

Helps get on-time calibration by letting users know about the remaining days to the next calibration

* Please read the user's manual carefully before use.

Table of contents

1. Important Safety Information
2. Introduction
3. Contents
4. Name of each part
5. Basic Operation
 - 5.1 Preparation
 - 5.2 Operation with app
 - 5.3 Operation without app
 - 5.4 Symbols & Readings
6. Basic Menu Options
 - 6.1 TEST RESULT
 - 6.2 TEST RESULT-G
 - 6.3 ALARM LIMIT
 - 6.4 UNIT
 - 6.5 BRIGHTNESS
 - 6.6 SOUND
 - 6.7 INFORMATION
 - 6.8 PIN CODE
7. Advanced Menu Options
 - 7.1 TEST LIMIT
 - 7.2 SET TIME
 - 7.3 DATE LIMIT
 - 7.4 CHANGE PIN
8. Specification
9. Contact Information

1. Important Safety Information

- Before using the alcohol tester, read all instruction manual carefully and perform the test.
- Recommended to use calibration service every 12 months or after 500 times tests by experts. The use without periodic calibration service may result in invalid result.
- The test should be performed after 30 minutes after eating, drinking or smoking. Failure to wait 30 minutes may result in invalid results or incorrect results.
- Residual alcohol in the mouth can distort the measurement.
- Do not immerse in water.
- Aromatic drinks or mouth sprays containing alcohol can interfere with measurements. In this case, wait for 30 minutes or rinse the mouth with pure water.
- Do not permit to blow cigarette smoke into the tester which may damage the sensor.
- Don't do the drunk driving and even small amount of alcohol may cause impairment in normal driving operation.
- Do not use this device as a tool to determine "drink and drive". The manufacturer and the sellers will not take any legal responsibility for the test results.
- When not used for a long time, keep the device after taking out the batteries. In case of testing after long-term storage, there might be high tolerance of test results for the first test.
- Replace the batteries when the battery indicator icon reaches empty for the accuracy reason.
- In case the test result is higher than 0.1 %BAC (1.0 g/L) and you try again without interval, then the warm-up time might be delayed.
- Perform a test within the operating temperature, which is specified in the instruction manual.
- Blowing hard may cause damage to the sensor as saliva flows into the sensor.
- Do not store the device in the place where the temperature and humidity are high. Recommended it to store at room temperature.
- Do not suck in air during the test.
- Recommended using clean mouthpiece during the test for accurate measurements.
- The device including mouthpieces should be kept out of reach of children under 12 years of age.

2. Introduction

Thank you for purchasing our alcohol tester, which is a professional use alcohol tester with high-reliability. It can be used in the law enforcement, hospital, school and many other industrial fields. It measures estimated B.A.C (Blood Alcohol Content) in human breath by means of a premium fuel cell sensor which is highly durable and providing accurate breath alcohol results.

3. Contents

- Digital Breathalyzer: AF-50
- Two AA alkaline batteries
- 6 pieces of mouthpiece
- Carrying case
- Instruction manual

4. Name of each part

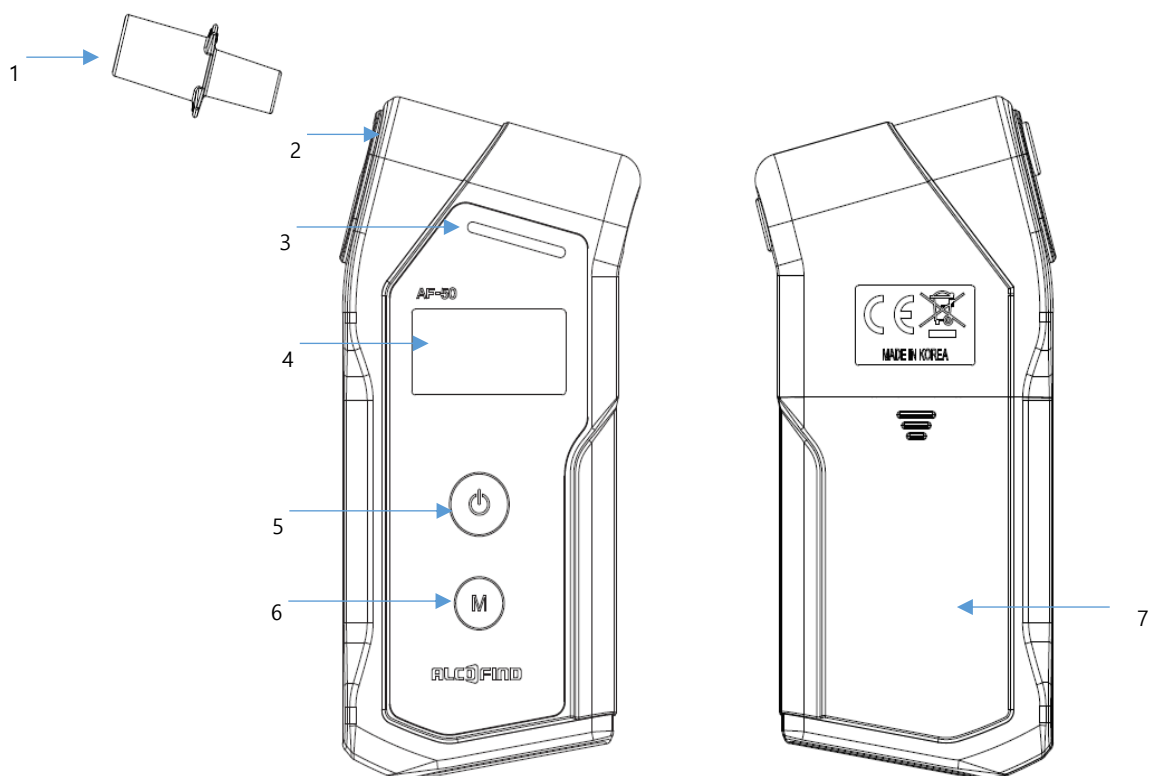

1. Mouthpiece
2. Mouthpiece slot
3. Status LED
4. High-Quality OLED Display
5. Power button
6. Menu button
7. Battery cover

5. Basic Operation

5.1 Preparation

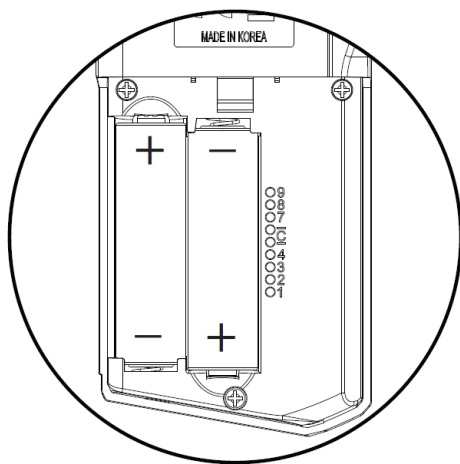

Insert two AA
batteries
(1.5V Alkaline)

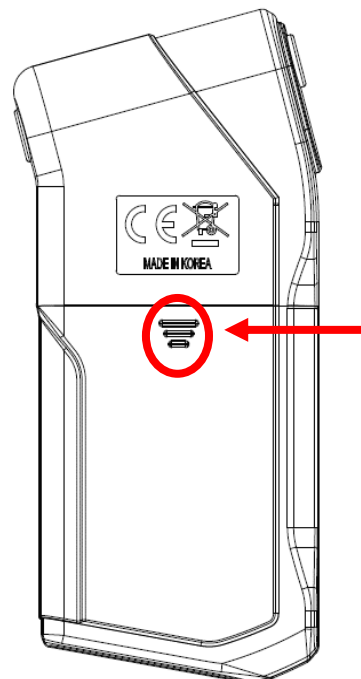

Press
and push
down
the cover
to open

Install two AA Batteries in the battery compartments by paying attention to the battery polarity.

Insert a mouthpiece into the slot on the side of the alcohol tester.

Ensure whether it securely fits or not.

Extra mouthpieces should be used for other person's testing for sanitary reasons.

5.2 Operation with app

Step 1. Open the app.

Note.

-Bluetooth must first be switched on in order to connect to the device. (Go to the Settings on your smartphone and turn on Bluetooth)

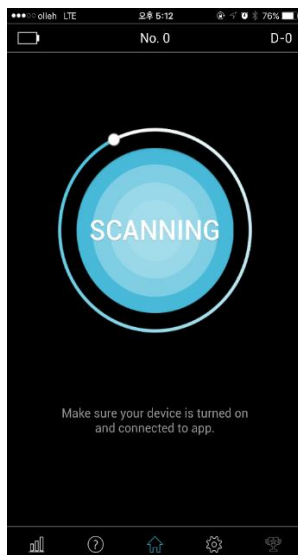

Step 2. To turn on the device, press and hold Power button for 2 seconds.

Step 3. If pairing is successful, the screen on your smartphone will show "START TEST". Tap "START TEST" on your smartphone.

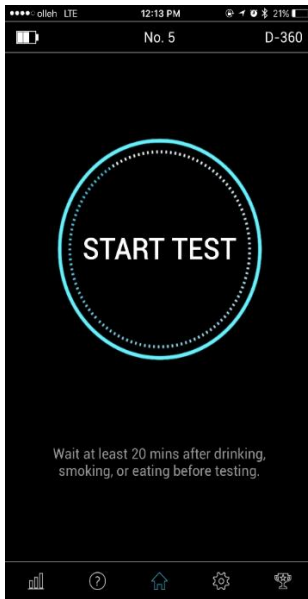

Note.

-In case of the first pairing process, a PIN Code request will be displayed. Input "000000" for PIN Code.

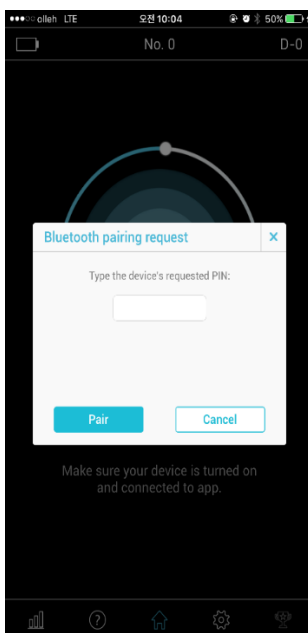

Note.

-The app is set to remember and search the device that has paired last time for 30 seconds.

-If the app is not able to find the previously paired device for 30 seconds, the app will show the following message.

-If you want the app to find another device, press "OK", and if you want the app to keep finding the previously paired device, press "Cancel".

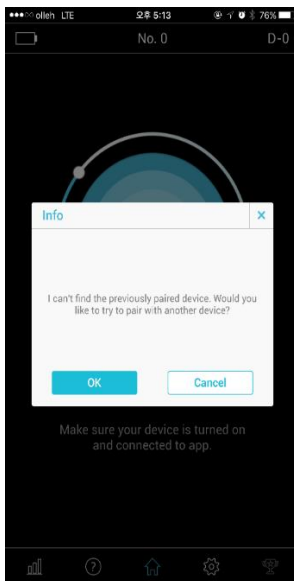

Step 4. Choose a user. Each test result will be saved separately according to the selection of the user. All history of saved test results are viewable from the Graphic Icon at the bottom of the menu.

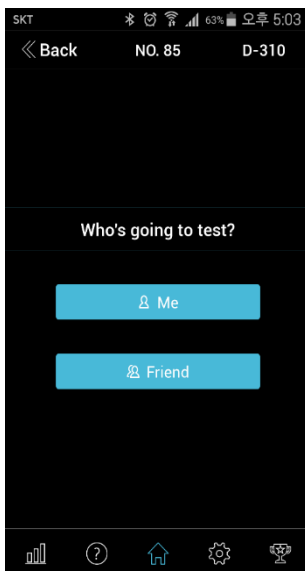

Step 5. The circular bar on the app indicates the progress of warm-up. When warming up gage reaches 95, take a deep breath and get ready for blowing.

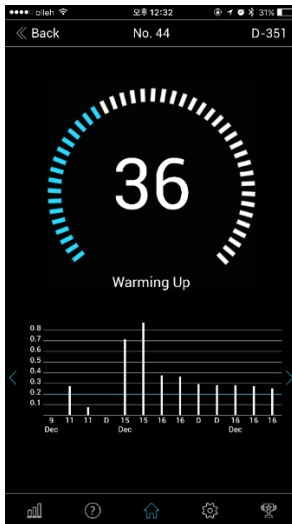

Step 6. When "Start blowing" is displayed, blow for 5 seconds into the mouthpiece until the gage reaches 100 or you feel the air has been pulled through the air pump in the device with a click.

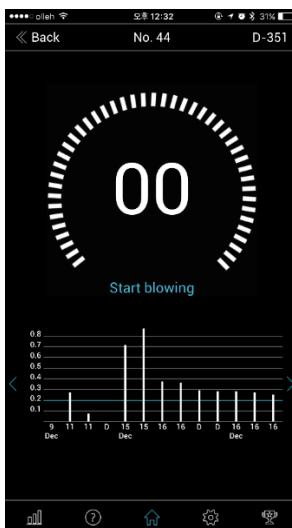

Note.

- If the camera feature is enabled, the camera will automatically capture the image of a user once the blowing has been completed.

Step 7. If a sufficient breath sample is taken correctly, the "Analyzing data" will be shown on the app.



Note.

- If insufficient sample is taken, an error message will displayed. To test again, press "OK" on the app.
- In the graph, the test results performed without app will be shown as "D".

Step 8. The estimated BAC level will be displayed on the app in a few seconds. In this page, the app enables you to make a memo which is viewable with test results from the Graph icon, and the test results can be also shareable via Text message, Facebook, or Twitter.

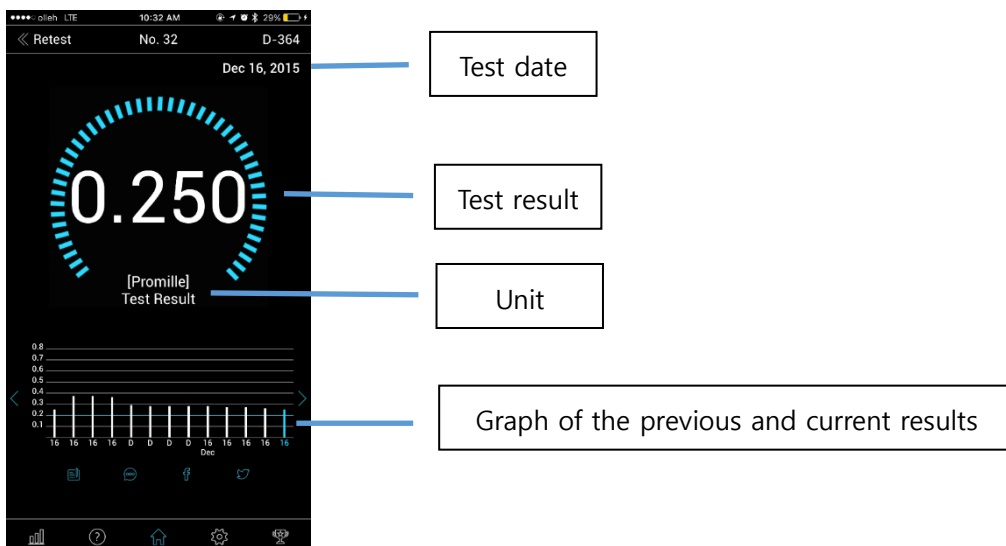

Step 9. Tap either "Retest" or "BAC level" on the app (or press Power Button on the device) to test again without selecting a user. If you want to start test again from the beginning, tap the Home

Icon at the bottom menu.

Step 10. Press and hold Power button on the device for 2 seconds to turn it off when you have finished testing.

Note.

- The device will turn off automatically if the device is not in use for 2 minutes.
- If you exit the app while the device is working with the app, all Blue, Red and Green LEDs on the device will flicker together. Press Power Button on the device to restart.

5.3 Operation without app

Step 1. Power On / Turn on the device

Press the power button for 2 seconds to turn on the device. The alarm limit, date and time set in the device will be displayed.



Step 2. Warm-up

The warm-up process will be started automatically. When the progress bar fills up, the 'START BLOW' will be displayed with double beep sound.



Note. Press the menu button shortly in this step if you want to check the 10 previous test results

with a bar graph, which enables you to check visually whether your test results are higher than the alarm limit that you have set in the menu.

Step 3. Measurement

Blow through the mouthpiece until the device beeps twice.

Note. The blowing time may vary depending on set value.



Step 4. Analyzing

When the sampling is successful, the analyzing process will be started automatically.



Step 5. Test result

After a few seconds (depending on the alcohol level), the estimated BAC will be displayed for 4 seconds, and the power button and menu button will be deactivated during this time. Depending on the test result, the status LED will be flashed as followings:

- 1) Flashes red LED if the test result is higher than the alarm limit
- 2) Flashes green LED if the test result is equal or lower than the alarm limit

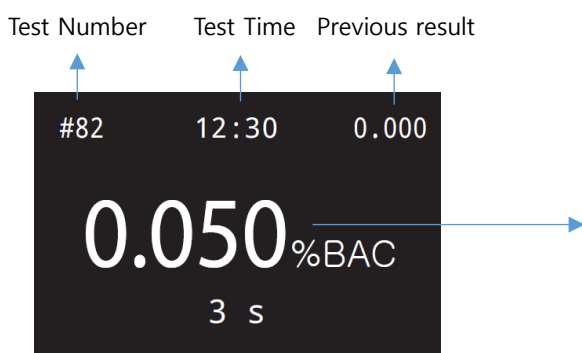

Test result

Step 6. After test

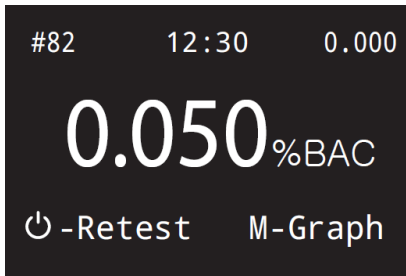

After displaying the test result for 4 seconds, the display will change to enable you to conduct the following functions:

- 1) RETEST - Press the power button shortly if you want to test again,
- 2) GRAPH - Press the menu button shortly if you want to check the 10 previous test results with a bar graph, which enables you to check visually whether your test results are higher than the alarm limit that you have set in the menu.



- ▲ : The most recent test result
- ◆ : The test result with an approved breath sample
- X : The test without an approved breath sample

- 3) POWER OFF - Press and hold the power button for 2 seconds if you want to turn off the device manually.

Note: The device will turn off automatically if it is not in use for 3 minutes.

5.4 Symbols & Troubleshooting

Status Display

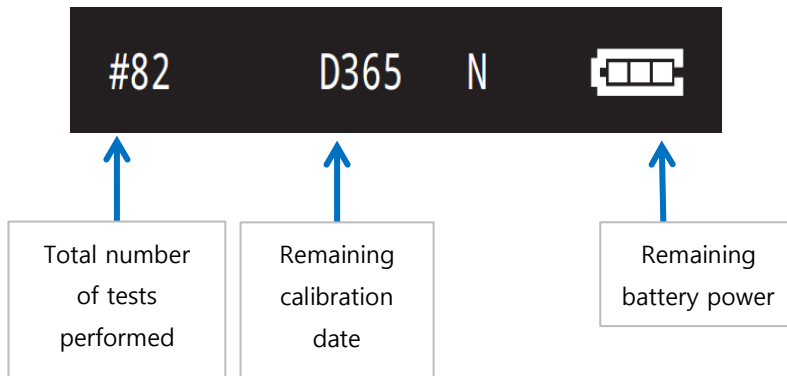

Troubleshooting guide

MESSAGE	WHAT IT MEANS	ACTION
BLOW ERROR	The sampling volume or blow power is not enough to analyze the breath sample.	Press the power button to perform a new retest.
LOW BATTERY	The testing cannot be performed because the battery is low.	Replace with new batteries.
CALIBRATION DUE DATE HAS PASSED	The calibration is required because the device has exceeded its recommended period of use.	Contact your local distributor or customer service center for proper recalibration service.
OVER NUMBER OF TEST ALLOWED	The calibration is required because the device has exceeded its recommended number of test.	Contact your local distributor or customer service center for proper recalibration service.
BREATH SAMPLE WITH EXCESSIVE SALIVA	The excessive saliva went into the sensor during the test.	Wait 20 minutes, and then try again. Contact your seller for customer service if this error code is displayed for a long time.
OUT OF TEMP RANGE	The testing cannot be performed because the device is powered on outside of operating temperature.	Repeat the test after the device has reached the temperature within the operating range.

<p>NO MEMORY CAPACITY AVAILABLE</p>	<p>The testing cannot be performed because the device has tested more than 10,000 times.</p>	<p>Contact your local distributor or customer service center for proper recalibration service.</p>
---	--	--

6. Basic Menu Options

*How to enter the menu options

- In Warm-up process (Step 2), press the menu button for 2 seconds.

*How to move/select/exit the menu options.

- To move the cursor up, press the power button shortly.
- To move the cursor down, press the menu button shortly.
- To enter the selected option, press the power button for 2 seconds.
- To return to warm up process, press the menu button for 2 seconds.

*How to save the selected setting

- Press and hold the power button and the menu button together for 2 seconds until a beep is heard.

6.1 TEST RESULT

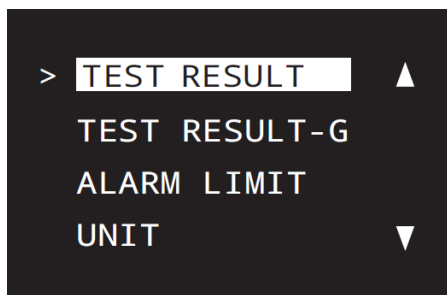

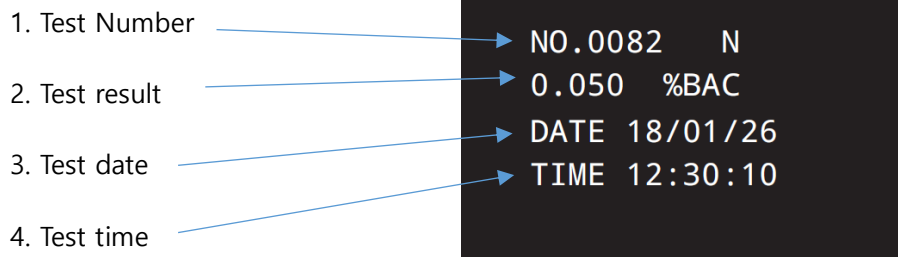

The test results can be checked with test number, date and time.

Note: The most recent test result will appear first.

* To see the previous result, press the power button shortly.

* To see the next result, press the menu button shortly.

* To return to the menu list, press the menu button for 2 seconds.

6.2 TEST RESULT-G

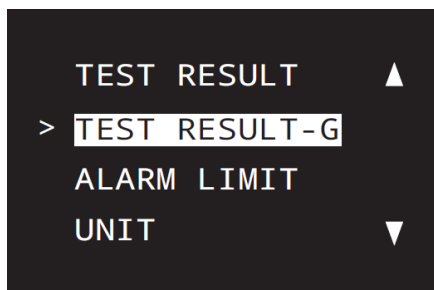

The test results can be checked with a bar graph, which enables you to check visually whether your test results are higher than the alarm limit that you have set in the menu.

* To see the previous page, press the power button shortly.

* To see the next page, press the menu button shortly.

* To return to the menu list, press the menu button for 2 seconds.

6.3 ALARM LIMIT



The limit value for alarm can be set in this menu.

The settable value range:

- 0.010 ~ 0.100 %BAC (0.10 ~ 1.00 ‰)
- OFF

* To raise the alarm limit, press the power button shortly.

* To reduce the alarm limit, press the menu button shortly.

* To save the setting and return to the menu list, press and hold the power button and the menu button together for 2 seconds.

* To return to the menu list without saving, press the menu button for 2 seconds.

6.4 UNIT

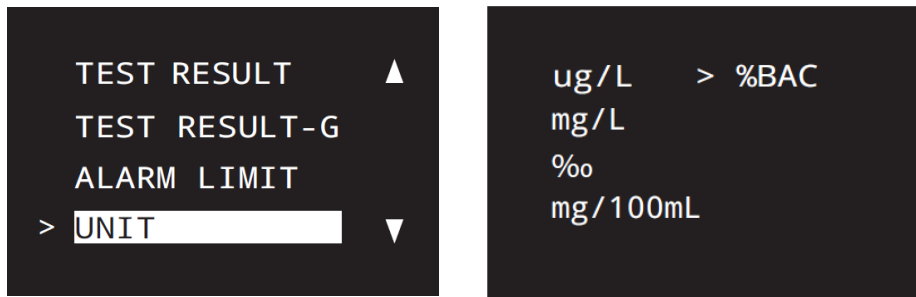

The measurement unit can be set in this menu.

The settable value range:

- ug/L, mg/L, ‰, mg/100mL, %BAC.

* To move the cursor up, press the power button shortly.

* To move the cursor down, press the menu button shortly.

* To save the setting and return to the menu list, press and hold the power button and the menu button together for 2 seconds.

* To return to the menu list without saving, press the menu button for 2 seconds.

6.5 BRIGHTNESS



The brightness of the display can be set in this menu.

The settable value range:

- HIGH, MID, LOW

* To move the cursor up, press the power button shortly.

* To move the cursor down, press the menu button shortly.

* To save the setting and return to the menu list, press and hold the power button and the menu button together for 2 seconds.

* To return to the menu list without saving, press the menu button for 2 seconds.

6.6 SOUND



The sound can be set in this menu.

The settable value range:

- HIGH, MID, LOW, OFF

* To move the cursor up, press the power button shortly.

* To move the cursor down, press the menu button shortly.

* To save the setting and return to the menu list, press and hold the power button and the menu button together for 2 seconds.

* To return to the menu list without saving, press the menu button for 2 seconds.

6.7 INFORMATION



The following information about the device can be checked in this menu.

1. Version of Firmware
2. The calibration date
3. The total number of tests performed

* To return to the menu list, press the menu button for 2 seconds.

6.8 PIN CODE



In this menu, the correct PIN code must be entered to move into the advanced menu option.

The default PIN code is 0000, and the PIN code is adjustable from 0000 to 9999 in the advanced menu option.

* To change digits of PIN code, press the power button for 2 seconds.

* To raise the number of PIN code, press the power button shortly.

* To reduce the number of PIN code, press the menu button shortly.

* To enter the advanced menu option, press and hold the power button and the menu button together for 2 seconds.

* To return to menu list, press the menu button for 2 seconds.

7. Advanced Menu Options

7.1 TEST LIMIT

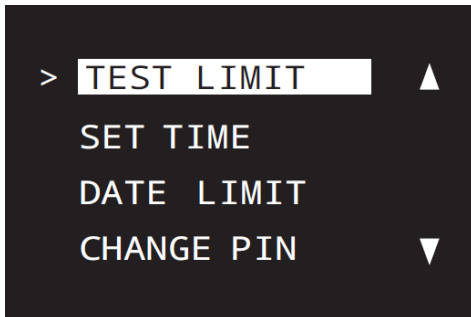

The maximum number of measurements allowed can be set in this menu.

The settable value range:

- 50 ~ 1000 tests
- OFF

* To raise the test limit, press power button shortly.

* To reduce the test limit, press the menu button shortly.

* To save the setting and return to the advanced menu list, press and hold the power button and the menu button together for 2 seconds.

* To return to the advanced menu list without saving, press the menu button for 2 seconds.

7.2 SET TIME

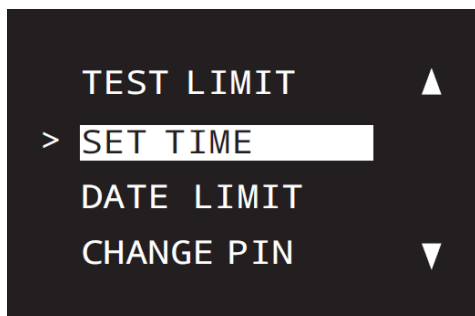

The device time can be adjusted in this menu.

* To change digits of time and date, press the power button for 2 seconds.

- * To raise the number of time and date, press the power button shortly.
- * To reduce the number of time and date, press the menu button shortly.
- * To save the setting and return to the advanced menu list, press and hold the power button and the menu button together for 2 seconds.
- * To return to the advanced menu list without saving, press the menu button for 2 seconds.

7.3 DATE LIMIT

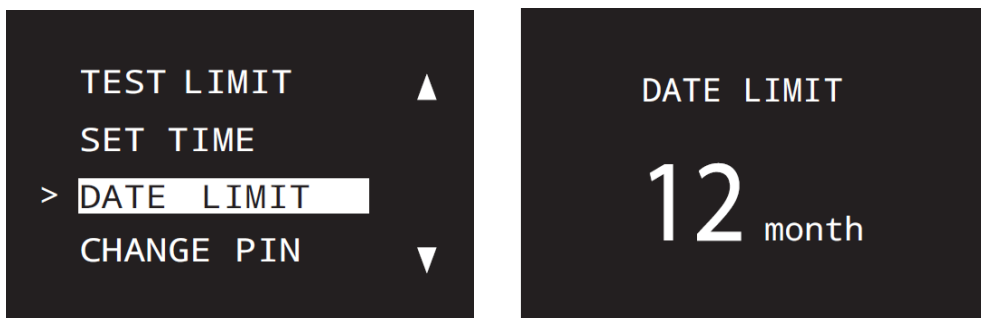

The date for the next calibration can be set in this menu.

The settable value range:

- 1 ~ 24 month

- * To raise the date limit, press the power button shortly.
- * To reduce the date limit, press the menu button shortly.
- * To save the setting and return to the advanced menu list, press and hold the power button and the menu button together for 2 seconds.
- * To return to the advanced menu list without saving, press the menu button for 2 seconds.

7.4 CHANGE PIN



The PIN code can be set in this menu.

The settable value range:

- 0000 ~ 9999.

* To change digits of PIN code, press the power button for 2 seconds.

* To raise the number of PIN code, press the power button shortly.

* To reduce the number of PIN code, press the menu button shortly.

* To save the setting and return to the advanced menu list, press and hold the power button and the menu button together for 2 seconds.

* To return to advanced menu list without saving, press the menu button for 2 seconds.

8. Specification

Indication of B.A.C	0.000 ~ 0.500 %BAC 0.00 ~ 5.00 ‰ 0.00 ~ 2.50 mg/L
Accuracy	±0.005 %BAC (at 0.100 %BAC, at 25 °C) ±0.05 ‰ (at 1.00 ‰, at 25 °C) ±0.025 mg/L (at 0.50 mg/L, at 25 °C)
Warm up time	Within 10 seconds at 0.050 %BAC * Warm up time may vary depending on the BAC measured
Sensor type	Premium Fuel Cell
Power supply	Two AA size alkaline batteries
Connectivity	Bluetooth 4.0 LE(1Mbps / 2Mbps)
Memory capacity	100 test results with test number, date and time
Battery life	Approx. 1000 tests
Dimensions(WxHxD)	60 x 128 x 24 mm
Weight	130 g including batteries
Calibration	Every 12 months or after 500 tests
Operating temperature	-5 ~ 40 °C

9. Contact information

For any questions, after-sales service, product calibration or to purchase additional mouthpieces, please kindly contact the nearest distributor or seller below.

Local distributor	
Manufacturer	DA Tech Co., Ltd 39, Pyeongcheon-ro 141beon-gil, Bupyeong-gu, Incheon, Korea Web: www.alcofind.com / Tel: +82-32-868-0844 / Fax: +82-32-868-0846

FCC Statements

This device complies with part 15 of the FCC Rules. Operation is subject to the following two conditions : (1) this device may not cause harmful interference, and (2) this device must accept any interference received, including interference that may cause undesired operation.

Note : This equipment has been tested and found to comply with the limits for a Class B digital device, pursuant to part 15 of the FCC Rules. These limits are designed to provide reasonable protection against harmful interference in a residential installation. This equipment generates, uses and can radiate radio frequency energy and, if not installed and used in accordance with the instructions, may cause harmful interference to radio communications. However, there is no guarantee that interference will not occur in a particular installation. If this equipment does cause harmful interference to radio or television reception, which can be determined by turning the equipment off and on, the user is encouraged to try to correct the interference by one or more of the following measures:

- Reorient or relocate the receiving antenna.
- Increase the separation between the equipment and receiver.
- Connect the equipment into an outlet on a circuit different from that to which the receiver is connected.
- Consult the dealer or an experienced radio/TV technician for help.

Changes or modifications not expressly approved by the party responsible for compliance could void the user's authority to operate the equipment.

This device complies with RF exposure requirement.

DECLARATION OF CONFORMITY

Directive 2014/53/EU

We, DA Tech Co., Ltd having its principal office at 39 Pyeongcheon-ro 141 beon-gil, Bupyeong-gu, Incheon, Korea, declare under our sole responsibility that the following product:

Product Name : Breathalyzer

Model number : AF-50

is in conformity with the following essential requirements and other relevant provisions of the Directive 2014/53/EU:

Essential Requirement	Applicable Standards / Specifications
Health & Safety	EN 60950-1:2006+A11:2009+A1:2010+A12:2011+A2:2013
	EN 62479 : 2010
Electromagnetic Compatibility	Draft ETSI EN 301 489-1 V2.2.0 (03/2017)
	Draft ETSI EN 301 489-3 V2.1.1 (03/2017)
	Final draft ETSI EN 301 489-17 V3.2.0 (03/2017)
	EN 61326-1:2013,
	EN 55011:2009+A1:2010 Class B,
	EN 61326-2-3 : 2013
	EN 61000-4-2 : 2009
	EN61000-4-3 : 2006+A1:2008+A2:2010,
EN 61000-4-8 : 2010	
Effective Use of Spectrum	EN 300 328 V2.1.1
	EN 303 413 V1.1.0
Various Requirements	Risk Assessment

The product carries the CE Mark:



Authorized Signature / Date: *K.H. Park* / October 11, 2018

Name & Title of Signatory: Kwang Hee Park / President

DA Tech Co., Ltd.

39 Pyeongcheon-ro 141 beon-gil,

Bupyeong-gu, Incheon, Korea