

# FCC SAR REPORT

**Applicant:** XCom Global Inc

**Address of Applicant:** 5910 pacific center blvd Suite 320 San diego, CA 92121 United States

**Equipment Under Test (EUT)**

Product Name: Global Mobile WiFi Travel Router

Model No.: fi1

Trade mark: SDG Telecom

**FCC ID:** 2AGER-XG1

**Applicable standards:** FCC 47 CFR Part 2.1093

**Date of Test:** 19 Nov., 2015 ~ 18 Dec., 2015

**Test Result:** Maximum Reported 1-g SAR (W/kg)  
Body: 1.044

Authorized Signature:



Bruce Zhang  
Laboratory Manager

This report details the results of the testing carried out on one sample. The results contained in this test report do not relate to other samples of the same product and does not permit the use of the CCIS product certification mark. The manufacturer should ensure that all products in series production are in conformity with the product sample detailed in this report.

This report may only be reproduced and distributed in full. If the product in this report is used in any configuration other than that detailed in the report, the manufacturer must ensure the new system complies with all relevant standards.

This document cannot be reproduced except in full, without prior written approval of the Company. Any unauthorized alteration, forgery or falsification of the content or appearance of this document is unlawful and offenders may be prosecuted to the fullest extent of the law. Unless otherwise stated the results shown in this test report refer only to the sample(s) tested and such sample(s) are retained for 90 days only.

## 2 Version

Version No.	Date	Description
00	22 Dec., 2015	Original
01	18 Jan., 2016	Updated Application Company Name and Address.

Prepared by: Sera Xiang Date: 22 Dec., 2015  
**Report Clerk**

Reviewed by: Janet Wei Date: 22 Dec., 2015  
**Project Engineer**

### 3 Contents

<b>1</b>	<b>COVER PAGE</b> .....	<b>1</b>
<b>2</b>	<b>VERSION</b> .....	<b>2</b>
<b>3</b>	<b>CONTENTS</b> .....	<b>3</b>
<b>4</b>	<b>SAR RESULTS SUMMARY</b> .....	<b>5</b>
<b>5</b>	<b>GENERAL INFORMATION</b> .....	<b>6</b>
5.1	CLIENT INFORMATION.....	6
5.2	GENERAL DESCRIPTION OF EUT .....	6
5.3	MAXIMUM RF OUTPUT POWER .....	7
5.4	ENVIRONMENT OF TEST SITE .....	8
5.5	TEST LOCATION .....	8
<b>6</b>	<b>INTRODUCTION</b> .....	<b>9</b>
6.1	INTRODUCTION .....	9
6.2	SAR DEFINITION.....	9
<b>7</b>	<b>RF EXPOSURE LIMITS</b> .....	<b>10</b>
7.1	UNCONTROLLED ENVIRONMENT.....	10
7.2	CONTROLLED ENVIRONMENT .....	10
7.3	RF EXPOSURE LIMITS .....	10
<b>8</b>	<b>SAR MEASUREMENT SYSTEM</b> .....	<b>11</b>
8.1	E-FIELD PROBE.....	12
8.2	DATA ACQUISITION ELECTRONICS (DAE).....	12
8.3	ROBOT .....	13
8.4	MEASUREMENT SERVER .....	13
8.5	LIGHT BEAM UNIT.....	13
8.6	PHANTOM.....	14
8.7	DEVICE HOLDER.....	15
8.8	DATA STORAGE AND EVALUATION .....	16
8.9	TEST EQUIPMENT LIST .....	18
<b>9</b>	<b>TISSUE SIMULATING LIQUIDS</b> .....	<b>19</b>
<b>10</b>	<b>SAR SYSTEM VERIFICATION</b> .....	<b>21</b>
<b>11</b>	<b>EUT TESTING POSITION</b> .....	<b>23</b>
11.1	HANDSET REFERENCE POINTS .....	23
11.2	POSITIONING FOR CHEEK / TOUCH .....	24
11.3	POSITIONING FOR EAR / 15° TILT.....	24
11.4	SAR EVALUATIONS NEAR THE MOUTH/JAW REGIONS OF THE SAM PHANTOM .....	25
11.5	BODY WORN ACCESSORY CONFIGURATIONS .....	25
11.6	WIRELESS ROUTER (HOTSPOT) CONFIGURATIONS .....	26
<b>12</b>	<b>MEASUREMENT PROCEDURES</b> .....	<b>27</b>
12.1	SPATIAL PEAK SAR EVALUATION .....	27
12.2	POWER REFERENCE MEASUREMENT.....	28
12.3	AREA & ZOOM SCAN PROCEDURES.....	28
12.4	VOLUME SCAN PROCEDURES .....	29
12.5	SAR AVERAGED METHODS .....	29
12.6	POWER DRIFT MONITORING .....	29
<b>13</b>	<b>CONDUCTED RF OUTPUT POWER</b> .....	<b>30</b>
13.1	GSM CONDUCTED POWER .....	30
13.2	WCDMA CONDUCTED POWER .....	32
13.3	LTE CONDUCTED POWER .....	35
13.4	WLAN 2.4 GHZ BAND CONDUCTED POWER .....	42
<b>14</b>	<b>EXPOSURE POSITIONS CONSIDERATION</b> .....	<b>43</b>
14.1	EUT ANTENNA LOCATIONS.....	43
14.2	TEST POSITIONS CONSIDERATION .....	43
<b>15</b>	<b>SAR TEST RESULTS SUMMARY</b> .....	<b>44</b>

15.1	STANDALONE BODY SAR .....	44
15.2	REPEATED SAR MEASUREMENT .....	46
15.3	MULTI-BAND SIMULTANEOUS TRANSMISSION CONSIDERATIONS.....	47
15.4	SAR SIMULTANEOUS TRANSMISSION ANALYSIS.....	48
15.5	MEASUREMENT UNCERTAINTY.....	49
15.6	MEASUREMENT CONCLUSION .....	51
<b>16</b>	<b>REFERENCE.....</b>	<b>52</b>
<b>APPENDIX A: EUT PHOTOS.....</b>		<b>53</b>
<b>APPENDIX B: TEST SETUP PHOTOS.....</b>		<b>55</b>
<b>APPENDIX C: PLOTS OF SAR SYSTEM CHECK .....</b>		<b>57</b>
<b>APPENDIX D: PLOTS OF SAR TEST DATA .....</b>		<b>64</b>
<b>APPENDIX E: SYSTEM CALIBRATION CERTIFICATE.....</b>		<b>76</b>

## 4 SAR Results Summary

The maximum results of Specific Absorption Rate (SAR) found during test as bellows:

<Highest Reported standalone SAR Summary>

Exposure Position	Frequency Band	Reported 1-g SAR (W/kg)	Equipment Class	Highest Reported 1-g SAR (W/kg)
Body (10 mm Gap)	GSM 850	0.637	PCE	1.044
	GSM 1900	0.983		
	WCDMA Band V	0.616		
	WCDMA Band II	1.044		
	LTE Band 4	0.579		
	LTE Band 7	0.653		
	LTE Band 17	0.680		
	WLAN 2.4GHz	0.103	DTS	

<Highest Reported simultaneous SAR Summary>

Exposure Position	Frequency Band	Reported 1-g SAR (W/kg)	Equipment Class	Highest Reported Simultaneous Transmission 1-g SAR (W/kg)
Front	WCDMA Band II	1.044	PCE	1.147
	WLAN 2.4 GHz	0.103	DTS	

**Note:**

1. The highest simultaneous transmission is scalar summation of Reported standalone SAR per FCC KDB 690783 D01 v01r02, and scalar SAR summation of all possible simultaneous transmission scenarios are < 1.6W/kg.
2. This device is compliance with Specific Absorption Rate (SAR) for general population/uncontrolled exposure limits (1.6 W/kg) specified in FCC 47 CFR part 2 (2.1093) and ANSI/IEEE C95.1-2005, and had been tested in accordance with the measurement methods and procedures specified in IEEE 1528-2013.

## 5 General Information

### 5.1 Client Information

Applicant:	XCom Global Inc
Address of Applicant:	5910 pacific center blvd Suite 320 San diego, CA 92121 United States
Manufacturer:	Asiatelco Technologies Co.
Address of Manufacturer:	#289, Bisheng Road, Pilot Free Trade Zone, Shanghai, China

### 5.2 General Description of EUT

Product Name:	Global Mobile WiFi Travel Router	
Model No.:	fi1	
Hardware Version:	XK8880_P2	
Software Version:	MF_XK8880B_AT1.17_V02	
Category of device	Portable device	
Operation Frequency:	GSM850: 824.2 ~ 848.8 MHz PCS 1900: 1850.2 ~ 1909.8 MHz WCDMA Band V: 826.4 ~ 846.6 MHz WCDMA Band II: 1852.4 ~ 1907.6 MHz FDD LTE Band 4 :1710MHz~1755MHz FDD LTE Band 7: 2500MHz~2570MHz FDD LTE Band 17: 704MHz~716MHz Wi-Fi: 802.11b/g/n-HT20: 2412MHz ~ 2462 MHz	
Modulation technology:	GSM/GPRS:GMSK, EGPRS: 8PSK, WCDMA/HSDPA/HSUPA: BPSK LTE:QPSK/16QAM Wi-Fi: 802.11b: DSSS, 802.11a/g/n: OFDM	
Antenna Type:	Internal Antenna	
Antenna Gain:	GSM 850: 1.3 dBi, PCS 1900: 1.3 dBi WCDMA Band V: 1.3 dBi, WCDMA Band II: 1.3 dBi LTE Band 4: 0.2 dBi, LTE Band 7: 1.55 dBi LTE Band 17: -3.25 dBi, WIFI:0.63 dBi	
Release Version:	R99 for GSM, R6 for WCDMA, R8 for LTE	
(E)GPRS Class:	(E)GPRS Class: 12	
Dimensions (L*W*H):	111 mm (L)x 70 mm (W)x 20 mm (H)	
Accessories information:	Adapter: /	Battery: Li-ion Battery 3.8V/6000mAh
		Headset: Not Support

### 5.3 Maximum RF Output Power

Mode	Average Power (dBm)	
	GSM 850	GSM 1900
GSM (Voice)	32.29	28.64
GPRS (1 TX Slot)	32.26	28.75
GPRS (2 TX Slots)	32.26	28.71
GPRS (3 TX Slots)	31.10	27.33
GPRS (4 TX Slots)	29.16	25.29
EGPRS (1 TX Slot)	26.15	24.64
EGPRS (2 TX Slots)	24.73	22.80
EGPRS (3 TX Slots)	23.71	21.49
EGPRS (4 TX Slots)	22.58	19.11

Mode	Average Power (dBm)	
	WCDMA Band V	WCDMA Band II
AMR 12.2 kbps	24.41	22.29
RMC 12.2 kbps	24.39	22.27
HSDPA Sub-test 1	24.49	22.42
HSDPA Sub-test 2	24.04	21.83
HSDPA Sub-test 3	22.47	20.20
HSDPA Sub-test 4	21.89	20.02
HSUPA Sub-test 1	24.13	21.97
HSUPA Sub-test 2	24.29	22.30
HSUPA Sub-test 3	22.41	20.26
HSUPA Sub-test 4	24.44	22.48
HSUPA Sub-test 5	23.90	21.44

Mode	Average Power (dBm)		
	LTE Band 4	LTE Band 7	LTE Band 17
BW/1.4 MHz	21.68	/	/
BW/3.0 MHz	21.44	/	/
BW/5.0 MHz	21.44	22.54	23.15
BW/10 MHz	21.62	22.59	23.16
BW/15 MHz	21.63	22.65	/
BW/20 MHz	21.52	22.62	/

WLAN 2.4 GHz Band Average Power (dBm)				
Mode/Band	b	g	n (HT-20)	n (HT-40)
WLAN 2.4GHz	16.60	14.05	14.00	Not support

**5.4 Environment of Test Site**

<b>Temperature:</b>	18°C ~25 °C
<b>Humidity:</b>	35%~75% RH
<b>Atmospheric Pressure:</b>	1010 mbar

**5.5 Test Location**

Shenzhen Zhongjian Nanfang Testing Co., Ltd.  
Address: No. B-C, 1/F., Building 2, Laodong No.2 Industrial Park, Xixiang Road,  
Bao'an District, Shenzhen, Guangdong, China  
Tel: +86-755-23118282  
Fax: +86-755-23116366



## 6 Introduction

### 6.1 Introduction

SAR is related to the rate at which energy is absorbed per unit mass in an object exposed to a radio field. The SAR distribution in a biological body is complicated and is usually carried out by experimental techniques or numerical modeling. The standard recommends limits for two tiers of groups, occupational/controlled and general population/uncontrolled, based on a person's awareness and ability to exercise control over his or her exposure. In general, occupational/controlled exposure limits are higher than the limits for general population/uncontrolled.

### 6.2 SAR Definition

The SAR definition is the time derivative (rate) of the incremental energy (dW) absorbed by (dissipated in) an incremental mass (dm) contained in a volume element (dv) of a given density (ρ). The equation description is as below:

$$SAR = \frac{d}{dt} \left( \frac{dU}{dm} \right) = \frac{d}{dt} \left( \frac{dU}{\rho dv} \right)$$

SAR is expressed in units of Watts per kilogram (W/kg)

SAR measurement can be either related to the temperature elevation in tissue by

$$SAR = C \left( \frac{\delta T}{\delta t} \right)$$

Where: C is the specific heat capacity,  $\delta T$  is the temperature rise and  $\delta t$  is the exposure duration, or related to the electrical field in the tissue by

$$SAR = \frac{\sigma \cdot E^2}{\rho}$$

Where:  $\sigma$  is the conductivity of the tissue,  $\rho$  is the mass density of the tissue and E is the RMS electrical field strength. However for evaluating SAR of low power transmitter, electrical field measurement is typically applied.

## 7 RF Exposure Limits

### 7.1 Uncontrolled Environment

Uncontrolled Environments are defined as locations where there is the exposure of individuals who have no knowledge or control of their exposure. The general population/uncontrolled exposure limits are applicable to situations in which the general public may be exposed or in which persons who are exposed as a consequence of their employment may not be made fully aware of the potential for exposure or cannot exercise control over their exposure. Members of the general public would come under this category when exposure is not employment-related; for example, in the case of a wireless transmitter that exposes persons in its vicinity.

### 7.2 Controlled Environment

Controlled Environments are defined as locations where there is exposure that may be incurred by persons who are aware of the potential for exposure, (i.e. as a result of employment or occupation). In general, occupational/controlled exposure limits are applicable to situations in which persons are exposed as a consequence of their employment, who have been made fully aware of the potential for exposure and can exercise control over their exposure. This exposure category is also applicable when the exposure is of a transient nature due to incidental passage through a location where the exposure levels may be higher than the general population/uncontrolled limits, but the exposed person is fully aware of the potential for exposure and can exercise control over his or her exposure by leaving the area or by some other appropriate means.

### 7.3 RF Exposure Limits

SAR Human Exposure Specified in ANSI/IEEE C95.1-1992 and Health Canada Safety Code 6

HUMAN EXPOSURE LIMITS		
	UNCONTROLLED ENVIRONMENT <i>General Population</i> (W/kg) or (mW/g)	CONTROLLED ENVIRONMENT <i>Occupational</i> (W/kg) or (mW/g)
SPATIAL PEAK SAR Brain	1.6	8.0
SPATIAL AVERAGE SAR Whole Body	0.08	0.4
SPATIAL PEAK SAR Hands, Feet, Ankles, Wrists	4.0	20

**Note:**

1. The Spatial Peak value of the SAR averaged over any 1 gram of tissue (defined as a tissue volume in the shape of a cube) and over the appropriate averaging time.
2. The Spatial Average value of the SAR averaged over the whole body.
3. The Spatial Peak value of the SAR averaged over any 10 grams of tissue (defined as a tissue volume in the shape of a cube) and over the appropriate averaging time.

## 8 SAR Measurement System

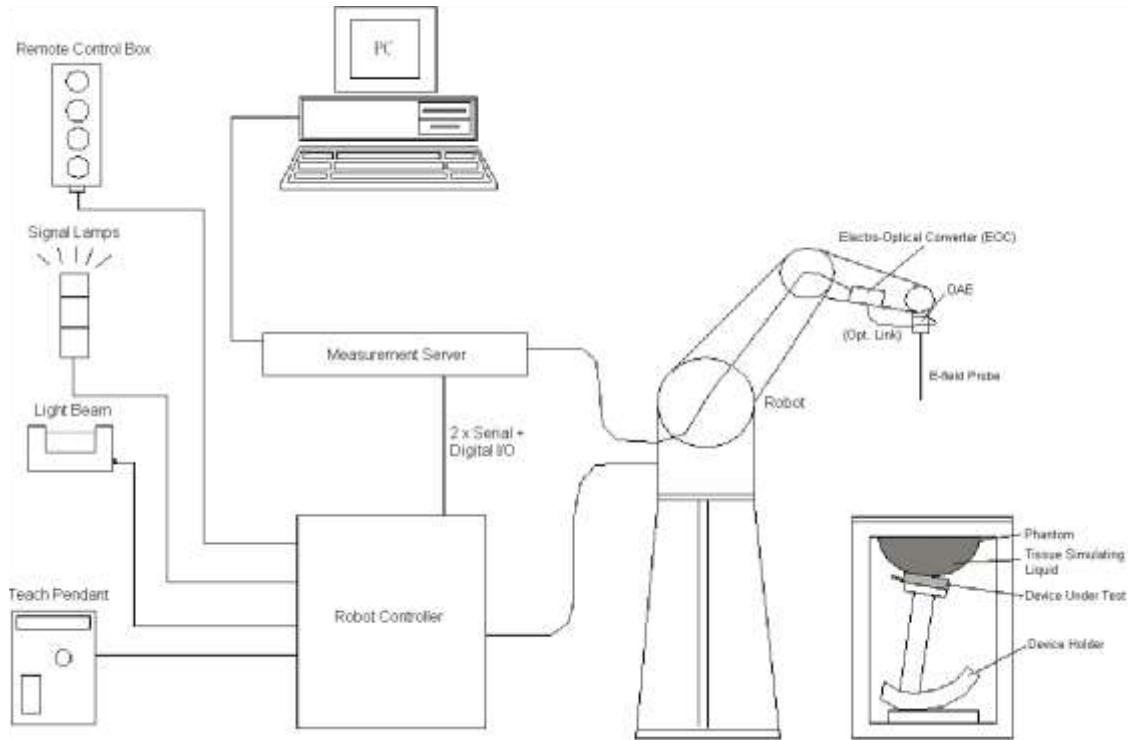

**Fig. 8.1 SPEAG DASY System Configurations**

The DASY system for performance compliance tests is illustrated above graphically. This system consists of the following items:

- A standard high precision 6-axis robot with controller, a teach pendant and software
- A data acquisition electronic (DAE) attached to the robot arm extension
- A dosimetric probe equipped with an optical surface detector system
- The electro-optical converter (EOC) performs the conversion between optical and electrical signals
- A measurement server performs the time critical tasks such as signal filtering, control of the robot operation and fast movement interrupts.
- A probe alignment unit which improves the accuracy of the probe positioning
- A computer operating Windows XP
- DASY software
- Remote control with teach pendant and additional circuitry for robot safety such as warning lamps, etc.
- The SAM twin phantom
- A device holder
- Tissue simulating liquid
- Dipole for evaluating the proper functioning of the system

Component details are described in the following sub-sections.

## 8.1 E-Field Probe

The SAR measurement is conducted with the dosimetric probe (manufactured by SPEAG). The probe is specially designed and calibrated for use in liquid with high permittivity. The dosimetric probe has special calibration in liquid at different frequency. This probe has a built in optical surface detection system to prevent from collision with phantom.

### ➤ E-Field Probe Specification <EX3DV4 Probe>

<b>Construction</b>	Symmetrical design with triangular core Built-in shielding against static charges PEEK enclosure material (resistant to organic solvents, e.g., DGBE)
<b>Frequency Directivity</b>	10 MHz to 6 GHz; Linearity: $\pm 0.2$ dB $\pm 0.3$ dB in HSL (rotation around probe axis) $\pm 0.5$ dB in tissue material (rotation normal to probe axis)
<b>Dynamic Range</b>	10 $\mu$ W/g to 100 mW/g; Linearity: $\pm 0.2$ dB (noise: typically $< 1$ $\mu$ W/g)
<b>Dimensions</b>	Overall length: 330 mm (Tip: 20mm) Tip diameter: 2.5 mm (Body: 12mm) Typical distance from probe tip to dipole centers: 1 mm



Fig. 8.2 Photo of E-Field Probe

### ➤ E-Field Probe Calibration

Each probe needs to be calibrated according to a dosimetric assessment procedure with accuracy better than  $\pm 10\%$ . The spherical isotropy shall be evaluated and within  $\pm 0.25$  dB. The sensitivity parameters (Norm X, Norm Y and Norm Z), the diode compression parameter (DCP) and the conversion factor (ConvF) of the probe are tested. The calibration data can be referred to appendix E of this report.

## 8.2 Data Acquisition Electronics (DAE)

The Data acquisition electronics (DAE) consists of a highly sensitive electrometer-grade preamplifier with auto-zeroing, a channel and gain-switching multiplexer, a fast 16 bit AD-converter and a command decoder and control logic unit. Transmission to the measurement server is accomplished through an optical downlink for data and status information as well as an optical uplink for commands and the clock. The input impedance of the DAE is 200 MOhm; the inputs are symmetrical and floating. Common mode rejection is above 80 dB.



Fig. 8.3 Photo of DAE

### 8.3 Robot

The SPEAG DASY system uses the high precision robots (DASY5: TX60XL) type from Stäubli SA (France). For the 6-axis controller system, the robot controller version (DASY5: CS8c) from Stäubli is used. The Stäubli robot series have many features that are important for our application:

- High precision (repeatability 0.02 mm)
- High reliability (industrial design)
- Low maintenance costs (virtually maintenance free due to direct drive gears; no belt drives)
- Jerk-free straight movements
- Low ELF interference (motor control fields shielded via the closed metallic construction shields)



Fig. 8.4 Photo of Robot

### 8.4 Measurement Server

The measurement server is based on a PC/104 CPU board with CPU (DASY 5: 400MHz, Intel Celeron), chip-disk (DASY5: 128 MB), RAM (DASY5: 128 MB). The necessary circuits for communication with the DAE electronic box, as well as the 16 bit AD converter system for optical detection and digital I/O interface are contained on the DASY I/O board, which is directly connected to the PC/104 bus of the CPU board. The measurement server performs all the real-time data evaluation for field measurements and surface detection, controls robot movements and handles safety operations.



Fig. 8.5 Photo of Server for DASY5

### 8.5 Light Beam Unit

The light beam switch allows automatic "tooling" of the probe. During the process, the actual position of the probe tip with respect to the robot arm is measured, as well as the probe length and the horizontal probe offset. The software then corrects all movements, such that the robot coordinates are valid for the probe tip.

The repeatability of this process is better than 0.1 mm. If a position has been taught with an aligned probe, the same position will be reached with another aligned probe within 0.1 mm, even if the other probe has different dimensions. During probe rotations, the probe tip will keep its actual position.



Fig. 8.6 Photo of Light Beam

## 8.6 Phantom

### <SAM Twin Phantom>

<b>Shell Thickness</b>	2 ± 0.2 mm; Center ear point: 6 ± 0.2 mm
<b>Filling Volume Dimensions</b>	Approx. 25 liters Length: 1000mm; Width: 500mm; Height: adjustable feet
<b>Measurement Areas</b>	Left Head, Right Head, Flat phantom



**Fig. 8.7 Photo of SAM Twin Phantom**

The bottom plate contains three pair of bolts for locking the device holder. The device holder positions are adjusted to the standard measurement positions in the three sections. A white cover is provided to tap the phantom during off-periods to prevent water evaporation and changes in the liquid parameters. On the phantom top, three reference markers are provided to identify the phantom position with respect to the robot.

### <ELI4 Phantom >

The ELI4 phantom is intended for compliance testing of handheld and body-mounted wireless devices in the frequency range of 30MHz to 6 GHz. ELI4 is fully compatible with the latest draft of the standard IEC 62209-2 and all known tissue simulating liquids.

ELI4 has been optimized regarding its performance and can be integrated into a SPEAG standard phantom table. A cover prevents evaporation of the liquid. Reference markings on the phantom allow installation of the complete setup, including all predefined phantom positions and measurement grids, by teaching three points. The phantom can be used with the following tissue simulating liquids:

- Water-sugar based liquids can be left permanently in the phantom. Always cover the liquid if the system is not in use; otherwise the parameters will change due to water evaporation.
- DGBE based liquids should be used with care. As DGBE is a softener for most plastics, the liquid should be taken out of the phantom and the phantom should be dried when the system is not in use (desirable at least once a week).
- Do not use other organic solvents without previously testing the phantom resistiveness.



**Fig.8.8 Photo of ELI4 Phantom**



## 8.7 Device Holder

### <Device Holder for SAM Twin Phantom>

The SAR in the phantom is approximately inversely proportional to the square of the distance between the source and the liquid surface. For a source at 5 mm distance, a positioning uncertainty of  $\pm 0.5$  mm would produce a SAR uncertainty of  $\pm 20$  %. Accurate device positioning is therefore crucial for accurate and repeatable measurements. The positions in which the devices must be measured are defined by the standards. The DASY device holder is designed to cope with different positions given in the standard. It has two scales for the device rotation (with respect to the body axis) and the device inclination (with respect to the line between the ear reference points). The rotation center for both scales is the ear reference point (ERP).

Thus the device needs no repositioning when changing the angles.

The DASY device holder is constructed of low-loss POM material having the following dielectric parameters: relative permittivity  $\epsilon = 3$  and loss tangent  $\delta = 0.02$ . The amount of dielectric material has been reduced in the closest vicinity of the device, since measurements have suggested that the influence of the clamp on the test results could thus be lowered.



Fig. 8.9 Photo of Device Holder

## 8.8 Data storage and Evaluation

### ➤ Data Storage

The DASY software stores the assessed data from the data acquisition electronics as raw data (in microvolt readings from the probe sensors), together with all the necessary software parameters for the data evaluation (probe calibration data, liquid parameters and device frequency and modulation data) in measurement files. The post-processing software evaluates the desired unit and format for output each time the data is visualized or exported. This allows verifications of the complete software setup even after the measurement and allows correction of erroneous parameter settings. For example, if a measurement has been performed with an incorrect crest factor parameter in the device setup, the parameter can be corrected afterwards and the data can be reevaluated.

The measured data can be visualized or exported in different units or formats, depending on the selected probe type (e.g., [V/m], [mW/g]). Some of these units are not available in certain situations or give meaningless results, e.g., a SAR-output in a non-lose media, will always be zero. Raw data can also be exported to perform the evaluation with other software packages.

### ➤ Data Evaluation

The DASY post-processing software (SEMCAD) automatically executes the following procedures to calculate the field units from the microvolt readings at the probe connector. The parameters used in the evaluation are stored in the configuration modules of the software:

<b>Probe Parameters:</b>	<ul style="list-style-type: none"> <li>- Sensitivity</li> <li>- Conversion</li> <li>- Diode compression point</li> </ul>	<ul style="list-style-type: none"> <li>Norm<sub>i</sub>, a<sub>i0</sub>, a<sub>i1</sub>, a<sub>i2</sub></li> <li>ConvF<sub>i</sub></li> <li>dcp<sub>i</sub></li> </ul>
<b>Device Parameters:</b>	<ul style="list-style-type: none"> <li>- Frequency</li> <li>- Crest</li> </ul>	<ul style="list-style-type: none"> <li>f</li> <li>cf</li> </ul>
<b>Media Parameters:</b>	<ul style="list-style-type: none"> <li>- Conductivity</li> <li>- Density</li> </ul>	<ul style="list-style-type: none"> <li>σ</li> <li>ρ</li> </ul>

These parameters must be set correctly in the software. They can be found in the component documents or they can be imported into the software from the configuration files issued for the DASY components. In the direct measuring mode of the multi-meter option, the parameters of the actual system setup are used. In the scan visualization and export modes, the parameters stored in the corresponding document files are used.

The first step of the evaluation is a linearization of the filtered input signal to account for the compression characteristics of the detector diode. The compensation depends on the input signal, the diode type and the DC-transmission factor from the diode to the evaluation electronics. If the exciting field is pulsed, the crest factor of the signal must be known to correctly compensate for peak power.



The formula for each channel can be given as:

$$V_i = U_i + U_i^2 \cdot \frac{cf}{dcp_i}$$

With  $V_i$  = compensated signal of channel i, (i = x, y, z)  
 $U_i$  = input signal of channel i, (i = x, y, z)  
 cf = crest factor of exciting field (DASY parameter)  
 $dcp_i$  = diode compression point (DASY parameter)

From the compensated input signals, the primary field data for each channel can be evaluated:

$$\text{E- Field Probes: } E_i = \sqrt{\frac{V_i}{\text{Norm}_i \cdot \text{ConvF}}}$$

$$\text{H-Field Probes: } H_i = \sqrt{V_i} \cdot \frac{a_{i0} + a_{i1}f + a_{i2}f^2}{f}$$

With  $V_i$  = compensated signal of channel i, (i = x, y, z)  
 $\text{Norm}_i$  = sensor sensitivity of channel i, (i = x, y, z),  $\mu\text{V}/(\text{V/m})^2$   
 ConvF = sensitivity enhancement in solution  
 $a_{ij}$  = sensor sensitivity factors for H-field probes  
 f = carrier frequency (GHz)  
 $E_i$  = electric field strength of channel i in V/m  
 $H_i$  = magnetic field strength of channel i in A/m

The RSS value of the field components gives the total field strength (Hermitian magnitude):

$$E_{tot} = \sqrt{E_x^2 + E_y^2 + E_z^2}$$

The primary field data are used to calculate the derived field units.

$$SAR = E_{tot}^2 \cdot \frac{\sigma}{\rho \cdot 1000}$$

With SAR = local specific absorption rate in mW/g  
 $E_{tot}$  = total field strength in V/m  
 $\sigma$  = conductivity in (mho/m) or (Siemens/m)  
 $\rho$  = equipment tissue density in  $\text{g/cm}^3$

Note that the density is set to 1, to account for actual head tissue density rather than the density of the tissue simulating liquid.

## 8.9 Test Equipment List

Manufacturer	Equipment Description	Model	S/N	Cal. Information	
				Last Cal.	Due Date
SPEAG	750MHz System Validation Kit	D750V3	1118	06.10.2014	06.09.2017
SPEAG	835MHz System Validation Kit	D835V2	4d154	06.06.2013	06.05.2016
SPEAG	1750MHz System Validation Kit	D1750V2	1021	08.02.2013	08.01.2016
SPEAG	1900MHz System Validation Kit	D1900V2	5d175	06.10.2013	06.09.2016
SPEAG	2450MHz System Validation Kit	D2450V2	910	06.07.2013	06.06.2016
SPEAG	2600MHz System Validation Kit	D2600V2	1114	09.21.2015	09.20.2018
SPEAG	Data Acquisition Electronics	DAE4	1373	07.23.2015	07.22.2016
SPEAG	Dosimetric E-Field Probe	EX3DV4	3924	07.10.2015	07.09.2016
SPEAG	Phantom	Twin Phantom	1765	N.C.R	
SPEAG	Phantom	ELI V5.0	1208	N.C.R	
SPEAG	Phone Positioner	N/A	N/A	N.C.R	
Stäubli	Robot	TX60L	F13/5P6VB1/A/01	N.C.R	
R&S	Universal Radio Communication Tester	CMU200	112477	03.28.2015	03.28.2016
R&S	Universal Radio Communication Tester	CMU200	117042	03.28.2015	03.28.2016
HP	Network Analyzer	8753D	1000596	03.28.2015	03.28.2016
Agilent	EPM Series Power Meter	E4418B	GB39512692	03.28.2015	03.28.2016
Agilent	Power Sensor	8481A	MY41090341	03.28.2015	03.28.2016
R&S	Signal Generator	SMR20	835457/016	03.28.2015	03.28.2016
R&S	Signal Generator	SMX	10080050	03.28.2015	03.28.2016
Huber Suhner	RF Cable	SUCOFLEX	12341	See Note 3	
Huber Suhner	RF Cable	SUCOFLEX	17268	See Note 3	
Huber Suhner	RF Cable	SUCOFLEX	2080	See Note 3	
Weinschel	Attenuator	23-3-34	BL5513	See Note 3	
Anritsu	Directional Coupler	MP654A	100217491	See Note 3	
SPEAG	Dielectric Assessment Kit	3.5 Probe	1119	See Note 4	
Mini-circuits	Power amplifier	ZHL-42W	SC609401309	See Note 5	

**Note:**

1. The calibration certificate of DASY can be referred to appendix C of this report.
2. Referring to KDB 865664 D01v01r03, the dipole calibration interval can be extended to 3 years with justification. The dipoles are also not physically damaged, or repaired during the interval.
3. The Insertion Loss calibration of Dual Directional Coupler and Attenuator were characterized via the network analyzer and compensated during system check.
4. The dielectric probe kit was calibrated via the network analyzer, with the specified procedure (calibrated in pure water) and calibration kit (standard) short circuit, before the dielectric measurement. The specific procedure and calibration kit are provided by Speag.
5. In system check we need to monitor the level on the power meter, and adjust the power amplifier level to have precise power level to the dipole; the measured SAR will be normalized to 1 W input power according to the ratio of 1 W to the input power to the dipole. For system check, the calibration of the power amplifier is deemed not critically required for correct measurement; the power meter is critical and we do have calibration for it
6. Attenuator insertion loss is calibrated by the network Analyzer, which the calibration is valid, before system check.
7. N.C.R means No Calibration Requirement.

## 9 Tissue Simulating Liquids

For the measurement of the field distribution inside the SAM phantom with DASY, the phantom must be filled with around 25 liters of homogeneous body tissue simulating liquid. For head SAR testing, the liquid height from the ear reference point (ERP) of the phantom to the liquid top surface is larger than 15 cm, which is shown in Fig. 9.1, for body SAR testing, the liquid height from the center of the flat phantom to liquid top surface is larger than 15 cm, which is shown in Fig. 9.2.

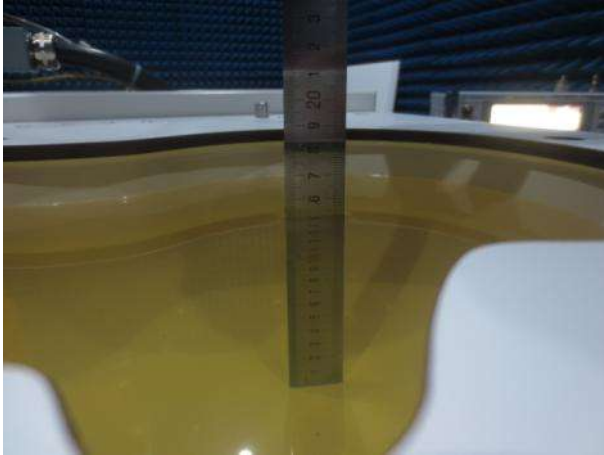

Fig. 9.1 Photo of Liquid Height for Head SAR



Fig. 9.2 Photo of Liquid Height for Body SAR

The relative permittivity and conductivity of the tissue material should be within  $\pm 5\%$  of the values given in the table below recommended by the FCC OET 65 supplement C and RSS 102 Issue 4.

Target Frequency (MHz)	Head		Body	
	$\epsilon_r$	$\sigma$ (S/m)	$\epsilon_r$	$\sigma$ (S/m)
150	52.3	0.76	61.9	0.80
300	45.3	0.87	58.2	0.92
450	43.5	0.87	56.7	0.94
835	41.5	0.90	55.2	0.97
900	41.5	0.97	55.0	1.05
915	41.5	0.98	55.0	1.06
1450	40.5	1.20	54.0	1.30
1610	40.3	1.29	53.8	1.40
1800-2000	40.0	1.40	53.3	1.52
2450	39.2	1.80	52.7	1.95
3000	38.5	2.40	52.0	2.73
5800	35.3	5.27	48.2	6.00

(  $\epsilon_r$  = relative permittivity,  $\sigma$  = conductivity and  $\rho = 1000 \text{ kg/m}^3$  )

The dielectric parameters of liquids were verified prior to the SAR evaluation using a Speag Dielectric Probe Kit and an Agilent Network Analyzer.

The following table shows the measuring results for simulating liquid.

Frequency (MHz)	Liquid Type	Liquid Temp. (°C)	Conductivity ( $\sigma$ )	Permittivity ( $\epsilon_r$ )	Conductivity Target( $\sigma$ )	Permittivity Target( $\epsilon_r$ )	Delta ( $\sigma$ )%	Delta ( $\epsilon_r$ )%	Limit (%)	Date (mm/dd/yy)
750	Body	21.5	0.95	56.16	0.96	55.5	-1.04	1.19	±5	11.25.2015
835	Body	21.6	0.99	54.98	0.97	55.2	2.06	-0.40	±5	11.19.2015
1750	Body	21.7	1.51	54.16	1.49	53.4	1.34	1.42	±5	11.21.2015
1900	Body	21.8	1.50	52.93	1.52	53.3	-1.32	-0.69	±5	11.23.2015
2450	Body	21.7	1.92	53.06	1.95	52.7	-1.54	0.68	±5	12.18.2015
2600	Body	21.03	2.13	52.09	2.16	52.5	-1.39	-0.78	±5	12.14.2015

## 10 SAR System Verification

Each DASY system is equipped with one or more system validation kits. These units, together with the predefined measurement procedures within the DASY software, enable the user to conduct the system performance check and system validation. System validation kit includes a dipole, tripod holder to fix it underneath the flat phantom and a corresponding distance holder.

### ➤ Purpose of System Performance check

The system performance check verifies that the system operates within its specifications. System and operator errors can be detected and corrected. It is recommended that the system performance check be performed prior to any usage of the system in order to guarantee reproducible results. The system performance check uses normal SAR measurements in a simplified setup with a well characterized source. This setup was selected to give a high sensitivity to all parameters that might fail or vary over time. The system check does not intend to replace the calibration of the components, but indicates situations where the system uncertainty is exceeded due to drift or failure.

### ➤ System Setup

In the simplified setup for system evaluation, the EUT is replaced by a calibrated dipole and the power source is replaced by a continuous wave that comes from a signal generator. The calibrated dipole must be placed beneath the flat phantom section of the SAM twin phantom with the correct distance holder. The distance holder should touch the phantom surface with a light pressure at the reference marking and be oriented parallel to the long side of the phantom. The equipment setup is shown below:

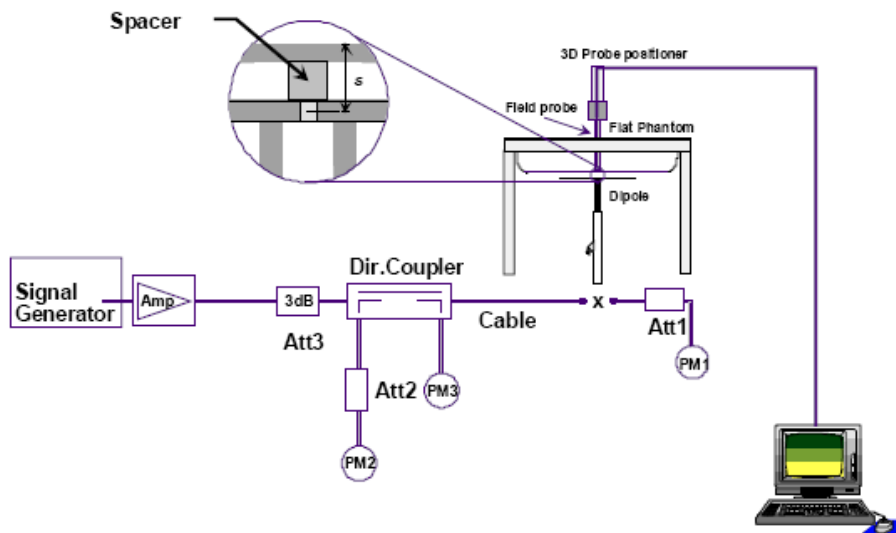

Fig.10.1 System Verification Setup Diagram



Fig.10.2 Photo of Dipole setup

➤ **System Verification Results**

Comparing to the original SAR value provided by SPEAG, the verification data should be within its specification of 10%. The table as below indicates the system performance check can meet the variation criterion and the plots can be referred to Appendix C of this report.

Date (mm/dd/yy)	Frequency (MHz)	Liquid Type	Power fed onto dipole (mW)	Measured 1g SAR (W/kg)	Normalized to 250 mW 1g SAR (W/kg)	250 mW Target 1g SAR (W/kg)	Deviation (%)
11.25.2015	750	Body	10	0.085	2.13	2.19	-2.74
11.19.2015	835	Body	10	0.096	2.40	2.44	-1.64
11.21.2015	1750	Body	10	0.390	9.75	9.52	2.42
11.23.2015	1900	Body	10	0.401	10.03	10.1	-0.69
12.18.2015	2450	Body	10	0.522	13.05	13.2	-1.14
12.14.2015	2600	Body	25	1.360	13.6	14.4	-5.56

## 11 EUT Testing Position

This EUT was tested in ten different positions. They are right cheek/right tilted/left cheek/left tilted for head, Front/Back/Right Side/Top Side/Bottom Side of the EUT with phantom 1 cm gap, as illustrated below, please refer to Appendix B for the test setup photos.

### 11.1 Handset Reference Points

- The vertical centreline passes through two points on the front side of the handset – the midpoint of the width  $w_t$  of the handset at the level of the acoustic output, and the midpoint of the width  $w_b$  of the bottom of the handset.
- The horizontal line is perpendicular to the vertical centreline and passes the center of the acoustic output. The horizontal line is also tangential to the handset at point A.
- The two lines intersect at point A. Note that for many handsets, point A coincides with the center of the acoustic output; however, the acoustic output may be located elsewhere on the horizontal line. Also note that the vertical centreline is not necessarily parallel to the front face of the handset, especially for clamshell handsets, handsets with flip covers, and other irregularly shaped handsets.



Fig.11.1 Illustration for Front, Back and Side of SAM Phantom

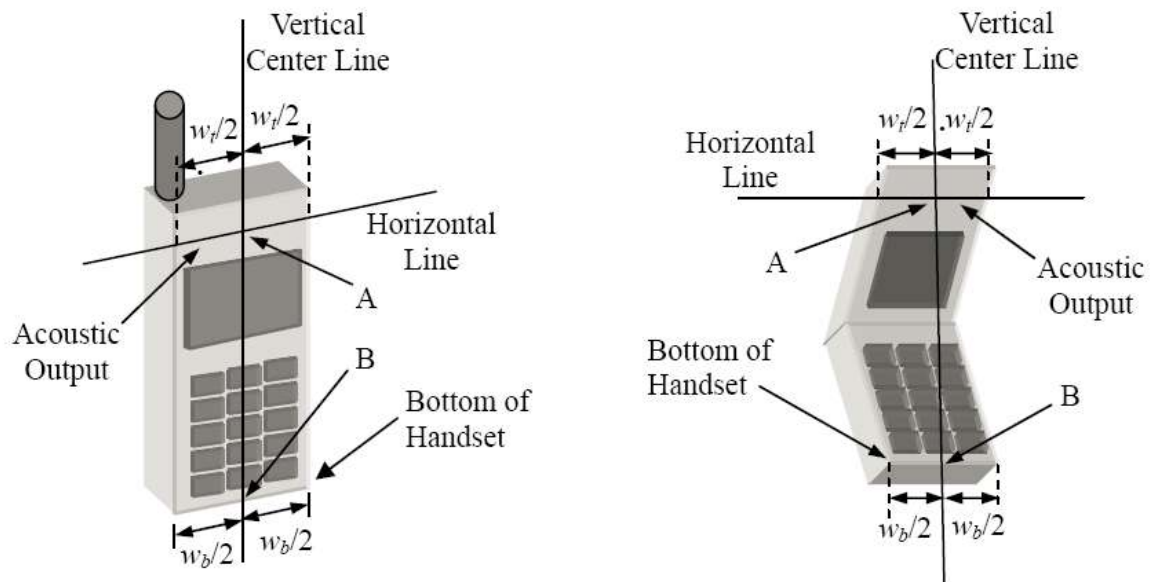

Fig. 11.2 Illustration for Handset Vertical and Horizontal Reference Lines



## 11.2 Positioning for Cheek / Touch

- To position the device with the vertical center line of the body of the device and the horizontal line crossing the center piece in a plane parallel to the sagittal plane of the phantom. While maintaining the device in this plane, align the vertical center line with the reference plane containing the three ear and mouth reference point (M: Mouth, RE: Right Ear and LE: Left Ear) and align the center of the ear piece with the line RE-LE.
- To move the device towards the phantom with the ear piece aligned with the line LE-RE until the phone touched the ear. While maintaining the device in the reference plane and maintaining the phone contact with the ear, move the bottom of the phone until any point on the front side is in contact with the cheek of the phantom or until contact with the ear is lost (see below figure)



Fig. 11.3 Illustration for Cheek Position

## 11.3 Positioning for Ear / 15° Tilt

- To position the device in the “cheek” position described above.
- While maintaining the device the reference plane described above and pivoting against the ear, moves it outward away from the mouth by an angle of 15 degrees or until contact with the ear is lost (see figure below).



Fig.11.4 Illustration for Tilted Position



## 11.4 SAR Evaluations near the Mouth/Jaw Regions of the SAM Phantom

Antennas located near the bottom of a phone may require SAR measurements around the mouth and jaw regions of the SAM head phantom. This typically applies to clam-shell style phones that are generally longer in the unfolded normal use positions or to certain older style long rectangular phones.

Under these circumstances, the following procedures apply, adopted from the FCC guidance on SAR handsets document FCC KDB Publication 648474 D04v01r02. The SAR required in these regions of SAM should be measured using a flat phantom. The phone should be positioned with a separation distance of 4 mm between the ear reference point (ERP) and the outer surface of the flat phantom shell. While maintaining this distance at the ERP location, the low (bottom) edge of the phone should be lowered from the phantom to establish the same separation distance between the peak SAR locations identified by the truncated partial SAR distribution measured with the SAM phantom. The distance from the peak SAR location to the phone is determined by the straight line passing perpendicularly through the phantom surface. When it is not feasible to maintain 4 mm separation at the ERP while also establishing the required separation at the peak SAR location, the top edge of the phone will be allowed to touch the phantom with a separation < 4 mm at the ERP. The phone should not be tilted to the left or right while placed in this inclined position to the flat phantom.

## 11.5 Body Worn Accessory Configurations

- To position the device parallel to the phantom surface with either keypad up or down.
- To adjust the device parallel to the flat phantom.
- To adjust the distance between the device surface and the flat phantom to 1.5 cm or holster surface and the flat phantom to 0 cm.



Fig.11.5 Illustration for Body Worn Position

## 11.6 Wireless Router (Hotspot) Configurations

Some battery-operated handsets have the capability to transmit and receive internet connectivity through simultaneous transmission of WIFI in conjunction with a separate licensed transmitter. The FCC has provided guidance in KDB Publication 941225 D06 where SAR test considerations for handsets (L x W ≥ 9 cm x 5 cm) are based on a composite test separation distance of 10 mm from the front, back and edges of the device with antennas 2.5 cm or closer to the edge of the device, determined from general mixed use conditions for this type of devices. Since the hotspot SAR results may overlap with the body-worn accessory SAR requirements, the more conservative configurations can be considered, thus excluding some body-worn accessory SAR tests.

When the user enables the personal wireless router functions for the handset, actual operations include simultaneous transmission of both the WIFI transmitter and another licensed transmitter. Both transmitters often do not transmit at the same transmitting frequency and thus cannot be evaluated for SAR under actual use conditions. Therefore, SAR must be evaluated for each frequency transmission and mode separately and summed with the WIFI transmitter according to KDB 648474 publication procedures. The “Portable Hotspot” feature on the handset was NOT activated, to ensure the SAR measurements were evaluated for a single transmission frequency RF signal.

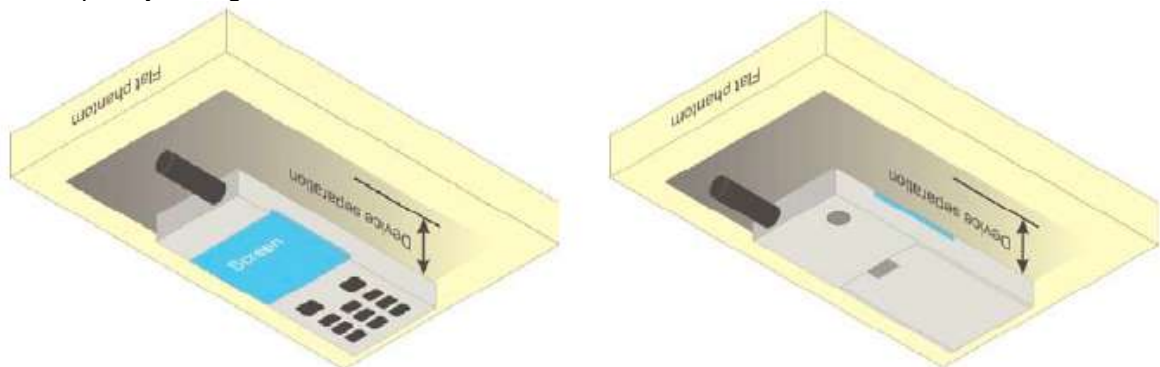

Fig.11.6 Illustration for Hotspot Position

## 12 Measurement Procedures

The measurement procedures are as follows:

<Conducted power measurement>

- For WWAN power measurement, use base station simulator to configure EUT WWAN transmission in conducted connection with RF cable, at maximum power in each supported wireless interface and frequency band.
- Read the WWAN RF power level from the base station simulator.
- For WLAN/BT power measurement, use engineering software to configure EUT WLAN/BT continuously transmission, at maximum RF power in each supported wireless interface and frequency band.
- Connect EUT RF port through RF cable to the power meter or spectrum analyzer, and measure WLAN/BT output power.

<Radiated power measurement>

- Use base station simulator to configure EUT WWAN transmission in radiated connection, and engineering software to configure EUT WLAN/BT continuously transmission, at maximum RF power, in the highest power channel.
- Place the EUT in positions as Appendix B demonstrates.
- Set scan area, grid size and other setting on the DASY software.
- Measure SAR results for the highest power channel on each testing position.
- Find out the largest SAR result on these testing positions of each band.
- Measure SAR results for other channels in worst SAR testing position if the Reported SAR or highest power channel is larger than 0.8 W/kg.

According to the test standard, the recommended procedure for assessing the peak spatial-average SAR value consists of the following steps:

- Power reference measurement
- Area scan
- Zoom scan
- Power drift measurement

### 12.1 Spatial Peak SAR Evaluation

The procedure for spatial peak SAR evaluation has been implemented according to the test standard. It can be conducted for 1g and 10g, as well as for user-specific masses. The DASY software includes all numerical procedures necessary to evaluate the spatial peak SAR value.

The base for the evaluation is a “cube” measurement. The measured volume must include the 1g and 10 g cubes with the highest averaged SAR values. For that purpose, the center of the measured volume is aligned to the interpolated peak SAR value of a previously performed area scan.

The entire evaluation of the spatial peak values is performed within the post-processing engine (SEMCAD). The system always gives the maximum values for 1g and 10g cubes. The algorithm to find the cube with highest averaged SAR is divided into the following stages:

- Extraction of the measured data (grid and values) from the Zoom Scan.
- Calculation of the SAR value at every measurement point based on all stored data (A/D values and measurement parameters).
- Generation of a high-resolution mesh within the measured volume.
- Interpolation of all measured values from the measurement grid to the high-resolution grid
- Extrapolation of the entire 3-D field distribution to the phantom surface over the distance from sensor to surface
- Calculation of the averaged SAR within masses of 1g and 10g.

## 12.2 Power Reference Measurement

The Power Reference Measurement and Power Drift Measurement are for monitoring the power drift of the device under test in the batch process. The minimum distance of probe sensors to surface determines the closest measurement point to phantom surface. This distance cannot be smaller than the distance of sensor calibration points to probe tip as defined in the probe properties.

## 12.3 Area & Zoom Scan Procedures

First Area Scan is used to locate the approximate location(s) of the local peak SAR value(s). The measurement grid within an Area Scan is defined by the grid extent, grid step size and grid offset. Next, in order to determine the EM field distribution in a three-dimensional spatial extension, Zoom Scan is required. The Zoom Scan is performed around the highest E-field value to determine the averaged SAR-distribution over 10g. Area scan and zoom scan resolution setting follows KDB 865664 D01v01r03 quoted below.

		$\leq 3$ GHz	$> 3$ GHz	
Maximum distance from closest measurement point (geometric center of probe sensors) to phantom surface		$5 \pm 1$ mm	$\frac{1}{2} \cdot \delta \cdot \ln(2) \pm 0.5$ mm	
Maximum probe angle from probe axis to phantom surface normal at the measurement location		$30^\circ \pm 1^\circ$	$20^\circ \pm 1^\circ$	
Maximum area scan spatial resolution: $\Delta x_{Area}$ , $\Delta y_{Area}$		$\leq 2$ GHz: $\leq 15$ mm 2 – 3 GHz: $\leq 12$ mm	3 – 4 GHz: $\leq 12$ mm 4 – 6 GHz: $\leq 10$ mm	
		When the x or y dimension of the test device, in the measurement plane orientation, is smaller than the above, the measurement resolution must be $\leq$ the corresponding x or y dimension of the test device with at least one measurement point on the test device.		
Maximum zoom scan spatial resolution: $\Delta x_{Zoom}$ , $\Delta y_{Zoom}$		$\leq 2$ GHz: $\leq 8$ mm 2 – 3 GHz: $\leq 5$ mm*	3 – 4 GHz: $\leq 5$ mm* 4 – 6 GHz: $\leq 4$ mm*	
Maximum zoom scan spatial resolution, normal to phantom surface	uniform grid: $\Delta z_{Zoom}(n)$	$\leq 5$ mm	3 – 4 GHz: $\leq 4$ mm 4 – 5 GHz: $\leq 3$ mm 5 – 6 GHz: $\leq 2$ mm	
	graded grid	$\Delta z_{Zoom}(1)$ : between 1 <sup>st</sup> two points closest to phantom surface	$\leq 4$ mm	3 – 4 GHz: $\leq 3$ mm 4 – 5 GHz: $\leq 2.5$ mm 5 – 6 GHz: $\leq 2$ mm
		$\Delta z_{Zoom}(n>1)$ : between subsequent points	$\leq 1.5 \cdot \Delta z_{Zoom}(n-1)$	
Minimum zoom scan volume	x, y, z	$\geq 30$ mm	3 – 4 GHz: $\geq 28$ mm 4 – 5 GHz: $\geq 25$ mm 5 – 6 GHz: $\geq 22$ mm	
Note: $\delta$ is the penetration depth of a plane-wave at normal incidence to the tissue medium; see draft standard IEEE P1528-2011 for details. * When zoom scan is required and the <i>reported</i> SAR from the <i>area scan based 1-g SAR estimation</i> procedures of KDB 447498 is $\leq 1.4$ W/kg, $\leq 8$ mm, $\leq 7$ mm and $\leq 5$ mm zoom scan resolution may be applied, respectively, for 2 GHz to 3 GHz, 3 GHz to 4 GHz and 4 GHz to 6 GHz.				

## **12.4 Volume Scan Procedures**

The volume scan is used for assess overlapping SAR distributions for antennas transmitting in different frequency bands. It is equivalent to an oversized zoom scan used in standalone measurements. The measurement volume will be used to enclose all the simultaneous transmitting antennas. For antennas transmitting simultaneously in different frequency bands, the volume scan is measured separately in each frequency band. In order to sum correctly to compute the 1g aggregate SAR, the EUT remain in the same test position for all measurements and all volume scan use the same spatial resolution and grid spacing. When all volume scan were completed, the software, SEMCAD post-processor scan combine and subsequently superpose these measurement data to calculating the multiband SAR.

## **12.5 SAR Averaged Methods**

In DASYS, the interpolation and extrapolation are both based on the modified Quadratic Shepard's method. The interpolation scheme combines a least-square fitted function method and a weighted average method which are the two basic types of computational interpolation and approximation.

Extrapolation routines are used to obtain SAR values between the lowest measurement points and the inner phantom surface. The extrapolation distance is determined by the surface detection distance and the probe sensor offset. The uncertainty increases with the extrapolation distance. To keep the uncertainty within 1% for the 1g and 10g cubes, the extrapolation distance should not be larger than 5 mm.

## **12.6 Power Drift Monitoring**

All SAR testing is under the EUT install full charged battery and transmit maximum output power. In DASYS measurement software, the power reference measurement and power drift measurement procedures are used for monitoring the power drift of EUT during SAR test. Both these procedures measure the field at a specified reference position before and after the SAR testing. The software will calculate the field difference in dB. If the power drifts more than 5%, the SAR will be retested.

## 13 Conducted RF Output Power

### 13.1 GSM Conducted Power

Band: GSM 850 Channel	Burst Average Power (dBm)			Frame-Average Power(dBm)		
	128	190	251	128	190	251
Frequency (MHz)	824.2	836.6	848.8	824.2	836.6	848.8
GSM (GMSK, Voice)	32.20	32.20	<b>32.29</b>	23.17	23.17	23.26
GPRS (GMSK, 1 TX slot)	32.27	32.17	32.26	23.24	23.14	23.23
GPRS (GMSK, 2 TX slots)	32.24	32.23	32.26	26.22	26.21	26.24
GPRS (GMSK, 3 TX slots)	31.01	30.96	<b>31.10</b>	26.75	26.70	<b>26.84</b>
GPRS (GMSK, 4 TX slots)	29.12	29.08	29.16	26.11	26.07	26.15
EGPRS (8PSK, 1 TX slot)	26.10	26.15	26.13	17.07	17.12	17.10
EGPRS (8PSK, 2 TX slots)	24.51	24.73	24.52	18.49	18.71	18.50
EGPRS (8PSK, 3 TX slots)	23.65	23.71	23.58	19.39	19.45	19.32
EGPRS (8PSK, 4 TX slots)	22.58	22.43	22.37	19.57	19.42	19.36

**Remark:**

- The frame-averaged power is linearly reported the maximum burst averaged power over 8 time slots. The calculated method are shown as below:  
The duty cycle "x" of different time slots as below:  
1 TX slot is 1/8, 2 TX slots is 2/8, 3 TX slots is 3/8 and 4 TX slots is 4/8  
Based on the calculation formula:  
Frame-averaged power = Burst averaged power + 10 log (x)  
So,  
Frame-averaged power (1 TX slot) = Burst averaged power (1 TX slot) – 9.03  
Frame-averaged power (2 TX slots) = Burst averaged power (2 TX slots) – 6.02  
Frame-averaged power (3 TX slots) = Burst averaged power (3 TX slots) – 4.26  
Frame-averaged power (4 TX slots) = Burst averaged power (4 TX slots) – 3.01
- CS1 coding scheme was used in GPRS conducted power measurements and SAR testing, MCS5 coding scheme was used in EGPRS conducted power measurements and SAR testing (if necessary).

**Note:**

- For Head SAR testing, GSM Voice mode should be evaluated, therefore the EUT was set in GSM 850 Voice mode.
- For Body worn SAR testing, GSM Voice mode should be evaluated, therefore the EUT was set in GSM 850 Voice mode.
- For Hotspot mode SAR testing, GPRS and EGPRS mode should be evaluated, therefore the EUT was set in GPRS 3 TX slots mode due to the highest frame-averaged power.
- Per KDB447498 D01v05r02, the maximum output power channel is used for SAR testing and for further SAR test reduction.
- The EUT do not support DTM and VoIP function.



Band: GSM 1900 Channel	Burst Average Power (dBm)			Frame-Average Power(dBm)		
	512	661	810	512	661	810
Frequency (MHz)	1850.2	1880.0	1909.8	1850.2	1880.0	1909.8
GSM (GMSK, Voice)	<b>28.64</b>	28.39	28.49	19.61	19.36	19.46
GPRS (GMSK, 1 TX slot)	28.75	28.50	28.55	19.72	19.47	19.52
GPRS (GMSK, 2 TX slots)	28.71	28.52	28.56	22.69	22.50	22.54
GPRS (GMSK, 3 TX slots)	<b>27.33</b>	27.20	27.25	<b>23.07</b>	22.94	22.99
GPRS (GMSK, 4 TX slots)	25.29	25.25	25.27	22.28	22.24	22.26
EGPRS (8PSK, 1 TX slot)	24.64	24.55	24.54	15.61	15.52	15.51
EGPRS (8PSK, 2 TX slots)	22.80	22.64	22.75	16.78	16.62	16.73
EGPRS (8PSK, 3 TX slots)	21.49	21.39	21.23	17.23	17.13	16.97
EGPRS (8PSK, 4 TX slots)	19.11	19.07	19.08	16.10	16.06	16.07

**Remark:**

- The frame-averaged power is linearly reported the maximum burst averaged power over 8 time slots. The calculated method are shown as below:  
The duty cycle "x" of different time slots as below:  
1 TX slot is 1/8, 2 TX slots is 2/8, 3 TX slots is 3/8 and 4 TX slots is 4/8  
Based on the calculation formula:  
Frame-averaged power = Burst averaged power + 10 log (x)  
So,  
Frame-averaged power (1 TX slot) = Burst averaged power (1 TX slot) – 9.03  
Frame-averaged power (2 TX slots) = Burst averaged power (2 TX slots) – 6.02  
Frame-averaged power (3 TX slots) = Burst averaged power (3 TX slots) – 4.26  
Frame-averaged power (4 TX slots) = Burst averaged power (4 TX slots) – 3.01
- CS1 coding scheme was used in GPRS conducted power measurements and SAR testing, MCS5 coding scheme was used in EGPRS conducted power measurements and SAR testing (if necessary).

**Note:**

- For Head SAR testing, GSM Voice mode should be evaluated, therefore the EUT was set in GSM 1900 Voice mode.
- For Body worn SAR testing, GSM Voice mode should be evaluated, therefore the EUT was set in GSM Voice 1900 mode.
- For Hotspot mode SAR testing, GPRS and EGPRS mode should be evaluated, therefore the EUT was set in GPRS 3 TX slots mode due to the highest frame-averaged power.
- Per KDB447498 D01v05r02, the maximum output power channel is used for SAR testing and for further SAR test reduction.
- The EUT do not support DTM and VoIP function.

## 13.2 WCDMA Conducted Power

The following tests were conducted according to the test requirements outlines in 3GPP TS 34.121 specification. A summary of these settings are illustrated below:

### HSDPA Setup Configuration:

- a. The EUT was connected to Base Station Rohde & Schwarz CMU200 referred to the Setup Configuration.
- b. The RF path losses were compensated into the measurements.
- c. A call was established between EUT and Base Station with following setting:
  - i. Set Gain Factors ( $\beta_c$  and  $\beta_d$ ) and parameters were set according to each
  - ii. Specific sub-test in the following table, C10.1.4, quoted from the TS 34.121
  - iii. Set RMC 12.2kbps + HSDPA mode.
  - iv. Set Cell Power = -86 dBm
  - v. Set HS-DSCH Configuration Type to FRC (H-set 1, QPSK)
  - vi. Select HSDPA Uplink Parameters
  - vii. Set Delta ACK, Delta NACK and Delta CQI = 8
  - viii. Set Ack-Nack Repetition Factor to 3
  - ix. Set CQI Feedback Cycle (k) to 4 ms
  - x. Set CQI Repetition Factor to 2
  - xi. Power Ctrl Mode = All Up bits
- d. The transmitted maximum output power was recorded.

Table 1

Sub-test	$\beta_c$	$\beta_d$	$\beta_d$ (SF)	$\beta_c/\beta_d$	$\beta_{hs}^{(1)}$	CM (dB) <sup>(2)</sup>
1	2/15	15/15	64	2/15	4/15	0.0
2	12/15 <sup>(3)</sup>	15/15 <sup>(3)</sup>	64	12/15 <sup>(3)</sup>	24/15	1.0
3	15/15	8/15	64	15/8	30/15	1.5
4	15/15	4/15	64	15/4	30/15	1.5

Note 1:  $\Delta_{ACK}, \Delta_{NACK}$  and  $\Delta_{CQI} = 8 \Leftrightarrow A_{hs} = \beta_{hs}/\beta_c = 30/15 \Leftrightarrow \beta_{hs} = 30/15 * \beta_c$

Note 2: CM = 1 for  $\beta_c/\beta_d = 12/15, \beta_{hs}/\beta_c = 24/15$ .

Note 3: For subtest 2 the  $\beta_c/\beta_d$  ratio of 12/15 for the TFC during the measurement period (TF1, TF0) is achieved by setting the signaled gain factors for the reference TFC (TF1, TF1) to  $\beta_c = 11/15$  and  $\beta_d = 15/15$ .

### HSDPA Sub-test setup configuration



**HSUPA Setup Configuration:**

- a. The EUT was connected to Base Station Rohde & Schwarz CMU200 referred to the Setup Configuration.
- b. The RF path losses were compensated into the measurements.
- c. A call was established between EUT and Base Station with following setting \* :
  - i. Call Configs = 5.2B, 5.9B, 5.10B, and 5.13.2B with QPSK
  - ii. Set the Gain Factors ( $\beta_c$  and  $\beta_d$ ) and parameters (AG Index) were set according to each specific sub-test in the following table, C11.1.3, quoted from the TS 34.121
  - iii. Set Cell Power = -86 dBm
  - iv. Set Channel Type = 12.2k + HSPA
  - v. Set UE Target Power
  - vi. Power Ctrl Mode= Alternating bits
  - vii. Set and observe the E-TFCI
  - viii. Confirm that E-TFCI is equal to the target E-TFCI of 75 for sub-test 1, and other subtest's E-TFCI
- d. The transmitted maximum output power was recorded.

**Table 2**

Sub-test	$\beta_c$	$\beta_d$	$\beta_d$ (SF)	$\beta_c/\beta_d$	$\beta_{hs}^{(1)}$	$\beta_{ec}$	$\beta_{ed}$	$\beta_{ed}$ (SF)	$\beta_{ed}$ (codes)	CM <sup>(2)</sup> (dB)	MPR (dB)	AG <sup>(4)</sup> Index	E-TFCI
1	11/15 <sup>(3)</sup>	15/15 <sup>(3)</sup>	64	11/15 <sup>(3)</sup>	22/15	209/225	1039/225	4	1	1.0	0.0	20	75
2	6/15	15/15	64	6/15	12/15	12/15	94/75	4	1	3.0	2.0	12	67
3	15/15	9/15	64	15/9	30/15	30/15	$\beta_{ed1}: 47/15$ $\beta_{ed2}: 47/15$	4	2	2.0	1.0	15	92
4	2/15	15/15	64	2/15	4/15	2/15	56/75	4	1	3.0	2.0	17	71
5	15/15 <sup>(4)</sup>	15/15 <sup>(4)</sup>	64	15/15 <sup>(4)</sup>	30/15	24/15	134/15	4	1	1.0	0.0	21	81

Note 1:  $\Delta_{ACK}, \Delta_{NACK}$  and  $\Delta_{CQI} = 8 \Leftrightarrow A_{hs} = \beta_{hs}/\beta_c = 30/15 \Leftrightarrow \beta_{hs} = 30/15 * \beta_c$ .

Note 2: CM = 1 for  $\beta_c/\beta_d = 12/15, \beta_{hs}/\beta_c = 24/15$ . For all other combinations of DPDCH, DPCCH, HS-DPCCH, E-DPDCH and E-DPCCH the MPR is based on the relative CM difference.

Note 3: For subtest 1 the  $\beta_c/\beta_d$  ratio of 11/15 for the TFC during the measurement period (TF1, TF0) is achieved by setting the signaled gain factors for the reference TFC (TF1, TF1) to  $\beta_c = 10/15$  and  $\beta_d = 15/15$ .

Note 4: For subtest 5 the  $\beta_c/\beta_d$  ratio of 15/15 for the TFC during the measurement period (TF1, TF0) is achieved by setting the signaled gain factors for the reference TFC (TF1, TF1) to  $\beta_c = 14/15$  and  $\beta_d = 15/15$ .

Note 5: Testing UE using E-DPDCH Physical Layer category 1 Sub-test 3 is not required according to TS 25.306 Table 5.1g.

Note 6:  $\beta_{ed}$  cannot be set directly; it is set by Absolute Grant Value.

**HSUPA Sub-test setup configuration**

**WCDMA Conducted Power:**

Band	WCDMA Average power (dBm)					
	WCDMA Band V			WCDMA Band II		
Channel	4132	4183	4233	9262	9400	9538
Frequency (MHz)	826.4	836.6	846.6	1852.4	1880.0	1907.6
AMR 12.2 kbps	23.95	24.41	24.33	21.91	22.19	22.29
RMC 12.2 kbps	23.88	<b>24.39</b>	24.27	21.78	22.14	<b>22.27</b>
HSDPA Sub-test 1	24.02	24.49	24.33	21.88	22.22	22.42
HSDPA Sub-test 2	23.47	24.04	23.79	21.52	21.69	21.83
HSDPA Sub-test 3	21.75	22.47	22.34	19.74	20.20	20.09
HSDPA Sub-test 4	21.24	21.89	21.45	19.60	20.02	19.76
HSUPA Sub-test 1	23.57	24.13	23.87	21.59	21.95	21.97
HSUPA Sub-test 2	23.79	24.29	24.17	21.98	22.21	22.30
HSUPA Sub-test 3	21.68	22.41	22.23	19.66	20.26	20.22
HSUPA Sub-test 4	23.93	24.44	24.25	22.19	22.39	22.48
HSUPA Sub-test 5	23.90	23.02	22.70	20.72	21.44	21.43

**Note:**

1. Applying the subtest setup in Table C.11.1.3 of 3GPP TS 34.121-1
2. Per KDB 941225 D01, RMC 12.2kbps mode is used to evaluate SAR due the highest output power. If AMR 12.2 kbps power is < 0.25dB higher than RMC 12.2kbps, SAR tests with AMR 12.2 kbps can be excluded.
3. AMR, HSDPA RF power will not be larger than RMC 12.2kbps, detailed information is included in Tune-up Procure exhibit.

## 13.3 LTE Conducted Power

### 13.3.1 Largest channel bandwidth standalone SAR test requirements

#### QPSK with 1 RB allocation

Start with the largest channel bandwidth and measure SAR for QPSK with 1 RB allocation, using the RB offset and required test channel combination with the highest maximum output power among RB offsets at the upper edge, middle and lower edge of each required test channel. When the reported SAR is  $\leq 0.8$  W/kg, testing of the remaining RB offset configurations and required test channels is not required for 1 RB allocation; otherwise, SAR is required for the remaining required test channels and only for the RB offset configuration with the highest output power for that channel.<sup>8</sup> When the reported SAR of a required test channel is  $> 1.45$  W/kg, SAR is required for all three RB offset configurations for that required test channel.

#### QPSK with 50% RB allocation

The procedures required for 1 RB allocation in section 4.2.1 are applied to measure the SAR for QPSK with 50% RB allocation.<sup>9</sup>

#### QPSK with 100% RB allocation

For QPSK with 100% RB allocation, SAR is not required when the highest maximum output power for 100 % RB allocation is less than the highest maximum output power in 50% and 1 RB allocations and the highest reported SAR for 1 RB and 50% RB allocation in sections 4.2.1 and 4.2.2 are  $\leq 0.8$  W/kg. Otherwise, SAR is measured for the highest output power channel; and if the reported SAR is  $> 1.45$  W/kg, the remaining required test channels must also be tested.

#### Higher order modulations

For each modulation besides QPSK; e.g., 16-QAM, 64-QAM, apply the QPSK procedures in sections 4.2.1, 5.2.2 and 4.2.3 to determine the QAM configurations that may need SAR measurement. For each configuration identified as required for testing, SAR is required only when the highest maximum output power for the configuration in the higher order modulation is  $> \frac{1}{2}$  dB higher than the same configuration in QPSK or when the reported SAR for the QPSK configuration is  $> 1.45$  W/kg.

### 13.3.2 Other channel bandwidth standalone SAR test requirements

For the other channel bandwidths used by the device in a frequency band, apply all the procedures required for the largest channel bandwidth in section 4.2 to determine the channels and RB configurations that need SAR testing and only measure SAR when the highest maximum output power of a configuration requiring testing in the smaller channel bandwidth is  $> \frac{1}{2}$  dB higher than the equivalent channel configurations in the largest channel bandwidth configuration or the reported SAR of a configuration for the largest channel bandwidth is  $> 1.45$  W/kg. The equivalent channel configuration for the RB allocation, RB offset and modulation etc. is determined for the smaller channel bandwidth according to the same number of RB allocated in the largest channel bandwidth. For example, 50 RB in 10 MHz channel bandwidth does not apply to 5 MHz channel bandwidth; therefore, this cannot be tested in the smaller channel bandwidth. However, 50% RB allocation in 10 MHz channel bandwidth is equivalent to 100% RB allocation in 5 MHz channel bandwidth; therefore, these are the equivalent configurations to be compared to determine the specific channel and configuration in the smaller channel bandwidth that need SAR testing.

**LTE Band 4 part**

LTE Band	Bandwidth (MHz)	Modulation	RB Size	RB Offset	Average Power (dBm)		
					19957	20175	20393
					1710.7MHz	1732.5MHz	1754.3MHz
Band 4	1.4	QPSK	1	0	21.01	21.61	21.10
			1	2	21.00	21.57	21.09
			1	5	20.98	21.55	21.10
			3	0	21.04	21.65	21.12
			3	1	21.03	21.61	21.16
			3	2	21.08	21.55	21.15
		16QAM	6	0	21.07	21.62	21.16
			1	0	20.97	21.47	21.02
			1	2	21.17	21.49	21.07
			1	5	21.08	21.61	21.28
			3	0	21.10	21.68	21.01
			3	1	21.08	21.38	21.02
			3	2	21.07	21.37	21.19
			6	0	21.04	21.51	21.14

LTE Band	Bandwidth (MHz)	Modulation	RB Size	RB Offset	Average Power (dBm)		
					19965	20175	20385
					1711.5MHz	1732.5MHz	1753.5MHz
Band 4	3	QPSK	1	0	20.74	21.42	20.80
			1	7	20.77	21.30	20.74
			1	14	20.81	21.23	20.79
			8	0	20.73	21.42	20.77
			8	4	20.78	21.37	20.77
			8	7	20.82	21.33	20.78
			15	0	20.77	21.38	20.77
		16QAM	1	0	20.74	21.37	20.67
			1	7	20.82	21.44	20.89
			1	14	20.86	21.38	20.94
			8	0	20.68	21.34	20.72
			8	4	20.75	21.27	20.76
			8	7	20.75	21.27	20.74
			15	0	20.67	21.34	20.85

LTE Band	Bandwidth (MHz)	Modulation	RB Size	RB Offset	Average Power (dBm)		
					19975	20175	20375
					1712.5MHz	1732.5MHz	1752.5MHz
Band 4	5	QPSK	1	0	20.71	21.44	20.78
			1	12	20.84	21.29	20.70
			1	24	20.83	21.16	20.77
			12	0	20.73	21.44	20.80
			12	6	20.80	21.32	20.80
			12	11	20.84	21.28	20.79
			25	0	20.82	21.36	20.81
		16QAM	1	0	20.72	21.30	20.66
			1	12	20.94	21.22	20.70
			1	24	20.92	21.24	20.73
			12	0	20.61	21.30	20.73
			12	6	20.80	21.32	20.68
			12	11	20.85	21.25	20.73
			25	0	20.81	21.34	20.80

LTE Band	Bandwidth (MHz)	Modulation	RB Size	RB Offset	Average Power (dBm)		
					20000	20175	20350
					1715.0MHz	1732.5MHz	1750.0MHz
Band 4	10	QPSK	1	0	20.71	21.55	20.74
			1	24	20.81	21.30	20.65
			1	49	21.06	21.00	20.72
			25	0	20.89	21.45	20.70
			25	12	20.88	21.35	20.68
			25	24	21.00	21.18	20.77
			50	0	20.90	21.36	20.90
		16QAM	1	0	20.81	21.62	20.59
			1	24	20.90	21.35	20.57
			1	49	21.23	21.12	20.89
			25	0	20.88	21.43	20.72
			25	12	20.92	21.34	20.65
			25	24	20.98	21.17	20.77
			50	0	20.92	21.32	20.71

LTE Band	Bandwidth (MHz)	Modulation	RB Size	RB Offset	Average Power (dBm)		
					20025	20175	20325
					1717.5MHz	1732.5MHz	1747.5MHz
Band 4	15	QPSK	1	0	20.70	21.45	20.93
			1	37	21.02	21.33	20.64
			1	74	21.25	20.88	20.67
			36	0	20.96	21.56	20.83
			36	16	21.06	21.38	20.73
			36	35	21.21	21.16	20.77
			75	0	21.05	21.39	20.76
		16QAM	1	0	20.90	21.63	20.86
			1	37	21.34	21.43	20.61
			1	74	21.57	20.83	20.52
			36	0	20.93	21.50	20.84
			36	16	21.06	21.32	20.67
			36	35	21.19	21.10	20.75
			75	0	21.06	21.34	20.74

LTE Band	Bandwidth (MHz)	Modulation	RB Size	RB Offset	Average Power (dBm)		
					20050	20175	20300
					1720.0MHz	1732.5MHz	1745.0MHz
Band 4	20	QPSK	1	0	20.35	21.00	20.77
			1	49	21.10	21.30	20.68
			1	99	20.98	20.35	20.79
			50	0	20.94	21.52	20.96
			50	24	21.13	21.36	20.78
			50	49	21.32	21.03	20.62
			100	0	21.03	21.31	20.81
		16QAM	1	0	20.21	21.32	20.98
			1	49	21.13	21.23	20.55
			1	99	20.98	20.17	20.49
			50	0	20.99	21.46	20.92
			50	24	21.13	21.30	20.76
			50	49	21.27	20.98	20.61
			100	0	21.02	21.27	20.81

**LTE Band 7 part:**

LTE Band	Bandwidth (MHz)	Modulation	RB Size	RB Offset	Average Power (dBm)		
					20775	21100	21425
					2502.5MHz	2535.0MHz	2567.5MHz
Band 7	5	QPSK	1	0	22.46	21.87	22.26
			1	12	22.49	21.84	22.35
			1	24	22.54	21.98	22.40
			12	0	22.54	21.93	22.37
			12	6	22.53	21.94	22.42
			12	11	22.52	22.02	22.41
			25	0	22.55	21.91	22.42
		16QAM	1	0	22.50	21.78	22.34
			1	12	22.53	21.79	22.23
			1	24	22.39	21.91	22.33
			12	0	22.53	21.85	22.30
			12	6	22.51	21.90	22.43
			12	11	22.40	21.98	22.39
			25	0	22.49	21.96	22.47

LTE Band	Bandwidth (MHz)	Modulation	RB Size	RB Offset	Average Power (dBm)		
					20800	21100	21400
					2505.0MHz	2535.0MHz	2565.0MHz
Band 7	10	QPSK	1	0	22.49	21.94	22.31
			1	24	22.46	21.82	22.23
			1	49	22.28	22.08	22.43
			25	0	22.54	21.95	22.33
			25	12	22.57	22.00	22.35
			25	24	22.44	22.05	22.41
			50	0	22.59	22.03	22.40
		16QAM	1	0	22.41	22.17	22.28
			1	24	22.31	22.13	22.36
			1	49	22.14	22.05	22.41
			25	0	22.47	21.95	22.34
			25	12	22.46	22.04	22.38
			25	24	22.43	22.06	22.39
			50	0	22.53	22.08	22.43

LTE Band	Bandwidth (MHz)	Modulation	RB Size	RB Offset	Average Power (dBm)		
					20825	21100	21375
					2507.5MHz	2535.0MHz	2562.5MHz
Band 7	15	QPSK	1	0	22.48	21.90	22.54
			1	37	22.36	21.92	22.23
			1	74	22.25	22.14	22.47
			36	0	22.64	22.06	22.43
			36	16	22.47	22.03	22.41
			36	35	22.33	22.18	22.40
			75	0	22.43	22.11	22.52
		16QAM	1	0	22.65	21.72	22.34
			1	37	22.35	21.77	22.21
			1	74	22.26	22.15	22.43
			36	0	22.59	22.05	22.44
			36	16	22.44	22.07	22.39
			36	35	22.35	22.24	22.40
			75	0	22.40	22.14	22.49

LTE Band	Bandwidth (MHz)	Modulation	RB Size	RB Offset	Average Power (dBm)		
					20850	21100	21350
					2510.0MHz	2535.0MHz	2560.0MHz
Band 7	20	QPSK	1	0	22.24	21.81	22.15
			1	49	22.27	21.95	22.38
			1	99	21.82	21.97	22.04
			50	0	22.58	22.02	22.62
			50	24	22.34	22.13	22.56
			50	49	22.33	22.19	22.44
			100	0	22.22	22.16	22.53
		16QAM	1	0	22.15	21.49	22.04
			1	49	22.16	22.18	22.38
			1	99	21.76	21.81	21.97
			50	0	22.55	22.00	22.62
			50	24	22.35	22.15	22.55
			50	49	22.28	22.24	22.44
			100	0	22.24	22.22	22.58



**LTE Band 17 part:**

LTE Band	Bandwidth (MHz)	Modulation	RB Size	RB Offset	Average Power (dBm)		
					23755	23790	23825
					706.5MHz	710.0MHz	713.5MHz
Band 17	5	QPSK	1	0	22.19	21.85	23.15
			1	12	21.73	22.75	22.71
			1	24	21.98	23.13	22.76
			12	0	21.94	22.05	23.08
			12	6	21.81	22.71	22.80
			12	11	21.99	23.15	22.58
			25	0	21.88	22.59	22.87
		16QAM	1	0	22.29	21.94	23.22
			1	12	21.67	22.63	22.74
			1	24	22.18	22.44	22.62
			12	0	21.93	22.05	22.97
			12	6	21.70	22.59	22.73
			12	11	21.95	23.09	22.52
			25	0	21.84	22.55	22.76

LTE Band	Bandwidth (MHz)	Modulation	RB Size	RB Offset	Average Power (dBm)		
					23780	23790	23800
					709.0MHz	710.0MHz	711.0MHz
Band 17	10	QPSK	1	0	22.20	21.91	21.79
			1	24	22.14	22.75	23.16
			1	49	22.88	22.59	22.65
			25	0	21.94	22.01	22.05
			25	12	22.12	22.62	23.00
			25	24	22.96	23.03	22.91
			50	0	21.85	22.13	22.56
		16QAM	1	0	22.59	21.78	21.94
			1	24	22.04	22.81	23.00
			1	49	22.68	22.41	22.48
			25	0	21.94	21.98	22.01
			25	12	22.07	22.58	22.88
			25	24	22.93	22.88	22.77
			50	0	21.81	22.12	22.54

### 13.4 WLAN 2.4 GHz Band Conducted Power

Channel	Frequency (MHz)	Average Power (dBm)		
		802.11 b	802.11 g	802.11n (HT20)
CH 01	2412	15.87	<b>14.05</b>	14.00
CH 06	2437	16.55	12.31	12.46
CH 11	2462	<b>16.60</b>	13.92	13.63

**Note:**

- Per KDB 447498 D01v05r02, the 1-g SAR test exclusion thresholds for 100 MHz to 6 GHz at *test separation distances* ≤ 50 mm are determined by:  

$$[(\text{max. power of channel, including tune-up tolerance, mW}) / (\text{min. test separation distance, mm})] \cdot [\sqrt{f(\text{GHz})}] \leq 3.0$$
 for 1-g SAR, where
  - f(GHz) is the RF channel transmit frequency in GHz
  - Power and distance are rounded to the nearest mW and mm before calculation
  - The result is rounded to one decimal place for comparison

Channel	Frequency (GHz)	Max. Tune-up Power (dBm)	Max. Power (mW)	Test distance (mm)	Result	exclusion thresholds for 1-g SAR
b/CH 11	2.462	17.0	50.12	5	15.74	3.0
g/CH 01	2.412	14.5	28.18	5	8.74	3.0

- Base on the result of note1, RF exposure evaluation of 802.11 b mode is required.
- Per KDB 248227 D01v02, choose the highest output power channel to test SAR and determine further SAR exclusion.
- Per KDB 248227 D01v02, In the 2.4 GHz band, separate SAR procedures are applied to DSSS and OFDM configurations to simplify DSSS test requirements. SAR is not required for the following 2.4 GHz OFDM conditions:
  - When KDB Publication 447498 SAR test exclusion applies to the OFDM configuration.
  - When the highest reported SAR for DSSS is adjusted by the ratio of OFDM to DSSS specified maximum output power and the adjusted SAR is ≤ 1.2 W/kg.
- The output power of all data rate were pre-scan, just the worst case (the lowest data rate) of all mode were shown in report.
- Per KDB 248227 D01V02 section 2.2, when the EUT in continuously transmitting mode, the actual duty cycle is 92.3%, so the duty cycle factor is 1.08.

## 14 Exposure Positions Consideration

### 14.1 EUT Antenna Locations

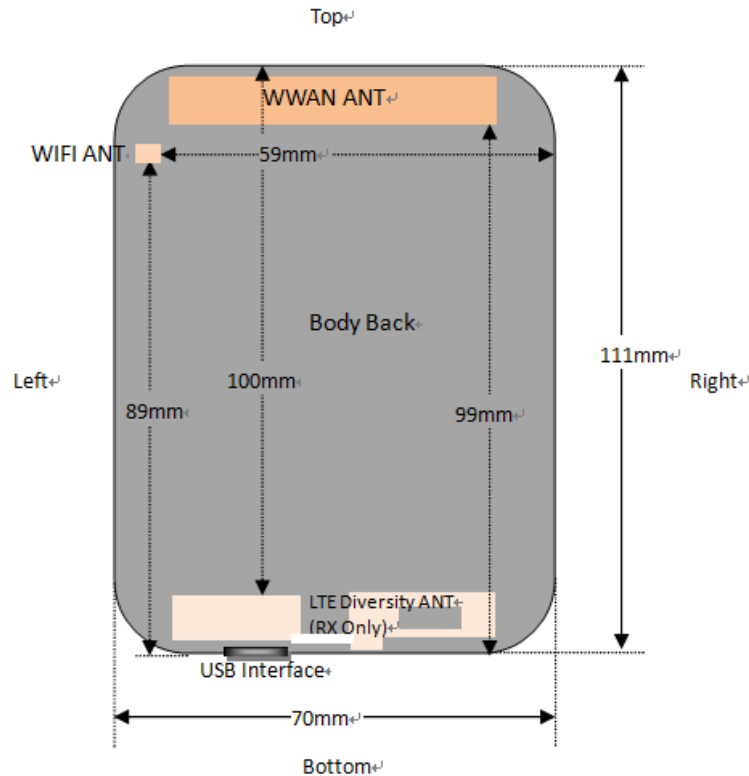

Fig.14.1 EUT Antenna Locations

### 14.2 Test Positions Consideration

Distance of Antennas to EUT edge/surface Test distance: 10mm						
Antennas	Back	Front	Top Side	Bottom Side	Right Side	Left Side
WWAN	<25mm	<25mm	<25mm	99mm	<25mm	<25mm
WLAN	<25mm	<25mm	<25mm	89mm	59mm	<25mm

Test Positions Test distance: 10mm						
Antennas	Back	Front	Top Side	Bottom Side	Right Side	Left Side
WWAN	Yes	Yes	Yes	No	Yes	Yes
WLAN	Yes	Yes	Yes	No	No	Yes

**Note:**

1. Body-worn mode SAR assessments are required.
2. Referring to KDB 941225 D06v02, when the overall device length and width are  $\geq 9\text{cm} * 5\text{cm}$ , the test distance is 10mm. SAR must be measured for all sides and surfaces with a transmitting antenna located within 25mm from that surface or edge.
3. Per KDB 447498 D01v05r02, for handsets the test separation distance is determined by the smallest distance between the outer surface of the device and the user, which is 10 mm for body-worn SAR.

## 15 SAR Test Results Summary

### 15.1 Standalone Body SAR

➤ GSM Body SAR

Plot No.	Band/Mode	Test Position	CH.	Freq. (MHz)	Ave. Power (dBm)	Power Drift (dB)	Tune-Up Limit (dBm)	Meas. SAR <sub>1g</sub> (W/kg)	Scaling Factor	Reported SAR <sub>1g</sub> (W/kg)
1	GPRS850/3 slots	Front	251	848.8	31.10	-0.08	31.5	0.510	1.096	0.559
	GPRS850/3 slots	Back	251	848.8	31.10	-0.10	31.5	<b>0.581</b>	1.096	0.637
	GPRS850/3 slots	Left	251	848.8	31.10	0.06	31.5	0.330	1.096	0.362
	GPRS850/3 slots	Right	251	848.8	31.10	0.02	31.5	0.334	1.096	0.366
	GPRS850/3 slots	Top	251	848.8	31.10	-0.22	31.5	0.260	1.096	0.285
2	GPRS1900/3 slots	Front	512	1850.2	27.33	-0.17	27.5	0.860	1.04	0.894
	<b>GPRS1900/3 slots</b>	<b>Front</b>	<b>512</b>	<b>1850.2</b>	<b>27.33</b>	<b>-0.13</b>	<b>27.5</b>	<b>0.945</b>	<b>1.04</b>	<b>0.983</b>
	GPRS1900/3 slots	Front	661	1880.0	27.20	-0.23	27.5	0.816	1.072	0.875
	GPRS1900/3 slots	Front	810	1909.8	27.25	-0.19	27.5	0.781	1.059	0.827
	GPRS1900/3 slots	Back	512	1850.2	27.33	-0.32	27.5	0.531	1.04	0.552
	GPRS1900/3 slots	Left	512	1850.2	27.33	-0.11	27.5	0.202	1.04	0.210
	GPRS1900/3 slots	Right	512	1850.2	27.33	0.03	27.5	0.243	1.04	0.253
	GPRS1900/3 slots	Top	512	1850.2	27.33	0.08	27.5	<b>0.872</b>	1.04	0.907
	<b>GPRS1900/3 slots</b>	<b>Top</b>	<b>512</b>	<b>1850.2</b>	<b>27.33</b>	<b>0.07</b>	<b>27.5</b>	<b>0.829</b>	<b>1.04</b>	<b>0.862</b>
	GPRS1900/3 slots	Top	661	1880.0	27.20	-0.04	27.5	0.727	1.072	0.779
	GPRS1900/3 slots	Top	810	1909.8	27.25	0.04	27.5	0.720	1.059	0.762
	<b>ANSI / IEEE C95.1 – SAFETY LIMIT Spatial Peak Uncontrolled Exposure/General Population</b>							<b>1.6 W/kg (mW/g) Averaged over 1g</b>		

➤ WCDMA Body SAR

Plot No.	Band/Mode	Test Position	CH.	Freq. (MHz)	Ave. Power (dBm)	Power Drift (dB)	Tune-Up Limit (dBm)	Meas. SAR <sub>1g</sub> (W/kg)	Scaling Factor	Reported SAR <sub>1g</sub> (W/kg)
3	Band V/RMC	Front	4183	836.6	24.39	0.03	24.5	0.576	1.026	0.591
	Band V/RMC	Back	4183	836.6	24.39	0.14	24.5	<b>0.600</b>	1.026	0.616
	Band V/RMC	Left	4183	836.6	24.39	0.09	24.5	0.455	1.026	0.467
	Band V/RMC	Right	4183	836.6	24.39	0.10	24.5	0.405	1.026	0.416
	Band V/RMC	Top	4183	836.6	24.39	-0.30	24.5	0.241	1.026	0.247
4	Band II/RMC	Front	9538	1907.6	22.27	-0.26	22.5	0.881	1.054	0.929
	Band II/RMC	Front	9262	1852.4	21.78	-0.29	22.5	0.842	1.18	0.994
	Band II/RMC	Front	9400	1880.0	22.14	-0.20	22.5	<b>0.961</b>	1.086	1.044
	<b>Band II/RMC</b>	<b>Front</b>	<b>9400</b>	<b>1880.0</b>	<b>22.14</b>	<b>0.08</b>	<b>22.5</b>	<b>0.910</b>	<b>1.086</b>	<b>0.988</b>
	Band II/RMC	Back	9538	1907.6	22.27	-0.28	22.5	0.484	1.054	0.510
	Band II/RMC	Left	9538	1907.6	22.27	0.13	22.5	0.214	1.054	0.226
	Band II/RMC	Right	9538	1907.6	22.27	0.28	22.5	0.262	1.054	0.276
	Band II/RMC	Top	9538	1907.6	22.27	-0.05	22.5	0.822	1.054	0.866
	Band II/RMC	Top	9262	1852.4	21.78	0.11	22.5	0.784	1.18	0.925
	Band II/RMC	Top	9400	1880.0	22.14	0.20	22.5	0.830	1.086	0.901
<b>ANSI / IEEE C95.1 – SAFETY LIMIT Spatial Peak Uncontrolled Exposure/General Population</b>							<b>1.6 W/kg (mW/g) Averaged over 1g</b>			

➤ LTE 20MHz QPSK 1RB Body SAR

Plot No.	Band/Mode	Test Position	CH.	Freq. (MHz)	Ave. Power (dBm)	Power Drift (dB)	Tune-Up Limit (dBm)	Meas. SAR <sub>1g</sub> (W/kg)	Scaling Factor	Reported SAR <sub>1g</sub> (W/kg)
5	Band4/RB#49	Front	20175	1732.5	21.30	0.09	21.5	<b>0.550</b>	1.047	0.576
	Band4/RB#49	Back	20175	1732.5	21.30	0.28	21.5	0.364	1.047	0.381
	Band4/RB#49	Left	20175	1732.5	21.30	0.25	21.5	0.202	1.047	0.211
	Band4/RB#49	Right	20175	1732.5	21.30	0.22	21.5	0.153	1.047	0.160
	Band4/RB#49	Top	20175	1732.5	21.30	0.19	21.5	0.424	1.047	0.444
6	Band7/RB#49	Front	21350	2560.0	22.38	0.25	22.5	<b>0.635</b>	1.028	0.653
	Band7/RB#49	Back	21350	2560.0	22.38	0.04	22.5	0.175	1.028	0.180
	Band7/RB#49	Left	21350	2560.0	22.38	0.32	22.5	0.123	1.028	0.126
	Band7/RB#49	Right	21350	2560.0	22.38	-0.05	22.5	0.060	1.028	0.062
	Band7/RB#49	Top	21350	2560.0	22.38	0.11	22.5	0.301	1.028	0.309
7	Band17/RB#24	Front	23800	711.0	23.16	-0.24	23.5	0.596	1.081	0.644
	Band17/RB#24	Back	23800	711.0	23.16	-0.25	23.5	<b>0.629</b>	1.081	0.680
	Band17/RB#24	Left	23800	711.0	23.16	0.03	23.5	0.314	1.081	0.339
	Band17/RB#24	Right	23800	711.0	23.16	-0.08	23.5	0.242	1.081	0.262
	Band17/RB#24	Top	23800	711.0	23.16	0.20	23.5	0.228	1.081	0.246
<b>ANSI / IEEE C95.1 – SAFETY LIMIT Spatial Peak Uncontrolled Exposure/General Population</b>							<b>1.6 W/kg (mW/g) Averaged over 1g</b>			

➤ LTE 20MHz QPSK 50%RB Body SAR

Plot No.	Band/Mode	Test Position	CH.	Freq. (MHz)	Ave. Power (dBm)	Power Drift (dB)	Tune-Up Limit (dBm)	Meas. SAR <sub>1g</sub> (W/kg)	Scaling Factor	Reported SAR <sub>1g</sub> (W/kg)
8	Band4/RB#0	Front	20175	1732.5	21.52	0.10	22.0	<b>0.518</b>	1.117	0.579
	Band4/RB#0	Back	20175	1732.5	21.52	0.38	22.0	0.344	1.117	0.384
	Band4/RB#0	Left	20175	1732.5	21.52	-0.12	22.0	0.199	1.117	0.222
	Band4/RB#0	Right	20175	1732.5	21.52	0.21	22.0	0.147	1.117	0.164
	Band4/RB#0	Top	20175	1732.5	21.52	0.14	22.0	0.422	1.117	0.471
9	Band7/RB#0	Front	21350	2560.0	22.62	-0.08	23.0	<b>0.580</b>	1.091	0.633
	Band7/RB#0	Back	21350	2560.0	22.62	0.15	23.0	0.190	1.091	0.207
	Band7/RB#0	Left	21350	2560.0	22.62	-0.18	23.0	0.125	1.091	0.136
	Band7/RB#0	Right	21350	2560.0	22.62	-0.05	23.0	0.062	1.091	0.068
	Band7/RB#0	Top	21350	2560.0	22.62	-0.16	23.0	0.309	1.091	0.337
10	Band17/RB#24	Front	23790	710.0	23.03	0.00	23.5	<b>0.323</b>	1.114	0.360
	Band17/RB#24	Back	23790	710.0	23.03	0.13	23.5	0.263	1.114	0.293
	Band17/RB#24	Left	23790	710.0	23.03	0.24	23.5	0.121	1.114	0.135
	Band17/RB#24	Right	23790	710.0	23.03	0.03	23.5	0.113	1.114	0.126
	Band17/RB#24	Top	23790	710.0	23.03	0.21	23.5	0.141	1.114	0.157
<b>ANSI / IEEE C95.1 – SAFETY LIMIT Spatial Peak Uncontrolled Exposure/General Population</b>							<b>1.6 W/kg (mW/g) Averaged over 1g</b>			

➤ WLAN 2.4GHz Body SAR

Plot No.	Band/Mode	Test Position	CH.	Freq. (MHz)	Ave. Power (dBm)	Power Drift (dB)	Tune-Up Limit (dBm)	Meas. SAR <sub>1g</sub> (W/kg)	Scaling Factor	D.C Factor	Reported SAR <sub>1g</sub> (W/kg)
	2.4GHz/802.11b	Front	11	2462	16.60	-0.21	17.0	0.087	1.096	1.08	0.103
	2.4GHz/802.11b	Back	11	2462	16.60	-0.02	17.0	0.056	1.096	1.08	0.066
11	2.4GHz/802.11b	Left	11	2462	16.60	-0.22	17.0	<b>0.089</b>	1.096	1.08	0.105
	2.4GHz/802.11b	Top	11	2462	16.60	0.10	17.0	0.026	1.096	1.08	0.007
<b>ANSI / IEEE C95.1 – SAFETY LIMIT Spatial Peak Uncontrolled Exposure/General Population</b>							<b>1.6 W/kg (mW/g) Averaged over 1g</b>				

**Note:**

- Per KDB 447498 D01v05r02, for each exposure position, if the highest output channel Reported SAR ≤ 0.8W/kg, other channels SAR testing is not necessary.
- Additional WLAN SAR testing was performed for simultaneous transmission analysis.

**Shenzhen Zhongjian Nanfang Testing Co., Ltd.**

No. B-C, 1/F., Building 2, Laodong No.2 Industrial Park, Xixiang Road, Bao'an District, Shenzhen, Guangdong, China  
Telephone: +86 (0) 755 23118282 Fax: +86 (0) 755 23116366

Project No.: CCIS151100851RF

3. For Hotspot SAR testing, per KDB 941225 D06v02, for EUT dimension  $\geq 9\text{cm} \times 5\text{cm}$ , the test distance is 10mm. SAR must be measured for all surfaces and sides with a transmitting antenna located within 2.5cm from that surface or edge.
4. Per KDB 941225 D01v03, RMC 12.2kbps setting is used to evaluate SAR. If HSDPA output power is  $< 0.25\text{dB}$  higher than RMC 12.2kbps, or Reported SAR with RMC 12.2kbps setting is  $\leq 1.2\text{W/kg}$ , HSDPA SAR evaluation can be excluded.
5. Per KDB 865664 D01v01r03, for each frequency band, repeated SAR measurement is required when the measured SAR is  $\geq 0.8\text{W/kg}$ .
6. Per KDB 865664 D01v01r03, for each frequency band, repeated SAR measurement is required when the measured SAR is  $\geq 0.8\text{W/kg}$ . Per KDB 648474 D04v01r02, when the Reported SAR for a body-worn accessory measured without a headset connected to the handset is  $> 1.2\text{W/kg}$ , SAR testing with a headset connected to the handset is required.
7. Per KDB 941225 D05v02r03, 100% RB allocation SAR measurement is not required when the highest reported SAR for 1 RB and 50% RB allocation are  $\leq 0.8\text{W/kg}$ . Otherwise, SAR is measured for the highest output power channel.
8. According to KDB 865664 D02v01r01, SAR plot is required for the highest measured SAR in each exposure configuration, wireless mode and frequency band combination.
9. Per KDB 248227 D01v02, OFDM SAR is not required when the highest reported SAR for DSSS is adjusted by the ratio of OFDM to DSSS specified maximum output power and the adjusted SAR is  $\leq 1.2\text{W/kg}$ . Cuz the maximum output power specified for OFDM and DSSS are  $25.41\text{mW}(14.05\text{dBm})$  and  $45.71\text{mW}(16.60\text{dBm})$ , the scaled SAR would be  $0.105 \times (25.41/45.71) = 0.058\text{W/Kg} < 1.2\text{W/kg}$ , therefore, SAR is not required for OFDM.
10. Highlight part of test data means repeated test.

## 15.2 Repeated SAR measurement

Band/ Mode	Test Position	CH.	Freq. (MHz)	Measured SAR (W/kg)				
				Original	1 <sup>st</sup> Repeated		2 <sup>nd</sup> Repeated	
					Value	Ratio	Value	Ratio
GPRS1900/3 slots	Front	512	1850.2	0.860	0.945	0.910	/	/
GPRS1900/3 slots	Top	512	1850.2	0.872	0.829	1.05	/	/
Band II/RMC	Front	9400	1880.0	0.961	0.910	1.06	/	/
<b>ANSI / IEEE C95.1 – SAFETY LIMIT Spatial Peak Uncontrolled Exposure/General Population</b>				<b>1.6 W/kg (mW/g) Averaged over 1g</b>				

**Note:**

1. Per KDB 865664 D01v01r03, for each frequency band, repeated SAR measurement is required only when the measured SAR is  $\geq 0.8\text{W/kg}$
2. Per KDB 865664 D01v01r03, if the ratio of *original* and *repeated* is  $\leq 1.2$  and the measured SAR  $< 1.45\text{W/kg}$ , only one repeated measurement is required.

### 15.3 Multi-Band Simultaneous Transmission Considerations

➤ **Simultaneous Transmission Capabilities**

According to FCC KDB Publication 447498 D01v05r02, transmitters are considered to be transmitting simultaneously when there is overlapping transmission, with the exception of transmissions during network hand-offs with maximum hand-off duration less than 30 seconds. Possible transmission paths for the EUT are shown in below Figure and are color-coded to indicate communication modes which share the same path. Modes which share the same transmission path cannot transmit simultaneously with one another.



**Fig.15.1 Simultaneous Transmission Paths**

➤ **Multi-Band simultaneous Transmission Consideration**

Simultaneous Transmission Consideration	Position	Applicable Combination
	Body	WWAN + WLAN 2.4 GHz

**Note:**

1. GSM/WCDMA/LTE shares the same antenna, and cannot transmit simultaneously.
2. The Report SAR summation is calculated based on the same configuration and test position.
3. Per KDB 447498 D01v05r02, simultaneous transmission SAR is compliant if,
  - i. Scalar SAR summation < 1.6 W/kg.
  - ii.  $SPLSR = (SAR_1 + SAR_2)^{1.5} / (min. \text{ separation distance, mm})$ , and the peak separation distance is determined from the square root of  $[(x_1-x_2)^2 + (y_1-y_2)^2 + (z_1-z_2)^2]$ , where  $(x_1, y_1, z_1)$  and  $(x_2, y_2, z_2)$  are the coordinates of the extrapolated peak SAR locations in the zoom scan. If  $SPLSR \leq 0.04$ , simultaneously transmission SAR measurement is not necessary.
  - iii. Simultaneously transmission SAR measurement, and the Reported multi-band SAR < 1.6 W/kg



## 15.4 SAR Simultaneous Transmission Analysis

### > Body worn Simultaneous Transmission

WWAN Mode	Position	WWAN SAR <sub>1g</sub> (W/kg)	WLAN SAR <sub>1g</sub> (W/kg)	Σ SAR (W/kg)
GSM850	Front	0.559	0.103	0.662
	Back	0.637	0.066	0.703
	Left	0.362	0.105	0.467
	Right	0.366	/	0.366
	Top	0.285	/	0.285
	Bottom	/	0.007	0.007

WWAN Mode	Position	WWAN SAR <sub>1g</sub> (W/kg)	WLAN SAR <sub>1g</sub> (W/kg)	Σ SAR (W/kg)
GSM 1900	Front	0.983	0.103	1.086
	Back	0.552	0.066	0.618
	Left	0.210	0.105	0.315
	Right	0.253	/	0.253
	Top	0.907	/	0.907
	Bottom	/	0.007	0.007

WWAN Mode	Position	WWAN SAR <sub>1g</sub> (W/kg)	WLAN SAR <sub>1g</sub> (W/kg)	Σ SAR (W/kg)
WCDMA Band V	Front	0.591	0.103	0.694
	Back	0.616	0.066	0.682
	Left	0.467	0.105	0.572
	Right	0.416	/	0.416
	Top	0.247	/	0.247
	Bottom	/	0.007	0.007

WWAN Mode	Position	WWAN SAR <sub>1g</sub> (W/kg)	WLAN SAR <sub>1g</sub> (W/kg)	Σ SAR (W/kg)
WCDMA Band II	Front	1.044	0.103	1.147
	Back	0.510	0.066	0.576
	Left	0.226	0.105	0.331
	Right	0.276	/	0.276
	Top	0.925	/	0.925
	Bottom	/	0.007	0.007

WWAN Mode	Position	WWAN SAR <sub>1g</sub> (W/kg)	WLAN SAR <sub>1g</sub> (W/kg)	Σ SAR (W/kg)
LTE Band 4	Front	0.579	0.103	0.682
	Back	0.384	0.066	0.450
	Left	0.222	0.105	0.327
	Right	0.164	/	0.164
	Top	0.471	/	0.471
	Bottom	/	0.007	0.007

WWAN Mode	Position	WWAN SAR <sub>1g</sub> (W/kg)	WLAN SAR <sub>1g</sub> (W/kg)	Σ SAR (W/kg)
LTE Band 7	Front	0.653	0.103	0.756
	Back	0.207	0.066	0.273
	Left	0.136	0.105	0.241
	Right	0.068	/	0.068
	Top	0.337	/	0.337
	Bottom	/	0.007	0.007

WWAN Mode	Position	WWAN SAR <sub>1g</sub> (W/kg)	WLAN SAR <sub>1g</sub> (W/kg)	Σ SAR (W/kg)
LTE Band 17	Front	0.644	0.103	0.747
	Back	0.680	0.066	0.746
	Left	0.339	0.105	0.444
	Right	0.262	/	0.262
	Top	0.246	/	0.246
	Bottom	/	0.007	0.007

### > Simultaneous Transmission Conclusion

The above numerical summed SAR results for all the case simultaneous transmission conditions were below the SAR limit. Therefore, the above analysis is sufficient to determine that simultaneous transmission cases will not exceed the SAR limit and therefore no measured volumetric simultaneous SAR summation is required per FCC KDB Publication 447498 D01v05r02.

## 15.5 Measurement Uncertainty

The component of uncertainty may generally be categorized according to the methods used to evaluate them. The evaluation of uncertainty by the statistical analysis of a series of observations is termed a Type A evaluation of uncertainty. The evaluation of uncertainty by means other than the statistical analysis of a series of observation is termed a Type B evaluation of uncertainty. Each component of uncertainty, however evaluated, is represented by an estimated standard deviation, termed standard uncertainty, which is determined by the positive square root of the estimated variance.

A Type A evaluation of standard uncertainty may be based on any valid statistical method for treating data. This includes calculating the standard deviation of the mean of a series of independent observations; using the method of least squares to fit a curve to the data in order to estimate the parameter of the curve and their standard deviations; or carrying out an analysis of variance in order to identify and quantify random effects in certain kinds of measurement.

A Type B evaluation of standard uncertainty is typically based on scientific judgment using all of the relevant information available. These may include previous measurement data, experience, and knowledge of the behavior and properties of relevant materials and instruments, manufacture’s specification, data provided in calibration reports and uncertainties assigned to reference data taken from handbooks. Broadly speaking, the uncertainty is either obtained from an outdoor source or obtained from an assumed distribution, such as the normal distribution, rectangular or triangular distributions indicated in below Table.

Uncertainty Distributions	Normal	Rectangular	Triangular	U-Shape
Multi-plying Factor	1/k(b)	$1/\sqrt{3}$	$1/\sqrt{6}$	$1/\sqrt{2}$

### Standard Uncertainty for Assumed Distribution

The combined standard uncertainty of the measurement result represents the estimated standard deviation of the result. It is obtained by combining the individual standard uncertainties of both Type A and Type B evaluation using the usual “root-sum-squares” (RSS) methods of combining standard deviations by taking the positive square root of the estimated variances.

Expanded uncertainty is a measure of uncertainty that defines an interval about the measurement result within which the measured value is confidently believed to lie. It is obtained by multiplying the combined standard uncertainty by a coverage factor. Typically, the coverage factor ranges from 2 to 3. Using a coverage factor allows the true value of a measured quantity to be specified with a defined probability within the specified uncertainty range. For purpose of this document, a coverage factor two is used, which corresponds to confidence interval of about 95 %. The DASY uncertainty Budget is shown in the following tables.

Uncertainty Component	Section	Uncert. Value	Prob. Dist.	Div.	(C <sub>i</sub> ) (1 g)	(C <sub>i</sub> ) (10 g)	Std. Unc. (1 g)	Std. Unc. (10 g)	V <sub>i</sub>
<b>Measurement System</b>									
Probe Calibration	E.2.1	±6.0%	N	1	1	1	±6.0%	±6.0%	∞
Axial Isotropy	E.2.2	±0.5%	R	$\sqrt{3}$	0.7	0.7	±0.20%	±0.20%	∞
Hemispherical Isotropy	E.2.2	±2.6%	R	$\sqrt{3}$	0.7	0.7	±1.05%	±1.05%	∞
Boundary Effects	E.2.3	±1.0%	R	$\sqrt{3}$	1	1	±0.58%	±0.58%	∞
Linearity	E.2.4	±0.6%	R	$\sqrt{3}$	1	1	±0.35%	±0.35%	∞
System Detection Limits	E.2.5	±0.25%	R	$\sqrt{3}$	1	1	±0.14%	±0.14%	∞
Readout Electronics	E.2.6	±0.3%	N	1	1	1	±0.3%	±0.3%	∞
Response Time	E.2.7	±0.8%	R	$\sqrt{3}$	1	1	±0.46%	±0.46%	∞
Integration Time	E.2.8	±2.6%	R	$\sqrt{3}$	1	1	±1.5%	±1.5%	∞
RF Ambient Noise	E.6.1	±3.0%	R	$\sqrt{3}$	1	1	±1.73%	±1.73%	∞
RF Ambient Reflections	E.6.1	±3.0%	R	$\sqrt{3}$	1	1	±1.73%	±1.73%	∞
Probe positioner mechanical tolerances	E.6.2	±0.4%	R	$\sqrt{3}$	1	1	±0.23%	±0.23%	∞
Probe positioning tolerance with respect to the phantom shell surface	E.6.3	±2.9%	R	$\sqrt{3}$	1	1	±1.67%	±1.67%	∞
Interpolation, extrapolation, and integration algorithm For max. SAR Evaluation.	E.5	±1.0%	R	$\sqrt{3}$	1	1	±0.58%	±0.58%	∞
<b>Test Sample Related</b>									
Device Positioning	E.4.2	±4.6%	N	1	1	1	±4.6%	±4.6%	M-1
Device Holder	E.4.1	±5.2%	N	1	1	1	±5.2%	±5.2%	M-1
Power Drift	6.6.2	±5.0%	R	$\sqrt{3}$	1	1	±2.89%	±2.89%	∞
<b>Phantom and Setup</b>									
Phantom Uncertainty	E.3.1	±4.0%	R	$\sqrt{3}$	1	1	±2.31%	±2.31%	∞
Liquid Conductivity(Target)	E.3.2	±5.0%	R	$\sqrt{3}$	0.64	0.43	±1.85%	±1.24%	∞
Liquid Conductivity(Meas.)	E.3.3	±2.5%	N	1	0.64	0.43	±1.64%	±1.08%	M
Liquid Permittivity(Target)	E.3.2	±5.0%	R	$\sqrt{3}$	0.6	0.49	±1.73%	±1.41%	∞
Liquid Permittivity(Meas.)	E.3.3	±2.5%	N	1	0.6	0.49	±1.5%	±1.23%	M
Combined Standard Uncertainty (RSS)							±11.07%	±10.84%	
Expanded Uncertainty (95% Confidence Level, k = 2)							±22.2%	±21.7%	

**Uncertainty Budget for frequency range 300 MHz to 3 GHz according to IEEE1528-2013**

## **15.6 Measurement Conclusion**

The SAR evaluation indicates that the EUT complies with the RF radiation exposure limits of the FCC and Industry Canada, with respect to all parameters subject to this test. These measurements were taken to simulate the RF effects of RF exposure under worst-case conditions. Precise laboratory measures were taken to assure repeatability of the tests. The results and statements relate only to the item(s) tested. Please note that the absorption and distribution of electromagnetic energy in the body are very complex phenomena that depend on the mass, shape, and size of the body, the orientation of the body with respect to the field vectors, and the electrical properties of both the body and the environment. Other variables that may play a substantial role in possible biological effects are those that characterize the environment (e.g. ambient temperature, air velocity, relative humidity, and body insulation) and those that characterize the individual (e.g. age, gender, activity level, debilitation, or disease). Because various factors may interact with one another to vary the specific biological outcome of an exposure to electromagnetic fields, any protection guide should consider maximal amplification of biological effects as a result of field-body interactions, environmental conditions, and physiological variables.

## 16 Reference

- [1]. FCC 47 CFR Part 2 “Frequency Allocations and Radio Treaty Matters; General Rules and Regulations”
- [2]. ANSI/IEEE Std. C95.1-1992, “IEEE Standard for Safety Levels with Respect to Human Exposure to Radio Frequency Electromagnetic Fields, 3 kHz to 300 GHz”, September 1992
- [3]. IEEE Std. 1528-2013, “Recommended Practice for Determining the Peak Spatial-Average Specific Absorption Rate (SAR) in the Human Head from Wireless Communications Devices: Measurement Techniques”, September 2013
- [4]. SPEAG DASY52 System Handbook
- [5]. FCC KDB 248227 D01 v02, “SAR GUIDANCE FOR IEEE 802.11 (Wi-Fi) TRANSMITTERS”, March 2015
- [6]. FCC KDB 447498 D01 v05r02, “Mobile and Portable Device RF Exposure Procedures and Equipment Authorization Policies”, May 2013
- [7]. FCC KDB 648474 D04 v01r02, “SAR Evaluation Considerations for Handsets with Multiple Transmitters and Antennas”, October 2012
- [8]. FCC KDB 941225 D01 v03, “3G SAR MEAUREMENT PROCEDURES”, October 2014
- [9]. FCC KDB 941225 D05 v02r03, “SAR Evaluation Considerations for LTE Devices”, Dec 2013
- [10]. FCC KDB 941225 D03 v01, “Recommended SAR Test Reduction Procedures for GSM / GPRS / EDGE”, December 2008
- [11]. FCC KDB 941225 D06 v02, "SAR Evaluation Procedures for Portable Devices with Wireless Router Capabilities", October 2014
- [12]. FCC KDB 865664 D01 v01r03, “SAR Measurement Requirements for 100MHz to 6 GHz”, May 2013

## Appendix A: EUT Photos





## Appendix B: Test Setup Photos

## Body

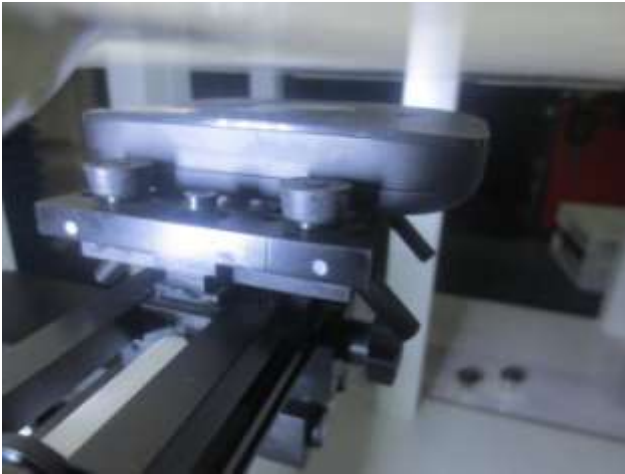

Front side (10mm)

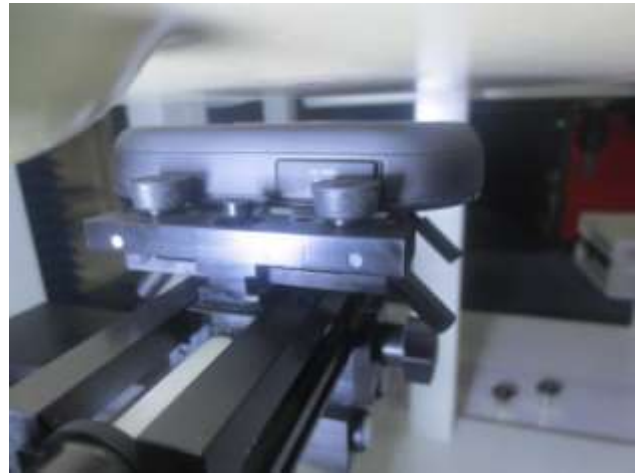

Back side(10mm)



Top side(10mm)



Bottom side(10mm)



Left side(10mm)



Right side(10mm)

## Appendix C: Plots of SAR System Check

Test Laboratory: CCIS

Date/Time: 11.25.2015 08:01:57

**DUT: Dipole 750 MHz D750V3; Type: D750V3; Serial: D750V3 - SN:1118**

Communication System: UID 0, CW (0); Frequency: 750 MHz

Medium parameters used:  $f = 750 \text{ MHz}$ ;  $\sigma = 0.949 \text{ S/m}$ ;  $\epsilon_r = 56.163$ ;  $\rho = 1000 \text{ kg/m}^3$

Phantom section: Flat Section

Measurement Standard: DASYS (IEEE/IEC/ANSI C63.19-2007)

DASY Configuration:

- Probe: EX3DV4 - SN3924; ConvF(9.95, 9.95, 9.95); Calibrated: 07.10.2015;
- Sensor-Surface: 2mm (Mechanical Surface Detection),  $z = 31.0$
- Electronics: DAE4 Sn1373; Calibrated: 07.23.2015
- Phantom: ELI v5.0; Type: QDOVA002AA; Serial: TP:1208
- DASYS2 52.8.8(1222); SEMCAD X 14.6.10(7331)

**System Performance Check at Frequency 750 MHz Body Tissue/d=15mm, Pin=10 mW, dist=2.0mm (EX-Probe)/Zoom Scan (7x7x7) (5x5x7)/Cube 0:**

Measurement grid:  $dx=8\text{mm}$ ,  $dy=8\text{mm}$ ,  $dz=5\text{mm}$

Reference Value = 10.28 V/m; Power Drift = 0.05 dB

Peak SAR (extrapolated) = 0.115 W/kg

**SAR(1 g) = 0.085 W/kg; SAR(10 g) = 0.057 W/kg**

Maximum value of SAR (measured) = 0.101 W/kg

**System Performance Check at Frequency 750 MHz Body Tissue/d=15mm, Pin=10 mW, dist=2.0mm (EX-Probe)/Area Scan (41x111x1):** Interpolated grid:

$dx=1.500 \text{ mm}$ ,  $dy=1.500 \text{ mm}$

Maximum value of SAR (interpolated) = 0.102 W/kg

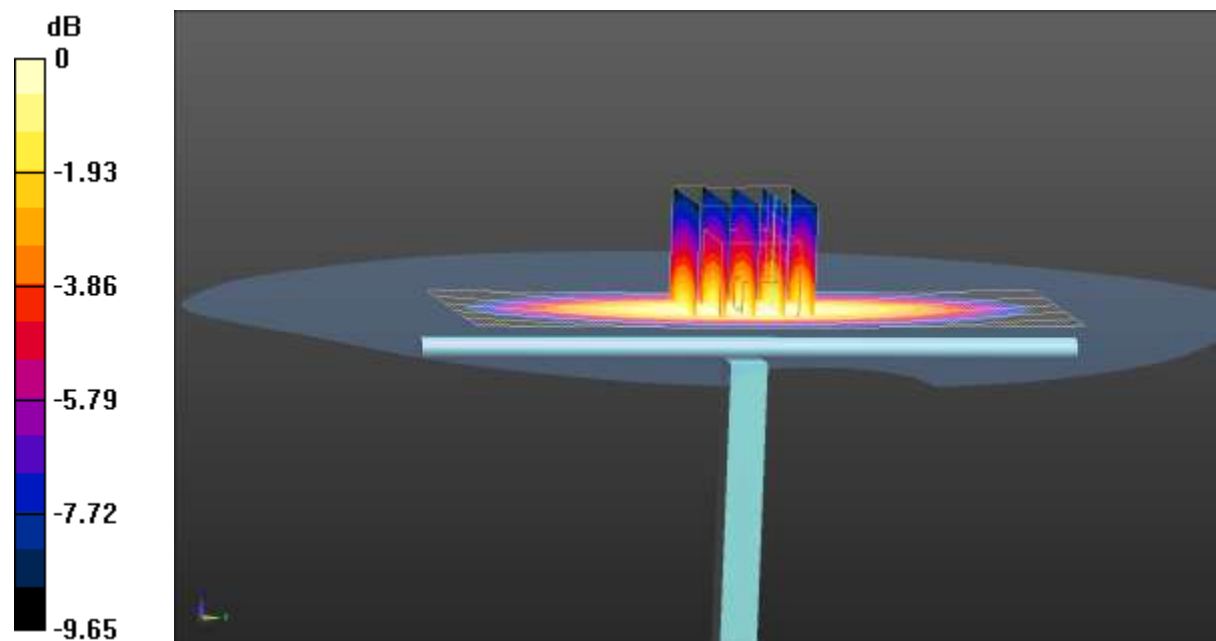

0 dB = 0.102 W/kg = -9.91 dBW/kg

Test Laboratory: CCIS

Date/Time: 11.19.2015 15:47:13

**DUT: Dipole 835 MHz D835V2; Type: SAAAD083BB; Serial: D835V2 - SN:4d154**

Communication System: UID 0, CW (0); Frequency: 835 MHz

Medium parameters used:  $f = 835 \text{ MHz}$ ;  $\sigma = 0.987 \text{ S/m}$ ;  $\epsilon_r = 54.976$ ;  $\rho = 1000 \text{ kg/m}^3$

Phantom section: Flat Section

Measurement Standard: DASYS5 (IEEE/IEC/ANSI C63.19-2007)

DASY Configuration:

- Probe: EX3DV4 - SN3924; ConvF(9.74, 9.74, 9.74); Calibrated: 07.10.2015;
- Sensor-Surface: 2mm (Mechanical Surface Detection),  $z = 31.0$
- Electronics: DAE4 Sn1373; Calibrated: 07.23.2015
- Phantom: ELI v5.0; Type: QDOVA002AA; Serial: TP:1208
- DASYS2 52.8.8(1222); SEMCAD X 14.6.10(7331)

**System Performance Check at Frequency 835 MHz Body Tissue/d=15mm, Pin=10 mW, dist=2.0mm (EX-Probe)/Zoom Scan (7x7x7) (5x5x7)/Cube 0:**

Measurement grid:  $dx=8\text{mm}$ ,  $dy=8\text{mm}$ ,  $dz=5\text{mm}$

Reference Value = 11.34 V/m; Power Drift = -0.07 dB

Peak SAR (extrapolated) = 0.141 W/kg

**SAR(1 g) = 0.096 W/kg; SAR(10 g) = 0.064 W/kg**

Maximum value of SAR (measured) = 0.120 W/kg

**System Performance Check at Frequency 835 MHz Body Tissue/d=15mm, Pin=10 mW, dist=2.0mm (EX-Probe)/Area Scan (41x131x1):** Interpolated grid:

$dx=1.500 \text{ mm}$ ,  $dy=1.500 \text{ mm}$

Maximum value of SAR (interpolated) = 0.120 W/kg

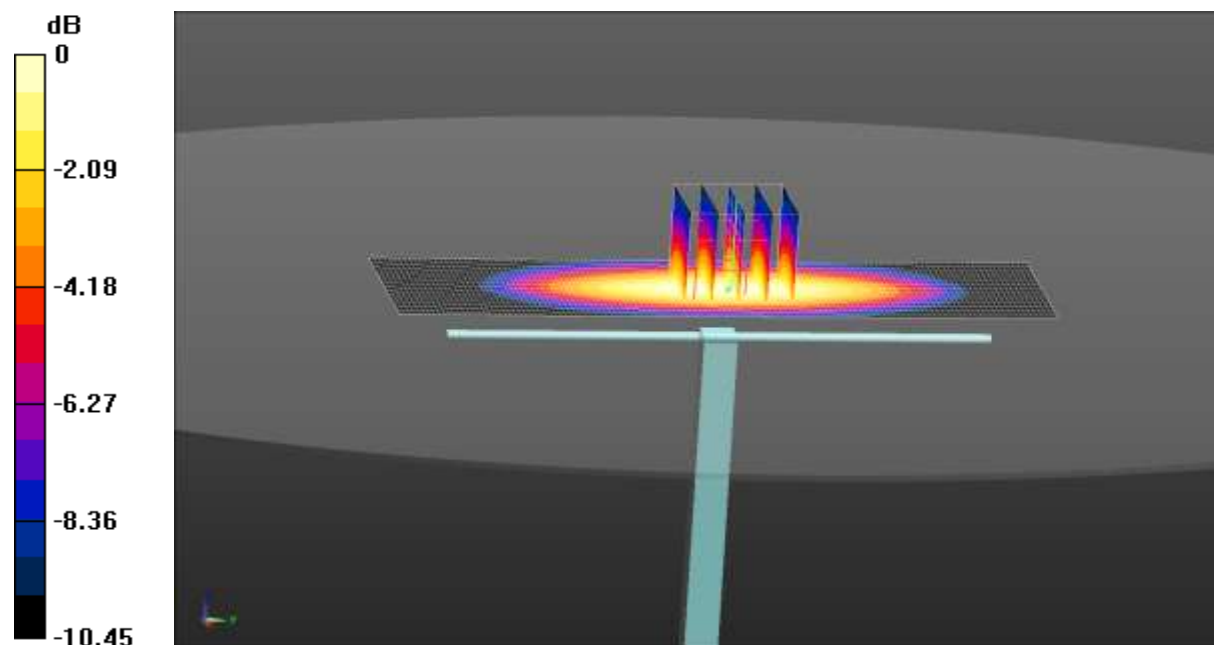

0 dB = 0.120 W/kg = -9.21 dBW/kg

Test Laboratory: CCIS

Date/Time: 11.21.2015 13:47:24

**DUT: Dipole 1750 MHz D1750V2; Type: D1750V2; Serial: 1062**

Communication System: UID 0, CW (0); Frequency: 1750 MHz

Medium parameters used:  $f = 1750 \text{ MHz}$ ;  $\sigma = 1.513 \text{ S/m}$ ;  $\epsilon_r = 54.165$ ;  $\rho = 1000 \text{ kg/m}^3$

Phantom section: Flat Section

Measurement Standard: DASYS5 (IEEE/IEC/ANSI C63.19-2007)

DASY Configuration:

- Probe: EX3DV4 - SN3924; ConvF(7.94, 7.94, 7.94); Calibrated: 07.10.2015;
- Sensor-Surface: 2mm (Mechanical Surface Detection),  $z = 31.0$
- Electronics: DAE4 Sn1373; Calibrated: 07.23.2015
- Phantom: ELI v5.0; Type: QDOVA002AA; Serial: TP:1208
- DASYS2 52.8.8(1222); SEMCAD X 14.6.10(7331)

**System Performance Check at Frequency 1750MHz Body Tissue/d=10mm, Pin=10 mW, dist=2.0mm (EX-Probe)/Area Scan (41x51x1):** Interpolated grid:  $dx=1.500 \text{ mm}$ ,  $dy=1.500 \text{ mm}$

Maximum value of SAR (interpolated) = 0.610 W/kg

**System Performance Check at Frequency 1750MHz Body Tissue/d=10mm, Pin=10 mW, dist=2.0mm (EX-Probe)/Zoom Scan (7x7x7) (5x5x7)/Cube 0:**

Measurement grid:  $dx=8\text{mm}$ ,  $dy=8\text{mm}$ ,  $dz=5\text{mm}$

Reference Value = 17.102 V/m; Power Drift = 0.11 dB

Peak SAR (extrapolated) = 0.709 W/kg

**SAR(1 g) = 0.390 W/kg; SAR(10 g) = 0.226 W/kg**

Maximum value of SAR (measured) = 0.572 W/kg

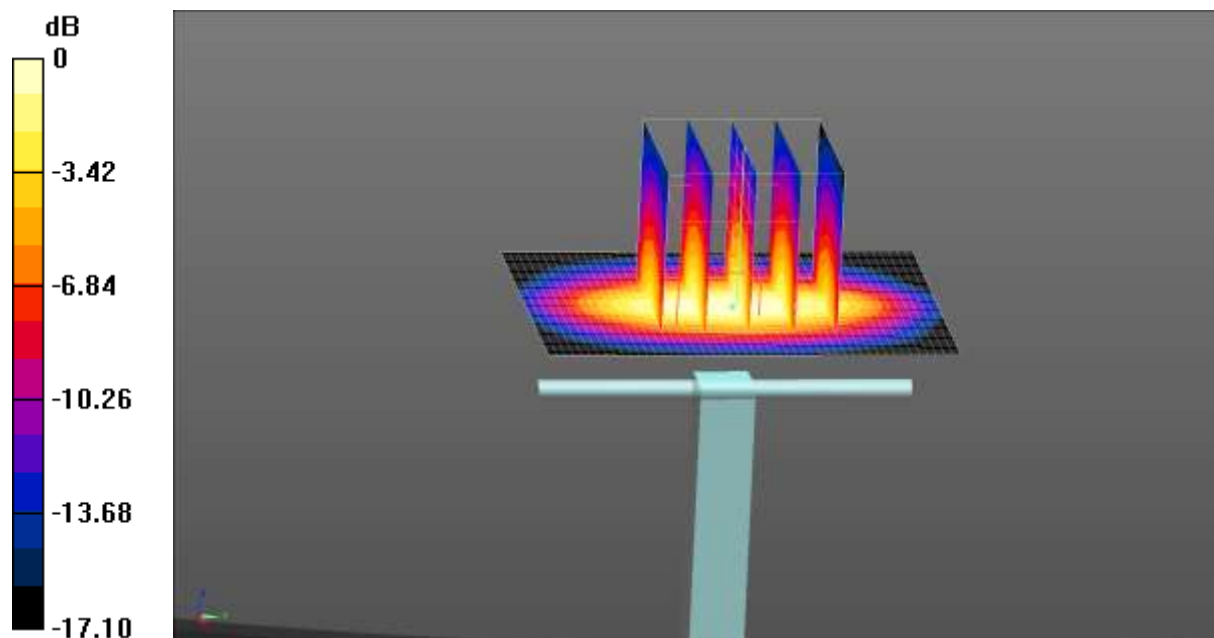

0 dB = 0.572 W/kg = -2.43 dBW/kg

Test Laboratory: CCIS

Date/Time: 11.23.2015 16:46:10

**DUT: Dipole 1900 MHz D1900V2; Type: SAAAD190CB; Serial: D1900V2 - SN:5d175**

Communication System: UID 0, CW (0); Frequency: 1900 MHz

Medium parameters used:  $f = 1900 \text{ MHz}$ ;  $\sigma = 1.497 \text{ S/m}$ ;  $\epsilon_r = 52.928$ ;  $\rho = 1000 \text{ kg/m}^3$

Phantom section: Flat Section

Measurement Standard: DASYS (IEEE/IEC/ANSI C63.19-2007)

DASY Configuration:

- Probe: EX3DV4 - SN3924; ConvF(7.65, 7.65, 7.65); Calibrated: 07.10.2015;
- Sensor-Surface: 2mm (Mechanical Surface Detection),  $z = 31.0$
- Electronics: DAE4 Sn1373; Calibrated: 07.23.2015
- Phantom: ELI v5.0; Type: QDOVA002AA; Serial: TP:1208
- DASYS2 52.8.8(1222); SEMCAD X 14.6.10(7331)

**System Performance Check at Frequency 1900MHz Body Tissue/d=10mm, Pin=10 mW, dist=2.0mm (EX-Probe)/Zoom Scan (7x7x7) (5x5x7)/Cube 0:**

Measurement grid:  $dx=8\text{mm}$ ,  $dy=8\text{mm}$ ,  $dz=5\text{mm}$

Reference Value = 20.38 V/m; Power Drift = -0.04 dB

Peak SAR (extrapolated) = 0.721 W/kg

**SAR(1 g) = 0.401 W/kg; SAR(10 g) = 0.210 W/kg**

Maximum value of SAR (measured) = 0.581 W/kg

**System Performance Check at Frequency 1900MHz Body Tissue/d=10mm, Pin=10 mW, dist=2.0mm (EX-Probe)/Area Scan (41x51x1):** Interpolated grid:

$dx=1.500 \text{ mm}$ ,  $dy=1.500 \text{ mm}$

Maximum value of SAR (interpolated) = 0.611 W/kg

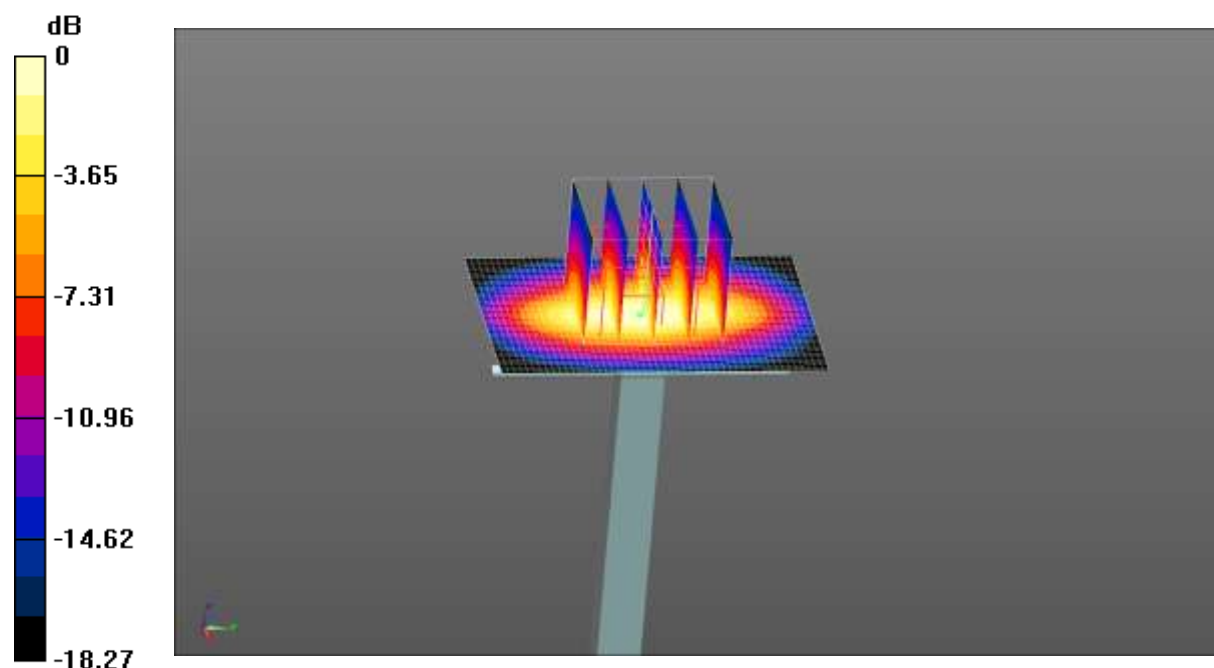

0 dB = 0.611 W/kg = -2.14 dBW/kg



Test Laboratory: CCIS

Date/Time: 12.18.2015 10:07:53

**DUT: Dipole 2450 MHz D2450V2; Type: D2450V2; Serial: D2450V2 - SN:910**

Communication System: UID 0, CW (0); Frequency: 2450 MHz

Medium parameters used:  $f = 2450$  MHz;  $\sigma = 1.922$  S/m;  $\epsilon_r = 53.06$ ;  $\rho = 1000$  kg/m<sup>3</sup>

Phantom section: Flat Section

Measurement Standard: DASYS (IEEE/IEC/ANSI C63.19-2007)

DASY Configuration:

- Probe: EX3DV4 - SN3924; ConvF(7.3, 7.3, 7.3); Calibrated: 07.10.2015;
- Sensor-Surface: 2mm (Mechanical Surface Detection),  $z = 1.0, 31.0$
- Electronics: DAE4 Sn1373; Calibrated: 07.23.2015
- Phantom: SAM 5.0; Type: QD000P40CD; Serial: TP:1765
- DASY52 52.8.8(1222); SEMCAD X 14.6.10(7331)

**System Performance Check at Frequency 2450MHz Body Tissue/d=10mm, Pin=10 mW, dist=2.0mm (EX-Probe)/Area Scan (51x61x1):** Interpolated grid:  $dx=1.200$  mm,  $dy=1.200$  mm

Maximum value of SAR (interpolated) = 0.833 W/kg

**System Performance Check at Frequency 2450MHz Body Tissue/d=10mm, Pin=10 mW, dist=2.0mm (EX-Probe)/Zoom Scan (7x7x7) (7x7x7)/Cube 0:**

Measurement grid:  $dx=5$ mm,  $dy=5$ mm,  $dz=5$ mm

Reference Value = 20.12 V/m; Power Drift = -0.10 dB

Peak SAR (extrapolated) = 1.01 W/kg

**SAR(1 g) = 0.522 W/kg; SAR(10 g) = 0.246 W/kg**

Maximum value of SAR (measured) = 0.784 W/kg

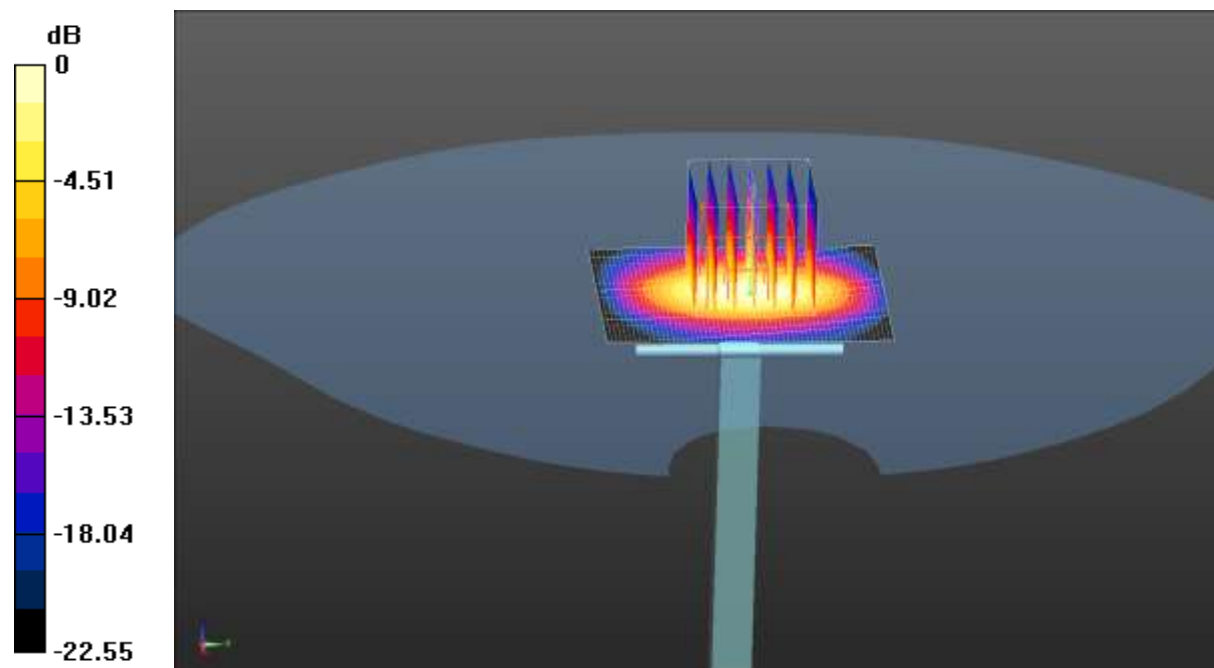

0 dB = 0.784 W/kg = -1.06 dBW/kg

Test Laboratory: CCIS

Date/Time: 12.14.2015 08:09:16

**DUT: Dipole 2600 MHz; Type: D2600V2; Serial: D2600V2 - SN:1114**

Communication System: UID 0, CW (0); Frequency: 2600 MHz

Medium parameters used:  $f = 2600$  MHz;  $\sigma = 2.135$  S/m;  $\epsilon_r = 52.089$ ;  $\rho = 1000$  kg/m<sup>3</sup>

Phantom section: Flat Section

Measurement Standard: DASY5 (IEEE/IEC/ANSI C63.19-2007)

DASY Configuration:

- Probe: EX3DV4 - SN3924; ConvF(7.2, 7.2, 7.2); Calibrated: 07.10.2015;
- Sensor-Surface: 2mm (Mechanical Surface Detection),  $z = 1.0, 31.0$
- Electronics: DAE4 Sn1373; Calibrated: 07.23.2015
- Phantom: ELI v5.0; Type: QDOVA002AA; Serial: TP:1208
- DASY52 52.8.8(1222); SEMCAD X 14.6.10(7331)

**System Performance Check at Frequency 2600MHz Body Tissue/d=10mm, Pin=25 mW, dist=2.0mm (EX-Probe)/Area Scan (51x61x1):** Interpolated grid: dx=1.200 mm, dy=1.200 mm

Maximum value of SAR (interpolated) = 2.19 W/kg

**System Performance Check at Frequency 2600MHz Body Tissue/d=10mm, Pin=25 mW, dist=2.0mm (EX-Probe)/Zoom Scan (7x7x7) (7x7x7)/Cube 0:**

Measurement grid: dx=5mm, dy=5mm, dz=5mm

Reference Value = 32.02 V/m; Power Drift = -0.09 dB

Peak SAR (extrapolated) = 2.75 W/kg

**SAR(1 g) = 1.34 W/kg; SAR(10 g) = 0.612 W/kg**

Maximum value of SAR (measured) = 2.12 W/kg

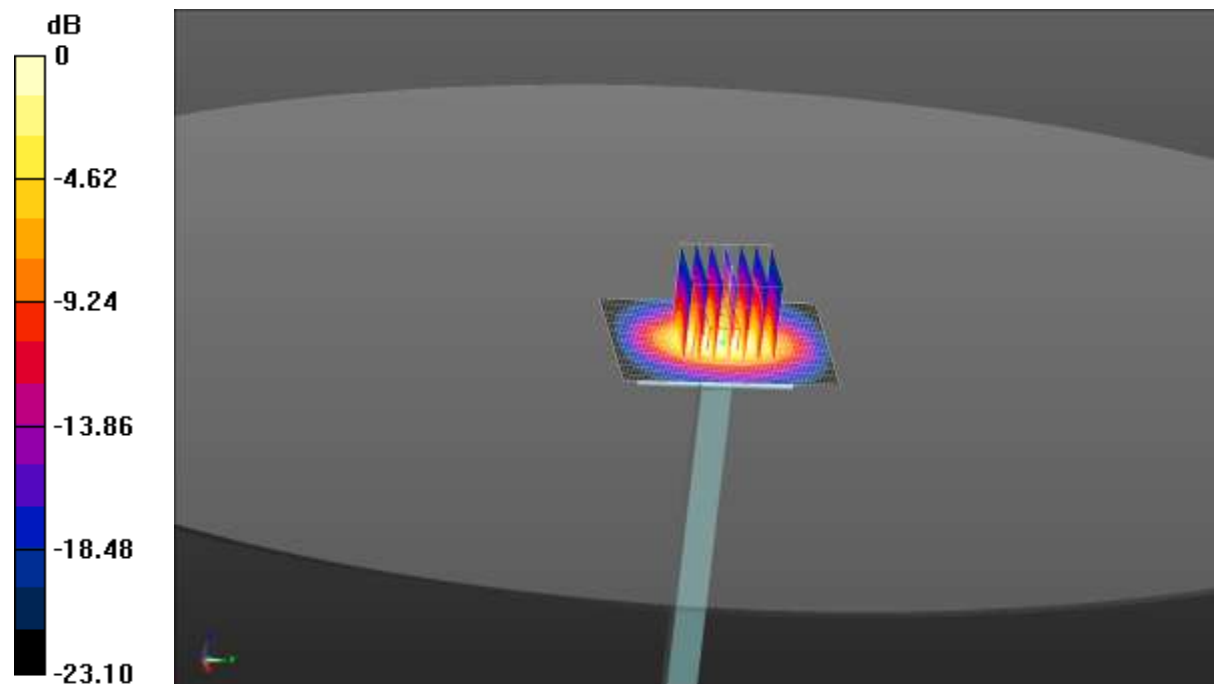

0 dB = 2.12 W/kg = 3.26 dBW/kg

## Appendix D: Plots of SAR Test Data

Test Laboratory: CCIS

Date/Time: 11.19.2015 17:31:22

**DUT: Global Mobile WiFi Travel Router; Type: fi1; Serial: 1#**

Communication System: UID 0, GPRS(3 Slots) (0); Frequency: 848.8 MHz

Medium parameters used (interpolated):  $f = 848.8$  MHz;  $\sigma = 1.006$  S/m;  $\epsilon_r = 55.126$ ;  $\rho = 1000$  kg/m<sup>3</sup>

Phantom section: Flat Section

Measurement Standard: DASYS5 (IEEE/IEC/ANSI C63.19-2007)

DASY Configuration:

- Probe: EX3DV4 - SN3924; ConvF(9.74, 9.74, 9.74); Calibrated: 07.10.2015;
- Sensor-Surface: 2mm (Mechanical Surface Detection),  $z = 31.0$
- Electronics: DAE4 Sn1373; Calibrated: 07.23.2015
- Phantom: ELI v5.0; Type: QDOVA002AA; Serial: TP:1208
- DASYS2 52.8.8(1222); SEMCAD X 14.6.10(7331)

**GPRS 850 3Slots Body Back/High Channel/Zoom Scan (5x5x7)/Cube 0:**

Measurement grid:  $dx=8$ mm,  $dy=8$ mm,  $dz=5$ mm

Reference Value = 25.54 V/m; Power Drift = -0.10 dB

Peak SAR (extrapolated) = 0.733 W/kg

**SAR(1 g) = 0.581 W/kg; SAR(10 g) = 0.445 W/kg**

Maximum value of SAR (measured) = 0.661 W/kg

**GPRS 850 3Slots Body Back/High Channel/Area Scan (41x71x1):** Interpolated

grid:  $dx=1.500$  mm,  $dy=1.500$  mm

Maximum value of SAR (interpolated) = 0.680 W/kg

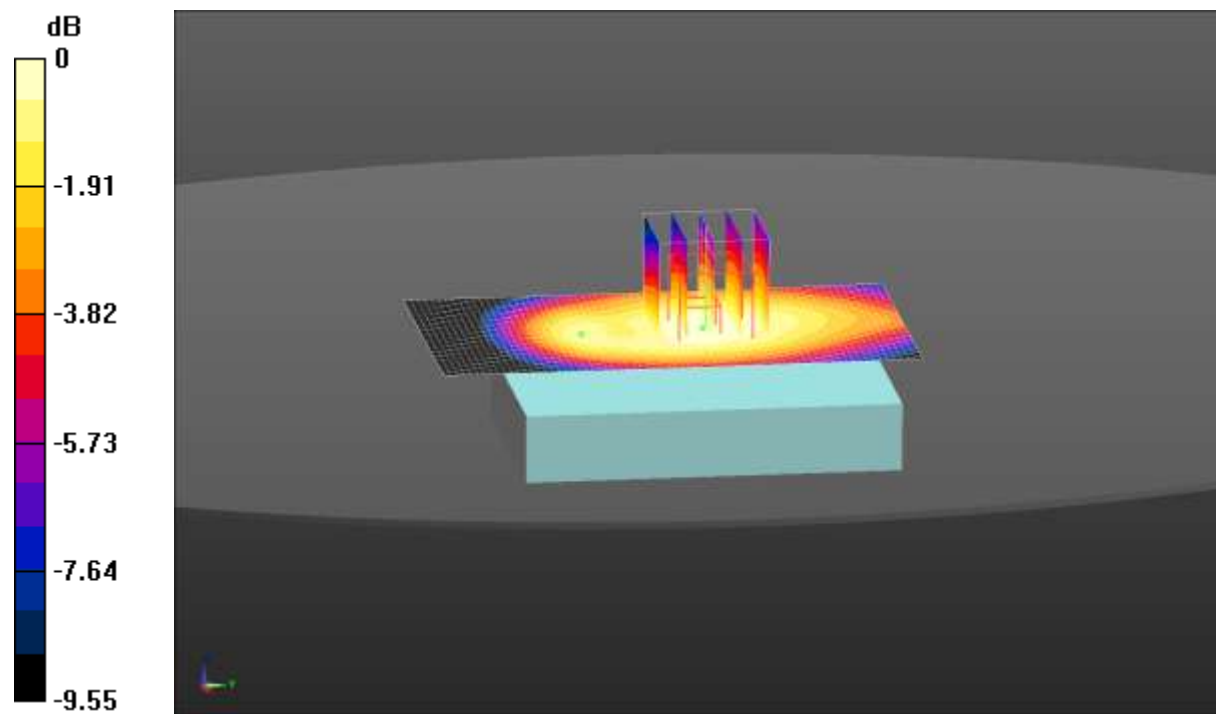

0 dB = 0.680 W/kg = -1.67 dBW/kg

Test Laboratory: CCIS

Date/Time: 11.23.2015 19:17:13

**DUT: Global Mobile WiFi Travel Router; Type: fi1; Serial: 1#**

Communication System: UID 0, GPRS(3 Slots) (0); Frequency: 1850.2 MHz

Medium parameters used (interpolated):  $f = 1850.2$  MHz;  $\sigma = 1.53$  S/m;  $\epsilon_r = 52.63$ ;  $\rho = 1000$  kg/m<sup>3</sup>

Phantom section: Flat Section

Measurement Standard: DASY5 (IEEE/IEC/ANSI C63.19-2007)

DASY Configuration:

- Probe: EX3DV4 - SN3924; ConvF(7.65, 7.65, 7.65); Calibrated: 07.10.2015;
- Sensor-Surface: 2mm (Mechanical Surface Detection),  $z = 1.0, 31.0$
- Electronics: DAE4 Sn1373; Calibrated: 07.23.2015
- Phantom: ELI v5.0; Type: QDOVA002AA; Serial: TP:1208
- DASY52 52.8.8(1222); SEMCAD X 14.6.10(7331)

**GPRS 1900 3Slots Body Front Repeat/Low Channel/Area Scan (41x71x1):**

Interpolated grid:  $dx=1.500$  mm,  $dy=1.500$  mm

Maximum value of SAR (interpolated) = 1.18 W/kg

**GPRS 1900 3Slots Body Front Repeat/Low Channel/Zoom Scan (5x5x7)/Cube**

**0:** Measurement grid:  $dx=8$ mm,  $dy=8$ mm,  $dz=5$ mm

Reference Value = 16.14 V/m; Power Drift = -0.13 dB

Peak SAR (extrapolated) = 1.51 W/kg

**SAR(1 g) = 0.945 W/kg; SAR(10 g) = 0.533 W/kg**

Maximum value of SAR (measured) = 1.19 W/kg

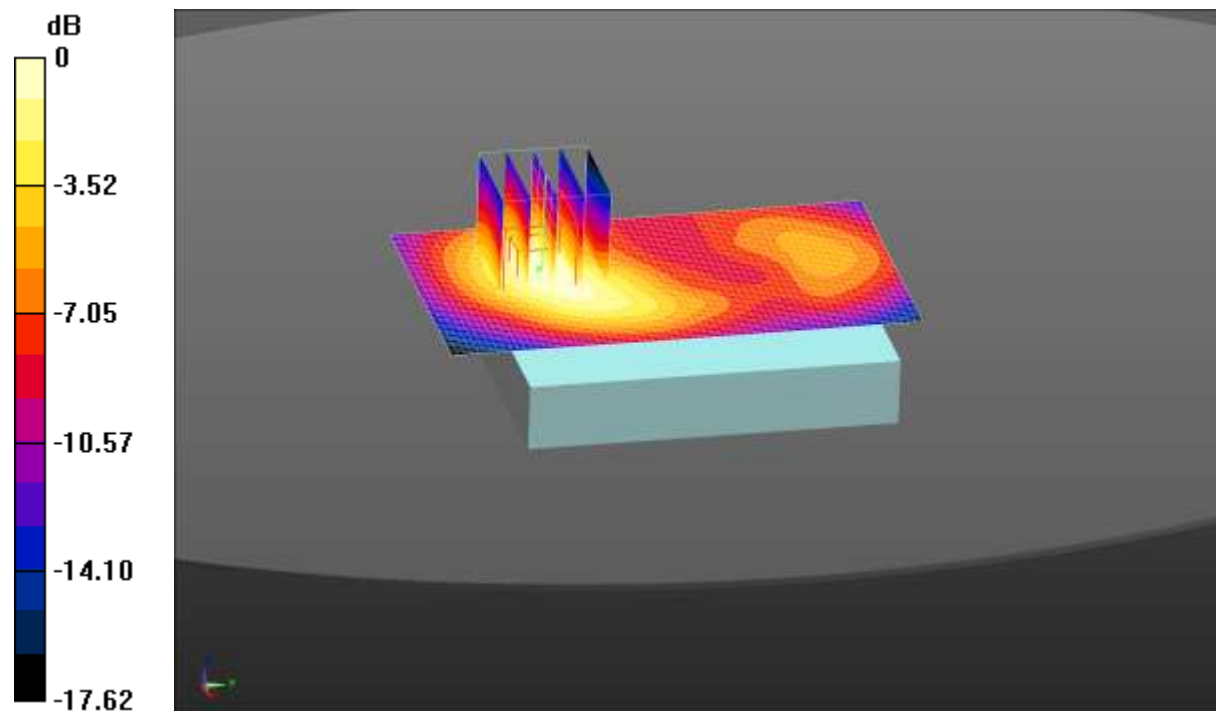

0 dB = 1.19 W/kg = 0.76 dBW/kg

Test Laboratory: CCIS

Date/Time: 11.20.2015 08:23:38

**DUT: Global Mobile WiFi Travel Router; Type: fi1; Serial: 1#**

Communication System: UID 0, UMTS-FDD(WCDMA) (0); Frequency: 836.6 MHz  
 Medium parameters used (interpolated):  $f = 836.6$  MHz;  $\sigma = 0.982$  S/m;  $\epsilon_r = 54.498$ ;  $\rho = 1000$  kg/m<sup>3</sup>  
 Phantom section: Flat Section  
 Measurement Standard: DASYS5 (IEEE/IEC/ANSI C63.19-2007)

DASY Configuration:

- Probe: EX3DV4 - SN3924; ConvF(9.74, 9.74, 9.74); Calibrated: 07.10.2015;
- Sensor-Surface: 2mm (Mechanical Surface Detection),  $z = 1.0, 31.0$
- Electronics: DAE4 Sn1373; Calibrated: 07.23.2015
- Phantom: ELI v5.0; Type: QDOVA002AA; Serial: TP:1208
- DASYS2 52.8.8(1222); SEMCAD X 14.6.10(7331)

**WCDMA 850 Body Back/Middle Channel/Area Scan (41x71x1):** Interpolated grid:  
 $dx=1.500$  mm,  $dy=1.500$  mm  
 Maximum value of SAR (interpolated) = 0.677 W/kg

**WCDMA 850 Body Back/Middle Channel/Zoom Scan (5x5x7)/Cube 0:**  
 Measurement grid:  $dx=8$ mm,  $dy=8$ mm,  $dz=5$ mm  
 Reference Value = 26.11 V/m; Power Drift = 0.14 dB  
 Peak SAR (extrapolated) = 0.741 W/kg  
**SAR(1 g) = 0.600 W/kg; SAR(10 g) = 0.468 W/kg**  
 Maximum value of SAR (measured) = 0.678 W/kg

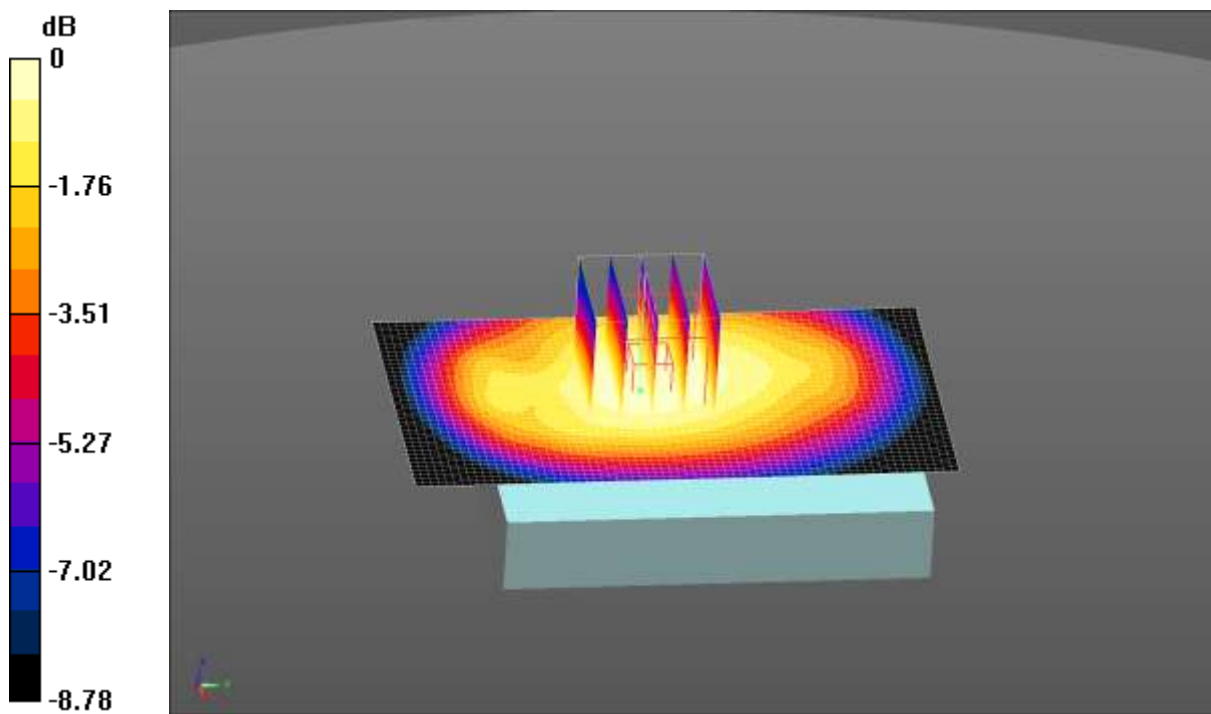

0 dB = 0.678 W/kg = -1.69 dBW/kg

Test Laboratory: CCIS

Date/Time: 11.23.2015 21:46:56

**DUT: Global Mobile WiFi Travel Router; Type: fi1; Serial: 1#**

Communication System: UID 0, UMTS-FDD(WCDMA) (0); Frequency: 1880 MHz  
 Medium parameters used:  $f = 1880$  MHz;  $\sigma = 1.48$  S/m;  $\epsilon_r = 51.657$ ;  $\rho = 1000$  kg/m<sup>3</sup>  
 Phantom section: Flat Section  
 Measurement Standard: DASYS5 (IEEE/IEC/ANSI C63.19-2007)

DASY Configuration:

- Probe: EX3DV4 - SN3924; ConvF(7.65, 7.65, 7.65); Calibrated: 07.10.2015;
- Sensor-Surface: 2mm (Mechanical Surface Detection),  $z = 31.0$
- Electronics: DAE4 Sn1373; Calibrated: 07.23.2015
- Phantom: ELI v5.0; Type: QDOVA002AA; Serial: TP:1208
- DASYS2 52.8.8(1222); SEMCAD X 14.6.10(7331)

**WCDMA 1900 Body Front/Middle Channel/Zoom Scan (5x5x7)/Cube 0:**

Measurement grid:  $dx=8$ mm,  $dy=8$ mm,  $dz=5$ mm  
 Reference Value = 10.54 V/m; Power Drift = -0.20 dB  
 Peak SAR (extrapolated) = 1.54 W/kg  
**SAR(1 g) = 0.961 W/kg; SAR(10 g) = 0.539 W/kg**  
 Maximum value of SAR (measured) = 1.28 W/kg

**WCDMA 1900 Body Front/Middle Channel/Area Scan (41x71x1):** Interpolated grid:  $dx=1.500$  mm,  $dy=1.500$  mm  
 Maximum value of SAR (interpolated) = 1.13 W/kg

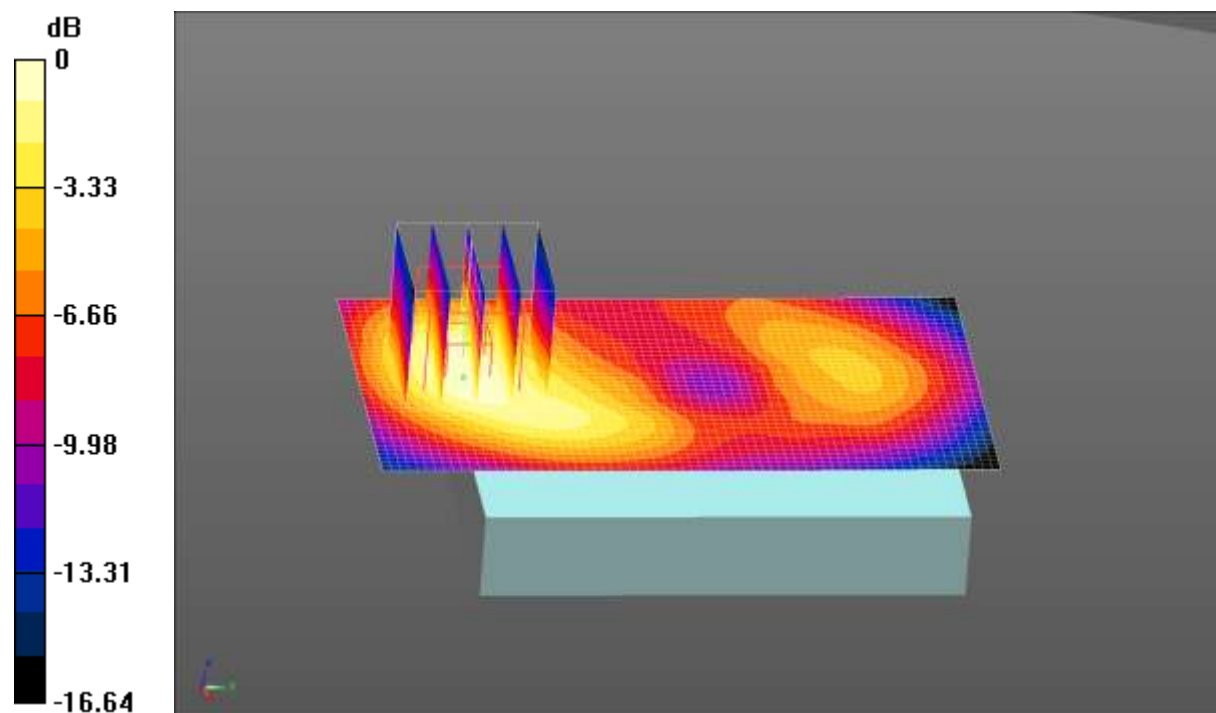

0 dB = 1.13 W/kg = 0.53 dBW/kg



Test Laboratory: CCIS

Date/Time: 11.21.2015 14:07:39

**DUT: Global Mobile WiFi Travel Router; Type: fi1; Serial: 1#**

Communication System: UID 0, LTE-Fdd(USA) 1RB QPSK (0); Frequency: 1732.5 MHz  
 Medium parameters used (interpolated):  $f = 1732.5$  MHz;  $\sigma = 1.505$  S/m;  $\epsilon_r = 55.13$ ;  $\rho = 1000$  kg/m<sup>3</sup>  
 Phantom section: Flat Section  
 Measurement Standard: DASY5 (IEEE/IEC/ANSI C63.19-2007)

DASY Configuration:

- Probe: EX3DV4 - SN3924; ConvF(7.94, 7.94, 7.94); Calibrated: 07.10.2015;
- Sensor-Surface: 2mm (Mechanical Surface Detection),  $z = 31.0$
- Electronics: DAE4 Sn1373; Calibrated: 07.23.2015
- Phantom: ELI v5.0; Type: QDOVA002AA; Serial: TP:1208
- DASY52 52.8.8(1222); SEMCAD X 14.6.10(7331)

**LTE Band4 1RB 20(MHZ) Body Front/Middle Channel/Zoom Scan**

**(5x5x7)/Cube 0:** Measurement grid:  $dx=8$ mm,  $dy=8$ mm,  $dz=5$ mm  
 Reference Value = 7.953 V/m; Power Drift = 0.09 dB  
 Peak SAR (extrapolated) = 0.876 W/kg  
**SAR(1 g) = 0.550 W/kg; SAR(10 g) = 0.309 W/kg**  
 Maximum value of SAR (measured) = 0.712 W/kg

**LTE Band4 1RB 20(MHZ) Body Front/Middle Channel/Area Scan (41x71x1):**

Interpolated grid:  $dx=1.500$  mm,  $dy=1.500$  mm  
 Maximum value of SAR (interpolated) = 0.564 W/kg

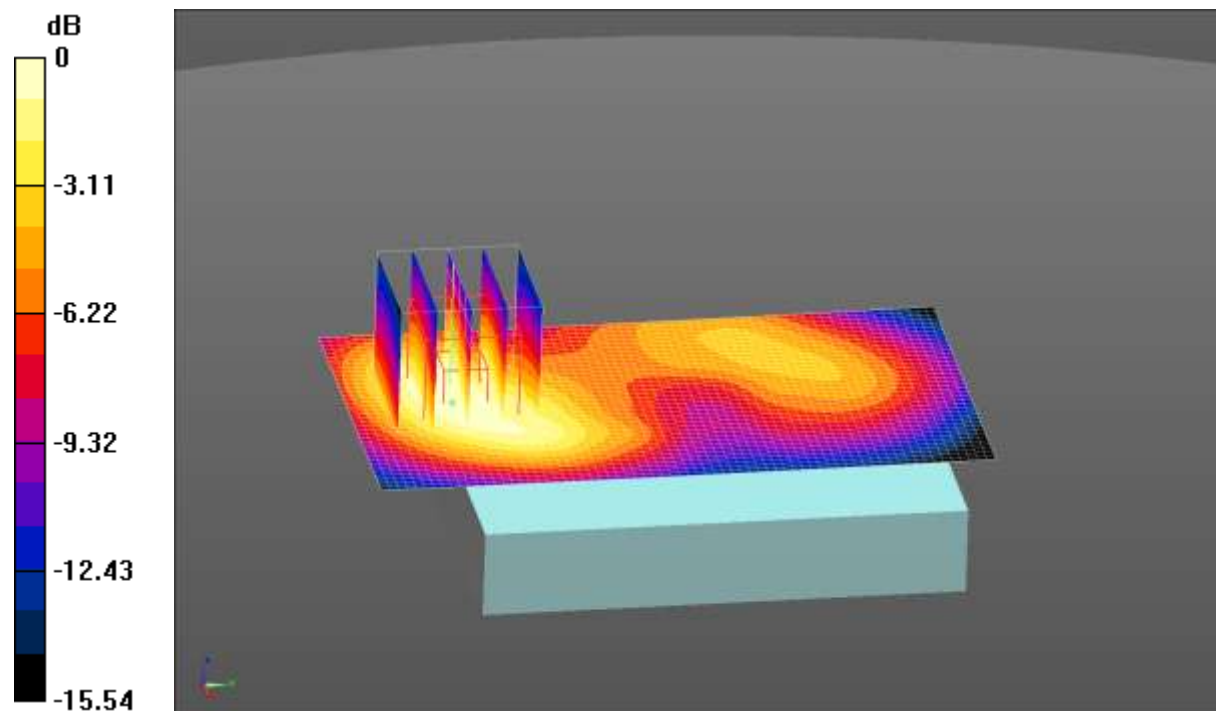

0 dB = 0.564 W/kg = -2.49 dBW/kg

Test Laboratory: CCIS

Date/Time: 12.14.2015 09:05:23

**DUT: Global Mobile WiFi Travel Router; Type: fi1; Serial: 1#**

Communication System: UID 0, LTE-FDD (USA) 20MHz 100%RB QPSK (0); Frequency: 2560 MHz

Medium parameters used:  $f = 2560 \text{ MHz}$ ;  $\sigma = 2.012 \text{ S/m}$ ;  $\epsilon_r = 50.742$ ;  $\rho = 1000 \text{ kg/m}^3$

Phantom section: Flat Section

Measurement Standard: DASYS5 (IEEE/IEC/ANSI C63.19-2007)

DASY Configuration:

- Probe: EX3DV4 - SN3924; ConvF(7.2, 7.2, 7.2); Calibrated: 07.10.2015;
- Sensor-Surface: 2mm (Mechanical Surface Detection),  $z = 31.0$
- Electronics: DAE4 Sn1373; Calibrated: 07.23.2015
- Phantom: ELI v5.0; Type: QDOVA002AA; Serial: TP:1208
- DASYS2 52.8.8(1222); SEMCAD X 14.6.10(7331)

**LTE Band 7 1RB 20(MHZ) Body Front/High Channel/Zoom Scan**

**(5x5x7)/Cube 0:** Measurement grid:  $dx=5\text{mm}$ ,  $dy=5\text{mm}$ ,  $dz=5\text{mm}$

Reference Value = 7.164 V/m; Power Drift = -0.25 dB

Peak SAR (extrapolated) = 1.07 W/kg

**SAR(1 g) = 0.635 W/kg; SAR(10 g) = 0.260 W/kg**

Maximum value of SAR (measured) = 0.934 W/kg

**LTE Band 7 1RB 20(MHZ) Body Front/High Channel/Area Scan (41x71x1):**

Interpolated grid:  $dx=1.200 \text{ mm}$ ,  $dy=1.200 \text{ mm}$

Maximum value of SAR (interpolated) = 0.980 W/kg

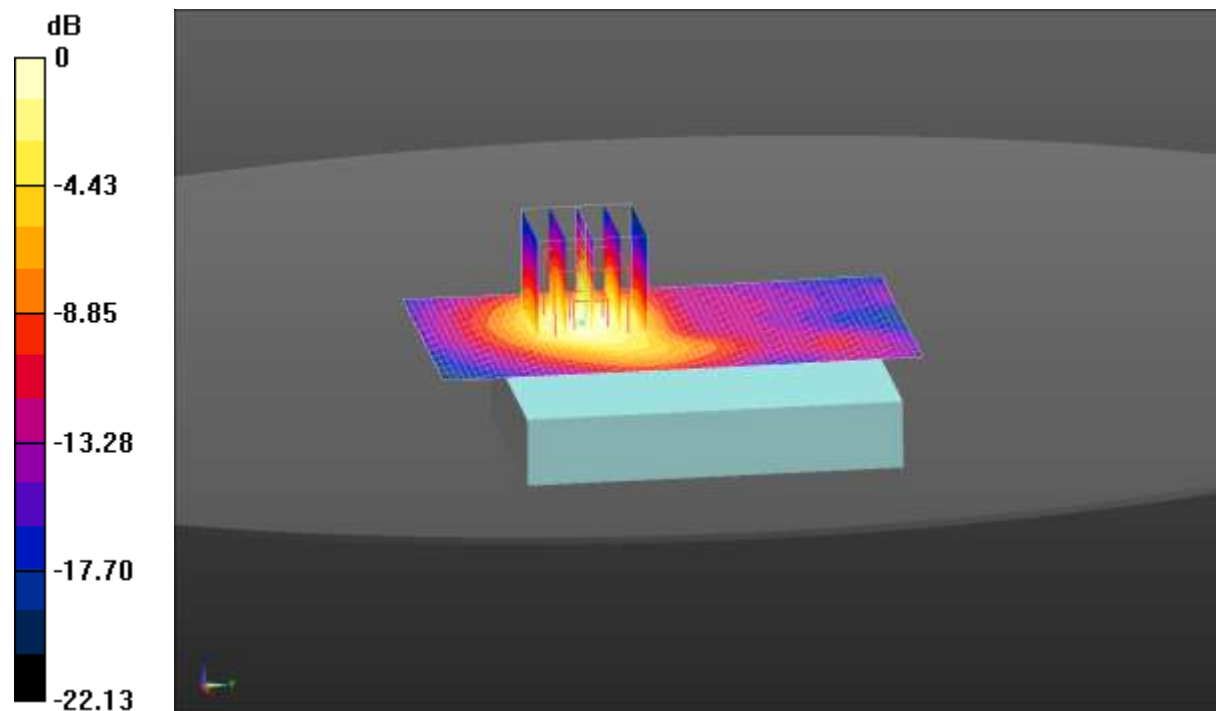

0 dB = 0.980 W/kg = 0.09 dBW/kg

Test Laboratory: CCIS

Date/Time: 11.25.2015 08:21:29

**DUT: Global Mobile WiFi Travel Router; Type: fi1; Serial: 1#**

Communication System: UID 0, LTE-Fdd(USA) 1RB QPSK (0); Frequency: 711 MHz  
 Medium parameters used (interpolated):  $f = 711 \text{ MHz}$ ;  $\sigma = 0.86 \text{ S/m}$ ;  $\epsilon_r = 42.412$ ;  $\rho = 1000 \text{ kg/m}^3$   
 Phantom section: Flat Section  
 Measurement Standard: DASY5 (IEEE/IEC/ANSI C63.19-2007)

DASY Configuration:

- Probe: EX3DV4 - SN3924; ConvF(9.95, 9.95, 9.95); Calibrated: 07.10.2015;
- Sensor-Surface: 2mm (Mechanical Surface Detection),  $z = 31.0$
- Electronics: DAE4 Sn1373; Calibrated: 07.23.2015
- Phantom: ELI v5.0; Type: QDOVA002AA; Serial: TP:1208
- DASY52 52.8.8(1222); SEMCAD X 14.6.10(7331)

**LTE Band17 1RB 10(MHZ) Body Back/High Channel/Zoom Scan**

**(5x5x7)/Cube 0:** Measurement grid:  $dx=8\text{mm}$ ,  $dy=8\text{mm}$ ,  $dz=5\text{mm}$   
 Reference Value =  $24.25 \text{ V/m}$ ; Power Drift =  $-0.25 \text{ dB}$   
 Peak SAR (extrapolated) =  $0.872 \text{ W/kg}$   
**SAR(1 g) = 0.629 W/kg; SAR(10 g) = 0.451 W/kg**  
 Maximum value of SAR (measured) =  $0.754 \text{ W/kg}$

**LTE Band17 1RB 10(MHZ) Body Back/High Channel/Area Scan (41x71x1):**

Interpolated grid:  $dx=1.500 \text{ mm}$ ,  $dy=1.500 \text{ mm}$   
 Maximum value of SAR (interpolated) =  $0.741 \text{ W/kg}$

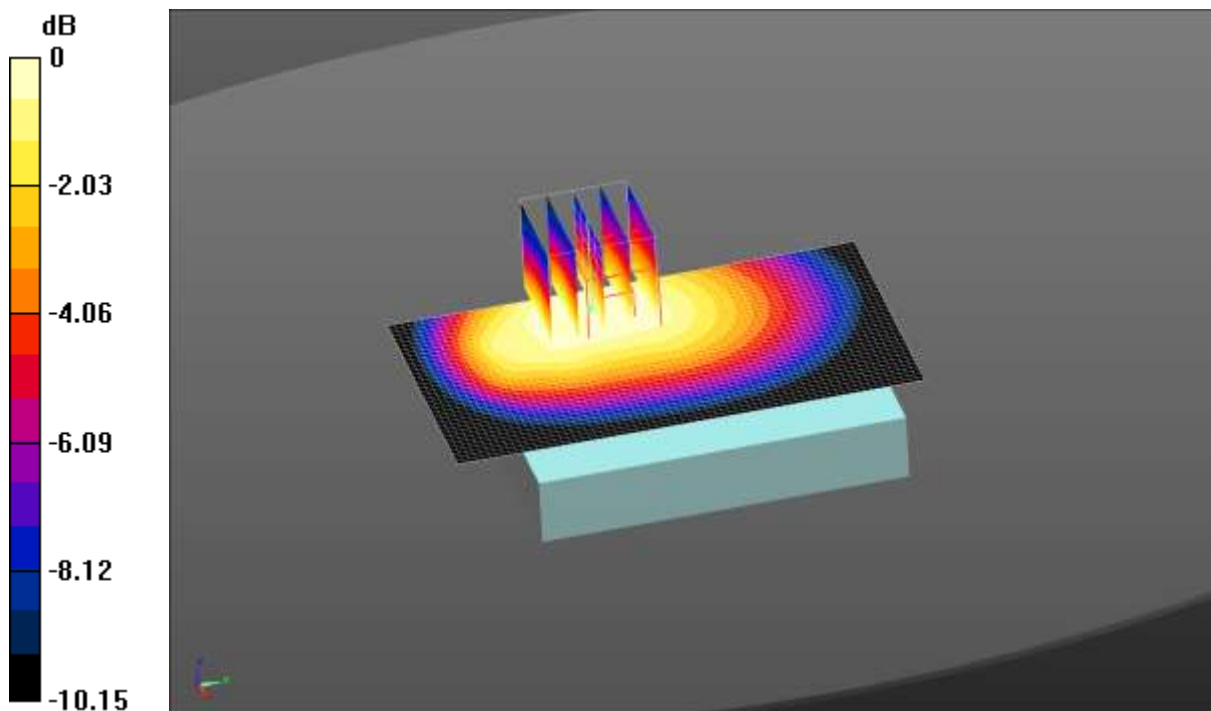

0 dB =  $0.741 \text{ W/kg} = -1.30 \text{ dBW/kg}$

Test Laboratory: CCIS

Date/Time: 11.21.2015 16:03:16

**DUT: Global Mobile WiFi Travel Router; Type: fi1; Serial: 1#**

Communication System: UID 0, LTE-FDD(USA) 20MHz 50%RB QPSK (0); Frequency: 1732.5 MHz

Medium parameters used (interpolated):  $f = 1732.5$  MHz;  $\sigma = 1.505$  S/m;  $\epsilon_r = 55.13$ ;  $\rho = 1000$  kg/m<sup>3</sup>

Phantom section: Flat Section

Measurement Standard: DASYS5 (IEEE/IEC/ANSI C63.19-2007)

DASY Configuration:

- Probe: EX3DV4 - SN3924; ConvF(7.94, 7.94, 7.94); Calibrated: 07.10.2015;
- Sensor-Surface: 2mm (Mechanical Surface Detection),  $z = 31.0$
- Electronics: DAE4 Sn1373; Calibrated: 07.23.2015
- Phantom: ELI v5.0; Type: QDOVA002AA; Serial: TP:1208
- DASYS2 52.8.8(1222); SEMCAD X 14.6.10(7331)

**LTE Band4 50%RB 20(MHZ) Body Front/Middle Channel/Zoom Scan**

**(5x5x7)/Cube 0:** Measurement grid:  $dx=8$ mm,  $dy=8$ mm,  $dz=5$ mm

Reference Value = 10.70 V/m; Power Drift = 0.10 dB

Peak SAR (extrapolated) = 0.838 W/kg

**SAR(1 g) = 0.518 W/kg; SAR(10 g) = 0.287 W/kg**

Maximum value of SAR (measured) = 0.647 W/kg

**LTE Band4 50%RB 20(MHZ) Body Front/Middle Channel/Area Scan**

**(41x71x1):** Interpolated grid:  $dx=1.500$  mm,  $dy=1.500$  mm

Maximum value of SAR (interpolated) = 0.676 W/kg

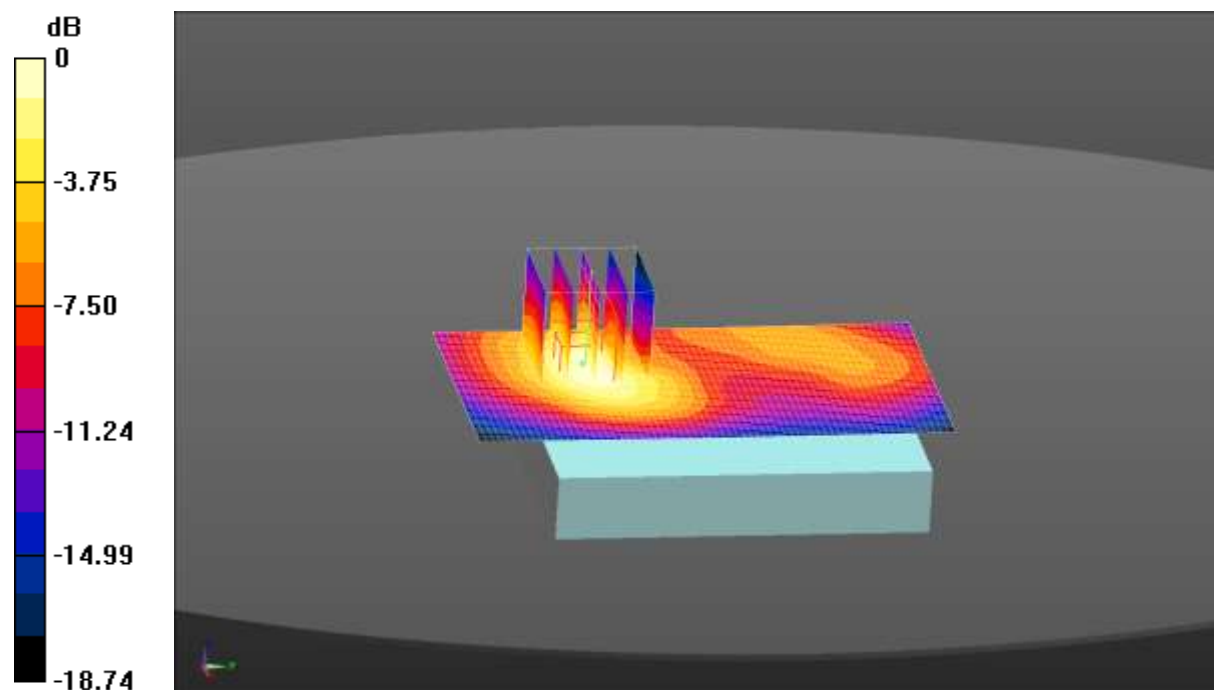

0 dB = 0.676 W/kg = -1.70 dBW/kg

Test Laboratory: CCIS

Date/Time: 12.14.2015 11:18:50

**DUT: Global Mobile WiFi Travel Router; Type: fi1; Serial: 1#**

Communication System: UID 0, LTE-FDD(USA) 20MHz 50%RB QPSK (0); Frequency: 2560 MHz

Medium parameters used:  $f = 2560 \text{ MHz}$ ;  $\sigma = 2.012 \text{ S/m}$ ;  $\epsilon_r = 50.742$ ;  $\rho = 1000 \text{ kg/m}^3$

Phantom section: Flat Section

Measurement Standard: DASY5 (IEEE/IEC/ANSI C63.19-2007)

DASY Configuration:

- Probe: EX3DV4 - SN3924; ConvF(7.2, 7.2, 7.2); Calibrated: 07.10.2015;
- Sensor-Surface: 2mm (Mechanical Surface Detection),  $z = 31.0$
- Electronics: DAE4 Sn1373; Calibrated: 07.23.2015
- Phantom: ELI v5.0; Type: QDOVA002AA; Serial: TP:1208
- DASY52 52.8.8(1222); SEMCAD X 14.6.10(7331)

**LTE Band 7 50%RB 20(MHZ) Body Front/High Channel/Zoom Scan**

**(5x5x7)/Cube 0:** Measurement grid:  $dx=5\text{mm}$ ,  $dy=5\text{mm}$ ,  $dz=5\text{mm}$

Reference Value = 7.182 V/m; Power Drift = -0.08 dB

Peak SAR (extrapolated) = 0.994 W/kg

**SAR(1 g) = 0.580 W/kg; SAR(10 g) = 0.217 W/kg**

Maximum value of SAR (measured) = 0.872 W/kg

**LTE Band 7 50%RB 20(MHZ) Body Front/High Channel/Area Scan**

**(41x71x1):** Interpolated grid:  $dx=1.200 \text{ mm}$ ,  $dy=1.200 \text{ mm}$

Maximum value of SAR (interpolated) = 0.891 W/kg

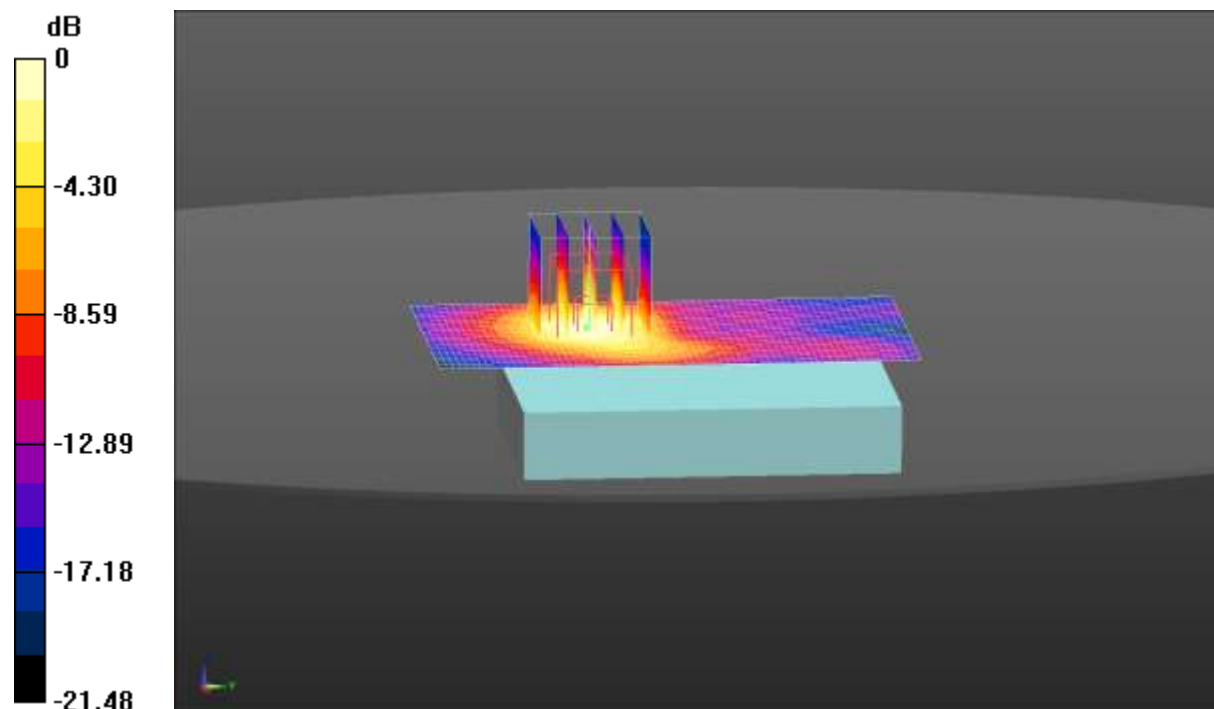

0 dB = 0.891 W/kg = -0.5 dBW/kg

Test Laboratory: CCIS

Date/Time: 11.25.2015 10:20:39

**DUT: Global Mobile WiFi Travel Routel; Type: XG1; Serial: 1#**

Communication System: UID 0, LTE-FDD (USA) 10MHz 50%RB QPSK (0); Frequency: 710 MHz

Medium parameters used (interpolated):  $f = 710 \text{ MHz}$ ;  $\sigma = 0.859 \text{ S/m}$ ;  $\epsilon_r = 42.426$ ;  $\rho = 1000 \text{ kg/m}^3$

Phantom section: Flat Section

Measurement Standard: DASYS (IEEE/IEC/ANSI C63.19-2007)

DASY Configuration:

- Probe: EX3DV4 - SN3924; ConvF(9.95, 9.95, 9.95); Calibrated: 07.10.2015;
- Sensor-Surface: 2mm (Mechanical Surface Detection),  $z = 31.0$
- Electronics: DAE4 Sn1373; Calibrated: 07.23.2015
- Phantom: ELI v5.0; Type: QDOVA002AA; Serial: TP:1208
- DASYS2 52.8.8(1222); SEMCAD X 14.6.10(7331)

**LTE Band17 50%RB 10(MHZ) Body Front/Middle Channel/Zoom Scan**

**(5x5x7)/Cube 0:** Measurement grid:  $dx=8\text{mm}$ ,  $dy=8\text{mm}$ ,  $dz=5\text{mm}$

Reference Value = 20.25 V/m; Power Drift = 0.00 dB

Peak SAR (extrapolated) = 0.433 W/kg

**SAR(1 g) = 0.323 W/kg; SAR(10 g) = 0.239 W/kg**

Maximum value of SAR (measured) = 0.380 W/kg

**LTE Band17 50%RB 10(MHZ) Body Front/Middle Channel/Area Scan**

**(41x71x1):** Interpolated grid:  $dx=1.500 \text{ mm}$ ,  $dy=1.500 \text{ mm}$

Maximum value of SAR (interpolated) = 0.371 W/kg

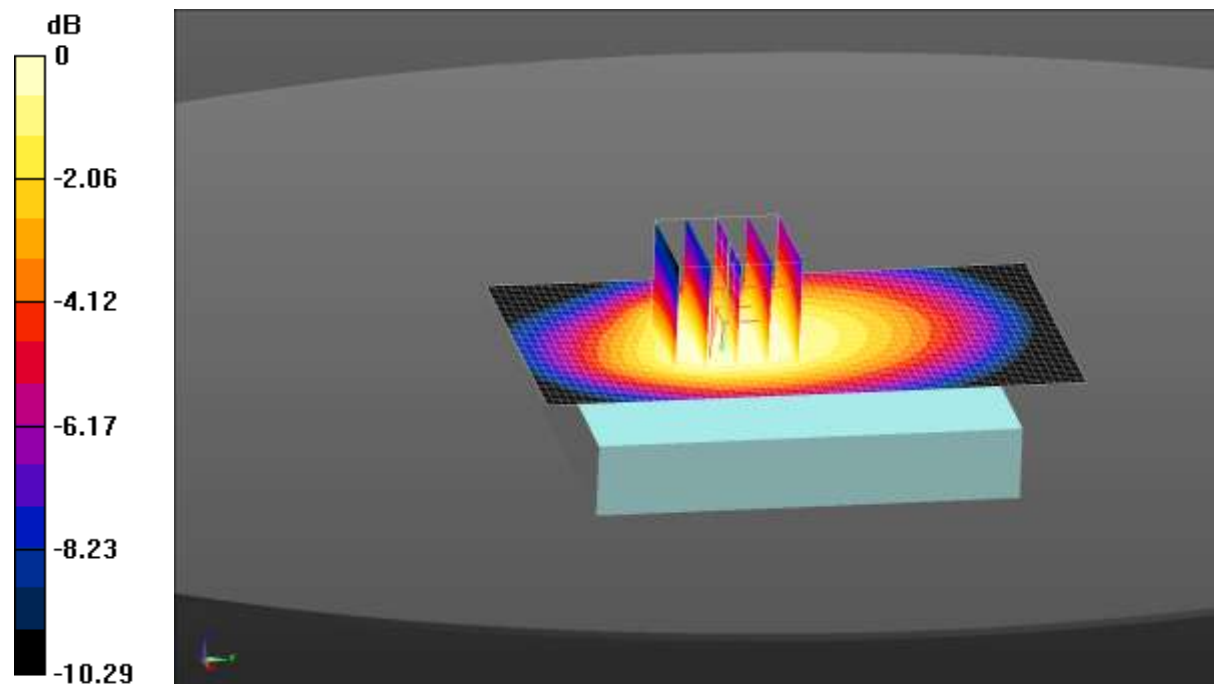

0 dB = 0.371 W/kg = -4.31 dBW/kg



Test Laboratory: CCIS

Date/Time: 12.18.2015 12:24:53

**DUT: Global Mobile WiFi Travel Routel; Type: XG1; Serial: 1#**

Communication System: UID 0, IEEE 802.11b WiFi 2.4 GHz (DSSS, 1 Mbps) (0);

Frequency: 2462 MHz

Medium parameters used (interpolated):  $f = 2462$  MHz;  $\sigma = 1.919$  S/m;  $\epsilon_r = 52.64$ ;  $\rho = 1000$  kg/m<sup>3</sup>

Phantom section: Flat Section

Measurement Standard: DASYS5 (IEEE/IEC/ANSI C63.19-2007)

DASY Configuration:

- Probe: EX3DV4 - SN3924; ConvF(7.3, 7.3, 7.3); Calibrated: 07.10.2015;
- Sensor-Surface: 2mm (Mechanical Surface Detection),  $z = 1.0, 31.0$
- Electronics: DAE4 Sn1373; Calibrated: 07.23.2015
- Phantom: ELI v5.0; Type: QDOVA002AA; Serial: TP:1208
- DASYS52 52.8.8(1222); SEMCAD X 14.6.10(7331)

**WiFi Body Left/High Channel/Area Scan (31x71x1):** Interpolated grid:  $dx=1.200$  mm,  $dy=1.200$  mm

Maximum value of SAR (interpolated) = 0.128 W/kg

**WiFi Body Left/High Channel/Zoom Scan (5x5x7)/Cube 0:** Measurement grid:  $dx=5$ mm,  $dy=5$ mm,  $dz=5$ mm

Reference Value = 7.090 V/m; Power Drift = -0.22 dB

Peak SAR (extrapolated) = 0.189 W/kg

**SAR(1 g) = 0.089 W/kg; SAR(10 g) = 0.046 W/kg**

Maximum value of SAR (measured) = 0.130 W/kg

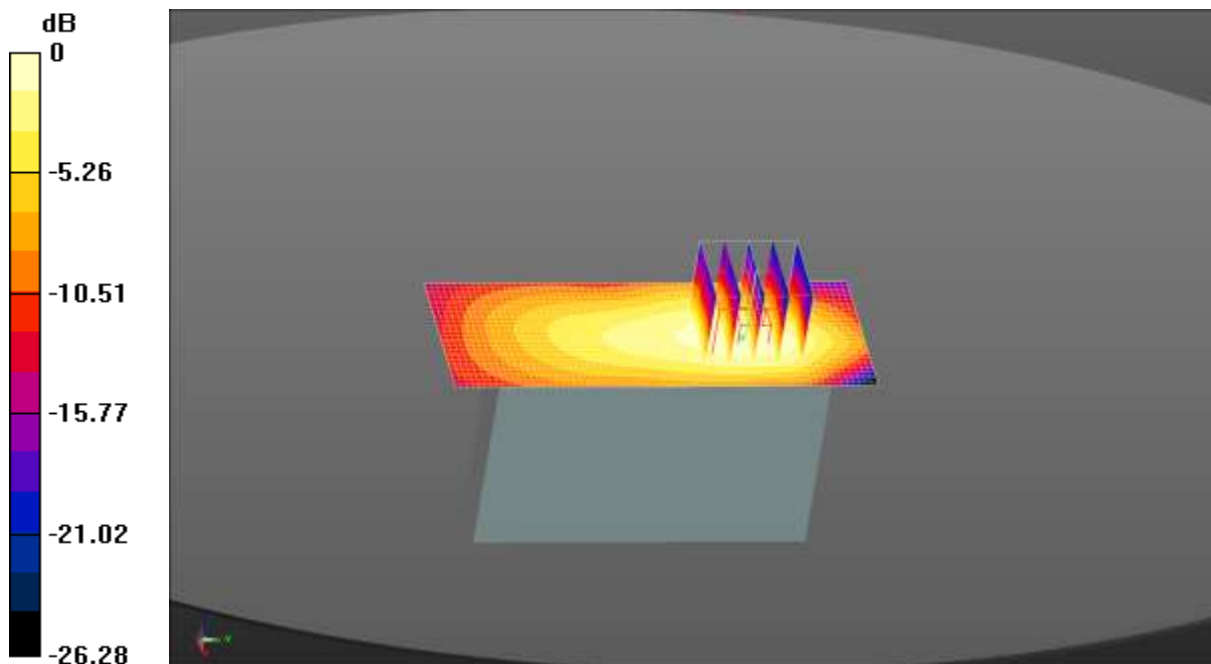

0 dB = 0.130 W/kg = -8.86 dBW/kg



## Appendix E: System Calibration Certificate

## Calibration information for E-field probes



In Collaboration with  
 Add: No.51 Xueyuan Road, Haidian District, Beijing, 100191, China  
 Tel: +86-10-62304633-2218 Fax: +86-10-62304633-2209  
 E-mail: cctl@chinattl.com [Http://www.chinattl.cn](http://www.chinattl.cn)



Client **CCIS** Certificate No: **Z15-97080**

CALIBRATION CERTIFICATE			
Object	EX3DV4 - SN:3924		
Calibration Procedure(s)	FD-Z11-2-004-01 Calibration Procedures for Dosimetric E-field Probes		
Calibration date:	July 10, 2015		
<p>This calibration Certificate documents the traceability to national standards, which realize the physical units of measurements(SI). The measurements and the uncertainties with confidence probability are given on the following pages and are part of the certificate.</p> <p>All calibrations have been conducted in the closed laboratory facility: environment temperature(22±3)°C and humidity&lt;70%.</p> <p>Calibration Equipment used (M&amp;TE critical for calibration)</p>			
Primary Standards	ID #	Cal Date(Calibrated by, Certificate No.)	Scheduled Calibration
Power Meter NRP2	101919	01-Jul-15 (CTTL, No.J15X04256)	Jun-16
Power sensor NRP-Z91	101547	01-Jul-15 (CTTL, No.J15X04256)	Jun-16
Power sensor NRP-Z91	101548	01-Jul-15 (CTTL, No.J15X04256)	Jun-16
Reference10dBAttenuator	18N50W-10dB	13-Mar-14(TMC,No.JZ14-1103)	Mar-16
Reference20dBAttenuator	18N50W-20dB	13-Mar-14(TMC,No.JZ14-1104)	Mar-16
Reference Probe EX3DV4	SN 3617	28-Aug-14(SPEAG,No.EX3-3617_Aug14)	Aug-15
DAE4	SN 777	17-Sep-14 (SPEAG, DAE4-777_Sep14)	Sep -15
Secondary Standards	ID #	Cal Date(Calibrated by, Certificate No.)	Scheduled Calibration
SignalGeneratorMG3700A	6201052605	01-Jul-15 (CTTL, No.J15X04255)	Jun-16
Network Analyzer E5071C	MY46110673	03-Feb-15 (CTTL, No.J15X00728)	Feb-16
Calibrated by:	Name	Function	Signature
	Yu Zongying	SAR Test Engineer	
Reviewed by:	Qi Dianyuan	SAR Project Leader	
Approved by:	Lu Bingsong	Deputy Director of the laboratory	
Issued: July 15, 2015			
This calibration certificate shall not be reproduced except in full without written approval of the laboratory.			

Certificate No: Z15-97080

Page 1 of 11



Add: No.51 Xueyuan Road, Haidian District, Beijing, 100191, China  
 Tel: +86-10-62304633-2218 Fax: +86-10-62304633-2209  
 E-mail: cttl@chinattl.com <http://www.chinattl.cn>

**Glossary:**

- TSL tissue simulating liquid
- NORM<sub>x,y,z</sub> sensitivity in free space
- ConvF sensitivity in TSL / NORM<sub>x,y,z</sub>
- DCP diode compression point
- CF crest factor (1/duty\_cycle) of the RF signal
- A,B,C,D modulation dependent linearization parameters
- Polarization  $\Phi$   $\Phi$  rotation around probe axis
- Polarization  $\theta$   $\theta$  rotation around an axis that is in the plane normal to probe axis (at measurement center),  $\theta=0$  is normal to probe axis

Connector Angle information used in DASY system to align probe sensor X to the robot coordinate system

**Calibration is Performed According to the Following Standards:**

- a) IEEE Std 1528-2013, "IEEE Recommended Practice for Determining the Peak Spatial-Averaged Specific Absorption Rate (SAR) in the Human Head from Wireless Communications Devices: Measurement Techniques", June 2013
- b) IEC 62209-1, "Procedure to measure the Specific Absorption Rate (SAR) for hand-held devices used in close proximity to the ear (frequency range of 300MHz to 3GHz)", February 2005

**Methods Applied and Interpretation of Parameters:**

- NORM<sub>x,y,z</sub>: Assessed for E-field polarization  $\theta=0$  (fs900MHz in TEM-cell;  $f > 1800$ MHz: waveguide). NORM<sub>x,y,z</sub> are only intermediate values, i.e., the uncertainties of NORM<sub>x,y,z</sub> does not effect the  $E^2$ -field uncertainty inside TSL (see below ConvF).
- NORM(f)<sub>x,y,z</sub> = NORM<sub>x,y,z</sub> \* frequency\_response (see Frequency Response Chart). This linearization is implemented in DASY4 software versions later than 4.2. The uncertainty of the frequency response is included in the stated uncertainty of ConvF.
- DCP<sub>x,y,z</sub>: DCP are numerical linearization parameters assessed based on the data of power sweep (no uncertainty required). DCP does not depend on frequency nor media.
- PAR: PAR is the Peak to Average Ratio that is not calibrated but determined based on the signal characteristics.
- Ax,y,z; Bx,y,z; Cx,y,z; VR<sub>x,y,z</sub>: A,B,C are numerical linearization parameters assessed based on the data of power sweep for specific modulation signal. The parameters do not depend on frequency nor media. VR is the maximum calibration range expressed in RMS voltage across the diode.
- ConvF and Boundary Effect Parameters: Assessed in flat phantom using E-field (or Temperature Transfer Standard for fs800MHz) and inside waveguide using analytical field distributions based on power measurements for  $f > 800$ MHz. The same setups are used for assessment of the parameters applied for boundary compensation (alpha, depth) of which typical uncertainty valued are given. These parameters are used in DASY4 software to improve probe accuracy close to the boundary. The sensitivity in TSL corresponds to NORM<sub>x,y,z</sub> \* ConvF whereby the uncertainty corresponds to that given for ConvF. A frequency dependent ConvF is used in DASY version 4.4 and higher which allows extending the validity from  $\pm 50$ MHz to  $\pm 100$ MHz.
- Spherical isotropy (3D deviation from isotropy): in a field of low gradients realized using a flat phantom exposed by a patch antenna.
- Sensor Offset: The sensor offset corresponds to the offset of virtual measurement center from the probe tip (on probe axis). No tolerance required.
- Connector Angle: The angle is assessed using the information gained by determining the NORM<sub>x</sub> (no uncertainty required).



Add: No.51 Xueyuan Road, Haidian District, Beijing, 100191, China  
Tel: +86-10-62304633-2218 Fax: +86-10-62304633-2209  
E-mail: [ctl@chinattl.com](mailto:ctl@chinattl.com) [Http://www.chinattl.cn](http://www.chinattl.cn)

# Probe EX3DV4

## SN: 3924

Calibrated: July 10, 2015

Calibrated for DASY/EASY Systems

(Note: non-compatible with DASY2 system!)



Add: No.51 Xueyuan Road, Haidian District, Beijing, 100191, China  
Tel: +86-10-62304633-2218 Fax: +86-10-62304633-2209  
E-mail: cttl@chinattl.com [Http://www.chinattl.cn](http://www.chinattl.cn)

## DASY/EASY – Parameters of Probe: EX3DV4 – SN: 3924

### Basic Calibration Parameters

	Sensor X	Sensor Y	Sensor Z	Unc (k=2)
Norm( $\mu\text{V}/(\text{V}/\text{m})^2$ ) <sup>A</sup>	0.50	0.41	0.67	±10.8%
DCP(mV) <sup>B</sup>	102.7	99.5	100.2	

### Modulation Calibration Parameters

UID	Communication System Name		A dB	B dB· $\mu\text{V}$	C	D dB	VR mV	Unc <sup>E</sup> (k=2)
0	CW	X	0.0	0.0	1.0	0.00	198.9	±2.1%
		Y	0.0	0.0	1.0		178.3	
		Z	0.0	0.0	1.0		233.2	

The reported uncertainty of measurement is stated as the standard uncertainty of Measurement multiplied by the coverage factor k=2, which for a normal distribution Corresponds to a coverage probability of approximately 95%.

<sup>A</sup> The uncertainties of Norm X, Y, Z do not affect the E<sup>2</sup>-field uncertainty inside TSL (see Page 5 and Page 6).  
<sup>B</sup> Numerical linearization parameter: uncertainty not required.  
<sup>E</sup> Uncertainty is determined using the max. deviation from linear response applying rectangular distribution and is expressed for the square of the field value.





Add: No.51 Xueyuan Road, Haidian District, Beijing, 100191, China  
Tel: +86-10-62304633-2218 Fax: +86-10-62304633-2209  
E-mail: [ctrl@chinattl.com](mailto:ctrl@chinattl.com) [Http://www.chinattl.cn](http://www.chinattl.cn)

## DASY/EASY – Parameters of Probe: EX3DV4 – SN: 3924

### Calibration Parameter Determined in Head Tissue Simulating Media

f [MHz] <sup>C</sup>	Relative Permittivity <sup>F</sup>	Conductivity (S/m) <sup>F</sup>	ConvF X	ConvF Y	ConvF Z	Alpha <sup>G</sup>	Depth <sup>G</sup> (mm)	Unct. (k=2)
750	41.9	0.89	9.95	9.95	9.95	0.13	1.40	± 12%
835	41.5	0.90	9.68	9.68	9.68	0.15	1.29	± 12%
900	41.5	0.97	9.42	9.42	9.42	0.22	1.09	± 12%
1750	40.1	1.37	8.37	8.37	8.37	0.21	1.10	± 12%
1900	40.0	1.40	7.95	7.95	7.95	0.22	1.12	± 12%
2450	39.2	1.80	7.17	7.17	7.17	0.35	0.98	± 12%
2600	39.0	1.96	7.04	7.04	7.04	0.34	1.07	± 12%

<sup>C</sup> Frequency validity of ±100MHz only applies for DASY v4.4 and higher (Page 2), else it is restricted to ±50MHz. The uncertainty is the RSS of ConvF uncertainty at calibration frequency and the uncertainty for the indicated frequency band.

<sup>F</sup> At frequency below 3 GHz, the validity of tissue parameters ( $\epsilon$  and  $\sigma$ ) can be relaxed to ±10% if liquid compensation formula is applied to measured SAR values. At frequencies above 3 GHz, the validity of tissue parameters ( $\epsilon$  and  $\sigma$ ) is restricted to ±5%. The uncertainty is the RSS of the ConvF uncertainty for indicated target tissue parameters.

<sup>G</sup> Alpha/Depth are determined during calibration. SPEAG warrants that the remaining deviation due to the boundary effect after compensation is always less than ± 1% for frequencies below 3 GHz and below ± 2% for the frequencies between 3-6 GHz at any distance larger than half the probe tip diameter from the boundary.



Add: No.51 Xueyuan Road, Haidian District, Beijing, 100191, China  
 Tel: +86-10-62304633-2218 Fax: +86-10-62304633-2209  
 E-mail: cttl@chinatl.com [Http://www.chinatl.cn](http://www.chinatl.cn)

## DASY/EASY – Parameters of Probe: EX3DV4 – SN: 3924

### Calibration Parameter Determined in Body Tissue Simulating Media

f [MHz] <sup>C</sup>	Relative Permittivity <sup>F</sup>	Conductivity (S/m) <sup>F</sup>	ConvF X	ConvF Y	ConvF Z	Alpha <sup>G</sup>	Depth <sup>G</sup> (mm)	Unct. (k=2)
750	55.5	0.96	9.90	9.90	9.90	0.29	0.98	± 12%
835	55.2	0.97	9.74	9.74	9.74	0.16	1.50	± 12%
900	55.0	1.05	9.51	9.51	9.51	0.30	1.03	± 12%
1750	53.4	1.49	7.94	7.94	7.94	0.21	1.13	± 12%
1900	53.3	1.52	7.65	7.65	7.65	0.13	2.58	± 12%
2450	52.7	1.95	7.30	7.30	7.30	0.28	1.31	± 12%
2600	52.5	2.16	7.20	7.20	7.20	0.38	0.98	± 12%

<sup>C</sup> Frequency validity of ±100MHz only applies for DASY v4.4 and higher (Page 2), else it is restricted to ±50MHz. The uncertainty is the RSS of ConvF uncertainty at calibration frequency and the uncertainty for the indicated frequency band.

<sup>F</sup> At frequency below 3 GHz, the validity of tissue parameters ( $\epsilon$  and  $\sigma$ ) can be relaxed to ±10% if liquid compensation formula is applied to measured SAR values. At frequencies above 3 GHz, the validity of tissue parameters ( $\epsilon$  and  $\sigma$ ) is restricted to ±5%. The uncertainty is the RSS of the ConvF uncertainty for indicated target tissue parameters.

<sup>G</sup> Alpha/Depth are determined during calibration. SPEAG warrants that the remaining deviation due to the boundary effect after compensation is always less than ± 1% for frequencies below 3 GHz and below ± 2% for the frequencies between 3-6 GHz at any distance larger than half the probe tip diameter from the boundary.





Add: No.51 Xueyuan Road, Haidian District, Beijing, 100191, China  
Tel: +86-10-62304633-2218 Fax: +86-10-62304633-2209  
E-mail: cttl@chinattl.com [Http://www.chinattl.cn](http://www.chinattl.cn)

## Frequency Response of E-Field (TEM-Cell: ifi110 EXX, Waveguide: R22)

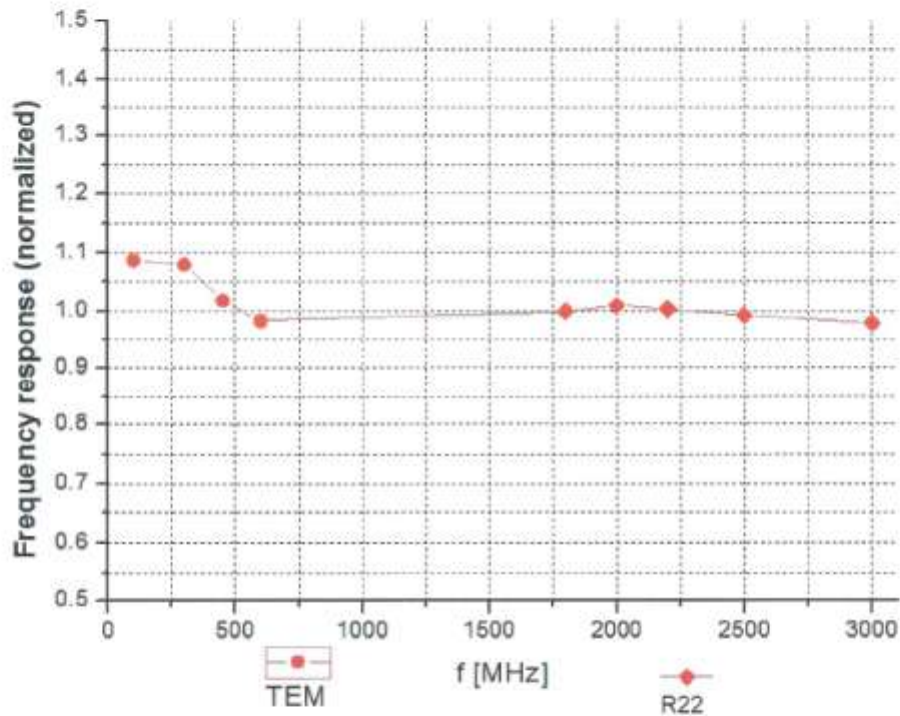

Uncertainty of Frequency Response of E-field:  $\pm 7.5\%$  (k=2)



In Collaboration with  
 Add: No.51 Xueyuan Road, Haidian District, Beijing, 100191, China  
 Tel: +86-10-62304633-2218 Fax: +86-10-62304633-2209  
 E-mail: cctl@chinattl.com [Http://www.chinattl.cn](http://www.chinattl.cn)

## Receiving Pattern ( $\Phi$ ), $\theta=0^\circ$

f=600 MHz, TEM

f=1800 MHz, R22

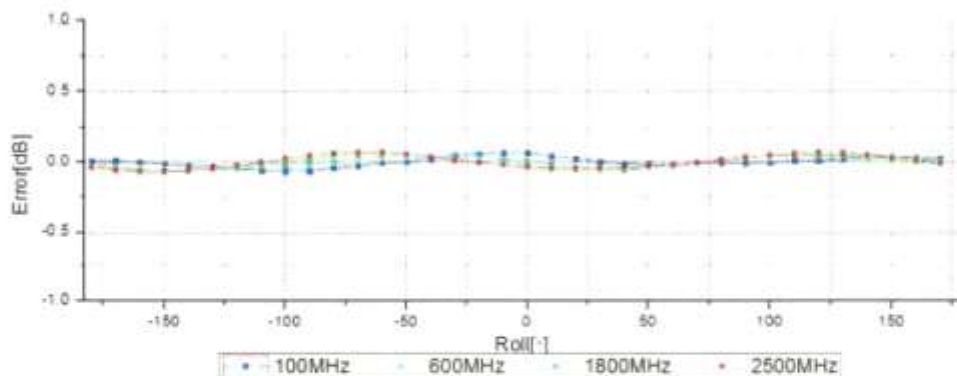
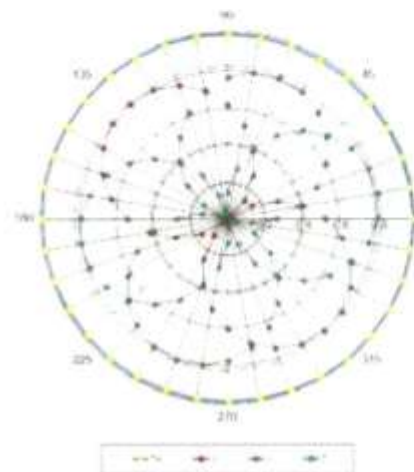
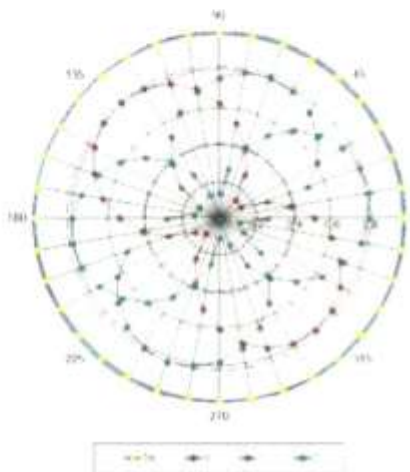

Uncertainty of Axial Isotropy Assessment:  $\pm 0.9\%$  (k=2)



Add: No.51 Xueyuan Road, Haidian District, Beijing, 100191, China  
Tel: +86-10-62304633-2218 Fax: +86-10-62304633-2209  
E-mail: cttl@chinatitl.com [Http://www.chinatitl.cn](http://www.chinatitl.cn)

## Dynamic Range f(SAR<sub>head</sub>) (TEM cell, f = 900 MHz)

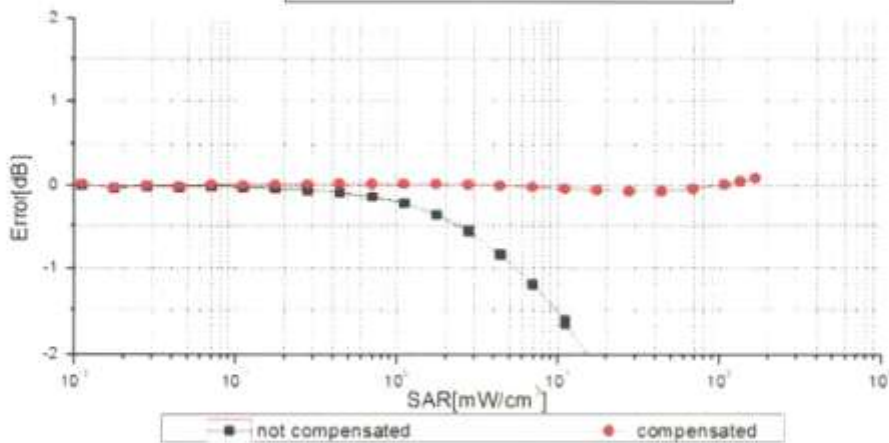
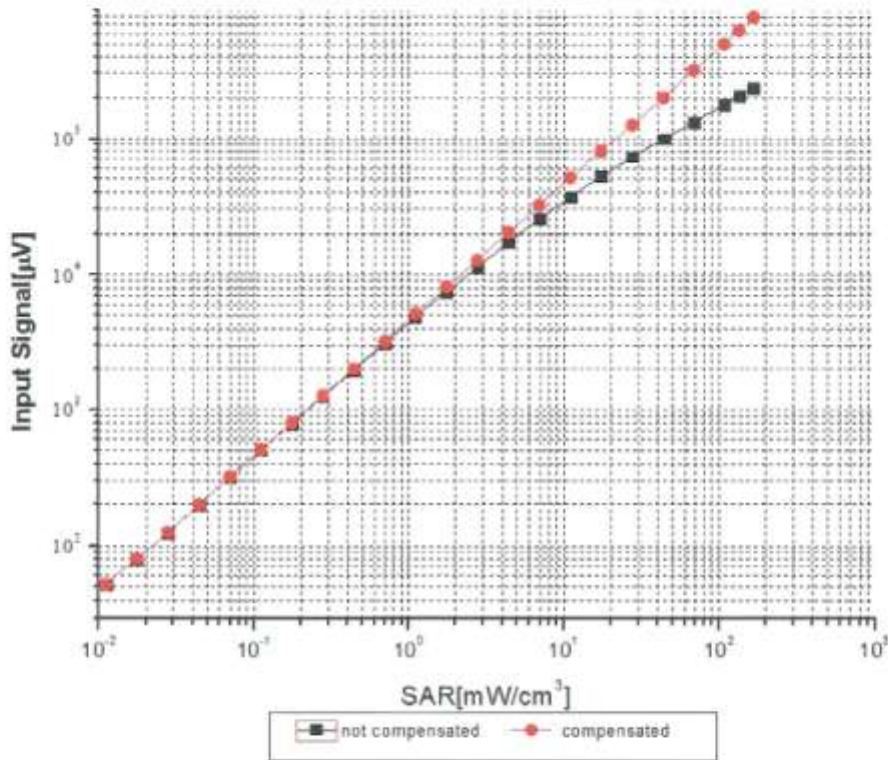

Uncertainty of Linearity Assessment: ±0.9% (k=2)



Add: No.51 Xueyuan Road, Haidian District, Beijing, 100191, China  
Tel: +86-10-62304633-2218 Fax: +86-10-62304633-2209  
E-mail: [ctrl@chinattl.com](mailto:ctrl@chinattl.com) [Http://www.chinattl.cn](http://www.chinattl.cn)

## Conversion Factor Assessment

f=900 MHz, WGLS R9(H\_convF)

f=1750 MHz, WGLS R22(H\_convF)

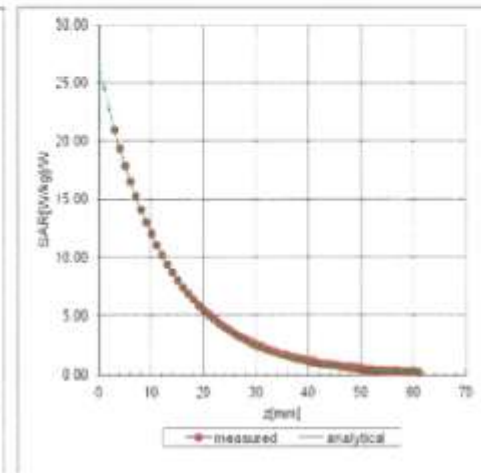
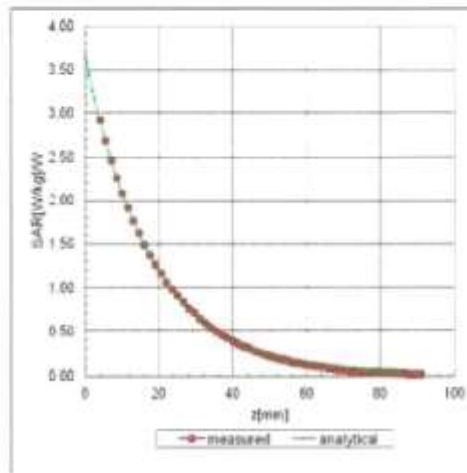

## Deviation from Isotropy in Liquid

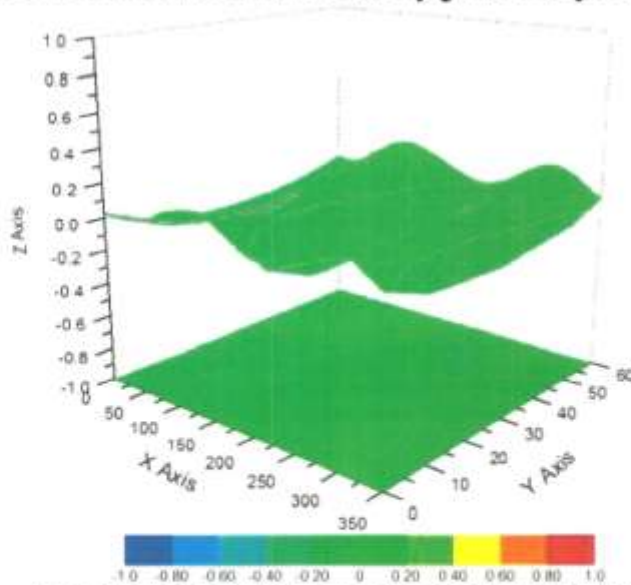

Uncertainty of Spherical Isotropy Assessment:  $\pm 2.8\%$  (K=2)



Add: No.51 Xueyuan Road, Haidian District, Beijing, 100191, China  
Tel: +86-10-62304633-2218 Fax: +86-10-62304633-2209  
E-mail: [cttl@chinatl.com](mailto:cttl@chinatl.com) [Http://www.chinatl.cn](http://www.chinatl.cn)

## DASY/EASY – Parameters of Probe: EX3DV4 – SN: 3924

### Other Probe Parameters

Sensor Arrangement	Triangular
Connector Angle (°)	152.8
Mechanical Surface Detection Mode	enabled
Optical Surface Detection Mode	disable
Probe Overall Length	337mm
Probe Body Diameter	10mm
Tip Length	9mm
Tip Diameter	2.5mm
Probe Tip to Sensor X Calibration Point	1mm
Probe Tip to Sensor Y Calibration Point	1mm
Probe Tip to Sensor Z Calibration Point	1mm
Recommended Measurement Distance from Surface	1.4mm



## Calibration information for Dipole

**Calibration Laboratory of Schmid & Partner Engineering AG**  
 Zeughausstrasse 43, 8004 Zurich, Switzerland



**S** Schweizerischer Kalibrierdienst  
**C** Service suisse d'étalonnage  
**S** Servizio svizzero di taratura  
**S** Swiss Calibration Service

Accredited by the Swiss Accreditation Service (SAS)

Accreditation No.: **SCS 108**

The Swiss Accreditation Service is one of the signatories to the EA Multilateral Agreement for the recognition of calibration certificates

Client **CCIS (Auden)**

Certificate No: **D750V3-1118\_Jul14**

### CALIBRATION CERTIFICATE

Object: **D750V3 - SN: 1118**

Calibration procedure(s): **QA CAL-05.v9  
 Calibration procedure for dipole validation kits above 700 MHz**

Calibration date: **July 10, 2014**

This calibration certificate documents the traceability to national standards, which realize the physical units of measurements (SI). The measurements and the uncertainties with confidence probability are given on the following pages and are part of the certificate.

All calibrations have been conducted in the closed laboratory facility: environment temperature (22 ± 3)°C and humidity < 70%.

Calibration Equipment used (M&TE critical for calibration)

Primary Standards	ID #	Cal Date (Certificate No.)	Scheduled Calibration
Power meter EPM-442A	GB37480704	09-Oct-13 (No. 217-01827)	Oct-14
Power sensor HP 8481A	US37292783	09-Oct-13 (No. 217-01827)	Oct-14
Power sensor HP 8481A	MY41092317	09-Oct-13 (No. 217-01828)	Oct-14
Reference 20 dB Attenuator	SN: 5058 (20k)	03-Apr-14 (No. 217-01918)	Apr-15
Type-N mismatch combination	SN: 5047.2 / 06327	03-Apr-14 (No. 217-01921)	Apr-15
Reference Probe ES3DV3	SN: 3205	30-Dec-13 (No. ES3-3205_Dec13)	Dec-14
DAE4	SN: 601	30-Apr-14 (No. DAE4-601_Apr14)	Apr-15
Secondary Standards	ID #	Check Date (in house)	Scheduled Check
RF generator R&S SMT-06	100005	04-Aug-99 (in house check Oct-13)	In house check: Oct-16
Network Analyzer HP 8753E	US37390585 S4206	18-Oct-01 (in house check Oct-13)	In house check: Oct-14

Calibrated by: **Michael Weber** (Name), **Laboratory Technician** (Function), *[Signature]* (Signature)

Approved by: **Katja Pokovic** (Name), **Technical Manager** (Function), *[Signature]* (Signature)

Issued: July 11, 2014

This calibration certificate shall not be reproduced except in full without written approval of the laboratory.

**Calibration Laboratory of  
Schmid & Partner  
Engineering AG**  
Zeughausstrasse 43, 8004 Zurich, Switzerland



**S** Schweizerischer Kalibrierdienst  
**C** Service suisse d'étalonnage  
**S** Servizio svizzero di taratura  
**S** Swiss Calibration Service

Accredited by the Swiss Accreditation Service (SAS)  
The Swiss Accreditation Service is one of the signatories to the EA  
Multilateral Agreement for the recognition of calibration certificates

Accreditation No.: **SCS 108**

**Glossary:**

TSL	tissue simulating liquid
ConvF	sensitivity in TSL / NORM x,y,z
N/A	not applicable or not measured

**Calibration is Performed According to the Following Standards:**

- a) IEEE Std 1528-2013, "IEEE Recommended Practice for Determining the Peak Spatial-Averaged Specific Absorption Rate (SAR) in the Human Head from Wireless Communications Devices: Measurement Techniques", June 2013
- b) IEC 62209-1, "Procedure to measure the Specific Absorption Rate (SAR) for hand-held devices used in close proximity to the ear (frequency range of 300 MHz to 3 GHz)", February 2005
- c) KDB 865664, "SAR Measurement Requirements for 100 MHz to 6 GHz"

**Additional Documentation:**

- d) DASY4/5 System Handbook

**Methods Applied and Interpretation of Parameters:**

- *Measurement Conditions:* Further details are available from the Validation Report at the end of the certificate. All figures stated in the certificate are valid at the frequency indicated.
- *Antenna Parameters with TSL:* The dipole is mounted with the spacer to position its feed point exactly below the center marking of the flat phantom section, with the arms oriented parallel to the body axis.
- *Feed Point Impedance and Return Loss:* These parameters are measured with the dipole positioned under the liquid filled phantom. The impedance stated is transformed from the measurement at the SMA connector to the feed point. The Return Loss ensures low reflected power. No uncertainty required.
- *Electrical Delay:* One-way delay between the SMA connector and the antenna feed point. No uncertainty required.
- *SAR measured:* SAR measured at the stated antenna input power.
- *SAR normalized:* SAR as measured, normalized to an input power of 1 W at the antenna connector.
- *SAR for nominal TSL parameters:* The measured TSL parameters are used to calculate the nominal SAR result.

The reported uncertainty of measurement is stated as the standard uncertainty of measurement multiplied by the coverage factor  $k=2$ , which for a normal distribution corresponds to a coverage probability of approximately 95%.



## Measurement Conditions

DASY system configuration, as far as not given on page 1.

DASY Version	DASY5	V52.8.8
Extrapolation	Advanced Extrapolation	
Phantom	Modular Flat Phantom	
Distance Dipole Center - TSL	15 mm	with Spacer
Zoom Scan Resolution	dx, dy, dz = 5 mm	
Frequency	750 MHz ± 1 MHz	

## Head TSL parameters

The following parameters and calculations were applied.

	Temperature	Permittivity	Conductivity
Nominal Head TSL parameters	22.0 °C	41.9	0.89 mho/m
Measured Head TSL parameters	(22.0 ± 0.2) °C	41.2 ± 6 %	0.92 mho/m ± 6 %
Head TSL temperature change during test	< 0.5 °C	----	----

## SAR result with Head TSL

SAR averaged over 1 cm <sup>3</sup> (1 g) of Head TSL	Condition	
SAR measured	250 mW input power	2.09 W/kg
SAR for nominal Head TSL parameters	normalized to 1W	<b>8.12 W/kg ± 17.0 % (k=2)</b>

SAR averaged over 10 cm <sup>3</sup> (10 g) of Head TSL	condition	
SAR measured	250 mW input power	1.36 W/kg
SAR for nominal Head TSL parameters	normalized to 1W	<b>5.32 W/kg ± 16.5 % (k=2)</b>

## Body TSL parameters

The following parameters and calculations were applied.

	Temperature	Permittivity	Conductivity
Nominal Body TSL parameters	22.0 °C	55.5	0.96 mho/m
Measured Body TSL parameters	(22.0 ± 0.2) °C	53.9 ± 6 %	1.00 mho/m ± 6 %
Body TSL temperature change during test	< 0.5 °C	----	----

## SAR result with Body TSL

SAR averaged over 1 cm <sup>3</sup> (1 g) of Body TSL	Condition	
SAR measured	250 mW input power	2.19 W/kg
SAR for nominal Body TSL parameters	normalized to 1W	<b>8.44 W/kg ± 17.0 % (k=2)</b>

SAR averaged over 10 cm <sup>3</sup> (10 g) of Body TSL	condition	
SAR measured	250 mW input power	1.44 W/kg
SAR for nominal Body TSL parameters	normalized to 1W	<b>5.59 W/kg ± 16.5 % (k=2)</b>

## Appendix (Additional assessments outside the scope of SCS108)

### Antenna Parameters with Head TSL

Impedance, transformed to feed point	52.3 $\Omega$ - 5.7 $j\Omega$
Return Loss	- 24.5 dB

### Antenna Parameters with Body TSL

Impedance, transformed to feed point	47.2 $\Omega$ - 7.1 $j\Omega$
Return Loss	- 22.1 dB

### General Antenna Parameters and Design

Electrical Delay (one direction)	1.030 ns
----------------------------------	----------

After long term use with 100W radiated power, only a slight warming of the dipole near the feedpoint can be measured.

The dipole is made of standard semirigid coaxial cable. The center conductor of the feeding line is directly connected to the second arm of the dipole. The antenna is therefore short-circuited for DC-signals. On some of the dipoles, small end caps are added to the dipole arms in order to improve matching when loaded according to the position as explained in the "Measurement Conditions" paragraph. The SAR data are not affected by this change. The overall dipole length is still according to the Standard.

No excessive force must be applied to the dipole arms, because they might bend or the soldered connections near the feedpoint may be damaged.

### Additional EUT Data

Manufactured by	SPEAG
Manufactured on	May 21, 2014

## DASY5 Validation Report for Head TSL

Date: 10.07.2014

Test Laboratory: SPEAG, Zurich, Switzerland

**DUT: Dipole 750 MHz; Type: D750V3; Serial: D750V3 - SN: 1118**

Communication System: UID 0 - CW; Frequency: 750 MHz

Medium parameters used:  $f = 750 \text{ MHz}$ ;  $\sigma = 0.92 \text{ S/m}$ ;  $\epsilon_r = 41.2$ ;  $\rho = 1000 \text{ kg/m}^3$

Phantom section: Flat Section

Measurement Standard: DASY5 (IEEE/IEC/ANSI C63.19-2011)

DASY52 Configuration:

- Probe: ES3DV3 - SN3205; ConvF(6.37, 6.37, 6.37); Calibrated: 30.12.2013;
- Sensor-Surface: 3mm (Mechanical Surface Detection)
- Electronics: DAE4 Sn601; Calibrated: 30.04.2014
- Phantom: Flat Phantom 4.9L; Type: QD000P49AA; Serial: 1001
- DASY52 52.8.8(1222); SEMCAD X 14.6.10(7331)

### Dipole Calibration for Head Tissue/Pin=250 mW, d=15mm/Zoom Scan (7x7x7)/Cube 0:

Measurement grid: dx=5mm, dy=5mm, dz=5mm

Reference Value = 53.24 V/m; Power Drift = 0.00 dB

Peak SAR (extrapolated) = 3.13 W/kg

**SAR(1 g) = 2.09 W/kg; SAR(10 g) = 1.36 W/kg**

Maximum value of SAR (measured) = 2.44 W/kg

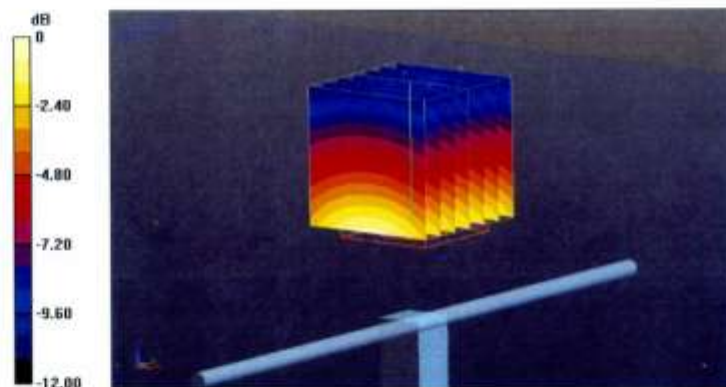

0 dB = 2.44 W/kg = 3.87 dBW/kg



## Impedance Measurement Plot for Head TSL

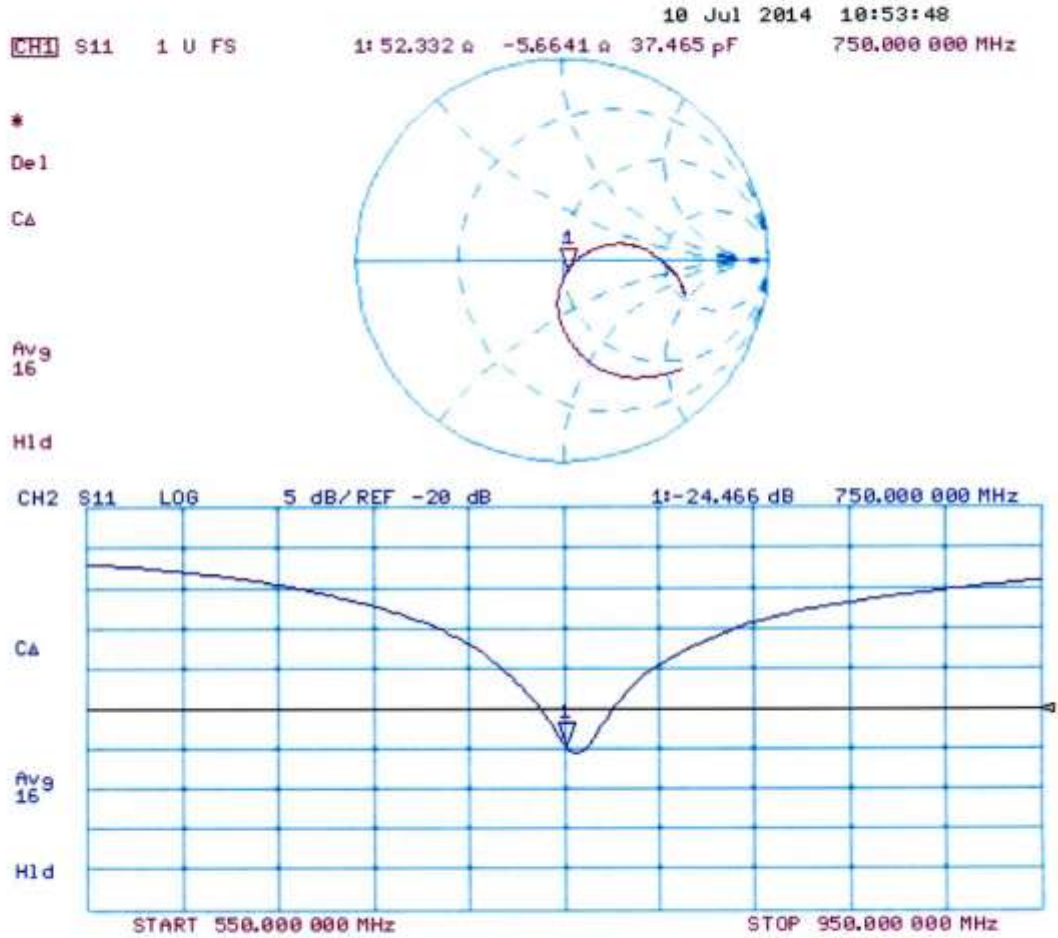

## DASY5 Validation Report for Body TSL

Date: 09.07.2014

Test Laboratory: SPEAG, Zurich, Switzerland

**DUT: Dipole 750 MHz; Type: D750V3; Serial: D750V3 - SN: 1118**

Communication System: UID 0 - CW; Frequency: 750 MHz

Medium parameters used:  $f = 750 \text{ MHz}$ ;  $\sigma = 1 \text{ S/m}$ ;  $\epsilon_r = 53.9$ ;  $\rho = 1000 \text{ kg/m}^3$

Phantom section: Flat Section

Measurement Standard: DASY5 (IEEE/IEC/ANSI C63.19-2011)

DASY52 Configuration:

- Probe: ES3DV3 - SN3205; ConvF(6.13, 6.13, 6.13); Calibrated: 30.12.2013;
- Sensor-Surface: 3mm (Mechanical Surface Detection)
- Electronics: DAE4 Sn601; Calibrated: 30.04.2014
- Phantom: Flat Phantom 4.9L; Type: QD000P49AA; Serial: 1001
- DASY52 52.8.8(1222); SEMCAD X 14.6.10(7331)

### Dipole Calibration for Body Tissue/Pin=250 mW, d=15mm/Zoom Scan (7x7x7)/Cube 0:

Measurement grid: dx=5mm, dy=5mm, dz=5mm

Reference Value = 52.14 V/m; Power Drift = 0.03 dB

Peak SAR (extrapolated) = 3.19 W/kg

**SAR(1 g) = 2.19 W/kg; SAR(10 g) = 1.44 W/kg**

Maximum value of SAR (measured) = 2.54 W/kg

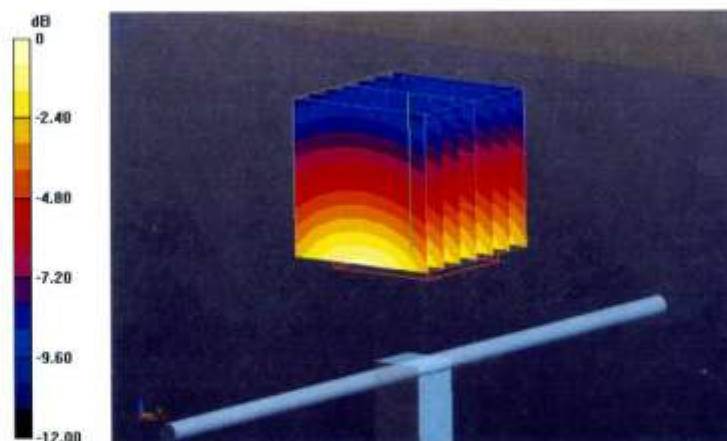

0 dB = 2.54 W/kg = 4.05 dBW/kg

## Impedance Measurement Plot for Body TSL

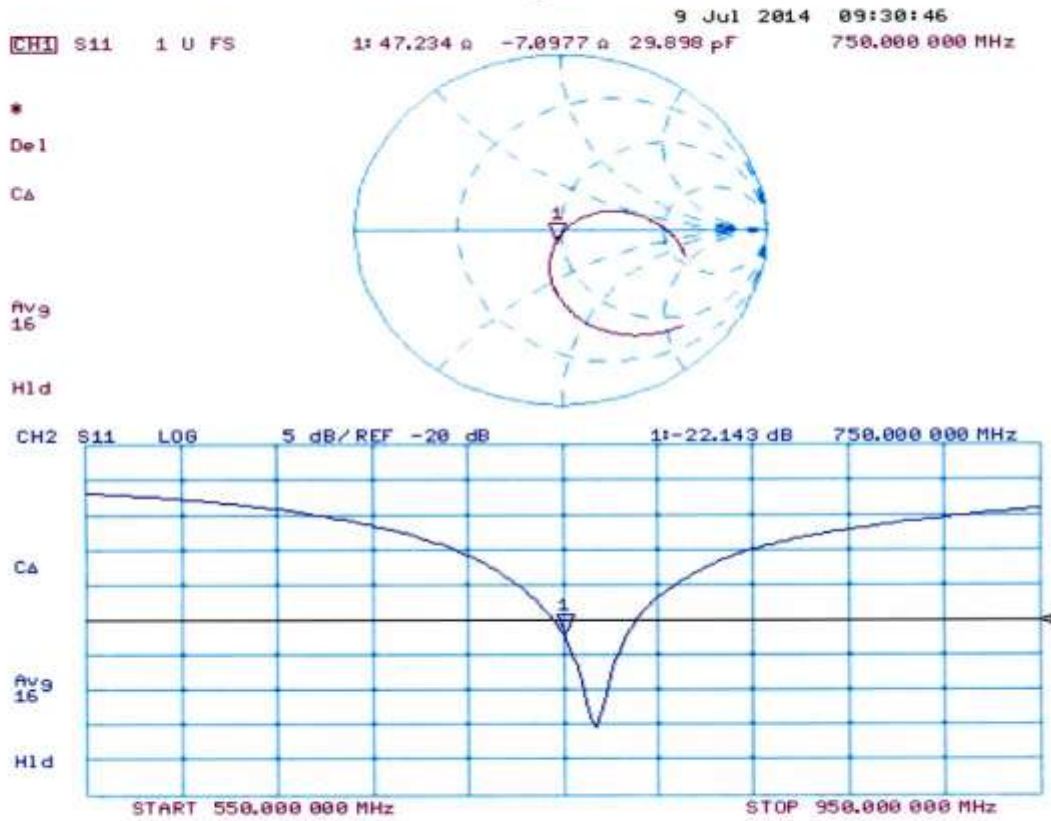

## Dipole Impedance and Return Loss calibration Report

**Object:** D750V3 - SN: 1118  
**Calibration Date:** June 26, 2015  
**Calibration reference:** IEEE Std 1528:2003, IEC 62209-1:2005, FCC KDB 865664 D01  
**Calibrated By:** *Janet Wei* (Janet Wei, SAR project engineer)  
**Reviewed By:** *Bruce Zhang* (Bruce Zhang, Technical manager)

### Environment of Test Site

Temperature:	21 ~ 23°C
Humidity:	50~60% RH
Atmospheric Pressure:	1011 mbar

### Test Data

Measurement Plot for Head TSL

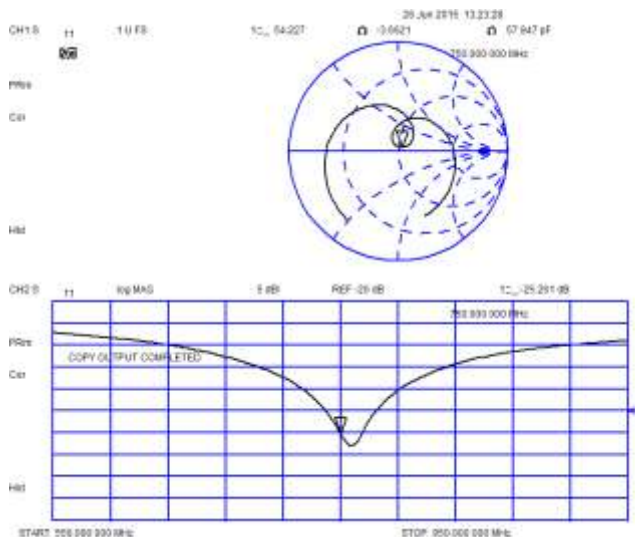

Measurement Plot for Body TSL

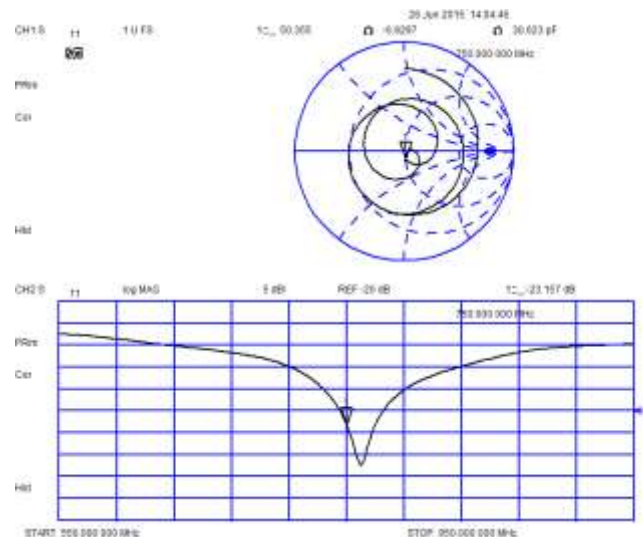

### Comparison with Original report

Items	Calibrated By Speag	Calibrated By CCIS	Deviation	Limit
Impedence for Head TSL	52.3Ω-5.7jΩ	54.2Ω-3.7 jΩ	1.9Ω+2.0 jΩ	±5Ω
Return Loss for Head TSL	-24.5dB	-25.3dB	-3.3%	±20%(No less than 20 dB)
Impedence for Body TSL	47.2Ω-7.1 jΩ	50.4Ω-6.9 jΩ	3.2Ω+0.2 jΩ	±5Ω
Return Loss for Body TSL	-22.1dB	-23.2dB	-5.0%	±20%(No less than 20 dB)

### Result

Compliance



**Calibration Laboratory of  
Schmid & Partner  
Engineering AG**  
Zeughausstrasse 43, 8004 Zurich, Switzerland



**S** Schweizerischer Kalibrierdienst  
**C** Service suisse d'étalonnage  
**S** Servizio svizzero di taratura  
**S** Swiss Calibration Service

Accredited by the Swiss Accreditation Service (SAS)  
The Swiss Accreditation Service is one of the signatories to the EA  
Multilateral Agreement for the recognition of calibration certificates

Accreditation No.: **SCS 108**

Client **CCIS (Auden)**

Certificate No: **D835V2-4d154\_Jun13**

CALIBRATION CERTIFICATE																																															
Object	D835V2 - SN: 4d154																																														
Calibration procedure(s)	QA CAL-05.v9 Calibration procedure for dipole validation kits above 700 MHz																																														
Calibration date:	June 06, 2013																																														
<p>This calibration certificate documents the traceability to national standards, which realize the physical units of measurements (SI). The measurements and the uncertainties with confidence probability are given on the following pages and are part of the certificate.</p> <p>All calibrations have been conducted in the closed laboratory facility: environment temperature (22 ± 3)°C and humidity &lt; 70%.</p> <p>Calibration Equipment used (M&amp;TE critical for calibration)</p> <table border="1"> <thead> <tr> <th>Primary Standards</th> <th>ID #</th> <th>Cal Date (Certificate No.)</th> <th>Scheduled Calibration</th> </tr> </thead> <tbody> <tr> <td>Power meter EPM-442A</td> <td>GB37480704</td> <td>01-Nov-12 (No. 217-01640)</td> <td>Oct-13</td> </tr> <tr> <td>Power sensor HP 8481A</td> <td>US37292783</td> <td>01-Nov-12 (No. 217-01640)</td> <td>Oct-13</td> </tr> <tr> <td>Reference 20 dB Attenuator</td> <td>SN: 5058 (20k)</td> <td>04-Apr-13 (No. 217-01736)</td> <td>Apr-14</td> </tr> <tr> <td>Type-N mismatch combination</td> <td>SN: 5047.3 / 06327</td> <td>04-Apr-13 (No. 217-01739)</td> <td>Apr-14</td> </tr> <tr> <td>Reference Probe ES3DV3</td> <td>SN: 3205</td> <td>28-Dec-12 (No. ES3-3205_Dec12)</td> <td>Dec-13</td> </tr> <tr> <td>DAE4</td> <td>SN: 601</td> <td>25-Apr-13 (No. DAE4-601_Apr13)</td> <td>Apr-14</td> </tr> </tbody> </table> <table border="1"> <thead> <tr> <th>Secondary Standards</th> <th>ID #</th> <th>Check Date (in house)</th> <th>Scheduled Check</th> </tr> </thead> <tbody> <tr> <td>Power sensor HP 8481A</td> <td>MY41092317</td> <td>18-Oct-02 (in house check Oct-11)</td> <td>In house check: Oct-13</td> </tr> <tr> <td>RF generator R&amp;S SMT-06</td> <td>100005</td> <td>04-Aug-99 (in house check Oct-11)</td> <td>In house check: Oct-13</td> </tr> <tr> <td>Network Analyzer HP 8753E</td> <td>US37390585 S4206</td> <td>18-Oct-01 (in house check Oct-12)</td> <td>In house check: Oct-13</td> </tr> </tbody> </table>				Primary Standards	ID #	Cal Date (Certificate No.)	Scheduled Calibration	Power meter EPM-442A	GB37480704	01-Nov-12 (No. 217-01640)	Oct-13	Power sensor HP 8481A	US37292783	01-Nov-12 (No. 217-01640)	Oct-13	Reference 20 dB Attenuator	SN: 5058 (20k)	04-Apr-13 (No. 217-01736)	Apr-14	Type-N mismatch combination	SN: 5047.3 / 06327	04-Apr-13 (No. 217-01739)	Apr-14	Reference Probe ES3DV3	SN: 3205	28-Dec-12 (No. ES3-3205_Dec12)	Dec-13	DAE4	SN: 601	25-Apr-13 (No. DAE4-601_Apr13)	Apr-14	Secondary Standards	ID #	Check Date (in house)	Scheduled Check	Power sensor HP 8481A	MY41092317	18-Oct-02 (in house check Oct-11)	In house check: Oct-13	RF generator R&S SMT-06	100005	04-Aug-99 (in house check Oct-11)	In house check: Oct-13	Network Analyzer HP 8753E	US37390585 S4206	18-Oct-01 (in house check Oct-12)	In house check: Oct-13
Primary Standards	ID #	Cal Date (Certificate No.)	Scheduled Calibration																																												
Power meter EPM-442A	GB37480704	01-Nov-12 (No. 217-01640)	Oct-13																																												
Power sensor HP 8481A	US37292783	01-Nov-12 (No. 217-01640)	Oct-13																																												
Reference 20 dB Attenuator	SN: 5058 (20k)	04-Apr-13 (No. 217-01736)	Apr-14																																												
Type-N mismatch combination	SN: 5047.3 / 06327	04-Apr-13 (No. 217-01739)	Apr-14																																												
Reference Probe ES3DV3	SN: 3205	28-Dec-12 (No. ES3-3205_Dec12)	Dec-13																																												
DAE4	SN: 601	25-Apr-13 (No. DAE4-601_Apr13)	Apr-14																																												
Secondary Standards	ID #	Check Date (in house)	Scheduled Check																																												
Power sensor HP 8481A	MY41092317	18-Oct-02 (in house check Oct-11)	In house check: Oct-13																																												
RF generator R&S SMT-06	100005	04-Aug-99 (in house check Oct-11)	In house check: Oct-13																																												
Network Analyzer HP 8753E	US37390585 S4206	18-Oct-01 (in house check Oct-12)	In house check: Oct-13																																												
Calibrated by:	Name Leif Klysnar	Function Laboratory Technician	Signature 																																												
Approved by:	Name Katja Pokovic	Function Technical Manager	Signature 																																												
			Issued: June 6, 2013																																												
This calibration certificate shall not be reproduced except in full without written approval of the laboratory.																																															

**Calibration Laboratory of  
Schmid & Partner  
Engineering AG**  
Zeughausstrasse 43, 8004 Zurich, Switzerland



**S** Schweizerischer Kalibrierdienst  
**C** Service suisse d'étalonnage  
**S** Servizio svizzero di taratura  
**S** Swiss Calibration Service

Accredited by the Swiss Accreditation Service (SAS)  
The Swiss Accreditation Service is one of the signatories to the EA  
Multilateral Agreement for the recognition of calibration certificates

Accreditation No.: SCS 108

**Glossary:**

TSL tissue simulating liquid  
ConvF sensitivity in TSL / NORM x,y,z  
N/A not applicable or not measured

**Calibration is Performed According to the Following Standards:**

- a) IEEE Std 1528-2003, "IEEE Recommended Practice for Determining the Peak Spatial-Averaged Specific Absorption Rate (SAR) in the Human Head from Wireless Communications Devices: Measurement Techniques", December 2003
- b) IEC 62209-1, "Procedure to measure the Specific Absorption Rate (SAR) for hand-held devices used in close proximity to the ear (frequency range of 300 MHz to 3 GHz)", February 2005
- c) Federal Communications Commission Office of Engineering & Technology (FCC OET), "Evaluating Compliance with FCC Guidelines for Human Exposure to Radiofrequency Electromagnetic Fields; Additional Information for Evaluating Compliance of Mobile and Portable Devices with FCC Limits for Human Exposure to Radiofrequency Emissions", Supplement C (Edition 01-01) to Bulletin 65

**Additional Documentation:**

- d) DASY4/5 System Handbook

**Methods Applied and Interpretation of Parameters:**

- *Measurement Conditions:* Further details are available from the Validation Report at the end of the certificate. All figures stated in the certificate are valid at the frequency indicated.
- *Antenna Parameters with TSL:* The dipole is mounted with the spacer to position its feed point exactly below the center marking of the flat phantom section, with the arms oriented parallel to the body axis.
- *Feed Point Impedance and Return Loss:* These parameters are measured with the dipole positioned under the liquid filled phantom. The impedance stated is transformed from the measurement at the SMA connector to the feed point. The Return Loss ensures low reflected power. No uncertainty required.
- *Electrical Delay:* One-way delay between the SMA connector and the antenna feed point. No uncertainty required.
- *SAR measured:* SAR measured at the stated antenna input power.
- *SAR normalized:* SAR as measured, normalized to an input power of 1 W at the antenna connector.
- *SAR for nominal TSL parameters:* The measured TSL parameters are used to calculate the nominal SAR result.

The reported uncertainty of measurement is stated as the standard uncertainty of measurement multiplied by the coverage factor k=2, which for a normal distribution corresponds to a coverage probability of approximately 95%.

### Measurement Conditions

DASY system configuration, as far as not given on page 1.

DASY Version	DASY5	V52.8.6
Extrapolation	Advanced Extrapolation	
Phantom	Modular Flat Phantom	
Distance Dipole Center - TSL	15 mm	with Spacer
Zoom Scan Resolution	dx, dy, dz = 5 mm	
Frequency	835 MHz ± 1 MHz	

### Head TSL parameters

The following parameters and calculations were applied.

	Temperature	Permittivity	Conductivity
Nominal Head TSL parameters	22.0 °C	41.5	0.90 mho/m
Measured Head TSL parameters	(22.0 ± 0.2) °C	40.4 ± 6 %	0.94 mho/m ± 6 %
Head TSL temperature change during test	< 0.5 °C	----	----

### SAR result with Head TSL

SAR averaged over 1 cm <sup>3</sup> (1 g) of Head TSL	Condition	
SAR measured	250 mW input power	2.47 W/kg
SAR for nominal Head TSL parameters	normalized to 1W	9.51 W/kg ± 17.0 % (k=2)

SAR averaged over 10 cm <sup>3</sup> (10 g) of Head TSL	condition	
SAR measured	250 mW input power	1.59 W/kg
SAR for nominal Head TSL parameters	normalized to 1W	6.17 W/kg ± 16.5 % (k=2)

### Body TSL parameters

The following parameters and calculations were applied.

	Temperature	Permittivity	Conductivity
Nominal Body TSL parameters	22.0 °C	55.2	0.97 mho/m
Measured Body TSL parameters	(22.0 ± 0.2) °C	54.5 ± 6 %	1.00 mho/m ± 6 %
Body TSL temperature change during test	< 0.5 °C	----	----

### SAR result with Body TSL

SAR averaged over 1 cm <sup>3</sup> (1 g) of Body TSL	Condition	
SAR measured	250 mW input power	2.44 W/kg
SAR for nominal Body TSL parameters	normalized to 1W	9.51 W/kg ± 17.0 % (k=2)

SAR averaged over 10 cm <sup>3</sup> (10 g) of Body TSL	condition	
SAR measured	250 mW input power	1.59 W/kg
SAR for nominal Body TSL parameters	normalized to 1W	6.23 W/kg ± 16.5 % (k=2)

**Appendix**

**Antenna Parameters with Head TSL**

Impedance, transformed to feed point	52.4 $\Omega$ - 2.8 j $\Omega$
Return Loss	- 28.8 dB

**Antenna Parameters with Body TSL**

Impedance, transformed to feed point	48.2 $\Omega$ - 4.5 j $\Omega$
Return Loss	- 26.0 dB

**General Antenna Parameters and Design**

Electrical Delay (one direction)	1.432 ns
----------------------------------	----------

After long term use with 100W radiated power, only a slight warming of the dipole near the feedpoint can be measured.

The dipole is made of standard semirigid coaxial cable. The center conductor of the feeding line is directly connected to the second arm of the dipole. The antenna is therefore short-circuited for DC-signals. On some of the dipoles, small end caps are added to the dipole arms in order to improve matching when loaded according to the position as explained in the "Measurement Conditions" paragraph. The SAR data are not affected by this change. The overall dipole length is still according to the Standard.

No excessive force must be applied to the dipole arms, because they might bend or the soldered connections near the feedpoint may be damaged.

**Additional EUT Data**

Manufactured by	SPEAG
Manufactured on	December 28, 2012



**DASY5 Validation Report for Head TSL**

Date: 06.06.2013

Test Laboratory: SPEAG, Zurich, Switzerland

**DUT: Dipole 835 MHz; Type: D835V2; Serial: D835V2 - SN: 4d154**

Communication System: UID 0 - CW ; Frequency: 835 MHz  
 Medium parameters used:  $f = 835 \text{ MHz}$ ;  $\sigma = 0.94 \text{ S/m}$ ;  $\epsilon_r = 40.4$ ;  $\rho = 1000 \text{ kg/m}^3$   
 Phantom section: Flat Section  
 Measurement Standard: DASY5 (IEEE/IEC/ANSI C63.19-2007)

**DASY52 Configuration:**

- Probe: ES3DV3 - SN3205; ConvF(6.05, 6.05, 6.05); Calibrated: 28.12.2012;
- Sensor-Surface: 3mm (Mechanical Surface Detection)
- Electronics: DAE4 Sn601; Calibrated: 25.04.2013
- Phantom: Flat Phantom 4.9L; Type: QD000P49AA; Serial: 1001
- DASY52 52.8.6(1115); SEMCAD X 14.6.9(7117)

**Dipole Calibration for Head Tissue/Pin=250 mW, d=15mm/Zoom Scan (7x7x7)/Cube 0:**

Measurement grid:  $dx=5\text{mm}$ ,  $dy=5\text{mm}$ ,  $dz=5\text{mm}$   
 Reference Value = 57.316 V/m; Power Drift = -0.00 dB  
 Peak SAR (extrapolated) = 3.76 W/kg  
**SAR(1 g) = 2.47 W/kg; SAR(10 g) = 1.59 W/kg**  
 Maximum value of SAR (measured) = 2.91 W/kg

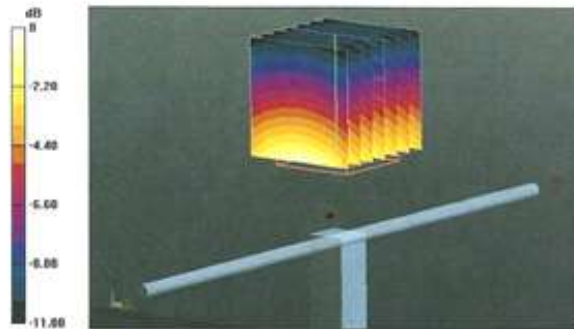

0 dB = 2.91 W/kg = 4.64 dBW/kg

### Impedance Measurement Plot for Head TSL

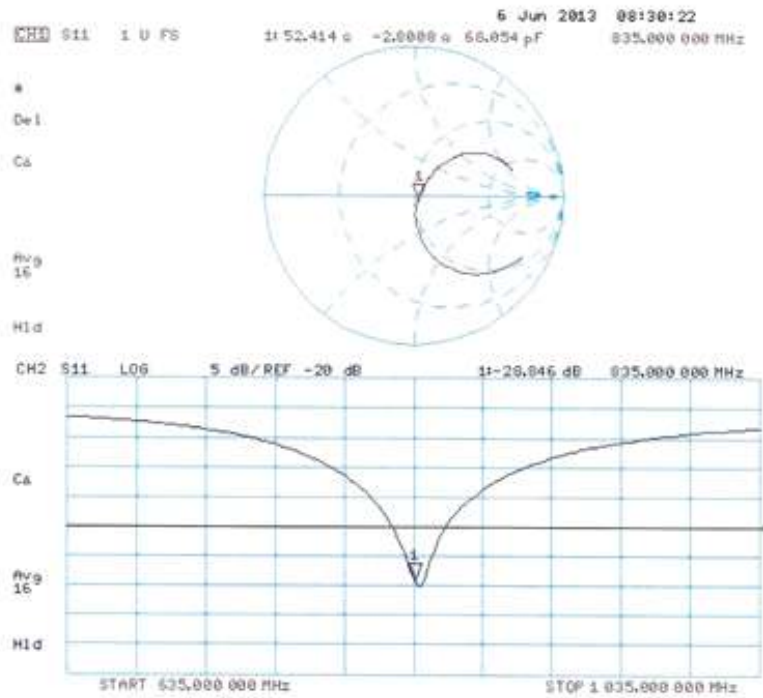



**DASY5 Validation Report for Body TSL**

Date: 05.06.2013

Test Laboratory: SPEAG, Zurich, Switzerland

**DUT: Dipole 835 MHz; Type: D835V2; Serial: D835V2 - SN: 4d154**

Communication System: UID 0 - CW ; Frequency: 835 MHz  
 Medium parameters used:  $f = 835 \text{ MHz}$ ;  $\sigma = 1 \text{ S/m}$ ;  $\epsilon_r = 54.5$ ;  $\rho = 1000 \text{ kg/m}^3$   
 Phantom section: Flat Section  
 Measurement Standard: DASY5 (IEEE/IEC/ANSI C63.19-2007)

**DASY52 Configuration:**

- Probe: ES3DV3 - SN3205; ConvF(6.04, 6.04, 6.04); Calibrated: 28.12.2012;
- Sensor-Surface: 3mm (Mechanical Surface Detection)
- Electronics: DAE4 Sn601; Calibrated: 25.04.2013
- Phantom: Flat Phantom 4.9L; Type: QD000P49AA; Serial: 1001
- DASY52 52.8.6(1115); SEMCAD X 14.6.9(7117)

**Dipole Calibration for Body Tissue/Pin=250 mW, d=15mm/Zoom Scan (7x7x7)/Cube 0:**

Measurement grid:  $dx=5\text{mm}$ ,  $dy=5\text{mm}$ ,  $dz=5\text{mm}$   
 Reference Value = 55.428 V/m; Power Drift = -0.00 dB  
 Peak SAR (extrapolated) = 3.58 W/kg  
**SAR(1 g) = 2.44 W/kg; SAR(10 g) = 1.59 W/kg**  
 Maximum value of SAR (measured) = 2.85 W/kg

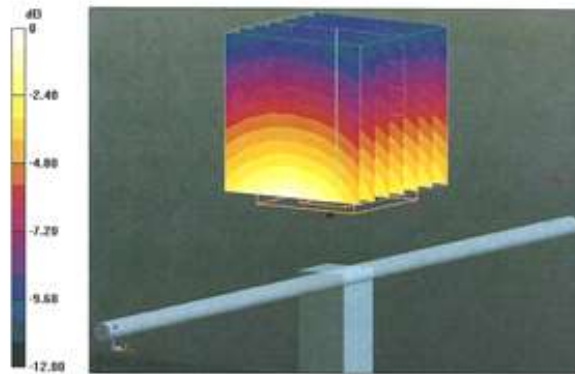

0 dB = 2.85 W/kg = 4.55 dBW/kg

### Impedance Measurement Plot for Body TSL

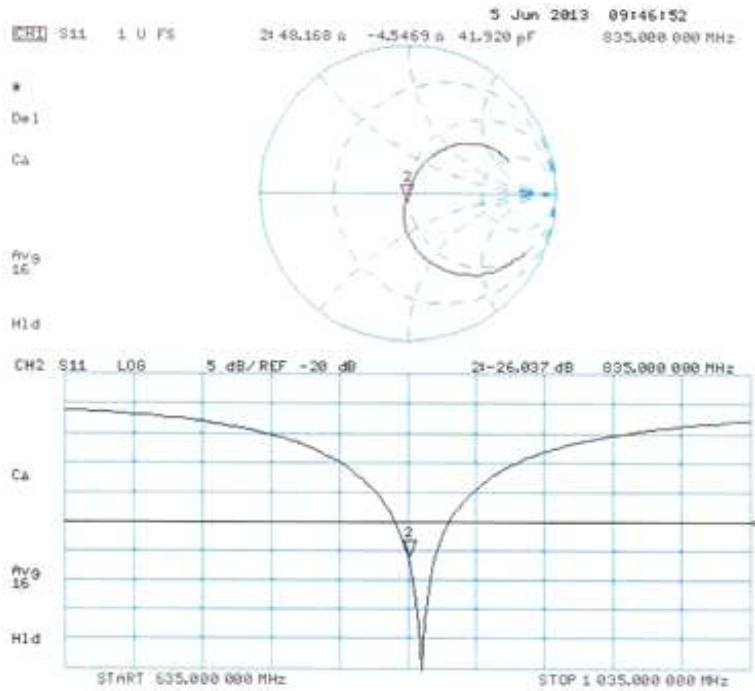

## Dipole Impedance and Return Loss calibration Report

**Object:** D835V2 - SN: 4d154

**Calibration Date:** June 25, 2015

**Calibration reference:** IEEE Std 1528:2013, IEC 62209-1:2006, FCC KDB 865664 D01

**Calibrated By:** *Janet Wei* (Janet Wei, SAR project engineer)

**Reviewed By:** *Bruce Zhang* (Bruce Zhang, Technical manager)

### Environment of Test Site

Temperature:	21 ~ 23°C
Humidity:	50~60% RH
Atmospheric Pressure:	1011 mbar

### Test Data

Measurement Plot for Head TSL In 2014

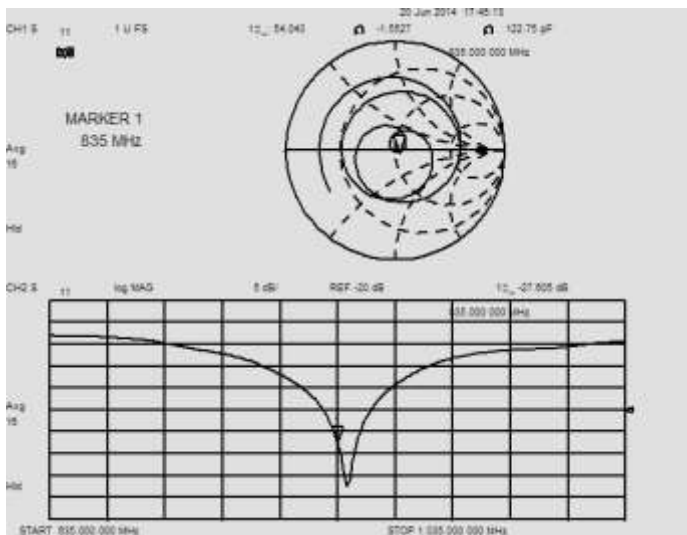

Measurement Plot for Body TSL In 2014

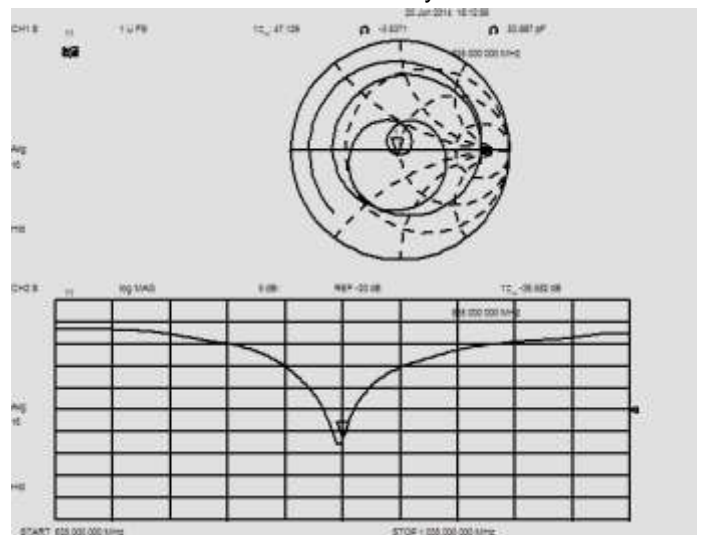

Measurement Plot for Head TSL In 2015

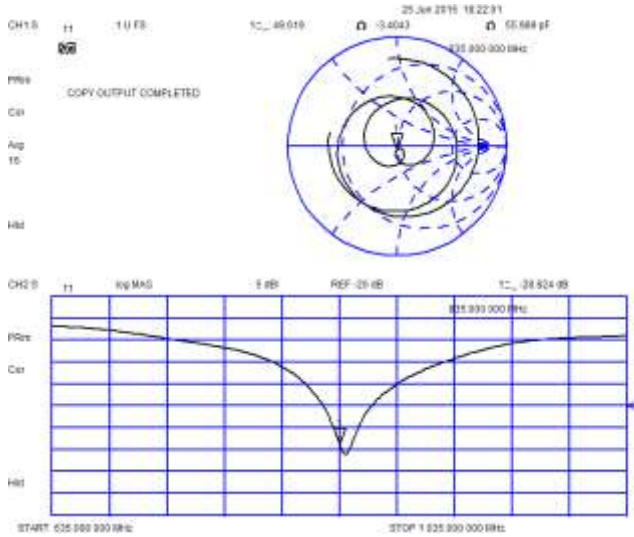

Measurement Plot for Body TSL In 2015

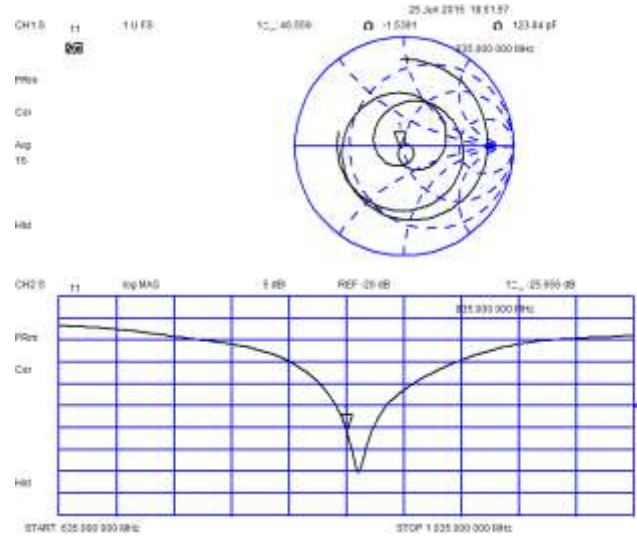

**Comparison with Original report**

Items	Calibrated By CCIS In 2014	Calibrated By CCIS In 2015	Deviation	Limit
Impedence for Head TSL	54.0Ω-1.6 jΩ	49.6Ω-3.4 jΩ	-4.4Ω-1.8 jΩ	±5Ω
Return Loss for Head TSL	-27.6dB	-28.8dB	4.3%	±20%(No less than 20 dB)
Impedence for Body TSL	47.1Ω-3.5 jΩ	46.6Ω-1.5 jΩ	-0.5Ω+2 jΩ	±5Ω
Return Loss for Body TSL	-26.6dB	-25.7dB	-3.4%	±20%(No less than 20 dB)

**Result**  
Compliance



In Collaboration with  
**s p e a g**  
CALIBRATION LABORATORY



Add: No.52 Huayuanbei Road, Haidian District, Beijing, 100191, China  
Tel: +86-10-62304633-2079 Fax: +86-10-62304633-2504  
E-mail: Info@emcite.com [Http://www.emcite.com](http://www.emcite.com)

Client **Sunway** Certificate No: **J13-2-2184**

## CALIBRATION CERTIFICATE

Object: **D1750V2 - SN: 1021**

Calibration Procedure(s):  
**TMC-OS-E-02-194**  
Calibration procedure for dipole validation kits

Calibration date: **August 2, 2013**

This calibration Certificate documents the traceability to national standards, which realize the physical units of measurements(SI). The measurements and the uncertainties with confidence probability are given on the following pages and are part of the certificate.

All calibrations have been conducted in the closed laboratory facility: environment temperature(22±3)°C and humidity<70%.

Calibration Equipment used (M&TE critical for calibration)

Primary Standards	ID #	Cal Date(Calibrated by, Certificate No.)	Scheduled Calibration
Power Meter NRVD	102083	11-Sep-12 (TMC, No.JZ12-443)	Sep-13
Power sensor NRV-Z5	100595	11-Sep-12 (TMC, No. JZ12-443)	Sep -13
Reference Probe EX3DV4	SN 3846	20- Dec-12 (SPEAG, No.EX3-3846_Dec12)	Dec-13
DAE4	SN 777	22-Feb-13 (SPEAG, DAE4-777_Feb13)	Feb -14
Signal Generator E4438C	MY49070393	13-Nov-12 (TMC, No.JZ12-394)	Nov-13
Network Analyzer E8362B	MY43021135	19-Oct-12 (TMC, No.JZ13-278)	Oct-13

	Name	Function	Signature
Calibrated by:	Zhao Jing	SAR Test Engineer	
Reviewed by:	Qi Dianyuan	SAR Project Leader	
Approved by:	Xiao Li	Deputy Director of the laboratory	

Issued: August 6, 2013

This calibration certificate shall not be reproduced except in full without written approval of the laboratory.





In Collaboration with  
**s p e a g**  
 CALIBRATION LABORATORY

Add: No.52 Huayuanbei Road, Haidian District, Beijing, 100191, China  
 Tel: +86-10-62304633-2079 Fax: +86-10-62304633-2504  
 E-mail: Info@emcite.com [Http://www.emcite.com](http://www.emcite.com)

**Glossary:**

TSL tissue simulating liquid  
 ConvF sensitivity in TSL / NORM<sub>x,y,z</sub>  
 N/A not applicable or not measured

**Calibration is Performed According to the Following Standards:**

- a) IEEE Std 1528-2003, "IEEE Recommended Practice for Determining the Peak Spatial-Averaged Specific Absorption Rate (SAR) in the Human Head from Wireless Communications Devices: Measurement Techniques", December 2003
- b) IEC 62209-1, "Procedure to measure the Specific Absorption Rate (SAR) For hand-held devices used in close proximity to the ear (frequency range of 300MHz to 3GHz)", February 2005
- c) KDB865664, SAR Measurement Requirements for 100 MHz to 6 GHz

**Additional Documentation:**

- d) DASY4/5 System Handbook

**Methods Applied and Interpretation of Parameters:**

- *Measurement Conditions:* Further details are available from the Validation Report at the end of the certificate. All figures stated in the certificate are valid at the frequency indicated.
- *Antenna Parameters with TSL:* The dipole is mounted with the spacer to position its feed point exactly below the center marking of the flat phantom section, with the arms oriented parallel to the body axis.
- *Feed Point Impedance and Return Loss:* These parameters are measured with the dipole positioned under the liquid filled phantom. The impedance stated is transformed from the measurement at the SMA connector to the feed point. The Return Loss ensures low reflected power. No uncertainty required.
- *Electrical Delay:* One-way delay between the SMA connector and the antenna feed point. No uncertainty required.
- *SAR measured:* SAR measured at the stated antenna input power.
- *SAR normalized:* SAR as measured, normalized to an input power of 1 W at the antenna connector.
- *SAR for nominal TSL parameters:* The measured TSL parameters are used to calculate the nominal SAR result.

The reported uncertainty of measurement is stated as the standard uncertainty of Measurement multiplied by the coverage factor k=2, which for a normal distribution Corresponds to a coverage probability of approximately 95%.





In Collaboration with  
**s p e a g**  
CALIBRATION LABORATORY

Add: No.52 Huayuanbei Road, Haidian District, Beijing, 100191, China  
Tel: +86-10-62304633-2079 Fax: +86-10-62304633-2504  
E-mail: Info@emcite.com [Http://www.emcite.com](http://www.emcite.com)

### Measurement Conditions

DASY system configuration, as far as not given on page 1.

DASY Version	DASY52	52.8.7.1137
Extrapolation	Advanced Extrapolation	
Phantom	Twin Phantom	
Distance Dipole Center - TSL	10 mm	with Spacer
Zoom Scan Resolution	dx, dy, dz = 5 mm	
Frequency	1750 MHz ± 1 MHz	

### Head TSL parameters

The following parameters and calculations were applied.

	Temperature	Permittivity	Conductivity
Nominal Head TSL parameters	22.0 °C	40.1	1.37 mho/m
Measured Head TSL parameters	(22.0 ± 0.2) °C	40.6 ± 6 %	1.35 mho/m ± 6 %
Head TSL temperature change during test	<0.5 °C	----	----

### SAR result with Head TSL

SAR averaged over 1 cm <sup>3</sup> (1 g) of Head TSL	Condition	
SAR measured	250 mW input power	8.54 mW / g
SAR for nominal Head TSL parameters	normalized to 1W	34.6 mW / g ± 20.8 % (k=2)
SAR averaged over 10 cm <sup>3</sup> (10 g) of Head TSL	Condition	
SAR measured	250 mW input power	4.55 mW / g
SAR for nominal Head TSL parameters	normalized to 1W	18.3 mW / g ± 20.4 % (k=2)

### Body TSL parameters

The following parameters and calculations were applied.

	Temperature	Permittivity	Conductivity
Nominal Body TSL parameters	22.0 °C	53.4	1.49 mho/m
Measured Body TSL parameters	(22.0 ± 0.2) °C	53.4 ± 6 %	1.52 mho/m ± 6 %
Body TSL temperature change during test	<0.5 °C	----	----

### SAR result with Body TSL

SAR averaged over 1 cm <sup>3</sup> (1 g) of Body TSL	Condition	
SAR measured	250 mW input power	9.52mW / g
SAR for nominal Body TSL parameters	normalized to 1W	37.5 mW / g ± 20.8 % (k=2)
SAR averaged over 10 cm <sup>3</sup> (10 g) of Body TSL	Condition	
SAR measured	250 mW input power	5.06 mW / g
SAR for nominal Body TSL parameters	normalized to 1W	20.1 mW / g ± 20.4 % (k=2)



In Collaboration with  
**s p e a g**  
 CALIBRATION LABORATORY

Add: No.52 Huayuanbei Road, Haidian District, Beijing, 100191, China  
 Tel: +86-10-62304633-2079 Fax: +86-10-62304633-2504  
 E-mail: Info@emcite.com [Http://www.emcite.com](http://www.emcite.com)

**Appendix**

**Antenna Parameters with Head TSL**

Impedance, transformed to feed point	46.3Ω-0.22jΩ
Return Loss	- 31.0dB

**Antenna Parameters with Body TSL**

Impedance, transformed to feed point	49.5Ω-2.36jΩ
Return Loss	- 27.5dB

After long term use with 100W radiated power, only a slight warming of the dipole near the feedpoint can be measured.

The dipole is made of standard semirigid coaxial cable. The center conductor of the feeding line is directly connected to the second arm of the dipole. The antenna is therefore short-circuited for DC-signals. On some of the dipoles, small end caps are added to the dipole arms in order to improve matching when loaded according to the position as explained in the "Measurement Conditions" paragraph. The SAR data are not affected by this change. The overall dipole length is still according to the Standard.

No excessive force must be applied to the dipole arms, because they might bend or the soldered connections near the feedpoint may be damaged.

**Additional EUT Data**

Manufactured by	SPEAG
-----------------	-------





Add: No.52 Huayuanbei Road, Haidian District, Beijing, 100191, China  
 Tel: +86-10-62304633-2079 Fax: +86-10-62304633-2504  
 E-mail: Info@emcite.com [Http://www.emcite.com](http://www.emcite.com)

**DASY5 Validation Report for Head TSL**

Date: 02.08.2013

Test Laboratory: TMC, Beijing, China

**DUT: Dipole 1750 MHz; Type: D1750V2; Serial: D1750V2 - SN: 1021**

Communication System: CW; Frequency: 1750 MHz

Medium parameters used:  $f = 1750 \text{ MHz}$ ;  $\sigma = 1.35 \text{ mho/m}$ ;  $\epsilon_r = 40.554$ ;  $\rho = 1000 \text{ kg/m}^3$

Phantom section: Flat Section

Measurement Standard: DASY5 (IEEE/IEC/ANSI C63.19-2007)

**DASY5 Configuration:**

- Probe: EX3DV4 - SN3846; ConvF(8.39, 8.39,8.39); Calibrated:20,12,2012
- Sensor-Surface: 2mm (Mechanical Surface Detection);1.0, 31.0
- Electronics: DAE4 Sn777; Calibrated: 22/2/2013
- Phantom: Flat Phantom; Type: QD000P40CC;
- DASY52 52.8.7(1137); SEMCAD X Version 14.6.10 (7164)

**Dipole Calibration for Head Tissue/Pin=250mW, d=10mm/Zoom Scan**

(7x7x7)/Cube 0: Measurement grid:  $dx=5\text{mm}$ ,  $dy=5\text{mm}$ ,  $dz=5\text{mm}$

Reference Value = 92.999 V/m; Power Drift = -0.07 dB

Peak SAR (extrapolated) = 15.5 W/kg

**SAR(1 g) = 8.54 W/kg; SAR(10 g) = 4.55 W/kg**

Maximum value of SAR (measured) = 12.2 W/kg

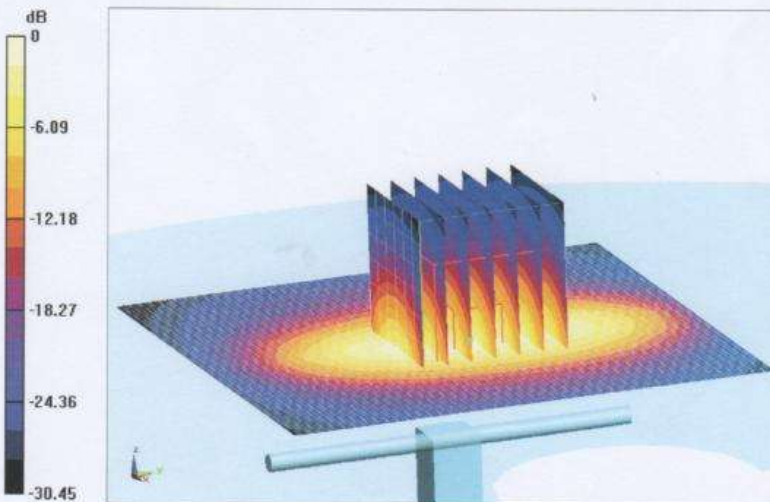

0 dB = 12.1 W/kg = 10.81 dBW/kg



Add: No.52 Huayuanbei Road, Haidian District, Beijing, 100191, China  
Tel: +86-10-62304633-2079 Fax: +86-10-62304633-2504  
E-mail: Info@emcite.com [Http://www.emcite.com](http://www.emcite.com)

### Impedance Measurement Plot for Head TSL

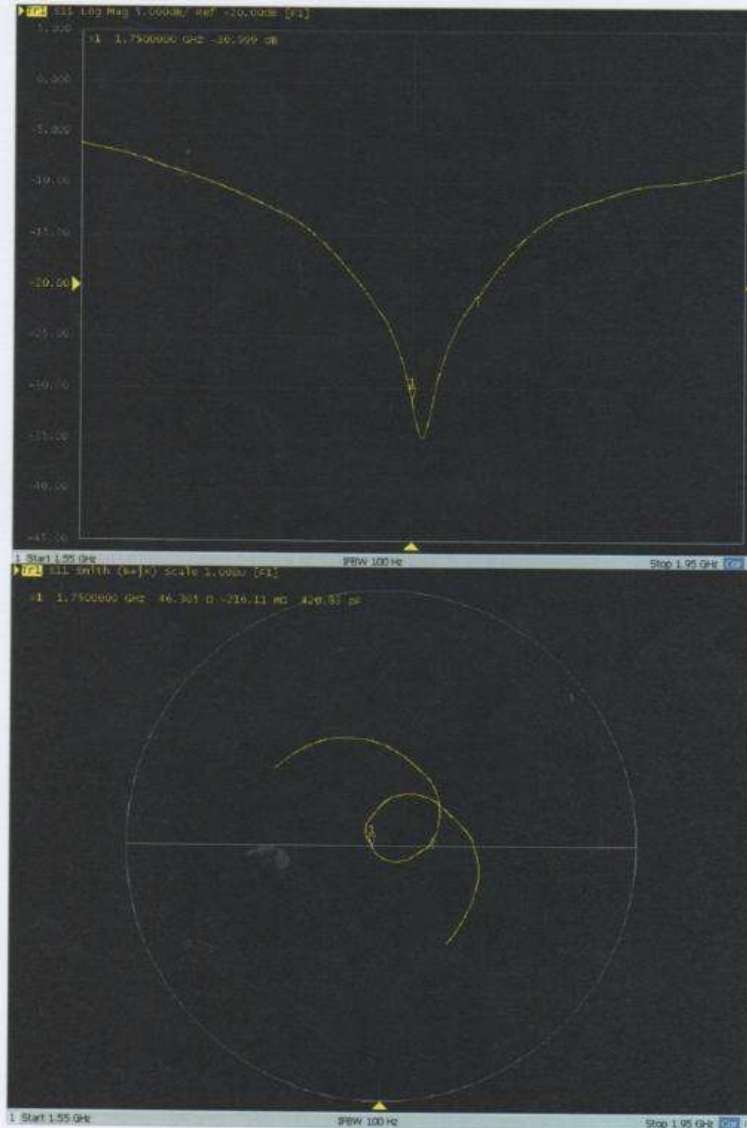

Certificate No: J13-2-2184

Page 6 of 8





Add: No.52 Huayuanbei Road, Haidian District, Beijing, 100191, China  
 Tel: +86-10-62304633-2079 Fax: +86-10-62304633-2504  
 E-mail: Info@emcite.com [Http://www.emcite.com](http://www.emcite.com)

**DASY5 Validation Report for Body TSL**

Date: 02.08.2013

Test Laboratory: TMC, Beijing, China

**DUT: Dipole 1750 MHz; Type: D1750V2; Serial: D1750V2 - SN: 1021**

Communication System: CW; Frequency: 1750 MHz;

Medium parameters used:  $f = 1750$  MHz;  $\sigma = 1.524$  mho/m;  $\epsilon_r = 53.401$ ;  $\rho = 1000$  kg/m<sup>3</sup>

Phantom section: Flat Phantom

Measurement Standard: DASY5 (IEEE/IEC/ANSI C63.19-2007)

**DASY5 Configuration:**

- Probe: EX3DV4 - SN3846; ConvF(7.63,7.63,7.63) ; Calibrated:20.12.2012
- Sensor-Surface: 2mm (Mechanical Surface Detection); 1.0, 31.0
- Electronics: DAE4 Sn777; Calibrated: 22/2/2013
- Phantom: ELI v4.0 1033;Type: QDOVA001BB;
- DASY52 52.8.7(1137); SEMCAD X Version 14.6.10 (7164)

**Dipole Calibration for Body Tissue/Pin=250mW, d=10mm/Zoom Scan**

(7x7x7)/Cube 0: Measurement grid: dx=5mm, dy=5mm, dz=5mm

Reference Value = 93.233 V/m; Power Drift = -0.00 dB

Peak SAR (extrapolated) = 16.9 W/kg

**SAR(1 g) = 9.52 W/kg; SAR(10 g) = 5.06 W/kg**

Maximum value of SAR (measured) = 13.5 W/kg

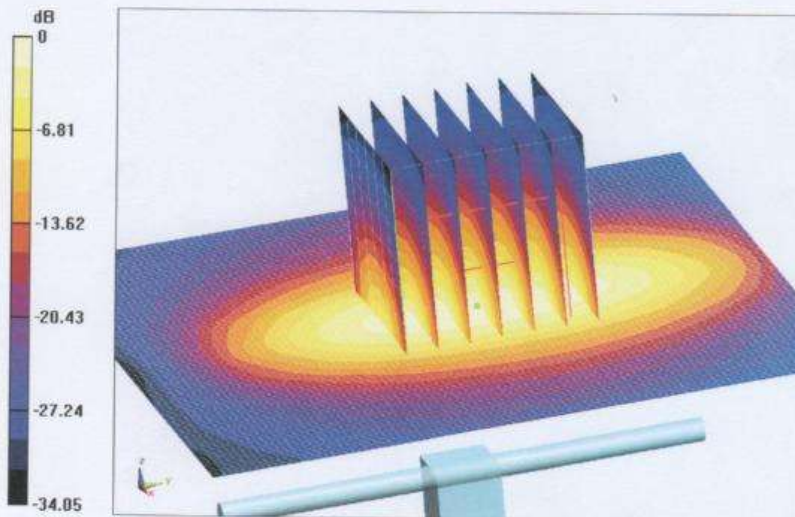

0 dB = 13.6 W/kg = 11.33 dBW/kg



Add: No.52 Huayuanbei Road, Haidian District, Beijing, 100191, China  
Tel: +86-10-62304633-2079 Fax: +86-10-62304633-2504  
E-mail: Info@emcite.com [Http://www.emcite.com](http://www.emcite.com)

### Impedance Measurement Plot for Body TSL

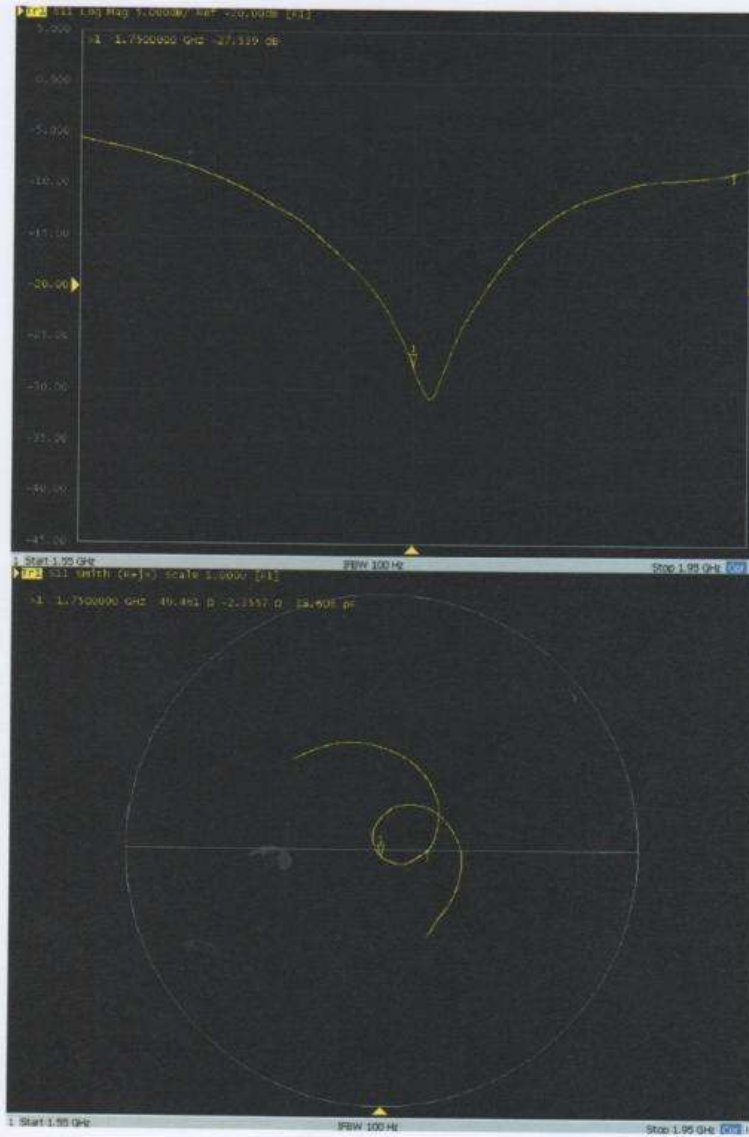



## Dipole Impedance and Return Loss calibration Report

**Object:** D1750V2 - SN: 1021

**Calibration Date:** Jan 215, 2015

**Calibration reference:** IEEE Std 1528:2013, IEC 62209-1:2006, FCC KDB 865664 D01

**Calibrated By:** *Tanet Wei* (Janet Wei, SAR project engineer)

**Reviewed By:** *Bruce Zhang* (Bruce Zhang, Technical manager)

### Environment of Test Site

Temperature:	21 ~ 23°C
Humidity:	50~60% RH
Atmospheric Pressure:	1011 mbar

### Test Data

Measurement Plot for Head TSL

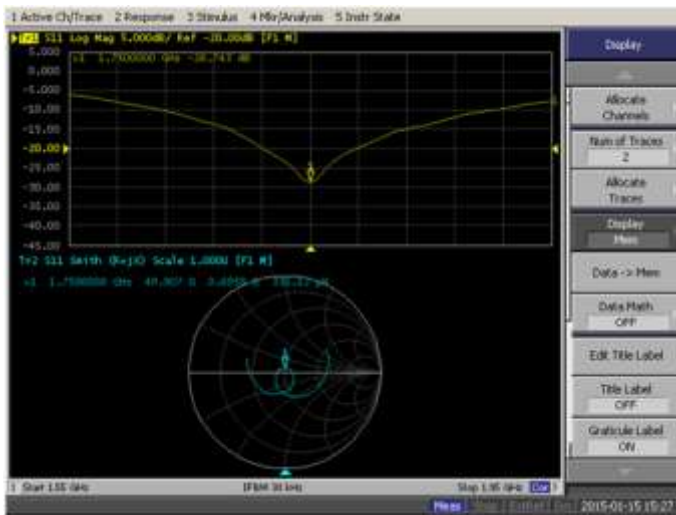

Measurement Plot for Body TSL

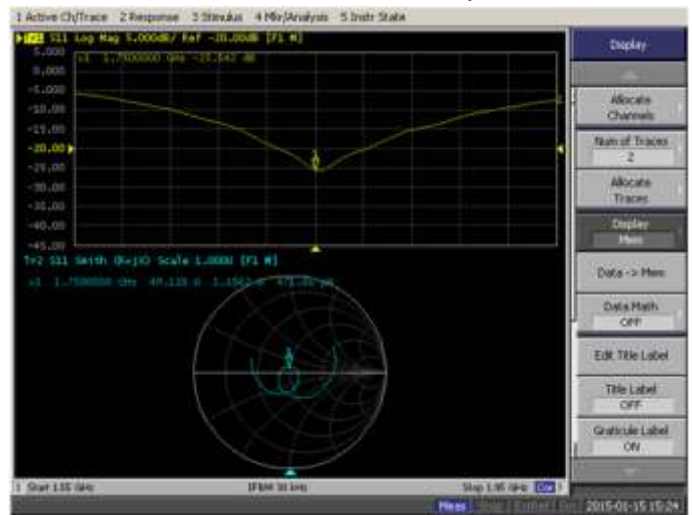

### Comparison with Original report

Items	Calibrated By Speag	Calibrated By CCIS	Deviation	Limit
Impedence for Head TSL	46.3Ω-0.22jΩ	49.9Ω+0.69 jΩ	-3.6Ω-0.91jΩ	±5Ω
Return Loss for Head TSL	-31.0dB	-28.74dB	7.3%	±20%(No less than 20 dB)
Impedence for Body TSL	49.5Ω-2.36 jΩ	49.13Ω+1.18 jΩ	0.37Ω-3.54 jΩ	±5Ω
Return Loss for Body TSL	-27.5dB	-25.54dB	7.1%	±20%(No less than 20 dB)

### Result

Compliance

**Calibration Laboratory of  
Schmid & Partner  
Engineering AG**  
Zeughausstrasse 43, 8004 Zurich, Switzerland



**S** Schweizerischer Kalibrierdienst  
**C** Service suisse d'étalonnage  
**S** Servizio svizzero di taratura  
**S** Swiss Calibration Service

Accredited by the Swiss Accreditation Service (SAS)  
The Swiss Accreditation Service is one of the signatories to the EA  
Multilateral Agreement for the recognition of calibration certificates

Accreditation No.: **SCS 108**

Client **CCIS (Auden)**

Certificate No: **D1900V2-5d175\_Jun13**

CALIBRATION CERTIFICATE			
Object	D1900V2 - SN: 5d175		
Calibration procedure(s)	QA CAL-05.v9 Calibration procedure for dipole validation kits above 700 MHz		
Calibration date:	June 10, 2013		
<p>This calibration certificate documents the traceability to national standards, which realize the physical units of measurements (SI). The measurements and the uncertainties with confidence probability are given on the following pages and are part of the certificate.</p> <p>All calibrations have been conducted in the closed laboratory facility; environment temperature (22 ± 3)°C and humidity &lt; 70%.</p> <p>Calibration Equipment used (M&amp;TE critical for calibration)</p>			
<b>Primary Standards</b>	<b>ID #</b>	<b>Cal Date (Certificate No.)</b>	<b>Scheduled Calibration</b>
Power meter EPM-442A	GB37480704	01-Nov-12 (No. 217-01640)	Oct-13
Power sensor HP 8481A	US37292783	01-Nov-12 (No. 217-01640)	Oct-13
Reference 20 dB Attenuator	SN: 5058 (20K)	04-Apr-13 (No. 217-01736)	Apr-14
Type-N mismatch combination	SN: 5047.3 / 06327	04-Apr-13 (No. 217-01739)	Apr-14
Reference Probe ES3DV3	SN: 3205	28-Dec-12 (No. ES3-3205_Dec12)	Dec-13
DAE4	SN: 601	25-Apr-13 (No. DAE4-601_Apr13)	Apr-14
<b>Secondary Standards</b>	<b>ID #</b>	<b>Check Date (in house)</b>	<b>Scheduled Check</b>
Power sensor HP 8481A	MY41092317	18-Oct-02 (in house check Oct-11)	In house check: Oct-13
RIF generator R&S SMT-06	100005	04-Aug-99 (in house check Oct-11)	In house check: Oct-13
Network Analyzer HP 8753E	US37390585 S4206	18-Oct-01 (in house check Oct-12)	In house check: Oct-13
Calibrated by:	Name Jeton Kastrati	Function Laboratory Technician	Signature 
Approved by:	Name Katja Pokovic	Function Technical Manager	Signature 
			Issued: June 11, 2013
This calibration certificate shall not be reproduced except in full without written approval of the laboratory.			

Certificate No: D1900V2-5d175\_Jun13

Page 1 of 8

**Calibration Laboratory of  
Schmid & Partner  
Engineering AG**  
Zeughausstrasse 43, 8004 Zurich, Switzerland



**S** Schweizerischer Kalibrierdienst  
**C** Service suisse d'étalonnage  
**S** Servizio svizzero di taratura  
**S** Swiss Calibration Service

Accredited by the Swiss Accreditation Service (SAS)  
The Swiss Accreditation Service is one of the signatories to the EA  
Multilateral Agreement for the recognition of calibration certificates

Accreditation No.: SCS 108

**Glossary:**

TSL	tissue simulating liquid
ConvF	sensitivity in TSL / NORM x,y,z
N/A	not applicable or not measured

**Calibration is Performed According to the Following Standards:**

- a) IEEE Std 1528-2003, "IEEE Recommended Practice for Determining the Peak Spatial-Averaged Specific Absorption Rate (SAR) in the Human Head from Wireless Communications Devices: Measurement Techniques", December 2003
- b) IEC 62209-1, "Procedure to measure the Specific Absorption Rate (SAR) for hand-held devices used in close proximity to the ear (frequency range of 300 MHz to 3 GHz)", February 2005
- c) Federal Communications Commission Office of Engineering & Technology (FCC OET), "Evaluating Compliance with FCC Guidelines for Human Exposure to Radiofrequency Electromagnetic Fields; Additional Information for Evaluating Compliance of Mobile and Portable Devices with FCC Limits for Human Exposure to Radiofrequency Emissions", Supplement C (Edition 01-01) to Bulletin 65

**Additional Documentation:**

- d) DASY4/5 System Handbook

**Methods Applied and Interpretation of Parameters:**

- *Measurement Conditions:* Further details are available from the Validation Report at the end of the certificate. All figures stated in the certificate are valid at the frequency indicated.
- *Antenna Parameters with TSL:* The dipole is mounted with the spacer to position its feed point exactly below the center marking of the flat phantom section, with the arms oriented parallel to the body axis.
- *Feed Point Impedance and Return Loss:* These parameters are measured with the dipole positioned under the liquid filled phantom. The impedance stated is transformed from the measurement at the SMA connector to the feed point. The Return Loss ensures low reflected power. No uncertainty required.
- *Electrical Delay:* One-way delay between the SMA connector and the antenna feed point. No uncertainty required.
- *SAR measured:* SAR measured at the stated antenna input power.
- *SAR normalized:* SAR as measured, normalized to an input power of 1 W at the antenna connector.
- *SAR for nominal TSL parameters:* The measured TSL parameters are used to calculate the nominal SAR result.

The reported uncertainty of measurement is stated as the standard uncertainty of measurement multiplied by the coverage factor  $k=2$ , which for a normal distribution corresponds to a coverage probability of approximately 95%.

### Measurement Conditions

DASY system configuration, as far as not given on page 1.

DASY Version	DASY5	V52.8.7
Extrapolation	Advanced Extrapolation	
Phantom	Modular Flat Phantom	
Distance Dipole Center - TSL	10 mm	with Spacer
Zoom Scan Resolution	dx, dy, dz = 5 mm	
Frequency	1900 MHz ± 1 MHz	

### Head TSL parameters

The following parameters and calculations were applied.

	Temperature	Permittivity	Conductivity
Nominal Head TSL parameters	22.0 °C	40.0	1.40 mho/m
Measured Head TSL parameters	(22.0 ± 0.2) °C	39.3 ± 6 %	1.34 mho/m ± 6 %
Head TSL temperature change during test	< 0.5 °C	----	----

### SAR result with Head TSL

SAR averaged over 1 cm <sup>3</sup> (1 g) of Head TSL	Condition	
SAR measured	250 mW input power	9.76 W/kg
SAR for nominal Head TSL parameters	normalized to 1W	39.9 W/kg ± 17.0 % (k=2)

SAR averaged over 10 cm <sup>3</sup> (10 g) of Head TSL	condition	
SAR measured	250 mW input power	5.14 W/kg
SAR for nominal Head TSL parameters	normalized to 1W	20.8 W/kg ± 16.5 % (k=2)

### Body TSL parameters

The following parameters and calculations were applied.

	Temperature	Permittivity	Conductivity
Nominal Body TSL parameters	22.0 °C	53.3	1.52 mho/m
Measured Body TSL parameters	(22.0 ± 0.2) °C	53.7 ± 6 %	1.50 mho/m ± 6 %
Body TSL temperature change during test	< 0.5 °C	----	----

### SAR result with Body TSL

SAR averaged over 1 cm <sup>3</sup> (1 g) of Body TSL	Condition	
SAR measured	250 mW input power	10.1 W/kg
SAR for nominal Body TSL parameters	normalized to 1W	40.8 W/kg ± 17.0 % (k=2)

SAR averaged over 10 cm <sup>3</sup> (10 g) of Body TSL	condition	
SAR measured	250 mW input power	5.38 W/kg
SAR for nominal Body TSL parameters	normalized to 1W	21.6 W/kg ± 16.5 % (k=2)



**Appendix**

**Antenna Parameters with Head TSL**

Impedance, transformed to feed point	54.0 Ω + 5.4 jΩ
Return Loss	- 23.8 dB

**Antenna Parameters with Body TSL**

Impedance, transformed to feed point	49.2 Ω + 5.7 jΩ
Return Loss	- 24.7 dB

**General Antenna Parameters and Design**

Electrical Delay (one direction)	1.202 ns
----------------------------------	----------

After long term use with 100W radiated power, only a slight warming of the dipole near the feedpoint can be measured.

The dipole is made of standard semirigid coaxial cable. The center conductor of the feeding line is directly connected to the second arm of the dipole. The antenna is therefore short-circuited for DC-signals. On some of the dipoles, small end caps are added to the dipole arms in order to improve matching when loaded according to the position as explained in the "Measurement Conditions" paragraph. The SAR data are not affected by this change. The overall dipole length is still according to the Standard.

No excessive force must be applied to the dipole arms, because they might bend or the soldered connections near the feedpoint may be damaged.

**Additional EUT Data**

Manufactured by	SPEAG
Manufactured on	June 08, 2012



**DASY5 Validation Report for Head TSL**

Date: 10.06.2013

Test Laboratory: SPEAG, Zurich, Switzerland

**DUT: Dipole 1900 MHz; Type: D1900V2; Serial: D1900V2 - SN: 5d175**

Communication System: UID 0 - CW ; Frequency: 1900 MHz

Medium parameters used:  $f = 1900$  MHz;  $\sigma = 1.34$  S/m;  $\epsilon_r = 39.3$ ;  $\rho = 1000$  kg/m<sup>3</sup>

Phantom section: Flat Section

Measurement Standard: DASY5 (IEEE/IEC/ANSI C63.19-2007)

**DASY52 Configuration:**

- Probe: ES3DV3 - SN3205; ConvF(4.98, 4.98, 4.98); Calibrated: 28.12.2012;
- Sensor-Surface: 3mm (Mechanical Surface Detection)
- Electronics: DAE4 Sn601; Calibrated: 25.04.2013
- Phantom: Flat Phantom 5.0 (front); Type: QD000P50AA; Serial: 1001
- DASY52 52.8.7(1137); SEMCAD X 14.6.10(7164)

**Dipole Calibration for Head Tissue/Pin=250 mW, d=10mm/Zoom Scan (7x7x7)/Cube 0:**

Measurement grid: dx=5mm, dy=5mm, dz=5mm

Reference Value = 96.173 V/m; Power Drift = 0,06 dB

Peak SAR (extrapolated) = 17.7 W/kg

**SAR(1 g) = 9.76 W/kg; SAR(10 g) = 5.14 W/kg**

Maximum value of SAR (measured) = 12.1 W/kg

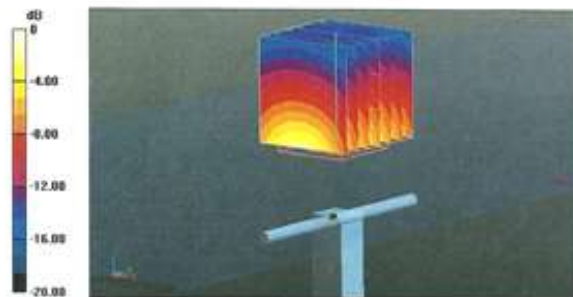

0 dB = 12.1 W/kg = 10.83 dBW/kg

### Impedance Measurement Plot for Head TSL

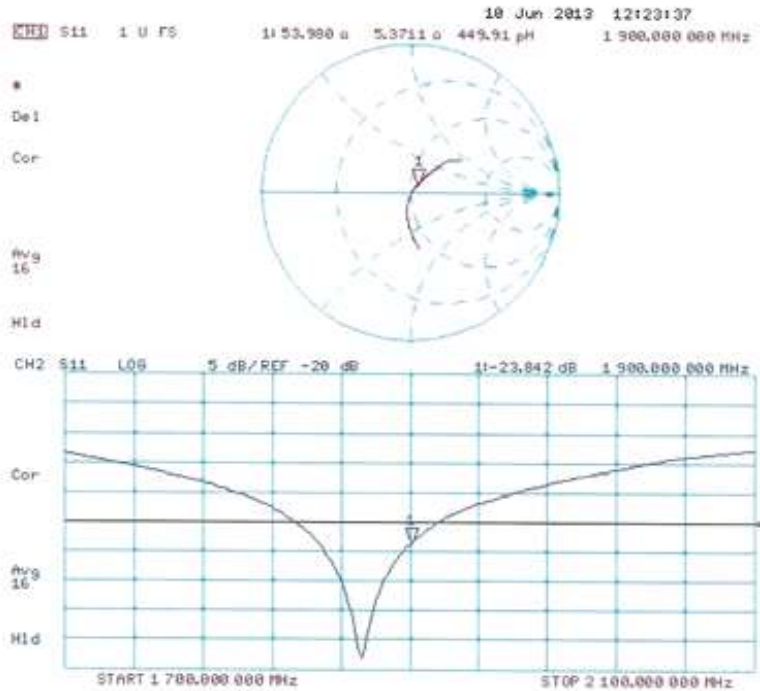

**DASY5 Validation Report for Body TSL**

Date: 10.06.2013

Test Laboratory: SPEAG, Zurich, Switzerland

**DUT: Dipole 1900 MHz; Type: D1900V2; Serial: D1900V2 - SN: 5d175**

Communication System: UID 0 - CW ; Frequency: 1900 MHz

Medium parameters used:  $f = 1900$  MHz;  $\sigma = 1.5$  S/m;  $\epsilon_r = 53.7$ ;  $\rho = 1000$  kg/m<sup>3</sup>

Phantom section: Flat Section

Measurement Standard: DASY5 (IEEE/IEC/ANSI C63.19-2007)

**DASY52 Configuration:**

- Probe: ES3DV3 - SN3205; ConvF(4.6, 4.6, 4.6); Calibrated: 28.12.2012;
- Sensor-Surface: 3mm (Mechanical Surface Detection)
- Electronics: DAE4 Sn601; Calibrated: 25.04.2013
- Phantom: Flat Phantom 5.0 (back); Type: QD000P50AA; Serial: 1002
- DASY52 52.8.7(1137); SEMCAD X 14.6.10(7164)

**Dipole Calibration for Body Tissue/Pin=250 mW, d=10mm/Zoom Scan (7x7x7)/Cube 0:**

Measurement grid: dx=5mm, dy=5mm, dz=5mm

Reference Value = 96.173 V/m; Power Drift = 0.02 dB

Peak SAR (extrapolated) = 17.2 W/kg

**SAR(1 g) = 10.1 W/kg; SAR(10 g) = 5.38 W/kg**

Maximum value of SAR (measured) = 12.7 W/kg

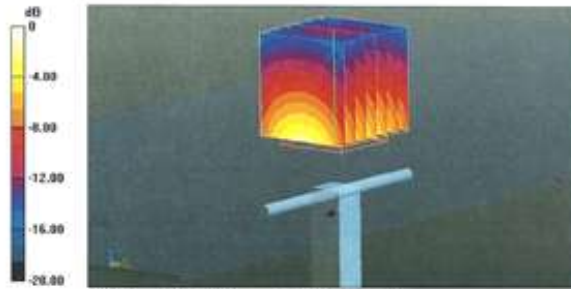

0 dB = 12.7 W/kg = 11.04 dBW/kg

## Impedance Measurement Plot for Body TSL

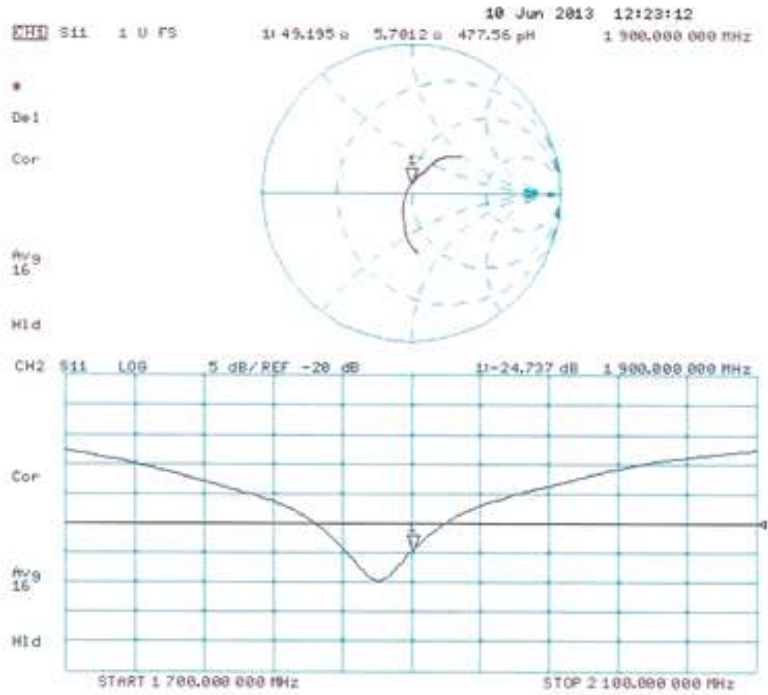

## Dipole Impedance and Return Loss calibration Report

**Object:** D1900V2 - SN: 5d175

**Calibration Date:** June 25, 2015

**Calibration reference:** IEEE Std 1528:2013, IEC 62209-1:2006, FCC KDB 865664 D01

**Calibrated By:** *Tanet Wei* (Janet Wei, SAR project engineer)

**Reviewed By:** *Bruce Zhang* (Bruce Zhang, Technical manager)

### Environment of Test Site

Temperature:	18 ~ 25°C
Humidity:	50~60% RH
Atmospheric Pressure:	1011 mbar

### Test Data

Measurement Plot for Head TSL In 2014

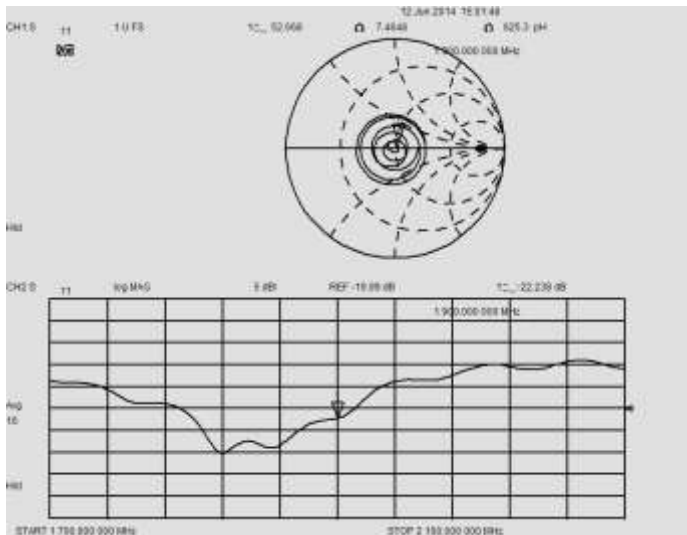

Measurement Plot for Body TSL In 2014

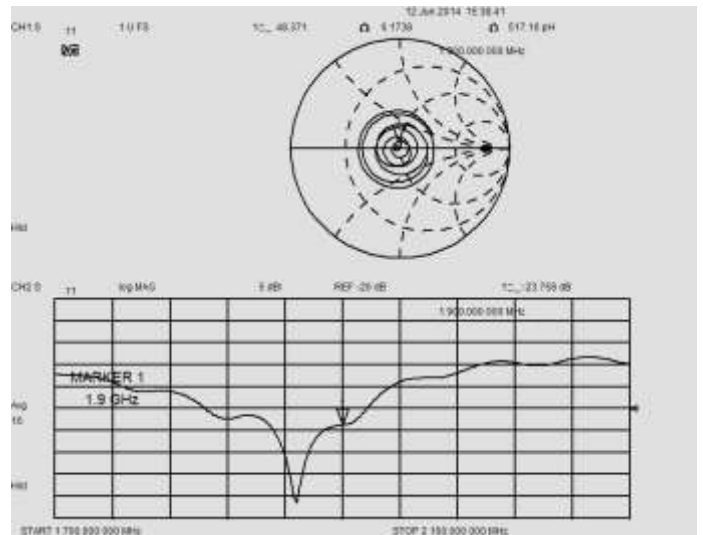



Measurement Plot for Head TSL In 2015

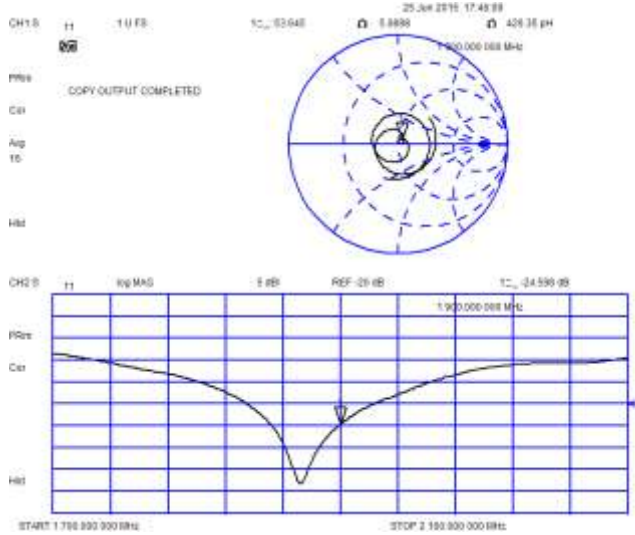

Measurement Plot for Body TSL In 2015

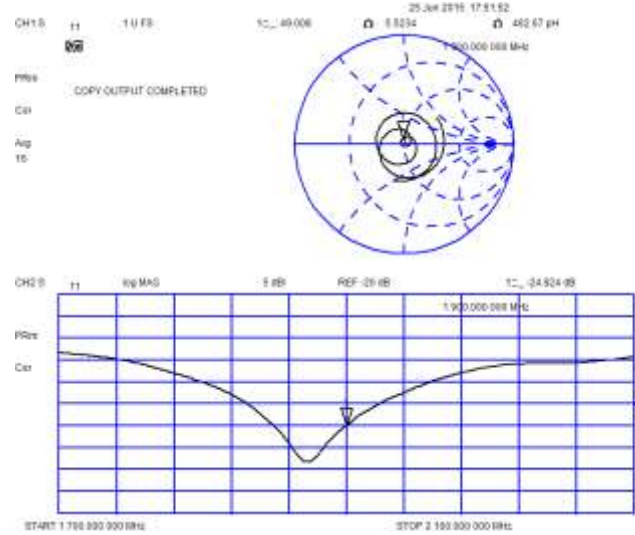

**Comparison with Original report**

Items	Calibrated By CCIS In 2014	Calibrated By CCIS In 2015	Deviation	Limit
Impedence for Head TSL	52.7Ω+7.5 jΩ	53.6Ω+5.1 jΩ	0.9Ω-2.4jΩ	±5Ω
Return Loss for Head TSL	-22.2dB	-24.6dB	10.8%	±20%(No less than 20 dB)
Impedence for Body TSL	48.4Ω+6.2 jΩ	49.0Ω+5.5 jΩ	0.6Ω-0.7jΩ	±5Ω
Return Loss for Body TSL	-23.8dB	-24.8dB	4.2%	±20%(No less than 20 dB)

**Result**

Compliance

**Calibration Laboratory of  
Schmid & Partner  
Engineering AG**  
Zeughausstrasse 43, 8004 Zurich, Switzerland



S Schweizerischer Kalibrierdienst  
C Service suisse d'étalonnage  
S Servizio svizzero di taratura  
S Swiss Calibration Service

Accredited by the Swiss Accreditation Service (SAS)  
The Swiss Accreditation Service is one of the signatories to the EA  
Multilateral Agreement for the recognition of calibration certificates

Accreditation No.: SCS 108

Client **CCIS (Auden)**

Certificate No: D2450V2-910\_Jun13

## CALIBRATION CERTIFICATE

Object **D2450V2 - SN: 910**

Calibration procedure(s) **QA CAL-05.v9  
Calibration procedure for dipole validation kits above 700 MHz**

Calibration date: **June 07, 2013**

This calibration certificate documents the traceability to national standards, which realize the physical units of measurements (SI).  
The measurements and the uncertainties with confidence probability are given on the following pages and are part of the certificate.

All calibrations have been conducted in the closed laboratory facility: environment temperature (22 ± 3)°C and humidity < 70%.

Calibration Equipment used (M&TE critical for calibration)

Primary Standards	ID #	Cal Date (Certificate No.)	Scheduled Calibration
Power meter EPM-442A	GB37480704	01-Nov-12 (No. 217-01640)	Oct-13
Power sensor HP 8481A	US37292783	01-Nov-12 (No. 217-01640)	Oct-13
Reference 20 dB Attenuator	SN: 5058 (20k)	04-Apr-13 (No. 217-01736)	Apr-14
Type-N mismatch combination	SN: 5047.3 / 06327	04-Apr-13 (No. 217-01738)	Apr-14
Reference Probe ES3DV3	SN: 3205	28-Dec-12 (No. ES3-3205_Dec12)	Dec-13
DAE4	SN: 601	25-Apr-13 (No. DAE4-601_Apr13)	Apr-14
Secondary Standards	ID #	Check Date (in house)	Scheduled Check
Power sensor HP 8481A	MY41092317	18-Oct-02 (in house check Oct-11)	In house check: Oct-13
RF generator R&S SMT-06	100005	04-Aug-99 (in house check Oct-11)	In house check: Oct-13
Network Analyzer HP 8753E	US37390585 S4206	18-Oct-01 (in house check Oct-12)	In house check: Oct-13

	Name	Function	Signature
Calibrated by:	Leif Klysner	Laboratory Technician	
Approved by:	Katja Pokovic	Technical Manager	

Issued: June 7, 2013

This calibration certificate shall not be reproduced except in full without written approval of the laboratory.

**Calibration Laboratory of  
Schmid & Partner  
Engineering AG**  
Zeughausstrasse 43, 8004 Zurich, Switzerland



S Schweizerischer Kalibrierdienst  
C Service suisse d'étalonnage  
S Servizio svizzero di taratura  
S Swiss Calibration Service

Accredited by the Swiss Accreditation Service (SAS)  
The Swiss Accreditation Service is one of the signatories to the EA  
Multilateral Agreement for the recognition of calibration certificates

Accreditation No.: SCS 108

**Glossary:**

TSL tissue simulating liquid  
ConvF sensitivity in TSL / NORM x,y,z  
N/A not applicable or not measured

**Calibration is Performed According to the Following Standards:**

- a) IEEE Std 1528-2003, "IEEE Recommended Practice for Determining the Peak Spatial-Averaged Specific Absorption Rate (SAR) in the Human Head from Wireless Communications Devices: Measurement Techniques", December 2003
- b) IEC 62209-1, "Procedure to measure the Specific Absorption Rate (SAR) for hand-held devices used in close proximity to the ear (frequency range of 300 MHz to 3 GHz)", February 2005
- c) Federal Communications Commission Office of Engineering & Technology (FCC OET), "Evaluating Compliance with FCC Guidelines for Human Exposure to Radiofrequency Electromagnetic Fields; Additional Information for Evaluating Compliance of Mobile and Portable Devices with FCC Limits for Human Exposure to Radiofrequency Emissions", Supplement C (Edition 01-01) to Bulletin 65

**Additional Documentation:**

- d) DASY4/5 System Handbook

**Methods Applied and Interpretation of Parameters:**

- *Measurement Conditions:* Further details are available from the Validation Report at the end of the certificate. All figures stated in the certificate are valid at the frequency indicated.
- *Antenna Parameters with TSL:* The dipole is mounted with the spacer to position its feed point exactly below the center marking of the flat phantom section, with the arms oriented parallel to the body axis.
- *Feed Point Impedance and Return Loss:* These parameters are measured with the dipole positioned under the liquid filled phantom. The impedance stated is transformed from the measurement at the SMA connector to the feed point. The Return Loss ensures low reflected power. No uncertainty required.
- *Electrical Delay:* One-way delay between the SMA connector and the antenna feed point. No uncertainty required.
- *SAR measured:* SAR measured at the stated antenna input power.
- *SAR normalized:* SAR as measured, normalized to an input power of 1 W at the antenna connector.
- *SAR for nominal TSL parameters:* The measured TSL parameters are used to calculate the nominal SAR result.

The reported uncertainty of measurement is stated as the standard uncertainty of measurement multiplied by the coverage factor k=2, which for a normal distribution corresponds to a coverage probability of approximately 95%.

### Measurement Conditions

DASY system configuration, as far as not given on page 1.

DASY Version	DASY5	V52.8.7
Extrapolation	Advanced Extrapolation	
Phantom	Modular Flat Phantom	
Distance Dipole Center - TSL	10 mm	with Spacer
Zoom Scan Resolution	dx, dy, dz = 5 mm	
Frequency	2450 MHz ± 1 MHz	

### Head TSL parameters

The following parameters and calculations were applied.

	Temperature	Permittivity	Conductivity
Nominal Head TSL parameters	22.0 °C	39.2	1.80 mho/m
Measured Head TSL parameters	(22.0 ± 0.2) °C	37.8 ± 6 %	1.81 mho/m ± 6 %
Head TSL temperature change during test	< 0.5 °C	---	---

### SAR result with Head TSL

SAR averaged over 1 cm <sup>3</sup> (1 g) of Head TSL	Condition	
SAR measured	250 mW input power	13.5 W/kg
SAR for nominal Head TSL parameters	normalized to 1W	53.4 W/kg ± 17.0 % (k=2)

SAR averaged over 10 cm <sup>3</sup> (10 g) of Head TSL	condition	
SAR measured	250 mW input power	6.24 W/kg
SAR for nominal Head TSL parameters	normalized to 1W	24.8 W/kg ± 16.5 % (k=2)

### Body TSL parameters

The following parameters and calculations were applied.

	Temperature	Permittivity	Conductivity
Nominal Body TSL parameters	22.0 °C	52.7	1.95 mho/m
Measured Body TSL parameters	(22.0 ± 0.2) °C	50.9 ± 6 %	2.02 mho/m ± 6 %
Body TSL temperature change during test	< 0.5 °C	---	---

### SAR result with Body TSL

SAR averaged over 1 cm <sup>3</sup> (1 g) of Body TSL	Condition	
SAR measured	250 mW input power	13.2 W/kg
SAR for nominal Body TSL parameters	normalized to 1W	51.5 W/kg ± 17.0 % (k=2)

SAR averaged over 10 cm <sup>3</sup> (10 g) of Body TSL	condition	
SAR measured	250 mW input power	6.09 W/kg
SAR for nominal Body TSL parameters	normalized to 1W	24.0 W/kg ± 16.5 % (k=2)



**Appendix**

**Antenna Parameters with Head TSL**

Impedance, transformed to feed point	56.6 $\Omega$ + 1.8 $\mu\Omega$
Return Loss	- 23.9 dB

**Antenna Parameters with Body TSL**

Impedance, transformed to feed point	51.8 $\Omega$ + 3.0 $\mu\Omega$
Return Loss	- 29.3 dB

**General Antenna Parameters and Design**

Electrical Delay (one direction)	1.159 ns
----------------------------------	----------

After long term use with 100W radiated power, only a slight warming of the dipole near the feedpoint can be measured.

The dipole is made of standard semirigid coaxial cable. The center conductor of the feeding line is directly connected to the second arm of the dipole. The antenna is therefore short-circuited for DC-signals. On some of the dipoles, small end caps are added to the dipole arms in order to improve matching when loaded according to the position as explained in the "Measurement Conditions" paragraph. The SAR data are not affected by this change. The overall dipole length is still according to the Standard.

No excessive force must be applied to the dipole arms, because they might bend or the soldered connections near the feedpoint may be damaged.

**Additional EUT Data**

Manufactured by	SPEAG
Manufactured on	December 19, 2012



## DASY5 Validation Report for Head TSL

Date: 07.06.2013

Test Laboratory: SPEAG, Zurich, Switzerland

**DUT: Dipole 2450 MHz; Type: D2450V2; Serial: D2450V2 - SN: 910**

Communication System: UID 0 - CW ; Frequency: 2450 MHz

Medium parameters used:  $f = 2450$  MHz;  $\sigma = 1.81$  S/m;  $\epsilon_r = 37.8$ ;  $\rho = 1000$  kg/m<sup>3</sup>

Phantom section: Flat Section

Measurement Standard: DASY5 (IEEE/IEC/ANSI C63.19-2007)

DASY52 Configuration:

- Probe: ES3DV3 - SN3205; ConvF(4.52, 4.52, 4.52); Calibrated: 28.12.2012;
- Sensor-Surface: 3mm (Mechanical Surface Detection)
- Electronics: DAE4 Sn601; Calibrated: 25.04.2013
- Phantom: Flat Phantom 5.0 (front); Type: QD000P50AA; Serial: 1001
- DASY52 52.8.7(1137); SEMCAD X 14.6.10(7164)

### Dipole Calibration for Head Tissue/Pin=250 mW, d=10mm/Zoom Scan (7x7x7)/Cube 0:

Measurement grid: dx=5mm, dy=5mm, dz=5mm

Reference Value = 95,417 V/m; Power Drift = 0,06 dB

Peak SAR (extrapolated) = 28.1 W/kg

SAR(1 g) = 13.5 W/kg; SAR(10 g) = 6.24 W/kg

Maximum value of SAR (measured) = 17.3 W/kg

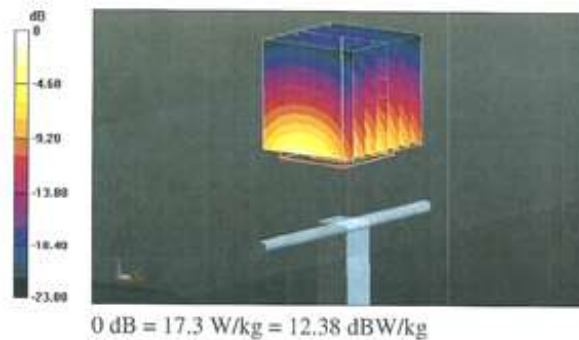

### Impedance Measurement Plot for Head TSL

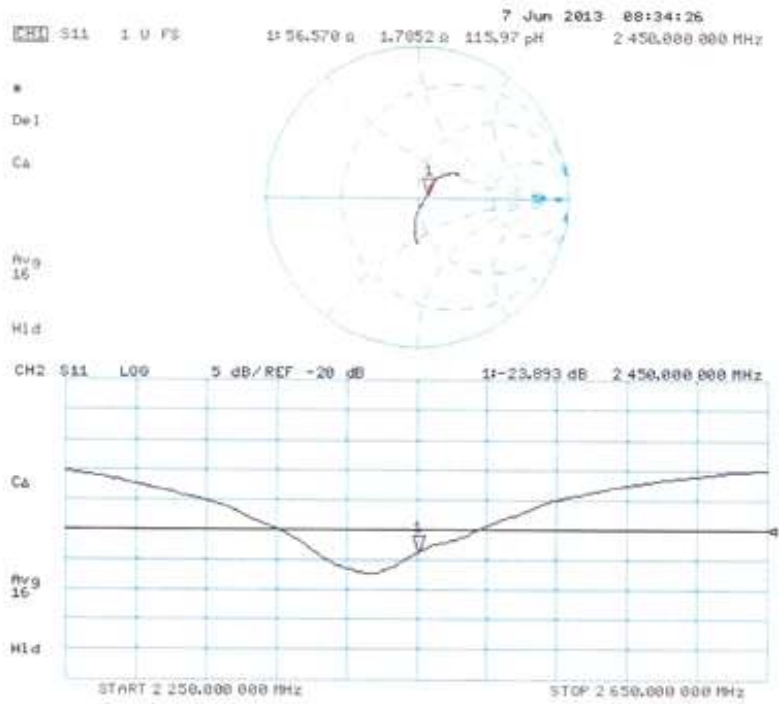

**DASY5 Validation Report for Body TSL**

Date: 07.06.2013

Test Laboratory: SPEAG, Zurich, Switzerland

**DUT: Dipole 2450 MHz; Type: D2450V2; Serial: D2450V2 - SN: 910**

Communication System: UID 0 - CW ; Frequency: 2450 MHz

Medium parameters used:  $f = 2450$  MHz;  $\sigma = 2.02$  S/m;  $\epsilon_r = 50.9$ ;  $\rho = 1000$  kg/m<sup>3</sup>

Phantom section: Flat Section

Measurement Standard: DASY5 (IEEE/IEC/ANSI C63.19-2007)

DASY52 Configuration:

- Probe: ES3DV3 - SN3205; ConvF(4.42, 4.42, 4.42); Calibrated: 28.12.2012;
- Sensor-Surface: 3mm (Mechanical Surface Detection)
- Electronics: DAE4 Sn601; Calibrated: 25.04.2013
- Phantom: Flat Phantom 5.0 (back); Type: QD000P50AA; Serial: 1002
- DASY52 52.8.7(1137); SEMCAD X 14.6.10(7164)

**Dipole Calibration for Body Tissue/Pin=250 mW, d=10mm/Zoom Scan (7x7x7)/Cube 0:**

Measurement grid: dx=5mm, dy=5mm, dz=5mm

Reference Value = 95.417 V/m; Power Drift = 0.01 dB

Peak SAR (extrapolated) = 27.6 W/kg

**SAR(1 g) = 13.2 W/kg; SAR(10 g) = 6.09 W/kg**

Maximum value of SAR (measured) = 17.4 W/kg

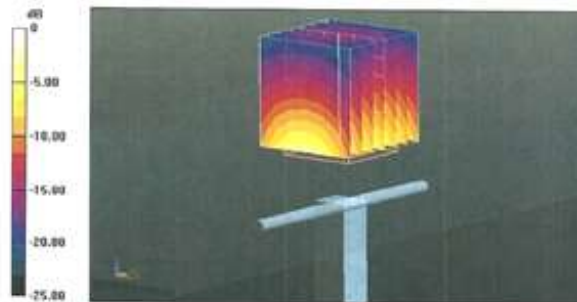

0 dB = 17.4 W/kg = 12.41 dBW/kg

### Impedance Measurement Plot for Body TSL

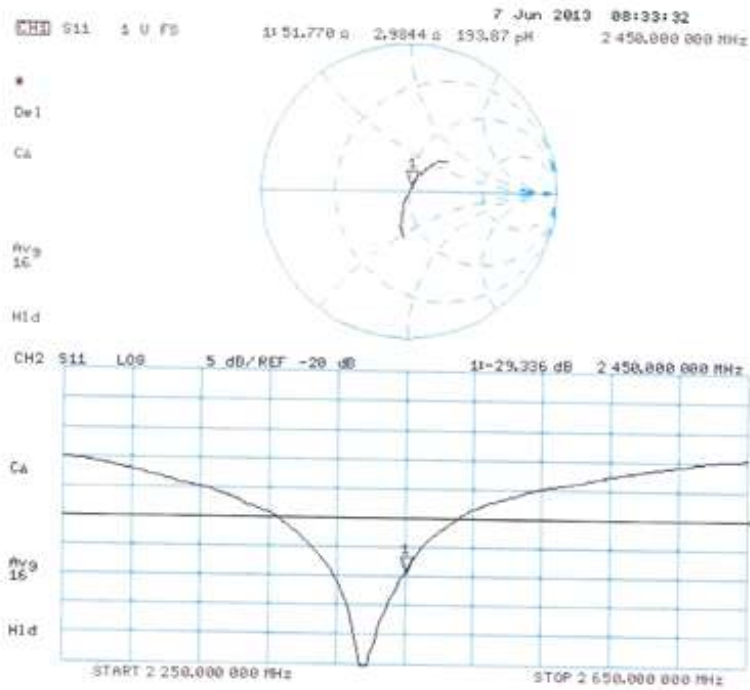

## Dipole Impedance and Return Loss calibration Report

**Object:** D2450V2 - SN: 910

**Calibration Date:** June 26, 2015

**Calibration reference:** IEEE Std 1528:2013, IEC 62209-1:2006, FCC KDB 865664 D01

**Calibrated By:** *Janet Wei* (Janet Wei, SAR project engineer)

**Reviewed By:** *Bruce Zhang* (Bruce Zhang, Technical manager)

### Environment of Test Site

Temperature:	18 ~ 25°C
Humidity:	50~60% RH
Atmospheric Pressure:	1011 mbar

### Test Data

Measurement Plot for Head TSL In 2014

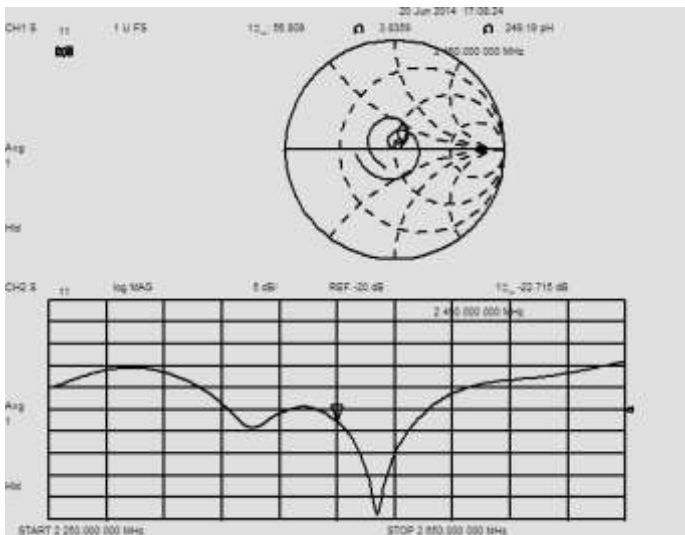

Measurement Plot for Body TSL In 2014

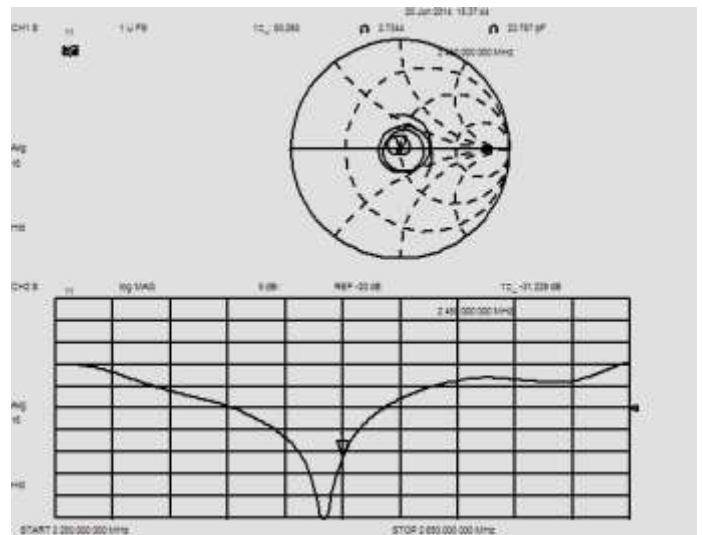



Measurement Plot for Head TSL In 2015

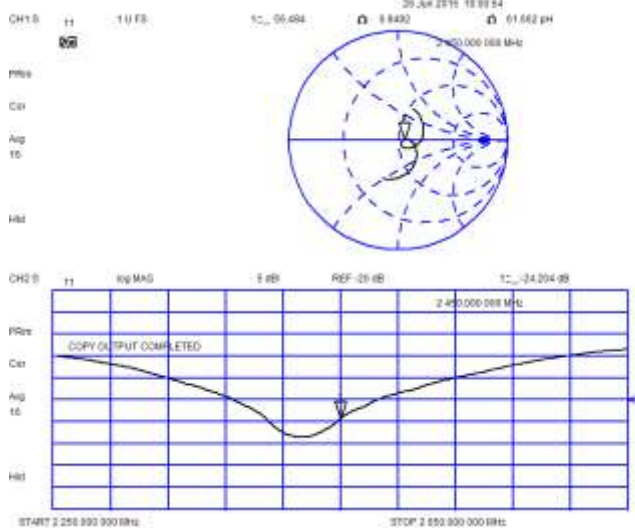

Measurement Plot for Body TSL In 2015

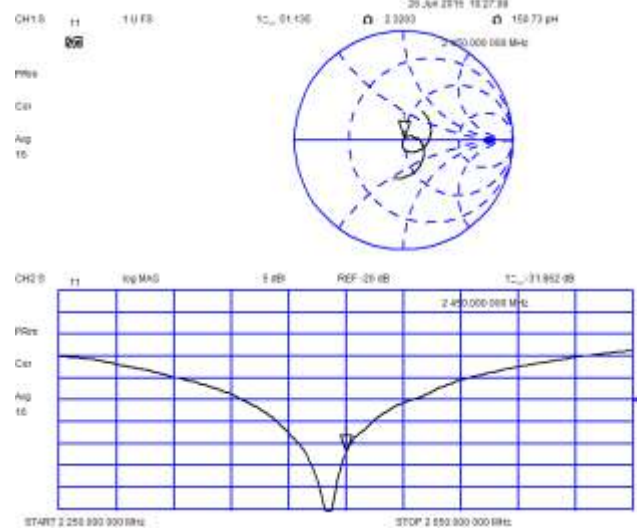

**Comparison with Original report**

Items	Calibrated By CCIS In 2014	Calibrated By CCIS In 2015	Deviation	Limit
Impedence for Head TSL	56.8Ω+3.8jΩ	56.5Ω+0.9jΩ	-0.3Ω-2.9 jΩ	±5Ω
Return Loss for Head TSL	-22.7dB	-24.2dB	6.6%	±20%(No less than 20 dB)
Impedence for Body TSL	50.3Ω+2.7jΩ	51.1Ω+2.3jΩ	0.8Ω-0.4 jΩ	±5Ω
Return Loss for Body TSL	-31.2dB	-31.9dB	2.2%	±20%(No less than 20 dB)

**Result**

Compliance

**Calibration Laboratory of  
Schmid & Partner  
Engineering AG**  
Zeughausstrasse 43, 8004 Zurich, Switzerland



S Schweizerischer Kalibrierdienst  
C Service suisse d'étalonnage  
S Servizio svizzero di taratura  
S Swiss Calibration Service

Accredited by the Swiss Accreditation Service (SAS)  
The Swiss Accreditation Service is one of the signatories to the EA  
Multilateral Agreement for the recognition of calibration certificates

Accreditation No.: SCS 0108

Client **CCIS-CN (Auden)**

Certificate No: D2600V2-1114\_Sep15

CALIBRATION CERTIFICATE																																															
Object	D2600V2 - SN: 1114																																														
Calibration procedure(s)	QA CAL-05.v9 Calibration procedure for dipole validation kits above 700 MHz																																														
Calibration date:	September 21, 2015																																														
<p>This calibration certificate documents the traceability to national standards, which realize the physical units of measurements (SI). The measurements and the uncertainties with confidence probability are given on the following pages and are part of the certificate.</p> <p>All calibrations have been conducted in the closed laboratory facility: environment temperature (22 ± 3)°C and humidity &lt; 70%.</p> <p>Calibration Equipment used (M&amp;TE critical for calibration)</p> <table border="1"> <thead> <tr> <th>Primary Standards</th> <th>ID #</th> <th>Cal Date (Certificate No.)</th> <th>Scheduled Calibration</th> </tr> </thead> <tbody> <tr> <td>Power meter EPM-442A</td> <td>GB37480704</td> <td>07-Oct-14 (No. 217-02020)</td> <td>Oct-15</td> </tr> <tr> <td>Power sensor HP 8481A</td> <td>US37282783</td> <td>07-Oct-14 (No. 217-02020)</td> <td>Oct-15</td> </tr> <tr> <td>Power sensor HP 8481A</td> <td>MY41092317</td> <td>07-Oct-14 (No. 217-02021)</td> <td>Oct-15</td> </tr> <tr> <td>Reference 20 dB Attenuator</td> <td>SN: 5058 (20k)</td> <td>01-Apr-15 (No. 217-02131)</td> <td>Mar-16</td> </tr> <tr> <td>Type-N mismatch combination</td> <td>SN: 5047.2 / 06327</td> <td>01-Apr-15 (No. 217-02134)</td> <td>Mar-16</td> </tr> <tr> <td>Reference Probe EX3DV4</td> <td>SN: 7349</td> <td>30-Dec-14 (No. EX3-7349_Dec14)</td> <td>Dec-15</td> </tr> <tr> <td>DAE4</td> <td>SN: 601</td> <td>17-Aug-15 (No. DAE4-601_Aug15)</td> <td>Aug-16</td> </tr> </tbody> </table> <table border="1"> <thead> <tr> <th>Secondary Standards</th> <th>ID #</th> <th>Check Date (in house)</th> <th>Scheduled Check</th> </tr> </thead> <tbody> <tr> <td>RF generator R&amp;S SMT-06</td> <td>100972</td> <td>15-Jun-15 (in house check Jun-15)</td> <td>In house check: Jun-16</td> </tr> <tr> <td>Network Analyzer HP 8753E</td> <td>US37390585 S4206</td> <td>18-Oct-01 (in house check Oct-14)</td> <td>In house check: Oct-15</td> </tr> </tbody> </table>				Primary Standards	ID #	Cal Date (Certificate No.)	Scheduled Calibration	Power meter EPM-442A	GB37480704	07-Oct-14 (No. 217-02020)	Oct-15	Power sensor HP 8481A	US37282783	07-Oct-14 (No. 217-02020)	Oct-15	Power sensor HP 8481A	MY41092317	07-Oct-14 (No. 217-02021)	Oct-15	Reference 20 dB Attenuator	SN: 5058 (20k)	01-Apr-15 (No. 217-02131)	Mar-16	Type-N mismatch combination	SN: 5047.2 / 06327	01-Apr-15 (No. 217-02134)	Mar-16	Reference Probe EX3DV4	SN: 7349	30-Dec-14 (No. EX3-7349_Dec14)	Dec-15	DAE4	SN: 601	17-Aug-15 (No. DAE4-601_Aug15)	Aug-16	Secondary Standards	ID #	Check Date (in house)	Scheduled Check	RF generator R&S SMT-06	100972	15-Jun-15 (in house check Jun-15)	In house check: Jun-16	Network Analyzer HP 8753E	US37390585 S4206	18-Oct-01 (in house check Oct-14)	In house check: Oct-15
Primary Standards	ID #	Cal Date (Certificate No.)	Scheduled Calibration																																												
Power meter EPM-442A	GB37480704	07-Oct-14 (No. 217-02020)	Oct-15																																												
Power sensor HP 8481A	US37282783	07-Oct-14 (No. 217-02020)	Oct-15																																												
Power sensor HP 8481A	MY41092317	07-Oct-14 (No. 217-02021)	Oct-15																																												
Reference 20 dB Attenuator	SN: 5058 (20k)	01-Apr-15 (No. 217-02131)	Mar-16																																												
Type-N mismatch combination	SN: 5047.2 / 06327	01-Apr-15 (No. 217-02134)	Mar-16																																												
Reference Probe EX3DV4	SN: 7349	30-Dec-14 (No. EX3-7349_Dec14)	Dec-15																																												
DAE4	SN: 601	17-Aug-15 (No. DAE4-601_Aug15)	Aug-16																																												
Secondary Standards	ID #	Check Date (in house)	Scheduled Check																																												
RF generator R&S SMT-06	100972	15-Jun-15 (in house check Jun-15)	In house check: Jun-16																																												
Network Analyzer HP 8753E	US37390585 S4206	18-Oct-01 (in house check Oct-14)	In house check: Oct-15																																												
Calibrated by:	Name Michael Weber	Function Laboratory Technician	Signature 																																												
Approved by:	Name Katja Pokovic	Function Technical Manager																																													
<p>This calibration certificate shall not be reproduced except in full without written approval of the laboratory.</p> <p>issued: September 23, 2015</p>																																															

**Calibration Laboratory of  
Schmid & Partner  
Engineering AG**  
Zeughausstrasse 43, 8004 Zurich, Switzerland



**S** Schweizerischer Kalibrierdienst  
**C** Service suisse d'étalonnage  
**S** Servizio svizzero di taratura  
**S** Swiss Calibration Service

Accredited by the Swiss Accreditation Service (SAS)  
The Swiss Accreditation Service is one of the signatories to the EA  
Multilateral Agreement for the recognition of calibration certificates

Accreditation No.: **SCS 0108**

**Glossary:**

TSL tissue simulating liquid  
ConvF sensitivity in TSL / NORM x,y,z  
N/A not applicable or not measured

**Calibration is Performed According to the Following Standards:**

- a) IEEE Std 1528-2013, "IEEE Recommended Practice for Determining the Peak Spatial-Averaged Specific Absorption Rate (SAR) in the Human Head from Wireless Communications Devices: Measurement Techniques", June 2013
- b) IEC 62209-1, "Procedure to measure the Specific Absorption Rate (SAR) for hand-held devices used in close proximity to the ear (frequency range of 300 MHz to 3 GHz)", February 2005
- c) IEC 62209-2, "Procedure to determine the Specific Absorption Rate (SAR) for wireless communication devices used in close proximity to the human body (frequency range of 30 MHz to 6 GHz)", March 2010
- d) KDB 865664, "SAR Measurement Requirements for 100 MHz to 6 GHz"

**Additional Documentation:**

- e) DAS4/5 System Handbook

**Methods Applied and Interpretation of Parameters:**

- *Measurement Conditions:* Further details are available from the Validation Report at the end of the certificate. All figures stated in the certificate are valid at the frequency indicated.
- *Antenna Parameters with TSL:* The dipole is mounted with the spacer to position its feed point exactly below the center marking of the flat phantom section, with the arms oriented parallel to the body axis.
- *Feed Point Impedance and Return Loss:* These parameters are measured with the dipole positioned under the liquid filled phantom. The impedance stated is transformed from the measurement at the SMA connector to the feed point. The Return Loss ensures low reflected power. No uncertainty required.
- *Electrical Delay:* One-way delay between the SMA connector and the antenna feed point. No uncertainty required.
- *SAR measured:* SAR measured at the stated antenna input power.
- *SAR normalized:* SAR as measured, normalized to an input power of 1 W at the antenna connector.
- *SAR for nominal TSL parameters:* The measured TSL parameters are used to calculate the nominal SAR result.

The reported uncertainty of measurement is stated as the standard uncertainty of measurement multiplied by the coverage factor k=2, which for a normal distribution corresponds to a coverage probability of approximately 95%.

### Measurement Conditions

DASY system configuration, as far as not given on page 1.

DASY Version	DASY5	V52.8.8
Extrapolation	Advanced Extrapolation	
Phantom	Modular Flat Phantom	
Distance Dipole Center - TSL	10 mm	with Spacer
Zoom Scan Resolution	dx, dy, dz = 5 mm	
Frequency	2600 MHz ± 1 MHz	

### Head TSL parameters

The following parameters and calculations were applied.

	Temperature	Permittivity	Conductivity
Nominal Head TSL parameters	22.0 °C	39.0	1.96 mho/m
Measured Head TSL parameters	(22.0 ± 0.2) °C	38.6 ± 6 %	2.04 mho/m ± 6 %
Head TSL temperature change during test	< 0.5 °C	----	----

### SAR result with Head TSL

SAR averaged over 1 cm <sup>3</sup> (1 g) of Head TSL	Condition	
SAR measured	250 mW input power	14.5 W/kg
SAR for nominal Head TSL parameters	normalized to 1W	56.9 W/kg ± 17.0 % (k=2)

SAR averaged over 10 cm <sup>3</sup> (10 g) of Head TSL	condition	
SAR measured	250 mW input power	6.41 W/kg
SAR for nominal Head TSL parameters	normalized to 1W	25.4 W/kg ± 16.5 % (k=2)

### Body TSL parameters

The following parameters and calculations were applied.

	Temperature	Permittivity	Conductivity
Nominal Body TSL parameters	22.0 °C	52.5	2.16 mho/m
Measured Body TSL parameters	(22.0 ± 0.2) °C	52.8 ± 6 %	2.19 mho/m ± 6 %
Body TSL temperature change during test	< 0.5 °C	----	----

### SAR result with Body TSL

SAR averaged over 1 cm <sup>3</sup> (1 g) of Body TSL	Condition	
SAR measured	250 mW input power	13.7 W/kg
SAR for nominal Body TSL parameters	normalized to 1W	54.5 W/kg ± 17.0 % (k=2)

SAR averaged over 10 cm <sup>3</sup> (10 g) of Body TSL	condition	
SAR measured	250 mW input power	6.12 W/kg
SAR for nominal Body TSL parameters	normalized to 1W	24.4 W/kg ± 16.5 % (k=2)



**Appendix (Additional assessments outside the scope of SCS 0108)**

**Antenna Parameters with Head TSL**

Impedance, transformed to feed point	49.8 $\Omega$ - 7.0 j $\Omega$
Return Loss	- 23.1 dB

**Antenna Parameters with Body TSL**

Impedance, transformed to feed point	45.7 $\Omega$ - 5.0 j $\Omega$
Return Loss	- 23.3 dB

**General Antenna Parameters and Design**

Electrical Delay (one direction)	1.154 ns
----------------------------------	----------

After long term use with 100W radiated power, only a slight warming of the dipole near the feedpoint can be measured.

The dipole is made of standard semirigid coaxial cable. The center conductor of the feeding line is directly connected to the second arm of the dipole. The antenna is therefore short-circuited for DC-signals. On some of the dipoles, small end caps are added to the dipole arms in order to improve matching when loaded according to the position as explained in the "Measurement Conditions" paragraph. The SAR data are not affected by this change. The overall dipole length is still according to the Standard.

No excessive force must be applied to the dipole arms, because they might bend or the soldered connections near the feedpoint may be damaged.

**Additional EUT Data**

Manufactured by	SPEAG
Manufactured on	September 10, 2015



**DASY5 Validation Report for Head TSL**

Date: 21.09.2015

Test Laboratory: SPEAG, Zurich, Switzerland

**DUT: Dipole 2600 MHz; Type: D2600V2; Serial: D2600V2 - SN: 1114**

Communication System: UID 0 - CW; Frequency: 2600 MHz

Medium parameters used:  $f = 2600$  MHz;  $\sigma = 2.04$  S/m;  $\epsilon_r = 38.6$ ;  $\rho = 1000$  kg/m<sup>3</sup>

Phantom section: Flat Section

Measurement Standard: DASY5 (IEEE/IEC/ANSI C63.19-2011)

DASY52 Configuration:

- Probe: EX3DV4 - SN7349; ConvF(7.4, 7.4, 7.4); Calibrated: 30.12.2014;
- Sensor-Surface: 1.4mm (Mechanical Surface Detection)
- Electronics: DAE4 Sn601; Calibrated: 17.08.2015
- Phantom: Flat Phantom 5.0 (front); Type: QD000P50AA; Serial: 1001
- DASY52 52.8.8(1222); SEMCAD X 14.6.10(7331)

**Dipole Calibration for Head Tissue/Pin=250 mW, d=10mm/Zoom Scan (7x7x7)/Cube 0:**

Measurement grid: dx=5mm, dy=5mm, dz=5mm

Reference Value = 115.6 V/m; Power Drift = 0.03 dB

Peak SAR (extrapolated) = 30.9 W/kg

**SAR(1 g) = 14.5 W/kg; SAR(10 g) = 6.41 W/kg**

Maximum value of SAR (measured) = 24.7 W/kg

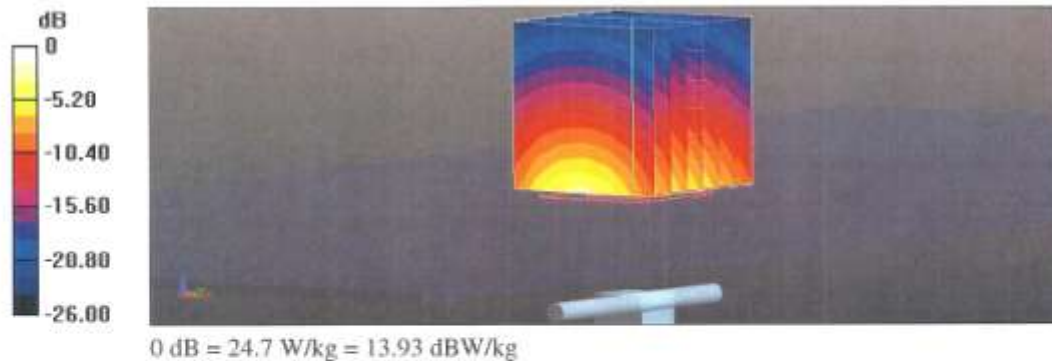

### Impedance Measurement Plot for Head TSL

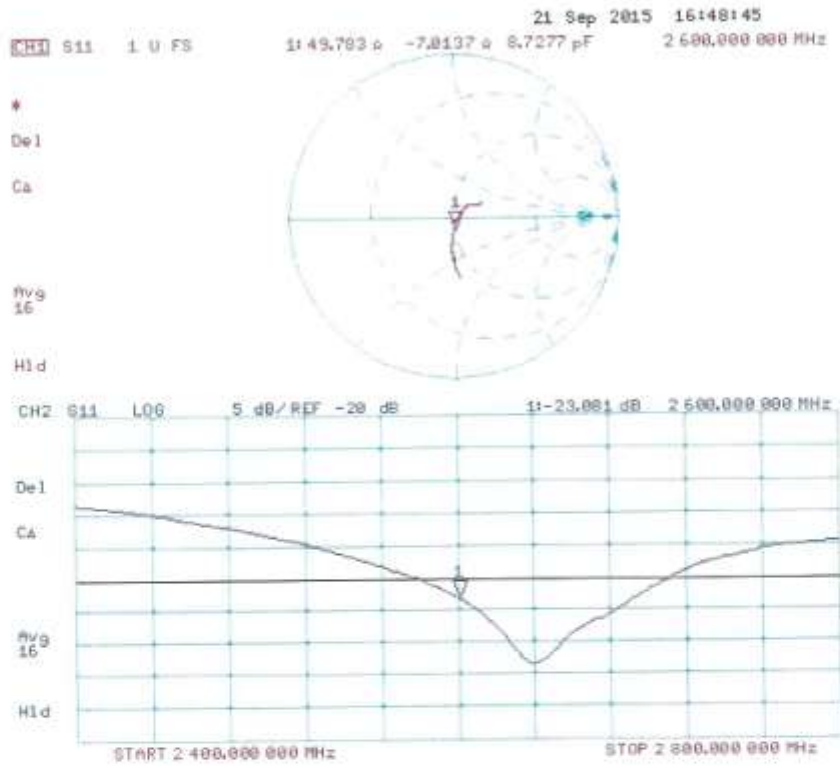

**DASY5 Validation Report for Body TSL**

Date: 17.09.2015

Test Laboratory: The name of your organization

**DUT: Dipole 2600 MHz; Type: D2600V2; Serial: D2600V2 - SN: 1114**

Communication System: UID 0 - CW; Frequency: 2600 MHz

Medium parameters used:  $f = 2600$  MHz;  $\sigma = 2.19$  S/m;  $\epsilon_r = 52.8$ ;  $\rho = 1000$  kg/m<sup>3</sup>

Phantom section: Flat Section

Measurement Standard: DASY5 (IEEE/IEC/ANSI C63.19-2011)

DASY52 Configuration:

- Probe: EX3DV4 - SN7349; ConvF(7.52, 7.52, 7.52); Calibrated: 30.12.2014;
- Sensor-Surface: 1.4mm (Mechanical Surface Detection)
- Electronics: DAE4 Sn601; Calibrated: 17.08.2015
- Phantom: Flat Phantom 5.0 (back); Type: QD000P50AA; Serial: 1002
- DASY52 52.8.8(1222); SEMCAD X 14.6.10(7331)

**Dipole Calibration for Body Tissue/Pin=250 mW, d=10mm/Zoom Scan (7x7x7)/Cube 0:**

Measurement grid: dx=5mm, dy=5mm, dz=5mm

Reference Value = 107.6 V/m; Power Drift = 0.01 dB

Peak SAR (extrapolated) = 28.3 W/kg

**SAR(1 g) = 13.7 W/kg; SAR(10 g) = 6.12 W/kg**

Maximum value of SAR (measured) = 23.0 W/kg

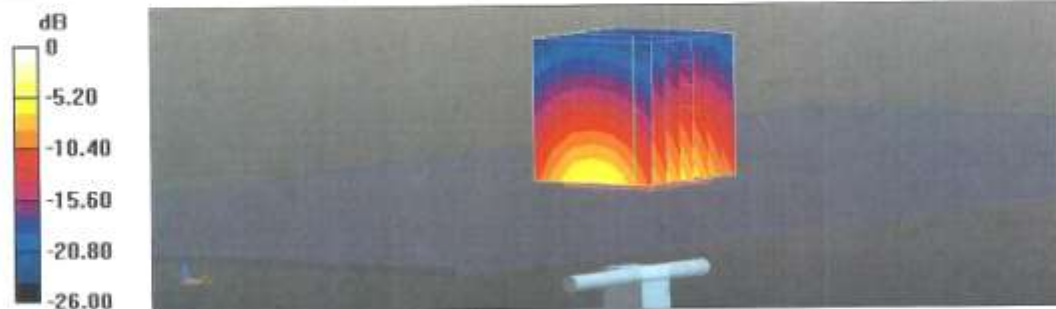

0 dB = 23.0 W/kg = 13.62 dBW/kg

## Impedance Measurement Plot for Body TSL

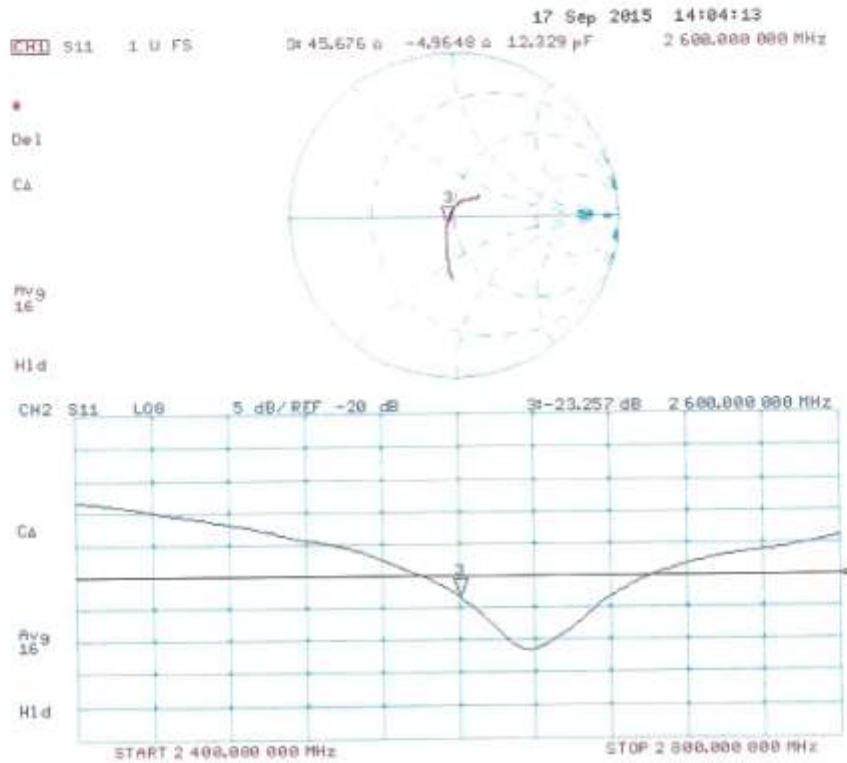

## Calibration information for DAE

**Calibration Laboratory of  
Schmid & Partner  
Engineering AG**  
Zeughausstrasse 43, 8004 Zurich, Switzerland



**S** Schweizerischer Kalibrierdienst  
**C** Service suisse d'étalonnage  
**S** Servizio svizzero di taratura  
**S** Swiss Calibration Service

Accreditation No.: SCS 0108

Accredited by the Swiss Accreditation Service (SAS)  
The Swiss Accreditation Service is one of the signatories to the EA  
Multilateral Agreement for the recognition of calibration certificates

Client **CCIS - SZ (Auden)**

Certificate No: DAE4-1373\_Jul15

CALIBRATION CERTIFICATE																							
Object	DAE4 - SD 000 D04 BM - SN: 1373																						
Calibration procedure(s)	QA CAL-06.v29 Calibration procedure for the data acquisition electronics (DAE)																						
Calibration date:	July 23, 2015																						
<p>This calibration certificate documents the traceability to national standards, which realize the physical units of measurements (SI). The measurements and the uncertainties with confidence probability are given on the following pages and are part of the certificate.</p> <p>All calibrations have been conducted in the closed laboratory facility: environment temperature (22 ± 3)°C and humidity &lt; 70%.</p> <p>Calibration Equipment used (MSTE critical for calibration)</p> <table border="1"> <thead> <tr> <th>Primary Standards</th> <th>ID #</th> <th>Cal Date (Certificate No.)</th> <th>Scheduled Calibration</th> </tr> </thead> <tbody> <tr> <td>Keithley Multimeter Type 2001</td> <td>SN: 0810278</td> <td>03-Oct-14 (No:15573)</td> <td>Oct-15</td> </tr> <tr> <th>Secondary Standards</th> <th>ID #</th> <th>Check Date (in house)</th> <th>Scheduled Check</th> </tr> <tr> <td>Auto DAE Calibration Unit</td> <td>SE UWS 053 AA 1001</td> <td>06-Jan-15 (in house check)</td> <td>In house check: Jan-15</td> </tr> <tr> <td>Calibrator Box V2.1</td> <td>SE UMS 006 AA 1002</td> <td>06-Jan-15 (in house check)</td> <td>In house check: Jan-15</td> </tr> </tbody> </table>				Primary Standards	ID #	Cal Date (Certificate No.)	Scheduled Calibration	Keithley Multimeter Type 2001	SN: 0810278	03-Oct-14 (No:15573)	Oct-15	Secondary Standards	ID #	Check Date (in house)	Scheduled Check	Auto DAE Calibration Unit	SE UWS 053 AA 1001	06-Jan-15 (in house check)	In house check: Jan-15	Calibrator Box V2.1	SE UMS 006 AA 1002	06-Jan-15 (in house check)	In house check: Jan-15
Primary Standards	ID #	Cal Date (Certificate No.)	Scheduled Calibration																				
Keithley Multimeter Type 2001	SN: 0810278	03-Oct-14 (No:15573)	Oct-15																				
Secondary Standards	ID #	Check Date (in house)	Scheduled Check																				
Auto DAE Calibration Unit	SE UWS 053 AA 1001	06-Jan-15 (in house check)	In house check: Jan-15																				
Calibrator Box V2.1	SE UMS 006 AA 1002	06-Jan-15 (in house check)	In house check: Jan-15																				
Calibrated by:	Name Eric Hainfeld	Function Technician	Signature 																				
Approved by:	Fin Bomholt	Deputy Technical Manager																					
			Issued: July 23, 2015																				
This calibration certificate shall not be reproduced except in full without written approval of the laboratory.																							

Certificate No: DAE4-1373\_Jul15

Page 1 of 5



**Calibration Laboratory of  
Schmid & Partner  
Engineering AG**  
Zeughausstrasse 43, 8004 Zurich, Switzerland



**S** Schweizerischer Kalibrierdienst  
**C** Service suisse d'étalonnage  
**S** Servizio svizzero di taratura  
**S** Swiss Calibration Service

Accreditation No.: SCS 0108

Accredited by the Swiss Accreditation Service (SAS)  
The Swiss Accreditation Service is one of the signatories to the EA  
Multilateral Agreement for the recognition of calibration certificates

### Glossary

**DAE** data acquisition electronics  
**Connector angle** information used in DASY system to align probe sensor X to the robot coordinate system.

### Methods Applied and Interpretation of Parameters

- **DC Voltage Measurement:** Calibration Factor assessed for use in DASY system by comparison with a calibrated instrument traceable to national standards. The figure given corresponds to the full scale range of the voltmeter in the respective range.
- **Connector angle:** The angle of the connector is assessed measuring the angle mechanically by a tool inserted. Uncertainty is not required.
- The following parameters as documented in the Appendix contain technical information as a result from the performance test and require no uncertainty.
  - **DC Voltage Measurement Linearity:** Verification of the Linearity at +10% and -10% of the nominal calibration voltage. Influence of offset voltage is included in this measurement.
  - **Common mode sensitivity:** Influence of a positive or negative common mode voltage on the differential measurement.
  - **Channel separation:** Influence of a voltage on the neighbor channels not subject to an input voltage.
  - **AD Converter Values with inputs shorted:** Values on the internal AD converter corresponding to zero input voltage
  - **Input Offset Measurement:** Output voltage and statistical results over a large number of zero voltage measurements.
  - **Input Offset Current:** Typical value for information; Maximum channel input offset current, not considering the input resistance.
  - **Input resistance:** Typical value for information: DAE input resistance at the connector, during internal auto-zeroing and during measurement.
  - **Low Battery Alarm Voltage:** Typical value for information. Below this voltage, a battery alarm signal is generated.
  - **Power consumption:** Typical value for information. Supply currents in various operating modes.

### DC Voltage Measurement

A/D - Converter Resolution nominal

High Range: 1LSB = 6.1 $\mu$ V, full range = -100...+300 mV

Low Range: 1LSB = 61nV, full range = -1.....+3mV

DASY measurement parameters: Auto Zero Time: 3 sec; Measuring time: 3 sec

Calibration Factors	X	Y	Z
High Range	403.849 $\pm$ 0.02% (k=2)	403.815 $\pm$ 0.02% (k=2)	404.110 $\pm$ 0.02% (k=2)
Low Range	3.98677 $\pm$ 1.50% (k=2)	4.00715 $\pm$ 1.50% (k=2)	4.01207 $\pm$ 1.50% (k=2)

### Connector Angle

Connector Angle to be used in DASY system	255.0 $^{\circ}$ $\pm$ 1 $^{\circ}$
-------------------------------------------	-------------------------------------

**Appendix (Additional assessments outside the scope of SCS0108)**

**1. DC Voltage Linearity**

High Range	Reading ( $\mu\text{V}$ )	Difference ( $\mu\text{V}$ )	Error (%)
Channel X + Input	200037.34	-0.23	-0.00
Channel X + Input	20006.84	2.50	0.01
Channel X - Input	-20004.98	1.13	-0.01
Channel Y + Input	200036.87	-0.29	-0.00
Channel Y + Input	20002.95	-1.30	-0.01
Channel Y - Input	-20006.36	-0.22	0.00
Channel Z + Input	200037.78	0.50	0.00
Channel Z + Input	20002.72	-1.49	-0.01
Channel Z - Input	-20007.18	-0.88	0.00

Low Range	Reading ( $\mu\text{V}$ )	Difference ( $\mu\text{V}$ )	Error (%)
Channel X + Input	2000.72	0.04	0.00
Channel X + Input	200.22	-0.22	-0.11
Channel X - Input	-189.54	-0.05	0.02
Channel Y + Input	2000.83	0.36	0.02
Channel Y + Input	199.37	-0.94	-0.47
Channel Y - Input	-200.64	-1.07	0.54
Channel Z + Input	2000.24	-0.16	-0.01
Channel Z + Input	198.90	-1.32	-0.66
Channel Z - Input	-201.49	-1.82	0.91

**2. Common mode sensitivity**

DASY measurement parameters: Auto Zero Time: 3 sec; Measuring time: 3 sec

	Common mode Input Voltage (mV)	High Range Average Reading ( $\mu\text{V}$ )	Low Range Average Reading ( $\mu\text{V}$ )
Channel X	200	7.57	5.57
	-200	-5.00	-6.75
	---	---	---
	-200	-11.78	-11.94
Channel Z	200	6.42	6.34
	-200	-10.15	-10.08

**3. Channel separation**

DASY measurement parameters: Auto Zero Time: 3 sec; Measuring time: 3 sec

	Input Voltage (mV)	Channel X ( $\mu\text{V}$ )	Channel Y ( $\mu\text{V}$ )	Channel Z ( $\mu\text{V}$ )
Channel X	200	-	1.51	-4.88
Channel Y	200	8.27	-	1.74
Channel Z	200	9.53	6.54	-

**4. AD-Converter Values with inputs shorted**

DASY measurement parameters: Auto Zero Time: 3 sec; Measuring time: 3 sec

	High Range (LSB)	Low Range (LSB)
Channel X	15941	15959
Channel Y	15859	15433
Channel Z	15875	15948

**5. Input Offset Measurement**

DASY measurement parameters: Auto Zero Time: 3 sec; Measuring time: 3 sec

Input 10MΩ

	Average (μV)	min. Offset (μV)	max. Offset (μV)	Std. Deviation (μV)
Channel X	1.08	0.01	2.93	0.37
Channel Y	-0.11	-0.96	0.80	0.34
Channel Z	0.97	0.15	2.47	0.49

**6. Input Offset Current**

Nominal Input circuitry offset current on all channels: <25fA

**7. Input Resistance** (Typical values for information)

	Zeroing (kOhm)	Measuring (MOhm)
Channel X	200	200
Channel Y	200	200
Channel Z	200	200

**8. Low Battery Alarm Voltage** (Typical values for information)

Typical values	Alarm Level (VDC)
Supply (+ Vcc)	+7.9
Supply (- Vcc)	-7.6

**9. Power Consumption** (Typical values for information)

Typical values	Switched off (mA)	Stand by (mA)	Transmitting (mA)
Supply (+ Vcc)	+0.01	+6	+14
Supply (- Vcc)	-0.01	-8	-9

-----End of Report-----