



**CONFORMANCE TEST REPORT
FOR
FCC 47 CFR, Part 15 Subpart C**

Report No.: 15-09-MAS-154-04

Client: **ALEXANDAVE INDUSTRIES CO., LTD.**
 Product: **Balance Gear (Dongle)**
 Model: **HC-BG-A1**
 FCC ID: **2AGEFHCBGA10B**
 Manufacturer/supplier: **Microtec Electronic Co., LTD.**

Date test item received: 2015/09/16
 Date test campaign completed: 2015/12/25
 Date of issue: 2015/12/29

The test result only corresponds to the tested sample. It is not permitted to copy this report, in part or in full, without the permission of the test laboratory.

Total number of pages of this test report: 43 pages

Total number of pages of photos: External photos 1 pages

Internal photos 2 pages

Setup photos 3 pages

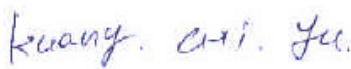
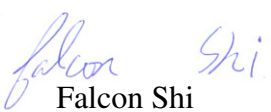
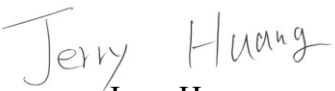
Test Engineer	Checked By	Approved By
 Kuang Chi Yu	 Falcon Shi	 Jerry Huang

ELECTRONICS TESTING CENTER, TAIWAN
 No.8, Lane 29, Wenming Rd. Guishan Dist.
 Taoyuan City 33383, Taiwan, R.O.C.

TEL: (03) 3276170~4
 INT: +886-3-3276170~4
 FAX: (03) 3276188
 INT: +886-3-3276188



Client : ALEXANDAVE INDUSTRIES CO., LTD.
Address : 9F-1, No. 203, Gongyuan Road Linkou District 24453, New Taipei City, Taiwan
Manufacturer : Microtec Electronic Co., LTD.
Address : No.53, Ln. 6, Sec. 4, Changping Rd., Daya Dist., Taichung City 428, Taiwan (R.O.C.)
EUT : Balance Gear (Dongle)
Trade name : ALDA
Model No. : HC-BG-A1
Power Source : 5V DC
Regulations applied : FCC 47 CFR, Part 15 Subpart C

The testing described in this report has been carried out to the best of our knowledge and ability, and our responsibility is limited to the exercise of reasonable care. This certification is not intended to believe the sellers from their legal and/or contractual obligations.

The compliance test is only certified for the test equipment and the results of the testing report relate only to the item tested. The compliance test of this report was conducted in accordance with the appropriate standards. It's not intention to assure the quality and performance of the product. This report shall not be reproduced except in full, without the approval of ETC. This report must not be used by the client to claim product endorsement by NVLAP or any agency of the U.S. Government.

Laboratory Introduction: Electronics Testing Center, Taiwan is recognized, filed and mutual recognition arrangement as following:

- ① ISO9001: TÜV Product Service
- ② ISO/IEC 17025: BSMI, TAF, NCC, NVLAP, ILAC MRA, UL, Compliance
- ③ Filing: FCC, Industry Canada, VCCI
- ④ MRA: Australia, Hong Kong, New Zealand, Singapore, USA, Japan, Korea, China, APLAC through TAF
- ⑤ FCC Registration Number: 91095, 392735, 278818
- ⑥ Industry Canada Site Registration Number: IC 2949A-2



NVLAP Lab Code 200133-0

Table of Contents

Page

1. GENERAL INFORMATION	4
1.1 PRODUCT DESCRIPTION.....	4
1.2 CHARACTERISTICS OF DEVICE:.....	4
1.3 TEST METHODOLOGY.....	錯誤! 尚未定義書籤。
1.4 TEST FACILITY	錯誤! 尚未定義書籤。
2. DEFINITION AND LIMITS.....	5
2.1 DEFINITION.....	5
2.2 RESTRICTED BANDS OF OPERATION	5
2.3 LIMITATION	5
2.4 LABELING REQUIREMENT.....	7
2.5 USER INFORMATION	7
3. RADIATED EMISSION MEASUREMENT.....	8
3.1 APPLICABLE STANDARD	8
3.2 MEASUREMENT PROCEDURE.....	8
3.3 TEST DATA.....	10
3.4 FIELD STRENGTH CALCULATION	37
3.5 RADIATED TEST EQUIPMENT	37
3.6 MEASURING INSTRUMENT SETUP.....	38
4. CONDUCTED EMISSION MEASUREMENT	39
4.1 STANDARD APPLICABLE	39
4.2 MEASUREMENT PROCEDURE.....	39
4.3 CONDUCTED EMISSION DATA.....	40
4.4 RESULT DATA CALCULATION	42
4.5 CONDUCTED MEASUREMENT EQUIPMENT.....	42
5. EQUIPMENTS LIST FOR TESTING.....	43

1. GENERAL INFORMATION

1.1 Product Description

- a) Type of EUT : Balance Gear (Dongle)
 b) Model No. : HC-BG-A1
 c) FCC ID. : 2AGEFHCBGA10B
 d) Working Frequency : 2402 MHz ~ 2479 MHz

1.2 Characteristics of Device:

ALDA Balance Gear is revolutionary wearable device that makes "Human Balance" measurement and training easy and available outside clinic environment. Being connected to any PC/NB, the light-weighted ALDA Balance Gear enables senior people or stroked people to regain their personal balance control by wearing it on the back of their body. The report collected from the customized training program provides info to all clinic or academic institute how an unbalanced people behaves himself to regain Balance.

Channel	Frequency	Channel	Frequency	Channel	Frequency	Channel	Frequency	Channel	Frequency	Channel	Frequency	Channel	Frequency	Channel	Frequency	Channel	Frequency
1	2402	2	2403	3	2404	4	2405	5	2406	6	2407	7	2408	8	2409	9	2410
10	2411	11	2412	12	2413	13	2414	14	2415	15	2416	16	2417	17	2418	18	2419
19	2420	20	2421	21	2422	22	2423	23	2424	24	2425	25	2426	26	2427	27	2428
28	2429	29	2430	30	2431	31	2432	32	2433	33	2434	34	2435	35	2436	36	2437
37	2438	38	2439	39	2440	40	2441	41	2442	42	2443	43	2444	44	2445	45	2446
46	2447	47	2448	48	2449	49	2450	50	2451	51	2452	52	2453	53	2454	54	2455
55	2456	56	2457	57	2458	58	2459	59	2460	60	2461	61	2462	62	2463	63	2464
64	2465	65	2466	66	2467	67	2468	68	2469	69	2470	70	2471	71	2472	72	2473
73	2474	74	2475	75	2476	76	2477	77	2478	78	2479						

1.3 Test Methodology

Radiated testing were performed according to the procedures in chapter 6 of ANSI C63.10 (2013)

The device under test was operated continuously in its normal operating mode for the purpose of the measurements. In order to secure the continuous operation of the device under test, rewiring in the circuit was done by the manufacturer so as to affect its intended operation.

The receiving antenna was varied from 1 to 4 meters and the wooden turntable was rotated through 360 degrees to obtain the highest reading on the field strength meter or on the display of the spectrum analyzer. And also, each emission was to be maximized by changing the orientation of the device under test. The hand-held or body-worn devices rotated through three orthogonal axes to determine which attitude and configuration produces the highest emission relatives to the limit.

1.4 Test Facility

The anechoic chamber and conducted measurement facility used to collect the radiated and conducted data are located inside the Building at No.8, Lane 29, Wen-ming Road, Lo-shan Tsun, Kweishan Hsiang, Taoyuan, Taiwan, R.O.C.

This site has been accreditation as a FCC filing site.

2. DEFINITION AND LIMITS

2.1 Definition

Intentional radiator:

A device that intentionally generates and emits radio frequency energy by radiation or induction.

2.2 Restricted Bands of Operation

Only spurious emissions are permitted in any of the frequency bands listed below:

MHz	MHz	MHz	GHz
0.090 - 0.110	16.42-16.423	399.9-410	4.5-5.25
0.495 - 0.505 **	16.69475 - 16.69525	608-614	5.35-5.46
2.1735 - 2.1905	16.80425 - 16.80475	960-1240	7.25-7.75
4.125-4.128	25.5-25.67	1300-1427	8.025-8.5
4.17725-4.17775	37.5-38.25	1435-1626.5	9.0-9.2
4.20725-4.20775	73-74.6	1645.5-1646.5	9.3-9.5
6.215-6.218	74.8-75.2	1660-1710	10.6-12.7
6.26775-6.26825	108-121.94	1718.8-1722.2	13.25-13.4
6.31175-6.31225	123-138	2200-2300	14.47-14.5
8.291-8.294	149.9-150.05	2310-2390	15.35-16.2
8.362-8.366	156.52475 - 156.52525	2483.5-2500	17.7-21.4
8.37625-8.38675	156.7-156.9	2655-2900	22.01-23.12
8.41425-8.41475	162.0125-167.17	3260-3267	23.6-24.0
12.29-12.293	167.72-173.2	3332-3339	31.2-31.8
12.51975-12.52025	240-285	3345.8-3358	36.43-36.5
12.57675-12.57725	322-335.4	3600-4400	Above 38.6
13.36-13.41			

Remark “***”: Until February 1, 1999, this restricted band shall be 0.490-0.510 MHz

2.3 Limitation

(1) Conducted Emission Limits:

For an intentional radiator, which is designed to be connected to the public utility (AC) power line, the conducted limit is the following:

Frequency MHz	Quasi Peak dB μ V	Average dB μ V
0.15 - 0.5	66-56*	56-46*
0.5 - 5.0	56	46
5.0 - 30.0	60	50

*Decreases with the logarithm of the frequency.

(2) Radiated Emission Limits:

According to 15.249, the field strength of emissions from intentional radiators operated under this section shall not exceed the following:

Frequency Band (MHz)	Field strength of Fundamental (mV/m)	Field strength of Harmonics (uV/m)
902 – 928	50	500
2400 – 2483.5	50	500
5725 – 5875	50	500
24.0 – 24.25 GHz	250	2500

Field strength limits are at the distance of 3 meters, emissions radiated outside of the specified bands, except for harmonics, shall be attenuated by at least 50 dB below the level of the fundamental or to the general radiated limits in 15.209, as following table(whichever is the lesser attenuation):

Other Frequencies (MHz)	Field Strength of Fundamental	
	$\mu\text{V}/\text{meter}$	$\text{dB}\mu\text{V}/\text{meter}$
30 - 88	100	40.0
88 - 216	150	43.5
216 - 960	200	46.0
Above 960	500	54.0

As shown in 15.35(b), for frequencies above 1000MHz, the field strength limits are based on average detector, however, the peak field strength of any emission shall not exceed the maximum permitted average limits, specified above by more than 20 dB under any condition of modulation.

2.4 Labeling Requirement

The device shall bear the following statement in a conspicuous location on the device:

This device complies with part 15 of the FCC Rules. Operation is subject to the following two conditions: (1) This device may not cause harmful interference, and (2) this device must accept any interference received, including interference that may cause undesired operation.

2.5 User Information

The users manual or instruction manual for an intentional or unintentional radiator shall caution the user that changes or modifications not expressly approved by the party responsible for compliance could void the user's authority to operate the equipment.

To comply with the FCC RF exposure compliance requirement, this device and its antenna must not be co-located or operating to conjunction with any other antenna or transmitter.

3. RADIATED EMISSION MEASUREMENT

3.1 Applicable Standard

For periodic operation intentional radiator, the radiated emission shall comply with § 15.249 and 15.209.

3.2 Measurement Procedure

1. Setup the configuration per figure 1 and 2 for frequencies measured below and above 1 GHz respectively. Turn on EUT and make sure that it is in normal function.
2. For emission frequencies measured below 1 GHz, a pre-scan is performed in a semi-anechoic chamber to determine the accurate frequencies of higher emissions and then each selected frequency is precisely measured. As the same purpose, for emission measured above 1 GHz, a pre-scan also be performed with a 1 meter measuring distance before final test.
3. For emission measured below and above 1 GHz, set the spectrum analyzer on a 120 kHz and 1 MHz resolution bandwidth respectively for each frequency measured in step 2.
4. The search antenna is to be raised and lowered over a range from 1 to 4 meters in horizontally polarized orientation. Position the highness when the highest value is indicated on spectrum analyzer, then change the orientation of EUT on test table over a range from 0 ° to 360 ° with a speed as slow as possible, and keep the azimuth that highest emission is indicated on the spectrum analyzer. Vary the antenna position again and record the highest value as a final reading. A RF test receiver is also used to confirm emissions measured.
5. Repeat step 4 until all frequencies that need to be measured were complete.
6. Repeat step 5 with search antenna in vertical polarized orientations.
7. Check the frequencies of highest emission with varying the placement of cables (if any) associated with EUT to obtain the worse case and record the result.

Figure 1: Frequencies measured below 1 GHz configuration

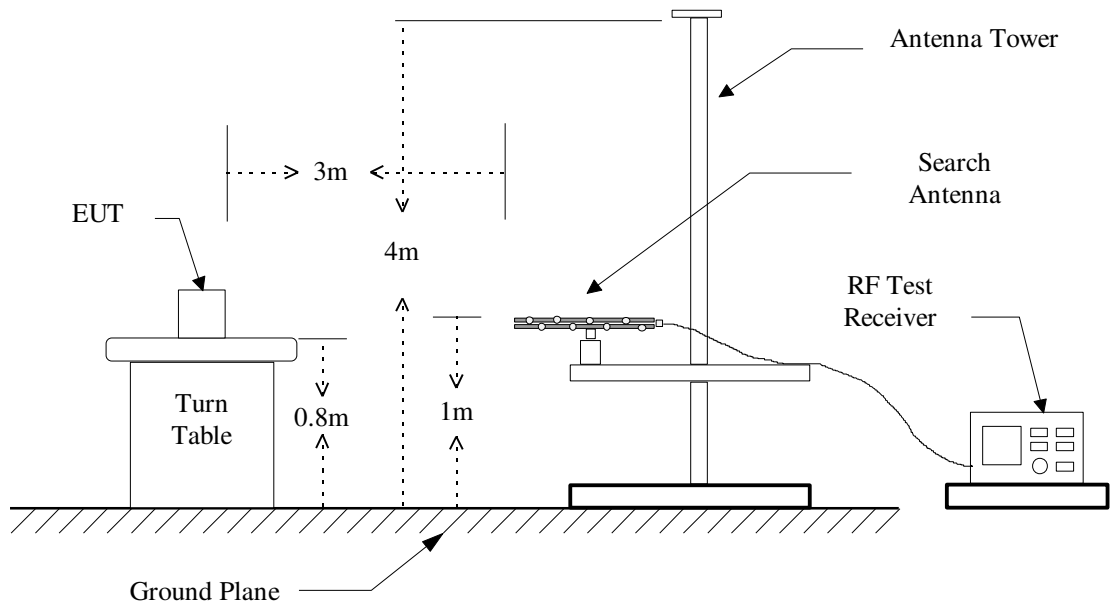
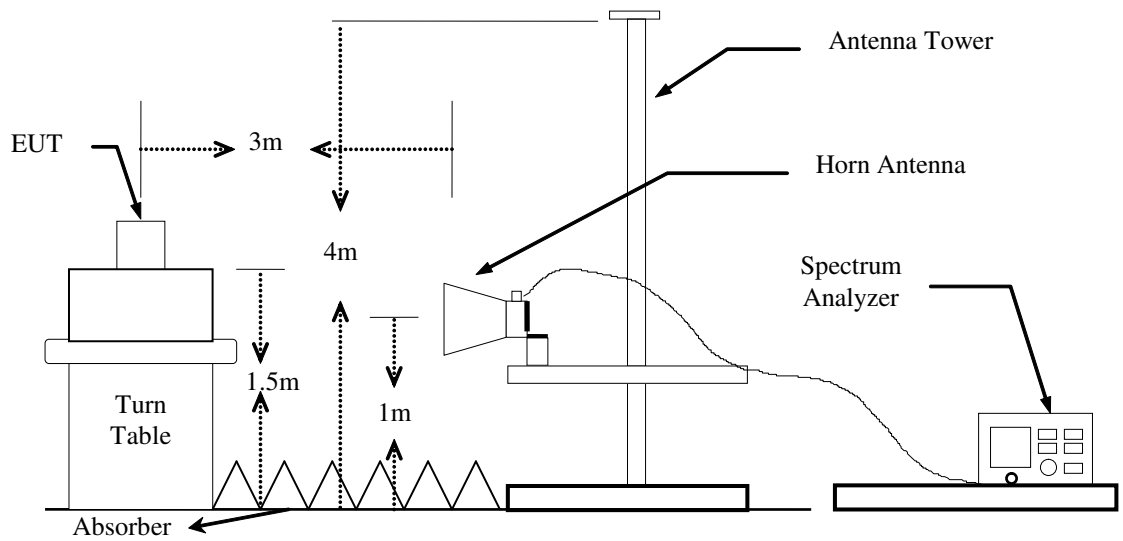

Figure 2: Frequencies measured above 1 GHz configuration



3.3 Test Data

3.3.1 Fundamental and Harmonic Emissions

3.3.1.1 Operated mode: Transmitting (CH Low)

Test Date : Dec. 14, 2015

Temperature : 24°C

Humidity : 58%

Frequency (MHz)	Ant Pol H/V	Reading (dBuV/m) @3m		Correct Factor (dB)	Result (dBuV/m) @3m		Limit (dBuV/m) @3m		Margin (worse) (dB)
		Peak	AVG		Peak	AVG	Peak	AVG	
Fundamental									
2402.0000	H	60.4	---	31.07	91.5	---	114.0	94.0	-2.5
2402.0000	V	65.3	49.7	31.07	96.4	80.8	114.0	94.0	-13.2
Harmonic									
4804.0000	H	49.5	---	-0.29	49.2	---	74.0	54.0	-4.8
4804.0000	V	50.8	---	-0.29	50.5	---	74.0	54.0	-3.5
7206.0000	H	---	---	3.13	---	---	74.0	54.0	---
7206.0000	V	---	---	3.13	---	---	74.0	54.0	---
9608.0000	H	---	---	5.32	---	---	74.0	54.0	---
9608.0000	V	---	---	5.32	---	---	74.0	54.0	---
12010.0000	H	---	---	8.28	---	---	74.0	54.0	---
12010.0000	V	---	---	8.28	---	---	74.0	54.0	---
14412.0000	H	---	---	13.15	---	---	74.0	54.0	---
14412.0000	V	---	---	13.15	---	---	74.0	54.0	---
16814.0000	H	---	---	10.56	---	---	74.0	54.0	---
16814.0000	V	---	---	10.56	---	---	74.0	54.0	---
19216.0000	H	---	---	24.60	---	---	74.0	54.0	---
19216.0000	V	---	---	24.60	---	---	74.0	54.0	---
21618.0000	H	---	---	26.20	---	---	74.0	54.0	---
21618.0000	V	---	---	26.20	---	---	74.0	54.0	---
24020.0000	H	---	---	25.06	---	---	74.0	54.0	---
24020.0000	V	---	---	25.06	---	---	74.0	54.0	---

Note:

1. *Peak Result = Peak Reading + Correct Factor*
2. *AVG Result = Peak Result + Duty Factor*
3. *If the result of peak value is under the limit of average, the average value doesn't need to be measured.*
4. *"*" means the frequency is in the Restricted Bands.*

3.3.1.2 Operated mode : Transmitting (CH Mid)Test Date : Dec. 14, 2015Temperature : 24°CHumidity : 58%

Frequency (MHz)	Ant Pol H/V	Reading (dBuV/m) @3m		Correct Factor (dB)	Result (dBuV/m) @3m		Limit (dBuV/m) @3m		Margin (worse) (dB)
		Peak	AVG		Peak	AVG	Peak	AVG	
Fundamental									
2440.0000	H	64.3	50.3	31.19	95.5	81.5	114.0	94.0	-12.5
2440.0000	V	66.4	55.2	31.19	97.6	86.4	114.0	94.0	-7.6
Harmonic									
4882.0000	H	49.3	---	-0.11	49.2	---	74.0	54.0	-4.8
4882.0000	V	50.2	---	-0.11	50.1	---	74.0	54.0	-3.9
7323.0000	H	---	---	3.44	---	---	74.0	54.0	---
7323.0000	V	---	---	3.44	---	---	74.0	54.0	---
9764.0000	H	---	---	5.46	---	---	74.0	54.0	---
9764.0000	V	---	---	5.46	---	---	74.0	54.0	---
12205.0000	H	---	---	8.54	---	---	74.0	54.0	---
12205.0000	V	---	---	8.54	---	---	74.0	54.0	---
14646.0000	H	---	---	12.29	---	---	74.0	54.0	---
14646.0000	V	---	---	12.29	---	---	74.0	54.0	---
17087.0000	H	---	---	12.14	---	---	74.0	54.0	---
17087.0000	V	---	---	12.14	---	---	74.0	54.0	---
19528.0000	H	---	---	24.91	---	---	74.0	54.0	---
19528.0000	V	---	---	24.91	---	---	74.0	54.0	---
21969.0000	H	---	---	25.95	---	---	74.0	54.0	---
21969.0000	V	---	---	25.95	---	---	74.0	54.0	---
24410.0000	H	---	---	24.64	---	---	74.0	54.0	---
24410.0000	V	---	---	24.64	---	---	74.0	54.0	---

Note:

1. Peak Result = Peak Reading + Correct Factor
2. AVG Result = Peak Result + Duty Factor
3. If the result of peak value is under the limit of average, the average value doesn't need to be measured.
4. "*" means the frequency is in the Restricted Bands.

3.3.1.3 Operated mode : Transmitting (CH High)Test Date : Dec. 14, 2015Temperature : 24°CHumidity : 58%

Frequency (MHz)	Ant Pol H/V	Reading (dBuV/m) @3m		Correct Factor (dB)	Result (dBuV/m) @3m		Limit (dBuV/m) @3m		Margin (worse) (dB)
		Peak	AVG		Peak	AVG	Peak	AVG	
Fundamental									
2479.0000	H	61.3	---	31.31	92.6	---	114.0	94.0	-1.4
2479.0000	V	66.4	54.3	31.31	97.7	85.6	114.0	94.0	-8.4
Harmonic									
4958.0000	H	48.9	---	0.05	49.0	---	74.0	54.0	-5.0
4958.0000	V	50.7	---	0.05	50.8	---	74.0	54.0	-3.2
7437.0000	H	---	---	3.73	---	---	74.0	54.0	---
7437.0000	V	---	---	3.73	---	---	74.0	54.0	---
9916.0000	H	---	---	5.59	---	---	74.0	54.0	---
9916.0000	V	---	---	5.59	---	---	74.0	54.0	---
12395.0000	H	---	---	8.78	---	---	74.0	54.0	---
12395.0000	V	---	---	8.78	---	---	74.0	54.0	---
14874.0000	H	---	---	11.20	---	---	74.0	54.0	---
14874.0000	V	---	---	11.20	---	---	74.0	54.0	---
17353.0000	H	---	---	13.83	---	---	74.0	54.0	---
17353.0000	V	---	---	13.83	---	---	74.0	54.0	---
19832.0000	H	---	---	25.05	---	---	74.0	54.0	---
19832.0000	V	---	---	25.05	---	---	74.0	54.0	---
22311.0000	H	---	---	26.13	---	---	74.0	54.0	---
22311.0000	V	---	---	26.13	---	---	74.0	54.0	---
24790.0000	H	---	---	24.73	---	---	74.0	54.0	---
24790.0000	V	---	---	24.73	---	---	74.0	54.0	---

Note:

1. *Peak Result = Peak Reading + Correct Factor*
2. *AVG Result = Peak Result + Duty Factor*
3. *If the result of peak value is under the limit of average, the average value doesn't need to be measured.*
4. *"*" means the frequency is in the Restricted Bands.*

3.3.2 Other emissions

3.3.2.1 below 1GHz

File: Data: #4 Date: 2015/12/14 Temperature: 24 °C
 Time: AM 10:36:47 Humidity: 61 %

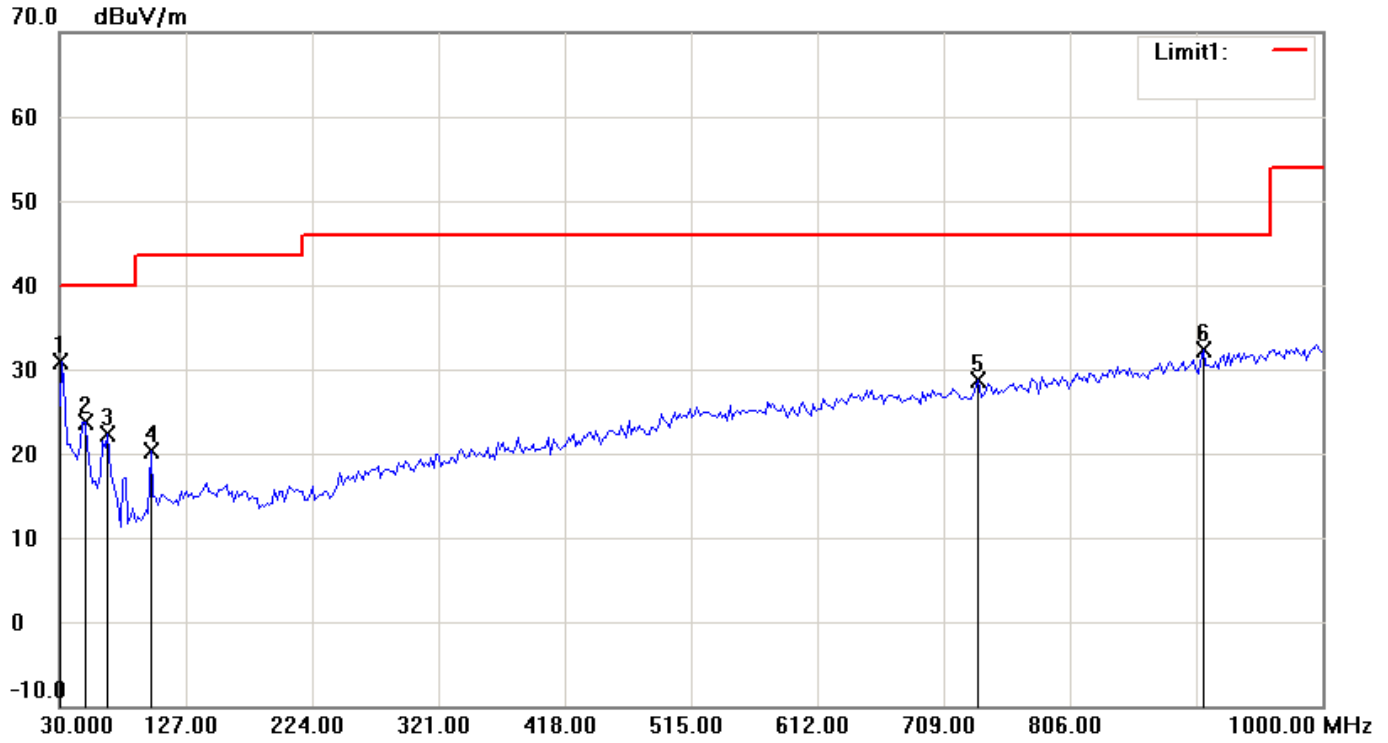

Condition: FCC_30-1000MHz Polarization: Horizontal
 EUT: Distance: 3m
 Model:
 Test Mode:
 Note:

No.	Frequency (MHz)	Reading (dBuV/m)	Detector	Corrected dB/m	Result (dBuV/m)	Limit (dBuV/m)	Margin (dB)
1	31.9438	11.43	QP	19.39	30.82	40.00	-9.18
2	49.4388	12.93	QP	10.84	23.77	40.00	-16.23
3	66.9338	15.05	QP	7.28	22.33	40.00	-17.67
4	99.9800	8.66	QP	11.69	20.35	43.50	-23.15
5	735.6313	3.07	QP	25.71	28.78	46.00	-17.22
6	908.6372	3.76	QP	28.47	32.23	46.00	-13.77

File: Data: #3 Date: 2015/12/14 Temperature: 24 °C
 Time: AM 10:35:31 Humidity: 61 %

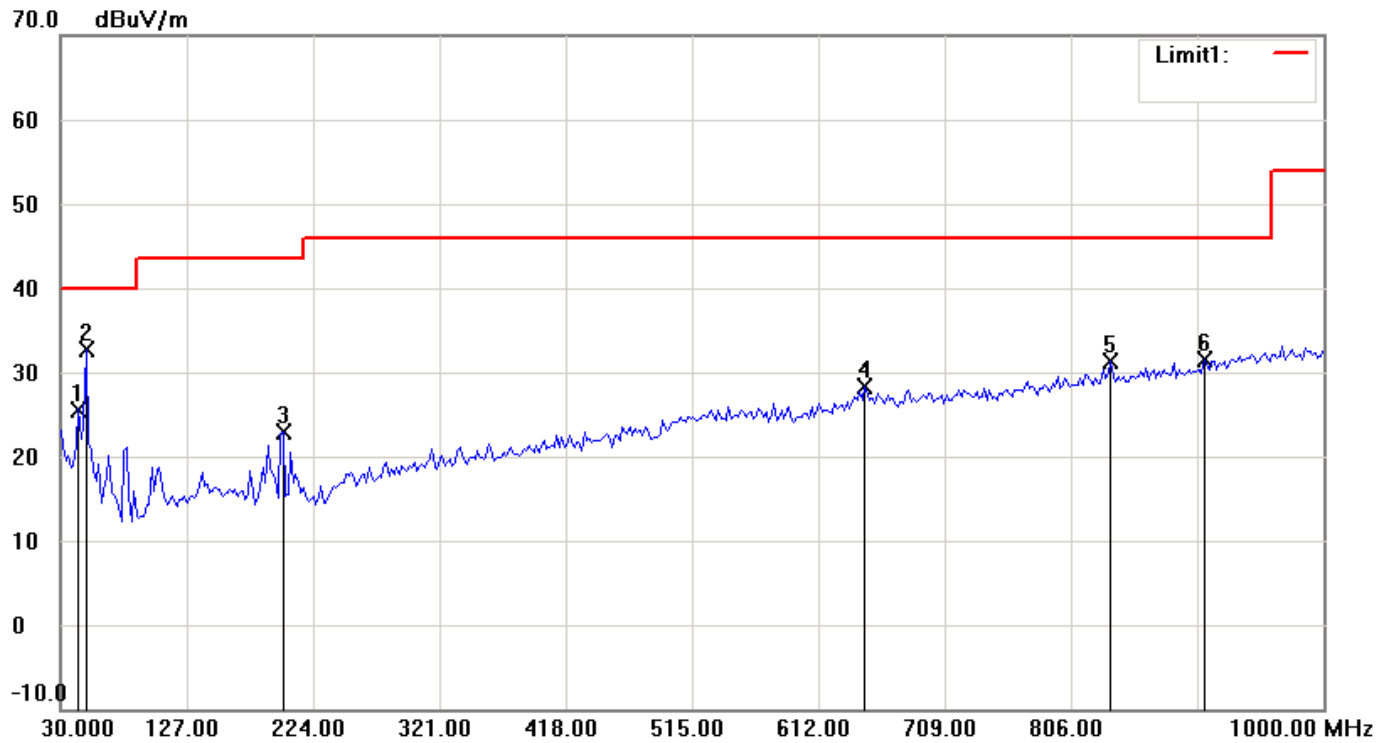

Condition: FCC_30-1000MHz Polarization: Vertical
 EUT: Distance: 3m
 Model:
 Test Mode:
 Note:

No.	Frequency (MHz)	Reading (dBuV/m)	Detector	Corrected dB/m	Result (dBuV/m)	Limit (dBuV/m)	Margin (dB)
1	43.6071	12.06	QP	13.54	25.60	40.00	-14.40
2	49.4388	21.84	QP	10.84	32.68	40.00	-7.32
3	201.0620	8.99	QP	13.92	22.91	43.50	-20.59
4	648.1562	2.98	QP	25.26	28.24	46.00	-17.76
5	836.7133	3.74	QP	27.49	31.23	46.00	-14.77
6	908.6372	3.13	QP	28.47	31.60	46.00	-14.40

3.3.2.2 above 1GHz

3.3.2.2.1 Fundamental Frequency: 2402 MHz

Frequency (MHz)	Ant Pol H/V	Reading (dBuV/m)@3m		Correct Factor (dB)	Result (dBuV/m)@3m		Limit (dBuV/m)@3m		Margin (worse) (dB)
		Peak	AVG		Peak	AVG	Peak	AVG	
1020.1923	V	52.3	---	-13.12	39.2	---	74	54	-14.8
1065.0641	V	52.3	---	-12.93	39.4	---	74	54	-14.6
1195.1920	V	58.2	---	-12.34	45.9	---	74	54	-8.1
1201.9230	H	51.4	---	-12.30	39.1	---	74	54	-14.9
1401.6023	V	57.6	---	-11.40	46.2	---	74	54	-7.8
1800.9614	H	52.5	---	-9.17	43.3	---	74	54	-10.7
1931.0896	H	52.2	---	-8.39	43.8	---	74	54	-10.2
1931.0896	H	51.0	---	-8.39	42.6	---	74	54	-11.4
2276.6026	H	51.6	---	-7.11	44.5	---	74	54	-9.5
2312.5000	H	53.3	---	-6.99	46.3	---	74	54	-7.7
2980.8236	V	50.1	---	-4.55	45.6	---	74	54	-8.4
3304.0841	H	49.0	---	-3.63	45.4	---	74	54	-8.6
4796.0551	V	51.2	---	-0.31	50.9	---	74	54	-3.1
4796.0552	H	53.0	---	-0.31	52.7	---	74	54	-1.3

3.3.2.2.2 Fundamental Frequency: 2441 MHz

Frequency (MHz)	Ant Pol H/V	Reading (dBuV/m)@3m		Correct Factor (dB)	Result (dBuV/m)@3m		Limit (dBuV/m)@3m		Margin (worse) (dB)
		Peak	AVG		Peak	AVG	Peak	AVG	
1013.4615	V	52.8	---	-13.16	39.6	---	74	54	-14.4
1058.3333	V	52.2	---	-12.95	39.3	---	74	54	-14.7
1197.4358	V	56.5	---	-12.33	44.2	---	74	54	-9.8
1399.3590	V	52.2	---	-11.41	40.8	---	74	54	-13.2
1599.0385	V	51.5	---	-10.35	41.2	---	74	54	-12.8
1796.4744	H	52.3	---	-9.19	43.1	---	74	54	-10.9
1910.8974	H	51.3	---	-8.51	42.8	---	74	54	-11.2
1962.5000	H	51.8	---	-8.19	43.6	---	74	54	-10.4
1987.1794	H	53.0	---	-8.06	44.9	---	74	54	-9.1
2000.6410	V	51.0	---	-7.98	43.0	---	74	54	-11.0
2241.9486	V	49.5	---	-7.21	42.3	---	74	54	-11.7
2757.0280	H	49.7	---	-5.41	44.3	---	74	54	-9.7
4870.6538	H	50.3	---	-0.14	50.2	---	74	54	-3.8
1013.4615	V	52.8	---	-13.16	39.6	---	74	54	-14.4

3.3.2.2.3 Fundamental Frequency: 2479 MHz

Frequency (MHz)	Ant Pol	Reading (dBuV/m)@3m		Correct Factor (dB)	Result (dBuV/m)@3m		Limit (dBuV/m)@3m		Margin (worse) (dB)
		Peak	AVG		Peak	AVG	Peak	AVG	
1197.4358	V	52.6	---	-12.33	40.3	---	74	54	-13.7
1397.1153	V	55.4	---	-11.42	44.0	---	74	54	-10.0
1599.0385	V	51.9	---	-10.35	41.6	---	74	54	-12.4
1796.4744	V	54.2	---	-9.19	45.0	---	74	54	-9.0
1800.9614	H	50.7	---	-9.17	41.5	---	74	54	-12.5
1937.8205	H	52.3	---	-8.34	44.0	---	74	54	-10.0
1987.1794	V	52.4	---	-8.06	44.3	---	74	54	-9.7
2000.6410	H	55.7	---	-7.98	47.7	---	74	54	-6.3
2153.2051	V	51.3	---	-7.50	43.8	---	74	54	-10.2
2267.6282	V	52.7	---	-7.14	45.6	---	74	54	-8.4
2732.1620	H	49.1	---	-5.50	43.6	---	74	54	-10.4

3.3.2.3 below 30MHz

Frequency (MHz)	Reading (dBuV/m) Peak	Duty (dB)	Factor (dB)	Result @3m (dBuV/m)			Limit @3m (dBuV/m)	
				Peak	QP	AVG	Peak	AVG
Radiated emission frequencies from 9 kHz to 30 MHz were too low to be measured.								

Note:

1. Place of Measurement: Measuring site of the ETC.
2. If the data table appeared symbol of "***" means the value was too low to be measured.
3. The estimated measurement uncertainty of the result measurement is
 - ±4.2dB (9kHz ≤ f ≤ 30MHz)
 - ±4.6dB (30MHz ≤ f < 300MHz).
 - ±4.4dB (300MHz ≤ f < 1000MHz).
 - ±4.1dB (1GHz ≤ f ≤ 18GHz).
 - ±4.4dB (18GHz < f ≤ 40GHz).
- 4 Remark "----" means that the emissions level is too low to be measured.
5. Please refer to page 17 to page 25 for chart

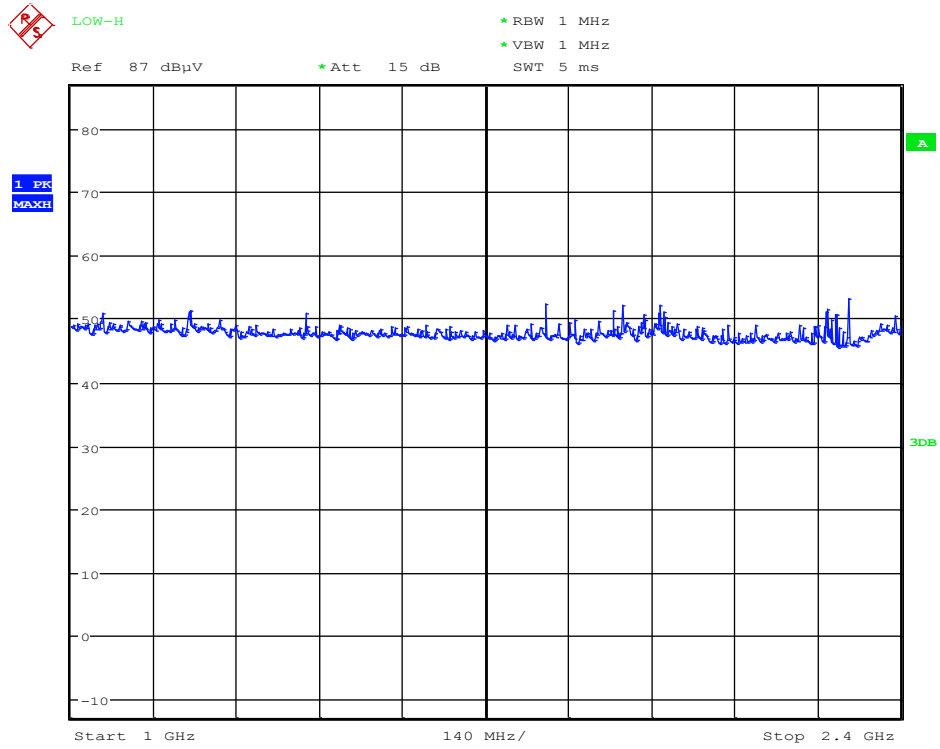

Date: 21.SEP.2015 03:03:18

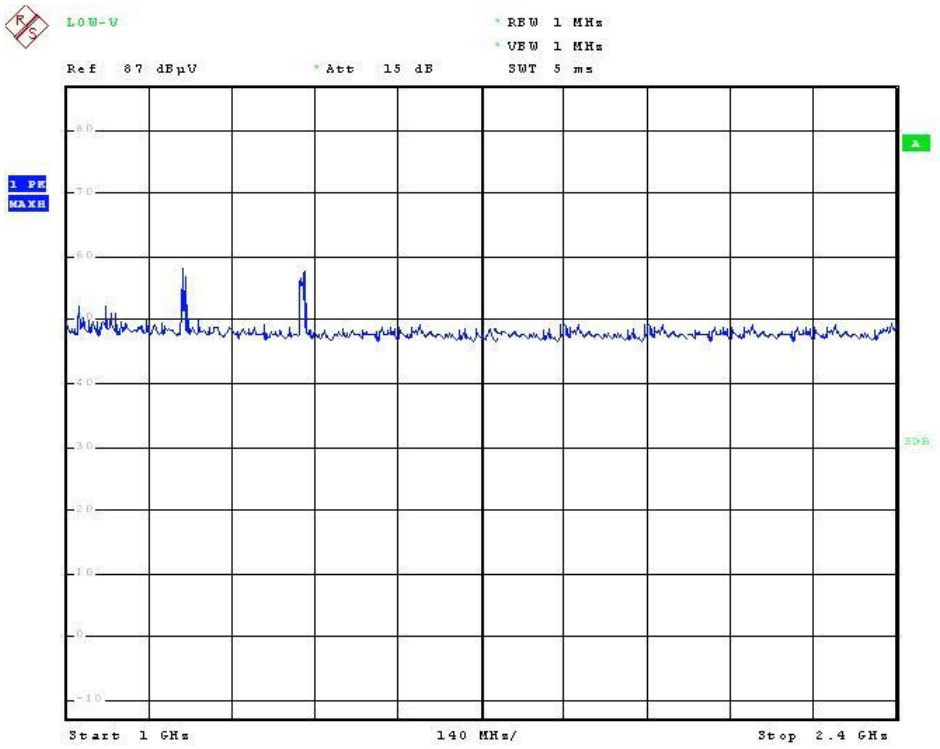

Date: 21.SEP.2015 03:06:52

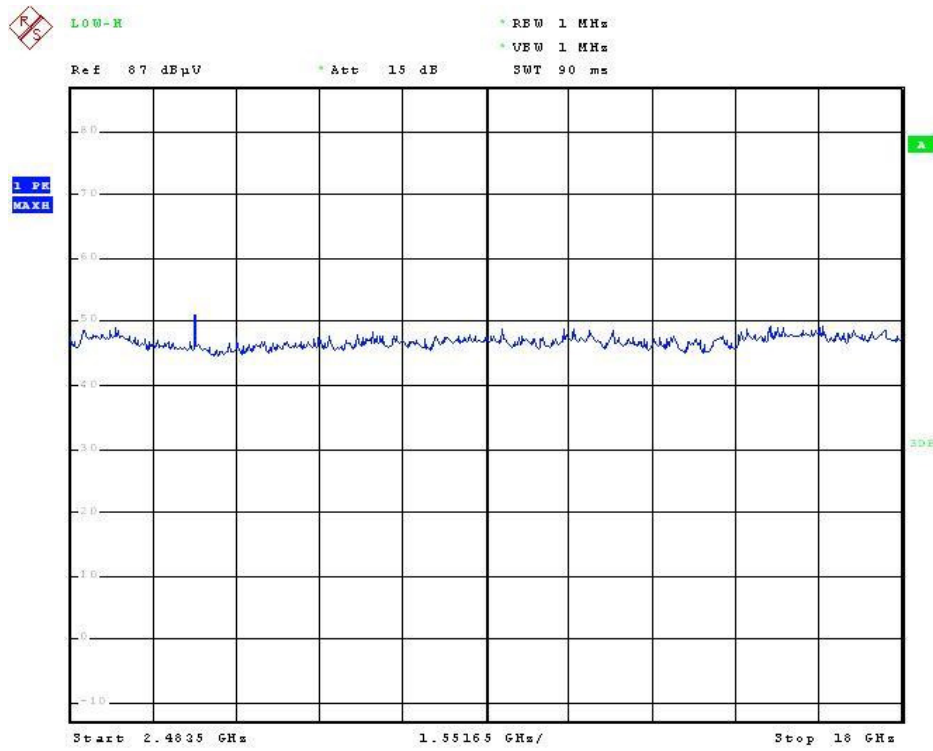

Date: 21.SEP.2015 03:04:31

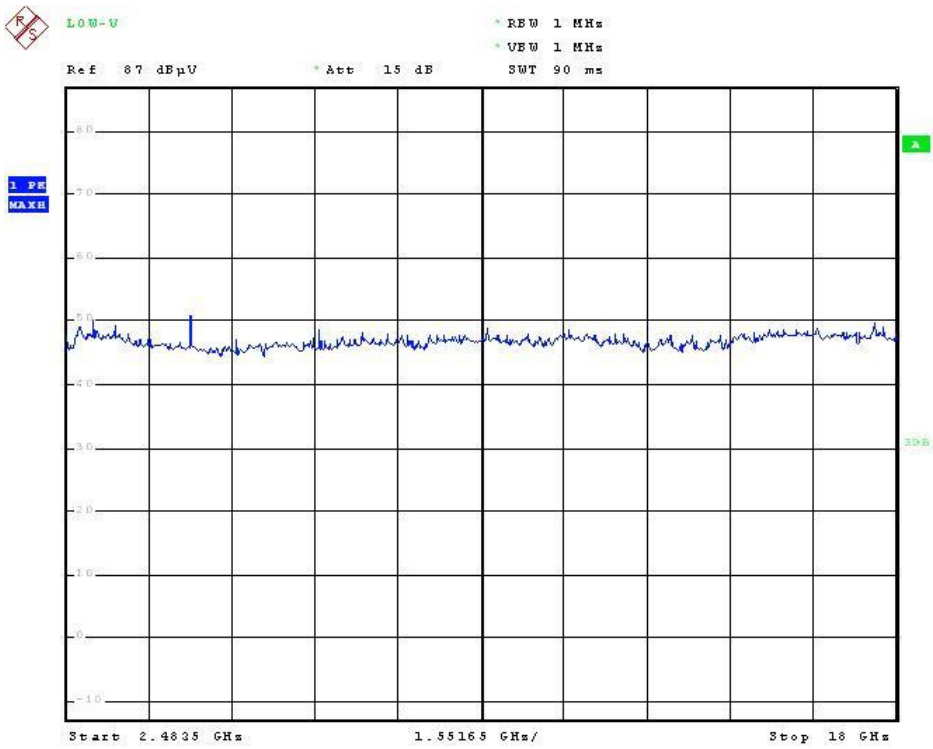

Date: 21.SEP.2015 03:08:03

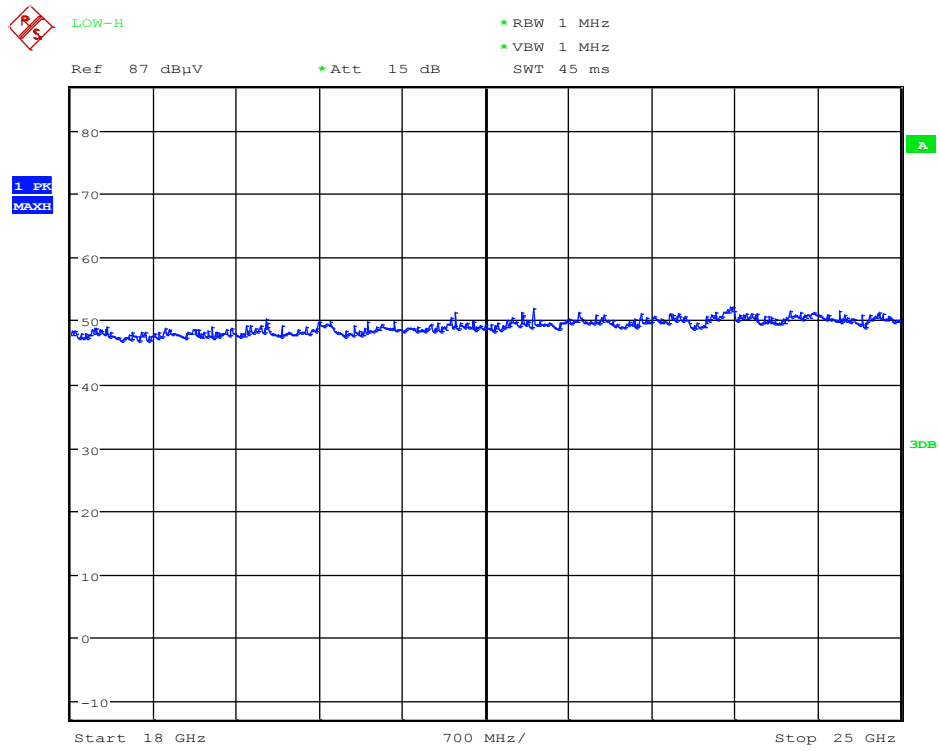

Date: 21.SEP.2015 03:05:41

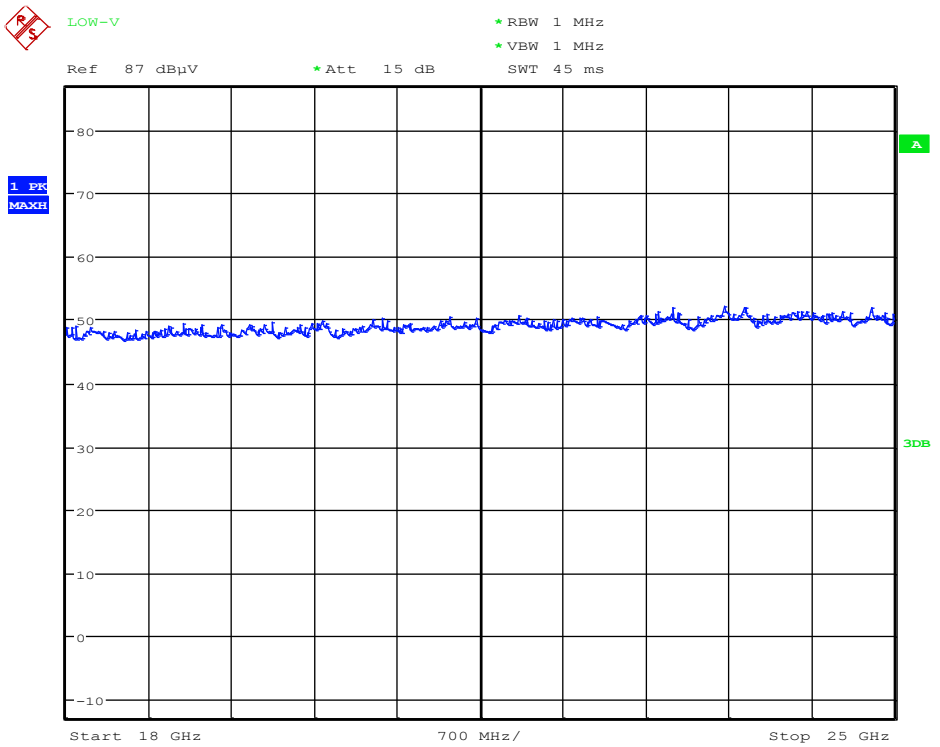

Date: 21.SEP.2015 03:09:14

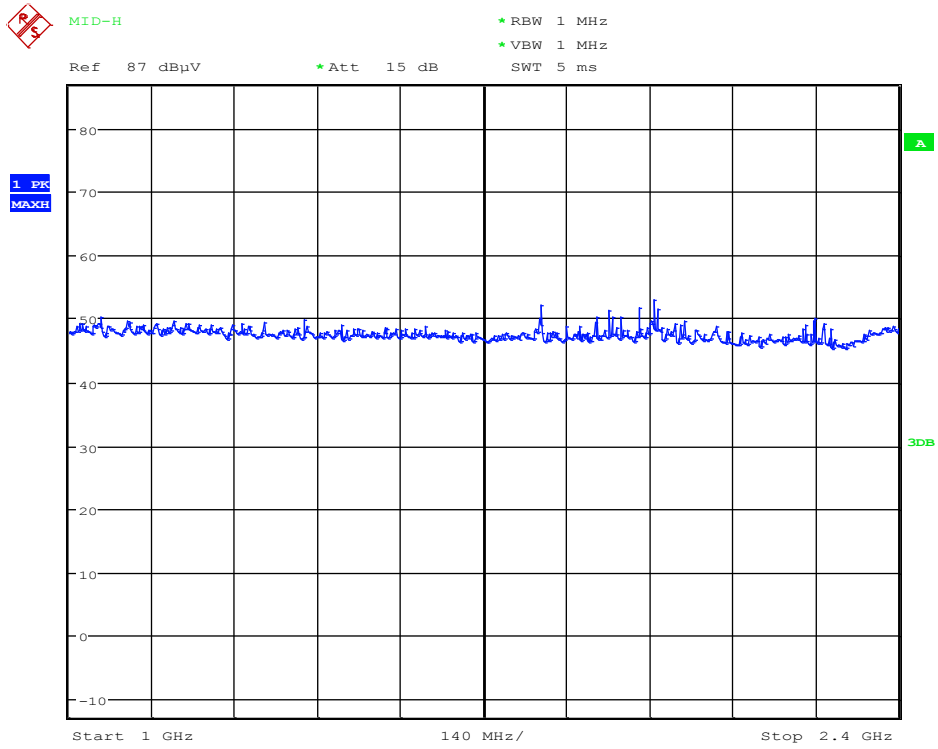

Date: 21.SEP.2015 03:25:50

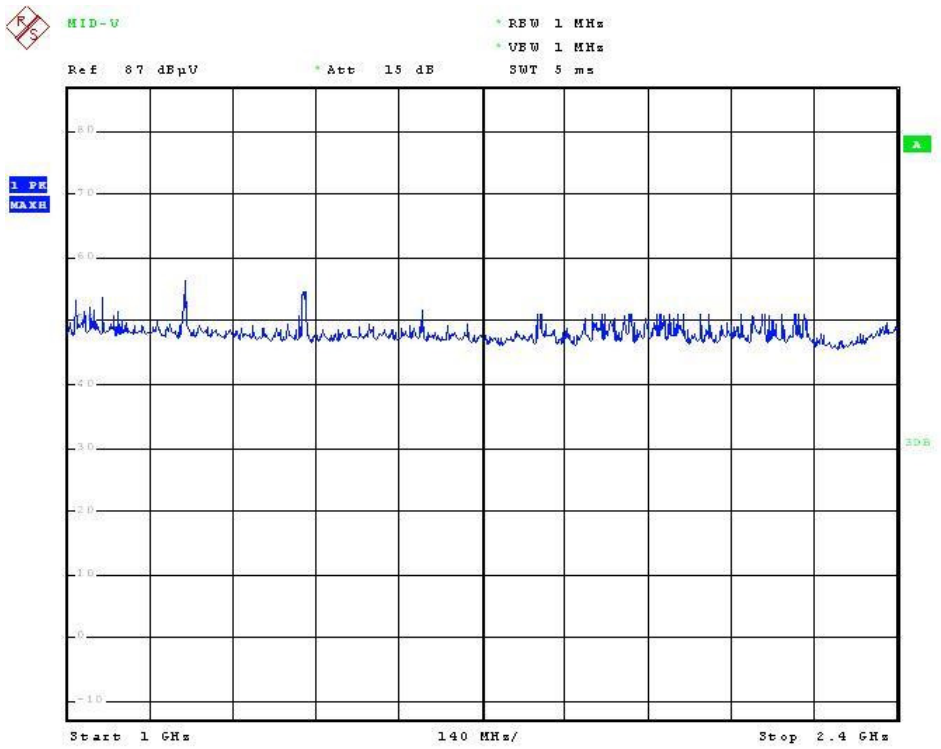

Date: 21.SEP.2015 03:29:24

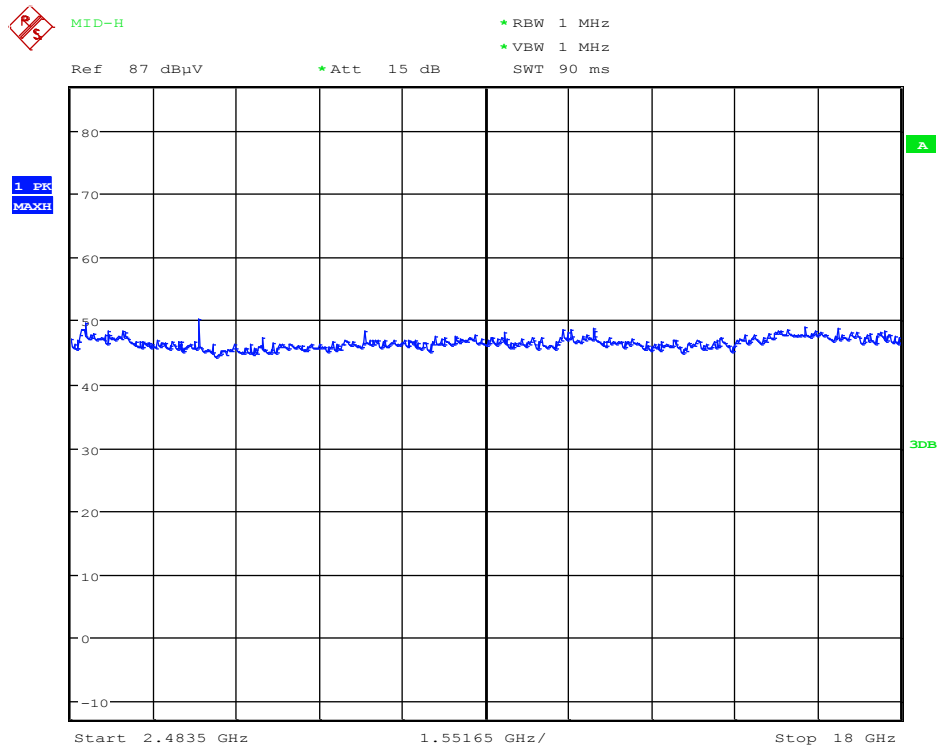

Date: 21.SEP.2015 03:27:02

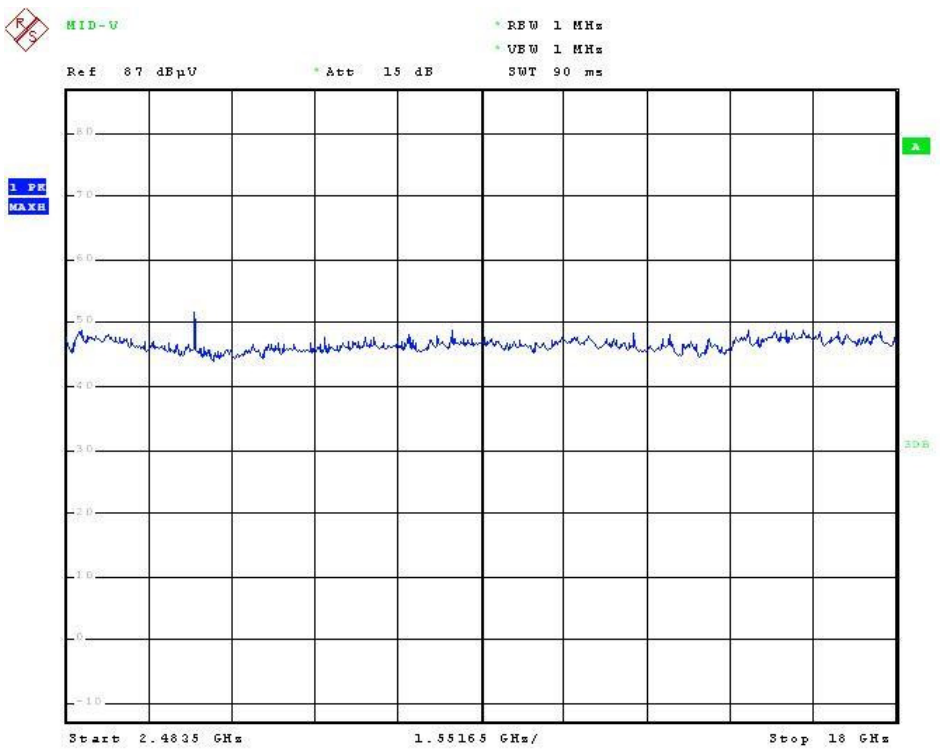

Date: 21.SEP.2015 03:30:35

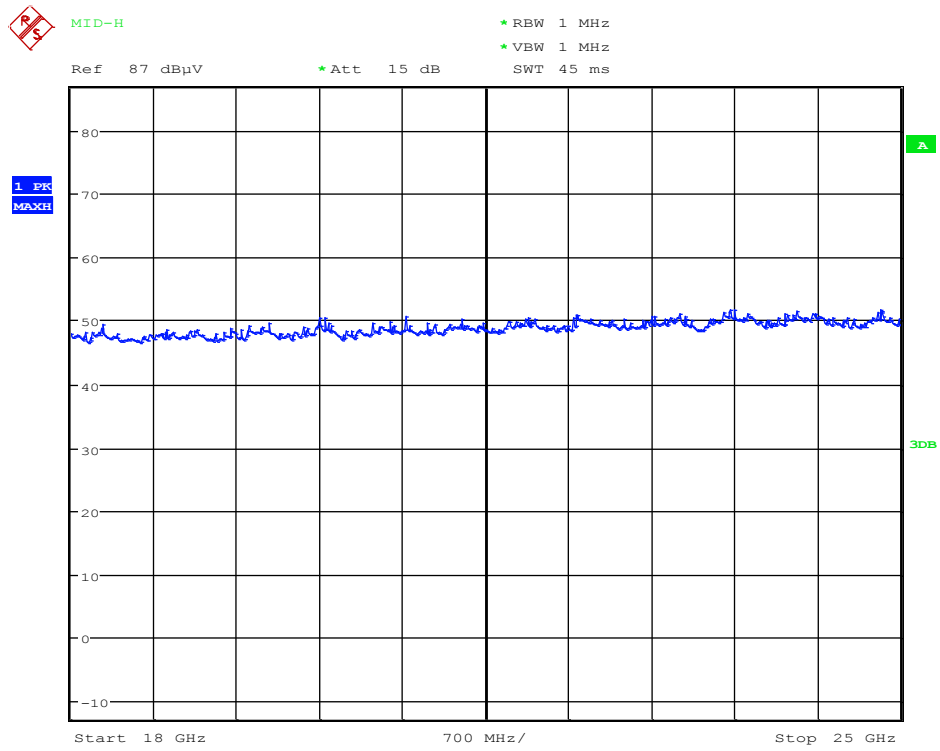

Date: 21.SEP.2015 03:28:13

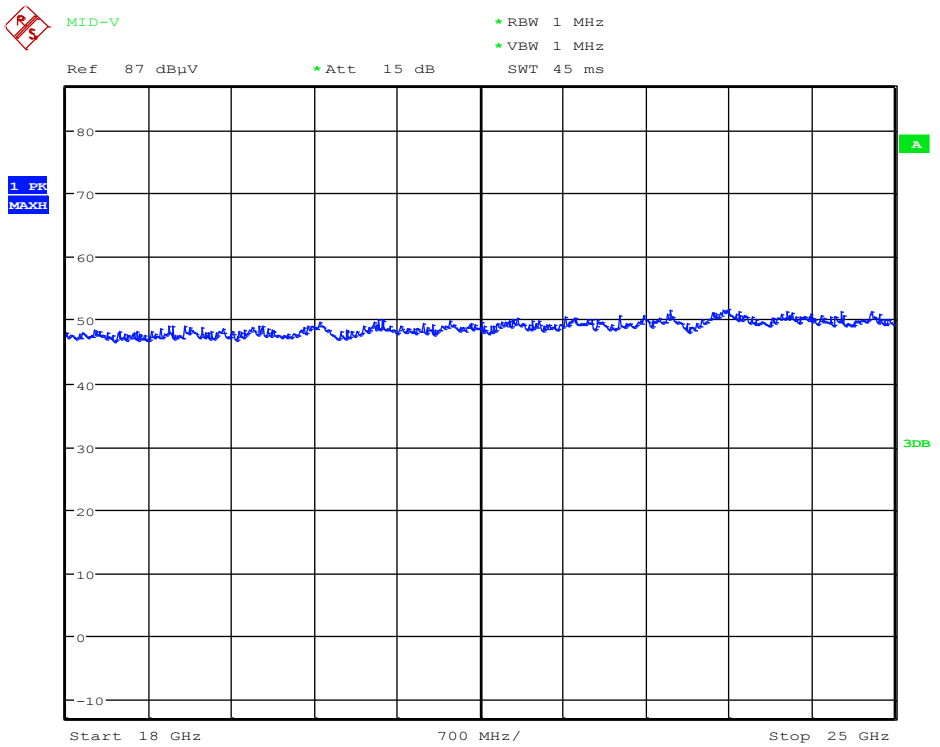

Date: 21.SEP.2015 03:31:47

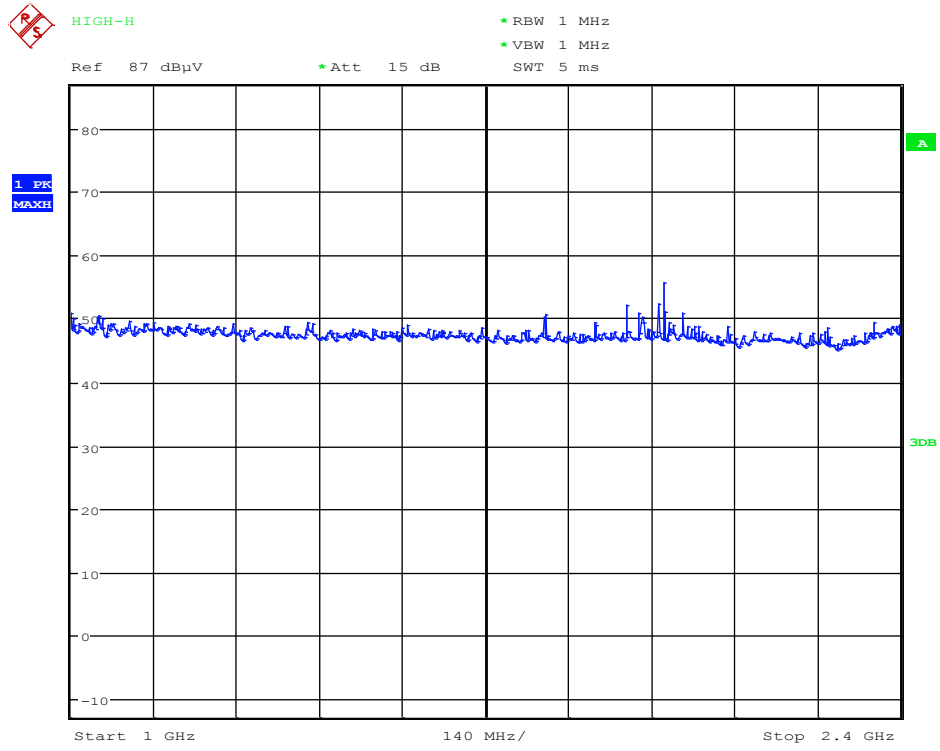

Date: 21.SEP.2015 03:47:51

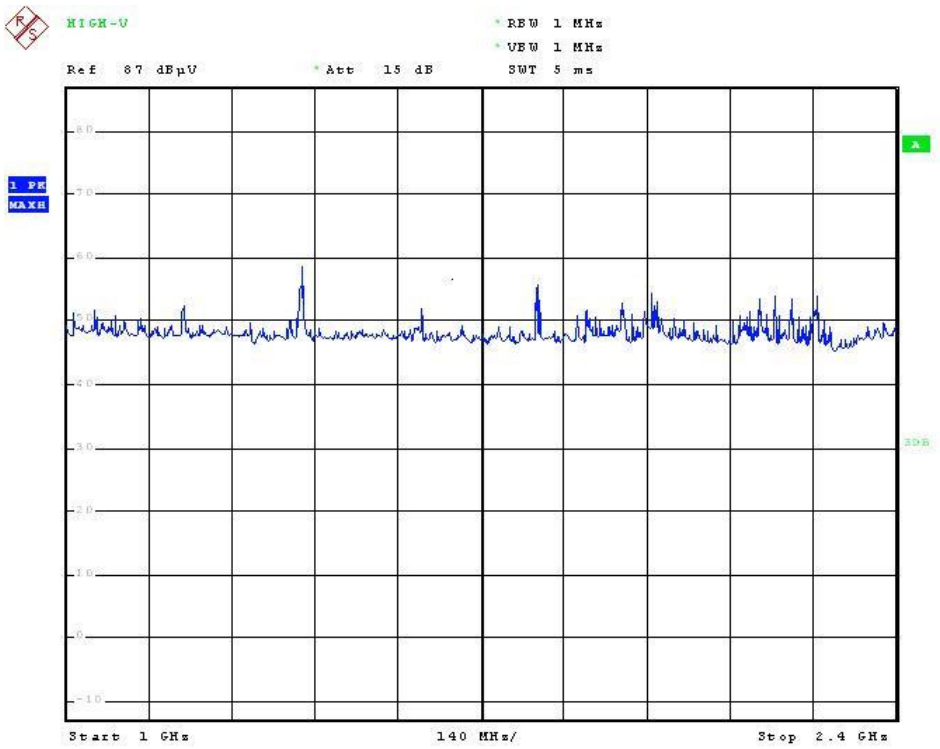

Date: 21.SEP.2015 03:51:23

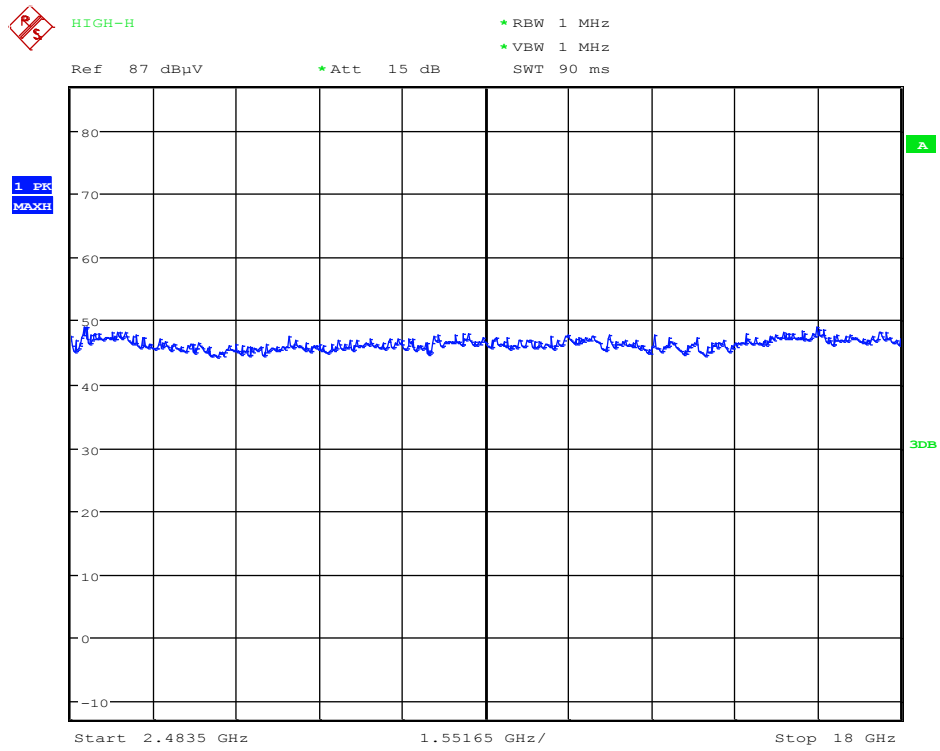

Date: 21.SEP.2015 03:49:02

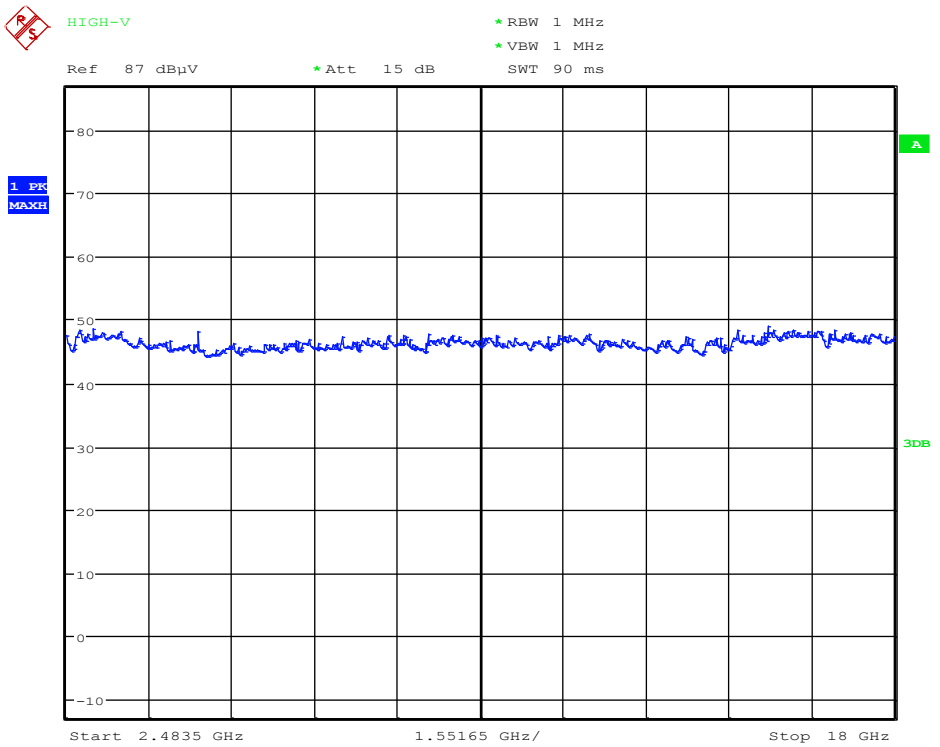

Date: 21.SEP.2015 03:52:34

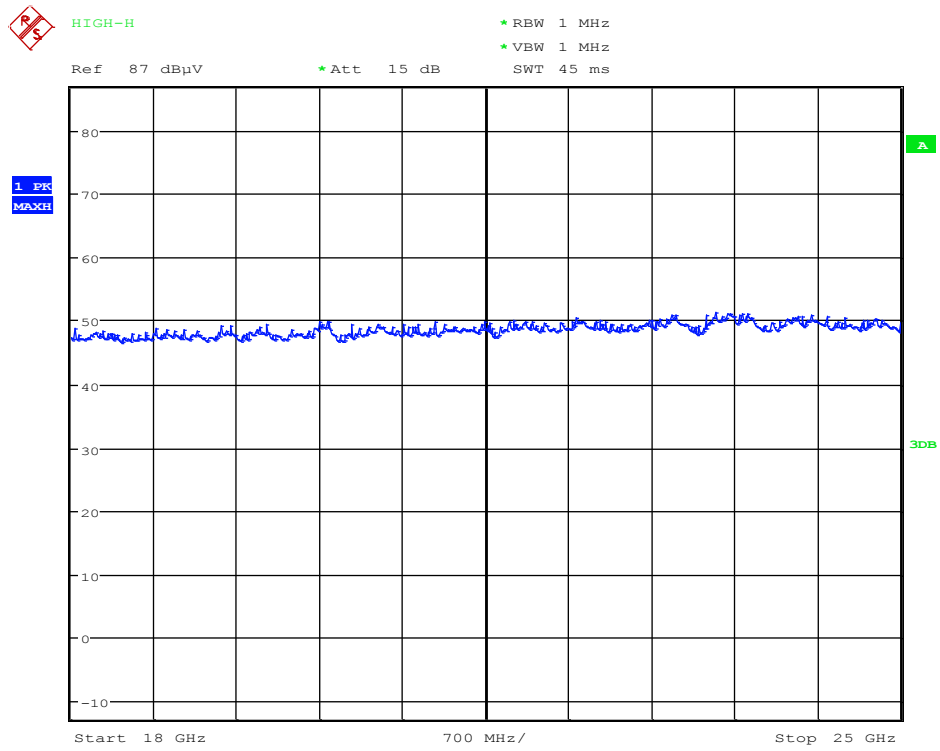

Date: 21.SEP.2015 03:50:12

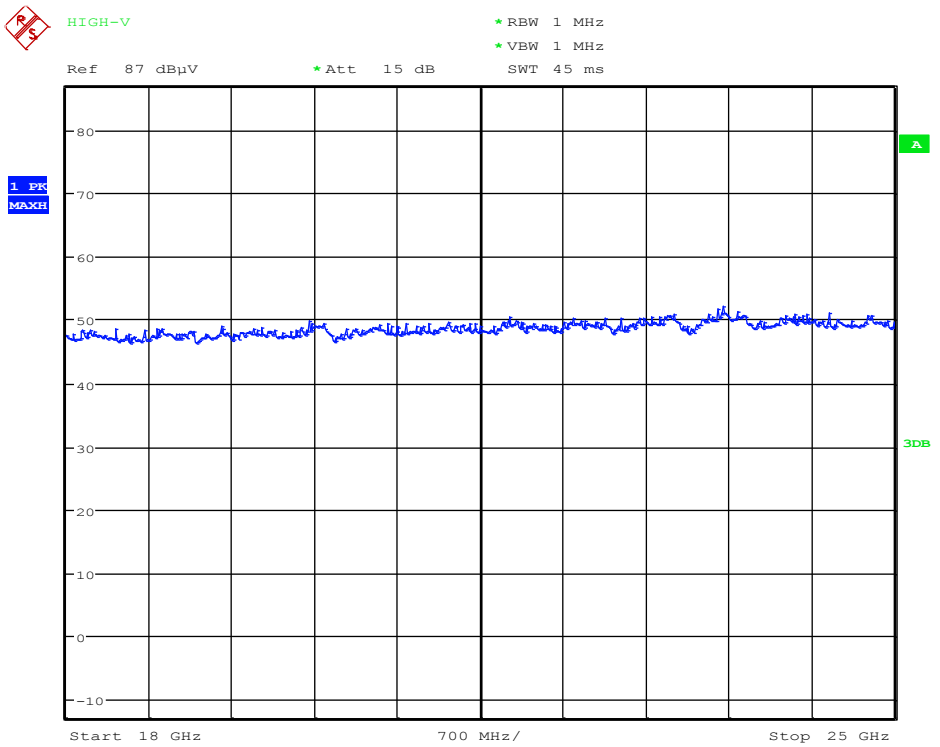

Date: 21.SEP.2015 03:53:45

3.3.2.4 Radiated Measurement at Bandedge with Fundamental FrequenciesTest Date : Dec. 18, 2015Temperature : 22°CHumidity : 65%

Channel	Frequency	Reading @3m (dBuV/m)				Factor	Result		Limit @3m		Margin (worse)	
		H		V			(dBuV/m)		(dBuV/m)		(dB)	
	(MHz)	Peak	Ave	Peak	Ave	(dB)	Peak	Ave	Peak	Ave	Peak	Ave
CH Low	2400.0	35.1	21.0	42.4	22.2	27.1	69.5	49.3	74	54	-4.5	-4.7
CH High	2483.5	32.7	14.2	26.6	14.4	27.3	60.0	41.7	74	54	-14	-12.3

Note: 1. The result is the highest value of radiated emission from restrict band of 2310~2500 MHz.
2. Please refer to page 27 to page 34 for chart.

File:	Data: #2	Date: 2015/12/18	Temperature: 22 °C
		Time: PM 02:24:15	Humidity: 65 %

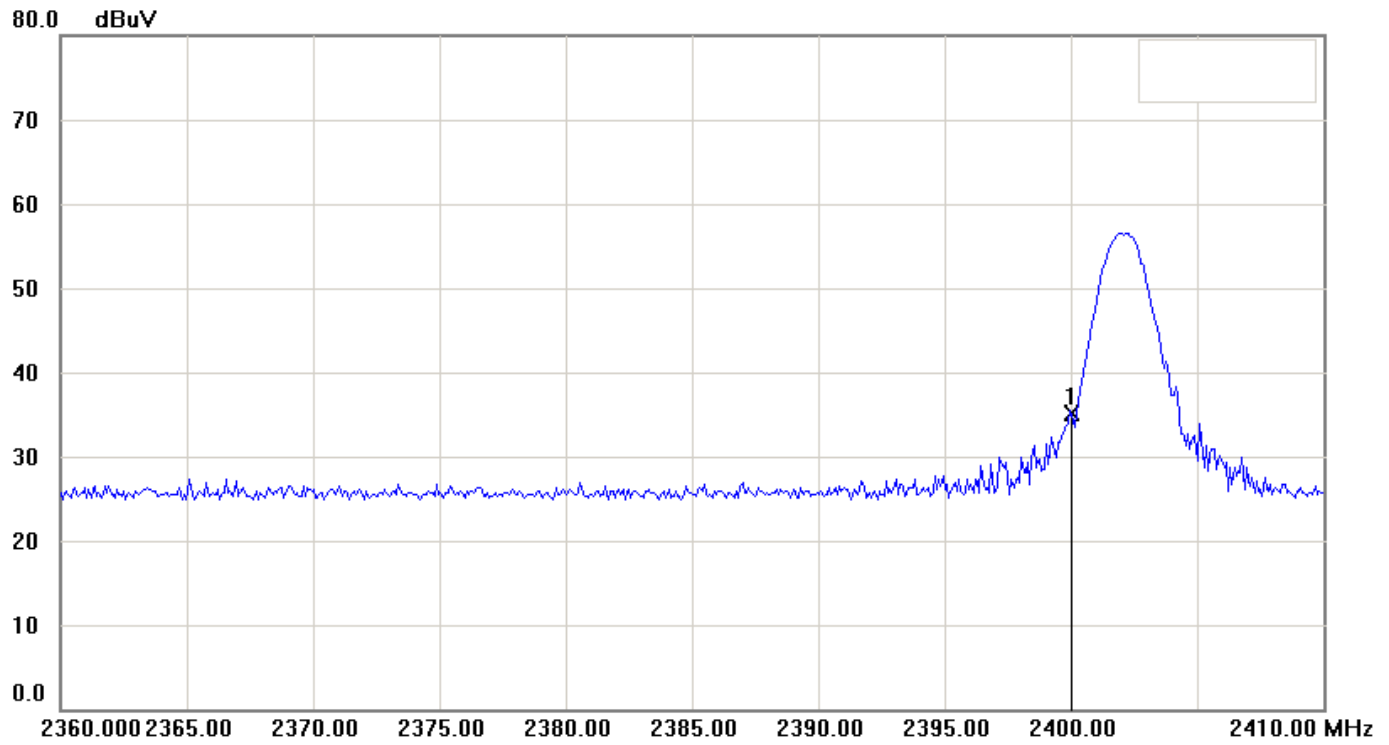

Condition:	Polarization:	Horizontal
EUT:	Distance:	3m
Model:	Detector:	Peak
Test Mode:		
Note:		

File: Data: #11 Date: 2015/12/18 Temperature: 22 °C
 Time: PM 02:48:17 Humidity: 65 %

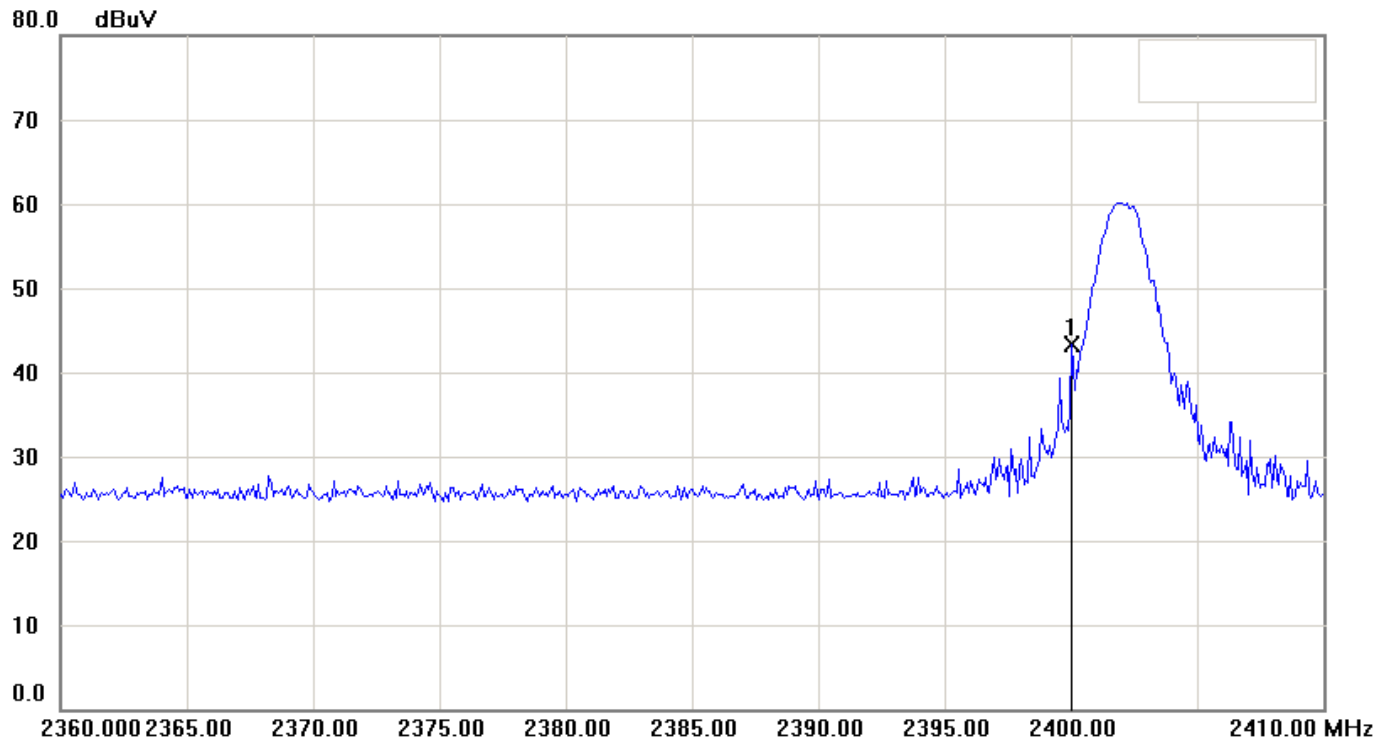

Condition:	Polarization:	Vertical
EUT:	Distance:	3m
Model:	Detector	Peak
Test Mode:		
Note:		

File:	Data: #5	Date: 2015/12/18	Temperature: 22 °C
		Time: PM 02:27:15	Humidity: 65 %

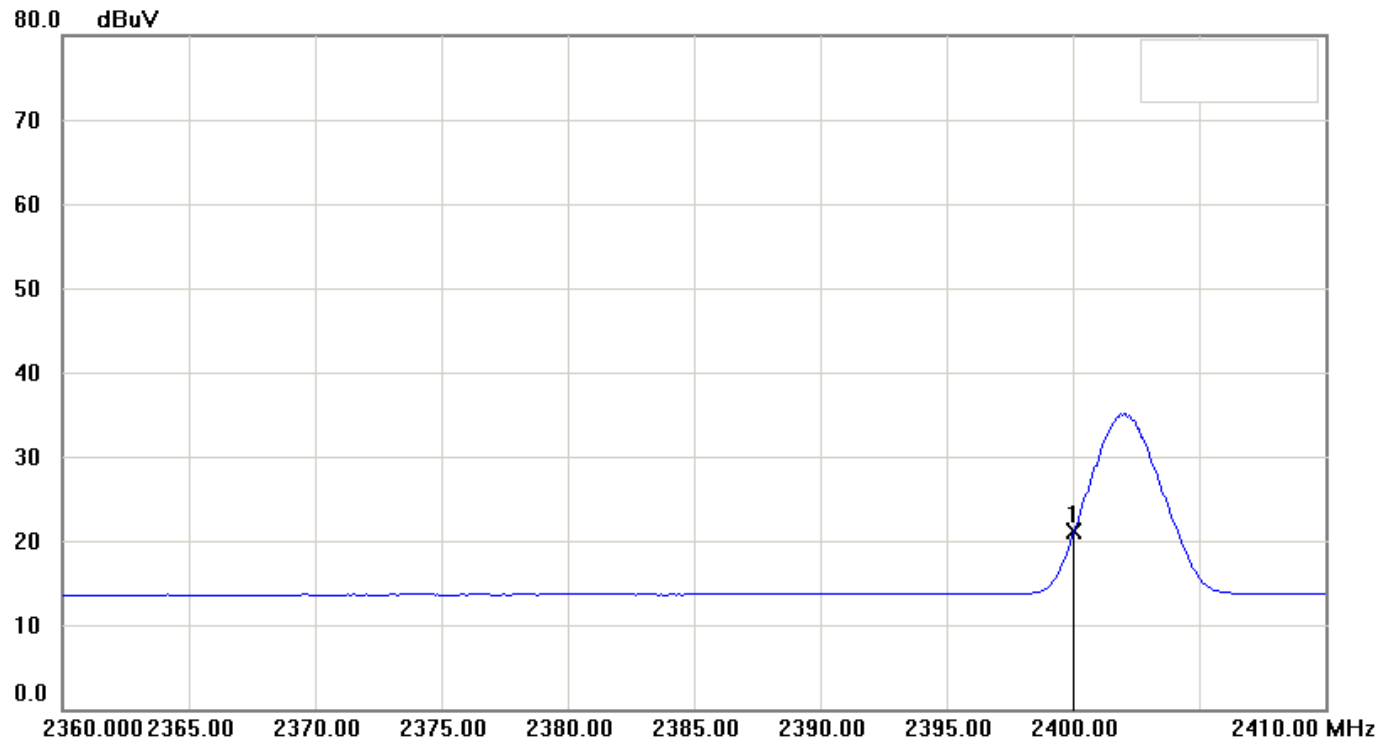

Condition:	Polarization: Horizontal
EUT:	Distance: 3m
Model:	Detector: AVG
Test Mode:	
Note:	

File: Data: #13 Date: 2015/12/18 Temperature: 22 °C
Time: PM 02:59:19 Humidity: 65 %

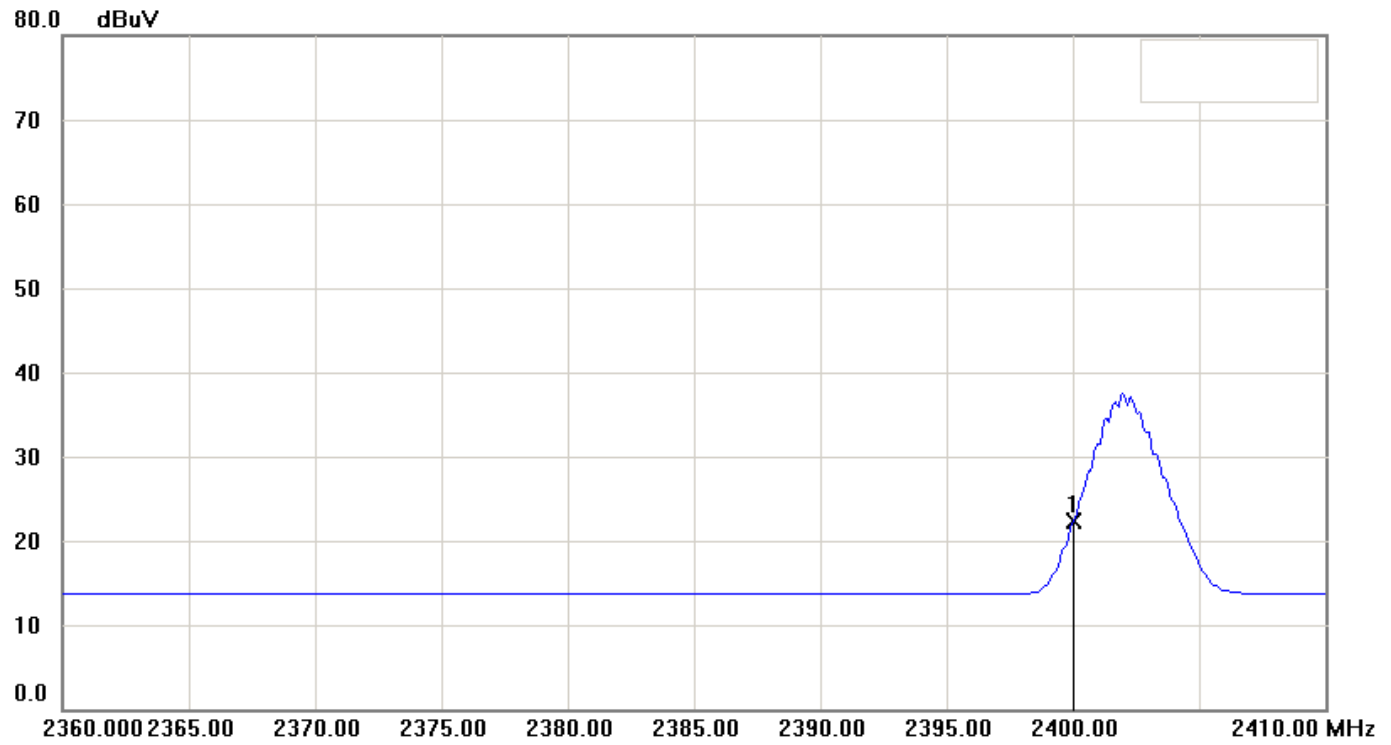

Condition: Polarization: Vertical
EUT: Distance: 3m
Model: Detector: AVG
Test Mode:
Note:

File: Data: #16 Date: 2015/12/18 Temperature: 22 °C
Time: PM 03:22:58 Humidity: 65 %

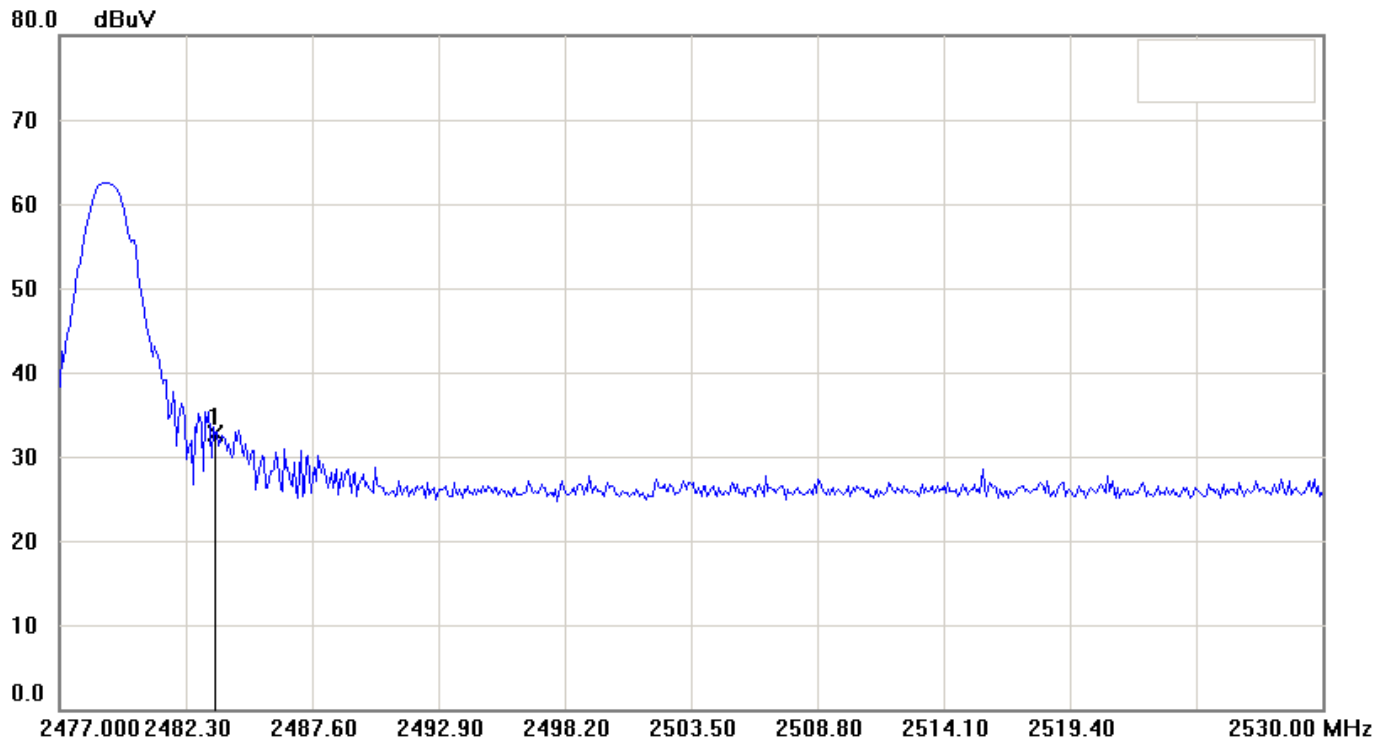

Condition: Polarization: Horizontal
EUT: Distance: 3m
Model: Detector Peak
Test Mode:
Note:

File: Data: #15 Date: 2015/12/18 Temperature: 22 °C
Time: PM 03:09:52 Humidity: 65 %

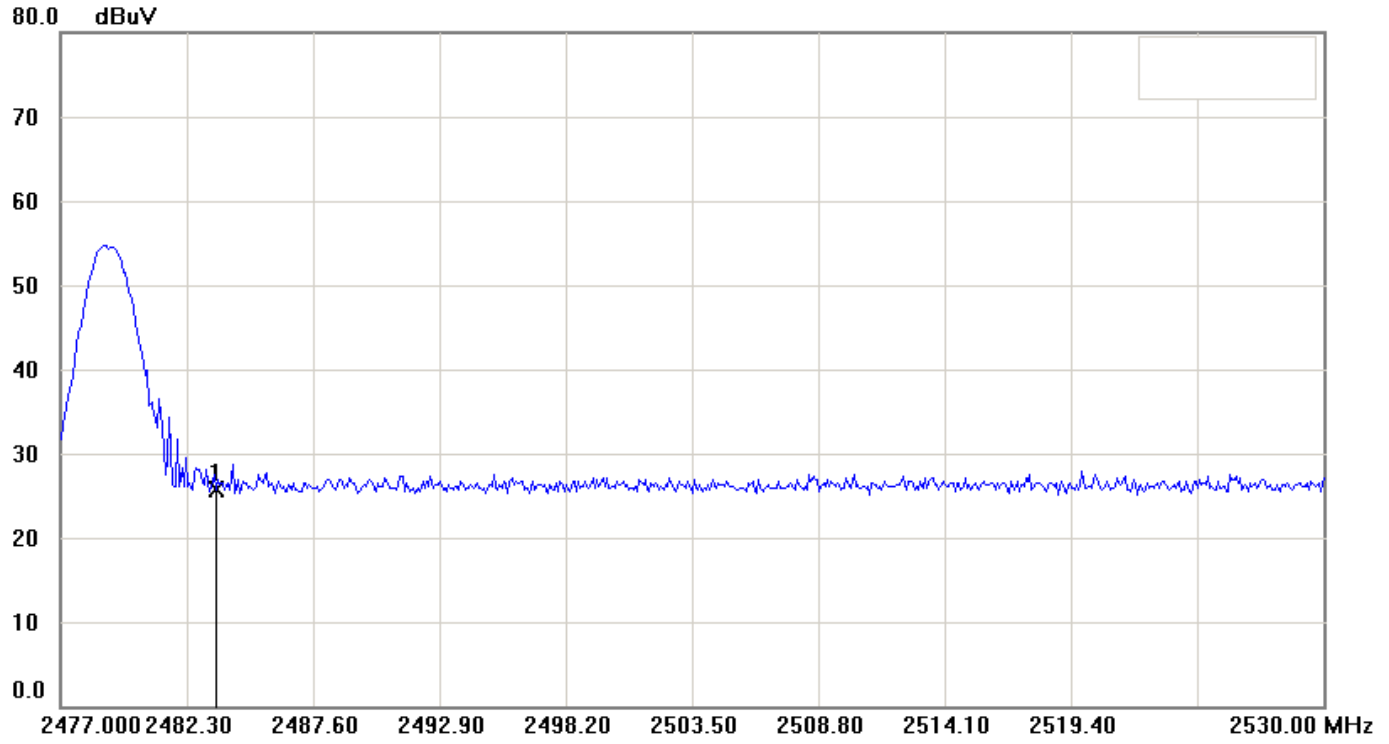

Condition: Polarization: Vertical
EUT: Distance: 3m
Model: Detector Peak
Test Mode:
Note:

File: Data: #17 Date: 2015/12/18 Temperature: 22 °C
Time: PM 03:30:45 Humidity: 65 %



Condition: Polarization: Horizontal
EUT: Distance: 3m
Model: Detector: AVG
Test Mode:
Note:

File: Data: #15 Date: 2015/12/18 Temperature: 22 °C
Time: PM 03:09:52 Humidity: 65 %



Condition: Polarization: Vertical
EUT: Distance: 3m
Model: Detector AVG
Test Mode:
Note:

3.3.2.5 20dB Emission Bandwidth

File: 123 Data: #10 Date: 2015/12/25 Temperature: 22 °C
 Time: AM 11:40:59 Humidity: 60 %

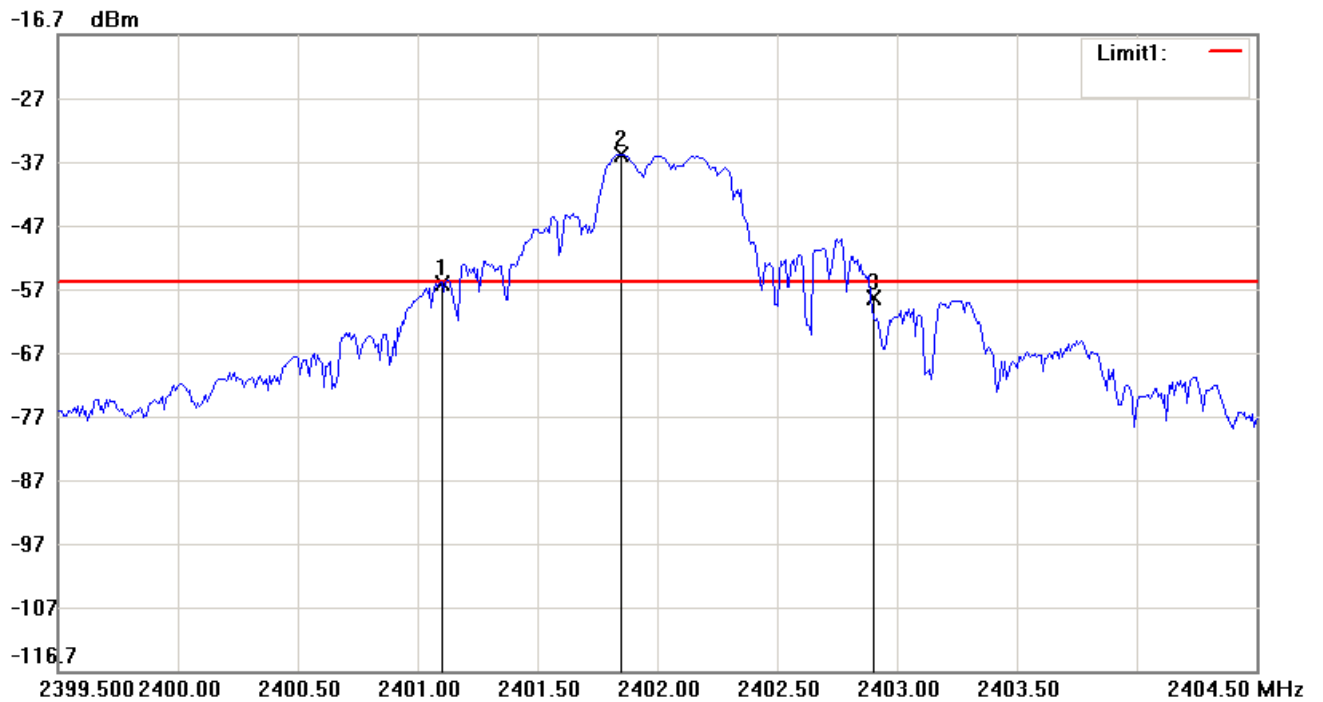

Condition: RF Conducted
 EUT: Sweep Time: 1ms Att.: 10dB
 Model: RBW: 100 KHz VBW: 300 KHz
 Test Mode:
 Note:

No.	Frequency(MHz)	Level(dBm)
1	2401.09170	-55.88
2	2401.84170	-35.54
3	2402.89170	-58.02

No.		Δ Frequency(MHz)	Δ Level(dB)
1	mk3-mk1	1.8	-2.14

File: 123 Data: #9 Date: 2015/12/25 Temperature: 22 °C
 Time: AM 11:38:58 Humidity: 60 %

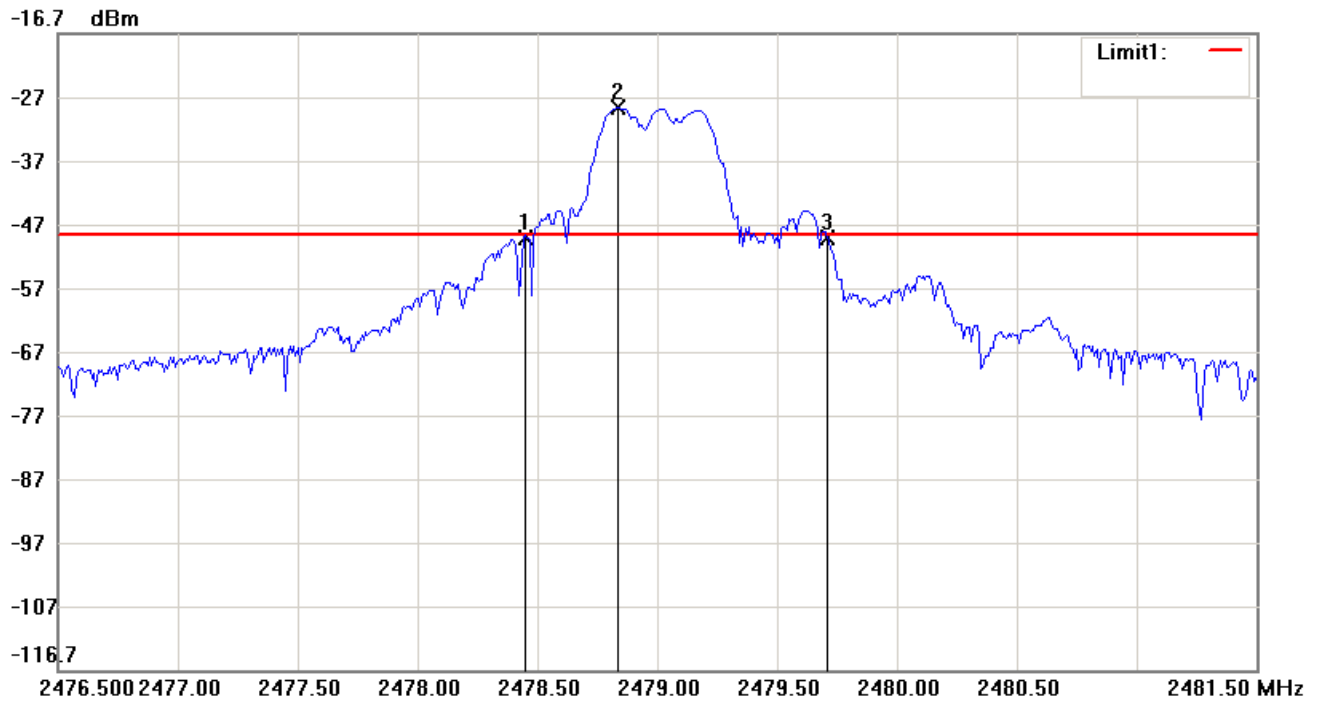

Condition:
 EUT:
 Model:
 Test Mode:
 Note:

RF Conducted
 Sweep Time: 1ms Att.: 10dB
 RBW: 100 KHz VBW: 300 KHz

No.	Frequency(MHz)	Level(dBm)
1	2478.44167	-48.83
2	2478.83333	-28.39
3	2479.70833	-48.79

No.		Δ Frequency(MHz)	Δ Level(dB)
1	mk3-mk1	1.26666	0.04

3.4 Field Strength Calculation

The field strength is calculated by adding the Antenna Factor and Cable Factor, and subtracting the Amplifier Gain (if any) from the measured reading. The basic equation with a sample calculation is as follows:

$$\mathbf{RESULT = READING + CORR. FACTOR}$$

where CORR. FACTOR = Antenna FACTOR + Cable FACTOR

3.5 Radiated Test Equipment

The following instrument are used for radiated emissions measurement:

Equipment	Manufacturer	Model No.
EMI Test Receiver	Rohde & Schwarz	ESIB7
Horn Antenna	EMCO	3115
BiLog Antenna	Schaffner	CBL6112B
Horn Antenna	EMCO	3116
Preamplifier	Hewlett-Packard	8449B
Spectrum Analyzer	R&S	FSU46

Note: The standards used to perform this calibration are traceable to NML/ROC, NIST/USA and NPL.

3.6 Measuring Instrument Setup

Measuring instrument setup in measured frequency band when specified detector function is used:

Frequency Band (MHz)	Instrument	Function	Resolution Bandwidth	Video Bandwidth
30 to 1000	RF Test Receiver	Quasi-Peak	120 kHz	300 kHz
	RF Test Receiver	Peak	120 kHz	300 kHz
Above 1000	Spectrum Analyzer	Peak	1 MHz	1 MHz
	Spectrum Analyzer	Average	1 MHz	10 Hz

4. CONDUCTED EMISSION MEASUREMENT

4.1 Standard Applicable

For unintentional and intentional device, Line Conducted Emission Limits are in accordance to § 15.107(a) and § 15.207(a) respectively. Both Limits are identical specification.

4.2 Measurement Procedure

1. Setup the configuration per figure 1.
2. A preliminary scan with a spectrum monitor is performed to identify the frequency of emission that has the highest amplitude relative to the limit by operating the EUT in selected modes of operation, typical cable positions, and with a typical system configuration.
3. Record the 6 highest emissions relative to the limit.
4. Measure each frequency obtained from step 3 by a test receiver set on quasi peak detector function, and then record the accuracy frequency and emission level. If all emissions measured in the specified band are attenuated more than 20 dB from the limit, this step would be ignored, and the peak detector function would be used.
5. Confirm the highest three emissions with variation of the EUT cable configuration and record the final data.
6. Repeat all above procedures on measuring each operation mode of EUT.

Figure 1 : Conducted emissions measurement configuration

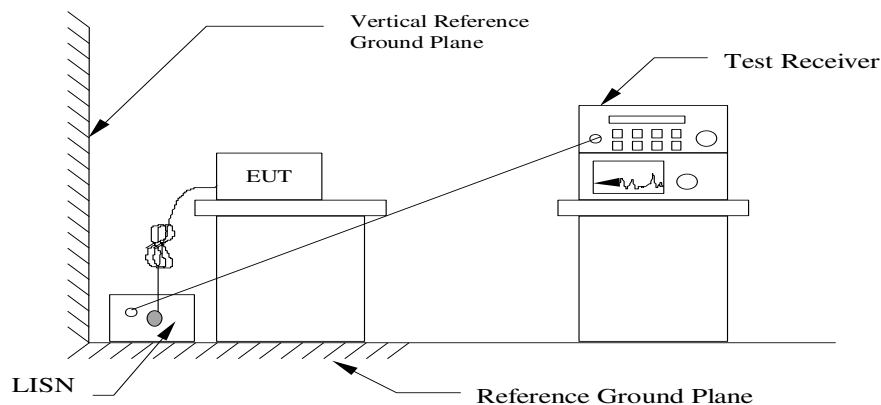

4.3 Conducted Emission Data

File: **yu** Data: **#660** Date: **2015/9/18** Temperature: **24 °C**
 Time: **PM 01:22:11** Humidity: **63 %**

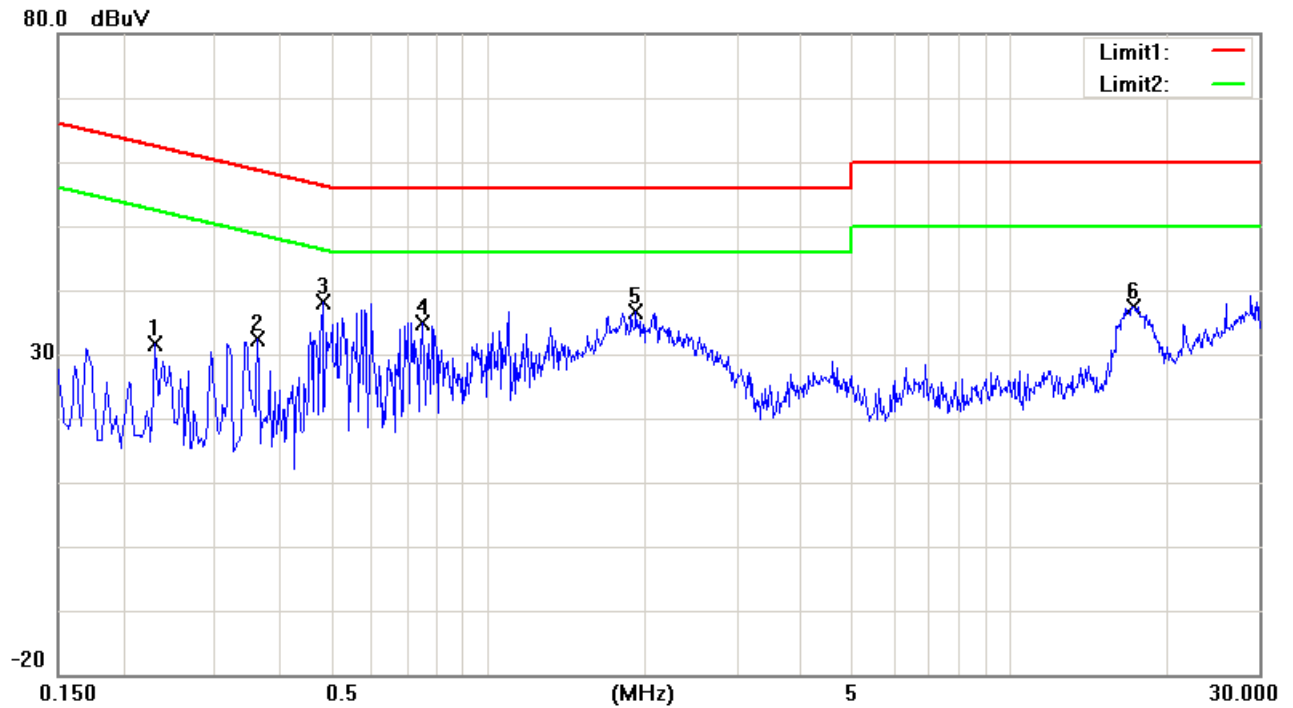

Condition: **Phase: L1**
 EUT:
 Model:
 Test Mode:
 Note: **DC 110V 20KW**

No.	Frequency (MHz)	Reading (dBuV)	Detector	Corrected (dB)	Result (dBuV)	Limit (dBuV)	Margin (dB)
1	0.2300	21.87	peak	9.65	31.52	62.45	-30.93
2	0.3620	22.72	peak	9.66	32.38	58.68	-26.30
3	0.4820	28.38	peak	9.66	38.04	56.30	-18.26
4	0.7500	25.25	peak	9.67	34.92	56.00	-21.08
5	1.9220	27.01	peak	9.70	36.71	56.00	-19.29
6	17.2460	27.51	peak	9.89	37.40	60.00	-22.60

- Note:
1. Place of measurement: EMC LAB. of the ETC.
 2. "***" means the value was too low to be measured.
 3. If the data table appeared symbol of "----" means the Q.P. value is under the limit of AVG. so, the AVG. value doesn't need to be measured.
 4. "#" means the noise was too low, so record the peak value.
 5. The estimated measurement uncertainty of the result measurement is $\pm 2.5\text{dB}$.

File: yu

Data: #659

Date: 2015/9/18

Temperature: 24 °C

Time: PM 01:21:19

Humidity: 63 %

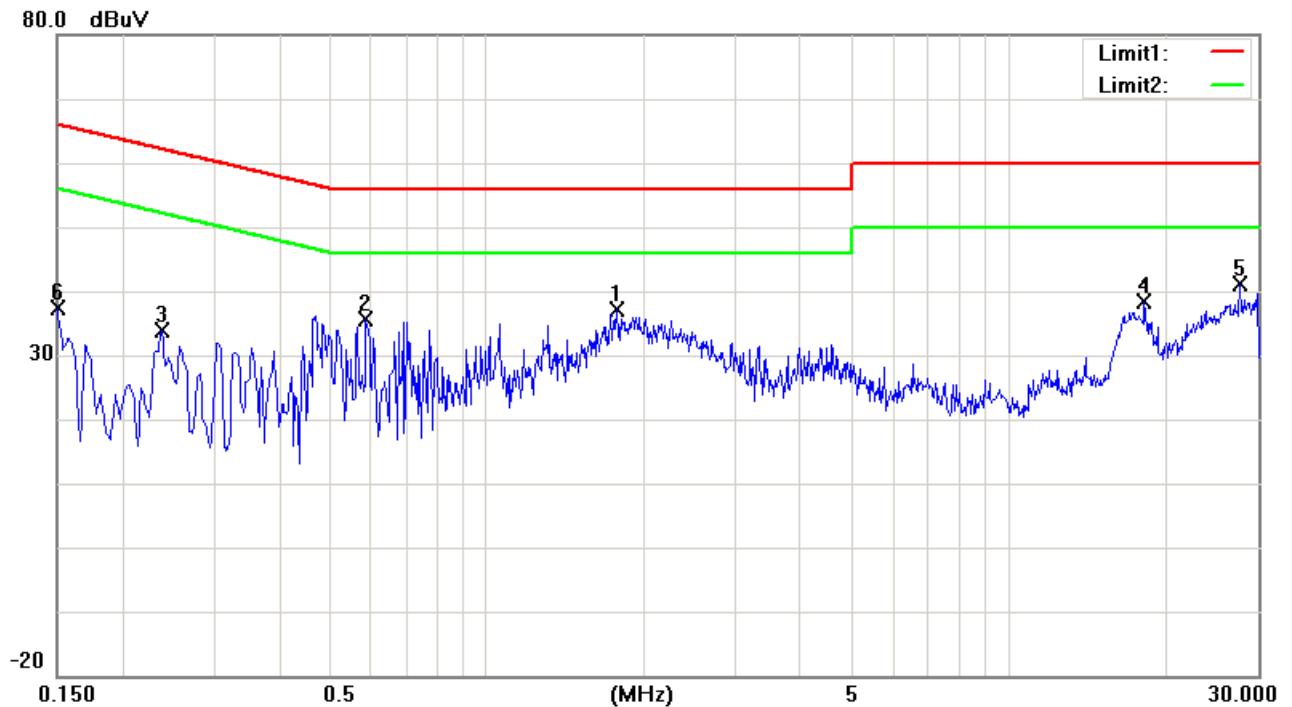

Condition:

Phase:

N

EUT:

Model:

Test Mode:

Note: DC 110V 20KW

No.	Frequency (MHz)	Reading (dBuV)	Detector	Corrected dB	Result (dBuV)	Limit (dBuV)	Margin (dB)
1	1.7780	27.39	peak	9.69	37.08	56.00	-18.92
2	0.5860	25.91	peak	9.64	35.55	56.00	-20.45
3	0.2380	24.32	peak	9.63	33.95	62.17	-28.22
4	18.1940	28.49	peak	9.99	38.48	60.00	-21.52
5	27.6260	31.10	peak	10.03	41.13	60.00	-18.87
6	0.1500	27.74	peak	9.64	37.38	66.00	-28.62

Note: 1. Place of measurement: EMC LAB. of the ETC.

2. “***” means the value was too low to be measured.

3. If the data table appeared symbol of "----" means the Q.P. value is under the limit of AVG. so, the AVG. value doesn't need to be measured.

4. “#” means the noise was too low, so record the peak value.

5. The estimated measurement uncertainty of the result measurement is $\pm 2.5\text{dB}$.

4.4 Result Data Calculation

The result data is calculated by adding the LISN Factor to the measured reading. The basic equation with a sample calculation is as follows:

$$\mathbf{RESULT = READING + LISN FACTOR (Included Cable Loss)}$$

4.5 Conducted Measurement Equipment

The following test equipment are used during the conducted test.

Equipment	Manufacturer	Model No.
EMI Test Receiver	R&S	ESCI
V-LISN	R&S	ENV216

5. EQUIPMENTS LIST FOR TESTING

Equipment	Manufacturer	Model No.	S/N	Calibration Date	Next Cal. Due
EMI Receiver	R&S	ESIB 7	13054414-001	01/17/2015	01/16/2016
Horn Antenna	EMCO	3115	13059201-001	09/10/2015	09/09/2016
BiLog Antenna	Schaffner	CBL6112B	2927	10/16/2015	10/15/2016
Hom Antenna	EMCO	3116	13059202-001	08/22/2015	08/21/2016
PRE-Amplifier	Agilent	8449B	13040709-001	11/21/2015	11/20/2016
Spectrum Analyzer	R&S	FSU46	13040904-001	01/17/2015	01/16/2016
EMI Test Receiver	R&S	ESCI	13054418-001	05/04/2015	05/03/2016
V-LISN	R&S	ENV216	13057719-001	05/13/2015	05/12/2016