





NVLAP Lab Code 200737-0

This report must not be used to claim product certification, approval, or endorsement by NVLAP, NIST, or any agency of the Federal Government. EMCI, Inc. is a NVLAP accredited laboratory.

Test Report issued under the responsibility of:



<b>TEST REPORT</b>	
FCC Part 15 Radio Frequency Devices Subpart C – Intentional Radiators	
<b>Report Reference No.</b> .....	: ETRB51002, Rev. A
Compiled by (+ signature) .....	: Kevin Johnson. 
Approved by (+ signature) .....	: Vincent W. Greb 
Date of issue .....	: 18 January 2016
Report Revision .....	: Initial Release
Total number of pages .....	: 71
<b>Testing Laboratory</b> .....	: EMC Integrity, Inc.
Address .....	: 1736 Vista View Drive. Longmont, CO 80504 USA FRN: <b>0015264914</b> IC Registration Number: <b>7726A</b>
	Tel: +1 303-776-7249 Fax: +1 303-776-7314
<b>Applicant's name</b> .....	: Kindara
Address.....	: 1628 Walnut Street, Boulder, CO 80302
<b>Model(s) Tested</b> .....	: Wink
<b>Test specification:</b>	
Standard .....	: FCC Part 15, Subpart C, , DTS 247 (v03r02), RSS-247 (Issue 1)
Test procedure.....	: ANSI C63.4:2009, ANSI C63.10: 2013
Non-standard test method .....	: N/A
TRF Revision.....	: 18 January 2016

<b>Revision History</b>		
<b>#</b>	<b>Description</b>	<b>Date</b>
-	Initial Report Release	22 December 2015
A	Corrected calibration date of Asset #1396 (page 19)	18 January 2016

**Notices:**

- 1.This report shall not be reproduced, except in full, without the written approval of the Issuing testing laboratory.
- 2.The test results presented in this report relate only to the object tested.
- 3.The results contained in this report reflect the results for this particular model and serial number. It is the responsibility of the manufacturer to ensure that all production models meet the intent of the requirements detailed within this report.
- 4."(See Enclosure #)" refers to additional information appended to the report.
- 5.Throughout this report a point is used as the decimal separator.
- 6.Dimensions in English units for convenience only, metric units prevail.

## **Table of Contents**

Revision History .....	2
Normative References.....	4
Equipment Under Test (EUT) .....	5
Details: .....	5
EUT Configuration .....	6
EUT Photo(s) .....	8
Summary of Testing.....	9
Testing Location.....	10
Procedural Requirements .....	10
United States .....	10
Information to the User and Labeling Requirements .....	10
United States .....	11
Technical Requirements.....	12
Conducted Emissions (Not Applicable) .....	12
Mains.....	12
Radiated Emissions – Restricted Bands .....	13
Restricted Bands 47 CFR 15.205.....	14
Radiated Emission Limit – Restricted Bands.....	14
DTS - Bandwidth .....	14
DTS - Fundamental Emission Output Power .....	15
DTS - Power Spectral Density.....	15
DTS - Emissions in Non-Restricted Bands .....	16
DTS - Band-Edge .....	16
DTS - Peak RF Output Power.....	16
DTS - Spurious Emissions.....	17
Measurement Uncertainty .....	17
List of Test Equipment.....	19
Test Results – Antenna Requirement.....	20
Test Results – Radiated Emissions – Spurious Out of Band Emissions & Restricted Bands.....	22
Test Results – 99% Occupied Bandwidth .....	35
Test Results – Band Edge .....	39
Test Results – DTS – 6 dB Occupied Bandwidth .....	42
Test Results – DTS – Power Spectral Density .....	46
Test Results – DTS – RF Power Output.....	50
Test Results – DTS – Spurious Emissions, Restricted Bands .....	54
Test Results - RF Exposure.....	67
Setup Photos.....	70

## Normative References

The following document(s) have been appropriately considered in the performance of the test results detailed in this report.

CFR Title 47, Part 15  
Radio Frequency Devices

Guidance for Performing Compliance Measurements on Digital Transmission Systems (DTS) Operating Under 15.247 (June 9, 2015)

RSS-247 (Issue 1, May 2015)  
Digital Transmission Systems (DTSSs), Frequency Hopping Systems (FHSs) and License-Exempt Local Area Network (LE-LAN) Devices

ANSI C63.4: 2009  
American National Standard for Methods of Measurement of Radio-Noise Emissions from Low-Voltage Electrical and Electronic Equipment in the Range of 9 kHz to 40 GHz

ANSI C63.10: 2013  
American National Standard of Procedures for Compliance Testing of Unlicensed Wireless Devices

## Equipment Under Test (EUT)

### Details:

#### Test item description:

Model ..... : Wink  
Serial Number ..... : A35  
Production Status ..... :  Production  Pre-Production  Prototype  
\*Production unit was specially modified with Mode Button  
Other Status Info ..... : N/A.  
EUT Received Date ..... : 16 October 2015  
Ratings ..... :  1 $\phi$   3 $\phi$   Internal Battery

#### General product description:

- The Wink device takes an oral temperature and sends the temperature to an App loaded on a cell phone.
- The Wink utilizes Bluetooth Low Energy (BTLE) technology.
- It should be noted that this report deals only with the FCC and IC testing of this unit.

#### Modifications to the EUT required for compliance:

No compliance modifications required.

#### Deviations from Test Methodology:

It should be noted that in order to facilitate testing, the PCB was modified to allow for the addition of wires to program the transmitter for different modes.

#### Engineering Judgements:

No engineering judgments based on the results in this test report have been made.

Approved by (+ signature) ..... : Vincent W. Greb



*Table 1 – EUT Internal Operating Frequencies*

Frequency	Description
32.768 kHz	RC oscillator – generated and used on BCM20736S chip
128 kHz	RC oscillator
24 MHz	Internal clock signal for BCM20736S chip
2402 to 2480 MHz	Tx frequency – Bluetooth transmitter

*Table 2 – EUT Operating Modes Used During Testing*

Mode #	Description
1	Tx Low (modulated)
2	Tx Mid (modulated)
3	Tx High (modulated)
4	Rx mode

## EUT Configuration

A minimum representative configuration, as defined by the manufacturer, has been used for the testing performed herein. The selection of hardware (including interface ports), software, and cables were chosen by the manufacturer as being representative of the product’s intended use. The interconnection of various articles of equipment and the types of cables used has also been defined by the manufacturer.

As the transmit antenna was integrated into the Broadcom chip, measuring conducted emissions at the antenna port was not possible. Radiated emissions testing was performed for all three orthogonal axes of the UUT, and the worst-case orientation was used for all formal measurements. The final placement of the equipment under test has been, to the extent practical, arranged to maximize emissions. The UUT was operated using a continuous (i.e., 100%) duty cycle for all testing.

Cables, of the type and length specified by the manufacturer, were connected to at least one of each type of interface port provided by the EUT and if practical, were terminated by a device typical of actual usage. For multiple ports of the same type, the addition of cables did not significantly affect the emission level (i.e. < 2B variation).

The arrangement of external power supply units was as follows:

- a) If the mains input cable of the external power supply unit is greater than 0,8 m, the external power supply unit shall be placed on the tabletop, with a nominal 0,1 m separation from the host unit.
- b) If the external power supply unit has a mains input cable that is less than 0,8 m, the external power supply unit shall be placed at a height above the ground plane such that its power cable is fully extended in the vertical direction.
- c) If the external power supply unit is incorporated into the mains power plug, it shall be placed on the tabletop. An extension cable shall be used between the external power supply unit and the source of power. The extension cable should be connected in a manner such that it takes the most direct path between the external power supply unit and the source of power.

Figure 1 - EUT Configuration Diagram

## WK01 Block Diagram

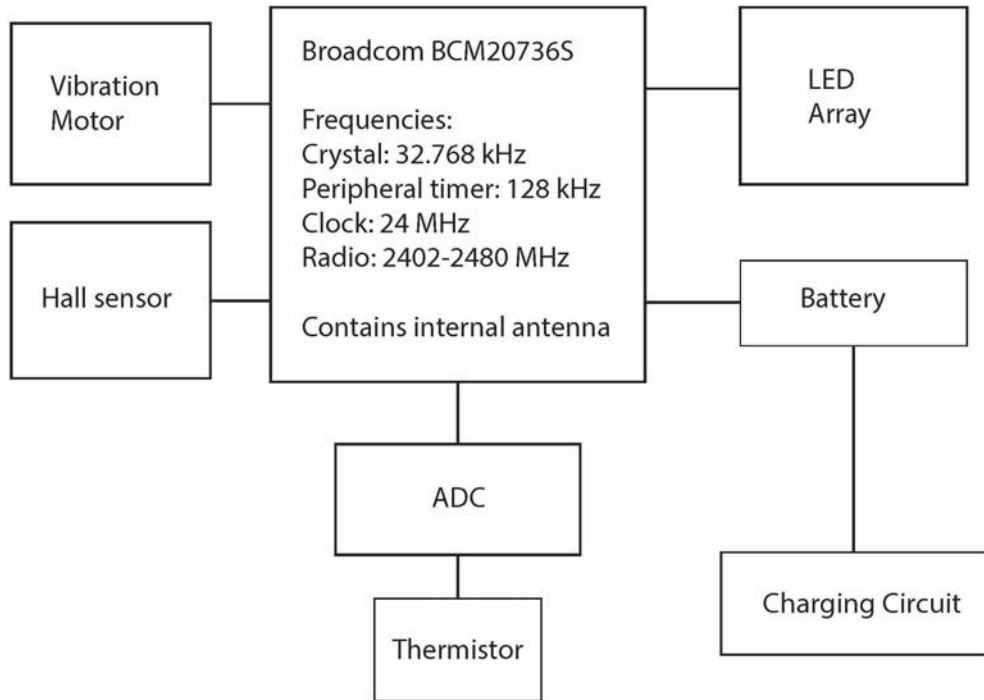

Table 3 – EUT Equipment List (No AE was required)

Item	Use*	Product Type	Manufacturer	Model	Serial No.
A	EUT	Thermometer	Kindara	Wink	A35
Note: * Use = EUT - Equipment Under Test, AE - Auxiliary/Associated Equipment, or SIM - Simulator (Not Subjected to Test)					

Table 4 - Interconnecting Cables List – Not applicable

Item	Use*	Cable Type
1		
2		
3		
4		

**EUT Photo(s)**

Photo 1

**EUT Photo – Front View**

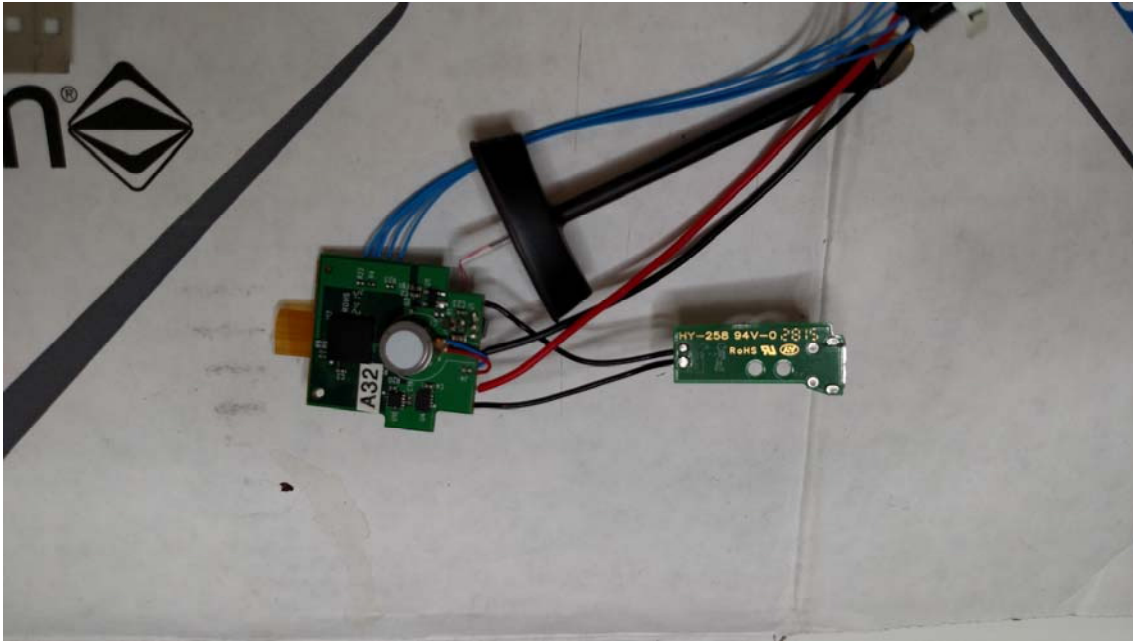

PCB – Top Side.

**Supplemental Information:**

Photo 2

**EUT Photo – Back View**

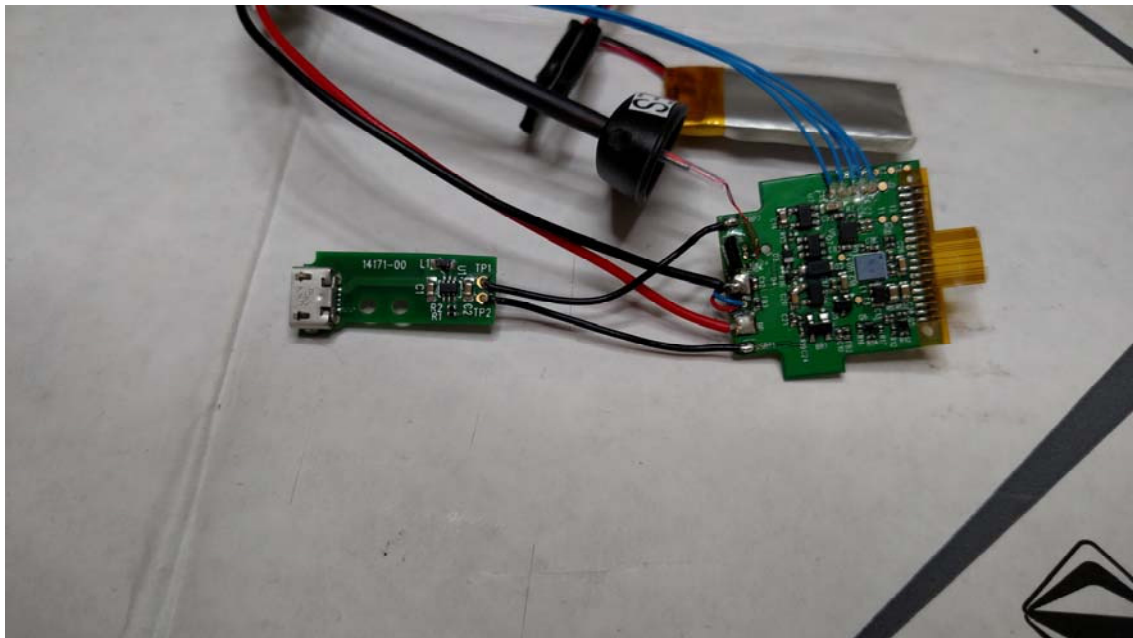

PCB – Bottom Side.

**Supplemental Information:**

## Summary of Testing

### Possible test case verdicts:

- test case does not apply to the test object : N/A
- test object does meet the requirement .....: P (Pass)
- test object does not meet the requirement : F (Fail)
- not tested (not part of this evaluation) .....: NT

Date(s) of performance of tests .....: 16 October through 17 November 2015.

Clause	Test Description	Verdict	Comment
<b>47 CFR</b>			
15.203	Antenna Requirement	P	
15.207	Conducted Emissions - Mains	N/A	
15.209	Radiated Emissions – Spurious Out of Band Emissions and Restricted Bands	P	
15.247(a)(1)	99% Occupied Bandwidth	P	
15.247(b)	Peak RF Output Power	P	
15.247(d)	Band Edge	P	
15.247(e)	RF Exposure	P	
<b>DTS Operating Under 15.247</b>			
8.0	6 dB Occupied Bandwidth	P	
9.0	Fundamental Emission Output Power	P	
10.0	Power Spectral Density	P	
11.0	Emissions in non-Restricted Bands	P	
12.0	Emissions in Restricted Bands	P	
13.0	Spurious Emissions – Band Edge	P	



### Notes:

### General remarks:

As this product was powered by an internal DC battery which was disposable, it has no connection to the AC power mains. Therefore, conducted emissions testing was not applicable ("N/A").

### Summary of compliance with national requirements:

Compliance with this standard provides a means of conformity with the United States Federal Communication Commission (FCC) verification, certification, or declaration of conformity authorization procedures and Industry Canada (IC) rules.

<b>Testing Location</b>	
<b>Testing Laboratory:</b>	
Testing location/ address .....	: EMC Integrity, Inc. 1736 Vista View Drive Longmont, CO 80504
Testing procedure: TMP	
Tested by (name + signature)	: Kevin Johnson 
Approved by (+ signature)	: Vincent W. Greb 
Testing location/ address .....	: EMC Integrity, Inc. 1736 Vista View Drive Longmont, CO 80504
<b>Supplemental Information:</b>	
Testing results contained herein were performed at the location(s) listed above.	

### **Procedural Requirements**

The following requirements are taken from the appropriate rules, other rules may apply and the manufacturer should consult the full text of the appropriate laws prior to marketing any device.

#### ***United States***

Mandated procedures for digital devices are defined in 47 CFR 15.201, *Equipment authorization requirement*. Details of the authorization procedures (verification, declaration of conformity, and certification) can be found in 47 CFR, Part 2, Subpart J, *Equipment Authorization Procedures*.

### **Information to the User and Labeling Requirements**

The following requirements are taken from the appropriate rules, other rules may apply and the manufacturer should consult the full text of the appropriate laws prior to marketing any device.

## ***United States***

### Labeling

#### 47 CFR 2.925

(a) Each equipment covered in an application for equipment authorization shall bear a nameplate or label listing the following:

(1) FCC Identifier consisting of the two elements in the exact order specified in §2.926. The FCC Identifier shall be preceded by the term *FCC ID* in capital letters on a single line, and shall be of a type size large enough to be legible without the aid of magnification.

*Example:* FCC ID XXX123. XXX—Grantee Code 123—Equipment Product Code

#### 47 CFR 15.19

(a) In addition to the requirements in part 2 of this chapter, a device subject to certification, or verification shall be labeled as follows:

(3) All other devices shall bear the following statement in a conspicuous location on the device:

This device complies with part 15 of the FCC Rules. Operation is subject to the following two conditions: (1) This device may not cause harmful interference, and (2) this device must accept any interference received, including interference that may cause undesired operation.

47 CFR 15.19(b)(2) Label text and information should be in a size of type large enough to be readily legible, consistent with the dimensions of the equipment and the label. However, the type size for the text is not required to be larger than eight point.

47 CFR 15.19(b)(3): When the device is so small or for such use that it is not practicable to place the statement specified under paragraph (b)(1) of this section on it, such as for a CPU board or a plug-in circuit board peripheral device, the text associated with the logo may be placed in a prominent location in the instruction manual or pamphlet supplied to the user. However, the unique identification (trade name and model number) and the logo must be displayed on the device.

47 CFR 15.19(b)(4): The label shall not be a stick-on, paper label. The label on these products shall be permanently affixed to the product and shall be readily visible to the purchaser at the time of purchase, as described in §2.925(d) of this chapter. "Permanently affixed" means that the label is etched, engraved, stamped, silkscreened, indelibly printed, or otherwise permanently marked on a permanently attached part of the equipment or on a nameplate of metal, plastic, or other material fastened to the equipment by welding, riveting, or a permanent adhesive. The label must be designed to last the expected lifetime of the equipment in the environment in which the equipment may be operated and must not be readily detachable.

### Information to User

47 CFR 15.21: The user's manual or instruction manual for an intentional or unintentional radiator shall caution the user that:

Changes or modifications not expressly approved by the party responsible for compliance could void the user's authority to operate the equipment.

In cases where the manual is provided only in a form other than paper, such as on a computer disk or over the Internet, the information required by this section may be included in the manual in that alternative form, provided the user can reasonably be expected to have the capability to access information in that form.

## Technical Requirements

The testing requirements, as appropriate, were derived from ANSI C63.4; 47 CFR, Subpart A.

### Conducted Emissions (Not Applicable)

The mains cable of the EUT or EUT host unit was connected to the LISN defined in this standard and is bonded to the reference plane. Where applicable, remaining auxiliary equipment was powered through an additional LISN (also bonded to the reference plane), using a multi-socket outlet strip if necessary. The LISNs were at least 0.8m away from the EUT. A vertical ground plane was used while the table-top EUTs were placed on a wooden table 0.8m high. Floor-standing EUTs were insulated from the ground plane and grounded according to the manufacturer's instructions.

Signal cables were positioned for their entire lengths, as far as possible, at a nominal distance of 0.4 m from the ground reference plane. Where the mains cable supplied by the manufacturer was longer than 1 m, the excess was folded at the center into a bundle no longer than 0.4 m, so that its length is shortened to 1 m. If the 1 m cable length cannot be achieved owing to physical limitations of the EUT arrangement, the cable length shall be as near to 1 m as possible.

All telecommunication and signal ports were correctly terminated using either appropriate associated equipment or a representative termination during the measurement of the conducted disturbances at the mains. If an ISN is connected to a telecommunications port during the measurement of conducted disturbances at the mains port, then the ISN receiver port was terminated in 50Ω. The ISNs were at least 0.8m away from the EUT.

### Mains

Any power cable(s) from the equipment under test that were directly connected to the AC Mains have been tested. In the event that the equipment under test had no direct connection to the Mains, that is, it was connected to a Host unit (example: USB powered); then conducted emissions was performed on the Mains of the Host unit. Battery powered equipment was not tested for conducted emissions; however, if the equipment makes provisions for connections to a battery charger that is connected to the Mains, then conducted emissions were performed on the battery charger.

Table 5 – Class B Conducted Emissions Limits - Mains

Frequency	Limits (dBμV)	
	Quasi-peak	Average
150 kHz – 500 kHz	66 - 56	5-46
500 kHz – 5 MHz	56	46
5 MHz – 30 MHz	60	50

NOTE 1: The lower limit shall apply at the transition frequency.  
NOTE 2: The limit decreases linearly with the logarithm of the frequency in the range 150 kHz to 500 kHz.

## Radiated Emissions – Restricted Bands

The arrangement of the equipment is typical of a normal installation practice and as was practical, the arrangement was varied and emissions investigated for maximum amplitude. Final measurements were performed in a semi-anechoic chamber. The equipment was rotated 360° and the antenna height has been varied between 1m and 4m. Measurements were taken at both horizontal and vertical antenna polarities. The receiver bandwidth was set to 120 kHz for measurements below 1 GHz, and 1 MHz for measurements above 1 GHz. A peak detector is used to detect an emission; a quasi-peak detector may be used to record a final measurement below 1 GHz and an average detector may be used above 1 GHz. An inverse proportionality factor of 20 dB/decade (10 dB) was used, as noted in 15.31(f)(1), to normalize the measured data to the specified test distance for determining compliance.

Frequency range of radiated measurements (15.33(a)):

<b>Operating frequency of intentional radiator</b>	<b>Lowest frequency searched</b>	<b>Highest frequency searched</b>
<b>Below 10 GHz</b>	9 kHz or lowest operating frequency generated in the device, whichever is highest	10 <sup>th</sup> harmonic of highest fundamental frequency or 40 GHz, whichever is lower
<b>10 – 30 GHz</b>	9 kHz or lowest operating frequency generated in the device, whichever is highest	5 <sup>th</sup> harmonic of highest fundamental frequency or 100 GHz, whichever is lower
<b>At or above 30 GHz</b>	9 kHz or lowest operating frequency generated in the device, whichever is highest	5 <sup>th</sup> harmonic of highest fundamental frequency or 200 GHz, whichever is lower

**Restricted Bands 47 CFR 15.205**

MHz	MHz	MHz	GHz
0.090–0.110	16.42–16.423	399.9–410	4.5–5.15
<sup>1</sup> 0.495–0.505	16.69475–16.69525	608–614	5.35–5.46
2.1735–2.1905	16.80425–16.80475	960–1240	7.25–7.75
4.125–4.128	25.5–25.67	1300–1427	8.025–8.5
4.17725–4.17775	37.5–38.25	1435–1626.5	9.0–9.2
4.20725–4.20775	73–74.6	1645.5–1646.5	9.3–9.5
6.215–6.218	74.8–75.2	1660–1710	10.6–12.7
6.26775–6.26825	108–121.94	1718.8–1722.2	13.25–13.4
6.31175–6.31225	123–138	2200–2300	14.47–14.5
8.291–8.294	149.9–150.05	2310–2390	15.35–16.2
8.362–8.366	156.52475–156.52525	2483.5–2500	17.7–21.4
8.37625–8.38675	156.7–156.9	2690–2900	22.01–23.12
8.41425–8.41475	162.0125–167.17	3260–3267	23.6–24.0
12.29–12.293	167.72–173.2	3332–3339	31.2–31.8
12.51975–12.52025	240–285	3345.8–3358	36.43–36.5
12.57675–12.57725	322–335.4	3600–4400	( <sup>2</sup> )
13.36–13.41			

**Radiated Emission Limit – Restricted Bands**

Reading on the measuring receiver showing fluctuations close to the limit, were observed for at least 15 s at each measurement frequency; the highest reading was recorded.

Table 6 – Radiated Emissions Limits per 47 CFR 15.209(a) & RSS-GEN 7.2.5

Frequency Range	Field Strength (µV/m)	Field Strength (dBµV/m)	Measurement Distance (m)
9 kHz – 490 kHz	2400/F(kHz)	48.5 – 13.8	300
490 kHz – 1.705 MHz	24000/F(kHz)	33.6 – 23.0	30
1.705 MHz – 30 MHz	30	29.5	30
30 MHz – 88 MHz	100	40.0	3
88 MHz – 216 MHz	150	43.5	3
216 MHz – 960 MHz	200	46.0	3
Above 960 MHz	500	54.0	3

**DTS - Bandwidth**

Section 8.0: DTS bandwidth was measured using **Option 2** given under Section 8.0 of the FCC’s “Guidance for Performing Compliance Measurements on Digital Transmission Systems (DTS) Operating Under 15.247”, dated April 9, 2013. The following verbiage describes this procedure.

EUT configuration: The EUT is set to normal Tx mode for low, middle and high Tx frequencies.

Spectrum analyzer settings:

RBW = 100 kHz

VBW  $\geq$  3 x RBW

Trace mode = max hold

Sweep = auto

Allow trace to stabilize

The automatic bandwidth measurement capability of an instrument may be employed by using the X dB bandwidth mode, with X set to 6 dB, if the functionality described above is implemented by the instrumentation function. When using this capability, care shall be taken so that the bandwidth measurement is not influenced by any intermediated power nulls in the fundamental emission that might be  $\geq$  6 dB. The minimum DTS bandwidth shall be at least 500 kHz.

## DTS - Fundamental Emission Output Power

Section 9.0: Fundamental emission output power was measured as outlined in **Section 9.1.1** of the FCC's "Guidance for Performing Compliance Measurements on Digital Transmission Systems (DTS) Operating Under 15.247", dated April 9, 2013. (This method was chosen as the DTS BW was less than 1 MHz.) The following verbiage describes this procedure.

EUT configuration: The EUT is set to normal Tx mode for low, middle and high Tx frequencies.

Spectrum analyzer settings:

RBW  $\geq$  DTS Bandwidth, or 1 MHz

VBW  $\geq$  3 x RBW, or 3 MHz

Span  $\geq$  3 x RBW, or 3 MHz)

Detector = Peak

Trace = Max Hold

Allow trace to stabilize

Use peak marker to determine the peak amplitude level.

## DTS - Power Spectral Density

Section 10.0: Power spectral density was measured as outlined in **Section 10.2 Method PKPSD** of the FCC's "Guidance for Performing Compliance Measurements on Digital Transmission Systems (DTS) Operating Under 15.247", dated April 9, 2013. The following verbiage describes this procedure. Since the maximum peak conducted output power (EIRP) method was used to demonstrate compliance, the peak PSD method specified in Section 10.2 was used for this measurement, as follows:

EUT configuration: The EUT is set to normal Tx mode for low, middle and high Tx frequencies.

Analyzer center frequency was set to DTS channel center frequency.

Span was set to 1.5 x DTS bandwidth

RBW was 3 kHz  $\leq$  RBW  $\leq$  100 kHz

Video Bandwidth was  $\geq$  3 x RBW

Sweep time = auto couple

Detector = Peak

Trace = Max Hold

Allow trace to stabilize

Use peak marker to determine the peak amplitude within the RBW. In the event that measured value exceeds limit, reduce RBW (no less than 3 kHz) and repeat.

## DTS - Emissions in Non-Restricted Bands

Section 12.0. Same method and data as for emissions in restricted bands.

## DTS - Band-Edge

Section 13.0 Band-edge was measured as outlined in **Section 13.2 Marker Delta Method** of the FCC's "Guidance for Performing Compliance Measurements on Digital Transmission Systems (DTS) Operating Under 15.247", dated April 9, 2013. The following verbiage describes this procedure.

EUT test mode: The EUT is set in its normal Tx mode for lowest and highest channels.

Spectrum analyzer settings:

The marker-delta method, as described in ANSI C63.10, can be used to perform measurements of the radiated unwanted emissions level at the band-edges provided that the 99% OBW of the fundamental emission is within 2 MHz of the authorized band edge.

Verify that emissions at band-edge and below/above band-edge comply with FCC 15.209 limit.

## DTS - Peak RF Output Power

15.247(2)(b)(1):

Frequency Band	Minimum No. of Non-Overlapping Hopping Channels	Maximum Peak RF Power at antenna
2400-2483.5 MHz	75	1 watt
2400-2483.5 MHz	All other	0.125 watt
5725-5850 MHz	-	1 watt

15.247(2)(b)(2): For...systems operating in the 902–928 MHz band:

Frequency Band	Minimum No. of Non-Overlapping Hopping Channels	Maximum Peak RF Power at antenna
902-928 MHz	50	1 watt
902-928 MHz	<50 but at least 25	0.250 watt

EUT test mode: The peak rf output power shall be measured at low, mid, and high channels and for each modulation mode.

Spectrum analyzer settings:

Span = approximately 5 times the 20 dB bandwidth, centered on a hopping channel

RBW > the 20 dB bandwidth of the emission being measured

VBW  $\geq$  RBW

Sweep = auto

Detector function = peak

Trace = max hold

## DTS - Spurious Emissions

15.247(d): In any 100 kHz bandwidth outside the frequency band in which the spread spectrum or digitally modulated intentional radiator is operating, the radio frequency power that is produced by the intentional radiator shall be at least 20 dB below that in the 100 kHz bandwidth within the band that contains the highest level of the desired power, based on either an RF conducted or a radiated measurement, provided the transmitter demonstrates compliance with the peak conducted power limits. If the transmitter complies with the conducted power limits based on the use of RMS averaging over a time interval, the attenuation required under this paragraph shall be 30 dB instead of 20 dB. Attenuation below the general limits is not required. In addition, radiated emissions which fall in the restricted bands must also comply with the radiated emission limits specified.

Spectrum analyzer settings:

Span = wide enough to capture the peak level of the in-band emission and all spurious emissions (e.g., harmonics) from the lowest frequency generated in the EUT up through the 10<sup>th</sup> harmonic. Typically, several plots are required to cover this entire span.

RBW = 100 kHz

VBW  $\geq$  RBW

Sweep = auto

Detector function = peak

Trace = max hold

Band edge spurious emissions:

Measurement shall be made in the following bands:

2310 – 2390 MHz

2483.5 – 2500 MHz

Span = wide enough to capture the peak level of the emission operating on the channel closest to the band edge, as well as any modulation products which fall outside of the authorized band of operation

RBW  $\geq$  1% of the span

VBW  $\geq$  RBW

Sweep = auto

Detector function = peak

Trace = max hold

## Measurement Uncertainty

Determining compliance with the limits in these standards was based on the results of the measurement, and does not take into account the measurement instrumentation uncertainty.

Referencing the measurement instrumentation uncertainty considerations contained in CISPR 16-4-2, the expanded measurement uncertainty numbers for each test is given in Table 7.

*Table 7 – Measurement Uncertainty Summary*

<b>Test</b>	<b>Measurement Uncertainty</b>
Bandwidth	0.7 dB
Fundamental Emission Output Power	0.5 dB
Power Spectral Density	0.5 dB
20 dB Occupied Bandwidth	0.7 dB
Band-Edge	1%
Peak RF Output Power	0.5 dB
Spurious Emissions	3.2 dB
Conducted Emissions	3.04

## List of Test Equipment

The following test equipment was used in the performance of the testing herein.

*Table 8 – Test Equipment Used*

ID Number	Manufacturer	Model #	Serial #	Description	Cal Date	Cal Due
1341	HP	85650A	2811A01351	Quasi-Peak Adapter	05/31/2015	05/31/2016
1340	HP	8566B	2542A11546	Spectrum Analyzer Display	05/31/2015	05/31/2016
1339	HP	8566B	2937A06103	Spectrum Analyzer with 2542A11546	05/31/2015	05/31/2016
1337	HP	85685A	2833A00775	RF Preselector	05/31/2015	05/31/2016
1215	HP	8564E	3943A01645	9kHz-40GHz Portable Spectrum Analyzer	05/06/2015	05/06/2016
1220	Mini-Circuits	ZKL-2	NA	Preamp, 10 - 2000 MHz, 30 dB	03/30/2015	03/30/2016
1403	Ciao Wireless	CA118-3010	105+106	Preamp Assembly, 1-18 GHz, 56 dB gain	10/03/2014	10/03/2015
1537	Extech Instruments	445715	Z315813	Hygro-Thermometer	04/08/2015	04/08/2016
1396	CIR Enterprises	10m Chamber #2	002	10m Chamber with 4m turntable	08/14/2015	08/14/2016
1253	Narda West	1840N506	010-100	18 to 40 GHz Preamplifier, 40dB Gain Nominal	01/29/2015	01/29/2016
1246	Micro-Tronics	BRM50701	038	2.4 GHz Notch Filter	02/20/2015	02/20/2016
1232	Sunol Sciences	JB1	A071605-2	Bilog Antenna, 30 MHz to 2.0 GHz	09/04/2015	09/04/2016
1392	Sunol Sciences	DRH-118	A020311	1-18 GHz Double-Ridged Horn Antenna	01/12/2015	01/12/2016

## **Test Results – Antenna Requirement**

Table No. 1	Antenna requirement	Verdict
		P
Type of antenna connection	<input checked="" type="checkbox"/> Integral antenna <input type="checkbox"/> Permanently attached <input type="checkbox"/> Unique connector	
Type of unique connector	N/A	
Method of permanent connection	The antenna is integral to the Broadcom BCM 20736S chip.	

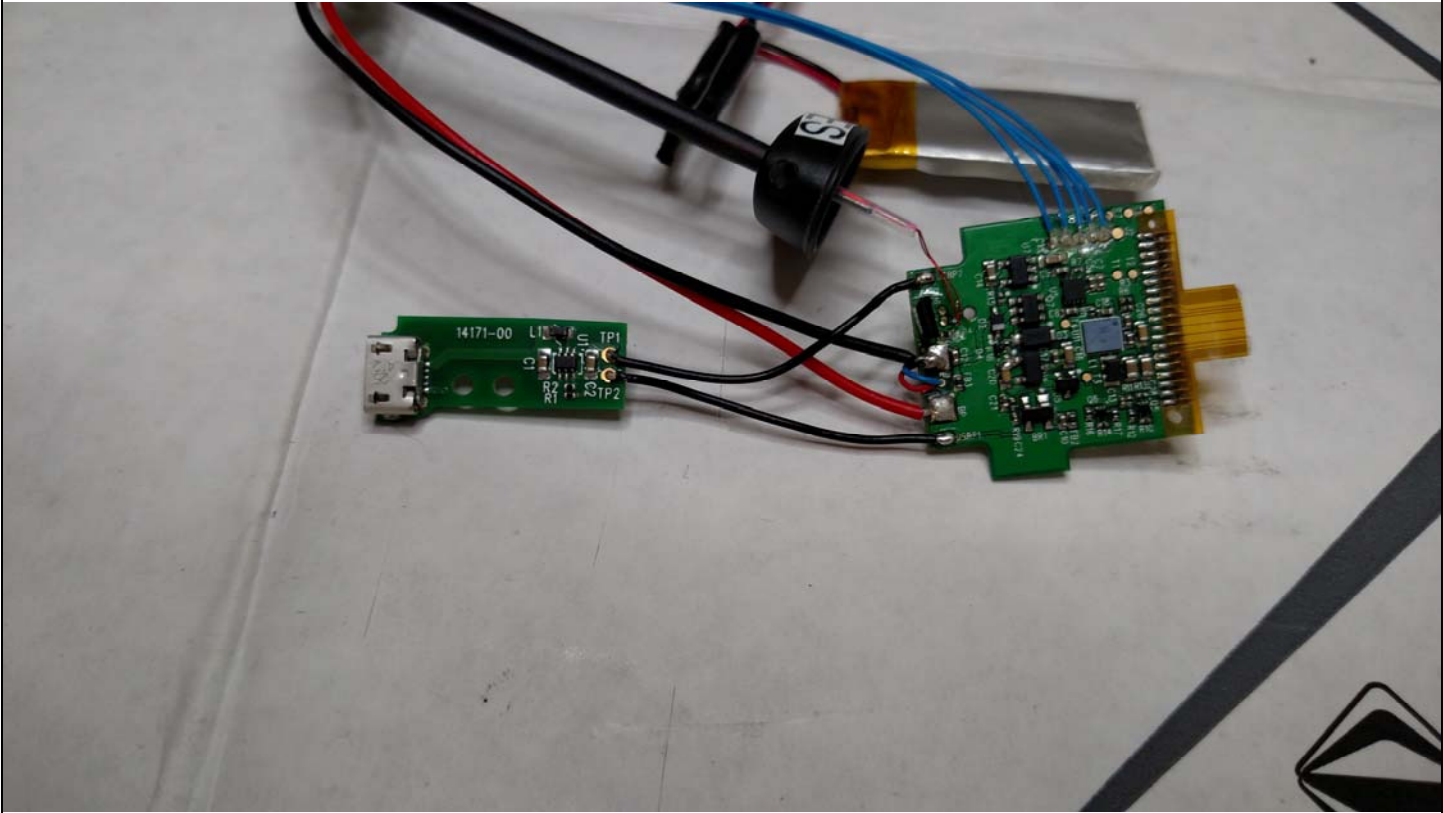

**Supplemental Information:**

Tested by (+ signature) .....:                      Kevin Johnson.



## **Test Results – Radiated Emissions – Spurious Out of Band Emissions & Restricted Bands**

Table No. 2	<b>Radiated Emissions – Spurious Out of Band Emissions &amp; Restricted Bands, Low, Mid and High Channels</b>	Verdict P
-------------	---	--------------

Frequency Range ..... : 30 kHz to 25 GHz                      Test Location ..... : 10m Chamber #2  
 Test Method..... : ANSI C63.4 & ANSI C63.10  
 Test Distance ..... : 10 m (30 kHz to 1 GHz); 3 m (1-18 GHz); 1 m (18-25 GHz)  
 EUT Configuration ..... : See individual plots for antenna, modulation and channel details  
 Test Date ..... : 11-16-2015.  
 Temperature ..... : 22°C    Relative Humidity .... : 24 %  
 Test Equipment Asset Tag List : 1337, 1339, 1340, 1341, 1215, 1220, 1403, 1246, 1537, 1396, 1253, 1232, 1392

**Supplemental Information:**

**Spurious Emissions, 30 kHz – 30 MHz low**

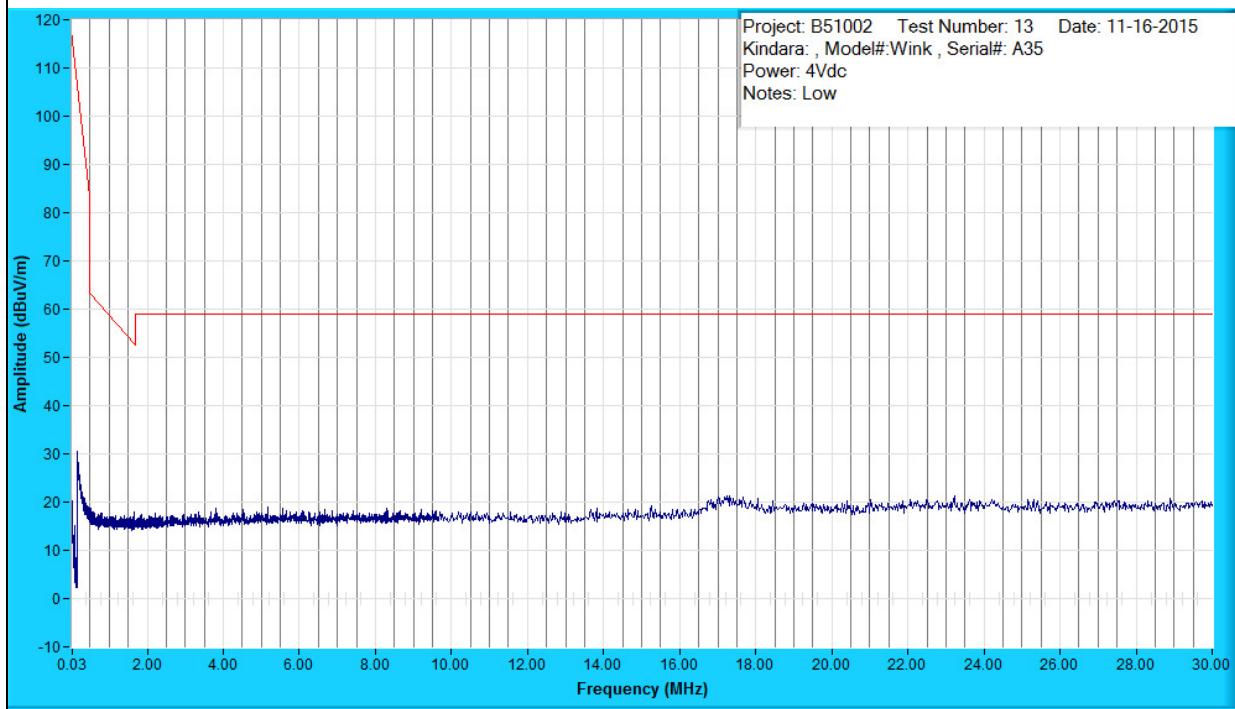

Type	Frequency (MHz)	Level (dBuV)	Transducer (dB/m)	Gain / Loss (dB)	Final (dBuV/m)	Azm(deg)/Pol/Hgt(m)	Margin: FCC Part 15 Low Freq AV (dB)
AV	0.150	1.9	3.9	0.0	5.7	225/V-Pole/1.02	102.21
QP	0.150	-4.8	3.9	0.0	-0.9	225/V-Pole/1.02	-
PK	0.150	2.6	3.9	0.0	6.5	225/V-Pole/1.02	101.46

Spurious Emissions, 30 kHz – 30 MHz Mid

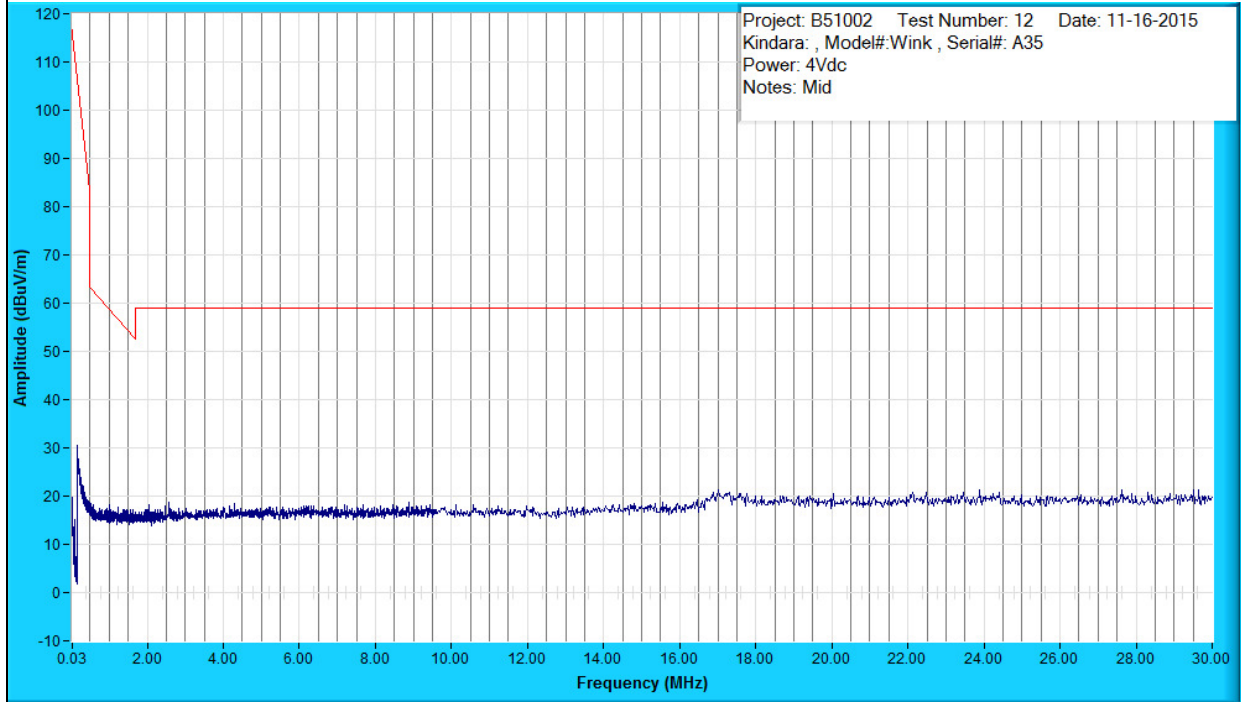

Type	Frequency (MHz)	Level (dBuV)	Transducer (dB/m)	Gain / Loss (dB)	Final (dBuV/m)	Azm(deg)/Pol/Hgt(m)	Margin: FCC Part 15 Low Freq AV (dB)
QP	0.151	24.4	3.9	0.0	28.2	90/H-Pole/1.02	-
AV	0.151	23.8	3.9	0.0	27.7	90/H-Pole/1.02	80.13
PK	0.151	27.9	3.9	0.0	31.8	90/H-Pole/1.02	76.03

Spurious Emissions, 30 kHz – 30 MHz High

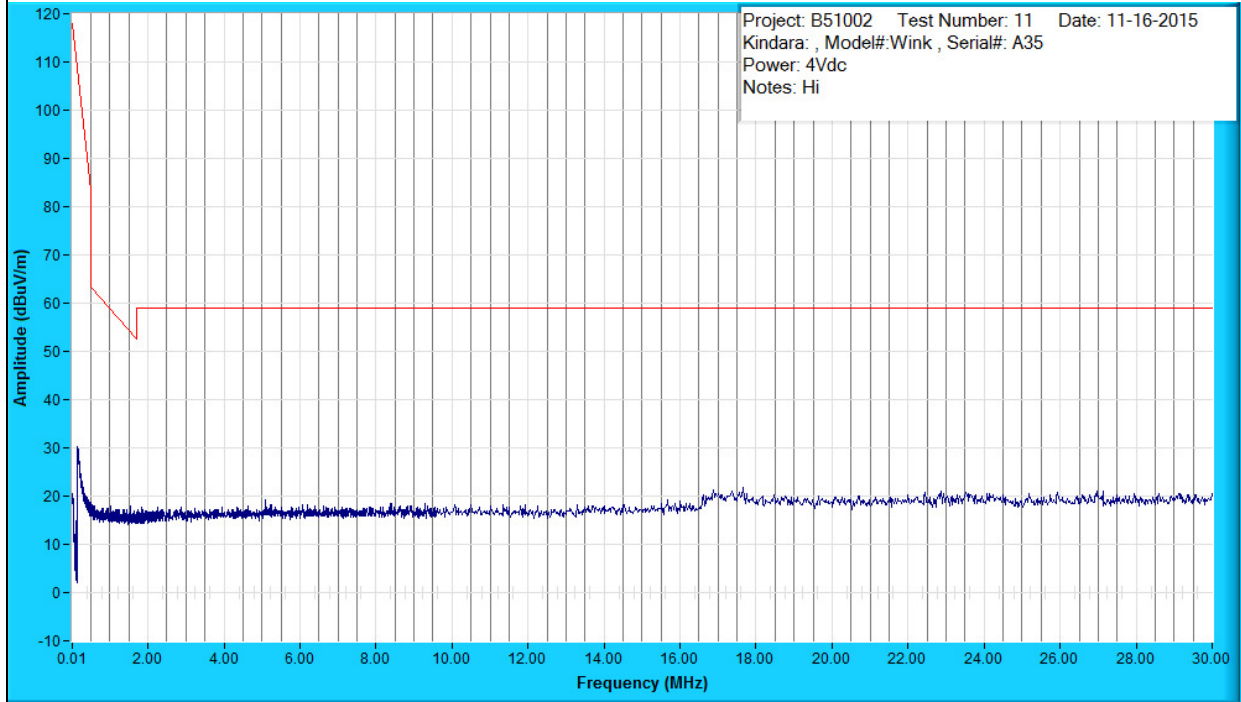

Type	Frequency (MHz)	Level (dBuV)	Transducer (dB/m)	Gain / Loss (dB)	Final (dBuV/m)	Azm(deg)/Pol/Hgt(m)	Margin: FCC Part 15 Low Freq AV (dB)
QP	0.154	24.2	3.8	0.0	28.0	315/H-Pole/1.02	-
PK	0.154	27.4	3.8	0.0	31.2	315/H-Pole/1.02	76.39

### Spurious Emissions, 30 MHz – 1GHz, Low

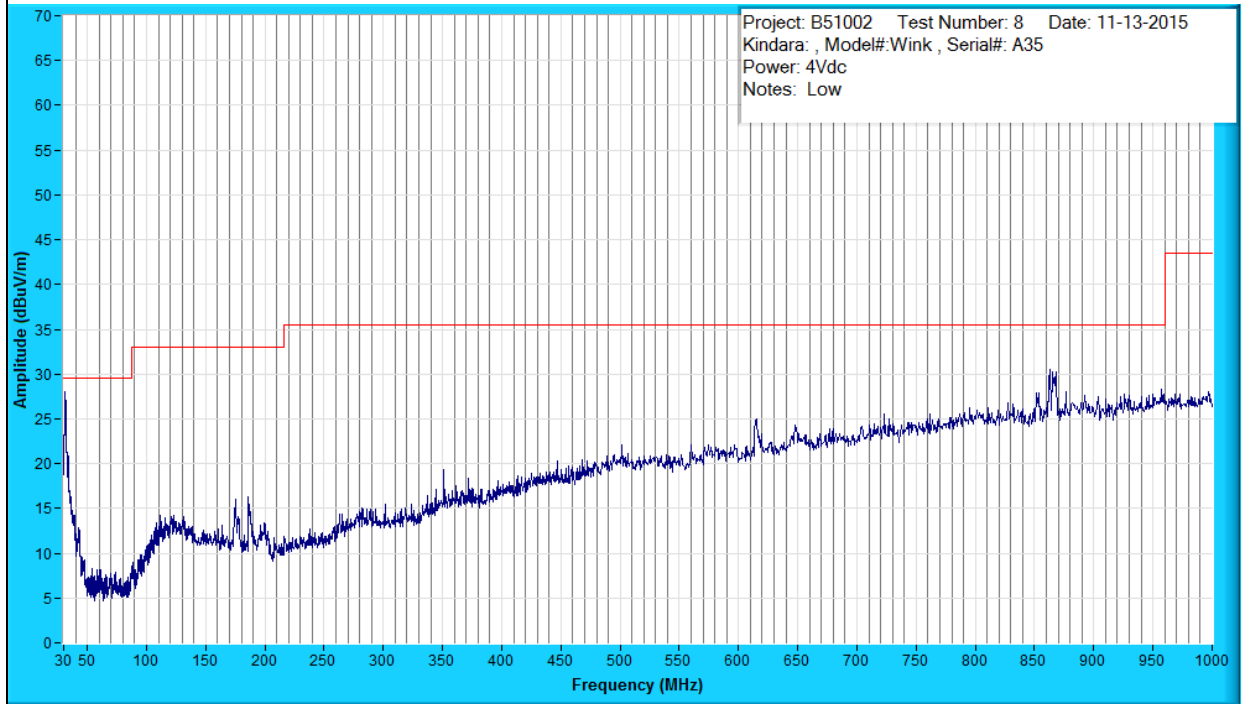

Type	Frequency (MHz)	Level (dBuV)	Transducer (dB/m)	Gain / Loss (dB)	Final (dBuV/m)	Azm(deg)/Pol/Hgt(m)	Margin: FCC Class B QP (dB)	Margin: FCC Class B AV (dB)
QP	31.324	37.6	20.0	-31.0	26.6	56/V-Pole/1.01	2.91	-
QP	175.292	31.7	11.5	-29.6	13.6	139/H-Pole/1.01	19.45	-
QP	186.295	32.6	11.4	-29.5	14.5	275/H-Pole/1.03	18.50	-
QP	614.328	33.4	18.9	-26.3	26.0	338/V-Pole/1.75	9.53	-
QP	852.455	29.4	21.5	-24.6	26.3	158/V-Pole/3.98	9.21	-
QP	863.223	32.7	21.9	-24.6	30.0	261/H-Pole/2.82	5.51	-

Spurious Emissions, 30 MHz – 1GHz, Mid

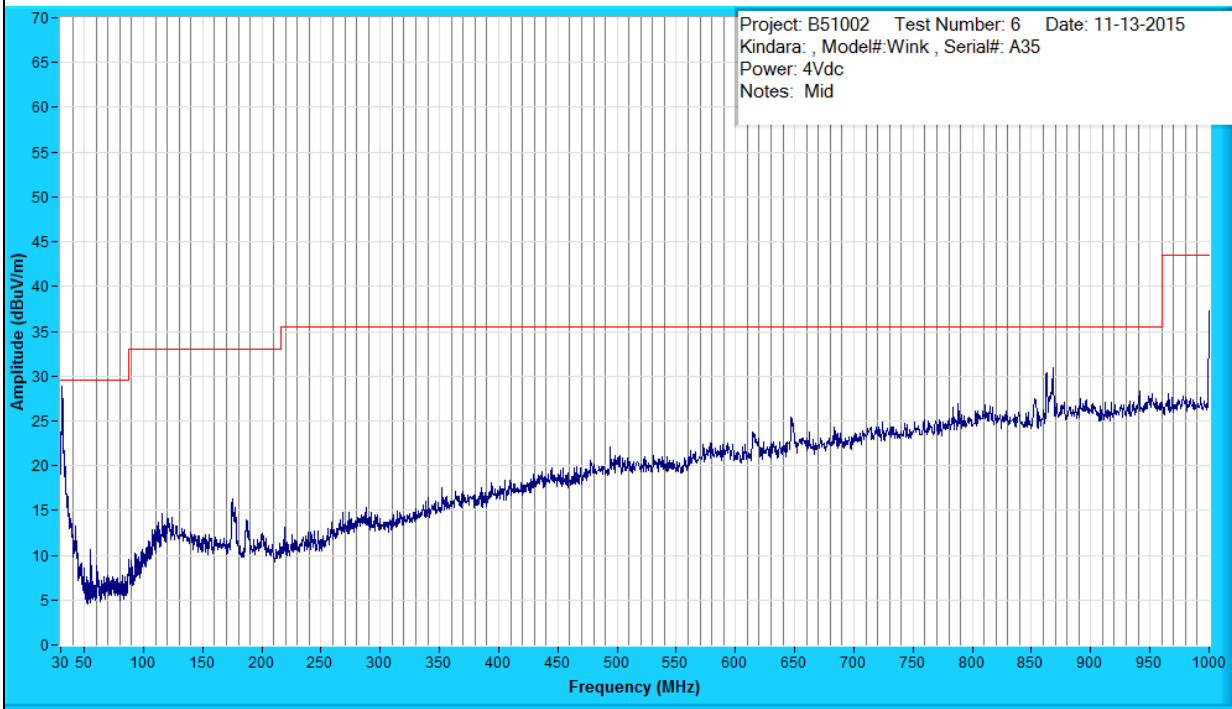

Type	Frequency (MHz)	Level (dBuV)	Transducer (dB/m)	Gain / Loss (dB)	Final (dBuV/m)	Azm(deg)/Pol/Hgt(m)	Margin: FCC Class B QP (dB)	Margin: FCC Class B AV (dB)
QP	31.306	37.0	20.1	-31.0	26.1	1/V-Pole/1.01	3.48	-
QP	175.255	31.3	11.4	-29.6	13.0	147/H-Pole/1.00	20.01	-
QP	647.744	28.6	19.6	-26.0	22.2	284/V-Pole/1.00	13.37	-
QP	862.605	32.5	21.6	-24.6	29.4	280/V-Pole/2.76	6.10	-
QP	867.641	28.4	22.0	-24.6	25.8	11/V-Pole/2.78	9.79	-
QP	997.120	23.7	23.0	-23.9	22.8	87/H-Pole/1.02	20.63	-

### Spurious Emissions, 30 MHz – 1GHz, High

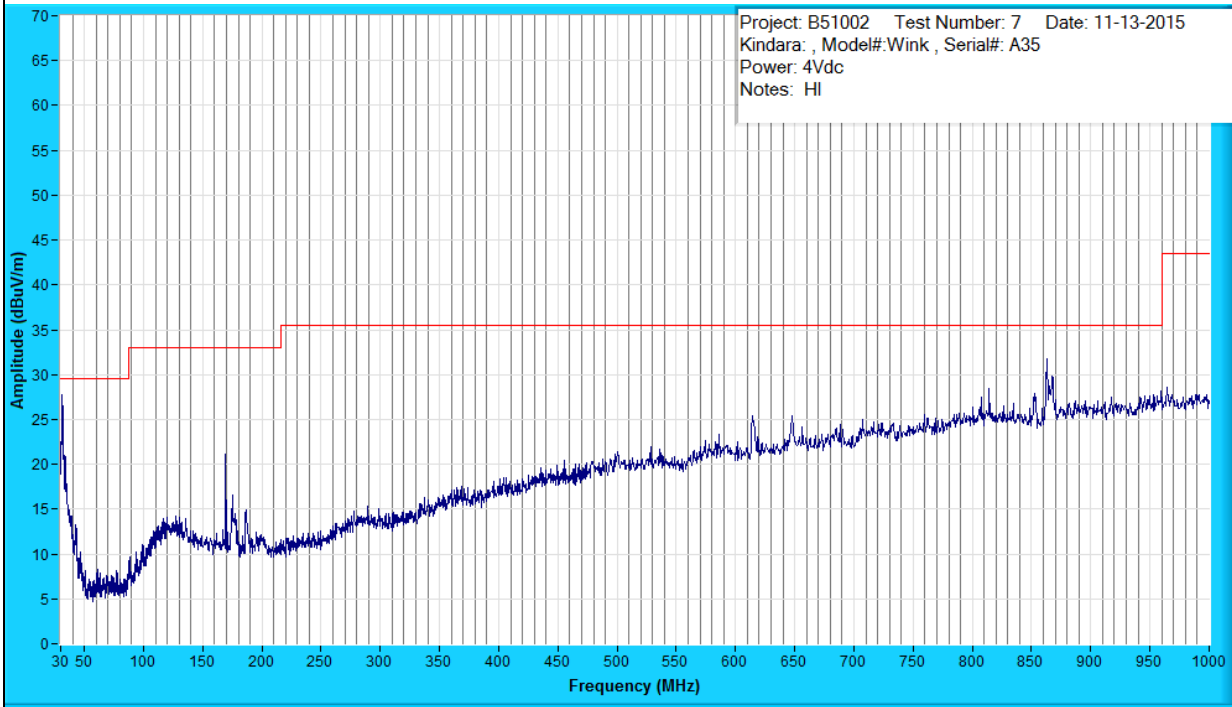

Type	Frequency (MHz)	Level (dBuV)	Transducer (dB/m)	Gain / Loss (dB)	Final (dBuV/m)	Azm(deg)/Pol/Hgt(m)	Margin: FCC Class B QP (dB)	Margin: FCC Class B AV (dB)
QP	31.225	37.3	20.2	-31.0	26.5	225/V-Pole/1.00	3.06	-
QP	169.143	24.7	11.8	-29.6	6.8	40/H-Pole/2.29	26.20	-
QP	175.177	31.7	11.4	-29.6	13.5	155/H-Pole/1.00	19.55	-
QP	614.306	33.7	18.6	-26.3	26.0	318/V-Pole/1.81	9.50	-
QP	814.517	24.4	21.5	-24.6	21.3	304/H-Pole/4.00	14.26	-
QP	863.259	30.1	21.6	-24.6	27.1	254/H-Pole/2.99	8.43	-

### Spurious Emissions, 1GHz – 18 GHz, Low

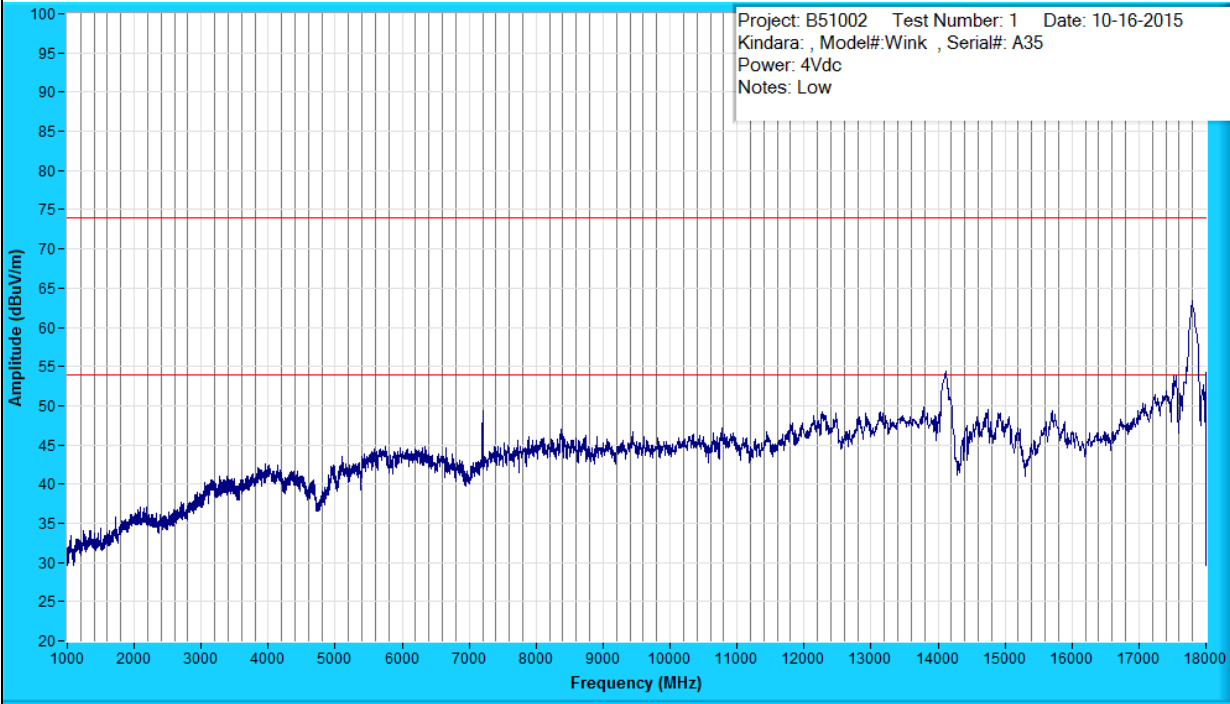

Type	Frequency (MHz)	Level (dBuV)	Transducer (dB/m)	Gain / Loss (dB)	Final (dBuV/m)	Azm(deg)/Pol/Hgt(m)	Margin: FCC Class B >1GHz PK (dB)	Margin: FCC Class B >1GHz AV (dB)
AV	7206.019	74.8	37.5	-68.7	43.5	45/V-Pole/2.89	-	10.42
PK	7206.019	80.7	37.5	-68.7	49.4	45/V-Pole/2.89	24.52	-
AV	14118.244	52.9	41.7	-51.3	43.3	180/V-Pole/3.96	-	10.69
PK	14118.244	65.7	41.7	-51.3	56.1	180/V-Pole/3.96	17.89	-
AV	17795.704	54.7	48.5	-51.4	51.7	135/H-Pole/2.00	-	2.21
PK	17795.704	68.7	48.5	-51.4	65.7	135/H-Pole/2.00	8.21	-

### Spurious Emissions, 1GHz – 18 GHz, Mid

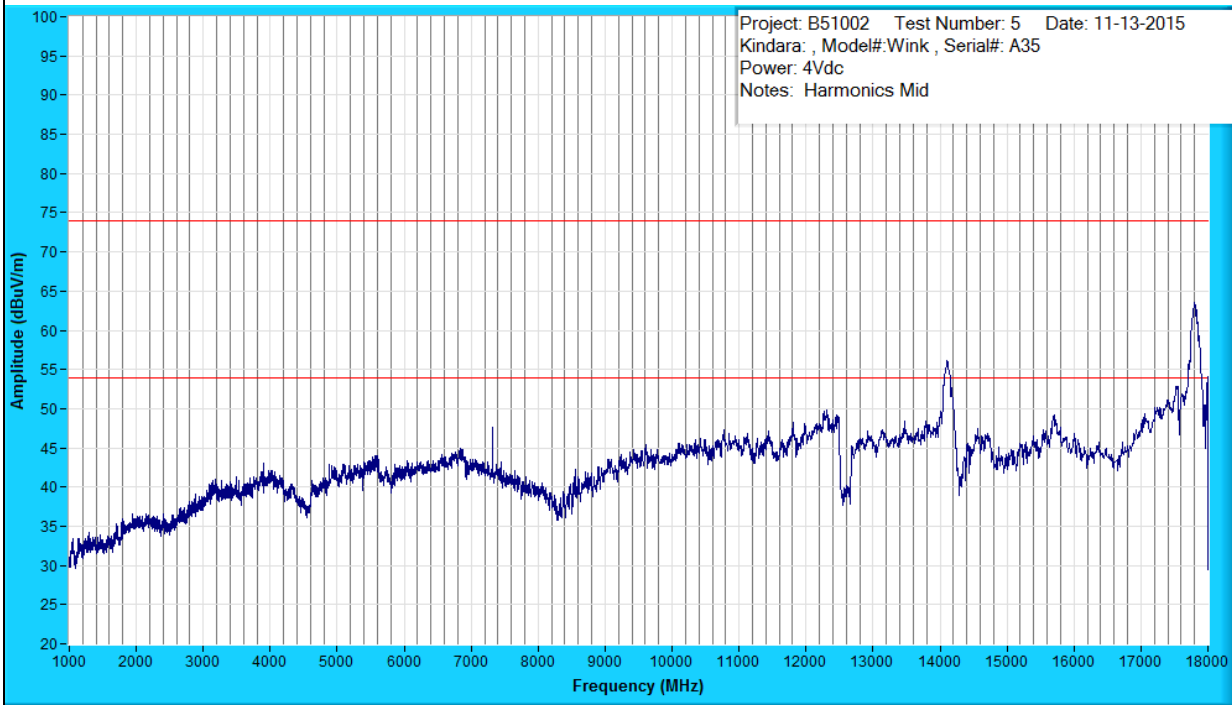

Type	Frequency (MHz)	Level (dBuV)	Transducer (dB/m)	Gain / Loss (dB)	Final (dBuV/m)	Azm(deg)/Pol/Hgt(m)	Margin: FCC Class B >1GHz PK (dB)	Margin: FCC Class B >1GHz AV (dB)
AV	7325.420	73.3	37.6	-69.2	41.8	112/V-Pole/1.36	-	12.16
PK	7325.420	82.5	37.6	-69.2	50.9	112/V-Pole/1.36	23.01	-
AV	14111.787	53.2	41.7	-51.2	43.7	45/H-Pole/2.01	-	10.27
PK	14111.787	66.3	41.7	-51.2	56.7	45/H-Pole/2.01	17.22	-
AV	17797.580	55.2	48.5	-51.2	52.5	202/V-Pole/1.00	-	1.42
PK	17797.580	68.8	48.5	-51.2	66.1	202/V-Pole/1.00	7.87	-

### Spurious Emissions, 1GHz – 18 GHz, High

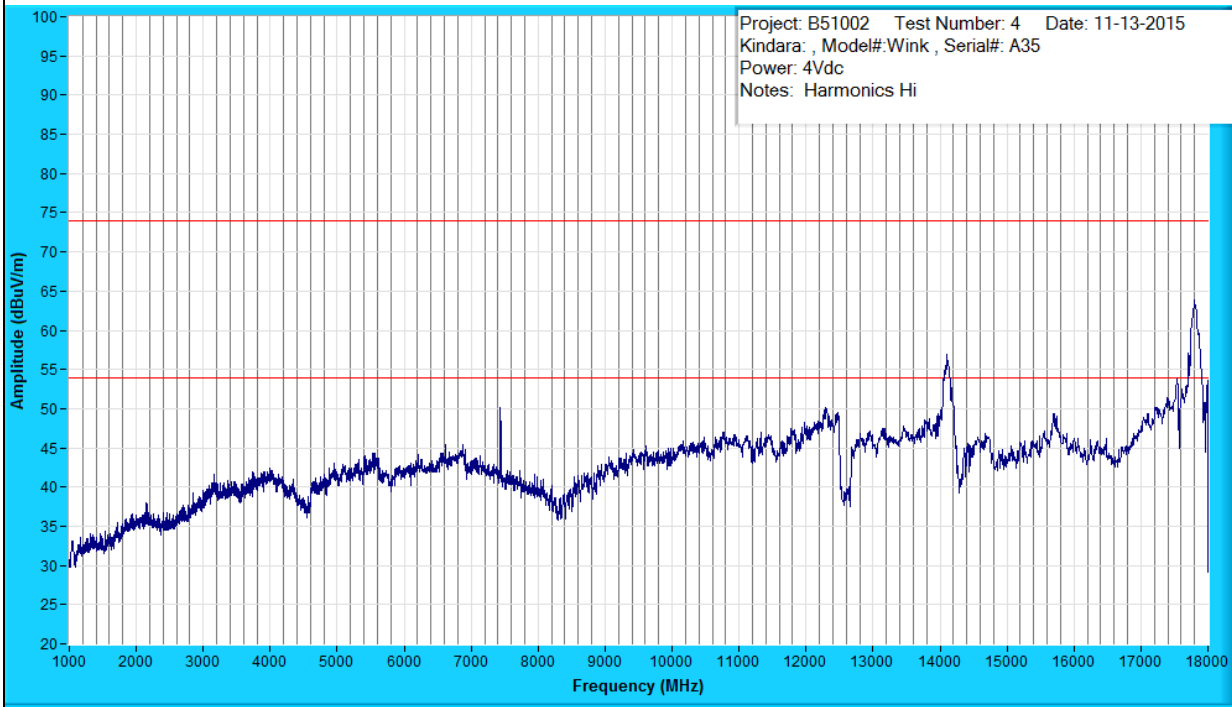

Type	Frequency (MHz)	Level (dBuV)	Transducer (dB/m)	Gain / Loss (dB)	Final (dBuV/m)	Azm(deg)/Pol/Hgt(m)	Margin: FCC Class B >1GHz PK (dB)	Margin: FCC Class B >1GHz AV (dB)
AV	7440.450	76.8	37.6	-69.1	45.2	89/H-Pole/1.11	-	8.76
PK	7440.450	84.3	37.6	-69.1	52.8	89/H-Pole/1.11	21.21	-
AV	14099.449	52.8	41.7	-51.2	43.3	225/V-Pole/2.01	-	10.70
PK	14099.449	66.0	41.7	-51.2	56.5	225/V-Pole/2.01	17.45	-
AV	17797.900	55.6	48.5	-51.2	53.0	0/V-Pole/2.01	-	0.97
PK	17797.900	68.8	48.5	-51.2	66.1	0/V-Pole/2.01	7.82	-

Spurious Emissions, 18 GHz – 25GHz, Low

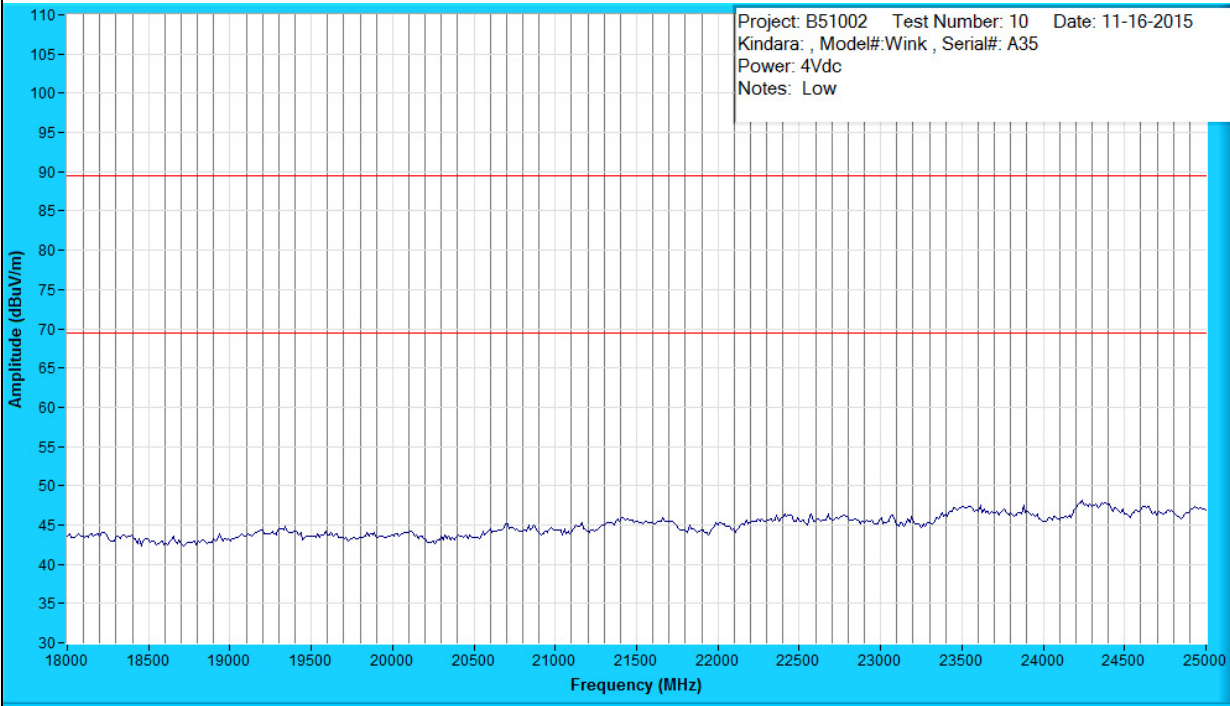

Type	Frequency (MHz)	Level (dBuV)	Transducer (dB/m)	Gain / Loss (dB)	Final (dBuV/m)	Azm(deg)/Pol/Hgt(m)	Margin: FCC Class A > 1GHz PK (dB)	Margin: FCC Class A > 1GHz AV (dB)

### Spurious Emissions, 18 GHz – 25GHz, Mid

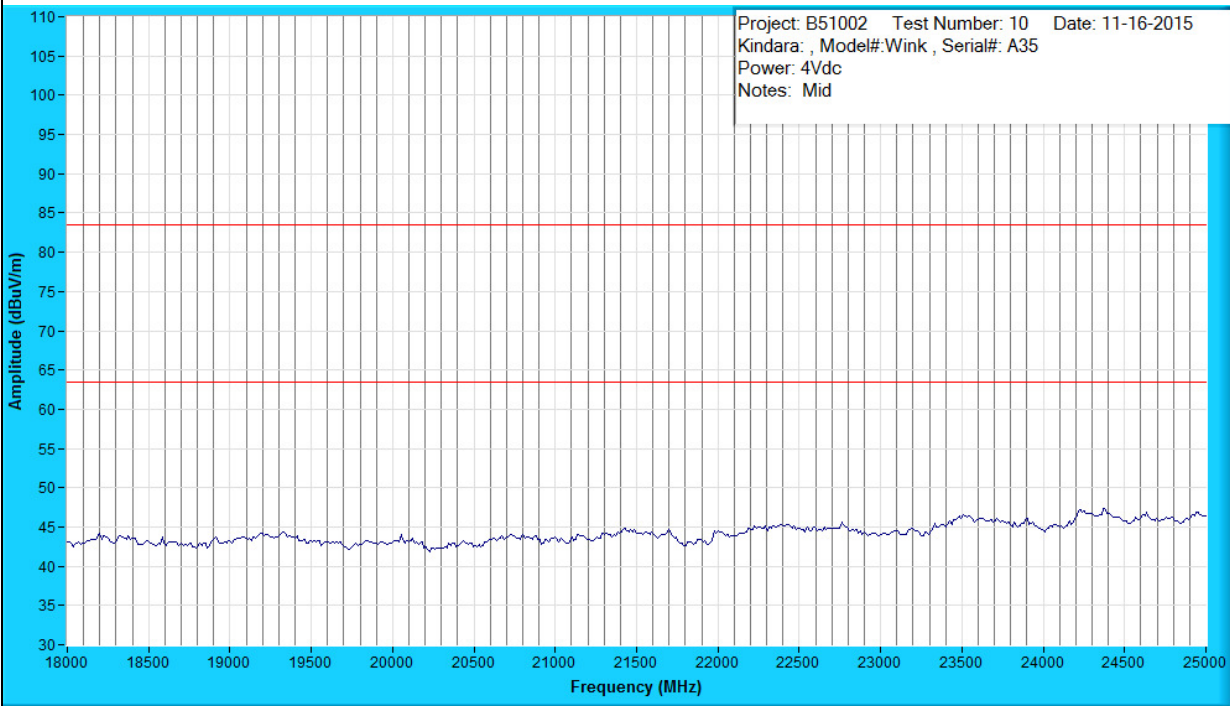

Type	Frequency (MHz)	Level (dBuV)	Transducer (dB/m)	Gain / Loss (dB)	Final (dBuV/m)	Azm(deg)/Pol/Hgt(m)	Margin: FCC Class B >1GHz PK (dB)	Margin: FCC Class B >1GHz AV (dB)

Spurious Emissions, 18 GHz – 25GHz, High

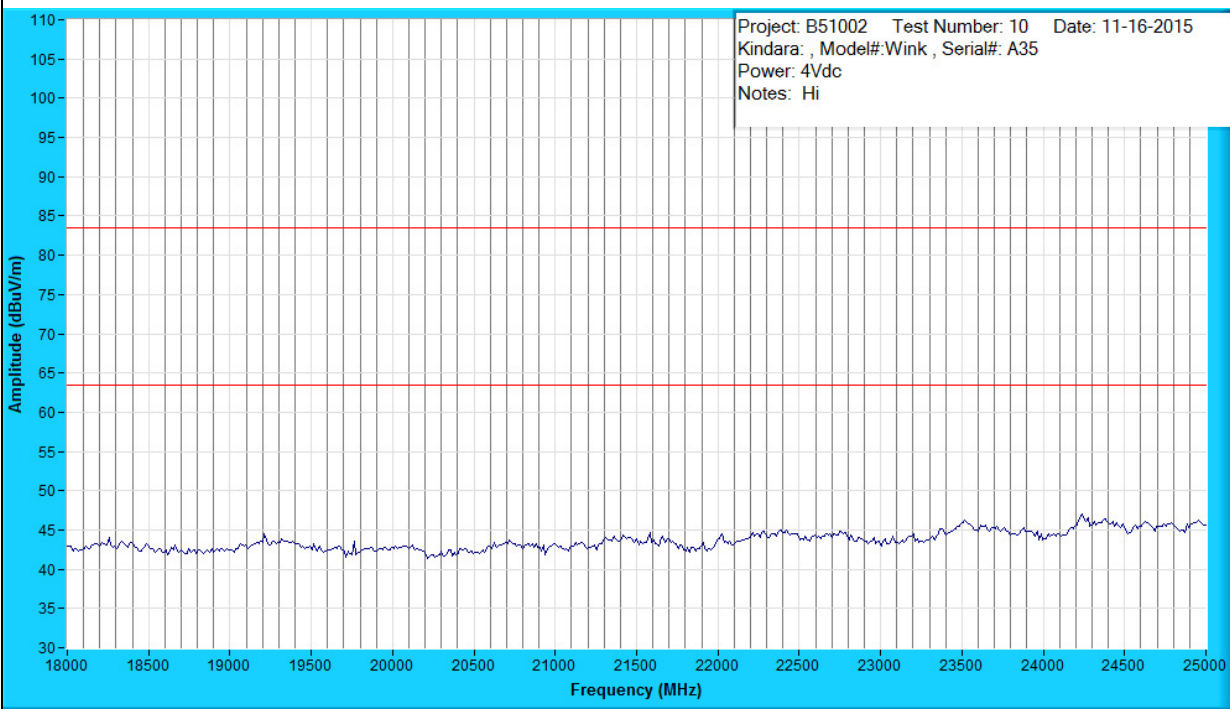

Type	Frequency (MHz)	Level (dBuV)	Transducer (dB/m)	Gain / Loss (dB)	Final (dBuV/m)	Azm(deg)/Pol/Hgt(m)	Margin: FCC Class B >1GHz PK (dB)	Margin: FCC Class B >1GHz AV (dB)

Tested by (+ signature) .....: Kevin Johnson.

## **Test Results – 99% Occupied Bandwidth**





99% BW – High

ATTEN 20dB  
RL 10.0dBm

5dB/

$\Delta$ MKR 1.17dB  
1.300MHz

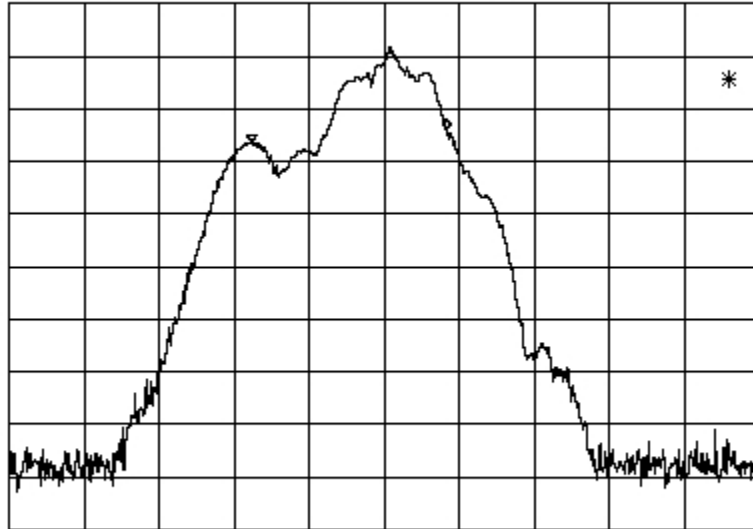

CENTER 2.480022GHz      SPAN 5.000MHz  
\*RBW 100kHz      VBW 300kHz      SWP 50.0ms

The 99% occupied BW for the highest frequency is 1.17 MHz.

Tested by (+ signature) .....

Kevin Johnson.

## Test Results – Band Edge

Table No. 4	<b>Band-Edge</b>	Verdict
		P

Frequency Range ..... : 2,402 MHz & 2,480 MHz      Test Location ..... : 10m Chamber #2  
 Test Method..... : ANSI C63.4 & ANSI C63.10  
 Test Distance ..... : N/A (conducted at antenna port)  
 EUT Configuration ..... : Transmit – low and high  
 Test Date ..... : 11-13-2015.  
 Temperature ..... : 21°C      Relative Humidity .... : 26 %  
 Test Equipment Asset Tag List : 1337, 1339, 1340, 1341, 1215, 1220, 1403, 1246, 1537, 1396, 1253, 1232, 1392

**Supplemental Information:**

Lower Band Edge

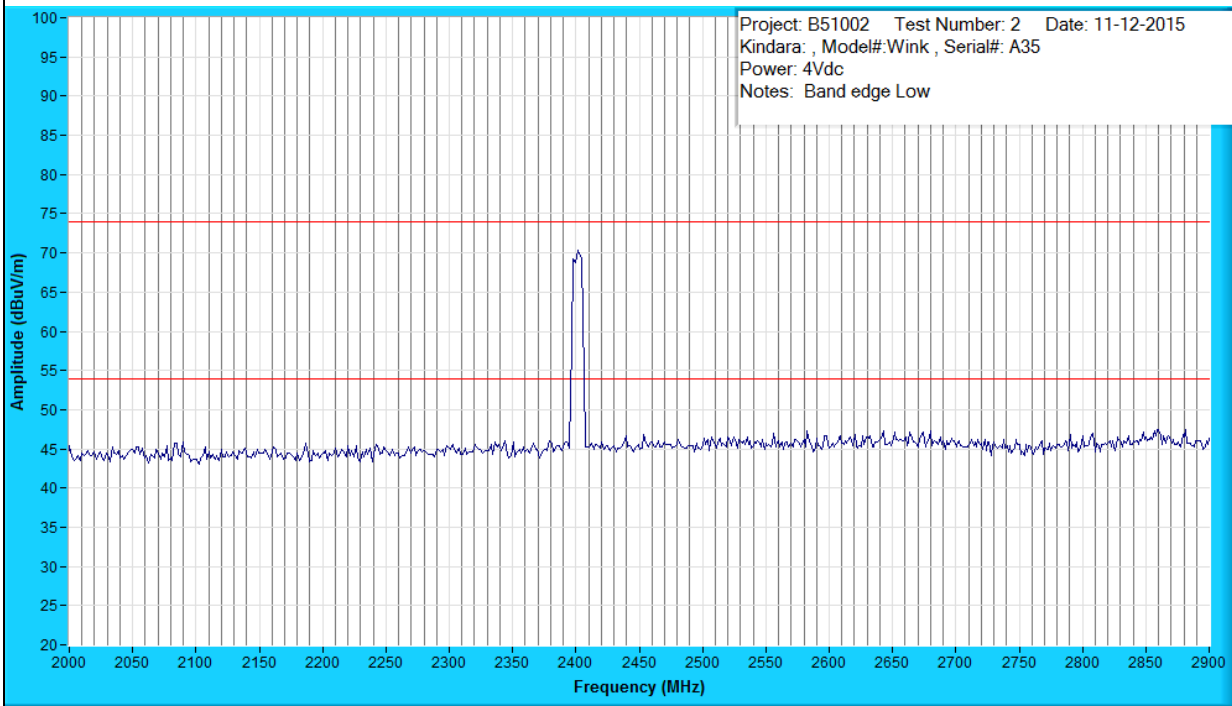

Type	Frequency (MHz)	Level (dBuV)	Transducer (dB/m)	Gain / Loss (dB)	Final (dBuV/m)	Azm(deg)/Pol/Hgt(m)	Margin: FCC Class B >1GHz PK (dB)	Margin: FCC Class B >1GHz AV (dB)
AV	2400.000	86.8	29.6	-66.7	49.7	359/V-Pole/1.02	-	4.30
AV	2399.000	73.2	29.6	-66.7	36.1	10/V-Pole/1.04	-	17.81
AV	2398.000	72.0	29.6	-66.7	34.9	20/V-Pole/1.79	-	19.02

### Upper Band Edge

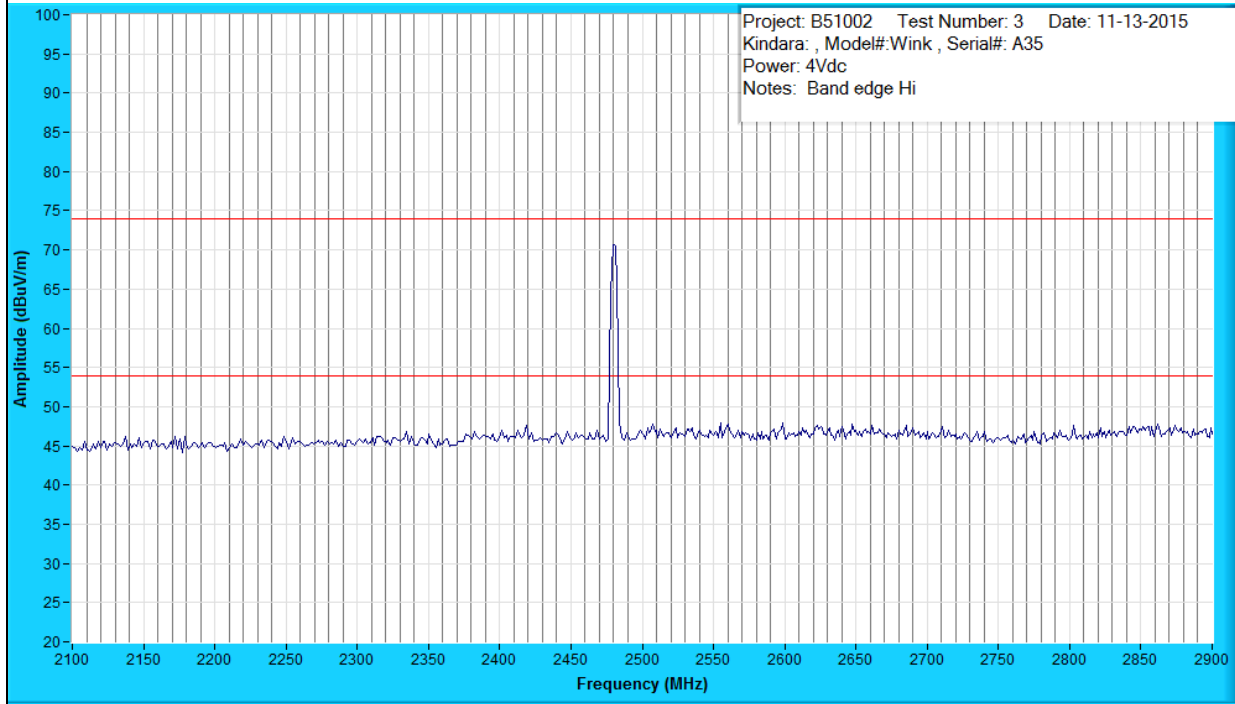

Type	Frequency (MHz)	Level (dBuV)	Transducer (dB/m)	Gain / Loss (dB)	Final (dBuV/m)	Azm(deg)/Pol/Hgt(m)	Margin: FCC Class B >1GHz PK (dB)	Margin: FCC Class B >1GHz AV (dB)
AV	2483.500	71.7	29.7	-66.6	34.7	85/V-Pole/1.00	-	19.27
AV	2484.500	71.6	29.7	-66.6	34.6	66/V-Pole/1.47	-	19.32
AV	2485.500	71.2	29.7	-66.6	34.2	74/V-Pole/1.45	-	19.72

Band-edge should be -20 dBc (peak) and -30 dBc (average), or must comply with the limits of 15.209 if they fall in a restricted band.

Average values for both lower and upper band-edge comply with the FCC 15.209 limits => Pass.

Tested by (+ signature) .....

Kevin Johnson.

## **Test Results – DTS – 6 dB Occupied Bandwidth**

Table No. 5	6 dB Bandwidth	Verdict
		P
Frequency Range ..... : 2,440 MHz <span style="float: right;">Test Location ..... : 10m Chamber #2</span>		
Test Method..... : ANSI C63.4 & ANSI C63.10		
Test Distance ..... : N/A (conducted at antenna port)		
EUT Configuration ..... : Transmit – low, mid and high		
Test Date ..... : 10-16-2015.		
Temperature ..... : 22°C <span style="float: right;">Relative Humidity .... : 24 %</span>		
Test Equipment Asset Tag List : 1337, 1339, 1340, 1341, 1215, 1220, 1403, 1246, 1537, 1396, 1253, 1232, 1392		

**Supplemental Information:**

6dB BW Low

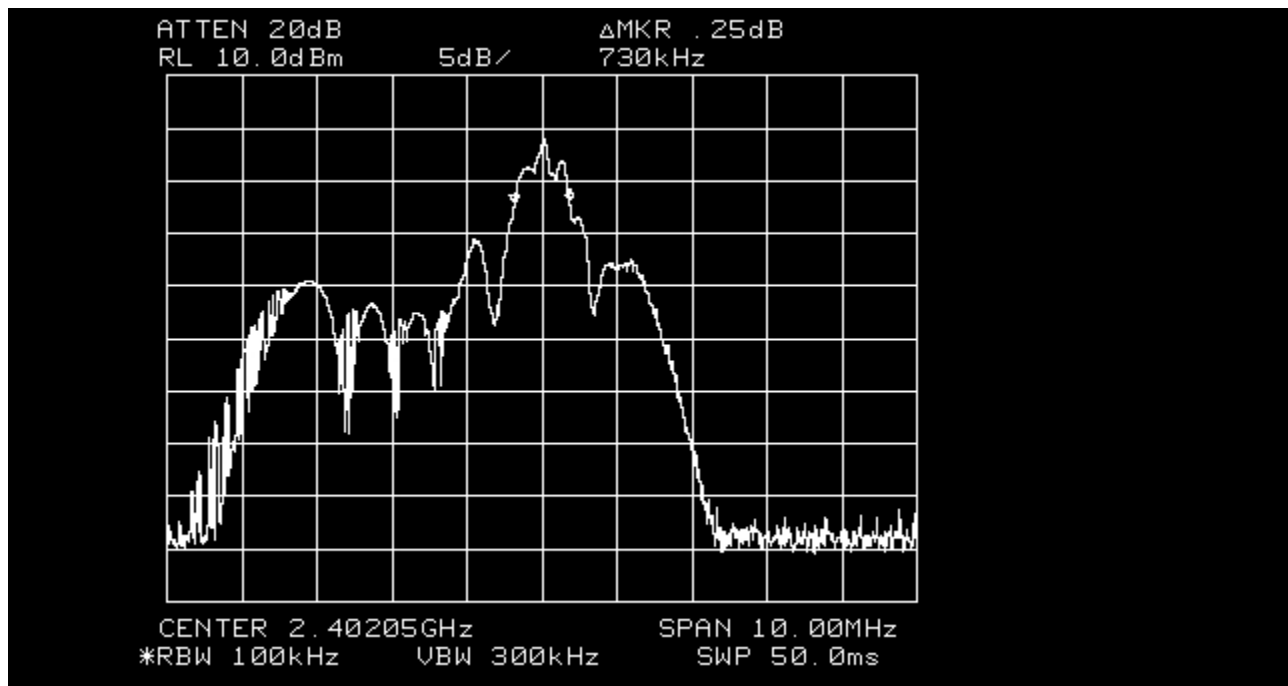

The 6 dB bandwidth for the low frequency is 730 kHz.





## **Test Results – DTS – Power Spectral Density**

Table No. 6	<b>Power Spectral Density</b>	Verdict
		P

Frequency Range ..... : 2,440 MHz                      Test Location ..... : 10m Chamber #2  
 Test Method..... : ANSI C63.4 & ANSI C63.10  
 Test Distance ..... : N/A (conducted at antenna port)  
 EUT Configuration ..... : Transmit – low, mid and high  
 Test Date ..... : 11-17-2015.  
 Temperature ..... : 22°C                                      Relative Humidity .... : 24 %  
 Test Equipment Asset Tag List : 1337, 1339, 1340, 1341, 1215, 1220, 1403, 1246, 1537, 1396, 1253, 1232, 1392

**Supplemental Information:**

Radiated Peak Power Spectral Density, Low

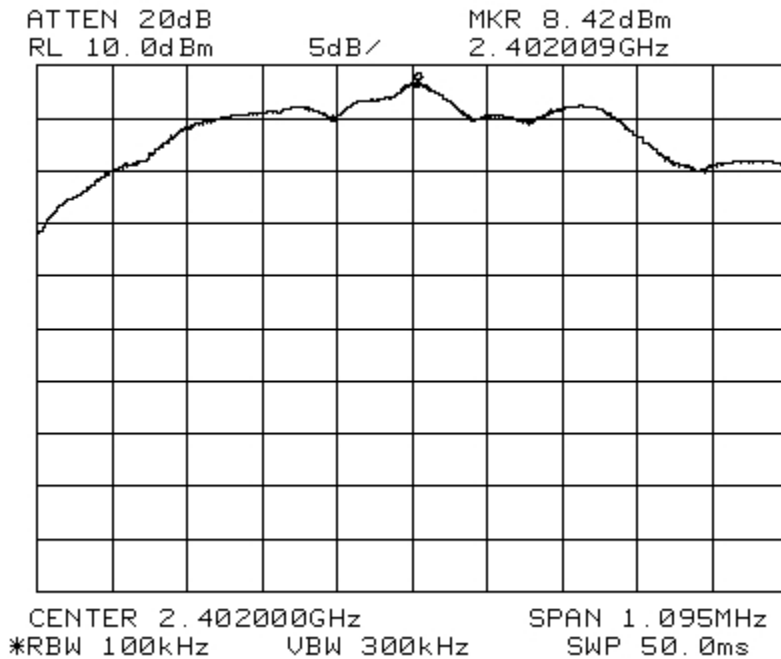



Radiated Peak Power Spectral Density, High

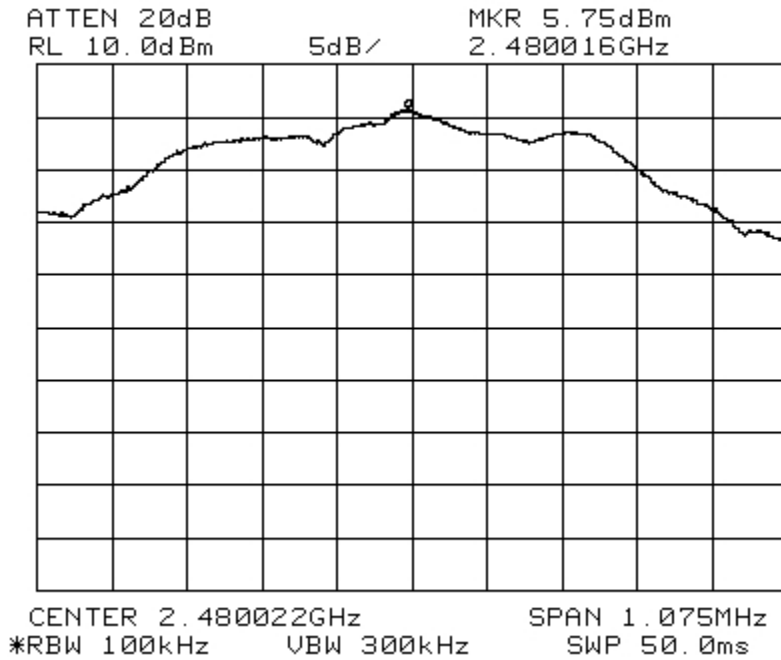

PSD limit is 8 dBm using a 3 kHz minimum bandwidth.

This was a radiated measurement. To convert to the power being delivered to the Tx antenna, the following calculation was performed:

Power Spectral Density

Frequency (MHz)	P <sub>meas</sub> Meter reading (dBm)	G <sub>R</sub> RX antenna gain (dBi)	L <sub>C</sub> Cable loss (dB)	G <sub>amp</sub> Pre-amp Gain (dB)	P <sub>R</sub> Adjusted RX Power (dBm)	L <sub>P</sub> Free-space propagation loss (dB)	EIRP (dBm)	G <sub>T</sub> TX antenna gain (dBi)	P <sub>T</sub> Transmit power at antenna port (dBm)	P <sub>T</sub> Transmit power at antenna port (mW)
2402.000	8.4	8.3	20.1	77.0	-56.8	49.7	-7.1	2.0	-9.1	0.122
2442.000	7.7	8.3	20.1	77.0	-57.5	49.8	-7.7	2.0	-9.7	0.106
2480.000	5.8	8.3	20.1	76.9	-59.4	49.9	-9.4	2.0	-11.4	0.072

The max PSD was -9.1 dB (using a 100 kHz RBW) => Pass.

Tested by (+ signature) .....

Kevin Johnson.

## **Test Results – DTS – RF Power Output**

Table No. 7	<b>RF Power Output</b>	Verdict
		P

Frequency Range ..... : 2,402 to 2,480 MHz                      Test Location ..... : 10m Chamber #2  
 Test Method..... : ANSI C63.4 & ANSI C63.10  
 Test Distance ..... : 3 meters  
 EUT Configuration ..... : Transmit – low, mid and high  
 Test Date ..... : 10-16-2015.  
 Temperature ..... : 22°C    Relative Humidity .... : 24 %  
 Test Equipment Asset Tag List : 1337, 1339, 1340, 1341, 1215, 1220, 1403, 1246, 1537, 1396, 1253, 1232, 1392

**Supplemental Information:**

Peak Power Low

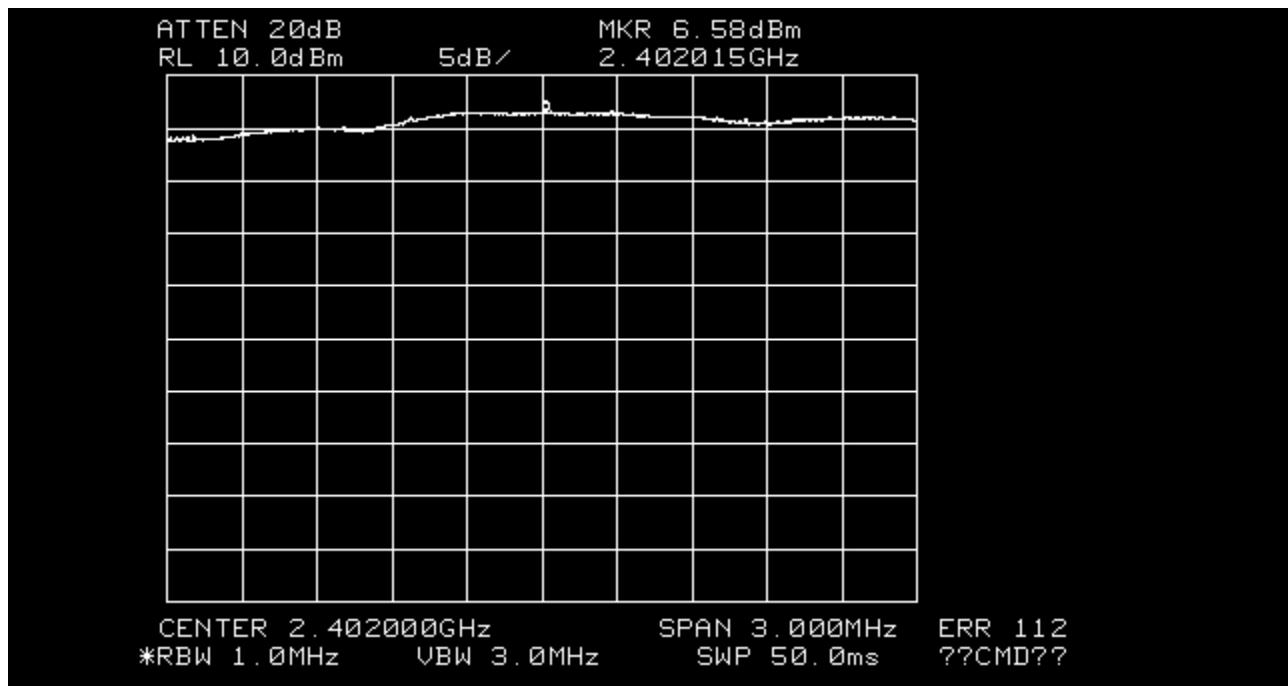

### Peak Power MID

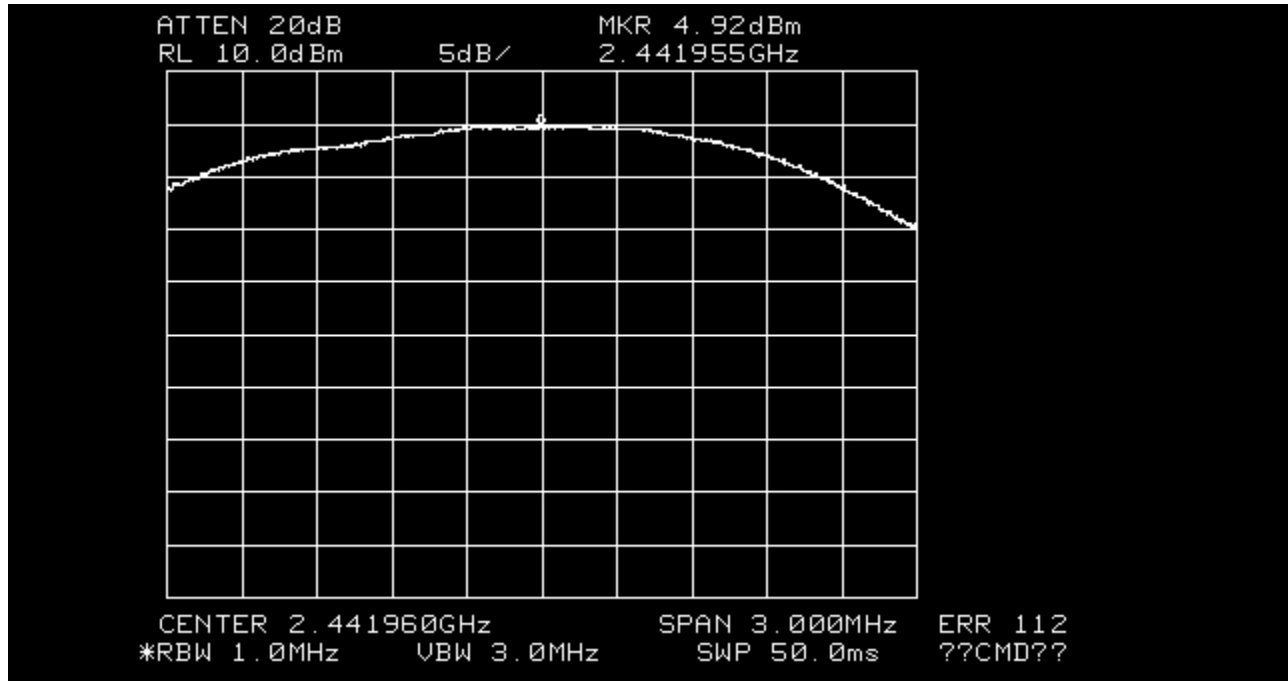

Peak Power High

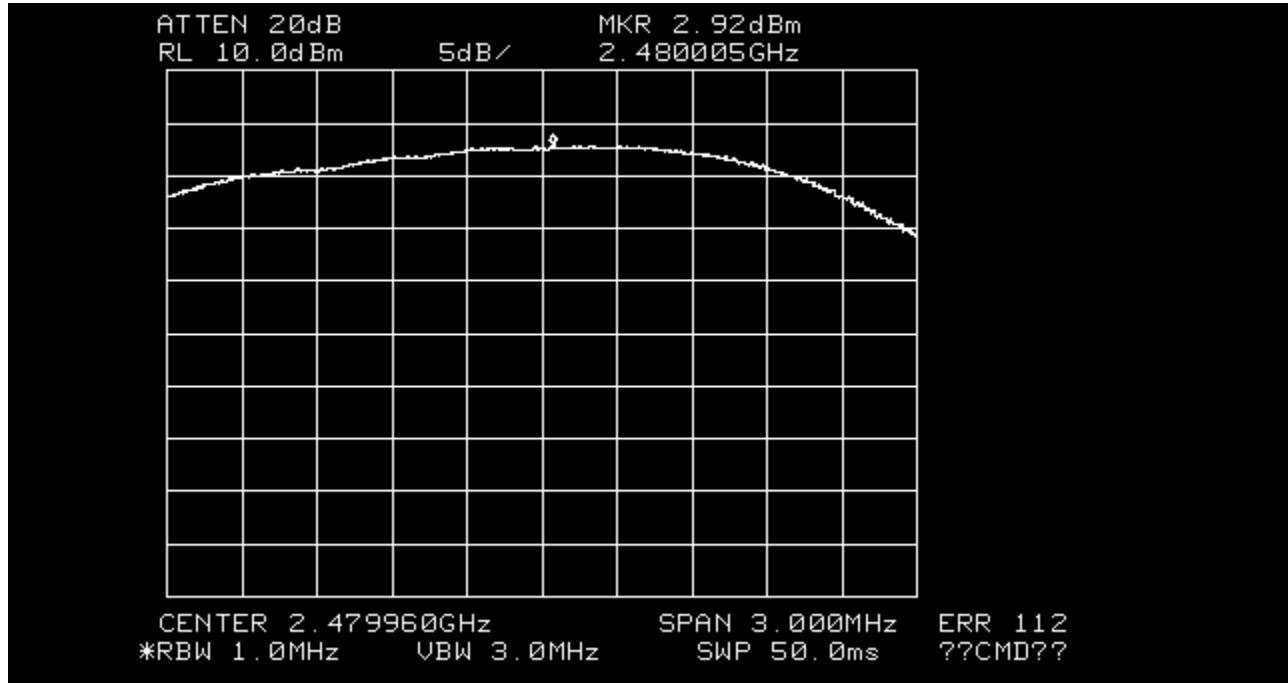

Peak Power

Frequency (MHz)	P <sub>meas</sub> Meter reading (dBm)	G <sub>R</sub> RX antenna gain (dBi)	L <sub>C</sub> Cable loss (dB)	G <sub>amp</sub> Pre-amp Gain (dB)	P <sub>R</sub> Adjusted RX Power (dBm)	L <sub>P</sub> Free-space propagation loss (dB)	EIRP (dBm)	G <sub>T</sub> TX antenna gain (dBi)	P <sub>T</sub> Transmit power at antenna port (dBm)	P <sub>T</sub> Transmit power at antenna port (mW)
2402.000	6.6	8.3	20.1	77.0	-58.6	49.7	-9.0	2.0	-11.0	0.080
2442.000	4.9	8.3	20.1	77.0	-60.3	49.8	-10.5	2.0	-12.5	0.056
2480.000	2.9	8.3	20.1	76.9	-62.2	49.9	-12.2	2.0	-14.2	0.038

Tested by (+ signature) .....

Kevin Johnson.

## **Test Results – DTS – Spurious Emissions, Restricted Bands**

Table No. 8	<b>Spurious Emissions, Restricted Bands</b>	Verdict
		P

Frequency Range ..... : 30 kHz to 25 GHz                      Test Location ..... : 10m Chamber #2  
 Test Method..... : ANSI C63.4 & ANSI C63.10  
 Test Distance ..... : 10 m (30 kHz to 1 GHz); 3 m (1-18 GHz); 1 m (18-25 GHz)  
 EUT Configuration ..... : See individual plots for antenna, modulation and channel details  
 Test Date ..... : 11-16-2015.  
 Temperature ..... : 22°C    Relative Humidity .... : 24 %  
 Test Equipment Asset Tag List : 1337, 1339, 1340, 1341, 1215, 1220, 1403, 1246, 1537, 1396, 1253, 1232, 1392

**Supplemental Information:**

**Spurious Emissions, 30 kHz – 30 MHz low**

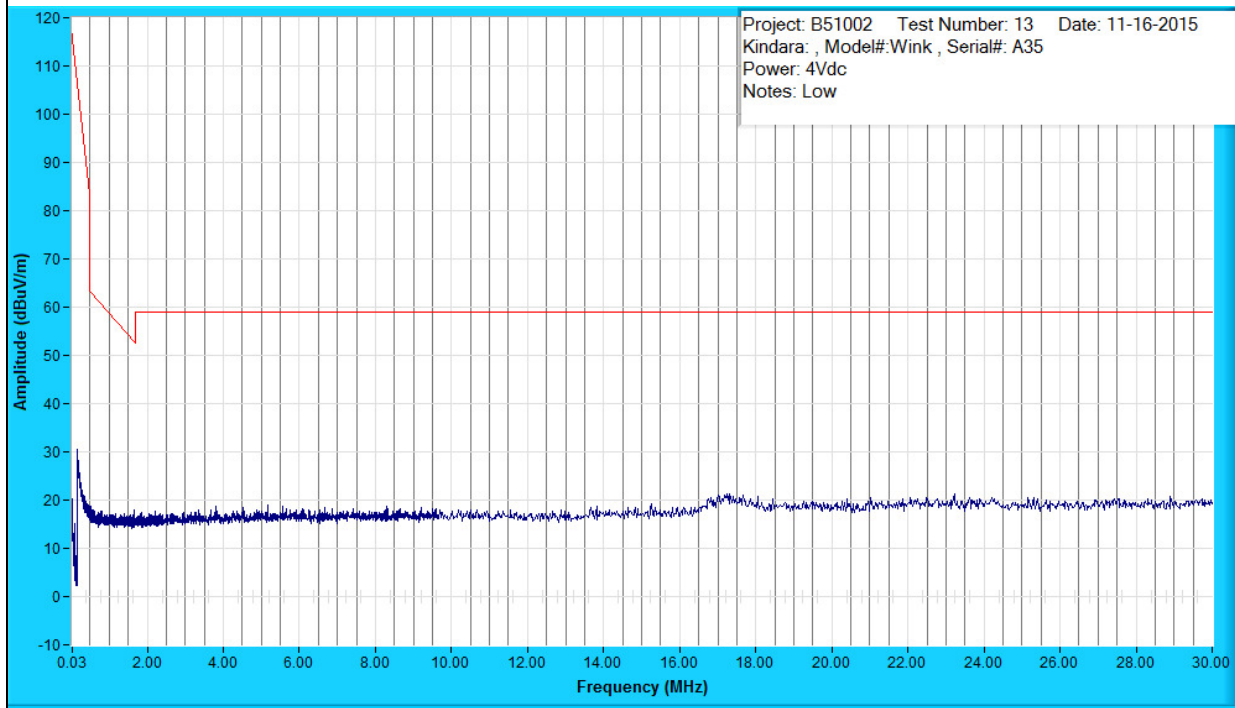

Type	Frequency (MHz)	Level (dBuV)	Transducer (dB/m)	Gain / Loss (dB)	Final (dBuV/m)	Azm(deg)/Pol/Hgt(m)	Margin: FCC Part 15 Low Freq AV (dB)
AV	0.150	1.9	3.9	0.0	5.7	225/V-Pole/1.02	102.21
QP	0.150	-4.8	3.9	0.0	-0.9	225/V-Pole/1.02	-
PK	0.150	2.6	3.9	0.0	6.5	225/V-Pole/1.02	101.46

Spurious Emissions, 30 kHz – 30 MHz Mid

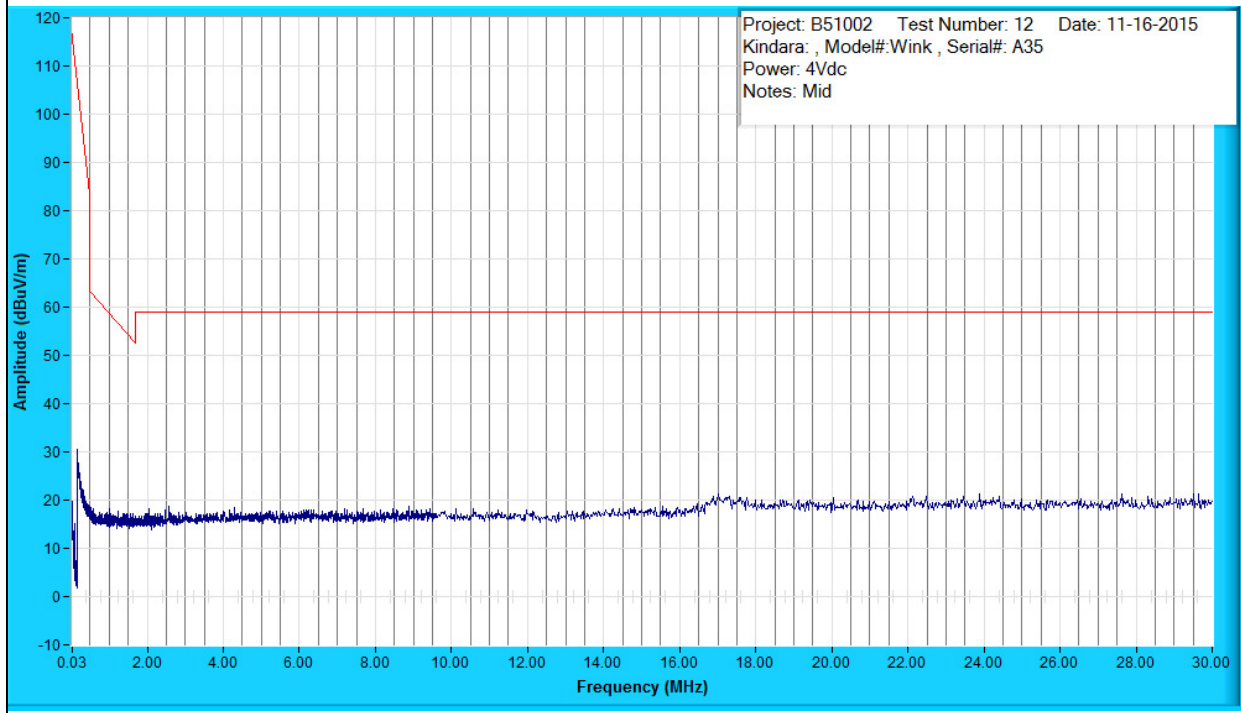

Type	Frequency (MHz)	Level (dBuV)	Transducer (dB/m)	Gain / Loss (dB)	Final (dBuV/m)	Azm(deg)/Pol/Hgt(m)	Margin: FCC Part 15 Low Freq AV (dB)
QP	0.151	24.4	3.9	0.0	28.2	90/H-Pole/1.02	-
AV	0.151	23.8	3.9	0.0	27.7	90/H-Pole/1.02	80.13
PK	0.151	27.9	3.9	0.0	31.8	90/H-Pole/1.02	76.03

Spurious Emissions, 30 kHz – 30 MHz High

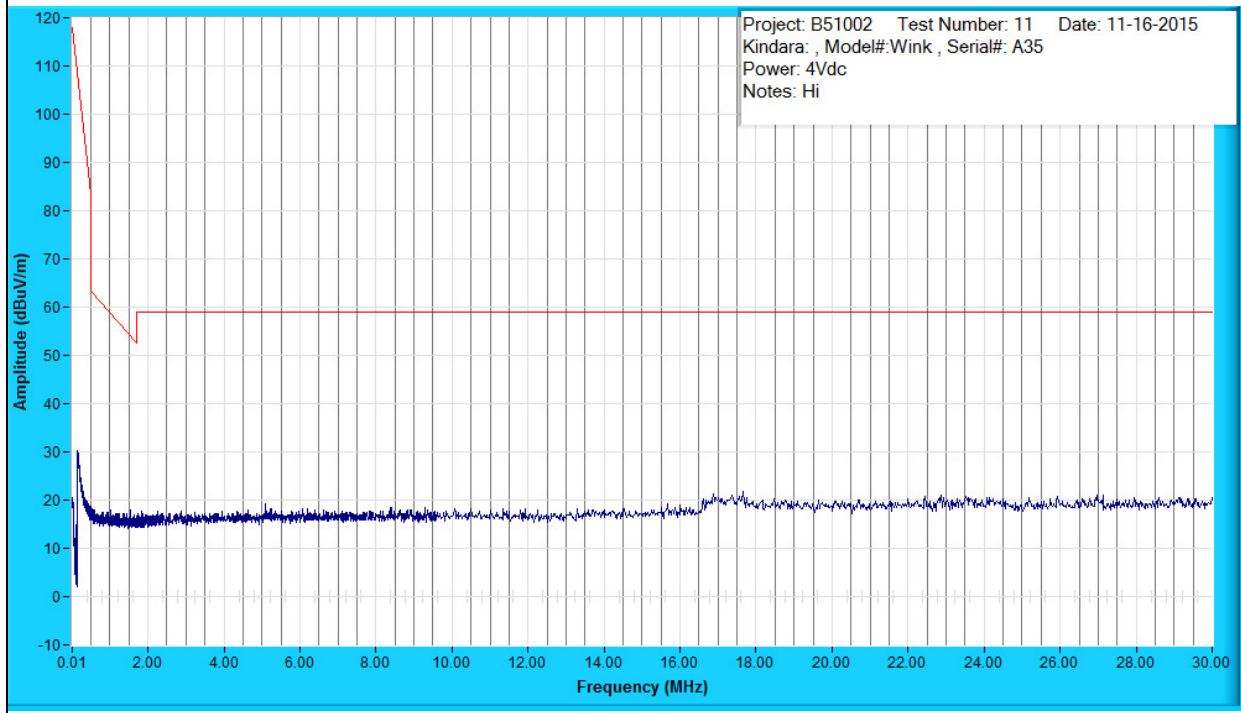

Type	Frequency (MHz)	Level (dBuV)	Transducer (dB/m)	Gain / Loss (dB)	Final (dBuV/m)	Azm(deg)/Pol/Hgt(m)	Margin: FCC Part 15 Low Freq AV (dB)
QP	0.154	24.2	3.8	0.0	28.0	315/H-Pole/1.02	-
PK	0.154	27.4	3.8	0.0	31.2	315/H-Pole/1.02	76.39

### Spurious Emissions, 30 MHz – 1GHz, Low

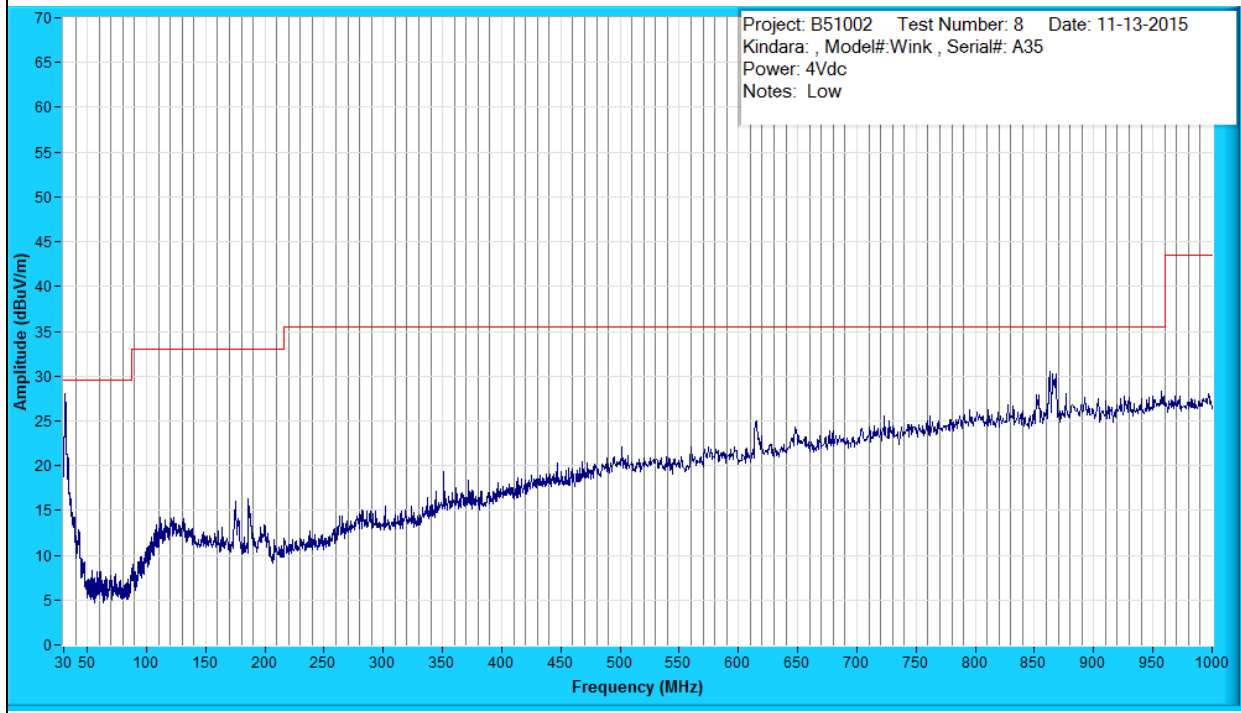

Type	Frequency (MHz)	Level (dBuV)	Transducer (dB/m)	Gain / Loss (dB)	Final (dBuV/m)	Azm(deg)/Pol/Hgt(m)	Margin: FCC Class B QP (dB)	Margin: FCC Class B AV (dB)
QP	31.324	37.6	20.0	-31.0	26.6	56/V-Pole/1.01	2.91	-
QP	175.292	31.7	11.5	-29.6	13.6	139/H-Pole/1.01	19.45	-
QP	186.295	32.6	11.4	-29.5	14.5	275/H-Pole/1.03	18.50	-
QP	614.328	33.4	18.9	-26.3	26.0	338/V-Pole/1.75	9.53	-
QP	852.455	29.4	21.5	-24.6	26.3	158/V-Pole/3.98	9.21	-
QP	863.223	32.7	21.9	-24.6	30.0	261/H-Pole/2.82	5.51	-

Spurious Emissions, 30 MHz – 1GHz, Mid

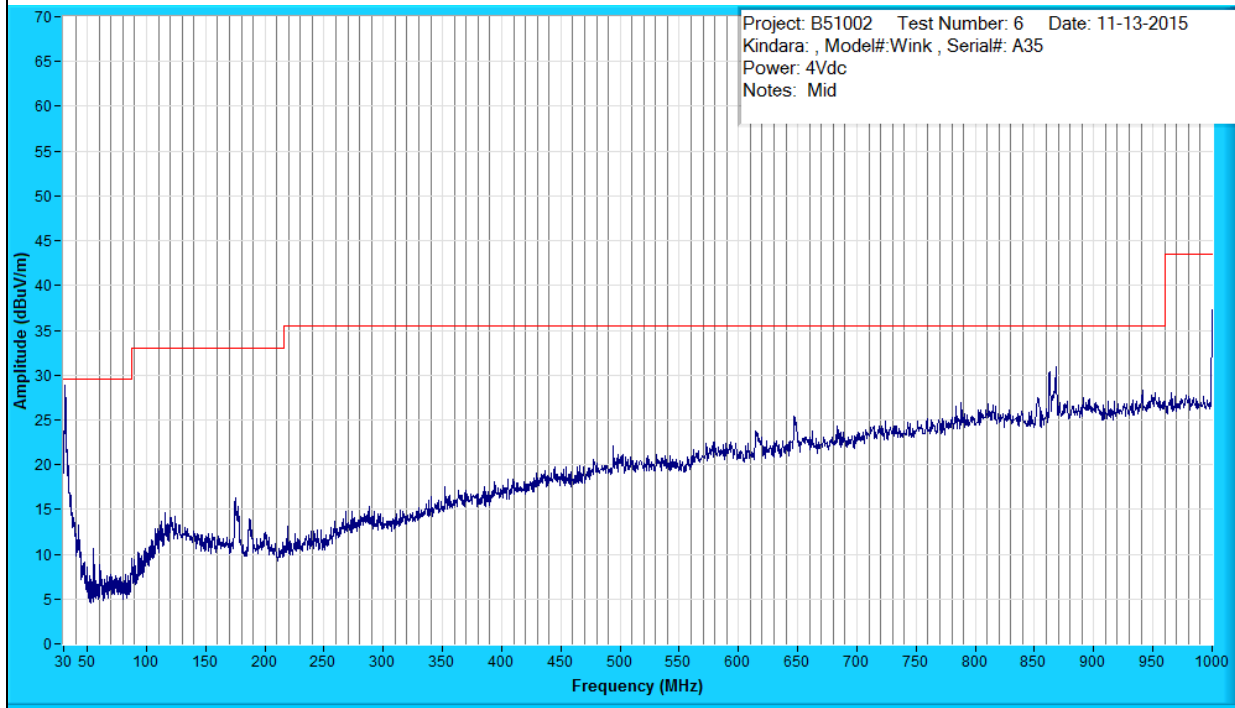

Type	Frequency (MHz)	Level (dBuV)	Transducer (dB/m)	Gain / Loss (dB)	Final (dBuV/m)	Azm(deg)/Pol/Hgt(m)	Margin: FCC Class B QP (dB)	Margin: FCC Class B AV (dB)
QP	31.306	37.0	20.1	-31.0	26.1	1/V-Pole/1.01	3.48	-
QP	175.255	31.3	11.4	-29.6	13.0	147/H-Pole/1.00	20.01	-
QP	647.744	28.6	19.6	-26.0	22.2	284/V-Pole/1.00	13.37	-
QP	862.605	32.5	21.6	-24.6	29.4	280/V-Pole/2.76	6.10	-
QP	867.641	28.4	22.0	-24.6	25.8	11/V-Pole/2.78	9.79	-
QP	997.120	23.7	23.0	-23.9	22.8	87/H-Pole/1.02	20.63	-

### Spurious Emissions, 30 MHz – 1GHz, High

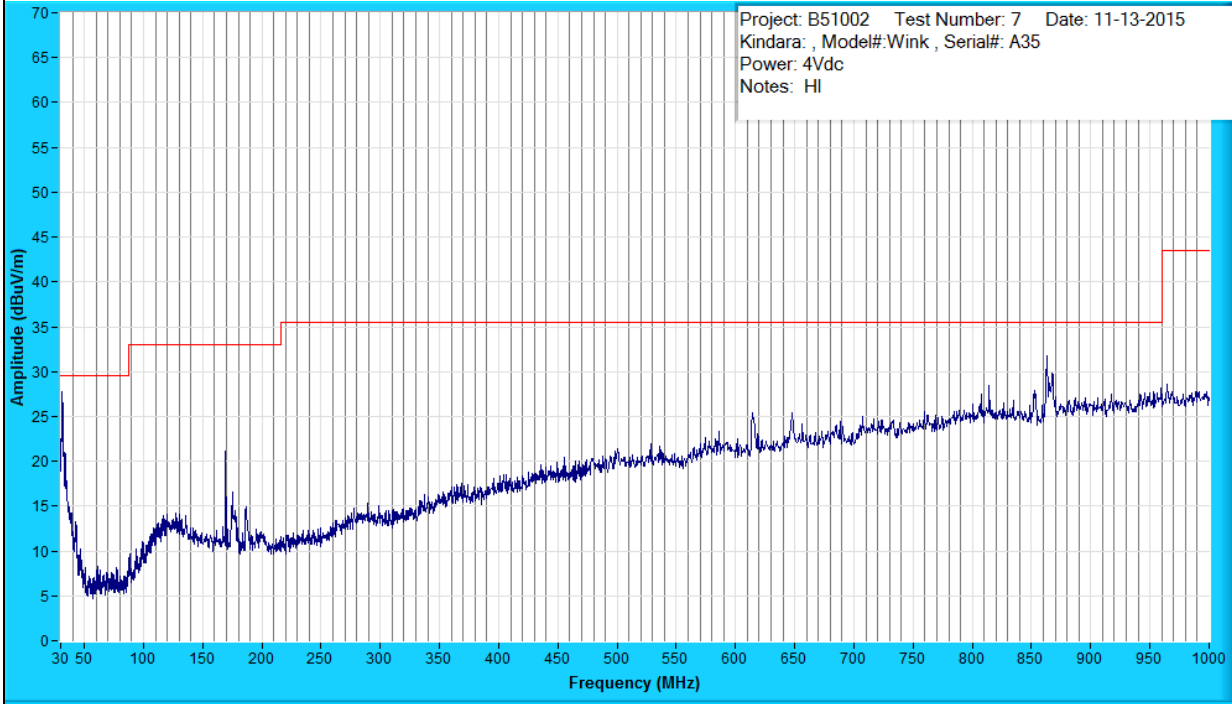

Type	Frequency (MHz)	Level (dBuV)	Transducer (dB/m)	Gain / Loss (dB)	Final (dBuV/m)	Azm(deg)/Pol/Hgt(m)	Margin: FCC Class B QP (dB)	Margin: FCC Class B AV (dB)
QP	31.225	37.3	20.2	-31.0	26.5	225/V-Pole/1.00	3.06	-
QP	169.143	24.7	11.8	-29.6	6.8	40/H-Pole/2.29	26.20	-
QP	175.177	31.7	11.4	-29.6	13.5	155/H-Pole/1.00	19.55	-
QP	614.306	33.7	18.6	-26.3	26.0	318/V-Pole/1.81	9.50	-
QP	814.517	24.4	21.5	-24.6	21.3	304/H-Pole/4.00	14.26	-
QP	863.259	30.1	21.6	-24.6	27.1	254/H-Pole/2.99	8.43	-

### Spurious Emissions, 1GHz – 18 GHz, Low

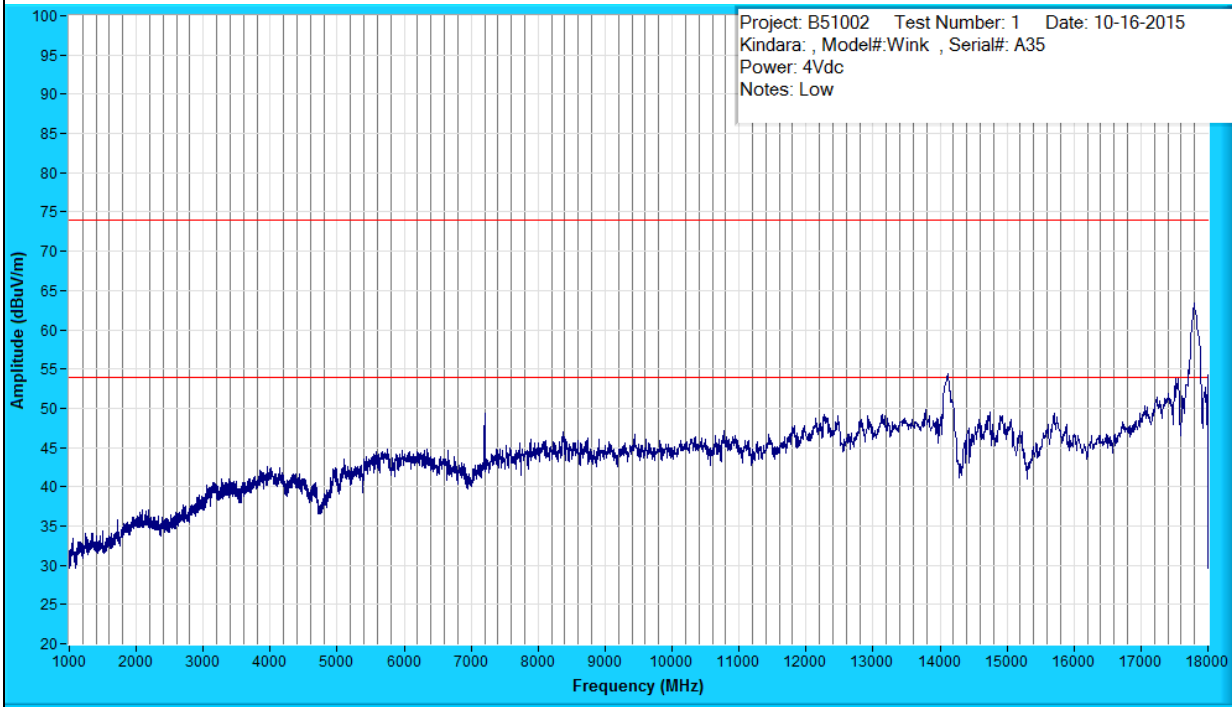

Type	Frequency (MHz)	Level (dBuV)	Transducer (dB/m)	Gain / Loss (dB)	Final (dBuV/m)	Azm(deg)/Pol/Hgt(m)	Margin: FCC Class B >1GHz PK (dB)	Margin: FCC Class B >1GHz AV (dB)
AV	7206.019	74.8	37.5	-68.7	43.5	45/V-Pole/2.89	-	10.42
PK	7206.019	80.7	37.5	-68.7	49.4	45/V-Pole/2.89	24.52	-
AV	14118.244	52.9	41.7	-51.3	43.3	180/V-Pole/3.96	-	10.69
PK	14118.244	65.7	41.7	-51.3	56.1	180/V-Pole/3.96	17.89	-
AV	17795.704	54.7	48.5	-51.4	51.7	135/H-Pole/2.00	-	2.21
PK	17795.704	68.7	48.5	-51.4	65.7	135/H-Pole/2.00	8.21	-

### Spurious Emissions, 1GHz – 18 GHz, Mid

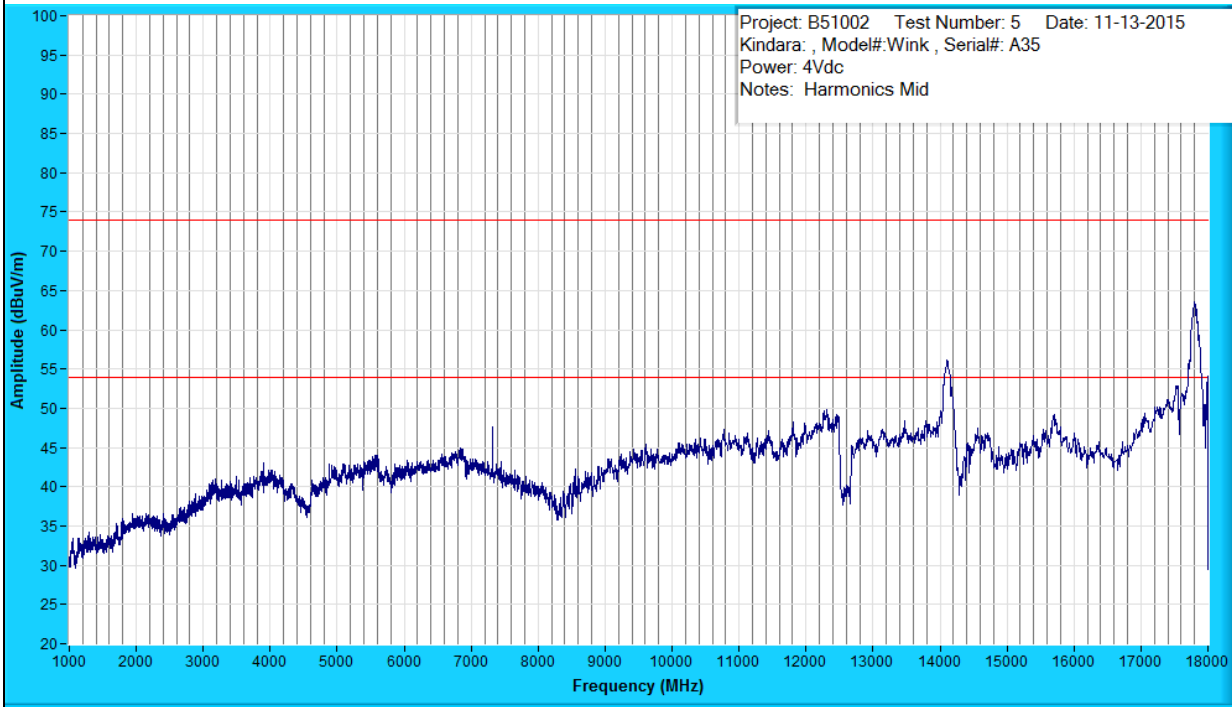

Type	Frequency (MHz)	Level (dBuV)	Transducer (dB/m)	Gain / Loss (dB)	Final (dBuV/m)	Azm(deg)/Pol/Hgt(m)	Margin: FCC Class B >1GHz PK (dB)	Margin: FCC Class B >1GHz AV (dB)
AV	7325.420	73.3	37.6	-69.2	41.8	112/V-Pole/1.36	-	12.16
PK	7325.420	82.5	37.6	-69.2	50.9	112/V-Pole/1.36	23.01	-
AV	14111.787	53.2	41.7	-51.2	43.7	45/H-Pole/2.01	-	10.27
PK	14111.787	66.3	41.7	-51.2	56.7	45/H-Pole/2.01	17.22	-
AV	17797.580	55.2	48.5	-51.2	52.5	202/V-Pole/1.00	-	1.42
PK	17797.580	68.8	48.5	-51.2	66.1	202/V-Pole/1.00	7.87	-

### Spurious Emissions, 1GHz – 18 GHz, High

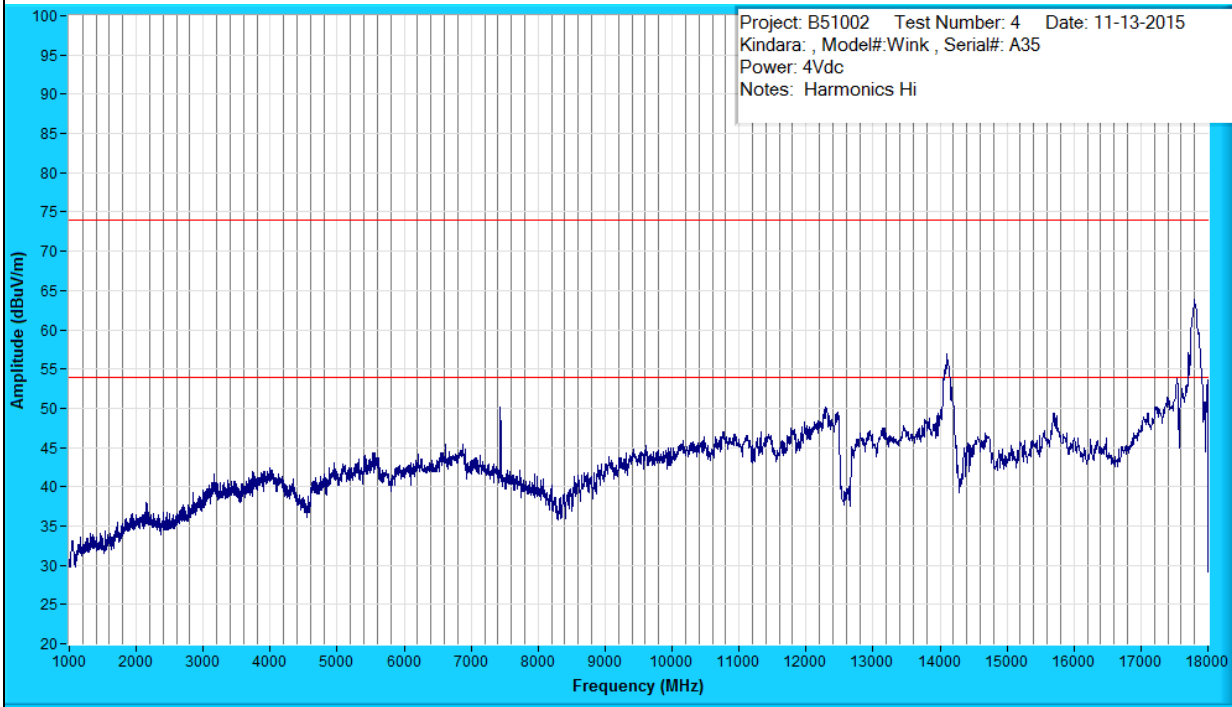

Type	Frequency (MHz)	Level (dBuV)	Transducer (dB/m)	Gain / Loss (dB)	Final (dBuV/m)	Azm(deg)/Pol/Hgt(m)	Margin: FCC Class B >1GHz PK (dB)	Margin: FCC Class B >1GHz AV (dB)
AV	7440.450	76.8	37.6	-69.1	45.2	89/H-Pole/1.11	-	8.76
PK	7440.450	84.3	37.6	-69.1	52.8	89/H-Pole/1.11	21.21	-
AV	14099.449	52.8	41.7	-51.2	43.3	225/V-Pole/2.01	-	10.70
PK	14099.449	66.0	41.7	-51.2	56.5	225/V-Pole/2.01	17.45	-
AV	17797.900	55.6	48.5	-51.2	53.0	0/V-Pole/2.01	-	0.97
PK	17797.900	68.8	48.5	-51.2	66.1	0/V-Pole/2.01	7.82	-

Spurious Emissions, 18 GHz – 25GHz, Low

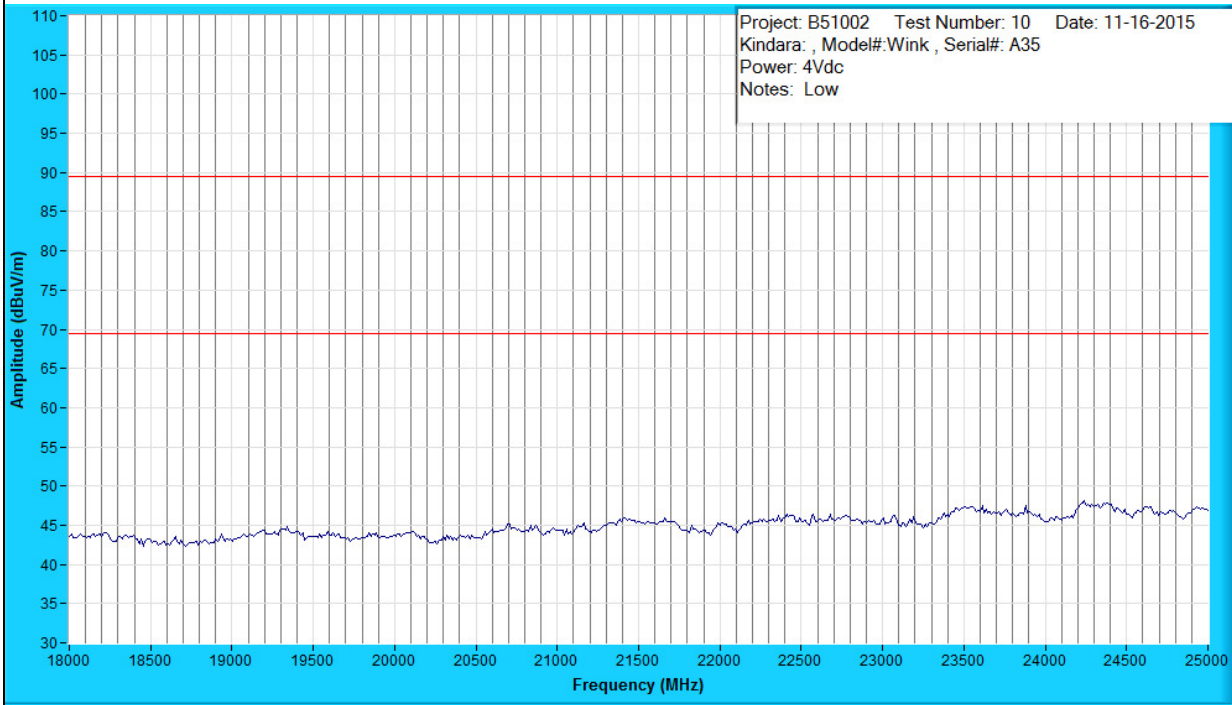

Type	Frequency (MHz)	Level (dBuV)	Transducer (dB/m)	Gain / Loss (dB)	Final (dBuV/m)	Azm(deg)/Pol/Hgt(m)	Margin: FCC Class A > 1GHz PK (dB)	Margin: FCC Class A > 1GHz AV (dB)

### Spurious Emissions, 18 GHz – 25GHz, Mid

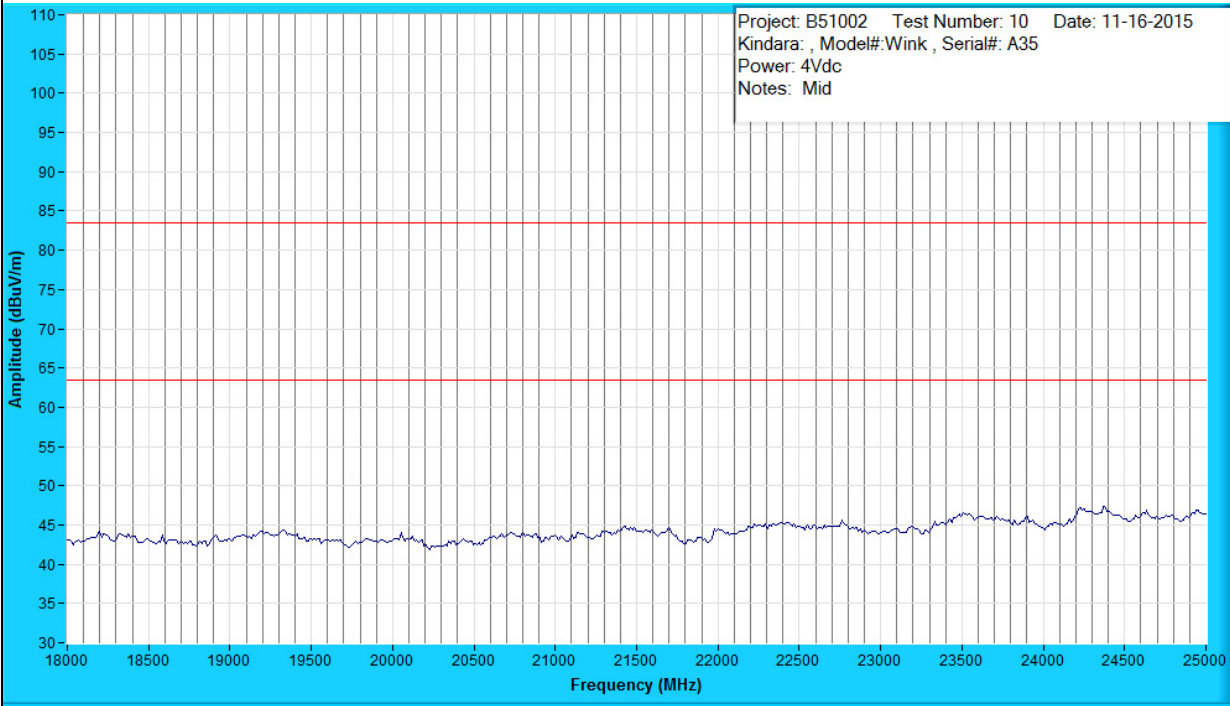

Type	Frequency (MHz)	Level (dBuV)	Transducer (dB/m)	Gain / Loss (dB)	Final (dBuV/m)	Azm(deg)/Pol/Hgt(m)	Margin: FCC Class B >1GHz PK (dB)	Margin: FCC Class B >1GHz AV (dB)

Spurious Emissions, 18 GHz – 25GHz, High

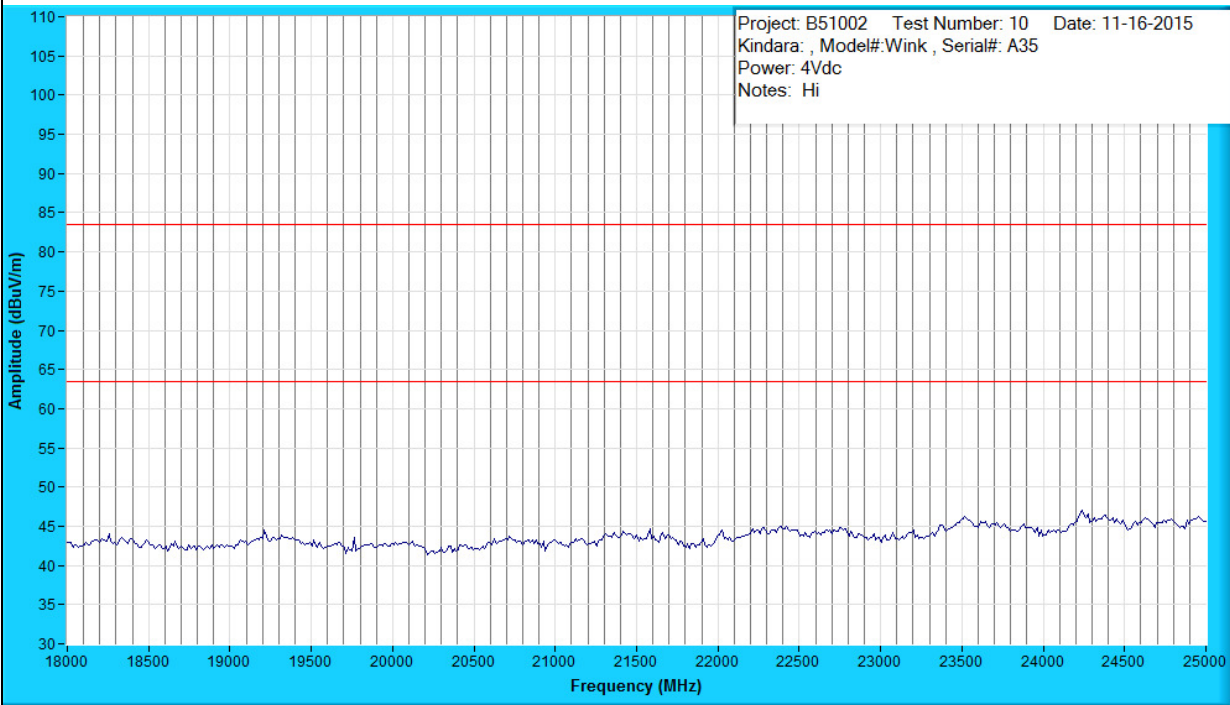

Type	Frequency (MHz)	Level (dBuV)	Transducer (dB/m)	Gain / Loss (dB)	Final (dBuV/m)	Azm(deg)/Pol/Hgt(m)	Margin: FCC Class B >1GHz PK (dB)	Margin: FCC Class B >1GHz AV (dB)

Tested by (+ signature) .....

Kevin Johnson.

## Test Results - RF Exposure

Table No. 2	<b>RF Exposure</b>	Verdict
		P

Test Method.....	: ANSI C63.4
EUT Configuration .....	:
Power Input .....	: Internal DC Battery <input checked="" type="checkbox"/> 1φ <input type="checkbox"/> 3φ
Test Date .....	: 11-17-2015
Temperature .....	: 21.5°C                      Relative Humidity .....:23 %
Test Equipment Asset Tag List .....	: 1337, 1339, 1340, 1341, 1215, 1220, 1403, 1246, 1537, 1396, 1253, 1232, 1392

# FCC SAR Exemption per KDB 447498

## KDB 447498 D01 General RF Exposure Guidance v05r02 (February 7, 2014)

### 1. Declaration of RF exposure compliance for exemption from routine evaluation limits

FCC ID:	2AGDF-WK01
Model number:	Wink
Manufacturer:	Kindara
4.3.1. Standalone SAR test exclusion considerations:	<p>During normal operation, user extremities can come within 20 cm of the internal antenna and therefore product is considered as “Portable”.</p> <p>The 1-g and 10-g SAR test exclusion thresholds for 100 MHz to 6 GHz at Test separation distances ≤ 50 mm are determined by:  <math display="block">[(\text{max. power of channel, including tune-up tolerance, mW}) \div (\text{min. test separation distance, mm})] \times \sqrt{f(\text{GHz})} \leq 3.0</math>         for 1-g SAR and ≤ 7.5 for 10-g extremity SAR, where</p> <p>f(GHz) is the RF channel transmit frequency in GHz          Power and distance are rounded to the nearest mW and mm before calculation          The result is rounded to one decimal place for comparison</p> <p>The test exclusions are applicable only when the minimum test separation distance is ≤ 50 mm and for transmission frequencies between 100 MHz and 6 GHz. When the minimum test separation distance is &lt; 5 mm, a distance of 5 mm according to 5) in section 4.1 is applied to determine SAR test exclusion</p> <p>Calculation based on the above formula:          Separation Distance = 5 mm          Conducted Output Power = -11 dBm = 0.08 mW          Frequency = 2.480 GHz          Calculation = <math>(0.08 \div 5) \times \sqrt{2.480} = 0.025 &lt; 3</math></p> <p>The calculation is below the threshold, therefore the product exempt from the SAR test requirements</p>

### 2. Attestation

ATTESTATION: I attest that the testing was performed or supervised by me; that the test measurements were made in accordance with the above-mentioned departmental standard(s), and that the radio equipment identified in this application has been subject to all applicable test conditions specified in the departmental standards and all of the requirements of the standards have been met.

Signature:	
Date:	December 22, 2015
Name:	Vincent W. Greb, EMC Integrity, Inc.

**Supplemental Information:**

Conducted power was determined by measuring the radiated power at 3-meters and calculating the power delivered to the Tx antenna using FCC Guidance Note 412172. Calculation table contained on page 53 of this report.

Tested by (+ signature) .....	Kevin Johnson.	
-------------------------------	----------------	---

## Setup Photos

Photo 1

**Test Setup – Radiated Measurements**



**Supplemental Information:**

Measurements from 30 kHz to 1 GHz were made using a 10-meter antenna separation.  
Measurements from 1 to 18 GHz were made using a 3-meter antenna separation.  
Measurements from 18 – 25 GHz were made using a 1-meter antenna separation.