

FCC SAR EVALUATION REPORT

In accordance with the requirements of
FCC 47 CFR Part 2(2.1093), ANSI/IEEE C95.1-1992 and
IEEE Std 1528-2013

Product Name : TT0802 8 inch tablet

Trademark : N/A

Model Name : TT0802

Family Model : N/A

Report No. : S21051701002001

FCC ID : JACSTT0802

Prepared for

JACS Solutions, Inc.

809 Pinnacle Drive, Suite R, Linthicum Heights, MD 21090

Prepared by

Shenzhen NTEK Testing Technology Co., Ltd.

1/F, Building E, Fenda Science Park, Sanwei Community, Xixiang Street,

Bao'an District, Shenzhen 518126 P.R.China.

Tel. 400-800-6106, 0755-2320 0050, 0755-2320 0090

Website: <http://www.ntek.org.cn>

TEST RESULT CERTIFICATION

Applicant's name.....: JACS Solutions, Inc.
Address.....: 809 Pinnacle Drive, Suite R, Linthicum Heights, MD 21090
Manufacturer's Name.....: JACS Solutions, Inc.
Address.....: 809 Pinnacle Drive, Suite R, Linthicum Heights, MD 21090

Product description

Product name.....: TT0802 8 inch tablet
Trademark: N/A
Model Name: TT0802
Family Model.....: N/A
 FCC 47 CFR Part 2(2.1093)

Standards.....: ANSI/IEEE C95.1-1992
 IEEE Std 1528-2013
 Published RF exposure KDB procedures

This device described above has been tested by Shenzhen NTEK. In accordance with the measurement methods and procedures specified in IEEE Std 1528-2013 and KDB 865664 D01. Testing has shown that this device is capable of compliance with localized specific absorption rate (SAR) specified in FCC 47 CFR Part 2(2.1093) and ANSI/IEEE C95.1-1992. The test results in this report apply only to the tested sample of the stated device/equipment. Other similar device/equipment will not necessarily produce the same results due to production tolerance and measurement uncertainties.

This report shall not be reproduced except in full, without the written approval of Shenzhen NTEK, this document may be altered or revised by Shenzhen NTEK, personal only, and shall be noted in the revision of the document.

Date of Test

Date (s) of performance of tests.....: Jun. 28, 2021 ~ Jul. 13, 2021
Date of Issue: Jul. 19, 2021
Test Result: **Pass**

Prepared By : Jacob.chen
 (Test Engineer) : (Jacob Chen)

Approved By : Alex
 (Lab Manager) : (Alex Li)

※ ※ Revision History ※ ※

REV.	DESCRIPTION	ISSUED DATE	REMARK
Rev.1.0	Initial Test Report Release	Jul. 19, 2021	Jacob Chen

TABLE OF CONTENTS

1. General Information	6
1.1. RF exposure limits.....	6
1.2. Statement of Compliance	7
1.3. EUT Description	7
1.4. Test specification(s)	9
1.5. Ambient Condition.....	9
2. SAR Measurement System	10
2.1. SATIMO SAR Measurement Set-up Diagram	10
2.2. Robot	11
2.3. E-Field Probe.....	12
2.3.1. E-Field Probe Calibration	12
2.4. SAM phantoms	13
2.4.1. Technical Data	14
2.5. Device Holder	15
2.6. Test Equipment List	16
3. SAR Measurement Procedures	18
3.1. Power Reference	18
3.2. Area scan & Zoom scan.....	18
3.3. Description of interpolation/extrapolation scheme	20
3.4. Volumetric Scan	20
3.5. Power Drift	20
4. System Verification Procedure	21
4.1. Tissue Verification	21
4.1.1. Tissue Dielectric Parameter Check Results	22
4.2. System Verification Procedure	23
4.2.1. System Verification Results.....	24
5. SAR Measurement variability and uncertainty	25
5.1. SAR measurement variability.....	25
5.2. SAR measurement uncertainty	25
6. RF Exposure Positions.....	26
6.1. Tablet host platform exposure conditions.....	26
7. RF Output Power	27
7.1. WCDMA Conducted Power	27
7.2. LTE Conducted Power	28
7.3. WLAN & Bluetooth Output Power	40
7.3.1. Output Power Results Of WLAN	40
7.3.2. Output Power Results Of Bluetooth.....	41
8. Antenna Location.....	42
9. Stand-alone SAR test exclusion.....	50

10.	SAR Results	51
10.1.	SAR measurement results	51
10.1.1.	SAR measurement Result of WCDMA Band 2	51
10.1.2.	SAR measurement Result of WCDMA Band 4	51
10.1.3.	SAR measurement Result of WCDMA Band 5	51
10.1.4.	SAR measurement Result of LTE Band 2	52
10.1.5.	SAR measurement Result of LTE Band 4	53
10.1.6.	SAR measurement Result of LTE Band 5	54
10.1.7.	SAR measurement Result of LTE Band 12	54
10.1.8.	SAR measurement Result of LTE Band 13	55
10.1.9.	SAR measurement Result of LTE Band 14	56
10.1.10.	SAR measurement Result of LTE Band 66	57
10.1.11.	SAR measurement Result of LTE Band 71	58
10.1.12.	SAR measurement Result of WLAN 2.4G	59
10.1.13.	SAR measurement Result of WLAN 5.8G	59
10.2.	SAR Summation Scenario.....	59
11.	Appendix A. Photo documentation	71
12.	Appendix B. System Check Plots	71
13.	Appendix C. Plots of High SAR Measurement.....	84
14.	Appendix D. Calibration Certificate	111

1. General Information

1.1. RF exposure limits

(A).Limits for Occupational/Controlled Exposure (W/kg)

Whole-Body	Partial-Body	Hands, Wrists, Feet and Ankles
0.4	8.0	20.0

(B).Limits for General Population/Uncontrolled Exposure (W/kg)

Whole-Body	Partial-Body	Hands, Wrists, Feet and Ankles
0.08	1.6	4.0

NOTE: **Whole-Body SAR** is averaged over the entire body, **partial-body SAR** is averaged over any 1 gram of tissue defined as a tissue volume in the shape of a cube. **SAR for hands, wrists, feet and ankles** is averaged over any 10 grams of tissue defined as a tissue volume in the shape of a cube.

Occupational/Controlled Environments:

Are defined as locations where there is exposure that may be incurred by people who are aware of the potential for exposure, (i.e. as a result of employment or occupation).

General Population/Uncontrolled Environments:

Are defined as locations where there is the exposure of individuals who have no knowledge or control of their exposure.

NOTE
TRUNK LIMIT
1.6 W/kg
APPLIED TO THIS EUT

1.2. Statement of Compliance

The maximum results of Specific Absorption Rate (SAR) found during testing for TT0802 are as follows.

RF Exposure Conditions		Equipment Class -Highest Reported SAR (W/kg)			
		PCE	DTS	NII	DSS
1-g Body (Separation distance of 0mm)		1.484	0.396	0.447	N/A
Max Simultaneous Tx	Body	1.552	1.381	1.552	1.325

Note: The Max Simultaneous Tx is calculated based on the same configuration and test position. This device is in compliance with Specific Absorption Rate (SAR) for general population/uncontrolled exposure limits (1.6 W/kg) specified in FCC 47 CFR Part 2(2.1093) and ANSI/IEEE C95.1-1992, and had been tested in accordance with the measurement methods and procedures specified in IEEE Std 1528-2013 & KDB 865664 D01.

1.3. EUT Description

Device Information			
Product Name	TT0802 8 inch tablet		
Trade Name	N/A		
Model Name	TT0802		
Family Model	N/A		
FCC ID	JACSTT0802		
Device Phase	Identical Prototype		
Exposure Category	General population / Uncontrolled environment		
Antenna	PIFA Antenna		
Battery Information	DC 3.7V, 3100mAh, 11.47Wh		
Device Operating Configurations			
Supporting Mode(s)	WCDMA Band 2/4/5, LTE Band 2/4/5/12/13/14/66/71, WLAN 2.4G/5.2G/5.8G, Bluetooth, NFC		
Test Modulation	WCDMA(QPSK), LTE(QPSK/16QAM), WLAN(DSSS/OFDM), Bluetooth(GFSK, $\pi/4$ -DQPSK, 8DPSK), NFC(ASK)		
Device Class	B		
Operating Frequency Range(s)	Band	Tx (MHz)	Rx (MHz)
	WCDMA Band 2	1850-1910	1930-1990
	WCDMA Band 4	1710-1755	2110-2155
	WCDMA Band 5	824-849	869-894
	LTE Band 2	1850-1910	1930-1990
	LTE Band 4	1710-1755	2110-2155
	LTE Band 5	824-849	869-894

	LTE Band 12	699-716	729-746
	LTE Band 13	777-787	746-756
	LTE Band 14	788-798	758-768
	LTE Band 66	1710-1780	2110-2200
	LTE Band 71	663-698	617-652
	WLAN 2.4G	2412-2462	
	WLAN 5.2G	5180-5240	
	WLAN 5.8G	5745-5825	
	NFC	13.56	
	Bluetooth	2402-2480	
Power Class	3, tested with power control "all 1"(WCDMA Band 2)		
	3, tested with power control "all 1"(WCDMA Band 4)		
	3, tested with power control "all 1"(WCDMA Band 5)		
	3, tested with power control all Max.(LTE Band 2)		
	3, tested with power control all Max.(LTE Band 4)		
	3, tested with power control all Max.(LTE Band 5)		
	3, tested with power control all Max.(LTE Band 12)		
	3, tested with power control all Max.(LTE Band 13)		
	3, tested with power control all Max.(LTE Band 14)		
	3, tested with power control all Max.(LTE Band 66)		
	3, tested with power control all Max.(LTE Band 71)		

1.4. Test specification(s)

FCC 47 CFR Part 2(2.1093)
ANSI/IEEE C95.1-1992
IEEE Std 1528-2013
KDB 865664 D01 SAR measurement 100 MHz to 6 GHz
KDB 865664 D02 RF Exposure Reporting
KDB 447498 D01 General RF Exposure Guidance
KDB 248227 D01 802.11 Wi-Fi SAR
KDB 941225 D01 3G SAR Procedures
KDB 941225 D05 SAR for LTE Devices
KDB 616217 D04 SAR for laptop and tablets

1.5. Ambient Condition

Ambient temperature	20°C – 24°C
Relative Humidity	30% – 70%

2. SAR Measurement System

2.1. SATIMO SAR Measurement Set-up Diagram

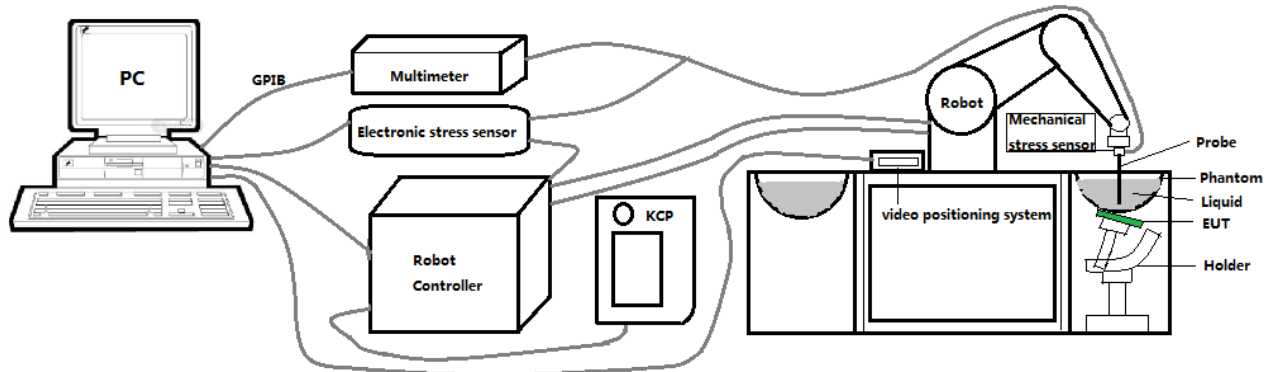

These measurements were performed with the automated near-field scanning system OPENSAR from SATIMO. The system is based on a high precision robot (working range: 901 mm), which positions the probes with a positional repeatability of better than ± 0.03 mm. The SAR measurements were conducted with dosimetric probe (manufactured by SATIMO), designed in the classical triangular configuration and optimized for dosimetric evaluation.

The first step of the field measurement is the evaluation of the voltages induced on the probe by the device under test. Probe diode detectors are nonlinear. Below the diode compression point, the output voltage is proportional to the square of the applied E-field; above the diode compression point, it is linear to the applied E-field. The compression point depends on the diode, and a calibration procedure is necessary for each sensor of the probe.

The Keithley multimeter reads the voltage of each sensor and send these three values to the PC. The corresponding E field value is calculated using the probe calibration factors, which are stored in the working directory. This evaluation includes linearization of the diode characteristics. The field calculation is done separately for each sensor. Each component of the E field is displayed on the "Dipole Area Scan Interface" and the total E field is displayed on the "3D Interface"

2.2. Robot

The SATIMO SAR system uses the high precision robots from KUKA. For the 6-axis controller system, the robot controller version (KUKA) from KUKA is used. The KUKA robot series have many features that are important for our application:



- High precision (repeatability ± 0.03 mm)
- High reliability (industrial design)
- Jerk-free straight movements
- Low ELF interference (the closed metallic construction shields against motor control fields)

2.3. E-Field Probe

This E-field detection probe is composed of three orthogonal dipoles linked to special Schottky diodes with low detection thresholds. The probe allows the measurement of electric fields in liquids such as the one defined in the IEEE and CENELEC standards.

For the measurements the Specific Dosimetric E-Field Probe SN 08/16 EPGO287 with following specifications is used



- Dynamic range: 0.01-100 W/kg
 - Tip Diameter : 2.5 mm
 - Distance between probe tip and sensor center: 1 mm
 - Distance between sensor center and the inner phantom surface: 2 mm (repeatability better than ± 1 mm).
 - Probe linearity: ± 0.08 dB
 - Axial isotropy: ± 0.01 dB
 - Hemispherical Isotropy: ± 0.01 dB
 - Calibration range: 650MHz to 5900MHz for head & body simulating liquid.
 - Lower detection limit: 8mW/kg
- Angle between probe axis (evaluation axis) and surface normal line: less than 30° .

2.3.1. E-Field Probe Calibration

Each probe needs to be calibrated according to a dosimetric assessment procedure with accuracy better than $\pm 10\%$. The spherical isotropy shall be evaluated and within ± 0.25 dB. The sensitivity parameters (Norm X, Norm Y, and Norm Z), the diode compression parameter (DCP) and the conversion factor (Conv F) of the probe are tested. The calibration data can be referred to appendix D of this report.

2.4. SAM phantoms

Photo of SAM phantom SN 16/15 SAM119



The SAM phantom is used to measure the SAR relative to people exposed to electro-magnetic field radiated by mobile phones.

2.4.1. Technical Data

Serial Number	Shell thickness	Filling volume	Dimensions	Positionner Material	Permittivity	Loss Tangent
SN 16/15 SAM119	2 mm ±0.2 mm	27 liters	Length:1000 mm Width:500 mm Height:200 mm	Gelcoat with fiberglass	3.4	0.02

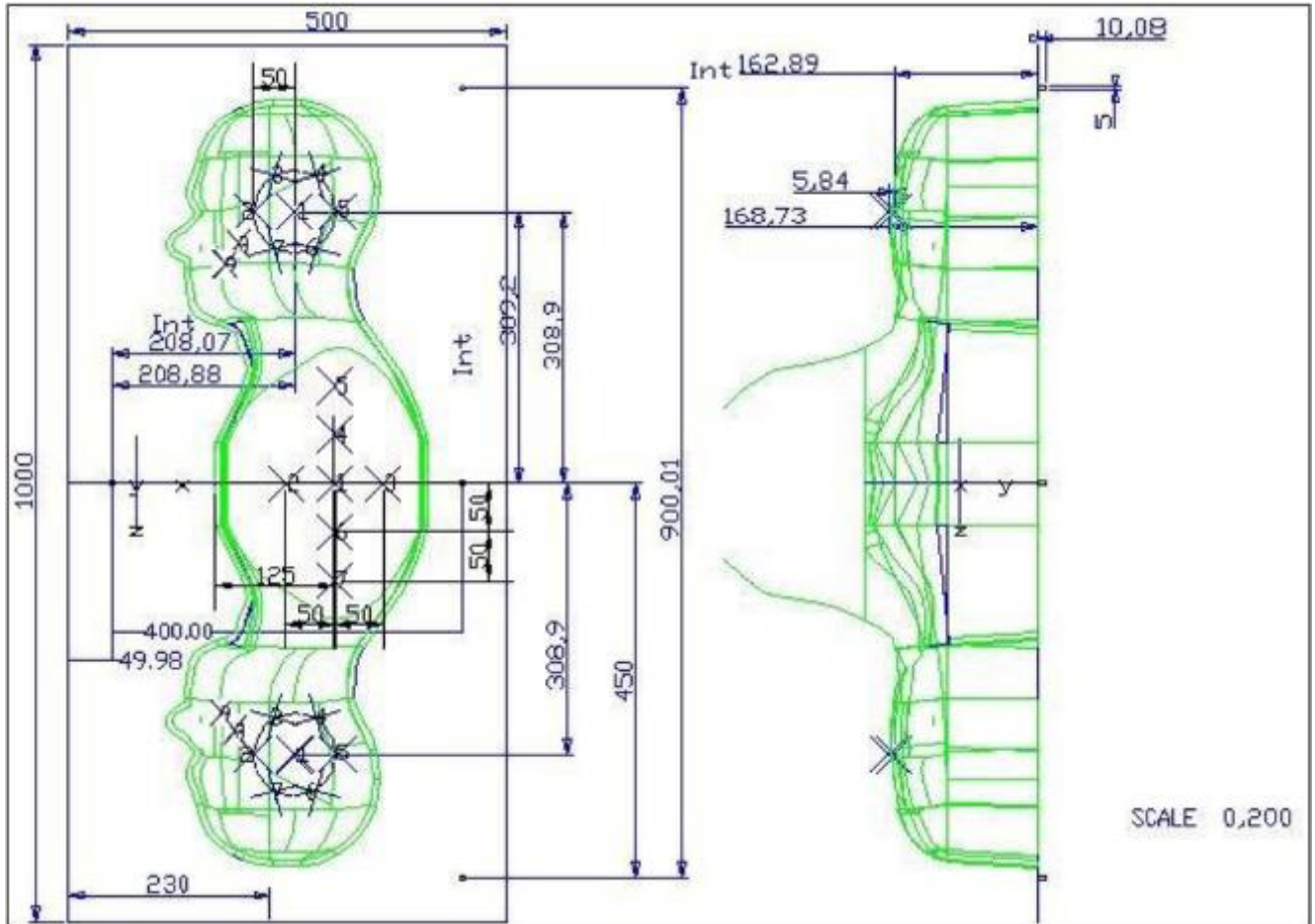

Serial Number	Left Head(mm)		Right Head(mm)		Flat Part(mm)	
	1	2	1	2	1	2
SN 16/15 SAM119	2	2.02	2	2.08	1	2.09
	3	2.05	3	2.06	2	2.06
	4	2.07	4	2.07	3	2.08
	5	2.08	5	2.08	4	2.10
	6	2.05	6	2.07	5	2.10
	7	2.05	7	2.05	6	2.07
	8	2.07	8	2.06	7	2.07
	9	2.08	9	2.06	-	-

The test, based on ultrasonic system, allows measuring the thickness with an accuracy of 10 µm.

2.5. Device Holder

The positioning system allows obtaining cheek and tilting position with a very good accuracy. In compliance with CENELEC, the tilt angle uncertainty is lower than 1 degree.

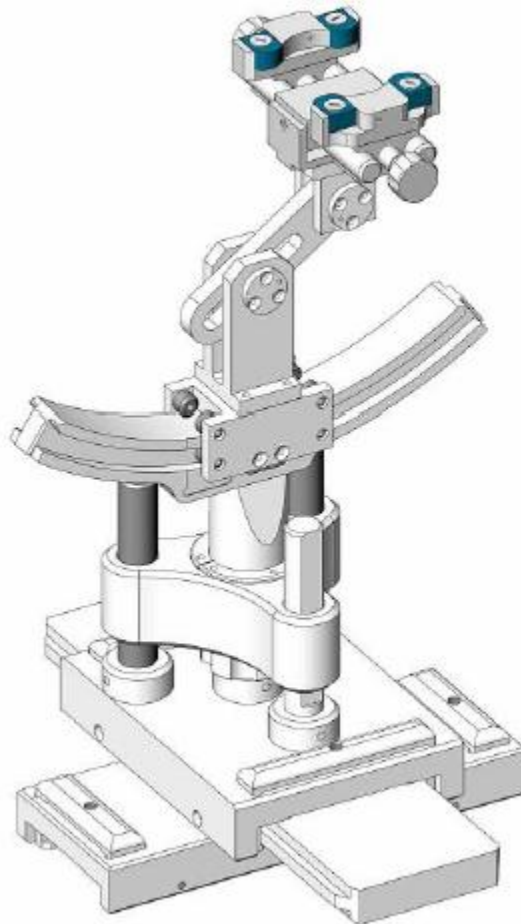

Serial Number	Holder Material	Permittivity	Loss Tangent
SN 16/15 MSH100	Delrin	3.7	0.005

2.6. Test Equipment List

This table gives a complete overview of the SAR measurement equipment.

Devices used during the test described are marked

	Manufacturer	Name of Equipment	Type/Model	Serial Number	Calibration	
					Last Cal.	Due Date
<input checked="" type="checkbox"/>	MVG	E FIELD PROBE	SSE2	SN 08/16 EPGO287	Mar. 01, 2021	Feb. 28, 2022
<input checked="" type="checkbox"/>	MVG	750 MHz Dipole	SID750	SN 03/15 DIP 0G750-355	Mar. 01, 2021	Feb. 28, 2024
<input checked="" type="checkbox"/>	MVG	835 MHz Dipole	SID835	SN 03/15 DIP 0G835-347	Mar. 01, 2021	Feb. 28, 2024
<input type="checkbox"/>	MVG	900 MHz Dipole	SID900	SN 03/15 DIP 0G900-348	Mar. 01, 2021	Feb. 28, 2024
<input checked="" type="checkbox"/>	MVG	1800 MHz Dipole	SID1800	SN 03/15 DIP 1G800-349	Mar. 01, 2021	Feb. 28, 2024
<input checked="" type="checkbox"/>	MVG	1900 MHz Dipole	SID1900	SN 03/15 DIP 1G900-350	Mar. 01, 2021	Feb. 28, 2024
<input type="checkbox"/>	MVG	2000 MHz Dipole	SID2000	SN 03/15 DIP 2G000-351	Mar. 01, 2021	Feb. 28, 2024
<input type="checkbox"/>	MVG	2300 MHz Dipole	SID2300	SN 03/16 DIP 2G300-358	Nov. 08, 2018	Nov. 07, 2021
<input checked="" type="checkbox"/>	MVG	2450 MHz Dipole	SID2450	SN 03/15 DIP 2G450-352	Mar. 01, 2021	Feb. 28, 2024
<input type="checkbox"/>	MVG	2600 MHz Dipole	SID2600	SN 03/15 DIP 2G600-356	Mar. 01, 2021	Feb. 28, 2024
<input checked="" type="checkbox"/>	MVG	5000 MHz Dipole	SWG5500	SN 13/14 WGA 33	Mar. 01, 2021	Feb. 28, 2024
<input checked="" type="checkbox"/>	MVG	Liquid measurement Kit	SCLMP	SN 21/15 OCPG 72	NCR	NCR
<input checked="" type="checkbox"/>	MVG	Power Amplifier	N.A	AMPLISAR_28/14_003	NCR	NCR
<input checked="" type="checkbox"/>	KEITHLEY	Millivoltmeter	2000	4072790	NCR	NCR
<input checked="" type="checkbox"/>	R&S	Universal radio communication tester	CMU200	117858	Jul. 13, 2020	Jul. 12, 2021
					Jul. 01, 2021	Jun. 30, 2022
<input checked="" type="checkbox"/>	R&S	Wideband radio communication tester	CMW500	103917	Jul. 13, 2020	Jul. 12, 2021
					Jul. 01, 2021	Jun. 30, 2022

<input checked="" type="checkbox"/>	HP	Network Analyzer	8753D	3410J01136	Jul. 13, 2020	Jul. 12, 2021
					Jul. 01, 2021	Jun. 30, 2022
<input checked="" type="checkbox"/>	Agilent	PSG Analog Signal Generator	E8257D	MY51110112	Jul. 13, 2020	Jul. 12, 2021
					Jul. 01, 2021	Jun. 30, 2022
<input checked="" type="checkbox"/>	Agilent	Power meter	E4419B	MY45102538	Jul. 13, 2020	Jul. 12, 2021
					Jul. 01, 2021	Jun. 30, 2022
<input checked="" type="checkbox"/>	Agilent	Power sensor	E9301A	MY41495644	Jul. 13, 2020	Jul. 12, 2021
					Jul. 01, 2021	Jun. 30, 2022
<input checked="" type="checkbox"/>	Agilent	Power sensor	E9301A	US39212148	Jul. 13, 2020	Jul. 12, 2021
					Jul. 01, 2021	Jun. 30, 2022
<input checked="" type="checkbox"/>	MCLI/USA	Directional Coupler	CB11-20	0D2L51502	Jul. 17, 2020	Jul. 16, 2023

3. SAR Measurement Procedures

The measurement procedures are as follows:

<Conducted power measurement>

- (a) For WWAN power measurement, use base station simulator to configure EUT WWAN transmission in conducted connection with RF cable, at maximum power in each supported wireless interface and frequency band.
- (b) Read the WWAN RF power level from the base station simulator.
- (c) For WLAN/Bluetooth power measurement, use engineering software to configure EUT WLAN/Bluetooth continuously transmission, at maximum RF power in each supported wireless interface and frequency band.
- (d) Connect EUT RF port through RF cable to the power meter, and measure WLAN/Bluetooth output power.

<SAR measurement>

- (a) Use base station simulator to configure EUT WWAN transmission in radiated connection, and engineering software to configure EUT WLAN/Bluetooth continuously transmission, at maximum RF power, in the highest power channel.
- (b) Place the EUT in the positions as Appendix A demonstrates.
- (c) Set scan area, grid size and other setting on the OPENSAR software.
- (d) Measure SAR results for the highest power channel on each testing position.
- (e) Find out the largest SAR result on these testing positions of each band.
- (f) Measure SAR results for other channels in worst SAR testing position if the reported SAR of highest power channel is larger than 0.8 W/kg.

According to the test standard, the recommended procedure for assessing the peak spatial-average SAR value consists of the following steps:

- (a) Power reference measurement
- (b) Area scan
- (c) Zoom scan
- (d) Power drift measurement

3.1. Power Reference

The Power Reference Measurement and Power Drift Measurements are for monitoring the power drift of the device under test in the batch process. The minimum distance of probe sensors to surface determines the closest measurement point to phantom surface. This distance cannot be smaller than the distance of sensor calibration points to probe tip as defined in the probe properties.

3.2. Area scan & Zoom scan

The area scan is a 2D scan to find the hot spot location on the DUT. The zoom scan is a 3D scan above the hot spot to calculate the 1g and 10g SAR value.

Measurement of the SAR distribution with a grid of 8 to 16 mm * 8 to 16 mm and a constant distance to the inner surface of the phantom. Since the sensors cannot directly measure at the inner phantom surface, the values between the sensors and the inner phantom surface are extrapolated. With these values the area of the maximum SAR is calculated by an interpolation scheme. Around this point, a cube of 30 * 30 * 30 mm or 32 * 32 * 32 mm is assessed by measuring 5 or 8 * 5 or 8 * 4 or 5 mm. With these data, the peak spatial-average SAR value can be calculated.

From the scanned SAR distribution, identify the position of the maximum SAR value, in addition identify the positions of any local maxima with SAR values within 2 dB of the maximum value that will not be within the zoom scan of other peaks; additional peaks shall be measured only when the primary peak is within 2 dB of the SAR compliance limit (e.g., 1 W/kg for 1,6 W/kg 1 g limit, or 1,26 W/kg for 2 W/kg, 10 g limit).

Area scan & Zoom scan scan parameters extracted from FCC KDB 865664 D01 SAR measurement 100 MHz to 6 GHz.

		≤ 3 GHz	> 3 GHz	
Maximum distance from closest measurement point (geometric center of probe sensors) to phantom surface		5 ± 1 mm	½·δ·ln(2) ± 0.5 mm	
Maximum probe angle from probe axis to phantom surface normal at the measurement location		30° ± 1°	20° ± 1°	
Maximum area scan spatial resolution: Δx _{Area} , Δy _{Area}		≤ 2 GHz: ≤ 15 mm 2 – 3 GHz: ≤ 12 mm	3 – 4 GHz: ≤ 12 mm 4 – 6 GHz: ≤ 10 mm	
		When the x or y dimension of the test device, in the measurement plane orientation, is smaller than the above, the measurement resolution must be ≤ the corresponding x or y dimension of the test device with at least one measurement point on the test device.		
Maximum zoom scan spatial resolution: Δx _{Zoom} , Δy _{Zoom}		≤ 2 GHz: ≤ 8 mm 2 – 3 GHz: ≤ 5 mm*	3 – 4 GHz: ≤ 5 mm* 4 – 6 GHz: ≤ 4 mm*	
Maximum zoom scan spatial resolution, normal to phantom surface	uniform grid: Δz _{Zoom} (n)	≤ 5 mm	3 – 4 GHz: ≤ 4 mm 4 – 5 GHz: ≤ 3 mm 5 – 6 GHz: ≤ 2 mm	
	graded grid	Δz _{Zoom} (1): between 1 st two points closest to phantom surface	≤ 4 mm	3 – 4 GHz: ≤ 3 mm 4 – 5 GHz: ≤ 2.5 mm 5 – 6 GHz: ≤ 2 mm
		Δz _{Zoom} (n>1): between subsequent points	≤ 1.5·Δz _{Zoom} (n-1)	
Minimum zoom scan volume	x, y, z	≥ 30 mm	3 – 4 GHz: ≥ 28 mm 4 – 5 GHz: ≥ 25 mm 5 – 6 GHz: ≥ 22 mm	

Note: δ is the penetration depth of a plane-wave at normal incidence to the tissue medium; see draft standard IEEE P1528-2011 for details.

* When zoom scan is required and the *reported* SAR from the *area scan based 1-g SAR estimation* procedures of KDB 447498 is ≤ 1.4 W/kg, ≤ 8 mm, ≤ 7 mm and ≤ 5 mm zoom scan resolution may be applied, respectively, for 2 GHz to 3 GHz, 3 GHz to 4 GHz and 4 GHz to 6 GHz.

3.3. Description of interpolation/extrapolation scheme

The local SAR inside the phantom is measured using small dipole sensing elements inside a probe body. The probe tip must not be in contact with the phantom surface in order to minimise measurements errors, but the highest local SAR will occur at the surface of the phantom.

An extrapolation is using to determinate this highest local SAR values. The extrapolation is based on a fourth-order least-square polynomial fit of measured data. The local SAR value is then extrapolated from the liquid surface with a 1 mm step.

The measurements have to be performed over a limited time (due to the duration of the battery) so the step of measurement is high. It could vary between 5 and 8 mm. To obtain an accurate assessment of the maximum SAR averaged over 10 grams and 1 gram requires a very fine resolution in the three dimensional scanned data array.

3.4. Volumetric Scan

The volumetric scan consists to a full 3D scan over a specific area. This 3D scan is useful form multi Tx SAR measurement. Indeed, it is possible with OpenSAR to add, point by point, several volumetric scan to calculate the SAR value of the combined measurement as it is define in the standard IEEE1528 and IEC62209.

3.5. Power Drift

All SAR testing is under the EUT install full charged battery and transmit maximum output power. In OpenSAR measurement software, the power reference measurement and power drift measurement procedures are used for monitoring the power drift of EUT during SAR test. Both these procedures measure the field at a specified reference position before and after the SAR testing. The software will calculate the field difference in V/m. If the power drifts more than $\pm 5\%$, the SAR will be retested.

4. System Verification Procedure

4.1. Tissue Verification

The following tissue formulations are provided for reference only as some of the parameters have not been thoroughly verified. The composition of ingredients may be modified accordingly to achieve the desired target tissue parameters required for routine SAR evaluation.

Ingredients (% of weight)	Head Tissue									
	750	835	900	1800	1900	2000	2450	2600	5200	5800
Frequency Band (MHz)										
Water	34.40	34.40	34.40	55.36	55.36	57.87	57.87	57.87	65.53	65.53
NaCl	0.79	0.79	0.79	0.35	0.35	0.16	0.16	0.16	0.00	0.00
1,2-Propanediol	64.81	64.81	64.81	0.00	0.00	0.00	0.00	0.00	0.00	0.00
Triton X-100	0.00	0.00	0.00	30.45	30.45	19.97	19.97	19.97	24.24	24.24
DGBE	0.00	0.00	0.00	13.84	13.84	22.00	22.00	22.00	10.23	10.23

For SAR measurement of the field distribution inside the phantom, the phantom must be filled with homogeneous tissue simulating liquid to a depth of at least 15 cm. For head SAR testing, the liquid depth from the ear reference point (ERP) of the phantom to the liquid top surface is larger than 15 cm.

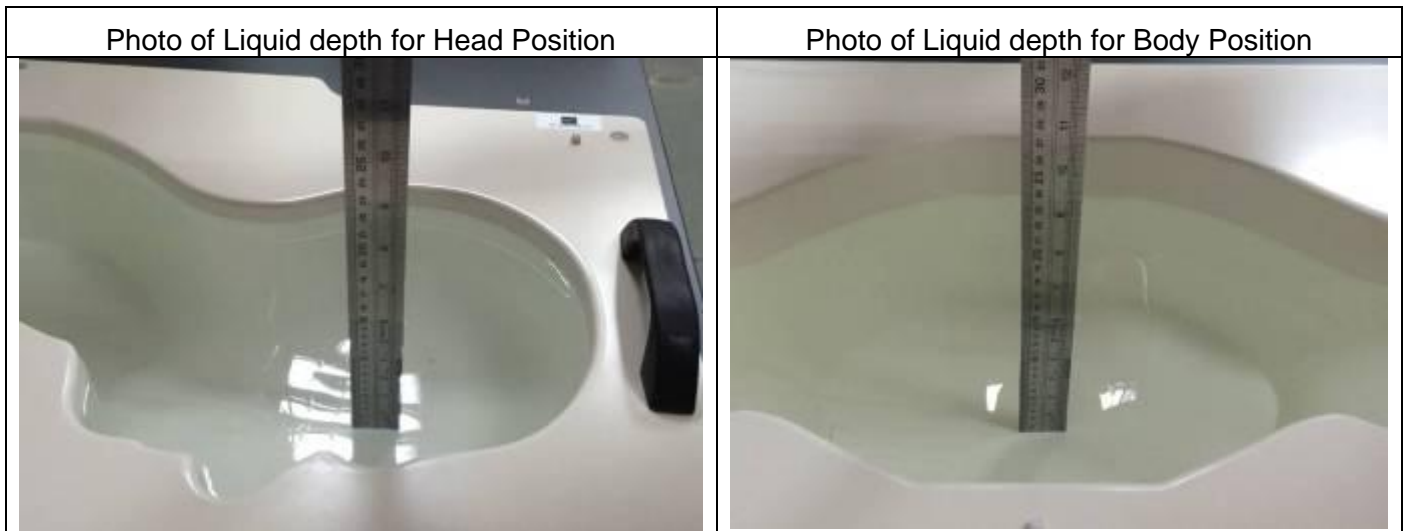

4.1.1. Tissue Dielectric Parameter Check Results

The simulating liquids should be checked at the beginning of a series of SAR measurements to determine if the dielectric parameters are within the tolerances of the specified target values. The measured conductivity and relative permittivity should be within $\pm 5\%$ of the target values.

Tissue Type	Measured Frequency (MHz)	Target Tissue		Measured Tissue		Liquid Temp.	Test Date
		ϵ_r ($\pm 5\%$)	σ (S/m) ($\pm 5\%$)	ϵ_r	σ (S/m)		
Head 750	750	41.96 (39.86~44.06)	0.89 (0.85~0.93)	41.05	0.89	21.3 °C	Jun. 28, 2021
Head 850	835	41.50 (39.43~43.58)	0.90 (0.86~0.95)	42.12	0.92	21.3 °C	Jun. 29, 2021
Head 1800	1800	40.00 (38.00~42.00)	1.40 (1.33~1.47)	39.81	1.41	21.5 °C	Jul. 01, 2021
Head 1900	1900	40.00 (38.00~42.00)	1.40 (1.33~1.47)	38.71	1.45	21.2 °C	Jul. 05, 2021
Head 2450	2450	39.20 (37.24~41.16)	1.80 (1.71~1.89)	38.48	1.85	21.7 °C	Jul. 08, 2021
Head 5800	5800	35.30 (33.54~37.07)	5.27 (5.01~5.53)	35.77	5.21	21.9 °C	Jul. 13, 2021

NOTE: The dielectric parameters of the tissue-equivalent liquid should be measured under similar ambient conditions and within 2 °C of the conditions expected during the SAR evaluation to satisfy protocol requirements.

4.2. System Verification Procedure

The system verification is performed for verifying the accuracy of the complete measurement system and performance of the software. The dipole is connected to the signal source consisting of signal generator and amplifier via a directional coupler, N-connector cable and adaption to SMA. It is fed with a power of 100mW (below 5GHz) or 100mW (above 5GHz). To adjust this power a power meter is used. The power sensor is connected to the cable before the system verification to measure the power at this point and do adjustments at the signal generator. At the outputs of the directional coupler both return loss as well as forward power are controlled during the system verification to make sure that emitted power at the dipole is kept constant. This can also be checked by the power drift measurement after the test (result on plot).

The system verification is shown as below picture:

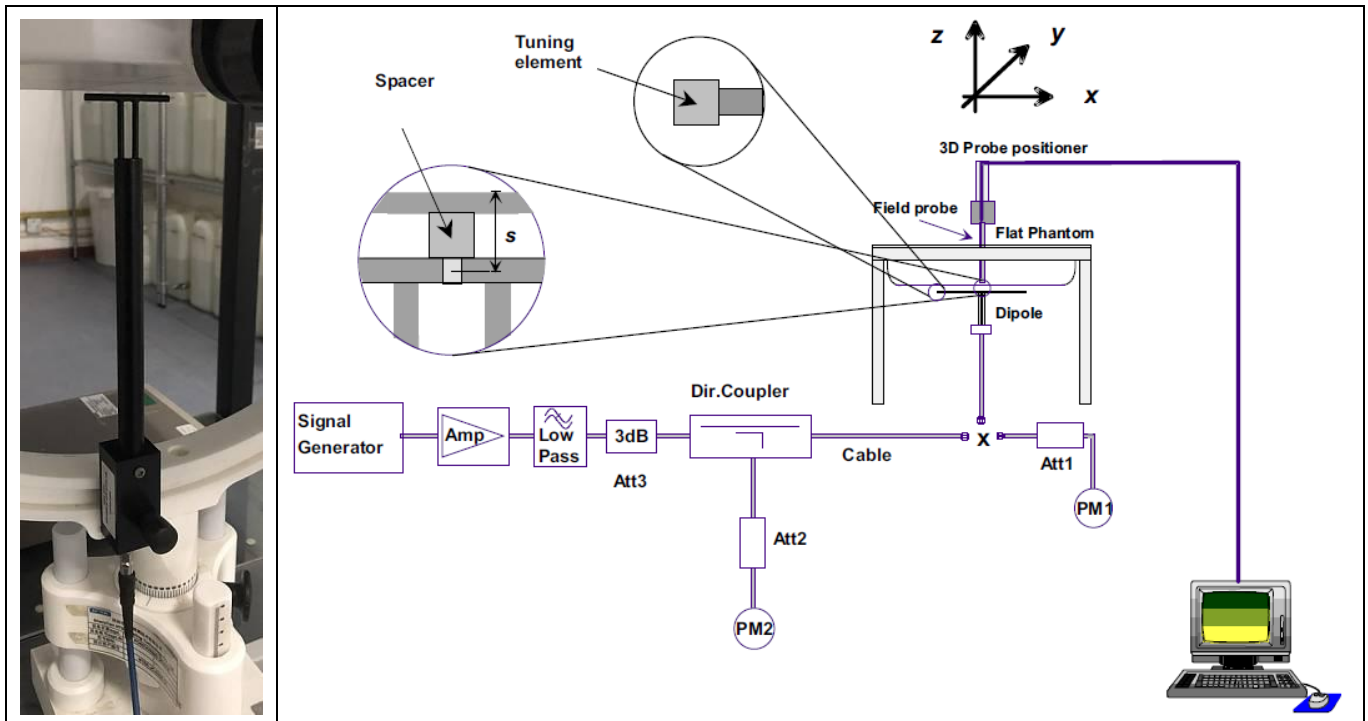

4.2.1. System Verification Results

Comparing to the original SAR value provided by SATIMO, the verification data should be within its specification of $\pm 10\%$. Below table shows the target SAR and measured SAR after normalized to 1W input power. The table below indicates the system performance verification can meet the variation criterion and the plots can be referred to Appendix B of this report.

System Verification	Target SAR (1W) ($\pm 10\%$)		Measured SAR (Normalized to 1W)		Liquid Temp.	Test Date
	1-g (W/Kg)	10-g (W/Kg)	1-g (W/Kg)	10-g (W/Kg)		
750MHz	8.53 (7.68~9.38)	5.56 (5.01~6.11)	8.99	5.53	21.3 °C	Jun. 28, 2021
835MHz	9.84 (8.86~10.82)	6.22 (5.60~6.84)	10.15	6.15	21.3 °C	Jun. 29, 2021
1800MHz	37.96 (34.17~41.75)	19.81 (17.83~21.79)	38.91	20.97	21.5 °C	Jul. 01, 2021
1900MHz	40.37 (36.34~44.40)	20.48 (18.44~22.52)	40.83	20.83	21.2 °C	Jul. 05, 2021
2450MHz	53.69 (48.33~59.05)	23.94 (21.55~26.33)	53.30	24.88	21.7 °C	Jul. 08, 2021
5800MHz	178.89 (161.01~196.77)	59.32 (53.39~65.25)	187.86	64.54	21.9 °C	Jul. 13, 2021

5. SAR Measurement variability and uncertainty

5.1. SAR measurement variability

Per KDB865664 D01 SAR measurement 100 MHz to 6 GHz, SAR measurement variability must be assessed for each frequency band, which is determined by the SAR probe calibration point and tissue-equivalent medium used for the device measurements. The additional measurements are repeated after the completion of all measurements requiring the same head or body tissue-equivalent medium in a frequency band. The test device should be returned to ambient conditions (normal room temperature) with the battery fully charged before it is re-mounted on the device holder for the repeated measurement(s) to minimize any unexpected variations in the repeated results.

- 1) Repeated measurement is not required when the original highest measured SAR is < 0.80 W/kg; steps 2) through 4) do not apply.
- 2) When the original highest measured SAR is ≥ 0.80 W/kg, repeat that measurement once.
- 3) Perform a second repeated measurement only if the ratio of largest to smallest SAR for the original and first repeated measurements is > 1.20 or when the original or repeated measurement is ≥ 1.45 W/kg (~ 10% from the 1-g SAR limit).
- 4) Perform a third repeated measurement only if the original, first or second repeated measurement is ≥ 1.5 W/kg and the ratio of largest to smallest SAR for the original, first and second repeated measurements is > 1.20 .

5.2. SAR measurement uncertainty

Per KDB865664 D01 SAR Measurement 100 MHz to 6 GHz, when the highest measured 1-g SAR within a frequency band is < 1.5 W/kg, the extensive SAR measurement uncertainty analysis described in IEEE Std 1528-2013 is not required in SAR reports submitted for equipment approval. The equivalent ratio (1.5/1.6) is applied to extremity and occupational exposure conditions.

6. RF Exposure Positions

6.1. Tablet host platform exposure conditions

Refer to KDB616217 D04, when the modular approach is used, transmitters and modules must be initially tested for standalone operations in generic host conditions according to the following minimum test separation distance and antenna installation requirements for incorporation in the tablet platform. The separation distance required for incorporation in qualified hosts is described in KDB 447498; item 5) of section 4.1 and item 1) of section 5.2.2 etc.

- ≤ 5 mm between the antenna and user for both back surface and edge exposure conditions
- the antennas used by the host must have been tested for equipment approval or qualify for SAR test exclusion
- the antenna polarization, physical orientation, rotation and installation configurations used by the host must have been tested for compliance or qualify for test exclusion
- when the *SAR Test Exclusion Threshold* in KDB 447498 applies, a *test separation distance* of 5 mm is required to determine test exclusion for the tablet platform

The antennas embedded in tablets are typically ≤ 5 mm from the outer housing. The required antenna to user test separation distance is a “not to exceed test” distance required to apply the modular approach. Instead of the typical zero gap tablet edge test requirement between the edge of a tablet and the user, when an antenna has been tested at ≤ 5 mm according to the modular approach it can be incorporated into tablets with at least twice the tested distance from the outer housing of the tablet edge; otherwise, the tablet edge zero gap test requirement applies. When the dedicated host approach is applied, the back surface and edges of the tablet should be tested for SAR compliance with the tablet touching the phantom.

7. RF Output Power

7.1. WCDMA Conducted Power

Band	WCDMA Band 2			
Tx Channel	Tune-up	9262	9400	9538
Frequency (MHz)		1852.4	1880	1907.6
RMC12.2K	23.50	23.19	23.05	23.04
HSDPA Sub 1	22.50	22.26	22.11	22.00
HSDPA Sub 2	22.50	22.20	22.07	22.00
HSDPA Sub 3	22.00	21.71	21.59	21.53
HSDPA Sub 4	22.00	21.72	21.60	21.54
HSUPA Sub 1	22.50	22.26	22.15	22.05
HSUPA Sub 2	22.00	21.67	21.62	21.61
HSUPA Sub 3	22.50	22.21	22.08	22.02
HSUPA Sub 4	22.50	22.31	22.18	22.13
HSUPA Sub 5	22.50	22.20	22.07	22.02
DC-HSDPA Sub 1	23.50	23.12	22.94	22.93
DC-HSDPA Sub 2	23.50	23.11	22.93	22.92
DC-HSDPA Sub 3	23.00	22.60	22.42	22.41
DC-HSDPA Sub 4	23.00	22.59	22.51	22.39
Band	WCDMA Band 4			
Tx Channel	Tune-up	1312	1413	1513
Frequency (MHz)		1712.4	1732.6	1752.6
RMC12.2K	23.50	23.46	23.35	23.37
HSDPA Sub 1	22.50	22.46	22.31	22.30
HSDPA Sub 2	23.00	22.50	22.31	22.38
HSDPA Sub 3	22.00	21.92	21.83	21.91
HSDPA Sub 4	22.00	21.91	21.81	21.90
HSUPA Sub 1	22.50	22.22	22.27	22.21
HSUPA Sub 2	22.00	21.95	21.81	21.91
HSUPA Sub 3	23.00	22.51	22.40	22.37
HSUPA Sub 4	23.00	22.53	22.38	22.37
HSUPA Sub 5	23.00	22.50	22.31	22.39
DC-HSDPA Sub 1	23.50	23.33	23.22	23.24
DC-HSDPA Sub 2	23.50	23.31	23.21	23.23
DC-HSDPA Sub 3	23.00	22.80	22.70	22.72
DC-HSDPA Sub 4	23.00	22.79	22.69	22.71
Band	WCDMA Band 5			
Tx Channel	Tune-up	4132	4183	4233

Frequency (MHz)		826.4	836.6	846.6
RMC12.2K	23.50	23.21	23.19	23.19
HSDPA Sub 1	22.50	22.16	22.22	22.27
HSDPA Sub 2	22.50	22.24	22.23	22.22
HSDPA Sub 3	22.00	21.70	21.62	21.76
HSDPA Sub 4	22.00	21.67	21.68	21.75
HSUPA Sub 1	22.50	22.15	22.24	22.23
HSUPA Sub 2	22.00	21.72	21.70	21.76
HSUPA Sub 3	22.50	22.20	22.20	22.19
HSUPA Sub 4	22.50	22.22	22.28	22.26
HSUPA Sub 5	22.50	22.17	22.24	22.23
DC-HSDPA Sub 1	23.50	23.08	23.06	23.06
DC-HSDPA Sub 2	23.50	23.17	23.04	23.05
DC-HSDPA Sub 3	23.00	22.66	22.53	22.54
DC-HSDPA Sub 4	23.00	22.65	22.52	22.53

7.2. LTE Conducted Power

Band	Band Width	Modulation	RB Configuration		Tune-up	Channel/Frequency(MHz)		
			RB Size	RB Offset		18607/1850.7	18900/1880	19193/1909.3
LTE Band 2	1.4MHz	QPSK	1	0	24.00	23.37	23.41	22.99
			1	2	24.00	23.41	23.79	22.99
			1	5	24.00	23.33	23.26	22.91
			3	0	23.50	23.35	23.29	23.12
			3	1	23.50	23.18	23.09	23.21
			3	2	23.50	23.37	23.26	22.90
		16QAM	6	0	22.50	22.23	22.49	22.07
			1	0	23.50	22.36	22.91	22.68
			1	2	23.50	22.41	22.94	23.00
			1	5	23.50	22.20	22.95	23.02
			3	0	22.50	22.33	22.19	22.16
			3	1	22.50	22.42	22.16	22.07
			3	2	22.50	22.31	22.29	22.06
			6	0	21.50	21.36	21.29	21.30
Band	Band Width	Modulation	RB Configuration		Tune-up	Channel/Frequency(MHz)		
			RB Size	RB Offset		18615/1851.5	18900/1880	19185/1908.5
LTE Band 2	3MHz	QPSK	1	0	24.00	23.39	23.45	23.02
			1	7	24.00	23.44	23.84	23.03
			1	14	24.00	23.36	23.31	22.95
			8	0	22.50	22.45	22.41	22.25
			8	4	22.50	22.30	22.19	22.33
			8	7	22.50	22.47	22.37	22.00
			15	0	23.00	22.26	22.53	22.10

		16QAM	1	0	23.50	22.39	22.93	22.71
			1	7	23.50	22.44	22.99	23.04
			1	14	23.50	22.22	22.99	23.05
			8	0	22.00	21.44	21.32	21.28
			8	4	22.00	21.53	21.29	21.19
			8	7	22.00	21.41	21.41	21.19
			15	0	21.50	21.39	21.33	21.33
Band	Band Width	Modulation	RB Configuration		Tune-up	Channel/Frequency(MHz)		
			RB Size	RB Offset		18625/1852.5	18900/1880	19175/1907.5
LTE Band 2	5MHz	QPSK	1	0	24.00	23.36	23.43	22.98
			1	12	24.00	23.42	23.80	23.00
			1	24	24.00	23.33	23.26	22.91
			12	0	22.50	22.42	22.36	22.21
			12	6	22.50	22.28	22.15	22.28
			12	11	22.50	22.45	22.35	21.96
		16QAM	25	0	23.00	22.24	22.52	22.08
			1	0	23.50	22.36	22.89	22.68
			1	12	23.50	22.41	22.97	23.01
			1	24	23.50	22.19	22.97	23.01
			12	0	22.00	21.42	21.28	21.25
			12	6	22.00	21.50	21.24	21.15
			12	11	22.00	21.38	21.36	21.15
			25	0	21.50	21.37	21.29	21.28
Band	Band Width	Modulation	RB Configuration		Tune-up	Channel/Frequency(MHz)		
			RB Size	RB Offset		18650/1855	18900/1880	19150/1905
LTE Band 2	10MHz	QPSK	1	0	24.00	23.38	23.44	23.01
			1	24	24.00	23.45	23.85	23.04
			1	49	24.00	23.35	23.30	22.94
			25	0	22.50	22.45	22.41	22.25
			25	12	22.50	22.31	22.20	22.32
			25	24	22.50	22.47	22.39	22.01
		16QAM	50	0	23.00	22.32	22.54	22.12
			1	0	23.50	22.38	22.92	22.70
			1	24	23.50	22.44	23.01	23.04
			1	49	23.50	22.22	22.99	23.04
			25	0	22.00	21.45	21.33	21.29
			25	12	22.00	21.52	21.28	21.18
			25	24	22.00	21.41	21.41	21.19
			50	0	21.50	21.40	21.34	21.32
Band	Band Width	Modulation	RB Configuration		Tune-up	Channel/Frequency(MHz)		
			RB Size	RB Offset		18675/1857.5	18900/1880	19125/1902.5
LTE Band 2	15MHz	QPSK	1	0	24.00	23.37	23.40	22.99
			1	37	24.00	23.43	23.84	23.01
			1	74	24.00	23.32	23.25	22.90
			36	0	22.50	22.43	22.37	22.22
			36	18	22.50	22.28	22.15	22.28

Band	Band Width	Modulation	RB Configuration		Tune-up	Channel/Frequency(MHz)				
			RB Size	RB Offset		18700/1860	18900/1880	19100/1900		
		16QAM	36	37	22.50	22.44	22.36	21.97		
			75	0	23.00	22.30	22.50	22.07		
			1	0	23.50	22.33	22.90	22.68		
			1	37	23.50	22.42	22.98	23.02		
			1	74	23.50	22.19	22.95	23.01		
			36	0	21.50	21.42	21.31	21.26		
			36	18	21.50	21.49	21.23	21.14		
			36	37	21.50	21.39	21.37	21.16		
			75	0	21.50	21.37	21.29	21.28		
LTE Band 2	20MHz	QPSK	1	0	24.00	23.34	23.36	22.96		
			1	49	24.00	23.42	23.80	22.99		
			1	99	24.00	23.30	23.24	22.87		
			50	0	22.50	22.40	22.32	22.18		
			50	24	22.50	22.26	22.11	22.25		
			50	49	22.50	22.41	22.31	21.93		
		16QAM	100	0	22.50	22.27	22.45	22.03		
			1	0	23.00	22.31	22.86	22.63		
			1	49	23.00	22.38	22.96	22.98		
			1	99	23.00	22.17	22.92	22.99		
			50	0	21.50	21.39	21.27	21.23		
			50	24	21.50	21.46	21.21	21.11		
					50	49	21.50	21.36	21.32	21.12
					100	0	21.50	21.35	21.25	21.25

Band	Band Width	Modulation	RB Configuration		Tune-up	Channel/Frequency(MHz)		
			RB Size	RB Offset		19957/1710.7	20175/1732.5	20393/1754.3
LTE Band 4	1.4MHz	QPSK	1	0	24.00	23.55	23.20	23.42
			1	2	24.00	23.44	23.53	23.46
			1	5	24.00	23.20	23.54	23.68
			3	0	24.00	23.32	23.22	23.55
			3	1	24.00	23.28	23.33	23.40
			3	2	24.00	23.31	23.42	23.39
		16QAM	6	0	23.00	22.30	22.40	22.64
			1	0	23.50	22.45	22.25	23.27
			1	2	23.50	22.52	22.79	23.15
			1	5	23.50	22.38	22.98	23.37
			3	0	22.50	22.23	22.32	22.43
			3	1	22.50	22.32	22.39	22.26
			3	2	22.50	22.39	22.47	22.47
			6	0	22.00	21.34	21.48	21.68
Band	Band Width	Modulation	RB Configuration		Tune-up	Channel/Frequency(MHz)		
			RB Size	RB Offset		19965/1711.5	20175/1732.5	20385/1753.5
LTE Band	3MHz	QPSK	1	0	24.00	23.57	23.24	23.45
			1	7	24.00	23.47	23.58	23.50

4			1	14	24.00	23.23	23.59	23.72			
			8	0	23.00	22.42	22.34	22.68			
			8	4	23.00	22.40	22.43	22.52			
			8	7	23.00	22.41	22.53	22.49			
			15	0	23.00	22.33	22.44	22.67			
		16QAM	1	0	23.50	22.48	22.27	23.30			
			1	7	23.50	22.55	22.84	23.19			
			1	14	23.50	22.40	23.02	23.40			
			8	0	22.00	21.34	21.45	21.55			
			8	4	22.00	21.43	21.52	21.38			
			8	7	22.00	21.49	21.59	21.60			
			15	0	22.00	21.37	21.52	21.71			
			Band	Band Width	Modulation	RB Configuration		Tune-up	Channel/Frequency(MHz)		
						RB Size	RB Offset		19975/1712.5	20175/1732.5	20375/1752.5
LTE Band 4	5MHz	QPSK	1	0	24.00	23.54	23.22	23.41			
			1	12	24.00	23.45	23.54	23.47			
			1	24	24.00	23.20	23.54	23.68			
			12	0	23.00	22.39	22.29	22.64			
			12	6	23.00	22.38	22.39	22.47			
			12	11	23.00	22.39	22.51	22.45			
			25	0	23.00	22.31	22.43	22.65			
		16QAM	1	0	23.50	22.45	22.23	23.27			
			1	12	23.50	22.52	22.82	23.16			
			1	24	23.50	22.37	23.00	23.36			
			12	0	22.00	21.32	21.41	21.52			
			12	6	22.00	21.40	21.47	21.34			
			12	11	22.00	21.46	21.54	21.56			
			25	0	22.00	21.35	21.48	21.66			
Band	Band Width	Modulation	RB Configuration		Tune-up	Channel/Frequency(MHz)					
			RB Size	RB Offset		20000/1715	20175/1732.5	20350/1750			
LTE Band 4	10MHz	QPSK	1	0	24.00	23.56	23.23	23.44			
			1	24	24.00	23.48	23.59	23.51			
			1	49	24.00	23.22	23.58	23.71			
			25	0	23.00	22.42	22.34	22.68			
			25	12	23.00	22.41	22.44	22.51			
			25	24	23.00	22.41	22.55	22.50			
			50	0	23.00	22.39	22.45	22.69			
		16QAM	1	0	23.50	22.47	22.26	23.29			
			1	24	23.50	22.55	22.86	23.19			
			1	49	23.50	22.40	23.02	23.39			
			25	0	22.00	21.35	21.46	21.56			
			25	12	22.00	21.42	21.51	21.37			
			25	24	22.00	21.49	21.59	21.60			
			50	0	22.00	21.38	21.53	21.70			
Band	Band Width	Modulation	RB Configuration		Tune-up	Channel/Frequency(MHz)					
			RB Size	RB Offset		20025/1717.5	20175/1732.5	20325/1747.5			

LTE Band 4	15MHz	QPSK	1	0	24.00	23.55	23.19	23.42
			1	37	24.00	23.46	23.58	23.48
			1	74	24.00	23.19	23.53	23.67
			36	0	23.00	22.40	22.30	22.65
			36	18	23.00	22.38	22.39	22.47
			36	37	23.00	22.38	22.52	22.46
			75	0	23.00	22.37	22.41	22.64
		16QAM	1	0	23.50	22.42	22.24	23.27
			1	37	23.50	22.53	22.83	23.17
			1	74	23.50	22.37	22.98	23.36
			36	0	22.00	21.32	21.44	21.53
			36	18	22.00	21.39	21.46	21.33
			36	37	22.00	21.47	21.55	21.57
			75	0	22.00	21.35	21.48	21.66
Band	Band Width	Modulation	RB Configuration		Tune-up	Channel/Frequency(MHz)		
			RB Size	RB Offset		20050/1720	20175/1732.5	20300/1745
LTE Band 4	20MHz	QPSK	1	0	24.00	23.52	23.15	23.39
			1	49	24.00	23.45	23.54	23.46
			1	99	24.00	23.17	23.52	23.64
			50	0	23.00	22.37	22.25	22.61
			50	24	23.00	22.36	22.35	22.44
			50	49	23.00	22.35	22.47	22.42
			100	0	23.00	22.34	22.36	22.60
		16QAM	1	0	23.50	22.40	22.20	23.22
			1	49	23.50	22.49	22.81	23.13
			1	99	23.50	22.35	22.95	23.34
			50	0	22.00	21.29	21.40	21.50
			50	24	22.00	21.36	21.44	21.30
			50	49	22.00	21.44	21.50	21.53
			100	0	22.00	21.33	21.44	21.63

Band	Band Width	Modulation	RB Configuration		Tune-up	Channel/Frequency(MHz)		
			RB Size	RB Offset		20407/824.7	20525/836.5	20643/848.3
LTE Band 5	1.4MHz	QPSK	1	0	24.50	23.81	23.90	23.80
			1	2	24.50	23.88	23.90	24.01
			1	5	24.50	23.97	23.90	23.77
			3	0	24.00	23.67	23.70	23.75
			3	1	24.00	23.67	23.74	23.78
			3	2	24.00	23.82	23.78	23.77
			6	0	23.00	22.80	22.89	22.87
		16QAM	1	0	23.50	23.44	23.11	22.82
			1	2	23.50	23.14	23.38	22.67
			1	5	23.50	23.25	23.04	22.66
			3	0	23.00	22.60	22.69	22.77
			3	1	23.00	22.78	22.63	22.60
			3	2	23.00	22.80	22.66	22.55
			6	0	22.00	21.68	21.75	21.71

Band	Band Width	Modulation	RB Configuration		Tune-up	Channel/Frequency(MHz)		
			RB Size	RB Offset		20415/825.5	20525/836.5	20635/847.5
LTE Band 5	3MHz	QPSK	1	0	24.50	23.83	23.94	23.83
			1	7	24.50	23.91	23.95	24.05
			1	14	24.50	24.00	23.95	23.81
			8	0	23.00	22.77	22.82	22.88
			8	4	23.00	22.79	22.84	22.90
			8	7	23.00	22.92	22.89	22.87
			15	0	23.00	22.83	22.93	22.90
		16QAM	1	0	23.50	23.47	23.13	22.85
			1	7	23.50	23.17	23.43	22.71
			1	14	23.50	23.27	23.08	22.69
			8	0	22.00	21.71	21.82	21.89
			8	4	22.00	21.89	21.76	21.72
			8	7	22.00	21.90	21.78	21.68
			15	0	22.00	21.71	21.79	21.74
Band	Band Width	Modulation	RB Configuration		Tune-up	Channel/Frequency(MHz)		
			RB Size	RB Offset		20425/826.5	20525/836.5	20625/846.5
LTE Band 5	5MHz	QPSK	1	0	24.50	23.81	23.89	23.80
			1	12	24.50	23.90	23.95	24.03
			1	24	24.50	23.96	23.89	23.76
			12	0	23.00	22.75	22.78	22.85
			12	6	23.00	22.77	22.80	22.85
			12	11	23.00	22.89	22.88	22.84
			25	0	23.00	22.87	22.90	22.87
		16QAM	1	0	23.50	23.41	23.10	22.82
			1	12	23.50	23.15	23.42	22.69
			1	24	23.50	23.24	23.04	22.65
			12	0	22.00	21.69	21.81	21.87
			12	6	22.00	21.85	21.70	21.67
			12	11	22.00	21.88	21.74	21.65
			25	0	22.00	21.69	21.75	21.69
Band	Band Width	Modulation	RB Configuration		Tune-up	Channel/Frequency(MHz)		
			RB Size	RB Offset		20450/829	20525/836.5	20600/844
LTE Band 5	10MHz	QPSK	1	0	24.50	23.78	23.85	23.77
			1	24	24.50	23.89	23.91	24.01
			1	49	24.50	23.94	23.88	23.73
			25	0	23.00	22.72	22.73	22.81
			25	12	23.00	22.75	22.76	22.82
			25	24	23.00	22.86	22.83	22.80
			50	0	23.00	22.84	22.85	22.83
		16QAM	1	0	23.50	23.39	23.06	22.77
			1	24	23.50	23.11	23.40	22.65
			1	49	23.50	23.22	23.01	22.63
			25	0	22.00	21.66	21.77	21.84

			25	12	22.00	21.82	21.68	21.64
			25	24	22.00	21.85	21.69	21.61
			50	0	22.00	21.67	21.71	21.66

Band	Band Width	Modulation	RB Configuration		Tune-up	Channel/Frequency(MHz)		
			RB Size	RB Offset		23017/699.7	23095/707.5	23173/715.3
LTE Band 12	1.4MHz	QPSK	1	0	24.00	23.63	23.64	23.61
			1	2	24.00	23.67	23.57	23.69
			1	5	24.00	23.61	23.50	23.70
			3	0	24.00	23.50	23.54	23.63
			3	1	24.00	23.45	23.50	23.54
			3	2	24.00	23.66	23.62	23.63
		16QAM	6	0	23.00	22.61	22.57	22.65
			1	0	23.50	22.95	22.18	22.96
			1	2	23.50	22.94	22.55	23.20
			1	5	23.50	22.76	22.36	22.86
			3	0	23.00	22.58	22.60	22.74
			3	1	23.00	22.52	22.50	22.51
			3	2	23.00	22.52	22.58	22.46
			6	0	22.00	21.71	21.63	21.84
Band	Band Width	Modulation	RB Configuration		Tune-up	Channel/Frequency(MHz)		
			RB Size	RB Offset		23025/700.5	23095/707.5	23165/714.5
LTE Band 12	3MHz	QPSK	1	0	24.00	23.65	23.68	23.64
			1	7	24.00	23.70	23.62	23.73
			1	14	24.00	23.64	23.55	23.74
			8	0	23.00	22.60	22.66	22.76
			8	4	23.00	22.57	22.60	22.66
			8	7	23.00	22.76	22.73	22.73
		16QAM	15	0	23.00	22.64	22.61	22.68
			1	0	23.50	22.98	22.20	22.99
			1	7	23.50	22.97	22.60	23.24
			1	14	23.50	22.78	22.40	22.89
			8	0	22.00	21.69	21.73	21.86
			8	4	22.00	21.63	21.63	21.63
			8	7	22.00	21.62	21.70	21.59
			15	0	22.00	21.74	21.67	21.87
Band	Band Width	Modulation	RB Configuration		Tune-up	Channel/Frequency(MHz)		
			RB Size	RB Offset		23035/701.5	23095/707.5	23155/713.5
LTE Band 12	5MHz	QPSK	1	0	24.00	23.63	23.63	23.61
			1	12	24.00	23.69	23.62	23.71
			1	24	24.00	23.60	23.49	23.69
			12	0	23.00	22.58	22.62	22.73
			12	6	23.00	22.55	22.56	22.61
			12	11	23.00	22.73	22.72	22.70
			25	0	23.00	22.68	22.58	22.65
		16QAM	1	0	23.50	22.92	22.17	22.96

Band	Band Width	Modulation	RB Configuration		Tune-up	Channel/Frequency(MHz)		
			RB Size	RB Offset		23060/704	23095/707.5	23130/711
LTE Band 12	10MHz	QPSK	1	12	23.50	22.95	22.59	23.22
			1	24	23.50	22.75	22.36	22.85
			12	0	22.00	21.67	21.72	21.84
			12	6	22.00	21.59	21.57	21.58
			12	11	22.00	21.60	21.66	21.56
			25	0	22.00	21.72	21.63	21.82
		16QAM	1	0	24.00	23.60	23.59	23.58
			1	24	24.00	23.68	23.58	23.69
			1	49	24.00	23.58	23.48	23.66
			25	0	23.00	22.55	22.57	22.69
			25	12	23.00	22.53	22.52	22.58
			25	24	23.00	22.70	22.67	22.66
			50	0	23.00	22.65	22.53	22.61
			50	0	22.00	21.70	21.59	21.79

Band	Band Width	Modulation	RB Configuration		Tune-up	Channel/Frequency(MHz)		
			RB Size	RB Offset		23205/779.5	23230/782	23255/784.5
LTE Band 13	5MHz	QPSK	1	0	24.00	23.72	23.63	23.78
			1	12	24.00	23.79	23.68	23.77
			1	24	24.00	23.58	23.69	23.65
			12	0	23.00	22.87	22.77	22.82
			12	6	23.00	22.85	22.80	22.86
			12	11	23.00	22.75	22.82	22.83
		16QAM	25	0	23.00	22.81	22.74	22.80
			1	0	23.50	23.06	22.41	22.60
			1	12	23.50	23.14	22.45	22.35
			1	24	23.50	23.03	22.16	22.43
			12	0	22.00	21.50	21.52	21.68
			12	6	22.00	21.63	21.75	21.65
			12	11	22.00	21.76	21.60	21.57
			25	0	22.00	21.74	21.96	21.62

Band	Band Width	Modulation	RB Configuration		Tune-up	Channel/Frequency(MHz)		
			RB Size	RB Offset		/	23230/782	/
LTE Band 13	10MHz	QPSK	1	0	24.00	/	23.76	/
			1	24	24.00	/	23.85	/
			1	49	24.00	/	23.71	/
			25	0	23.00	/	22.87	/
			25	12	23.00	/	22.79	/

		16QAM	25	24	23.00	/	22.88	/
			50	0	23.00	/	22.74	/
			1	0	23.50	/	23.11	/
			1	24	23.50	/	23.41	/
			1	49	23.50	/	22.94	/
			25	0	22.00	/	21.78	/
			25	12	22.00	/	21.83	/
			25	24	22.00	/	21.88	/
			50	0	22.00	/	21.82	/

Band	Band Width	Modulation	RB Configuration		Tune-up	Channel/Frequency(MHz)		
			RB Size	RB Offset		23305/790.5	23330/793	23355/795.5
LTE Band 14	5MHz	QPSK	1	0	24.00	23.81	23.59	23.59
			1	12	24.00	23.64	23.84	23.75
			1	24	24.00	23.68	23.88	23.90
			12	0	23.00	22.83	22.83	22.75
			12	6	23.00	22.77	22.80	22.71
			12	11	23.00	22.82	22.85	22.77
		16QAM	25	0	23.00	22.89	22.76	22.73
			1	0	23.00	22.50	22.47	22.42
			1	12	23.00	22.38	22.61	22.54
			1	24	23.00	22.21	22.57	22.22
			12	0	22.00	21.65	21.68	21.74
			12	6	22.00	21.84	21.59	21.85
			12	11	22.00	21.67	21.50	21.65
25	0	22.00	21.77	21.73	21.69			

Band	Band Width	Modulation	RB Configuration		Tune-up	Channel/Frequency(MHz)		
			RB Size	RB Offset		/	23330/793	/

LTE Band 14	10MHz	QPSK	1	0	24.00	/	23.73	/
			1	24	24.00	/	23.85	/
			1	49	24.00	/	23.53	/
			25	0	23.00	/	22.84	/
			25	12	23.00	/	22.78	/
			25	24	23.00	/	22.82	/
		16QAM	50	0	23.00	/	22.83	/
			1	0	23.50	/	22.70	/
			1	24	23.50	/	23.38	/
			1	49	23.50	/	22.85	/
			25	0	22.00	/	21.64	/
			25	12	22.00	/	21.80	/
			25	24	22.00	/	21.76	/
50	0	22.00	/	21.77	/			

Band	Band Width	Modulation	RB Configuration		Tune-up	Channel/Frequency(MHz)		
			RB Size	RB Offset		131979/1710.7	132322/1745	132665/1779.3

LTE Band 66	1.4MHz	QPSK	1	0	24.00	23.42	23.57	23.56
			1	2	24.00	23.30	23.76	23.57
			1	5	24.00	23.37	23.64	23.45
			3	0	24.00	23.47	23.58	23.26
			3	1	24.00	23.35	23.75	23.33
			3	2	24.00	23.59	23.55	23.36
			6	0	23.00	22.51	22.73	22.34
		16QAM	1	0	23.00	22.84	22.38	22.20
			1	2	23.00	22.43	22.76	22.57
			1	5	23.00	22.57	22.42	22.22
			3	0	23.00	22.53	22.57	22.27
			3	1	23.00	22.32	22.76	22.43
			3	2	23.00	22.69	22.62	22.45
			6	0	22.00	21.65	21.84	21.45
Band	Band Width	Modulation	RB Configuration		Tune-up	Channel/Frequency(MHz)		
			RB Size	RB Offset		131987/1711.5	132322/1745	132657/1778.5
LTE Band 66	3MHz	QPSK	1	0	24.00	23.44	23.61	23.59
			1	7	24.00	23.33	23.81	23.61
			1	14	24.00	23.40	23.69	23.49
			8	0	23.00	22.57	22.70	22.39
			8	4	23.00	22.47	22.85	22.45
			8	7	23.00	22.69	22.66	22.46
			15	0	23.00	22.54	22.77	22.37
		16QAM	1	0	23.00	22.87	22.40	22.23
			1	7	23.00	22.46	22.81	22.61
			1	14	23.00	22.59	22.46	22.25
			8	0	22.00	21.64	21.70	21.39
			8	4	22.00	21.43	21.89	21.55
			8	7	22.00	21.79	21.74	21.58
			15	0	22.00	21.68	21.88	21.48
Band	Band Width	Modulation	RB Configuration		Tune-up	Channel/Frequency(MHz)		
			RB Size	RB Offset		131997/1712.5	132322/1745	132647/1777.5
LTE Band 66	5MHz	QPSK	1	0	24.00	23.41	23.59	23.55
			1	12	24.00	23.31	23.77	23.58
			1	24	24.00	23.37	23.64	23.45
			12	0	23.00	22.54	22.65	22.35
			12	6	23.00	22.45	22.81	22.40
			12	11	23.00	22.67	22.64	22.42
			25	0	23.00	22.52	22.76	22.35
		16QAM	1	0	23.00	22.84	22.36	22.20
			1	12	23.00	22.43	22.79	22.58
			1	24	23.00	22.56	22.44	22.21
			12	0	22.00	21.62	21.66	21.36
			12	6	22.00	21.40	21.84	21.51
			12	11	22.00	21.76	21.69	21.54
			25	0	22.00	21.66	21.84	21.43
Band	Band	Modulation	RB		Tune-up	Channel/Frequency(MHz)		

	Width		Configuration					
			RB Size	RB Offset		132022/1715	132322/1745	132622/1775
LTE Band 66	10MHz	QPSK	1	0	24.00	23.43	23.60	23.58
			1	24	24.00	23.34	23.82	23.62
			1	49	24.00	23.39	23.68	23.48
			25	0	23.00	22.57	22.70	22.39
			25	12	23.00	22.48	22.86	22.44
			25	24	23.00	22.69	22.68	22.47
		16QAM	50	0	23.00	22.60	22.78	22.39
			1	0	23.00	22.86	22.39	22.22
			1	24	23.00	22.46	22.83	22.61
			1	49	23.00	22.59	22.46	22.24
			25	0	22.00	21.65	21.71	21.40
			25	12	22.00	21.42	21.88	21.54
			25	24	22.00	21.79	21.74	21.58
			50	0	22.00	21.69	21.89	21.47
Band	Band Width	Modulation	RB Configuration		Tune-up	Channel/Frequency(MHz)		
			RB Size	RB Offset		132047/1717.5	132322/1745	132597/1772.5
LTE Band 66	15MHz	QPSK	1	0	24.00	23.42	23.56	23.56
			1	37	24.00	23.32	23.81	23.59
			1	74	24.00	23.36	23.63	23.44
			36	0	23.00	22.55	22.66	22.36
			36	18	23.00	22.45	22.81	22.40
			36	37	23.00	22.66	22.65	22.43
		16QAM	75	0	23.00	22.58	22.74	22.34
			1	0	23.00	22.81	22.37	22.20
			1	37	23.00	22.44	22.80	22.59
			1	74	23.00	22.56	22.42	22.21
			36	0	22.00	21.62	21.69	21.37
			36	18	22.00	21.39	21.83	21.50
			36	37	22.00	21.77	21.70	21.55
			75	0	22.00	21.66	21.84	21.43
Band	Band Width	Modulation	RB Configuration		Tune-up	Channel/Frequency(MHz)		
			RB Size	RB Offset		132072/1720	132322/1745	132572/1770
LTE Band 66	20MHz	QPSK	1	0	24.00	23.39	23.52	23.53
			1	49	24.00	23.31	23.77	23.57
			1	99	24.00	23.34	23.62	23.41
			50	0	23.00	22.52	22.61	22.32
			50	24	23.00	22.43	22.77	22.37
			50	49	23.00	22.63	22.60	22.39
			100	0	23.00	22.55	22.69	22.30
		16QAM	1	0	23.00	22.79	22.33	22.15
			1	49	23.00	22.40	22.78	22.55
			1	99	23.00	22.54	22.39	22.19
			50	0	22.00	21.59	21.65	21.34
			50	24	22.00	21.36	21.81	21.47

			50	49	22.00	21.74	21.65	21.51
			100	0	22.00	21.64	21.80	21.40

Band	Band Width	Modulation	RB Configuration		Tune-up	Channel/Frequency(MHz)		
			RB Size	RB Offset		133147/665.5	133297/680.5	133447/695.5
LTE Band 71	5MHz	QPSK	1	0	23.50	23.15	23.23	22.96
			1	12	23.50	23.44	23.23	23.08
			1	24	23.50	23.25	23.06	23.07
			12	0	22.50	22.15	22.33	22.29
			12	6	22.50	22.20	22.19	22.21
			12	11	22.50	22.38	22.36	22.33
		16QAM	1	0	23.00	22.08	22.64	22.90
			1	12	23.00	22.20	22.85	22.91
			1	24	23.00	22.22	22.43	22.78
			12	0	21.50	21.29	21.23	21.07
			12	6	21.50	21.25	21.28	21.26
			12	11	21.50	21.38	21.23	21.13
			25	0	22.00	21.32	21.50	21.31

Band	Band Width	Modulation	RB Configuration		Tune-up	Channel/Frequency(MHz)		
			RB Size	RB Offset		133172/668	133297/680.5	133422/693
LTE Band 71	10MHz	QPSK	1	0	23.50	23.17	23.24	22.99
			1	24	23.50	23.47	23.28	23.12
			1	49	23.50	23.27	23.10	23.10
			25	0	22.50	22.18	22.38	22.33
			25	12	22.50	22.23	22.24	22.25
			25	24	22.50	22.40	22.40	22.38
			50	0	22.50	22.25	22.42	22.24
		16QAM	1	0	23.00	22.10	22.67	22.92
			1	24	23.00	22.23	22.89	22.94
			1	49	23.00	22.25	22.45	22.81
			25	0	21.50	21.32	21.28	21.11
			25	12	21.50	21.27	21.32	21.29
			25	24	21.50	21.41	21.28	21.17
			50	0	22.00	21.35	21.55	21.35

Band	Band Width	Modulation	RB Configuration		Tune-up	Channel/Frequency(MHz)		
			RB Size	RB Offset		133197/670.5	133297/680.5	133397/690.5
LTE Band 71	15MHz	QPSK	1	0	23.50	23.16	23.01	22.97
			1	37	23.50	23.45	23.11	23.09
			1	74	23.50	23.24	23.09	23.06
			36	0	22.50	22.16	22.25	22.30
			36	18	22.50	22.20	22.21	22.21
			36	37	22.50	22.37	22.13	22.34
			75	0	22.50	22.23	22.11	22.19
		16QAM	1	0	23.00	22.05	22.07	22.90
			1	37	23.00	22.21	22.09	22.92

			1	74	23.00	22.22	22.22	22.78
			36	0	21.50	21.29	21.25	21.08
			36	18	21.50	21.24	21.20	21.25
			36	37	21.50	21.39	21.12	21.14
			75	0	21.50	21.32	21.11	21.31
Band	Band Width	Modulation	RB Configuration		Tune-up	Channel/Frequency(MHz)		
			RB Size	RB Offset		133222/673	133297/680.5	133372/688
LTE Band 71	20MHz	QPSK	1	0	23.50	23.13	23.16	22.94
			1	49	23.50	23.44	23.23	23.07
			1	99	23.50	23.22	23.04	23.03
			50	0	22.50	22.13	22.29	22.26
			50	24	22.50	22.18	22.15	22.18
			50	49	22.50	22.34	22.32	22.30
			100	0	22.50	22.20	22.33	22.15
		16QAM	1	0	23.00	22.03	22.61	22.85
			1	49	23.00	22.17	22.84	22.88
			1	99	23.00	22.20	22.38	22.76
			50	0	21.50	21.26	21.22	21.05
			50	24	21.50	21.21	21.25	21.22
			50	49	21.50	21.36	21.19	21.10
			100	0	21.50	21.30	21.46	21.28

7.3. WLAN & Bluetooth Output Power

7.3.1. Output Power Results Of WLAN

Mode	Channel	Frequency (MHz)	Tune-up	Output Power (dBm)
802.11b	1	2412	13.50	13.18
	6	2437	13.50	12.71
	11	2462	13.50	13.26
802.11g	1	2412	13.50	12.59
	6	2437	13.50	12.45
	11	2462	13.50	13.11
802.11n HT20	1	2412	12.50	12.19
	6	2437	12.50	11.92
	11	2462	12.50	12.21

NOTE: Power measurement results of WLAN 2.4G.

Mode	Channel	Frequency (MHz)	Tune-up	Output Power (dBm)
802.11a	36	5180	7.50	7.27
	40	5200	7.50	7.45
	48	5240	7.50	7.27
802.11n	36	5180	7.50	6.86

(HT20)	40	5200	7.50	7.10
	48	5240	7.50	7.19
802.11n (HT40)	38	5190	7.00	6.32
	46	5230	7.00	6.57
802.11ac (VHT20)	36	5180	8.00	7.13
	40	5200	8.00	7.55
	48	5240	8.00	7.28
802.11ac (VHT40)	38	5190	7.00	6.15
	46	5230	7.00	6.71
802.11ac (VHT80)	42	5210	6.00	6.00

NOTE: Power measurement results of WLAN 5.2G.

Mode	Channel	Frequency (MHz)	Tune-up	Output Power (dBm)
802.11a	149	5745	11.00	9.15
	157	5785	11.00	10.89
	165	5825	11.00	9.91
802.11n (HT20)	149	5745	10.50	8.76
	157	5785	10.50	10.37
	165	5825	10.50	9.56
802.11n (HT40)	151	5755	10.50	10.14
	159	5795	10.50	10.30
802.11ac (VHT20)	149	5745	10.00	8.91
	165	5825	10.00	9.92
802.11ac (VHT40)	151	5755	10.50	9.79
	159	5795	10.50	10.12
802.11ac (VHT80)	155	5775	10.00	9.77

NOTE: Power measurement results of WLAN 5.8G.

7.3.2. Output Power Results Of Bluetooth

BR+EDR	Output Power (dBm)				
	Data Rates	Tune-up	Channel		
			0CH	39CH	78CH
1M	4.710	2.712	4.702	4.206	
2M	2.500	0.732	2.353	1.362	
3M	3.000	1.197	2.737	1.659	

BLE	Channel	Tune-up	Output Power (dBm)
-----	---------	---------	--------------------

	0CH	0.000	-0.892
	19CH	1.000	0.327
	39CH	-1.000	-1.048

8. Antenna Location

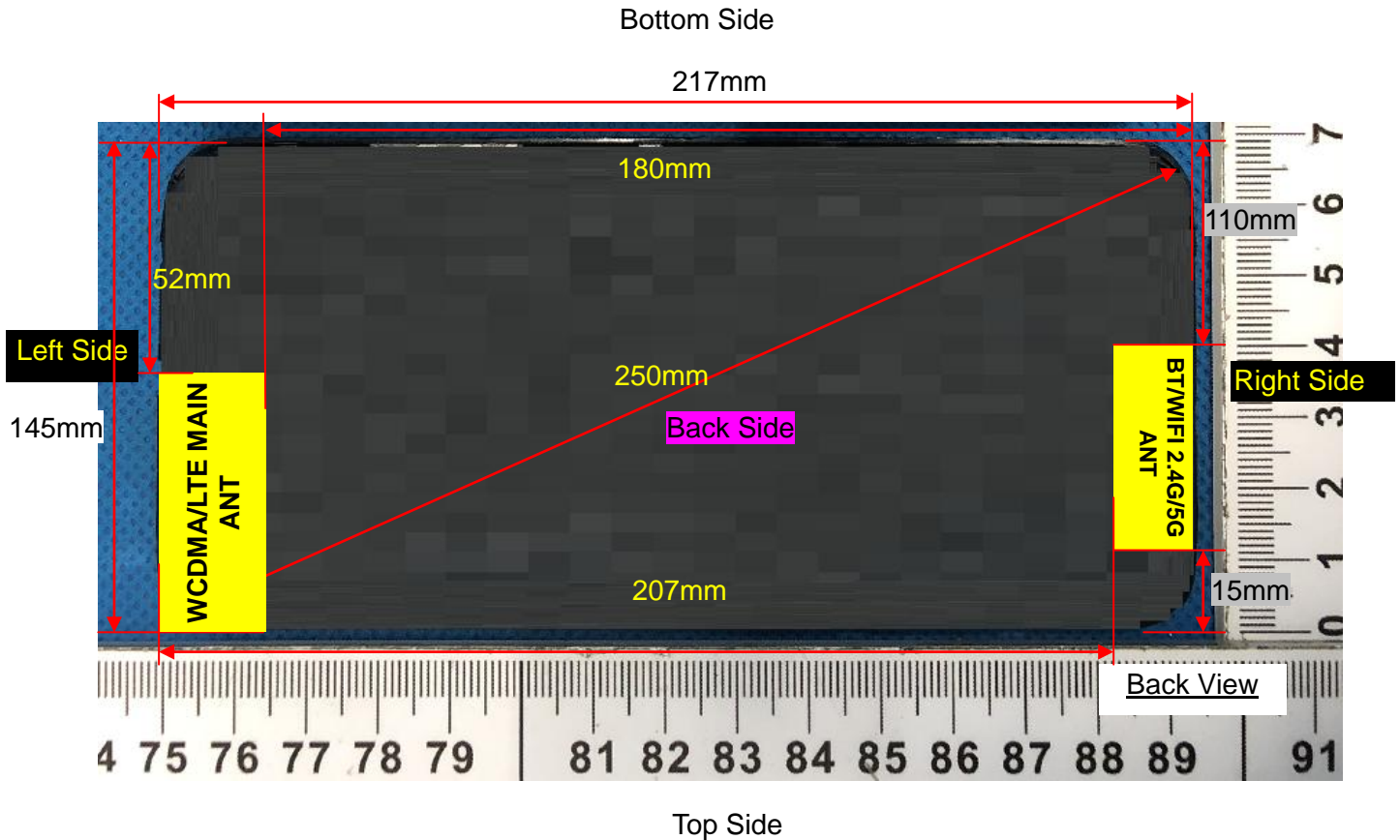

Note: Since the confidentiality request of EUT, the antenna location example diagram see as above.

Distance of the Antenna to the EUT surface/edge						
Antennas	Front Side	Back Side	Left Side	Right Side	Top Side	Bottom Side
WWAN Main	/	5	5	180	5	52
WLAN & Bluetooth	/	5	207	5	15	110

Note: When the minimum separation distance is < 5 mm, a distance of 5 mm is applied to determine SAR test exclusion.

Positions for SAR tests		
Test separation distances \leq 50 mm		
Exposure Positions	Tune-up Maximum power of WLAN 2.4G	
	13.50dBm	
Back Side	Antenna to user(mm)	5
	SAR exclusion threshold	7.0
	SAR testing required?	YES
Right Side	Antenna to user(mm)	5
	SAR exclusion threshold	7.0
	SAR testing required?	YES
Top Side	Antenna to user(mm)	15
	SAR exclusion threshold	2.3
	SAR testing required?	NO
Exposure Positions	Tune-up Maximum power of WLAN 5.8G	
	11.00dBm	
Back Side	Antenna to user(mm)	5
	SAR exclusion threshold	6.1
	SAR testing required?	YES
Right Side	Antenna to user(mm)	5
	SAR exclusion threshold	6.1
	SAR testing required?	YES
Top Side	Antenna to user(mm)	15
	SAR exclusion threshold	2.0
	SAR testing required?	NO
Exposure Positions	Tune-up Maximum power of WCDMA Band 2	
	23.50dBm	
Back Side	Antenna to user(mm)	5
	SAR exclusion threshold	61.9
	SAR testing required?	YES
Left Side	Antenna to user(mm)	5
	SAR exclusion threshold	61.9
	SAR testing required?	YES
Top Side	Antenna to user(mm)	5
	SAR exclusion threshold	61.9
	SAR testing required?	YES
Exposure Positions	Tune-up Maximum power of WCDMA Band 4	
	23.50dBm	
Back Side	Antenna to user(mm)	5
	SAR exclusion threshold	59.3

	SAR testing required?	YES
Left Side	Antenna to user(mm)	5
	SAR exclusion threshold	59.3
	SAR testing required?	YES
Top Side	Antenna to user(mm)	5
	SAR exclusion threshold	59.3
	SAR testing required?	YES
Exposure Positions	Tune-up Maximum power of WCDMA Band 5	
	23.50dBm	
Back Side	Antenna to user(mm)	5
	SAR exclusion threshold	41.3
	SAR testing required?	YES
Left Side	Antenna to user(mm)	5
	SAR exclusion threshold	41.3
	SAR testing required?	YES
Top Side	Antenna to user(mm)	5
	SAR exclusion threshold	41.3
	SAR testing required?	YES
Exposure Positions	Tune-up Maximum power of LTE Band 2	
	24.00dBm	
Back Side	Antenna to user(mm)	5
	SAR exclusion threshold	69.4
	SAR testing required?	YES
Left Side	Antenna to user(mm)	5
	SAR exclusion threshold	69.4
	SAR testing required?	YES
Top Side	Antenna to user(mm)	5
	SAR exclusion threshold	69.4
	SAR testing required?	YES
Exposure Positions	Tune-up Maximum power of LTE Band 4	
	24.00dBm	
Back Side	Antenna to user(mm)	5
	SAR exclusion threshold	66.6
	SAR testing required?	YES
Left Side	Antenna to user(mm)	5
	SAR exclusion threshold	66.6
	SAR testing required?	YES
Top Side	Antenna to user(mm)	5
	SAR exclusion threshold	66.6
	SAR testing required?	YES

Exposure Positions	Tune-up Maximum power of LTE Band 5	
	24.50dBm	
Back Side	Antenna to user(mm)	5
	SAR exclusion threshold	52.0
	SAR testing required?	YES
Left Side	Antenna to user(mm)	5
	SAR exclusion threshold	52.0
	SAR testing required?	YES
Top Side	Antenna to user(mm)	5
	SAR exclusion threshold	52.0
	SAR testing required?	YES
Exposure Positions	Tune-up Maximum power of LTE Band 12	
	24.00dBm	
Back Side	Antenna to user(mm)	5
	SAR exclusion threshold	42.5
	SAR testing required?	YES
Left Side	Antenna to user(mm)	5
	SAR exclusion threshold	42.5
	SAR testing required?	YES
Top Side	Antenna to user(mm)	5
	SAR exclusion threshold	42.5
	SAR testing required?	YES
Exposure Positions	Tune-up Maximum power of LTE Band 13	
	24.00dBm	
Back Side	Antenna to user(mm)	5
	SAR exclusion threshold	44.6
	SAR testing required?	YES
Left Side	Antenna to user(mm)	5
	SAR exclusion threshold	44.6
	SAR testing required?	YES
Top Side	Antenna to user(mm)	5
	SAR exclusion threshold	44.6
	SAR testing required?	YES
Exposure Positions	Tune-up Maximum power of LTE Band 14	
	24.00dBm	
Back Side	Antenna to user(mm)	5
	SAR exclusion threshold	44.9
	SAR testing required?	YES
Left Side	Antenna to user(mm)	5
	SAR exclusion threshold	44.9

	SAR testing required?	YES
Top Side	Antenna to user(mm)	5
	SAR exclusion threshold	44.9
	SAR testing required?	YES
Exposure Positions	Tune-up Maximum power of LTE Band 66	
	24.00dBm	
Back Side	Antenna to user(mm)	5
	SAR exclusion threshold	67.0
	SAR testing required?	YES
Left Side	Antenna to user(mm)	5
	SAR exclusion threshold	67.0
	SAR testing required?	YES
Top Side	Antenna to user(mm)	5
	SAR exclusion threshold	67.0
	SAR testing required?	YES
Exposure Positions	Tune-up Maximum power of LTE Band 71	
	23.50dBm	
Back Side	Antenna to user(mm)	5
	SAR exclusion threshold	37.4
	SAR testing required?	YES
Left Side	Antenna to user(mm)	5
	SAR exclusion threshold	37.4
	SAR testing required?	YES
Top Side	Antenna to user(mm)	5
	SAR exclusion threshold	37.4
	SAR testing required?	YES

NOTE: Refer to section 4.3.1 of KDB 447498 D01.

Positions for SAR tests		
Test separation distances > 50 mm		
Exposure Positions	Tune-up Maximum power of WLAN 2.4G	
	13.50dBm	22.39mW
Left Side	Antenna to user(mm)	207
	SAR exclusion threshold(mW)	1666
	SAR testing required?	NO
Bottom Side	Antenna to user(mm)	110
	SAR exclusion threshold(mW)	696
	SAR testing required?	NO
Exposure Positions	Tune-up Maximum power of WLAN 5.8G	
	11.00dBm	12.59mW

Left Side	Antenna to user(mm)	207
	SAR exclusion threshold(mW)	1632
	SAR testing required?	NO
Bottom Side	Antenna to user(mm)	110
	SAR exclusion threshold(mW)	662
	SAR testing required?	NO
Exposure Positions	Tune-up Maximum power of WCDMA Band 2	
	23.50dBm	223.87mW
Right Side	Antenna to user(mm)	180
	SAR exclusion threshold(mW)	1409
	SAR testing required?	NO
Bottom Side	Antenna to user(mm)	52
	SAR exclusion threshold(mW)	129
	SAR testing required?	YES
Exposure Positions	Tune-up Maximum power of WCDMA Band 4	
	23.50dBm	223.87mW
Right Side	Antenna to user(mm)	180
	SAR exclusion threshold(mW)	1409
	SAR testing required?	NO
Bottom Side	Antenna to user(mm)	52
	SAR exclusion threshold(mW)	129
	SAR testing required?	YES
Exposure Positions	Tune-up Maximum power of WCDMA Band 5	
	23.50dBm	223.87mW
Right Side	Antenna to user(mm)	180
	SAR exclusion threshold(mW)	938
	SAR testing required?	NO
Bottom Side	Antenna to user(mm)	52
	SAR exclusion threshold(mW)	170
	SAR testing required?	YES
Exposure Positions	Tune-up Maximum power of LTE Band 2	
	24.00dBm	251.19mW
Right Side	Antenna to user(mm)	180
	SAR exclusion threshold(mW)	1409
	SAR testing required?	NO
Bottom Side	Antenna to user(mm)	52
	SAR exclusion threshold(mW)	129
	SAR testing required?	YES
Exposure Positions	Tune-up Maximum power of LTE Band 4	
	24.00dBm	251.19mW

Right Side	Antenna to user(mm)	180
	SAR exclusion threshold(mW)	1409
	SAR testing required?	NO
Bottom Side	Antenna to user(mm)	52
	SAR exclusion threshold(mW)	129
	SAR testing required?	YES
Exposure Positions	Tune-up Maximum power of LTE Band 5	
	24.50dBm	281.84mW
Right Side	Antenna to user(mm)	180
	SAR exclusion threshold(mW)	938
	SAR testing required?	NO
Bottom Side	Antenna to user(mm)	52
	SAR exclusion threshold(mW)	170
	SAR testing required?	YES
Exposure Positions	Tune-up Maximum power of LTE Band 12	
	24.00dBm	251.19mW
Right Side	Antenna to user(mm)	180
	SAR exclusion threshold(mW)	888
	SAR testing required?	NO
Bottom Side	Antenna to user(mm)	52
	SAR exclusion threshold(mW)	175
	SAR testing required?	YES
Exposure Positions	Tune-up Maximum power of LTE Band 13	
	24.00dBm	251.19mW
Right Side	Antenna to user(mm)	180
	SAR exclusion threshold(mW)	888
	SAR testing required?	NO
Bottom Side	Antenna to user(mm)	52
	SAR exclusion threshold(mW)	175
	SAR testing required?	YES
Exposure Positions	Tune-up Maximum power of LTE Band 14	
	24.00dBm	251.19mW
Right Side	Antenna to user(mm)	180
	SAR exclusion threshold(mW)	888
	SAR testing required?	NO
Bottom Side	Antenna to user(mm)	52
	SAR exclusion threshold(mW)	175
	SAR testing required?	YES
Exposure Positions	Tune-up Maximum power of LTE Band 66	
	24.00dBm	251.19mW

Right Side	Antenna to user(mm)	180
	SAR exclusion threshold(mW)	1409
	SAR testing required?	NO
Bottom Side	Antenna to user(mm)	52
	SAR exclusion threshold(mW)	129
	SAR testing required?	YES
Exposure Positions	Tune-up Maximum power of LTE Band 71	
	23.50dBm	223.87mW
Right Side	Antenna to user(mm)	180
	SAR exclusion threshold(mW)	888
	SAR testing required?	NO
Bottom Side	Antenna to user(mm)	52
	SAR exclusion threshold(mW)	175
	SAR testing required?	YES

NOTE: Refer to section 4.3.1 of KDB 447498 D01.

9. Stand-alone SAR test exclusion

Refer to FCC KDB 447498D01, the 1-g SAR and 10-g SAR test exclusion thresholds for 100 MHz to 6 GHz at test separation distances ≤ 50 mm are determined by:

$[(\text{max. power of channel, including tune-up tolerance, mW})/(\text{min. test separation distance, mm})] \cdot [\sqrt{f_{(\text{GHz})}}]$
 ≤ 3.0 for 1-g SAR and ≤ 7.5 for 10-g extremity SAR, where:

- $f_{(\text{GHz})}$ is the RF channel transmit frequency in GHz
- Power and distance are rounded to the nearest mW and mm before calculation
- The result is rounded to one decimal place for comparison

When the minimum test separation distance is < 5 mm, a distance of 5 mm is applied to determine SAR test exclusion.

Mode	P_{max} (dBm)	P_{max} (mW)	Distance (mm)	f (GHz)	Calculation Result	SAR Exclusion threshold	SAR test exclusion
Bluetooth	4.70	2.95	5	2.480	0.93	3	Yes
WLAN 5.2G	8.00	6.31	5	5.240	2.89	3	Yes

NOTE: Standalone SAR test exclusion for Bluetooth

When standalone SAR test exclusion applies to an antenna that transmits simultaneously with other antennas, the standalone SAR must be estimated according to following to determine simultaneous transmission SAR test exclusion:

$[(\text{max. power of channel, including tune-up tolerance, mW})/(\text{min. test separation distance, mm})] \cdot [\sqrt{f_{(\text{GHz})}/x}]$ W/kg for test separation distances ≤ 50 mm, where $x = 7.5$ for 1-g SAR and $x = 18.75$ for 10-g SAR.

When the minimum test separation distance is < 5 mm, a distance of 5 mm is applied to determine SAR test exclusion.

Mode	Position	P_{max} (dBm)	P_{max} (mW)	Distance (mm)	f (GHz)	x	Estimated SAR (W/Kg)
Bluetooth	Body	4.70	2.95	5	2.48	7.5	0.124
WLAN 5.2G	Body	8.00	6.31	5	5.24	7.5	0.385

NOTE: Estimated SAR calculation for Bluetooth.

10. SAR Results

10.1. SAR measurement results

10.1.1. SAR measurement Result of WCDMA Band 2

Test Position of Body with 0mm	Test channel /Freq.	Test Mode	SAR Value (W/kg)		Power Drift ($\pm 5\%$)	Conducted power (dBm)	Tune-up power (dBm)	Scaled SAR 1g (W/Kg)	Date
			1g	10g					
Back Side	9400/1880	RMC12.2K	1.338	0.752	-0.81	23.05	23.50	1.484	2021/7/5
Back Side Repeated	9400/1880	RMC12.2K	1.330	0.748	2.35	23.05	23.50	1.475	2021/7/5
Left Side	9400/1880	RMC12.2K	0.749	0.408	0.68	23.05	23.50	0.831	2021/7/5
Top Side	9400/1880	RMC12.2K	0.321	0.173	-2.52	23.05	23.50	0.356	2021/7/5
Bottom Side	9400/1880	RMC12.2K	0.187	0.103	-2.01	23.05	23.50	0.207	2021/7/5
Back Side	9262/1852.4	RMC12.2K	1.124	0.600	-2.26	23.19	23.50	1.207	2021/7/5
Back Side	9538/1907.6	RMC12.2K	1.164	0.654	-3.30	23.04	23.50	1.294	2021/7/5

NOTE: Body SAR test results of WCDMA Band 2

10.1.2. SAR measurement Result of WCDMA Band 4

Test Position of Body with 0mm	Test channel /Freq.	Test Mode	SAR Value (W/kg)		Power Drift ($\pm 5\%$)	Conducted power (dBm)	Tune-up power (dBm)	Scaled SAR 1g (W/Kg)	Date
			1g	10g					
Back Side	1413/1732.6	RMC12.2K	1.128	0.608	4.93	23.35	23.50	1.168	2021/7/1
Back Side Repeated	1413/1732.6	RMC12.2K	1.120	0.600	1.25	23.35	23.50	1.159	2021/7/1
Left Side	1413/1732.6	RMC12.2K	0.770	0.398	0.41	23.35	23.50	0.797	2021/7/1
Top Side	1413/1732.6	RMC12.2K	0.332	0.173	-0.61	23.35	23.50	0.344	2021/7/1
Bottom Side	1413/1732.6	RMC12.2K	0.133	0.070	-3.47	23.35	23.50	0.138	2021/7/1
Back Side	1312/1712.4	RMC12.2K	0.995	0.576	3.06	23.46	23.50	1.004	2021/7/1
Back Side	1513/1752.6	RMC12.2K	1.105	0.593	-3.72	23.37	23.50	1.139	2021/7/1

NOTE: Body SAR test results of WCDMA Band 4

10.1.3. SAR measurement Result of WCDMA Band 5

Test Position of	Test channel	Test Mode	SAR Value (W/kg)	Power Drift	Conducted power	Tune-up power	Scaled SAR	Date
------------------	--------------	-----------	------------------	-------------	-----------------	---------------	------------	------

Body with 0mm	/Freq.		1g	10g	(±5%)	(dBm)	(dBm)	1g (W/Kg)	
Back Side	4183/836.6	RMC12.2K	1.018	0.596	-0.58	23.19	23.50	1.093	2021/6/29
Back Side Repeated	4183/836.6	RMC12.2K	1.010	0.590	1.25	23.19	23.50	1.085	2021/6/29
Left Side	4183/836.6	RMC12.2K	0.611	0.358	-3.82	23.19	23.50	0.656	2021/6/29
Top Side	4183/836.6	RMC12.2K	0.244	0.141	0.33	23.19	23.50	0.262	2021/6/29
Bottom Side	4183/836.6	RMC12.2K	0.143	0.082	-0.71	23.19	23.50	0.154	2021/6/29
Back Side	4132/826.4	RMC12.2K	0.979	0.572	0.04	23.21	23.50	1.047	2021/6/29
Back Side	4233/846.6	RMC12.2K	0.997	0.588	-0.06	23.19	23.50	1.071	2021/6/29

NOTE: Body SAR test results of WCDMA Band 5

10.1.4. SAR measurement Result of LTE Band 2

Test Position of Body with 0mm	Test channel /Freq.	Test Mode	SAR Value (W/kg)		Power Drift (±5%)	Conducted power (dBm)	Tune-up power (dBm)	Scaled SAR 1g (W/Kg)	Date
			1g	10g					
1RB									
Back Side	18900/1880	20M QPSK(1,49)	0.748	0.475	-1.71	23.80	24.00	0.783	2021/7/5
Left Side	18900/1880	20M QPSK(1,49)	0.516	0.256	-2.47	23.80	24.00	0.540	2021/7/5
Top Side	18900/1880	20M QPSK(1,49)	0.208	0.101	0.71	23.80	24.00	0.218	2021/7/5
Bottom Side	18900/1880	20M QPSK(1,49)	0.091	0.046	-2.38	23.80	24.00	0.095	2021/7/5
Back Side	18700/1860	20M QPSK(1,49)	0.905	0.454	2.05	23.42	24.00	1.034	2021/7/5
Back Side Repeated	18700/1860	20M QPSK(1,49)	0.896	0.448	1.23	23.42	24.00	1.024	2021/7/5
Back Side	19100/1900	20M QPSK(1,49)	0.811	0.407	-0.12	22.99	24.00	1.023	2021/7/5
50%RB									
Back Side	18900/1880	20M QPSK(50,49)	0.424	0.266	2.98	22.31	22.50	0.443	2021/7/5
Left Side	18900/1880	20M QPSK(50,49)	0.293	0.143	-3.12	22.31	22.50	0.306	2021/7/5
Top Side	18900/1880	20M QPSK(50,49)	0.120	0.058	-3.43	22.31	22.50	0.125	2021/7/5
Bottom Side	18900/1880	20M QPSK(50,49)	0.046	0.025	0.87	22.31	22.50	0.048	2021/7/5

100%									
Back Side	18900/1880	20M QPSK(100,0)	0.416	0.264	1.25	22.45	22.50	0.421	2021/7/5

OTE: Body SAR test results of LTE Band 2

10.1.5. SAR measurement Result of LTE Band 4

Test Position of Body with 0mm	Test channel /Freq.	Test Mode	SAR Value (W/kg)		Power Drift (±5%)	Conducted power (dBm)	Tune-up power (dBm)	Scaled SAR 1g (W/Kg)	Date
			1g	10g					
1RB									
Back Side	20175/1732.5	20M QPSK(1,99)	0.842	0.438	1.83	23.52	24.00	0.940	2021/7/1
Left Side	20175/1732.5	20M QPSK(1,99)	0.506	0.255	2.83	23.52	24.00	0.565	2021/7/1
Top Side	20175/1732.5	20M QPSK(1,99)	0.206	0.106	3.15	23.52	24.00	0.230	2021/7/1
Bottom Side	20175/1732.5	20M QPSK(1,99)	0.120	0.061	-1.77	23.52	24.00	0.134	2021/7/1
Back Side	20050/1720	20M QPSK(1,99)	0.857	0.455	-1.62	23.17	24.00	1.037	2021/7/1
Back Side Repeated	20050/1720	20M QPSK(1,99)	0.850	0.451	2.35	23.17	24.00	1.029	2021/7/1
Back Side	20300/1745	20M QPSK(1,99)	0.849	0.447	-1.16	23.64	24.00	0.922	2021/7/1
50%RB									
Back Side	20175/1732.5	20M QPSK(50,0)	0.474	0.225	3.42	22.25	23.00	0.563	2021/7/1
Left Side	20175/1732.5	20M QPSK(50,0)	0.282	0.146	-2.77	22.25	23.00	0.335	2021/7/1
Top Side	20175/1732.5	20M QPSK(50,0)	0.104	0.062	-0.94	22.25	23.00	0.124	2021/7/1
Bottom Side	20175/1732.5	20M QPSK(50,0)	0.064	0.034	1.69	22.25	23.00	0.076	2021/7/1
100%									
Back Side	20175/1732.5	20M QPSK(100,0)	0.470	0.223	1.23	22.36	23.00	0.545	2021/7/1

NOTE: Body SAR test results of LTE Band 4

10.1.6. SAR measurement Result of LTE Band 5

Test Position of Body with 0mm	Test channel /Freq.	Test Mode	SAR Value (W/kg)		Power Drift ($\pm 5\%$)	Conducted power (dBm)	Tune-up power (dBm)	Scaled SAR 1g (W/Kg)	Date
			1g	10g					
1RB									
Back Side	20525/836.5	10M QPSK(1,24)	1.014	0.593	0.25	23.91	24.50	1.162	2021/6/29
Left Side	20525/836.5	10M QPSK(1,24)	0.589	0.332	2.31	23.91	24.50	0.675	2021/6/29
Top Side	20525/836.5	10M QPSK(1,24)	0.231	0.131	3.42	23.91	24.50	0.265	2021/6/29
Bottom Side	20525/836.5	10M QPSK(1,24)	0.137	0.080	-0.51	23.91	24.50	0.157	2021/6/29
Back Side	20450/829	10M QPSK(1,24)	1.018	0.594	0.20	23.89	24.50	1.172	2021/6/29
Back Side	20600/844	10M QPSK(1,24)	1.051	0.610	1.94	24.01	24.50	1.177	2021/6/29
Back Side Repeated	20600/844	10M QPSK(1,24)	1.045	0.605	0.23	24.01	24.50	1.170	2021/6/29
50%RB									
Back Side	20525/836.5	10M QPSK(25,24)	0.581	0.307	0.56	22.83	23.00	0.604	2021/6/29
Left Side	20525/836.5	10M QPSK(25,24)	0.328	0.196	-0.41	22.83	23.00	0.341	2021/6/29
Top Side	20525/836.5	10M QPSK(25,24)	0.127	0.077	1.87	22.83	23.00	0.132	2021/6/29
Bottom Side	20525/836.5	10M QPSK(25,24)	0.079	0.048	-1.64	22.83	23.00	0.082	2021/6/29
100%									
Back Side	20525/836.5	10M QPSK(50,0)	0.544	0.286	-1.11	22.85	23.00	0.563	2021/6/29

NOTE: Body SAR test results of LTE Band 5

10.1.7. SAR measurement Result of LTE Band 12

Test Position of Body with 0mm	Test channel /Freq.	Test Mode	SAR Value (W/kg)		Power Drift ($\pm 5\%$)	Conducted power (dBm)	Tune-up power (dBm)	Scaled SAR 1g (W/Kg)	Date
			1g	10g					

1RB									
Back Side	23095/707.5	10M QPSK(1,24)	1.039	0.769	-2.84	23.58	24.00	1.144	2021/6/28
Back Side Repeated	23095/707.5	10M QPSK(1,24)	1.030	0.762	0.24	23.58	24.00	1.135	2021/6/28
Left Side	23095/707.5	10M QPSK(1,24)	0.613	0.454	1.94	23.58	24.00	0.675	2021/6/28
Top Side	23095/707.5	10M QPSK(1,24)	0.218	0.155	-3.69	23.58	24.00	0.240	2021/6/28
Bottom Side	23095/707.5	10M QPSK(1,24)	0.156	0.112	-2.91	23.58	24.00	0.172	2021/6/28
Back Side	23060/704	10M QPSK(1,24)	0.997	0.701	-0.02	23.68	24.00	1.073	2021/6/28
Back Side	23130/711	10M QPSK(1,24)	0.987	0.731	0.87	23.69	24.00	1.060	2021/6/28
50%RB									
Back Side	23095/707.5	10M QPSK(25,24)	0.567	0.388	3.21	22.67	23.00	0.612	2021/6/28
Left Side	23095/707.5	10M QPSK(25,24)	0.324	0.271	2.07	22.67	23.00	0.350	2021/6/28
Top Side	23095/707.5	10M QPSK(25,24)	0.125	0.087	3.85	22.67	23.00	0.135	2021/6/28
Bottom Side	23095/707.5	10M QPSK(25,24)	0.085	0.057	0.87	22.67	23.00	0.092	2021/6/28
100%									
Back Side	23095/707.5	10M QPSK(50,0)	0.559	0.381	0.88	22.53	23.00	0.623	2021/6/28

NOTE: Body SAR test results of LTE Band 12

10.1.8. SAR measurement Result of LTE Band 13

Test Position of Body with 0mm	Test channel /Freq.	Test Mode	SAR Value (W/kg)		Power Drift (±5%)	Conducted power (dBm)	Tune-up power (dBm)	Scaled SAR 1g (W/Kg)	Date
			1g	10g					
1RB									
Back Side	23230/782	10M QPSK(1,24)	1.160	0.703	0.60	23.85	24.00	1.201	2021/6/28
Back Side	23230/782	10M QPSK(1,24)	1.152	0.696	1.34	23.85	24.00	1.192	2021/6/28

Repeated									
Left Side	23230/782	10M QPSK(1,24)	0.673	0.396	-2.46	23.85	24.00	0.697	2021/6/28
Top Side	23230/782	10M QPSK(1,24)	0.232	0.139	1.29	23.85	24.00	0.240	2021/6/28
Bottom Side	23230/782	10M QPSK(1,24)	0.174	0.101	0.56	23.85	24.00	0.180	2021/6/28
50%RB									
Back Side	23230/782	10M QPSK(25,24)	0.655	0.358	-1.80	22.88	23.00	0.673	2021/6/28
Left Side	23230/782	10M QPSK(25,24)	0.370	0.228	-3.92	22.88	23.00	0.380	2021/6/28
Top Side	23230/782	10M QPSK(25,24)	0.133	0.076	-1.90	22.88	23.00	0.137	2021/6/28
Bottom Side	23230/782	10M QPSK(25,24)	0.094	0.059	1.20	22.88	23.00	0.097	2021/6/28
100%									
Back Side	23230/782	10M QPSK(50,0)	0.640	0.349	0.23	22.74	23.00	0.679	2021/6/28

NOTE: Body SAR test results of LTE Band 13

10.1.9. SAR measurement Result of LTE Band 14

Test Position of Body with 0mm	Test channel /Freq.	Test Mode	SAR Value (W/kg)		Power Drift (±5%)	Conducted power (dBm)	Tune-up power (dBm)	Scaled SAR 1g (W/Kg)	Date
			1g	10g					
1RB									
Back Side	23330/793	10M QPSK(1,24)	1.099	0.628	0.78	23.85	24.00	1.138	2021/6/28
Back Side Repeated	23330/793	10M QPSK(1,24)	1.090	0.622	1.48	23.85	24.00	1.128	2021/6/28
Left Side	23330/793	10M QPSK(1,24)	0.604	0.328	3.40	23.85	24.00	0.625	2021/6/28
Top Side	23330/793	10M QPSK(1,24)	0.374	0.203	-0.88	23.85	24.00	0.387	2021/6/28
Bottom Side	23330/793	10M QPSK(1,24)	0.165	0.090	0.01	23.85	24.00	0.171	2021/6/28
50%RB									
Back	23330/793	10M	0.607	0.344	1.09	22.84	23.00	0.630	2021/6/28

Side		QPSK(25,0)							
Left Side	23330/793	10M QPSK(25,0)	0.355	0.178	-1.83	22.84	23.00	0.368	2021/6/28
Top Side	23330/793	10M QPSK(25,0)	0.206	0.102	2.00	22.84	23.00	0.214	2021/6/28
Bottom Side	23330/793	10M QPSK(25,0)	0.083	0.054	0.26	22.84	23.00	0.086	2021/6/28
100%									
Back Side	23330/793	10M QPSK(50,0)	0.582	0.361	-3.52	22.83	23.00	0.605	2021/6/28

NOTE: Body SAR test results of LTE Band 14

10.1.10. SAR measurement Result of LTE Band 66

Test Position of Body with 0mm	Test channel /Freq.	Test Mode	SAR Value (W/kg)		Power Drift (±5%)	Conducted power (dBm)	Tune-up power (dBm)	Scaled SAR 1g (W/Kg)	Date
			1g	10g					
1RB									
Back Side	132322/1745	20M QPSK(1,49)	0.838	0.436	2.01	23.77	24.00	0.884	2021/7/1
Back Side Repeated	132322/1745	20M QPSK(1,49)	0.830	0.430	0.15	23.77	24.00	0.875	2021/7/1
Left Side	132322/1745	20M QPSK(1,49)	0.469	0.242	0.56	23.77	24.00	0.495	2021/7/1
Top Side	132322/1745	20M QPSK(1,49)	0.210	0.108	-1.64	23.77	24.00	0.221	2021/7/1
Bottom Side	132322/1745	20M QPSK(1,49)	0.117	0.058	3.55	23.77	24.00	0.123	2021/7/1
Back Side	132072/1720	20M QPSK(1,49)	0.779	0.401	-3.33	23.31	24.00	0.913	2021/7/1
Back Side	132572/1770	20M QPSK(1,49)	0.737	0.372	2.04	23.57	24.00	0.814	2021/7/1
50%RB									
Back Side	132322/1745	20M QPSK(50,24)	0.486	0.235	-2.80	22.77	23.00	0.512	2021/7/1
Left Side	132322/1745	20M QPSK(50,24)	0.259	0.140	-2.31	22.77	23.00	0.273	2021/7/1
Top Side	132322/1745	20M QPSK(50,24)	0.116	0.064	-0.30	22.77	23.00	0.122	2021/7/1

Bottom Side	132322/1745	20M QPSK(50,24)	0.069	0.034	-0.06	22.77	23.00	0.073	2021/7/1
100%									
Back Side	132322/1745	20M QPSK(100,0)	0.480	0.230	1.23	22.69	23.00	0.516	2021/7/1

NOTE: Body SAR test results of LTE Band 66

10.1.11. SAR measurement Result of LTE Band 71

Test Position of Body with 0mm	Test channel /Freq.	Test Mode	SAR Value (W/kg)		Power Drift (±5%)	Conducted power (dBm)	Tune-up power (dBm)	Scaled SAR 1g (W/Kg)	Date
			1g	10g					
1RB									
Back Side	133297/680.5	20M QPSK(1,49)	0.828	0.431	-0.09	23.23	23.50	0.881	2021/6/28
Back Side Repeated	133297/680.5	20M QPSK(1,49)	0.822	0.425	1.25	23.23	23.50	0.875	2021/6/28
Left Side	133297/680.5	20M QPSK(1,49)	0.497	0.248	0.69	23.23	23.50	0.529	2021/6/28
Top Side	133297/680.5	20M QPSK(1,49)	0.174	0.086	-1.68	23.23	23.50	0.185	2021/6/28
Bottom Side	133297/680.5	20M QPSK(1,49)	0.083	0.042	-0.92	23.23	23.50	0.088	2021/6/28
Back Side	133222/673	20M QPSK(1,49)	0.729	0.372	1.68	23.44	23.50	0.739	2021/6/28
Back Side	133372/688	20M QPSK(1,49)	0.762	0.377	2.20	23.07	23.50	0.841	2021/6/28
50%RB									
Back Side	133297/680.5	20M QPSK(50,49)	0.472	0.218	-2.08	22.32	22.50	0.492	2021/6/28
Left Side	133297/680.5	20M QPSK(50,49)	0.280	0.137	3.87	22.32	22.50	0.292	2021/6/28
Top Side	133297/680.5	20M QPSK(50,49)	0.101	0.046	1.98	22.32	22.50	0.105	2021/6/28
Bottom Side	133297/680.5	20M QPSK(50,49)	0.047	0.022	-0.46	22.32	22.50	0.049	2021/6/28
100%									
Back Side	133297/680.5	20M QPSK(100,0)	0.465	0.213	0.34	22.33	22.50	0.484	2021/6/28

NOTE: Body SAR test results of LTE Band 71

10.1.12. SAR measurement Result of WLAN 2.4G

Test Position of Body with 0mm	Test channel /Freq.	Test Mode	SAR Value (W/kg)		Power Drift ($\pm 5\%$)	Conducted power (dBm)	Tune-up power (dBm)	Scaled SAR 1g (W/Kg)	Date
			1g	10g					
Back Side	6/2437	802.11b	0.150	0.086	-1.98	12.71	13.50	0.180	2021/7/8
Right Side	6/2437	802.11b	0.330	0.150	-2.58	12.71	13.50	0.396	2021/7/8

NOTE: Body SAR test results of WLAN 2.4G

10.1.13. SAR measurement Result of WLAN 5.8G

Test Position of Body with 0mm	Test channel /Freq.	Test Mode	SAR Value (W/kg)		Power Drift ($\pm 5\%$)	Conducted power (dBm)	Tune-up power (dBm)	Scaled SAR 1g (W/Kg)	Date
			1g	10g					
Back Side	157/5785	802.11a	0.172	0.101	2.47	10.89	11.00	0.176	2021/7/13
Right Side	157/5785	802.11a	0.436	0.195	3.56	10.89	11.00	0.447	2021/7/13

NOTE: Body SAR test results of WLAN 5.8G

10.2. SAR Summation Scenario

Per KDB 447498 D01, simultaneous transmission SAR is compliant if,

- Scalar SAR summation $< 1.6\text{W/kg}$.
- $\text{SPLSR} = (\text{SAR}_1 + \text{SAR}_2)^{1.5} / (\text{min. separation distance, mm})$, and the peak separation distance is determined from the square root of $[(x_1-x_2)^2 + (y_1-y_2)^2 + (z_1-z_2)^2]$, where (x_1, y_1, z_1) and (x_2, y_2, z_2) are the coordinates of the extrapolated peak SAR locations in the zoom scan. If $\text{SPLSR} \leq 0.04$, simultaneously transmission SAR measurement is not necessary.

Test Position		Scaled SAR _{MAX}		Σ 1-g SAR (W/Kg)	SPLSR	Remark
		WCDMA Band 2	WLAN 2.4G			
Body	Front Side	N/A	N/A	N/A	N/A	N/A
	Back Side	1.484	0.180	1.664	0.01	Pass
	Left Side	0.831	N/A	0.831	N/A	N/A
	Right Side	N/A	0.396	0.396	N/A	N/A
	Top Side	0.356	N/A	0.356	N/A	N/A
	Bottom Side	0.207	N/A	0.207	N/A	N/A

NOTE: 1-g SAR Simultaneous Tx Combination of WCDMA Band 2 and WLAN 2.4G.

Test Position	Scaled SAR _{MAX}	Σ 1-g SAR	SPLSR	Remark
---------------	---------------------------	------------------	-------	--------

		WCDMA Band 4	WLAN 2.4G	(W/Kg)		
Body	Front Side	N/A	N/A	N/A	N/A	N/A
	Back Side	1.168	0.180	1.348	N/A	N/A
	Left Side	0.797	N/A	0.797	N/A	N/A
	Right Side	N/A	0.396	0.396	N/A	N/A
	Top Side	0.344	N/A	0.344	N/A	N/A
	Bottom Side	0.138	N/A	0.138	N/A	N/A

NOTE: 1-g SAR Simultaneous Tx Combination of WCDMA Band 4 and WLAN 2.4G.

Test Position		Scaled SAR _{MAX}		Σ 1-g SAR (W/Kg)	SPLSR	Remark
		WCDMA Band 5	WLAN 2.4G			
Body	Front Side	N/A	N/A	N/A	N/A	N/A
	Back Side	1.093	0.180	1.273	N/A	N/A
	Left Side	0.656	N/A	0.656	N/A	N/A
	Right Side	N/A	0.396	0.396	N/A	N/A
	Top Side	0.262	N/A	0.262	N/A	N/A
	Bottom Side	0.154	N/A	0.154	N/A	N/A

NOTE: 1-g SAR Simultaneous Tx Combination of WCDMA Band 5 and WLAN 2.4G.

Test Position		Scaled SAR _{MAX}		Σ 1-g SAR (W/Kg)	SPLSR	Remark
		LTE Band 2	WLAN 2.4G			
Body	Front Side	N/A	N/A	N/A	N/A	N/A
	Back Side	1.034	0.180	1.214	N/A	N/A
	Left Side	0.540	N/A	0.540	N/A	N/A
	Right Side	N/A	0.396	0.396	N/A	N/A
	Top Side	0.218	N/A	0.218	N/A	N/A
	Bottom Side	0.095	N/A	0.095	N/A	N/A

NOTE: 1-g SAR Simultaneous Tx Combination of LTE Band 2 and WLAN 2.4G.

Test Position		Scaled SAR _{MAX}		Σ 1-g SAR (W/Kg)	SPLSR	Remark
		LTE Band 4	WLAN 2.4G			
Body	Front Side	N/A	N/A	N/A	N/A	N/A
	Back Side	1.037	0.180	1.217	N/A	N/A
	Left Side	0.565	N/A	0.565	N/A	N/A
	Right Side	N/A	0.396	0.396	N/A	N/A
	Top Side	0.230	N/A	0.230	N/A	N/A
	Bottom Side	0.134	N/A	0.134	N/A	N/A

NOTE: 1-g SAR Simultaneous Tx Combination of LTE Band 4 and WLAN 2.4G.

Test Position	Scaled SAR _{MAX}	Σ 1-g SAR	SPLSR	Remark
---------------	---------------------------	-----------	-------	--------

		LTE Band 5	WLAN 2.4G	(W/Kg)		
Body	Front Side	N/A	N/A	N/A	N/A	N/A
	Back Side	1.177	0.180	1.357	N/A	N/A
	Left Side	0.675	N/A	0.675	N/A	N/A
	Right Side	N/A	0.396	0.396	N/A	N/A
	Top Side	0.265	N/A	0.265	N/A	N/A
	Bottom Side	0.157	N/A	0.157	N/A	N/A

NOTE: 1-g SAR Simultaneous Tx Combination of LTE Band 5 and WLAN 2.4G.

Test Position		Scaled SAR _{MAX}		Σ 1-g SAR (W/Kg)	SPLSR	Remark
		LTE Band 12	WLAN 2.4G			
Body	Front Side	N/A	N/A	N/A	N/A	N/A
	Back Side	1.144	0.180	1.324	N/A	N/A
	Left Side	0.675	N/A	0.675	N/A	N/A
	Right Side	N/A	0.396	0.396	N/A	N/A
	Top Side	0.240	N/A	0.240	N/A	N/A
	Bottom Side	0.172	N/A	0.172	N/A	N/A

NOTE: 1-g SAR Simultaneous Tx Combination of LTE Band 12 and WLAN 2.4G.

Test Position		Scaled SAR _{MAX}		Σ 1-g SAR (W/Kg)	SPLSR	Remark
		LTE Band 13	WLAN 2.4G			
Body	Front Side	N/A	N/A	N/A	N/A	N/A
	Back Side	1.201	0.180	1.381	N/A	N/A
	Left Side	0.697	N/A	0.697	N/A	N/A
	Right Side	N/A	0.396	0.396	N/A	N/A
	Top Side	0.240	N/A	0.240	N/A	N/A
	Bottom Side	0.180	N/A	0.180	N/A	N/A

NOTE: 1-g SAR Simultaneous Tx Combination of LTE Band 13 and WLAN 2.4G.

Test Position		Scaled SAR _{MAX}		Σ 1-g SAR (W/Kg)	SPLSR	Remark
		LTE Band 14	WLAN 2.4G			
Body	Front Side	N/A	N/A	N/A	N/A	N/A
	Back Side	1.138	0.180	1.318	N/A	N/A
	Left Side	0.625	N/A	0.625	N/A	N/A
	Right Side	N/A	0.396	0.396	N/A	N/A
	Top Side	0.387	N/A	0.387	N/A	N/A
	Bottom Side	0.171	N/A	0.171	N/A	N/A

NOTE: 1-g SAR Simultaneous Tx Combination of LTE Band 14 and WLAN 2.4G.

Test Position		Scaled SAR _{MAX}		Σ 1-g SAR (W/Kg)	SPLSR	Remark
		LTE Band 66	WLAN 2.4G			
Body	Front Side	N/A	N/A	N/A	N/A	N/A
	Back Side	0.913	0.180	1.093	N/A	N/A
	Left Side	0.495	N/A	0.495	N/A	N/A
	Right Side	N/A	0.396	0.396	N/A	N/A
	Top Side	0.221	N/A	0.221	N/A	N/A
	Bottom Side	0.123	N/A	0.123	N/A	N/A

NOTE: 1-g SAR Simultaneous Tx Combination of LTE Band 66 and WLAN 2.4G.

Test Position		Scaled SAR _{MAX}		Σ 1-g SAR (W/Kg)	SPLSR	Remark
		LTE Band 71	WLAN 2.4G			
Body	Front Side	N/A	N/A	N/A	N/A	N/A
	Back Side	0.881	0.180	1.061	N/A	N/A
	Left Side	0.529	N/A	0.529	N/A	N/A
	Right Side	N/A	0.396	0.396	N/A	N/A
	Top Side	0.185	N/A	0.185	N/A	N/A
	Bottom Side	0.088	N/A	0.088	N/A	N/A

NOTE: 1-g SAR Simultaneous Tx Combination of LTE Band 71 and WLAN 2.4G.

Test Position		Scaled SAR _{MAX}		Σ 1-g SAR (W/Kg)	SPLSR	Remark
		WCDMA Band 2	WLAN 5.2G			
Body	Front Side	N/A	N/A	N/A	N/A	N/A
	Back Side	1.484	0.351	1.835	0.01	Pass
	Left Side	0.831	N/A	0.831	N/A	N/A
	Right Side	N/A	0.351	0.351	N/A	N/A
	Top Side	0.356	N/A	0.356	N/A	N/A
	Bottom Side	0.207	N/A	0.207	N/A	N/A

NOTE: 1-g SAR Simultaneous Tx Combination of WCDMA Band 2 and WLAN 5.2G.

Test Position		Scaled SAR _{MAX}		Σ 1-g SAR (W/Kg)	SPLSR	Remark
		WCDMA Band 4	WLAN 5.2G			
Body	Front Side	N/A	N/A	N/A	N/A	N/A
	Back Side	1.168	0.351	1.519	N/A	N/A
	Left Side	0.797	N/A	0.797	N/A	N/A
	Right Side	N/A	0.351	0.351	N/A	N/A

	Top Side	0.344	N/A	0.344	N/A	N/A
	Bottom Side	0.138	N/A	0.138	N/A	N/A

NOTE: 1-g SAR Simultaneous Tx Combination of WCDMA Band 4 and WLAN 5.2G.

Test Position		Scaled SAR _{MAX}		Σ 1-g SAR (W/Kg)	SPLSR	Remark
		WCDMA Band 5	WLAN 5.2G			
Body	Front Side	N/A	N/A	N/A	N/A	N/A
	Back Side	1.093	0.351	1.444	N/A	N/A
	Left Side	0.656	N/A	0.656	N/A	N/A
	Right Side	N/A	0.351	0.351	N/A	N/A
	Top Side	0.262	N/A	0.262	N/A	N/A
	Bottom Side	0.154	N/A	0.154	N/A	N/A

NOTE: 1-g SAR Simultaneous Tx Combination of WCDMA Band 5 and WLAN 5.2G.

Test Position		Scaled SAR _{MAX}		Σ 1-g SAR (W/Kg)	SPLSR	Remark
		LTE Band 2	WLAN 5.2G			
Body	Front Side	N/A	N/A	N/A	N/A	N/A
	Back Side	1.034	0.351	1.385	N/A	N/A
	Left Side	0.540	N/A	0.540	N/A	N/A
	Right Side	N/A	0.351	0.351	N/A	N/A
	Top Side	0.218	N/A	0.218	N/A	N/A
	Bottom Side	0.095	N/A	0.095	N/A	N/A

NOTE: 1-g SAR Simultaneous Tx Combination of LTE Band 2 and WLAN 5.2G.

Test Position		Scaled SAR _{MAX}		Σ 1-g SAR (W/Kg)	SPLSR	Remark
		LTE Band 4	WLAN 5.2G			
Body	Front Side	N/A	N/A	N/A	N/A	N/A
	Back Side	1.037	0.351	1.388	N/A	N/A
	Left Side	0.565	N/A	0.565	N/A	N/A
	Right Side	N/A	0.351	0.351	N/A	N/A
	Top Side	0.230	N/A	0.230	N/A	N/A
	Bottom Side	0.134	N/A	0.134	N/A	N/A

NOTE: 1-g SAR Simultaneous Tx Combination of LTE Band 4 and WLAN 5.2G.

Test Position		Scaled SAR _{MAX}		Σ 1-g SAR (W/Kg)	SPLSR	Remark
		LTE Band 5	WLAN 5.2G			
Body	Front Side	N/A	N/A	N/A	N/A	N/A
	Back Side	1.177	0.351	1.528	N/A	N/A
	Left Side	0.675	N/A	0.675	N/A	N/A
	Right Side	N/A	0.351	0.351	N/A	N/A
	Top Side	0.265	N/A	0.265	N/A	N/A

	Bottom Side	0.157	N/A	0.157	N/A	N/A
--	-------------	-------	-----	-------	-----	-----

NOTE: 1-g SAR Simultaneous Tx Combination of LTE Band 5 and WLAN 5.2G.

Test Position		Scaled SAR _{MAX}		Σ 1-g SAR (W/Kg)	SPLSR	Remark
		LTE Band 12	WLAN 5.2G			
Body	Front Side	N/A	N/A	N/A	N/A	N/A
	Back Side	1.144	0.351	1.495	N/A	N/A
	Left Side	0.675	N/A	0.675	N/A	N/A
	Right Side	N/A	0.351	0.351	N/A	N/A
	Top Side	0.240	N/A	0.240	N/A	N/A
	Bottom Side	0.172	N/A	0.172	N/A	N/A

NOTE: 1-g SAR Simultaneous Tx Combination of LTE Band 12 and WLAN 5.2G.

Test Position		Scaled SAR _{MAX}		Σ 1-g SAR (W/Kg)	SPLSR	Remark
		LTE Band 13	WLAN 5.2G			
Body	Front Side	N/A	N/A	N/A	N/A	N/A
	Back Side	1.201	0.351	1.552	N/A	N/A
	Left Side	0.697	N/A	0.697	N/A	N/A
	Right Side	N/A	0.351	0.351	N/A	N/A
	Top Side	0.240	N/A	0.240	N/A	N/A
	Bottom Side	0.180	N/A	0.180	N/A	N/A

NOTE: 1-g SAR Simultaneous Tx Combination of LTE Band 13 and WLAN 5.2G.

Test Position		Scaled SAR _{MAX}		Σ 1-g SAR (W/Kg)	SPLSR	Remark
		LTE Band 14	WLAN 5.2G			
Body	Front Side	N/A	N/A	N/A	N/A	N/A
	Back Side	1.138	0.351	1.489	N/A	N/A
	Left Side	0.625	N/A	0.625	N/A	N/A
	Right Side	N/A	0.351	0.351	N/A	N/A
	Top Side	0.387	N/A	0.387	N/A	N/A
	Bottom Side	0.171	N/A	0.171	N/A	N/A

NOTE: 1-g SAR Simultaneous Tx Combination of LTE Band 14 and WLAN 5.2G.

Test Position		Scaled SAR _{MAX}		Σ 1-g SAR (W/Kg)	SPLSR	Remark
		LTE Band 66	WLAN 5.2G			
Body	Front Side	N/A	N/A	N/A	N/A	N/A
	Back Side	0.913	0.351	1.264	N/A	N/A
	Left Side	0.495	N/A	0.495	N/A	N/A

	Right Side	N/A	0.351	0.351	N/A	N/A
	Top Side	0.221	N/A	0.221	N/A	N/A
	Bottom Side	0.123	N/A	0.123	N/A	N/A

NOTE: 1-g SAR Simultaneous Tx Combination of LTE Band 66 and WLAN 5.2G.

Test Position		Scaled SAR _{MAX}		Σ 1-g SAR (W/Kg)	SPLSR	Remark
		LTE Band 71	WLAN 5.2G			
Body	Front Side	N/A	N/A	N/A	N/A	N/A
	Back Side	0.881	0.351	1.232	N/A	N/A
	Left Side	0.529	N/A	0.529	N/A	N/A
	Right Side	N/A	0.351	0.351	N/A	N/A
	Top Side	0.185	N/A	0.185	N/A	N/A
	Bottom Side	0.088	N/A	0.088	N/A	N/A

NOTE: 1-g SAR Simultaneous Tx Combination of LTE Band 71 and WLAN 5.2G.

Test Position		Scaled SAR _{MAX}		Σ 1-g SAR (W/Kg)	SPLSR	Remark
		WCDMA Band 2	WLAN 5.8G			
Body	Front Side	N/A	N/A	N/A	N/A	N/A
	Back Side	1.484	0.176	1.660	0.01	Pass
	Left Side	0.831	N/A	0.831	N/A	N/A
	Right Side	N/A	0.447	0.447	N/A	N/A
	Top Side	0.356	N/A	0.356	N/A	N/A
	Bottom Side	0.207	N/A	0.207	N/A	N/A

NOTE: 1-g SAR Simultaneous Tx Combination of WCDMA Band 2 and WLAN 5.8G.

Test Position		Scaled SAR _{MAX}		Σ 1-g SAR (W/Kg)	SPLSR	Remark
		WCDMA Band 4	WLAN 5.8G			
Body	Front Side	N/A	N/A	N/A	N/A	N/A
	Back Side	1.168	0.176	1.344	N/A	N/A
	Left Side	0.797	N/A	0.797	N/A	N/A
	Right Side	N/A	0.447	0.447	N/A	N/A
	Top Side	0.344	N/A	0.344	N/A	N/A
	Bottom Side	0.138	N/A	0.138	N/A	N/A

NOTE: 1-g SAR Simultaneous Tx Combination of WCDMA Band 4 and WLAN 5.8G.

Test Position		Scaled SAR _{MAX}		Σ 1-g SAR (W/Kg)	SPLSR	Remark
		WCDMA Band 5	WLAN 5.8G			
Body	Front Side	N/A	N/A	N/A	N/A	N/A

	Back Side	1.093	0.176	1.269	N/A	N/A
	Left Side	0.656	N/A	0.656	N/A	N/A
	Right Side	N/A	0.447	0.447	N/A	N/A
	Top Side	0.262	N/A	0.262	N/A	N/A
	Bottom Side	0.154	N/A	0.154	N/A	N/A

NOTE: 1-g SAR Simultaneous Tx Combination of WCDMA Band 5 and WLAN 5.8G.

Test Position		Scaled SAR _{MAX}		Σ 1-g SAR (W/Kg)	SPLSR	Remark
		LTE Band 2	WLAN 5.8G			
Body	Front Side	N/A	N/A	N/A	N/A	N/A
	Back Side	1.034	0.176	1.210	N/A	N/A
	Left Side	0.540	N/A	0.540	N/A	N/A
	Right Side	N/A	0.447	0.447	N/A	N/A
	Top Side	0.218	N/A	0.218	N/A	N/A
	Bottom Side	0.095	N/A	0.095	N/A	N/A

NOTE: 1-g SAR Simultaneous Tx Combination of LTE Band 2 and WLAN 5.8G.

Test Position		Scaled SAR _{MAX}		Σ 1-g SAR (W/Kg)	SPLSR	Remark
		LTE Band 4	WLAN 5.8G			
Body	Front Side	N/A	N/A	N/A	N/A	N/A
	Back Side	1.037	0.176	1.213	N/A	N/A
	Left Side	0.565	N/A	0.565	N/A	N/A
	Right Side	N/A	0.447	0.447	N/A	N/A
	Top Side	0.230	N/A	0.230	N/A	N/A
	Bottom Side	0.134	N/A	0.134	N/A	N/A

NOTE: 1-g SAR Simultaneous Tx Combination of LTE Band 4 and WLAN 5.8G.

Test Position		Scaled SAR _{MAX}		Σ 1-g SAR (W/Kg)	SPLSR	Remark
		LTE Band 5	WLAN 5.8G			
Body	Front Side	N/A	N/A	N/A	N/A	N/A
	Back Side	1.177	0.176	1.353	N/A	N/A
	Left Side	0.675	N/A	0.675	N/A	N/A
	Right Side	N/A	0.447	0.447	N/A	N/A
	Top Side	0.265	N/A	0.265	N/A	N/A
	Bottom Side	0.157	N/A	0.157	N/A	N/A

NOTE: 1-g SAR Simultaneous Tx Combination of LTE Band 5 and WLAN 5.8G.

Test Position		Scaled SAR _{MAX}		Σ 1-g SAR (W/Kg)	SPLSR	Remark
		LTE Band 12	WLAN 5.8G			
Body	Front Side	N/A	N/A	N/A	N/A	N/A
	Back Side	1.144	0.176	1.320	N/A	N/A

	Left Side	0.675	N/A	0.675	N/A	N/A
	Right Side	N/A	0.447	0.447	N/A	N/A
	Top Side	0.240	N/A	0.240	N/A	N/A
	Bottom Side	0.172	N/A	0.172	N/A	N/A

NOTE: 1-g SAR Simultaneous Tx Combination of LTE Band 12 and WLAN 5.8G.

Test Position		Scaled SAR _{MAX}		Σ 1-g SAR (W/Kg)	SPLSR	Remark
		LTE Band 13	WLAN 5.8G			
Body	Front Side	N/A	N/A	N/A	N/A	N/A
	Back Side	1.201	0.176	1.377	N/A	N/A
	Left Side	0.697	N/A	0.697	N/A	N/A
	Right Side	N/A	0.447	0.447	N/A	N/A
	Top Side	0.240	N/A	0.240	N/A	N/A
	Bottom Side	0.180	N/A	0.180	N/A	N/A

NOTE: 1-g SAR Simultaneous Tx Combination of LTE Band 13 and WLAN 5.8G.

Test Position		Scaled SAR _{MAX}		Σ 1-g SAR (W/Kg)	SPLSR	Remark
		LTE Band 14	WLAN 5.8G			
Body	Front Side	N/A	N/A	N/A	N/A	N/A
	Back Side	1.138	0.176	1.314	N/A	N/A
	Left Side	0.625	N/A	0.625	N/A	N/A
	Right Side	N/A	0.447	0.447	N/A	N/A
	Top Side	0.387	N/A	0.387	N/A	N/A
	Bottom Side	0.171	N/A	0.171	N/A	N/A

NOTE: 1-g SAR Simultaneous Tx Combination of LTE Band 14 and WLAN 5.8G.

Test Position		Scaled SAR _{MAX}		Σ 1-g SAR (W/Kg)	SPLSR	Remark
		LTE Band 66	WLAN 5.8G			
Body	Front Side	N/A	N/A	N/A	N/A	N/A
	Back Side	0.913	0.176	1.089	N/A	N/A
	Left Side	0.495	N/A	0.495	N/A	N/A
	Right Side	N/A	0.447	0.447	N/A	N/A
	Top Side	0.221	N/A	0.221	N/A	N/A
	Bottom Side	0.123	N/A	0.123	N/A	N/A

NOTE: 1-g SAR Simultaneous Tx Combination of LTE Band 66 and WLAN 5.8G.

Test Position		Scaled SAR _{MAX}		Σ 1-g SAR (W/Kg)	SPLSR	Remark
		LTE Band 71	WLAN 5.8G			

Body	Front Side	N/A	N/A	N/A	N/A	N/A
	Back Side	0.881	0.176	1.057	N/A	N/A
	Left Side	0.529	N/A	0.529	N/A	N/A
	Right Side	N/A	0.447	0.447	N/A	N/A
	Top Side	0.185	N/A	0.185	N/A	N/A
	Bottom Side	0.088	N/A	0.088	N/A	N/A

NOTE: 1-g SAR Simultaneous Tx Combination of LTE Band 71 and WLAN 5.8G.

Test Position		Scaled SAR _{MAX}		Σ 1-g SAR (W/Kg)	SPLSR	Remark
		WCDMA Band 2	Bluetooth			
Body	Front Side	N/A	N/A	N/A	N/A	N/A
	Back Side	1.484	0.124	1.608	0.01	Pass
	Left Side	0.831	N/A	0.831	N/A	N/A
	Right Side	N/A	0.124	0.124	N/A	N/A
	Top Side	0.356	N/A	0.356	N/A	N/A
	Bottom Side	0.207	N/A	0.207	N/A	N/A

NOTE: 1-g SAR Simultaneous Tx Combination of WCDMA Band 2 and Bluetooth.

Test Position		Scaled SAR _{MAX}		Σ 1-g SAR (W/Kg)	SPLSR	Remark
		WCDMA Band 4	Bluetooth			
Body	Front Side	N/A	N/A	N/A	N/A	N/A
	Back Side	1.168	0.124	1.292	N/A	N/A
	Left Side	0.797	N/A	0.797	N/A	N/A
	Right Side	N/A	0.124	0.124	N/A	N/A
	Top Side	0.344	N/A	0.344	N/A	N/A
	Bottom Side	0.138	N/A	0.138	N/A	N/A

NOTE: 1-g SAR Simultaneous Tx Combination of WCDMA Band 4 and Bluetooth.

Test Position		Scaled SAR _{MAX}		Σ 1-g SAR (W/Kg)	SPLSR	Remark
		WCDMA Band 5	Bluetooth			
Body	Front Side	N/A	N/A	N/A	N/A	N/A
	Back Side	1.093	0.124	1.217	N/A	N/A
	Left Side	0.656	N/A	0.656	N/A	N/A
	Right Side	N/A	0.124	0.124	N/A	N/A
	Top Side	0.262	N/A	0.262	N/A	N/A
	Bottom Side	0.154	N/A	0.154	N/A	N/A

NOTE: 1-g SAR Simultaneous Tx Combination of WCDMA Band 5 and Bluetooth.

Test Position	Scaled SAR _{MAX}		Σ 1-g SAR	SPLSR	Remark
---------------	---------------------------	--	-----------	-------	--------

		LTE Band 2	Bluetooth	(W/Kg)		
Body	Front Side	N/A	N/A	N/A	N/A	N/A
	Back Side	1.034	0.124	1.158	N/A	N/A
	Left Side	0.540	N/A	0.540	N/A	N/A
	Right Side	N/A	0.124	0.124	N/A	N/A
	Top Side	0.218	N/A	0.218	N/A	N/A
	Bottom Side	0.095	N/A	0.095	N/A	N/A

NOTE: 1-g SAR Simultaneous Tx Combination of LTE Band 2 and Bluetooth.

Test Position		Scaled SAR _{MAX}		Σ 1-g SAR (W/Kg)	SPLSR	Remark
		LTE Band 4	Bluetooth			
Body	Front Side	N/A	N/A	N/A	N/A	N/A
	Back Side	1.037	0.124	1.161	N/A	N/A
	Left Side	0.565	N/A	0.565	N/A	N/A
	Right Side	N/A	0.124	0.124	N/A	N/A
	Top Side	0.230	N/A	0.230	N/A	N/A
	Bottom Side	0.134	N/A	0.134	N/A	N/A

NOTE: 1-g SAR Simultaneous Tx Combination of LTE Band 4 and Bluetooth.

Test Position		Scaled SAR _{MAX}		Σ 1-g SAR (W/Kg)	SPLSR	Remark
		LTE Band 5	Bluetooth			
Body	Front Side	N/A	N/A	N/A	N/A	N/A
	Back Side	1.177	0.124	1.301	N/A	N/A
	Left Side	0.675	N/A	0.675	N/A	N/A
	Right Side	N/A	0.124	0.124	N/A	N/A
	Top Side	0.265	N/A	0.265	N/A	N/A
	Bottom Side	0.157	N/A	0.157	N/A	N/A

NOTE: 1-g SAR Simultaneous Tx Combination of LTE Band 5 and Bluetooth.

Test Position		Scaled SAR _{MAX}		Σ 1-g SAR (W/Kg)	SPLSR	Remark
		LTE Band 12	Bluetooth			
Body	Front Side	N/A	N/A	N/A	N/A	N/A
	Back Side	1.144	0.124	1.268	N/A	N/A
	Left Side	0.675	N/A	0.675	N/A	N/A
	Right Side	N/A	0.124	0.124	N/A	N/A
	Top Side	0.240	N/A	0.240	N/A	N/A
	Bottom Side	0.172	N/A	0.172	N/A	N/A

NOTE: 1-g SAR Simultaneous Tx Combination of LTE Band 12 and Bluetooth.

Test Position		Scaled SAR _{MAX}		Σ 1-g SAR (W/Kg)	SPLSR	Remark
		LTE Band	Bluetooth			

		13				
Body	Front Side	N/A	N/A	N/A	N/A	N/A
	Back Side	1.201	0.124	1.325	N/A	N/A
	Left Side	0.697	N/A	0.697	N/A	N/A
	Right Side	N/A	0.124	0.124	N/A	N/A
	Top Side	0.240	N/A	0.240	N/A	N/A
	Bottom Side	0.180	N/A	0.180	N/A	N/A

NOTE: 1-g SAR Simultaneous Tx Combination of LTE Band 13 and Bluetooth.

Test Position		Scaled SAR _{MAX}		Σ 1-g SAR (W/Kg)	SPLSR	Remark
		LTE Band 14	Bluetooth			
Body	Front Side	N/A	N/A	N/A	N/A	N/A
	Back Side	1.138	0.124	1.262	N/A	N/A
	Left Side	0.625	N/A	0.625	N/A	N/A
	Right Side	N/A	0.124	0.124	N/A	N/A
	Top Side	0.387	N/A	0.387	N/A	N/A
	Bottom Side	0.171	N/A	0.171	N/A	N/A

NOTE: 1-g SAR Simultaneous Tx Combination of LTE Band 14 and Bluetooth.

Test Position		Scaled SAR _{MAX}		Σ 1-g SAR (W/Kg)	SPLSR	Remark
		LTE Band 66	Bluetooth			
Body	Front Side	N/A	N/A	N/A	N/A	N/A
	Back Side	0.913	0.124	1.037	N/A	N/A
	Left Side	0.495	N/A	0.495	N/A	N/A
	Right Side	N/A	0.124	0.124	N/A	N/A
	Top Side	0.221	N/A	0.221	N/A	N/A
	Bottom Side	0.123	N/A	0.123	N/A	N/A

NOTE: 1-g SAR Simultaneous Tx Combination of LTE Band 66 and Bluetooth.

Test Position		Scaled SAR _{MAX}		Σ 1-g SAR (W/Kg)	SPLSR	Remark
		LTE Band 71	Bluetooth			
Body	Front Side	N/A	N/A	N/A	N/A	N/A
	Back Side	0.881	0.124	1.005	N/A	N/A
	Left Side	0.529	N/A	0.529	N/A	N/A
	Right Side	N/A	0.124	0.124	N/A	N/A
	Top Side	0.185	N/A	0.185	N/A	N/A
	Bottom Side	0.088	N/A	0.088	N/A	N/A

NOTE: 1-g SAR Simultaneous Tx Combination of LTE Band 71 and Bluetooth.

11. Appendix A. Photo documentation

Refer to appendix Test Setup photo---SAR

12. Appendix B. System Check Plots

Table of contents
MEASUREMENT 1 System Performance Check - 750MHz
MEASUREMENT 2 System Performance Check - 835MHz
MEASUREMENT 3 System Performance Check - 1800MHz
MEASUREMENT 4 System Performance Check - 1900MHz
MEASUREMENT 5 System Performance Check - 2450MHz
MEASUREMENT 6 System Performance Check - 5800MHz

MEASUREMENT 1

Date of measurement: 28/6/2021

A. Experimental conditions.

Area Scan	<u>dx=15mm dy=15mm, h= 5.00 mm</u>
ZoomScan	<u>5x5x7,dx=8mm dy=8mm dz=5mm</u>
Phantom	<u>Validation plane</u>
Device Position	<u>Dipole</u>
Band	<u>CW750</u>
Channels	<u>Middle</u>
Signal	<u>CW (Crest factor: 1.0)</u>

B. SAR Measurement Results

Frequency (MHz)	750.000000
Relative permittivity (real part)	41.047169
Relative permittivity (imaginary part)	21.275281
Conductivity (S/m)	0.886470
Variation (%)	-1.810000

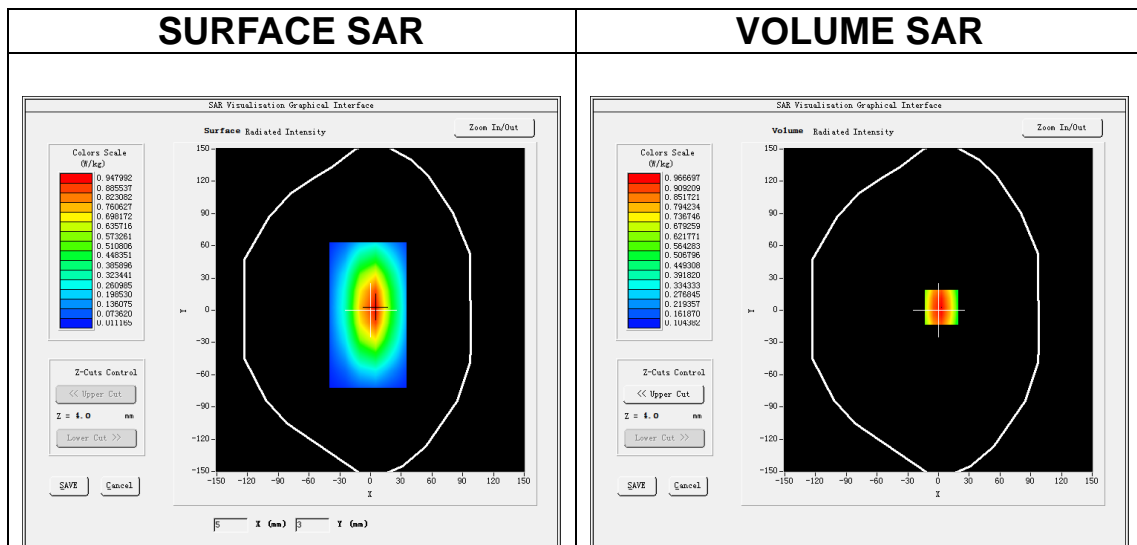

Maximum location: X=3.00, Y=3.00
SAR Peak: 1.30 W/kg

SAR 10g (W/Kg)	0.553218
SAR 1g (W/Kg)	0.899062

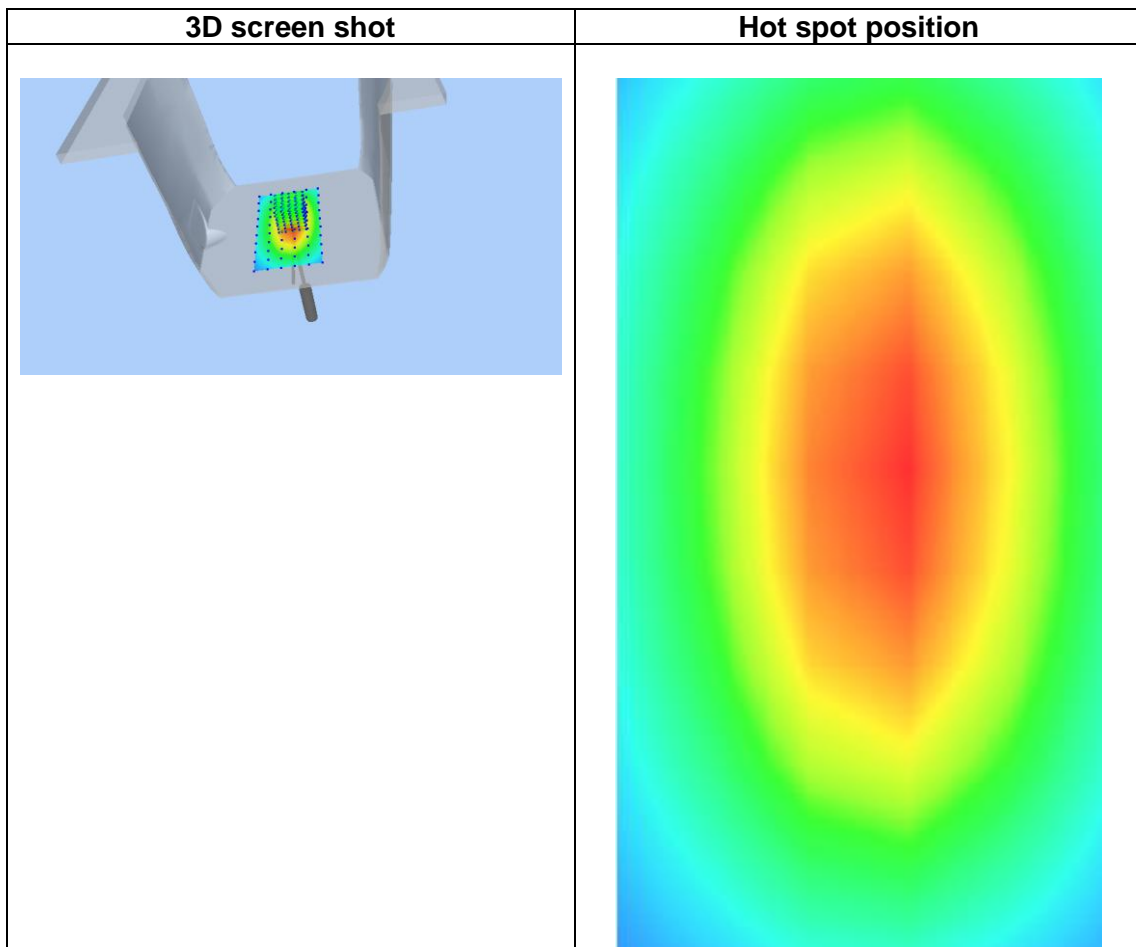
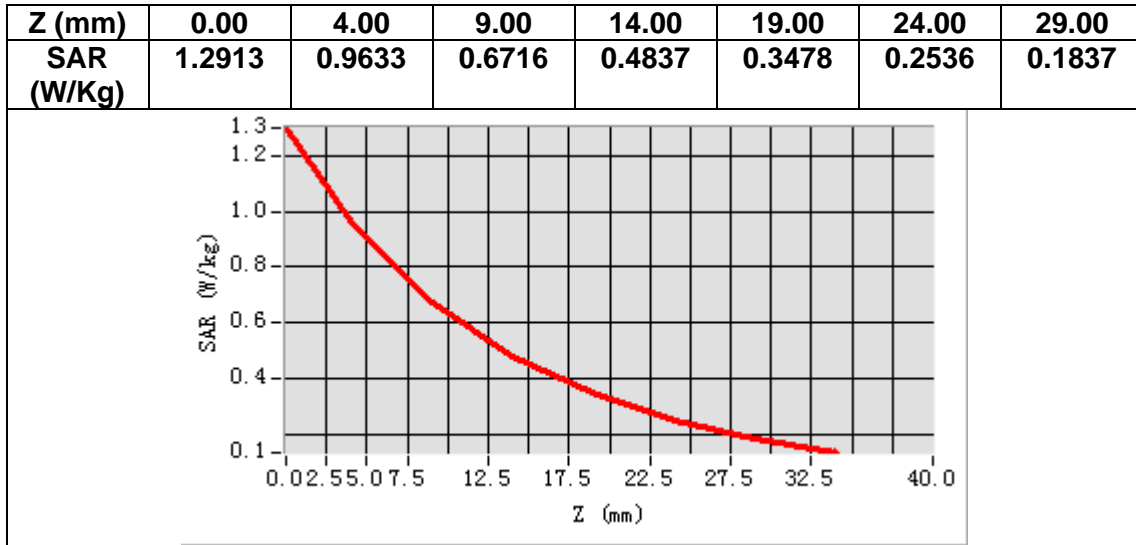

MEASUREMENT 2

Date of measurement: 29/6/2021

A. Experimental conditions.

Area Scan	<u>dx=15mm dy=15mm, h= 5.00 mm</u>
ZoomScan	<u>5x5x7, dx=8mm dy=8mm dz=5mm</u>
Phantom	<u>Validation plane</u>
Device Position	<u>Dipole</u>
Band	<u>CW835</u>
Channels	<u>Middle</u>
Signal	<u>CW (Crest factor: 1.0)</u>

B. SAR Measurement Results

Frequency (MHz)	835.000000
Relative permittivity (real part)	42.117610
Relative permittivity (imaginary part)	19.882123
Conductivity (S/m)	0.922310
Variation (%)	1.870000

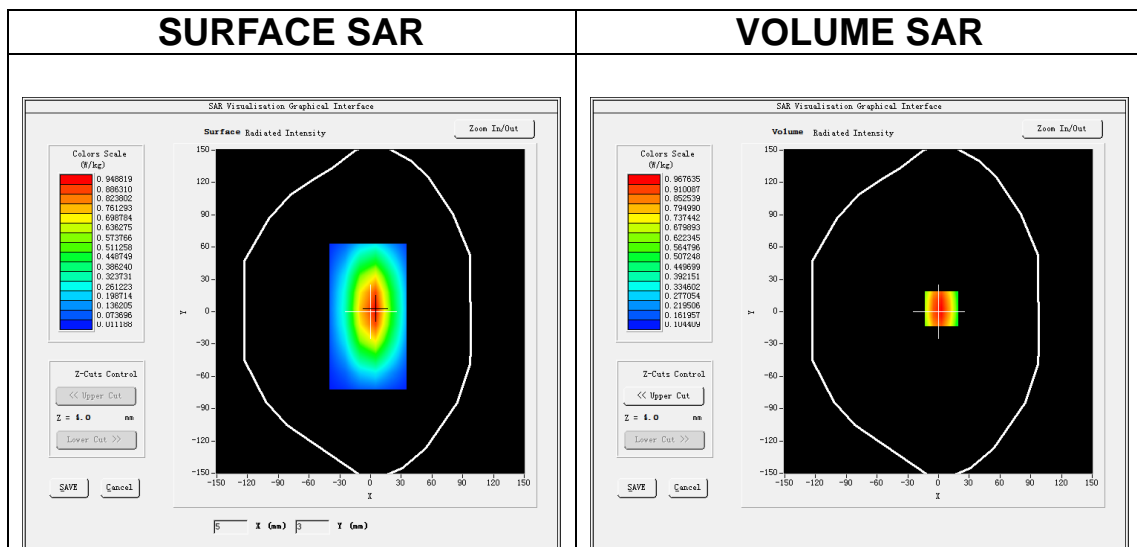

Maximum location: X=3.00, Y=3.00

SAR Peak: 1.30 W/kg

SAR 10g (W/Kg)	0.615433
SAR 1g (W/Kg)	1.015035

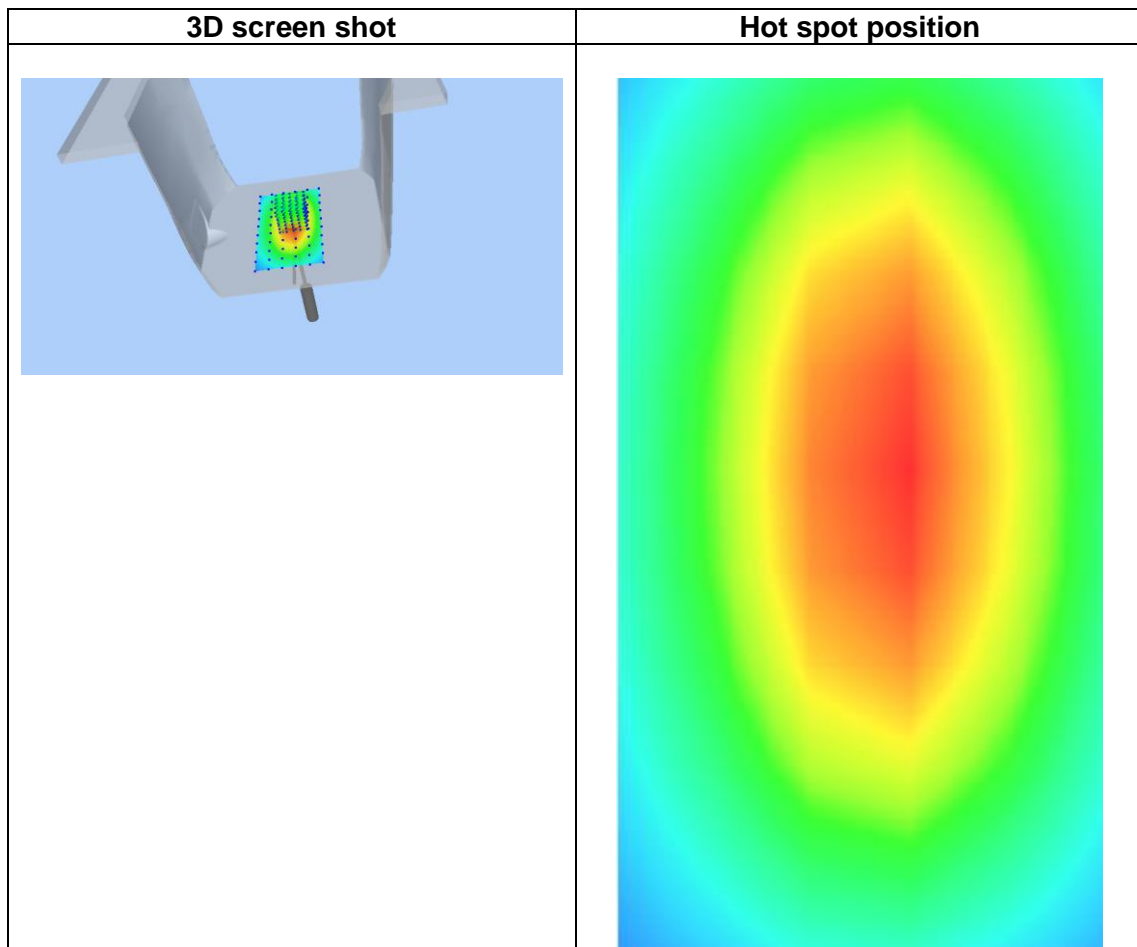
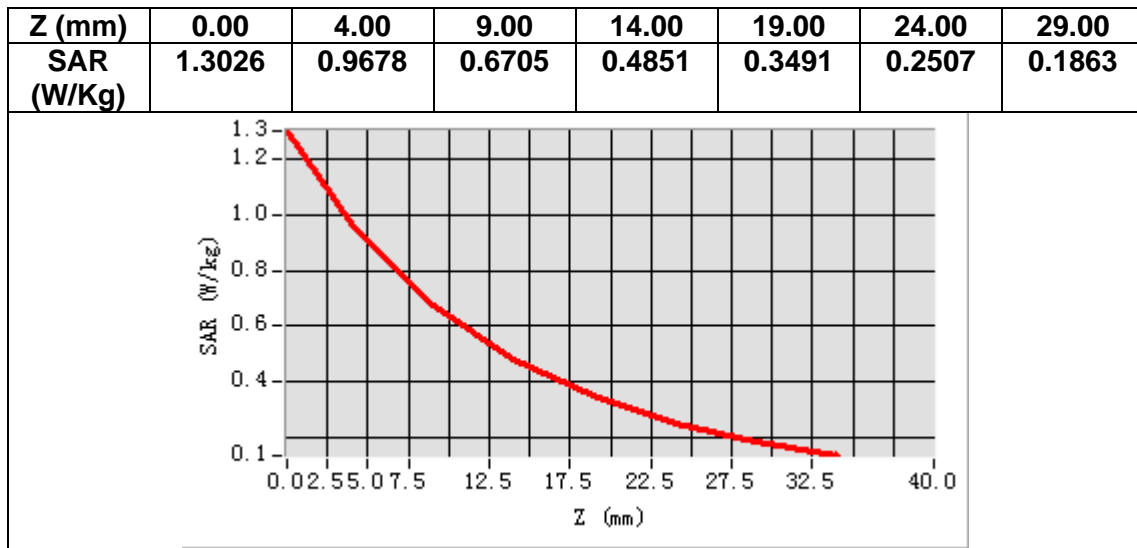

MEASUREMENT 3

Date of measurement: 1/7/2021

A. Experimental conditions.

Area Scan	<u>dx=15mm dy=15mm, h= 5.00 mm</u>
ZoomScan	<u>5x5x7, dx=8mm dy=8mm dz=5mm</u>
Phantom	<u>Validation plane</u>
Device Position	<u>Dipole</u>
Band	<u>CW1800</u>
Channels	<u>Middle</u>
Signal	<u>CW (Crest factor: 1.0)</u>

B. SAR Measurement Results

Frequency (MHz)	1800.000000
Relative permittivity (real part)	39.808501
Relative permittivity (imaginary part)	14.143163
Conductivity (S/m)	1.414316
Variation (%)	-2.113000

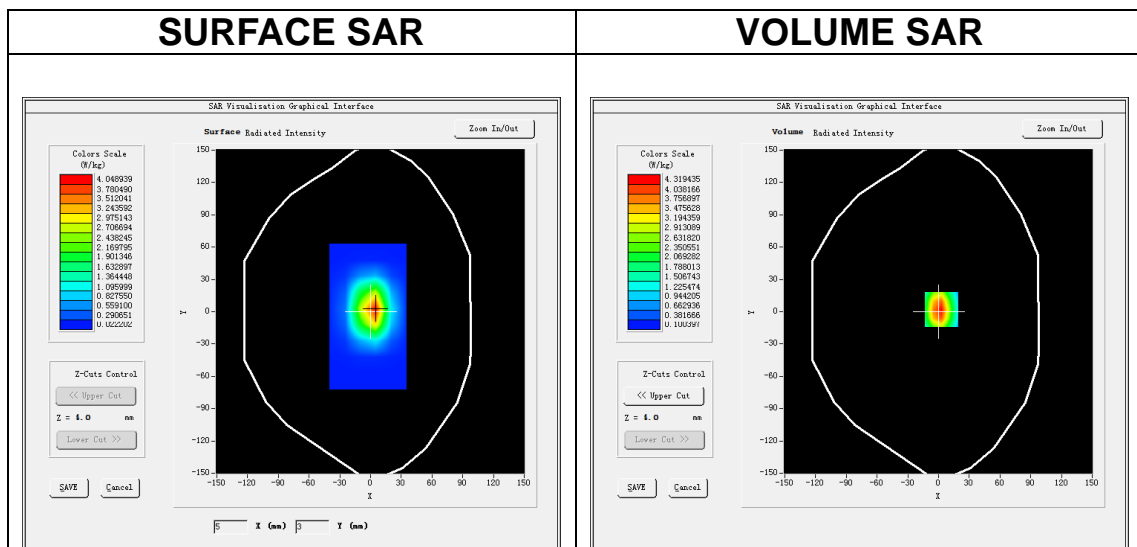

Maximum location: X=3.00, Y=2.00

SAR Peak: 6.82 W/kg

SAR 10g (W/Kg)	2.097397
SAR 1g (W/Kg)	3.891451

Z (mm)	0.00	4.00	9.00	14.00	19.00	24.00	29.00
SAR (W/Kg)	6.7434	4.3126	2.4318	1.4277	0.8554	0.5237	0.3279

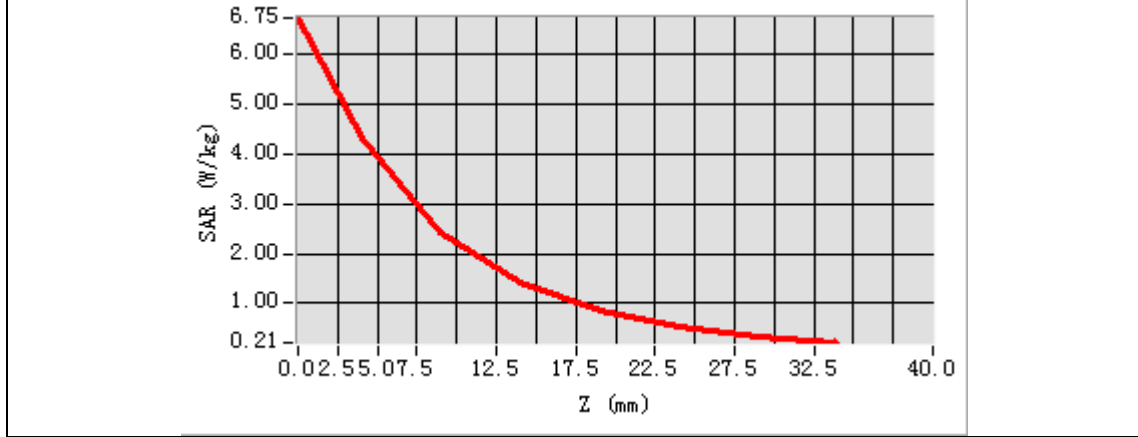

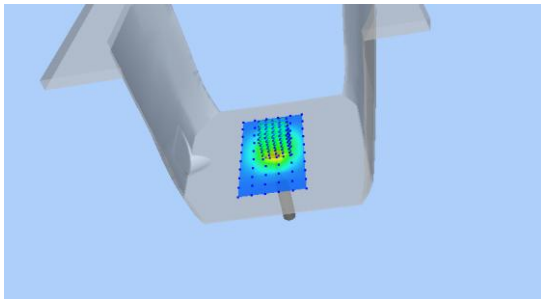
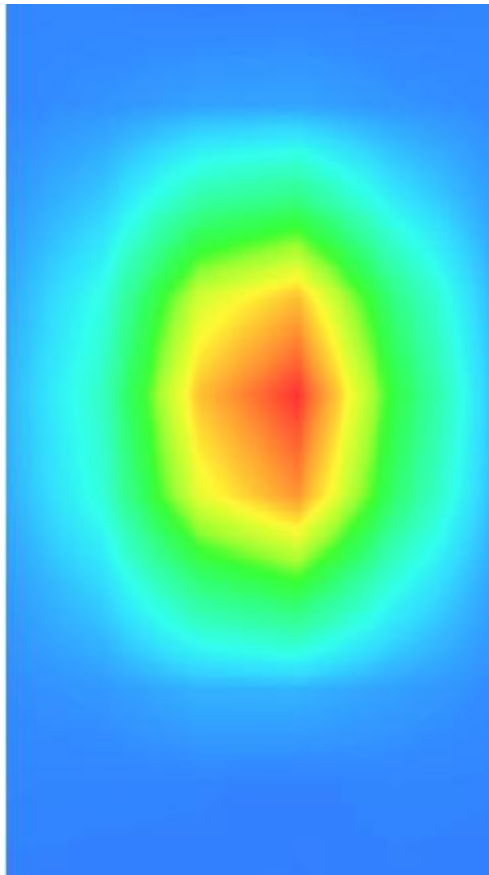
3D screen shot	Hot spot position
	

MEASUREMENT 4

Date of measurement: 5/7/2021

A. Experimental conditions.

Area Scan	<u>dx=15mm dy=15mm, h= 5.00 mm</u>
ZoomScan	<u>5x5x7, dx=8mm dy=8mm dz=5mm</u>
Phantom	<u>Validation plane</u>
Device Position	<u>Dipole</u>
Band	<u>CW1900</u>
Channels	<u>Middle</u>
Signal	<u>CW (Crest factor: 1.0)</u>

B. SAR Measurement Results

Frequency (MHz)	1900.000000
Relative permittivity (real part)	38.707325
Relative permittivity (imaginary part)	13.767884
Conductivity (S/m)	1.453277
Variation (%)	-1.430000

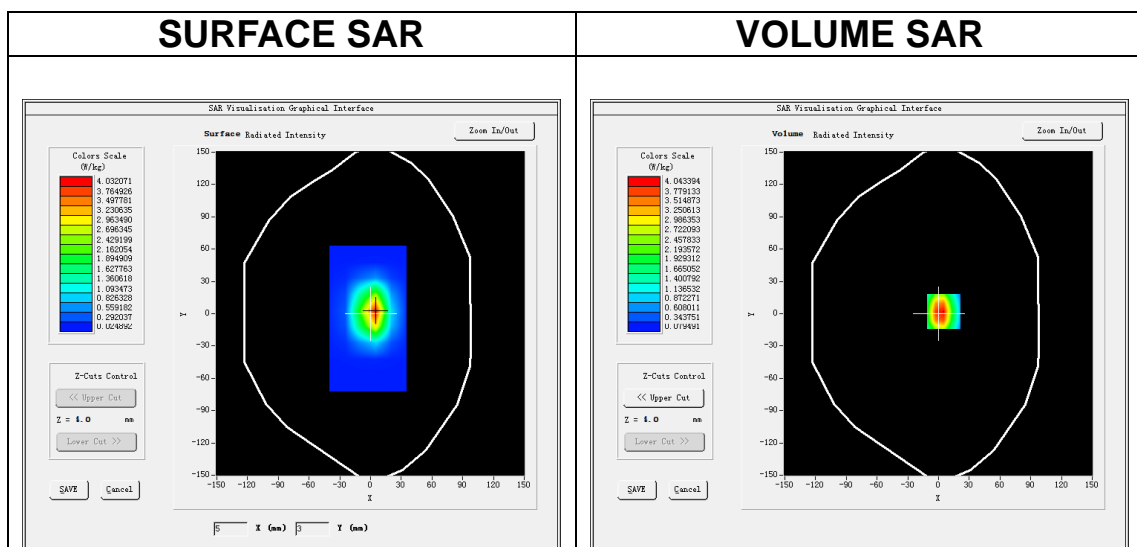

Maximum location: X=5.00, Y=2.00

SAR Peak: 6.70 W/kg

SAR 10g (W/Kg)	2.083452
SAR 1g (W/Kg)	4.083361

Z (mm)	0.00	4.00	9.00	14.00	19.00	24.00	29.00
SAR (W/Kg)	6.3211	4.0432	2.2653	1.3077	0.7635	0.4533	0.2735

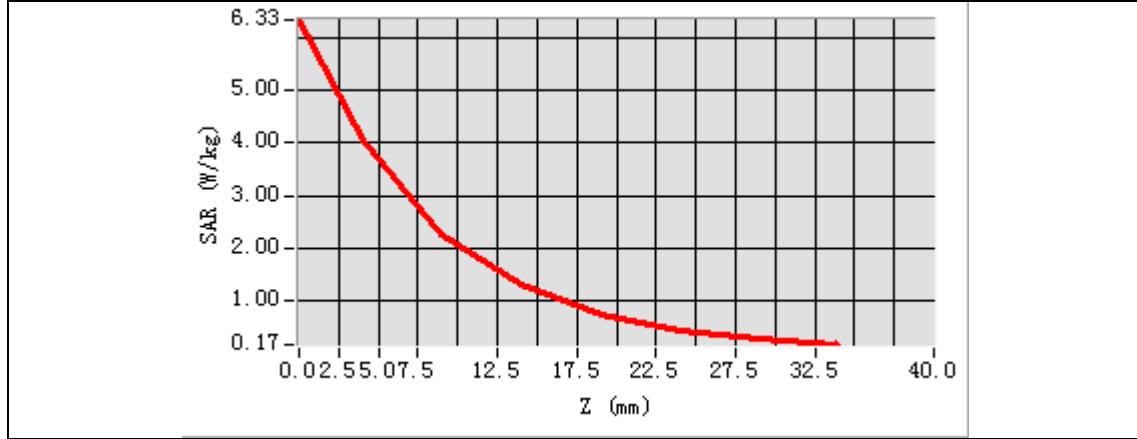

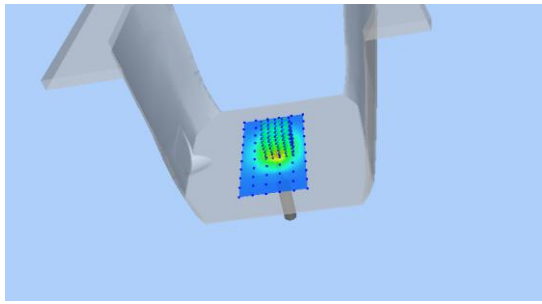
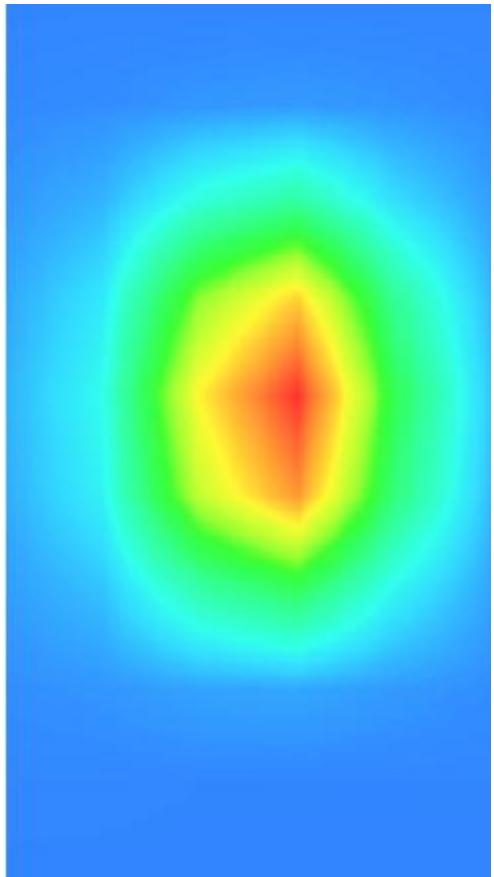
3D screen shot	Hot spot position
	

MEASUREMENT 5

Date of measurement: 8/7/2021

A. Experimental conditions.

Area Scan	<u>dx=12mm dy=12mm, h= 5.00 mm</u>
ZoomScan	<u>7x7x7, dx=5mm dy=5mm dz=5mm</u>
Phantom	<u>Validation plane</u>
Device Position	<u>Dipole</u>
Band	<u>CW2450</u>
Channels	<u>Middle</u>
Signal	<u>CW (Crest factor: 1.0)</u>

B. SAR Measurement Results

Frequency (MHz)	2450.000000
Relative permittivity (real part)	38.475900
Relative permittivity (imaginary part)	13.561800
Conductivity (S/m)	1.845912
Variation (%)	-3.350000

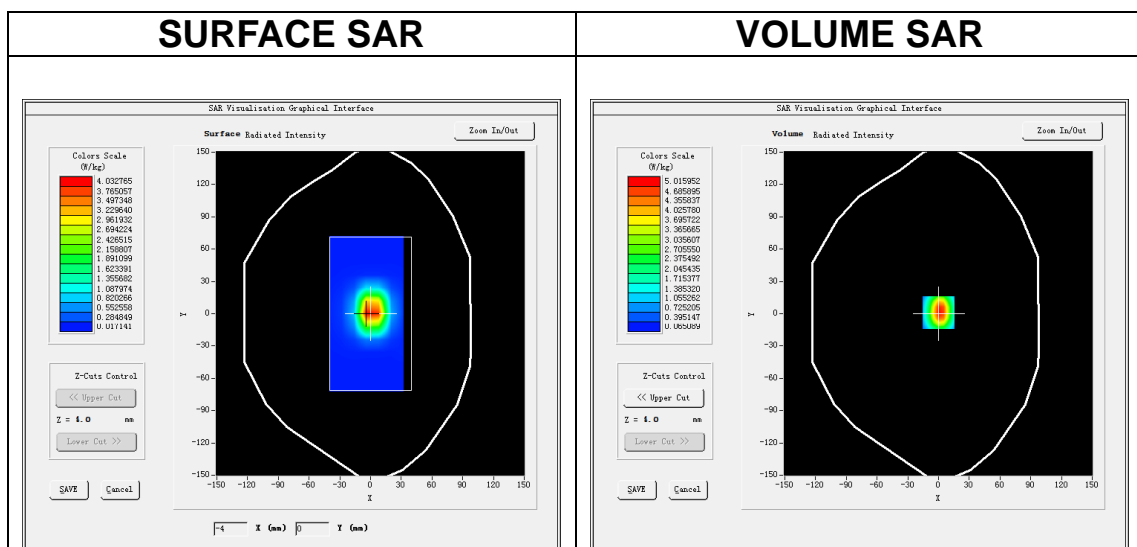

Maximum location: X=0.00, Y=1.00

SAR Peak: 8.14 W/kg

SAR 10g (W/Kg)	2.488175
SAR 1g (W/Kg)	5.330435

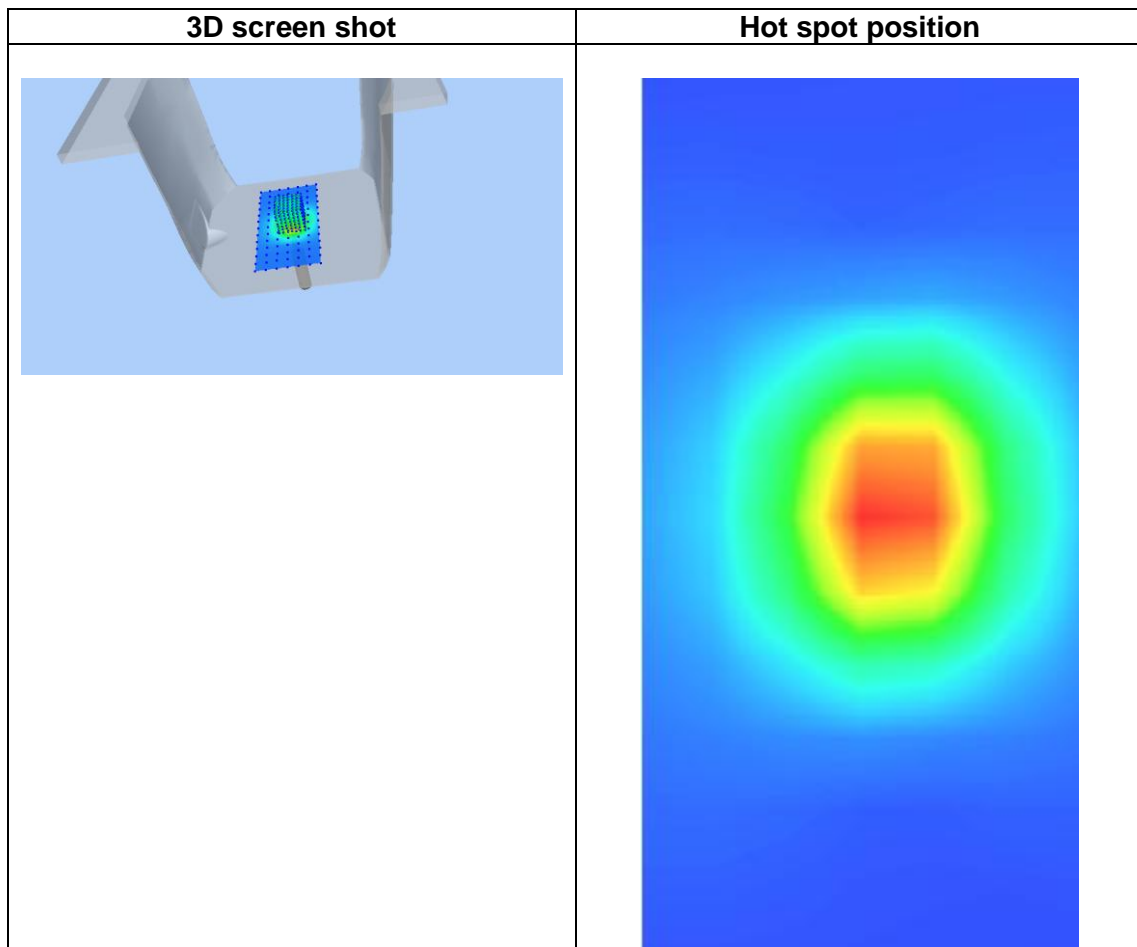
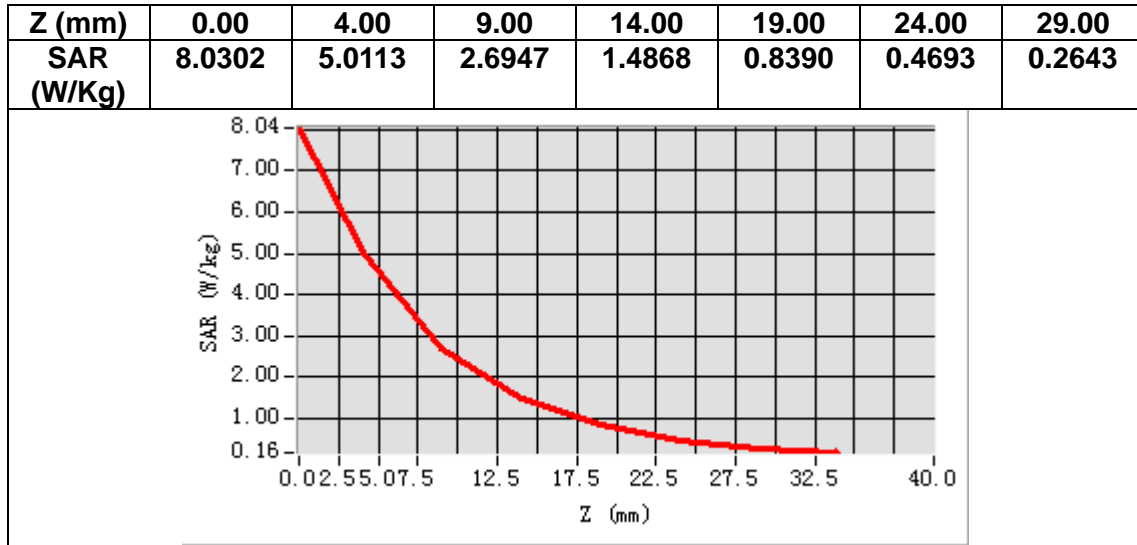

MEASUREMENT 6

Date of measurement: 13/7/2021

A. Experimental conditions.

Area Scan	<u>dx=10mm dy=10mm, h= 2.00 mm</u>
ZoomScan	<u>7x7x12,dx=4mm dy=4mm dz=2mm</u>
Phantom	<u>Validation plane</u>
Device Position	<u>Dipole</u>
Band	<u>CW5800</u>
Channels	<u>Middle</u>
Signal	<u>CW (Crest factor: 1.0)</u>

B. SAR Measurement Results

Frequency (MHz)	5800.000000
Relative permittivity (real part)	35.765594
Relative permittivity (imaginary part)	16.172081
Conductivity (S/m)	5.211004
Variation (%)	-1.880000

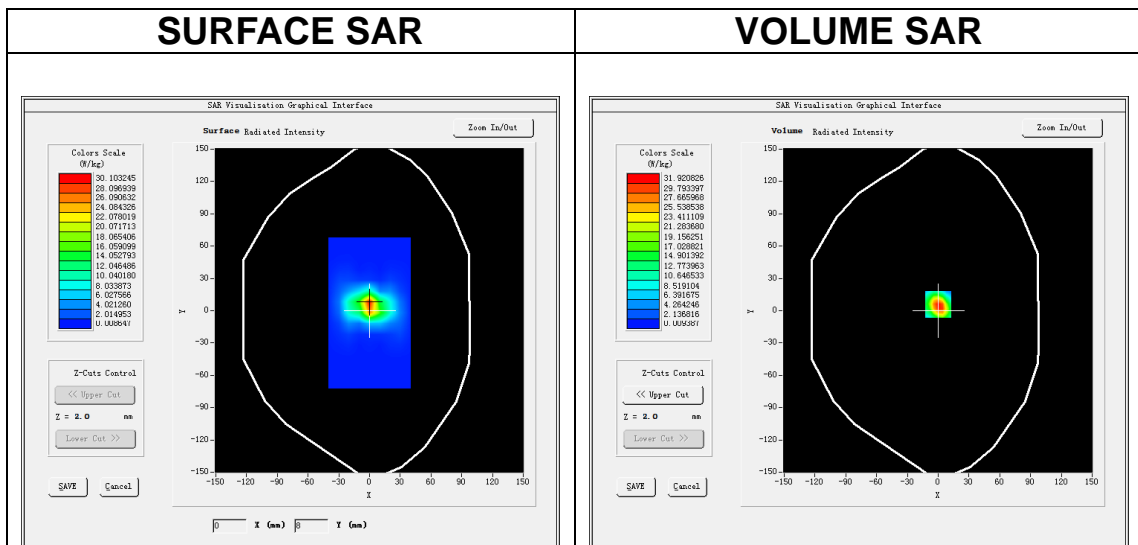

Maximum location: X=0.00, Y=6.00

SAR Peak: 57.37 W/kg

SAR 10g (W/Kg)	6.454095
SAR 1g (W/Kg)	18.786093

Z (m m)	0.00	2.00	4.00	6.00	8.00	10.0	12.0	14.0	16.0	18.0	20.0	22.0
SAR (W/ Kg)	54.0 311	31.9 215	16.1 720	8.17 01	4.08 84	2.05 12	1.03 08	0.51 81	0.27 50	0.15 53	0.07 40	0.04 39

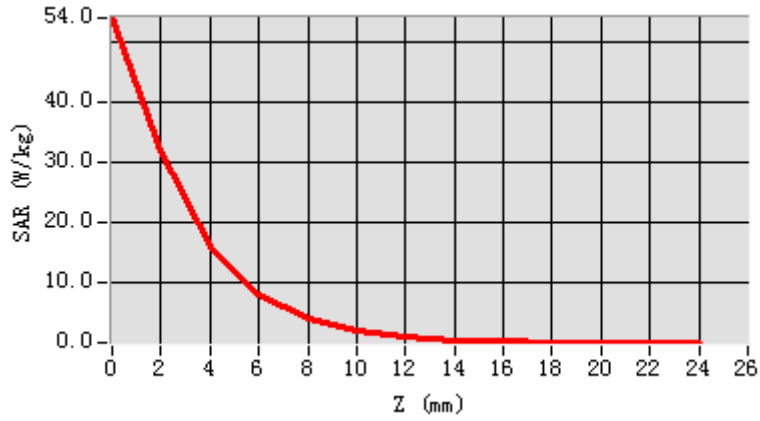

3D screen shot

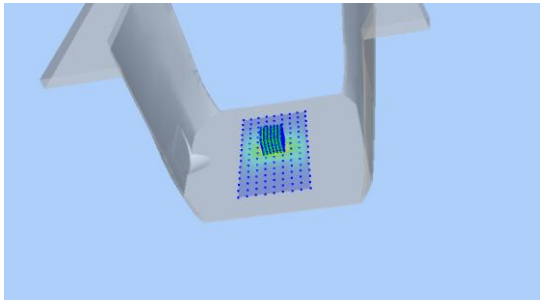

Hot spot position

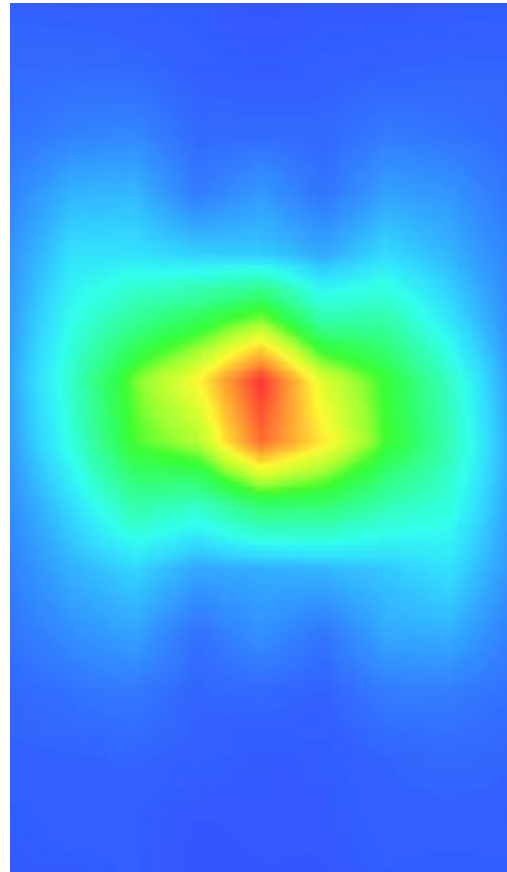

13. Appendix C. Plots of High SAR Measurement

Table of contents
MEASUREMENT 1 WCDMA Band 2 Body
MEASUREMENT 2 WCDMA Band 4 Body
MEASUREMENT 3 WCDMA Band 5 Body
MEASUREMENT 4 WLAN 5.8G Body
MEASUREMENT 5 WLAN 2.4G Body
MEASUREMENT 6 LTE Band 2 Body
MEASUREMENT 7 LTE Band 4 Body
MEASUREMENT 8 LTE Band 5 Body
MEASUREMENT 9 LTE Band 12 Body
MEASUREMENT 10 LTE Band 13 Body
MEASUREMENT 11 LTE Band 14 Body
MEASUREMENT 12 LTE Band 66 Body
MEASUREMENT 13 LTE Band 71 Body

MEASUREMENT 1

Date of measurement: 5/7/2021

A. Experimental conditions.

Area Scan	<u>dx=15mm dy=15mm, h= 5.00 mm</u>
ZoomScan	<u>5x5x7, dx=8mm dy=8mm dz=5mm</u>
Phantom	<u>Validation plane</u>
Device Position	<u>Body</u>
Band	<u>Band2 WCDMA1900</u>
Channels	<u>Middle</u>
Signal	<u>WCDMA (Crest factor: 1.0)</u>

B. SAR Measurement Results

Frequency (MHz)	1880.000000
Relative permittivity (real part)	38.793724
Relative permittivity (imaginary part)	13.785684
Conductivity (S/m)	1.439838
Variation (%)	-0.810000

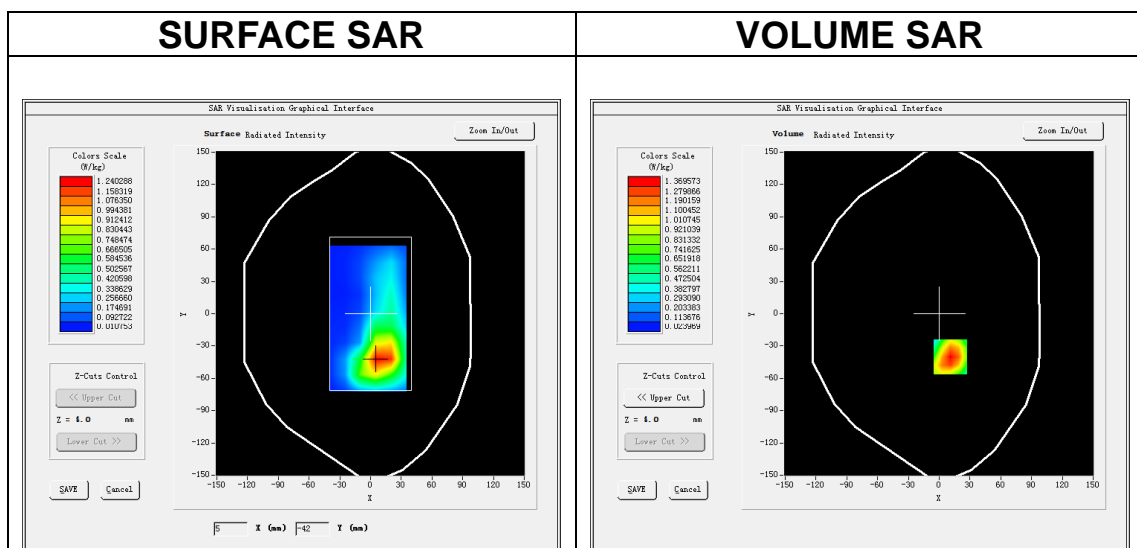

Maximum location: X=11.00, Y=-40.00

SAR Peak: 2.00 W/kg

SAR 10g (W/Kg)	0.751598
SAR 1g (W/Kg)	1.338220

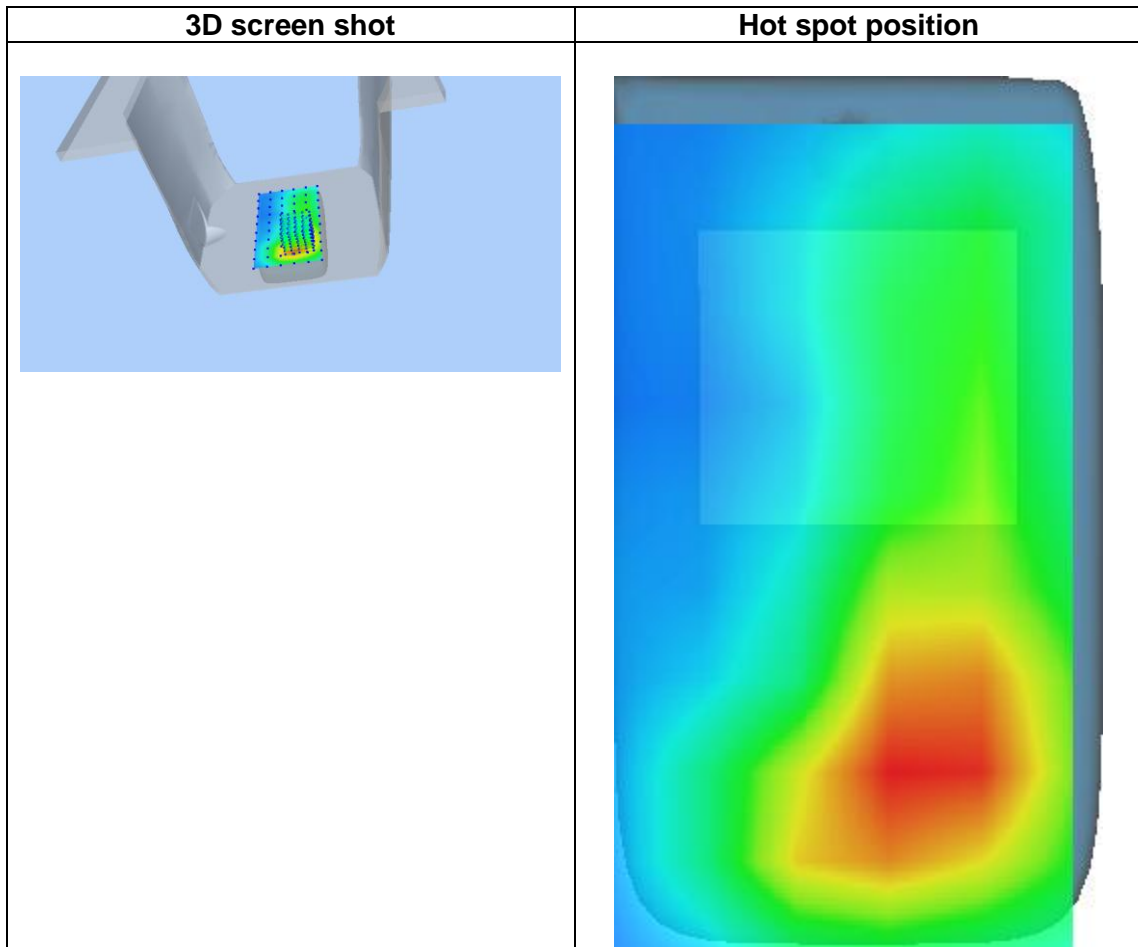
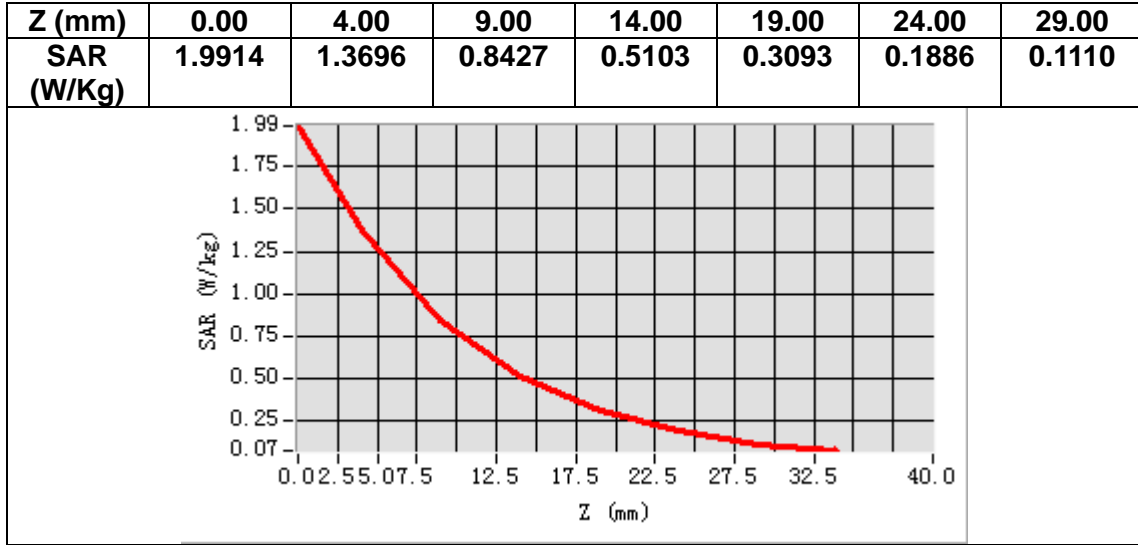

MEASUREMENT 2

Date of measurement: 1/7/2021

A. Experimental conditions.

Area Scan	<u>dx=15mm dy=15mm, h= 5.00 mm</u>
ZoomScan	<u>5x5x7, dx=8mm dy=8mm dz=5mm</u>
Phantom	<u>Validation plane</u>
Device Position	<u>Body</u>
Band	<u>Band4 WCDMA1700</u>
Channels	<u>Middle</u>
Signal	<u>WCDMA (Crest factor: 1.0)</u>

B. SAR Measurement Results

Frequency (MHz)	1732.600000
Relative permittivity (real part)	40.268200
Relative permittivity (imaginary part)	14.095463
Conductivity (S/m)	1.356297
Variation (%)	4.930000

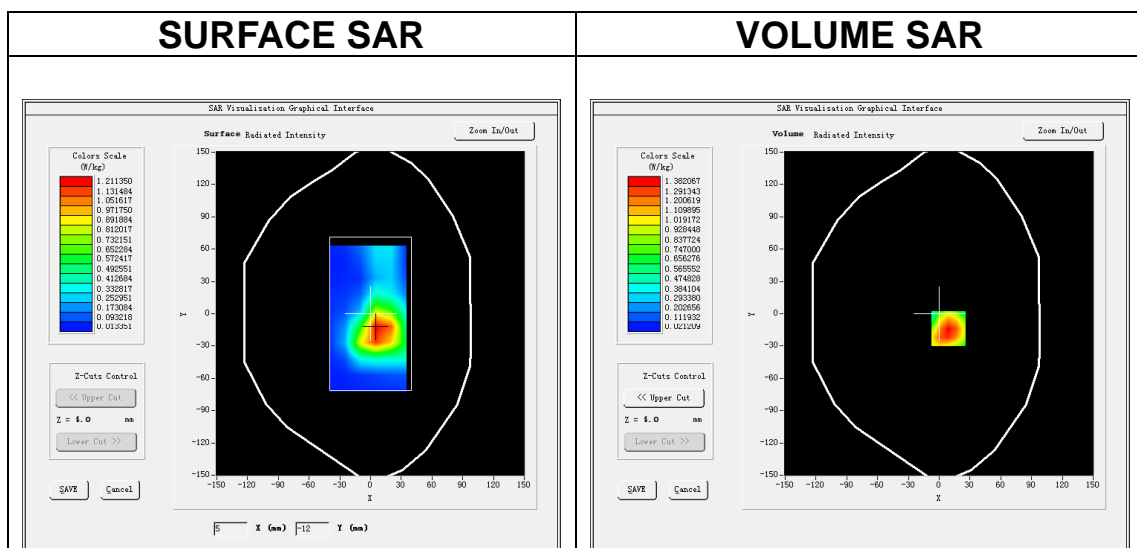

Maximum location: X=9.00, Y=-14.00

SAR Peak: 2.18 W/kg

SAR 10g (W/Kg)	0.608109
SAR 1g (W/Kg)	1.128440

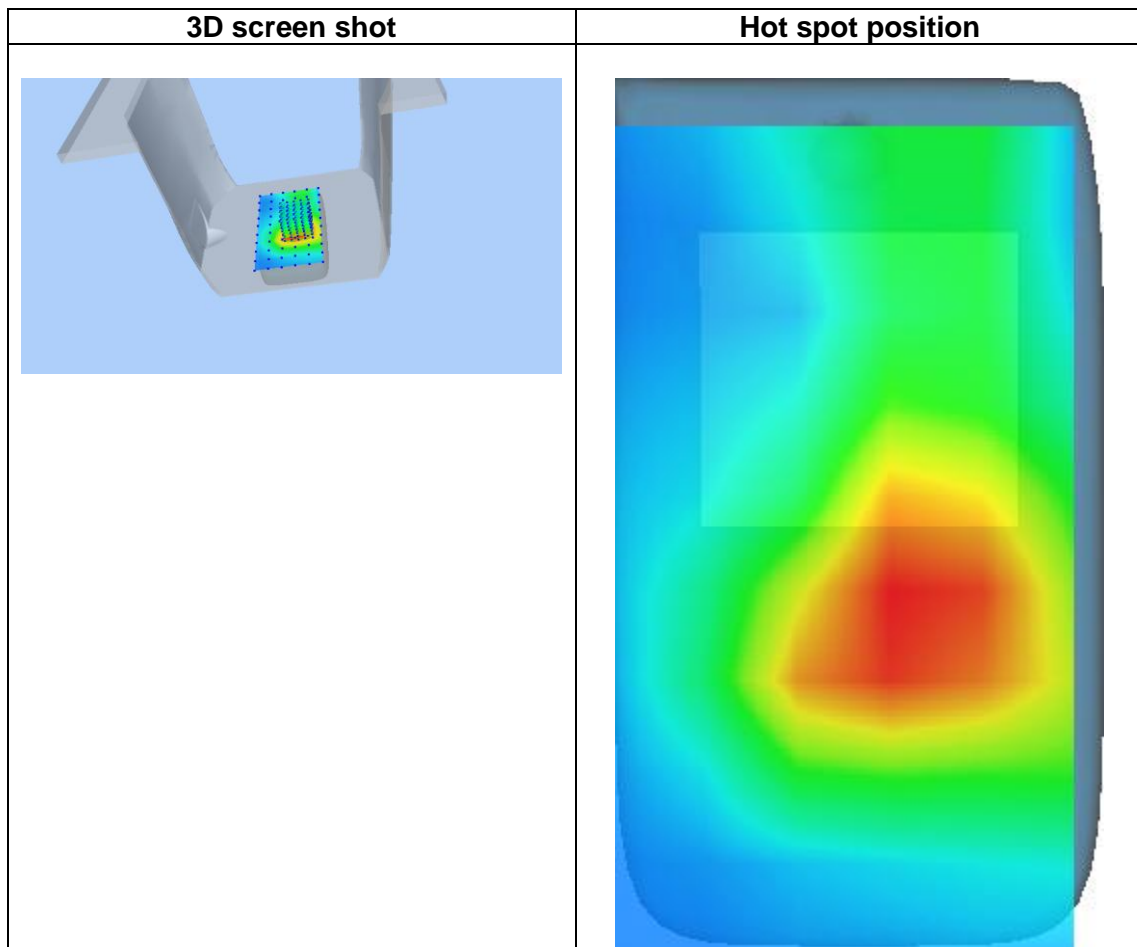
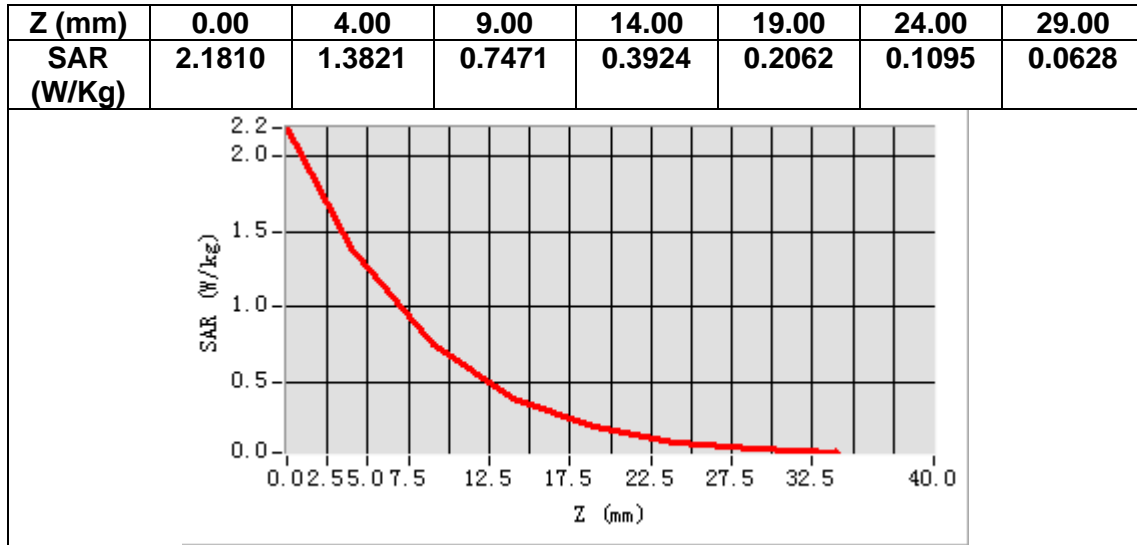

MEASUREMENT 3

Date of measurement: 29/6/2021

A. Experimental conditions.

Area Scan	<u>dx=15mm dy=15mm, h= 5.00 mm</u>
ZoomScan	<u>5x5x7, dx=8mm dy=8mm dz=5mm</u>
Phantom	<u>Validation plane</u>
Device Position	<u>Body</u>
Band	<u>Band5_WCDMA850</u>
Channels	<u>Middle</u>
Signal	<u>WCDMA (Crest factor: 1.0)</u>

B. SAR Measurement Results

Frequency (MHz)	836.600000
Relative permittivity (real part)	42.033272
Relative permittivity (imaginary part)	19.907963
Conductivity (S/m)	0.925057
Variation (%)	-0.580000

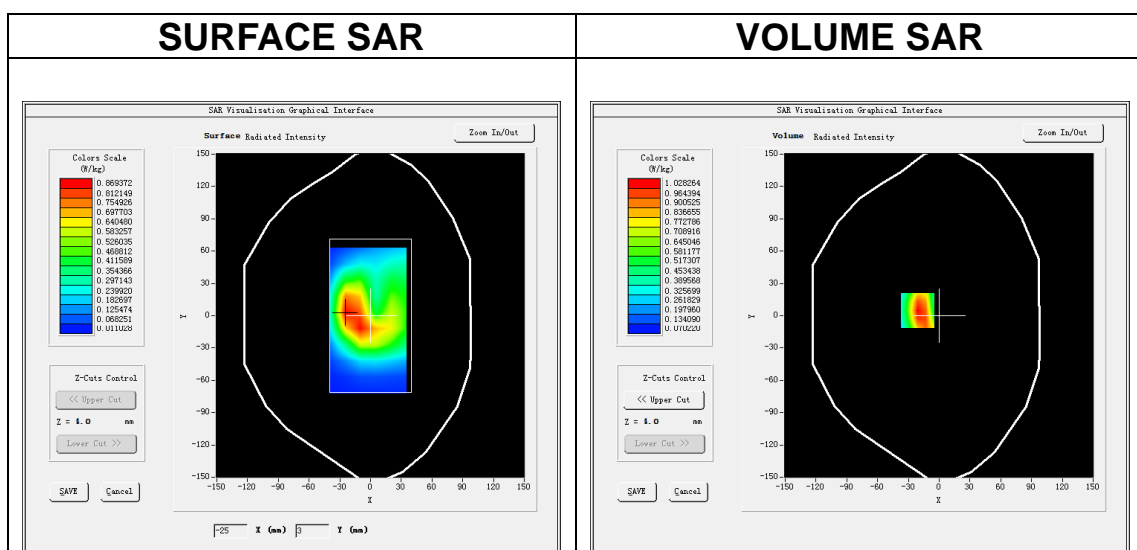

Maximum location: X=-21.00, Y=5.00

SAR Peak: 1.57 W/kg

SAR 10g (W/Kg)	0.595910
SAR 1g (W/Kg)	1.017582

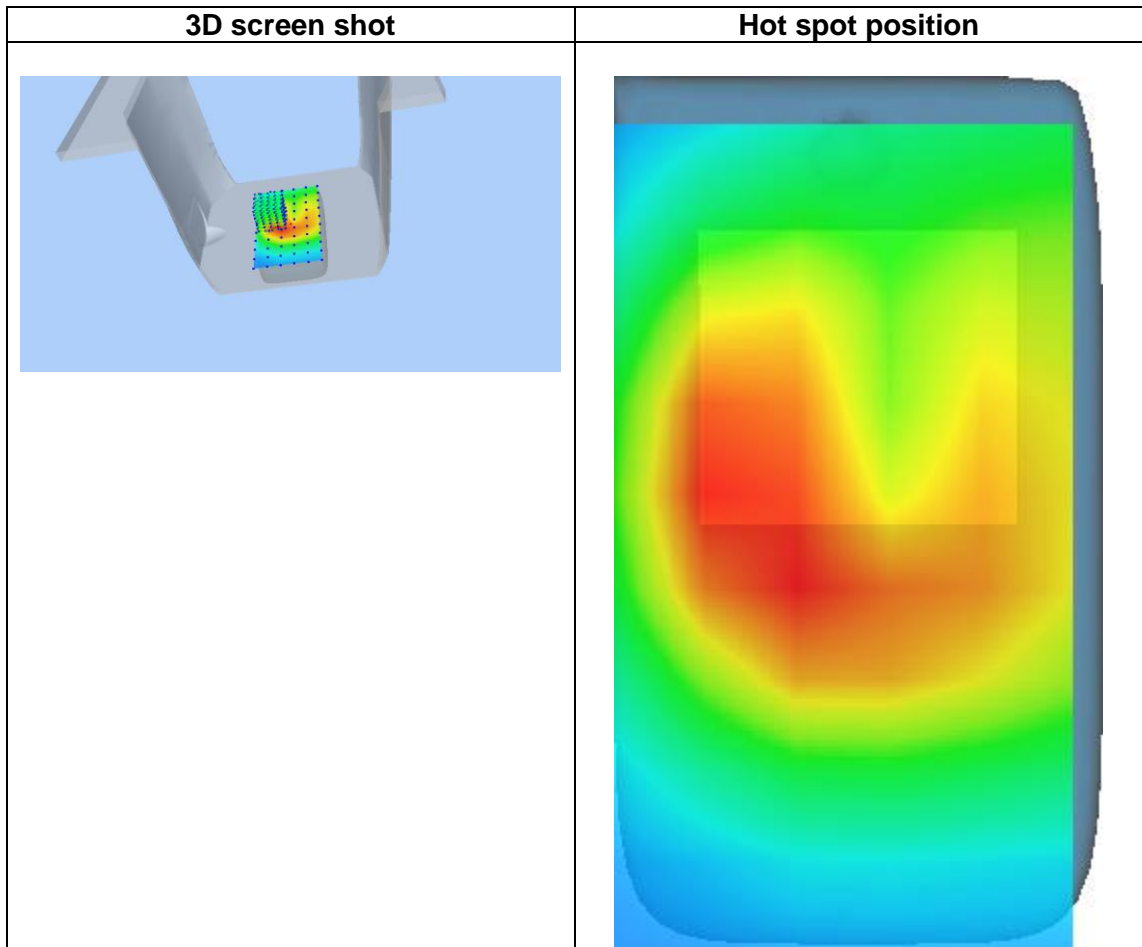
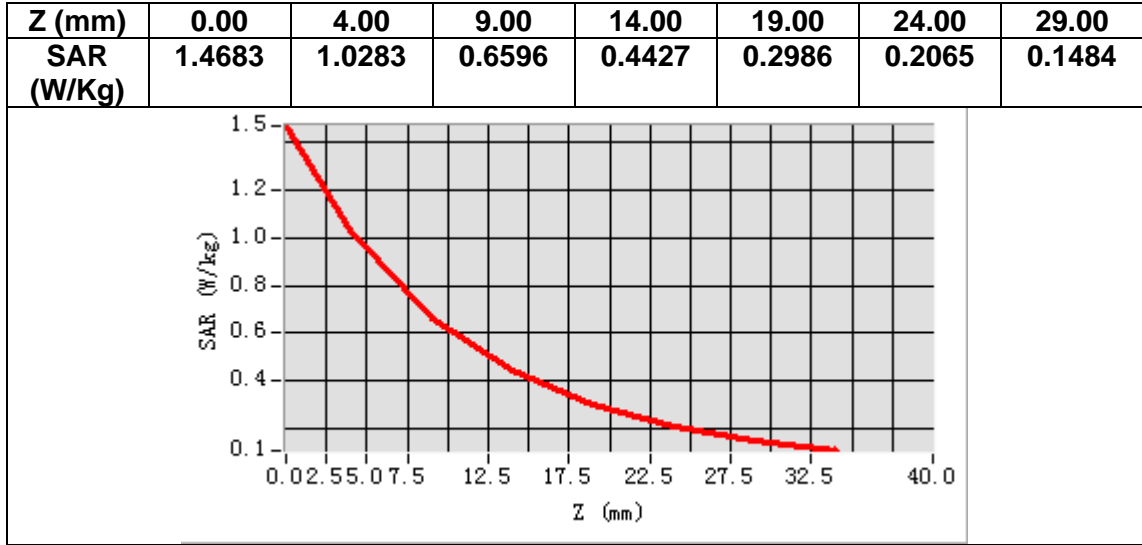

MEASUREMENT 4

Date of measurement: 13/7/2021

A. Experimental conditions.

Area Scan	<u>dx=10mm dy=10mm, h= 2.00 mm</u>
ZoomScan	<u>7x7x12,dx=4mm dy=4mm dz=2mm</u>
Phantom	<u>Validation plane</u>
Device Position	<u>Body</u>
Band	<u>IEEE 802.11a U-NII</u>
Channels	<u>Middle</u>
Signal	<u>IEEE802.11a (Crest factor: 1.0)</u>

B. SAR Measurement Results

Frequency (MHz)	5785.000000
Relative permittivity (real part)	35.841545
Relative permittivity (imaginary part)	16.047638
Conductivity (S/m)	5.157533
Variation (%)	3.560000

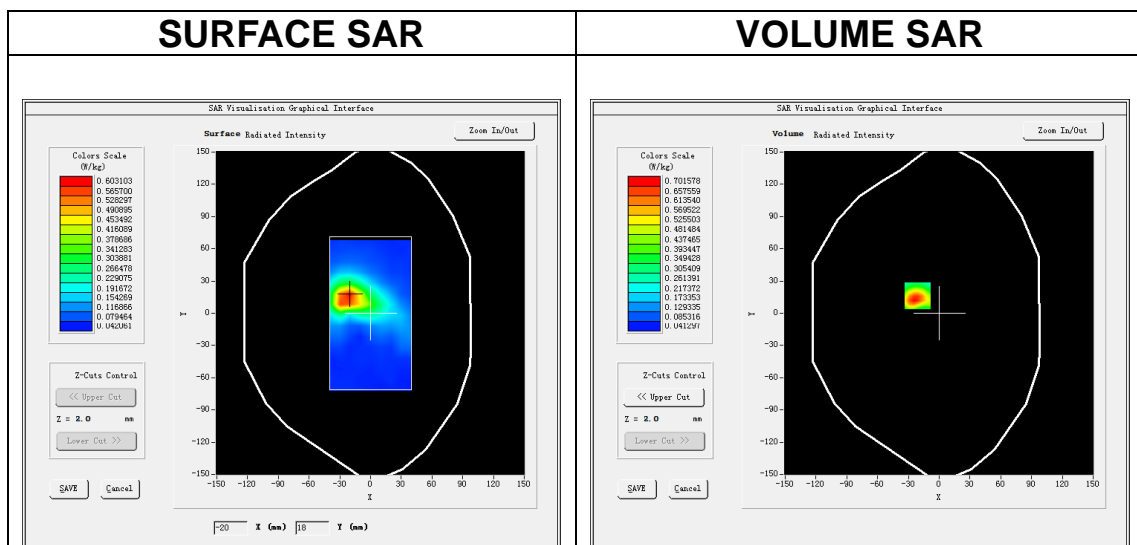

Maximum location: X=-21.00, Y=16.00

SAR Peak: 1.15 W/kg

SAR 10g (W/Kg)	0.195449
SAR 1g (W/Kg)	0.435889

Z (m)	0.00	2.00	4.00	6.00	8.00	10.00	12.00	14.00	16.00	18.00	20.00	22.00
SAR (W/Kg)	1.1374	0.7016	0.3142	0.2539	0.1326	0.1093	0.0728	0.0652	0.0545	0.0562	0.0467	0.0475

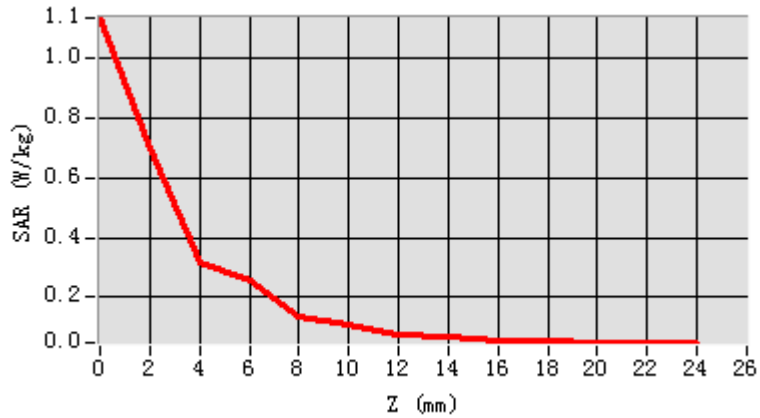

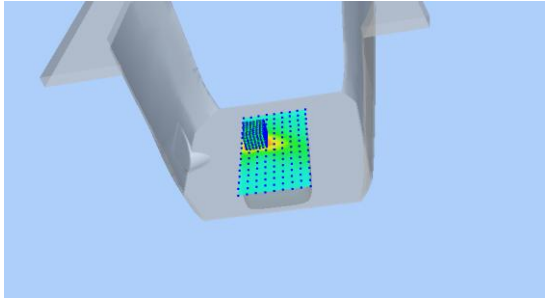
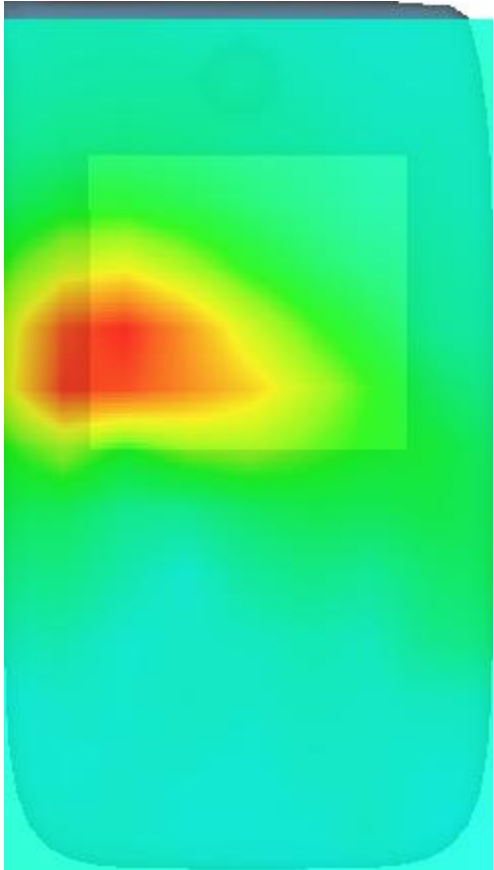
3D screen shot	Hot spot position
	

MEASUREMENT 5

Date of measurement: 8/7/2021

A. Experimental conditions.

Area Scan	<u>dx=12mm dy=12mm, h= 5.00 mm</u>
ZoomScan	<u>7x7x7, dx=5mm dy=5mm dz=5mm</u>
Phantom	<u>Validation plane</u>
Device Position	<u>Body</u>
Band	<u>IEEE 802.11b ISM</u>
Channels	<u>Middle</u>
Signal	<u>IEEE802.11b (Crest factor: 1.0)</u>

B. SAR Measurement Results

Frequency (MHz)	2437.000000
Relative permittivity (real part)	40.273632
Relative permittivity (imaginary part)	13.490183
Conductivity (S/m)	1.826421
Variation (%)	-2.580000

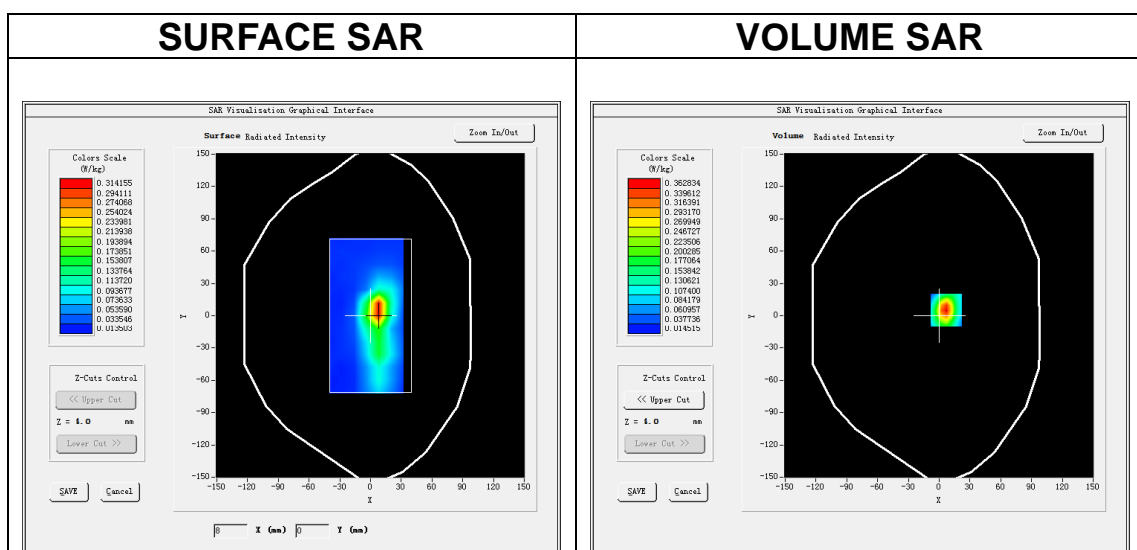

Maximum location: X=7.00, Y=5.00

SAR Peak: 0.63 W/kg

SAR 10g (W/Kg)	0.149765
SAR 1g (W/Kg)	0.330022

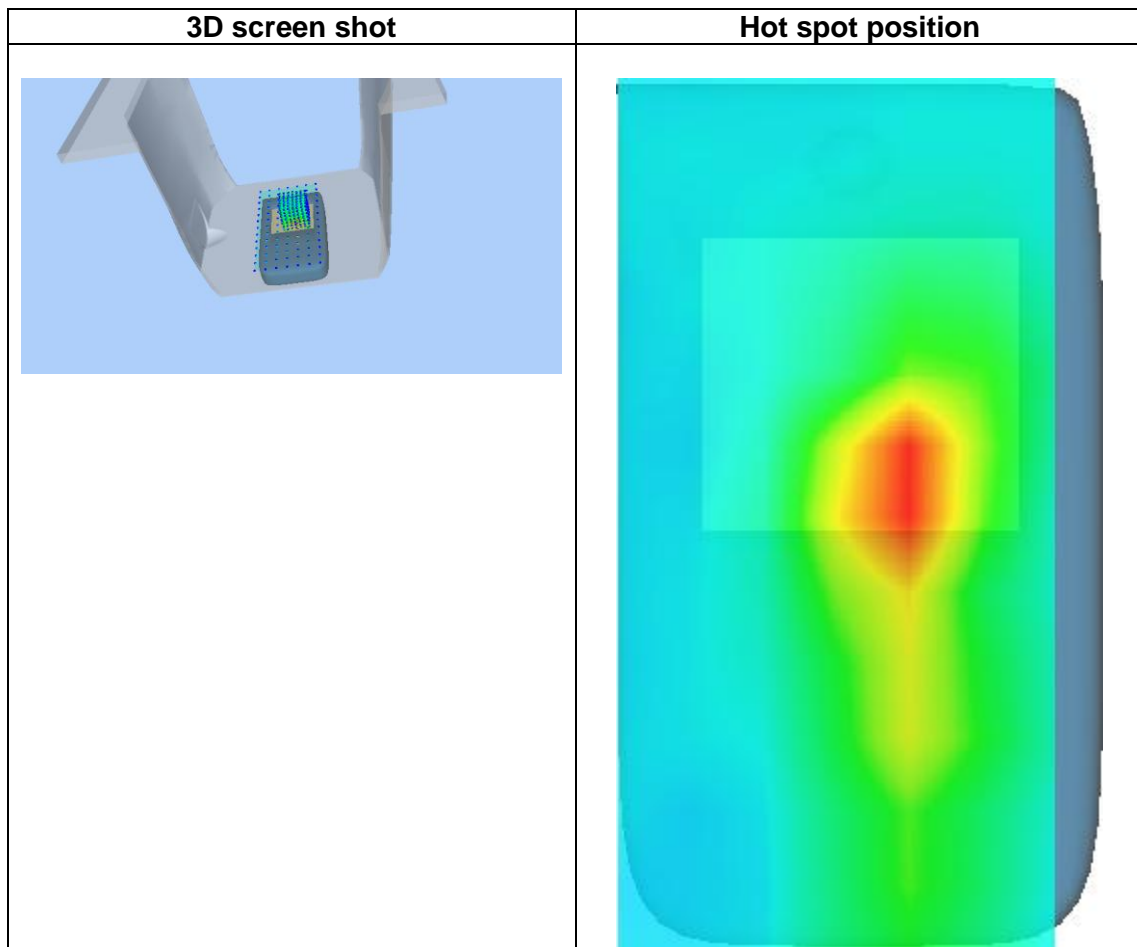
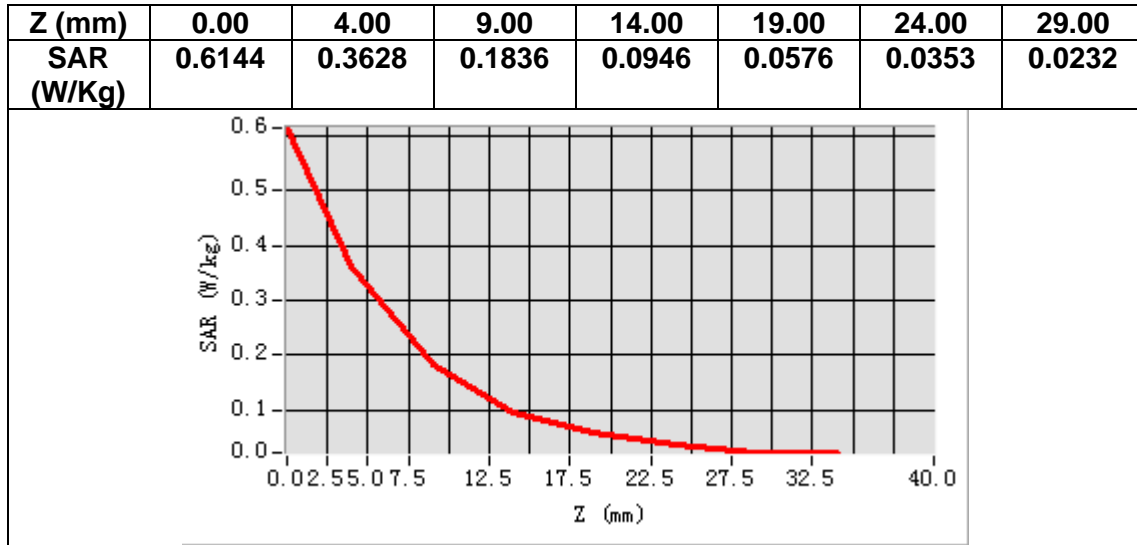

MEASUREMENT 6

Date of measurement: 5/7/2021

A. Experimental conditions.

Area Scan	<u>dx=15mm dy=15mm, h= 5.00 mm</u>
ZoomScan	<u>5x5x7, dx=8mm dy=8mm dz=5mm</u>
Phantom	<u>Validation plane</u>
Device Position	<u>Body</u>
Band	<u>LTE band 2</u>
Channels	<u>Low</u>
Signal	<u>LTE (Crest factor: 1.0)</u>

B. SAR Measurement Results

Frequency (MHz)	1860.000000
Relative permittivity (real part)	38.895374
Relative permittivity (imaginary part)	13.814234
Conductivity (S/m)	1.427087
Variation (%)	2.050000

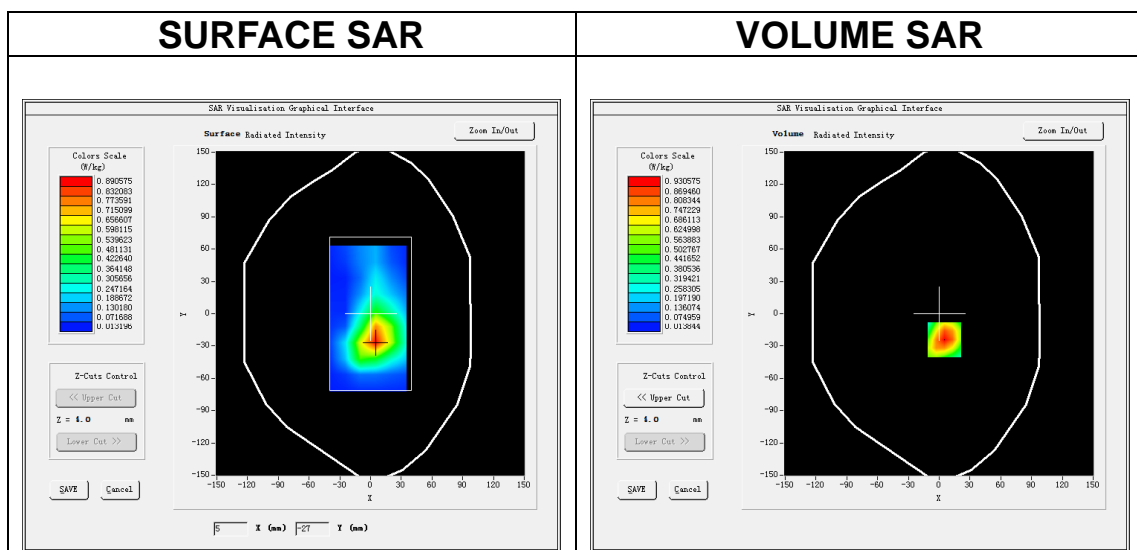

Maximum location: X=5.00, Y=-24.00

SAR Peak: 1.56 W/kg

SAR 10g (W/Kg)	0.454072
SAR 1g (W/Kg)	0.905117

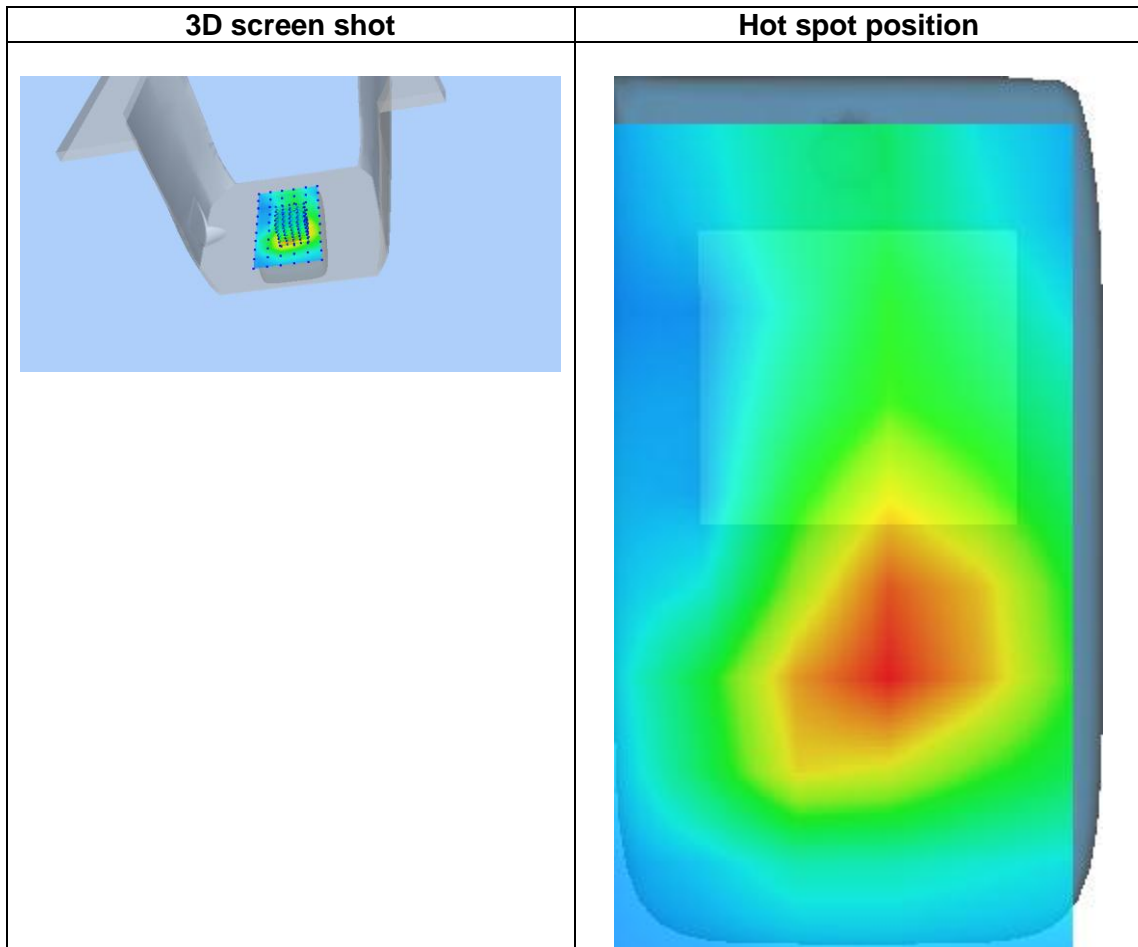
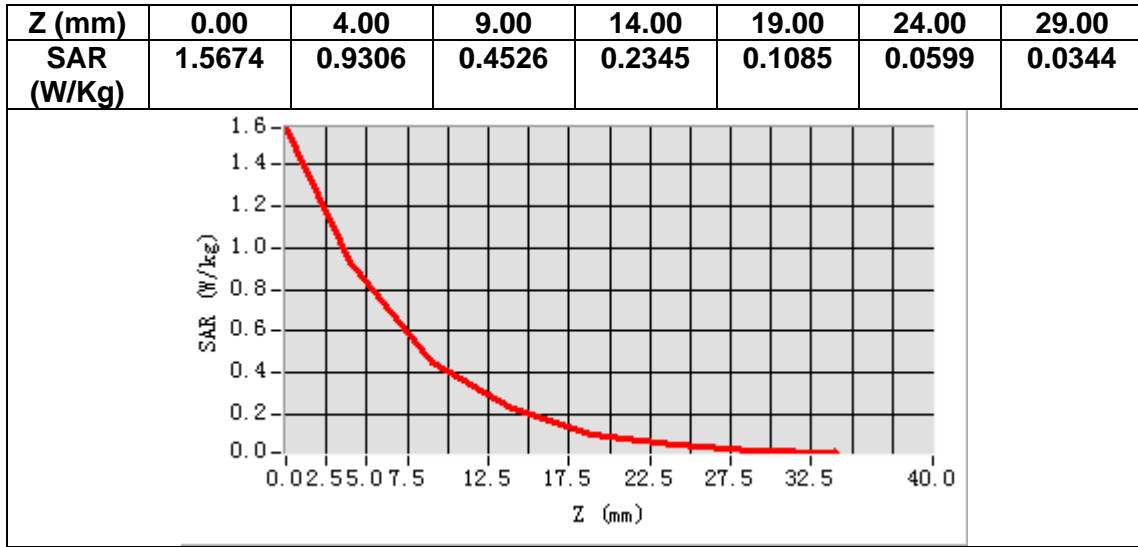

MEASUREMENT 7

Date of measurement: 1/7/2021

A. Experimental conditions.

Area Scan	<u>dx=15mm dy=15mm, h= 5.00 mm</u>
ZoomScan	<u>5x5x7, dx=8mm dy=8mm dz=5mm</u>
Phantom	<u>Validation plane</u>
Device Position	<u>Body</u>
Band	<u>LTE band 4</u>
Channels	<u>Low</u>
Signal	<u>LTE (Crest factor: 1.0)</u>

B. SAR Measurement Results

Frequency (MHz)	1720.000000
Relative permittivity (real part)	40.408802
Relative permittivity (imaginary part)	14.038663
Conductivity (S/m)	1.341082
Variation (%)	-1.620000

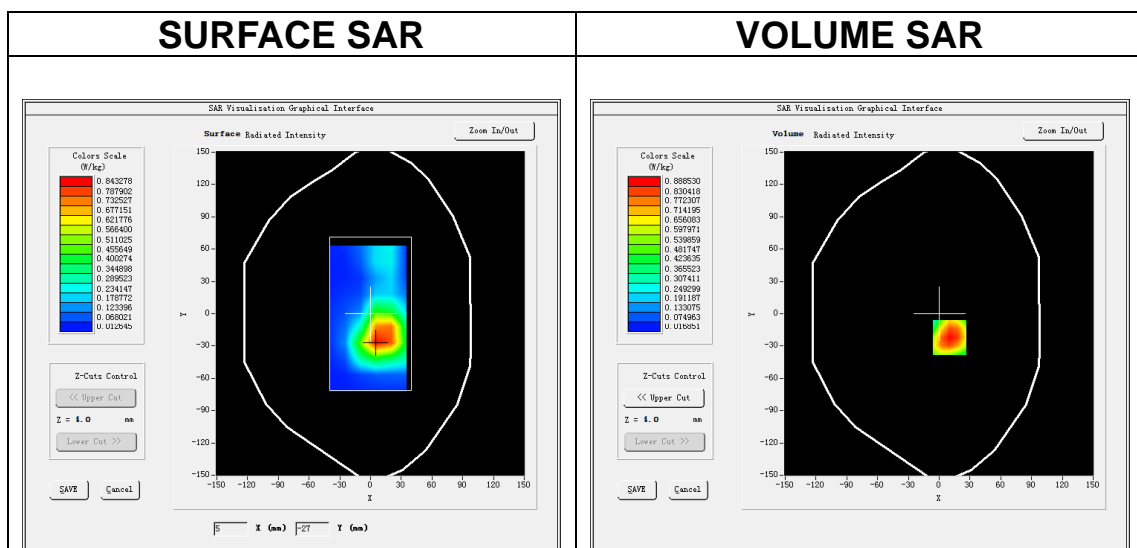

Maximum location: X=10.00, Y=-22.00

SAR Peak: 1.44 W/kg

SAR 10g (W/Kg)	0.455310
SAR 1g (W/Kg)	0.857358

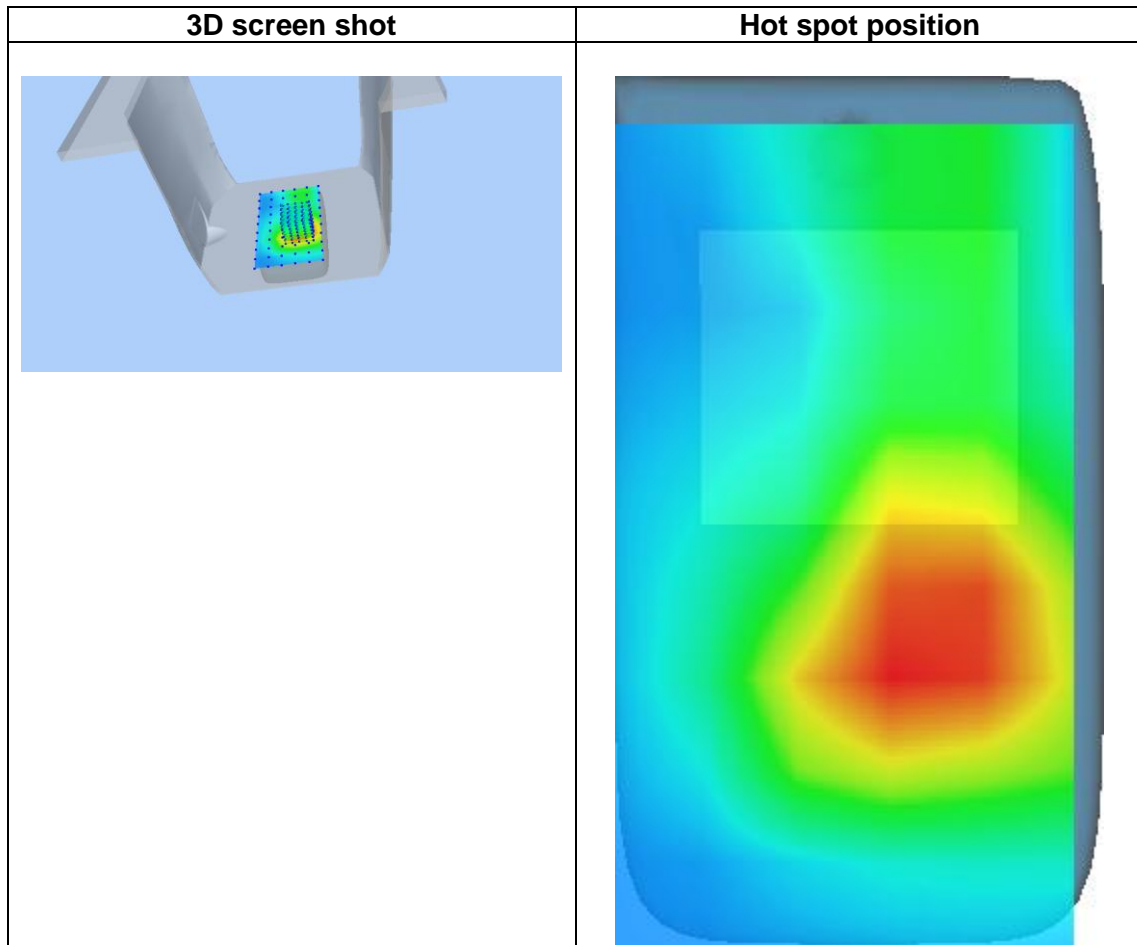
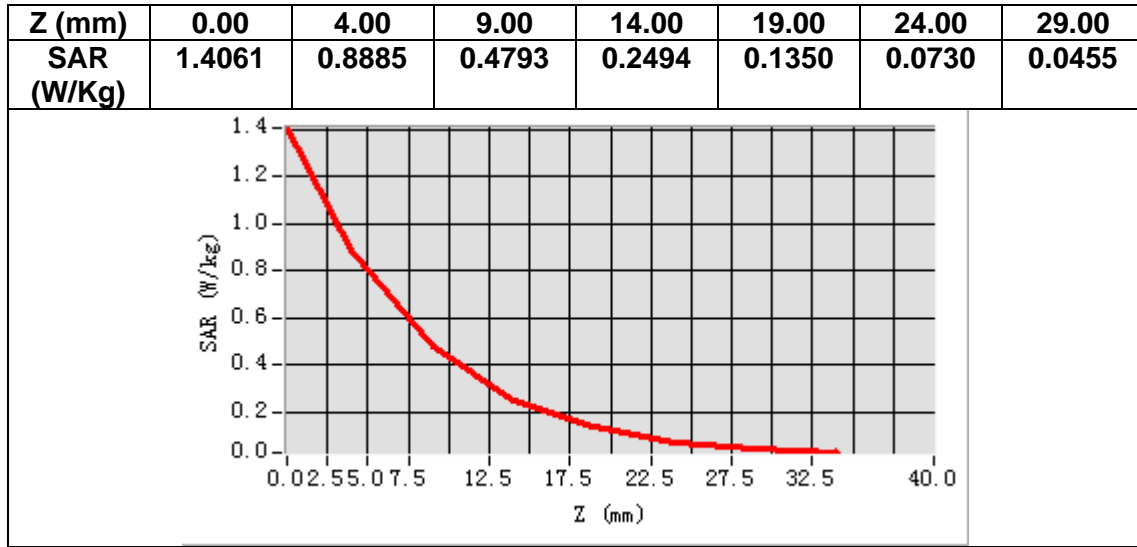

MEASUREMENT 8

Date of measurement: 29/6/2021

A. Experimental conditions.

Area Scan	<u>dx=15mm dy=15mm, h= 5.00 mm</u>
ZoomScan	<u>5x5x7, dx=8mm dy=8mm dz=5mm</u>
Phantom	<u>Validation plane</u>
Device Position	<u>Body</u>
Band	<u>LTE band 5</u>
Channels	<u>High</u>
Signal	<u>LTE (Crest factor: 1.0)</u>

B. SAR Measurement Results

Frequency (MHz)	844.000000
Relative permittivity (real part)	41.959209
Relative permittivity (imaginary part)	19.949972
Conductivity (S/m)	0.934878
Variation (%)	1.940000

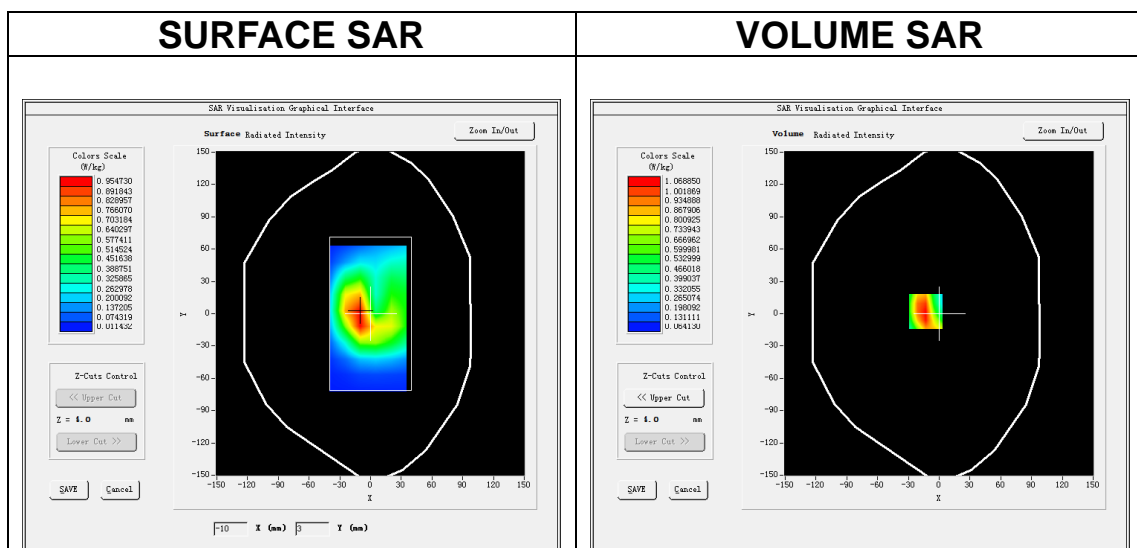

Maximum location: X=-13.00, Y=2.00

SAR Peak: 1.62 W/kg

SAR 10g (W/Kg)	0.610451
SAR 1g (W/Kg)	1.050605

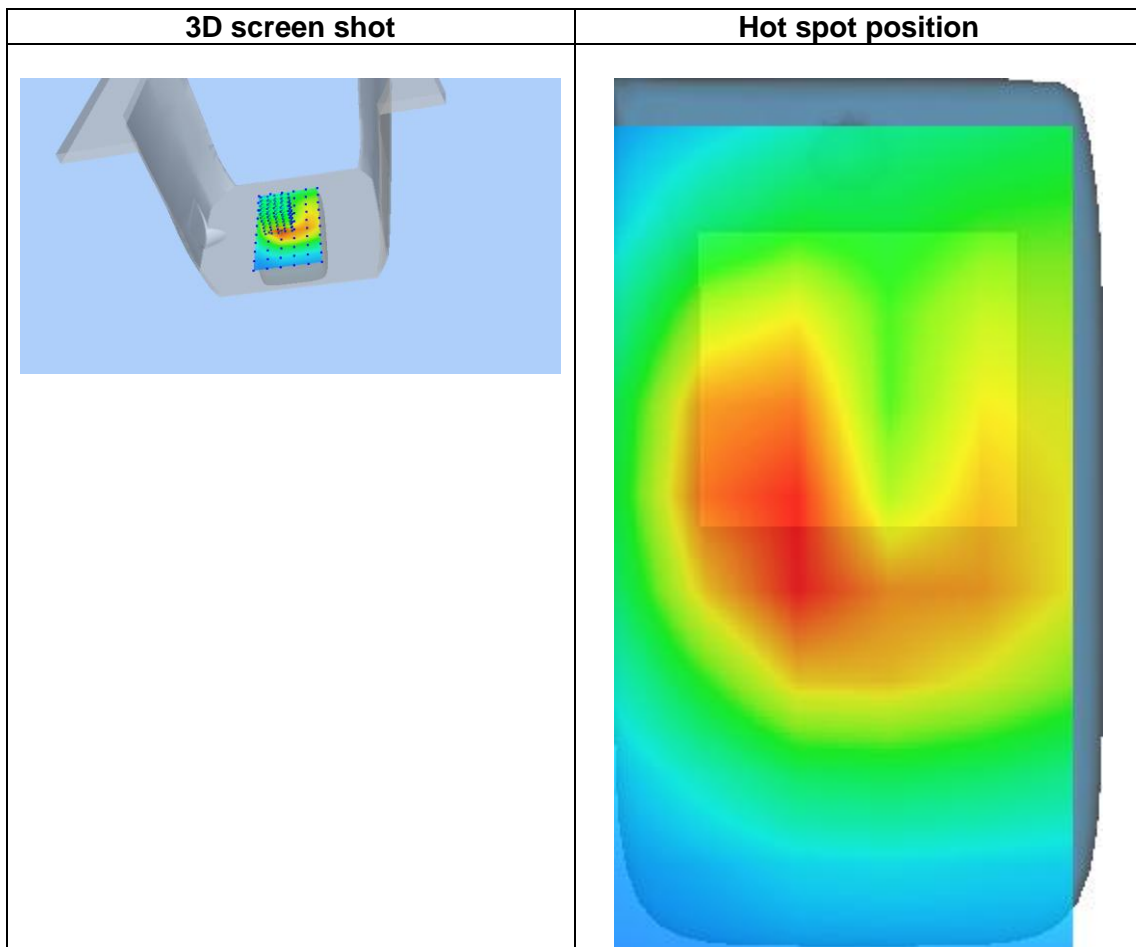
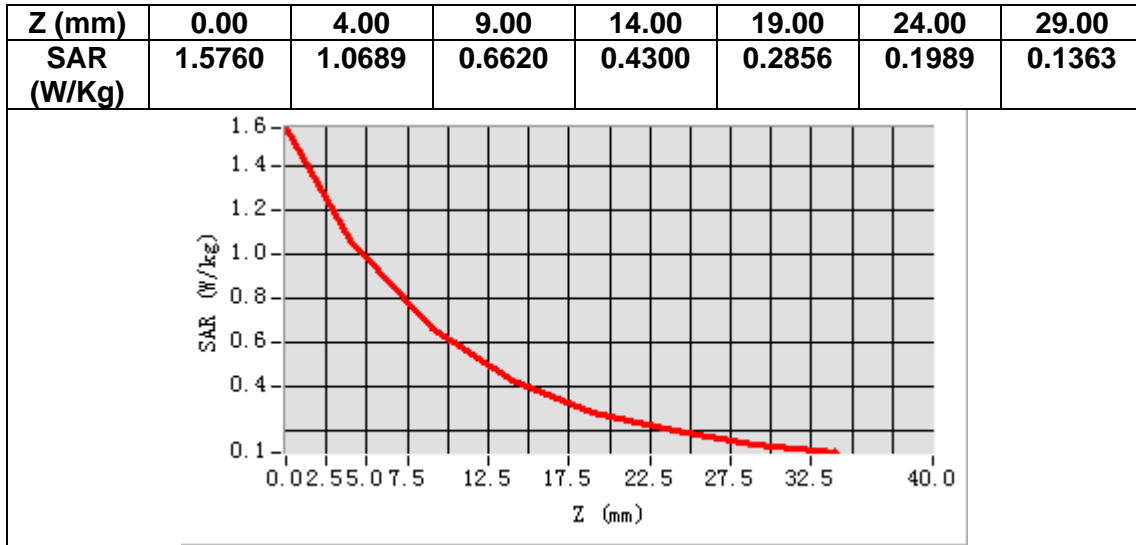

MEASUREMENT 9

Date of measurement: 28/6/2021

A. Experimental conditions.

Area Scan	<u>dx=15mm dy=15mm, h= 5.00 mm</u>
ZoomScan	<u>5x5x7, dx=8mm dy=8mm dz=5mm</u>
Phantom	<u>Validation plane</u>
Device Position	<u>Body</u>
Band	<u>LTE band 12</u>
Channels	<u>Middle</u>
Signal	<u>LTE (Crest factor: 1.0)</u>

B. SAR Measurement Results

Frequency (MHz)	707.500000
Relative permittivity (real part)	41.589821
Relative permittivity (imaginary part)	21.587030
Conductivity (S/m)	0.848490
Variation (%)	-2.840000

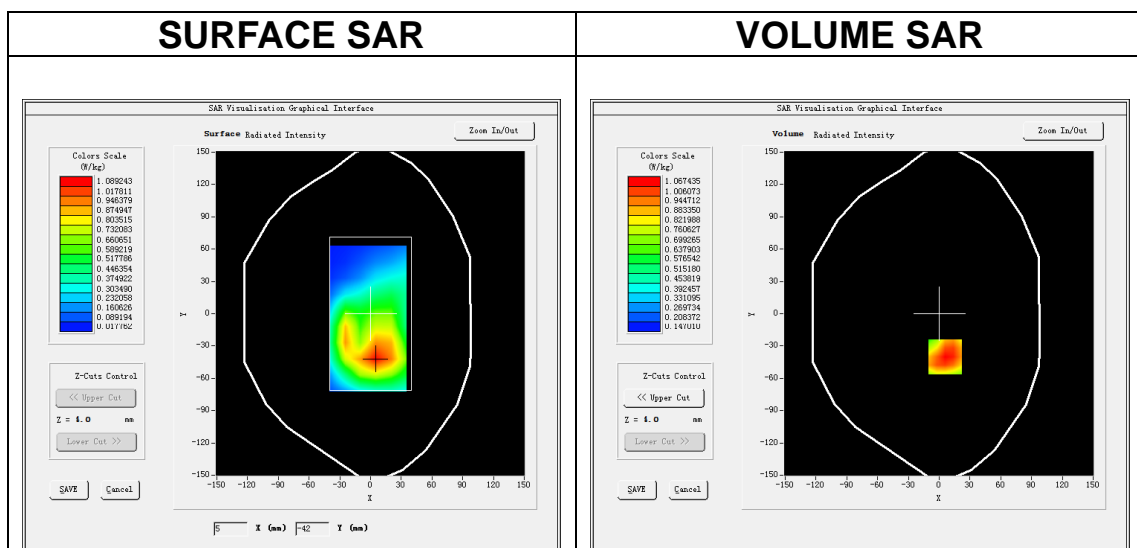

Maximum location: X=6.00, Y=-40.00

SAR Peak: 1.35 W/kg

SAR 10g (W/Kg)	0.769272
SAR 1g (W/Kg)	1.039050

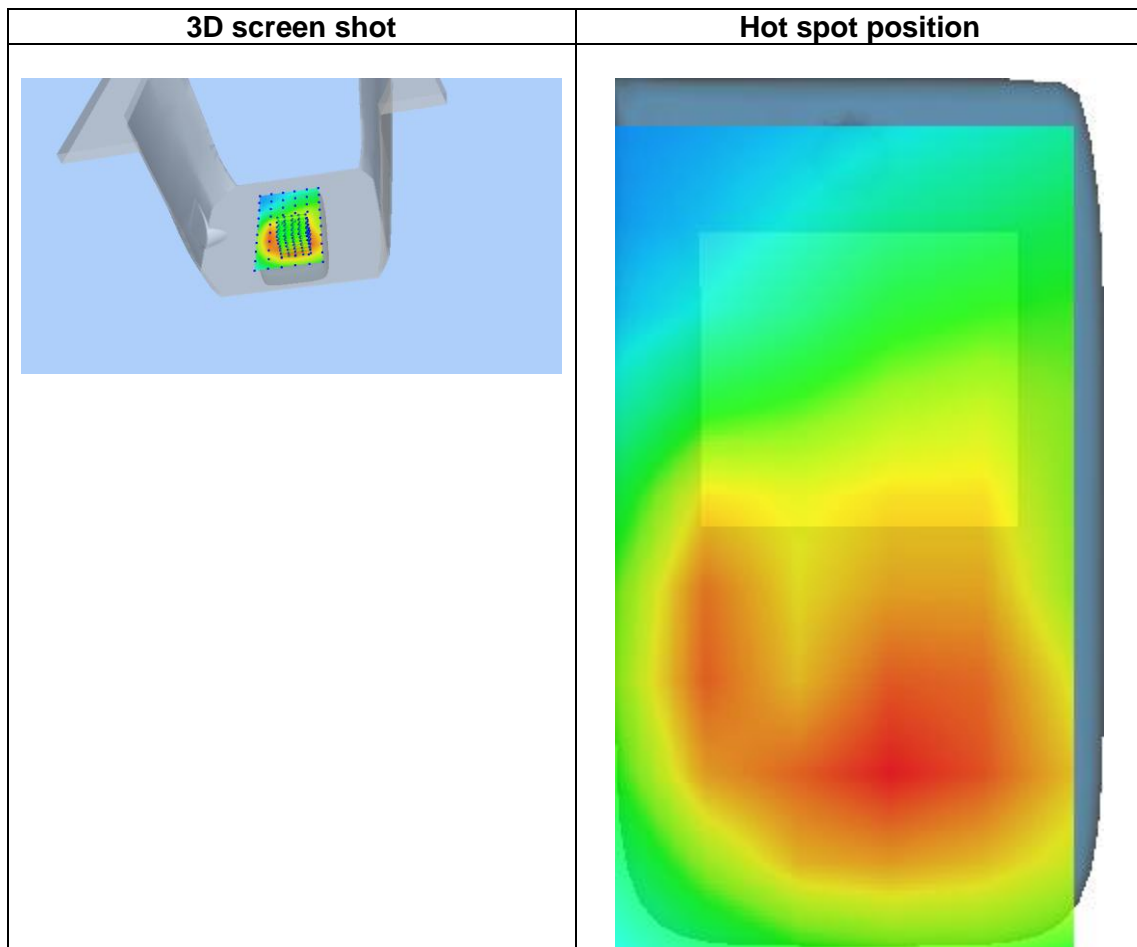
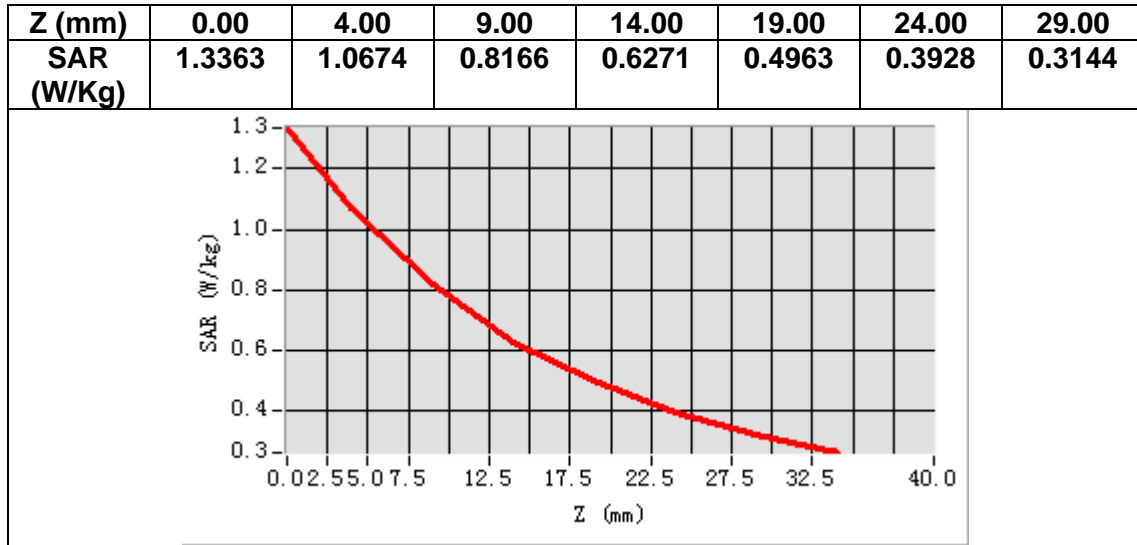

MEASUREMENT 10

Date of measurement: 28/6/2021

A. Experimental conditions.

Area Scan	<u>dx=15mm dy=15mm, h= 5.00 mm</u>
ZoomScan	<u>5x5x7, dx=8mm dy=8mm dz=5mm</u>
Phantom	<u>Validation plane</u>
Device Position	<u>Body</u>
Band	<u>LTE band 13</u>
Channels	<u>Middle</u>
Signal	<u>LTE (Crest factor: 1.0)</u>

B. SAR Measurement Results

Frequency (MHz)	782.000000
Relative permittivity (real part)	40.755970
Relative permittivity (imaginary part)	20.379082
Conductivity (S/m)	0.884792
Variation (%)	0.600000

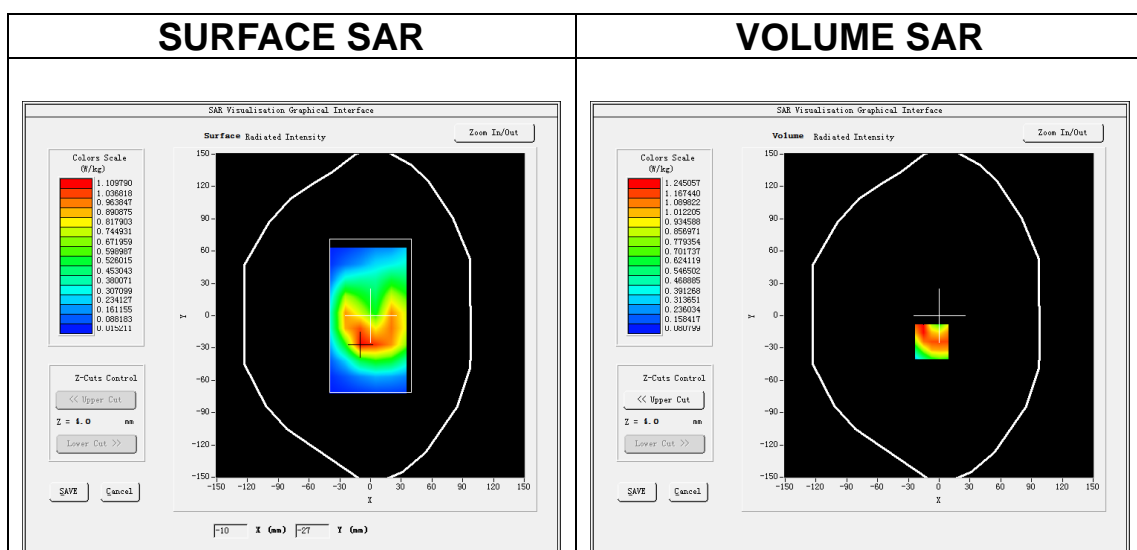

Maximum location: X=-7.00, Y=-24.00

SAR Peak: 1.80 W/kg

SAR 10g (W/Kg)	0.702724
SAR 1g (W/Kg)	1.160474

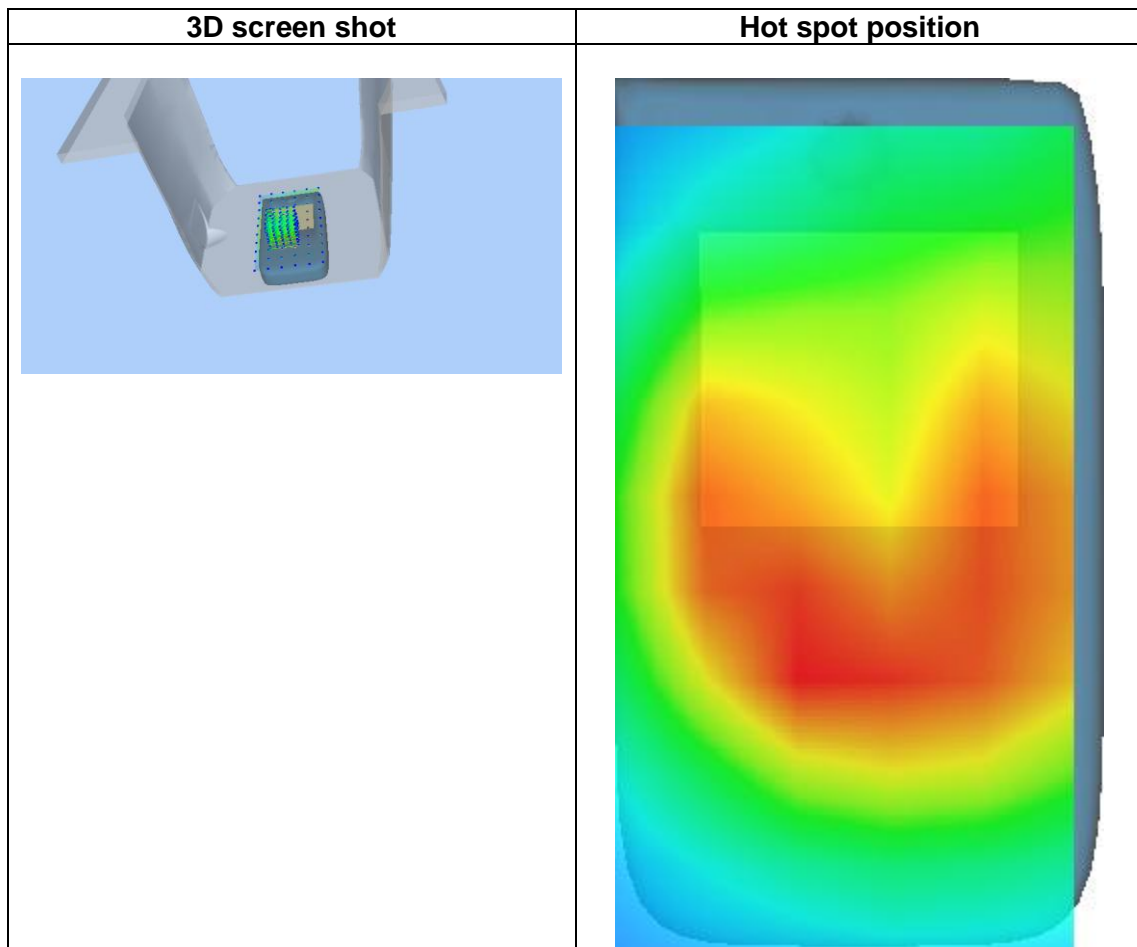
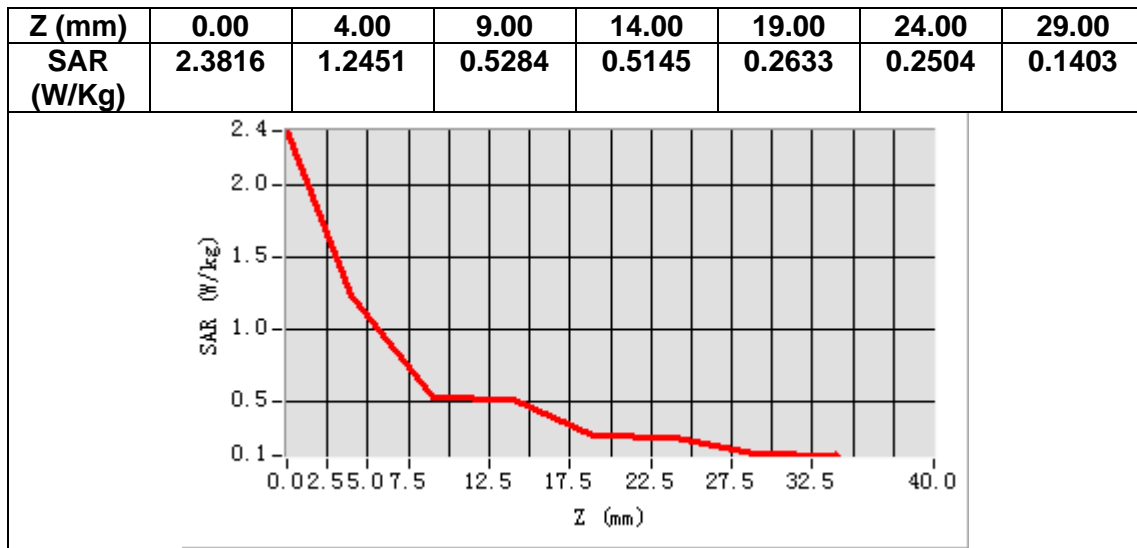

MEASUREMENT 11

Date of measurement: 28/6/2021

A. Experimental conditions.

Area Scan	<u>dx=15mm dy=15mm, h= 5.00 mm</u>
ZoomScan	<u>5x5x7, dx=8mm dy=8mm dz=5mm</u>
Phantom	<u>Validation plane</u>
Device Position	<u>Body</u>
Band	<u>LTE band 14</u>
Channels	<u>Middle</u>
Signal	<u>LTE (Crest factor: 1.0)</u>

B. SAR Measurement Results

Frequency (MHz)	793.000000
Relative permittivity (real part)	40.570769
Relative permittivity (imaginary part)	20.961381
Conductivity (S/m)	0.923465
Variation (%)	0.780000

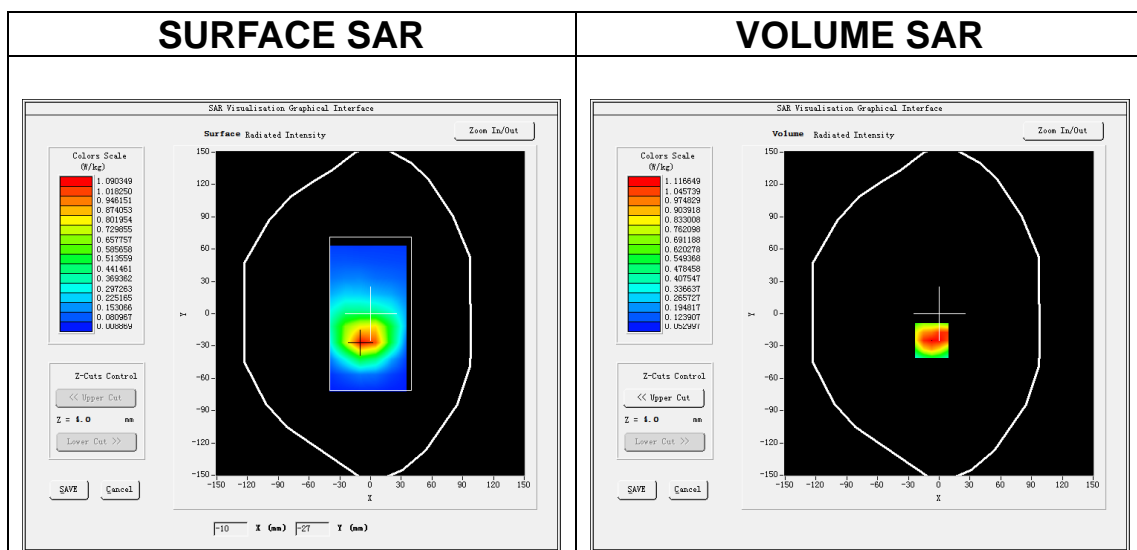

Maximum location: X=-7.00, Y=-25.00

SAR Peak: 1.79 W/kg

SAR 10g (W/Kg)	0.628061
SAR 1g (W/Kg)	1.098899

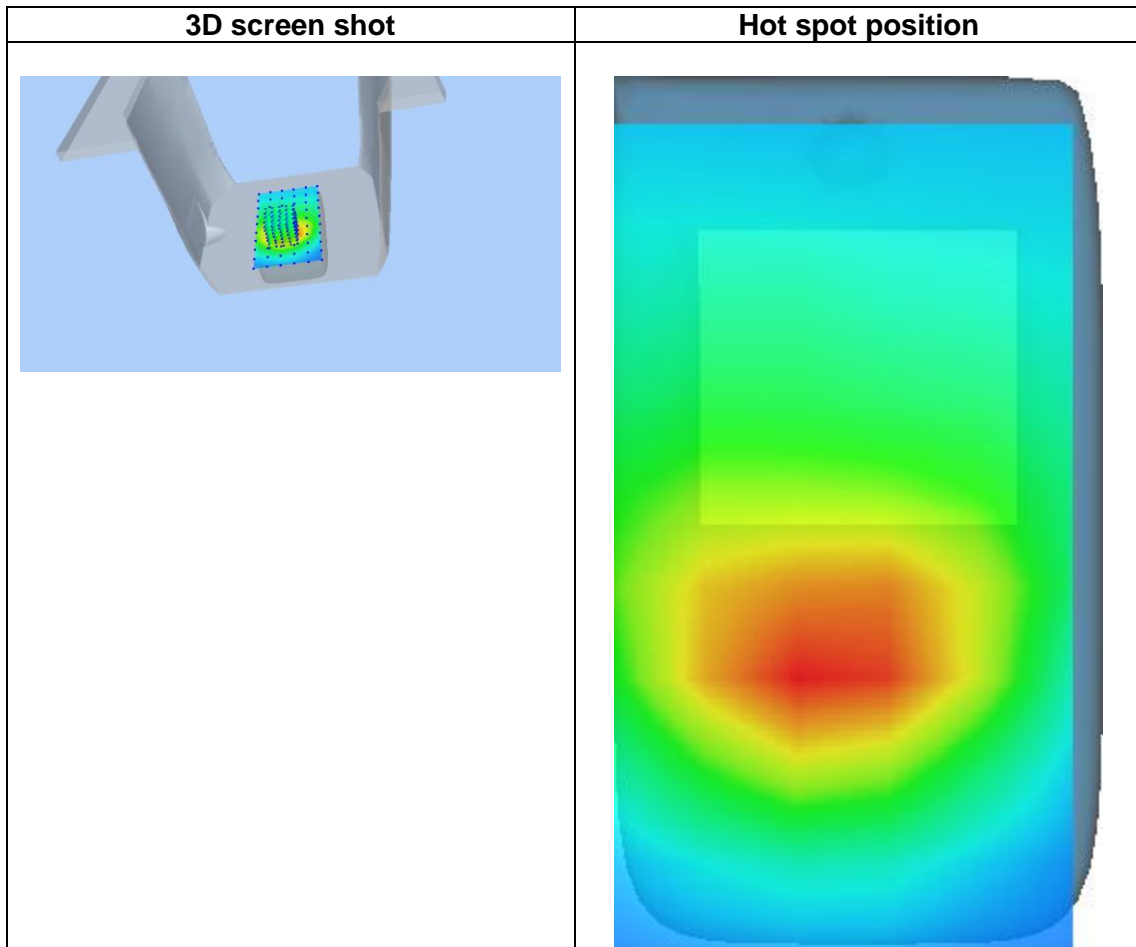
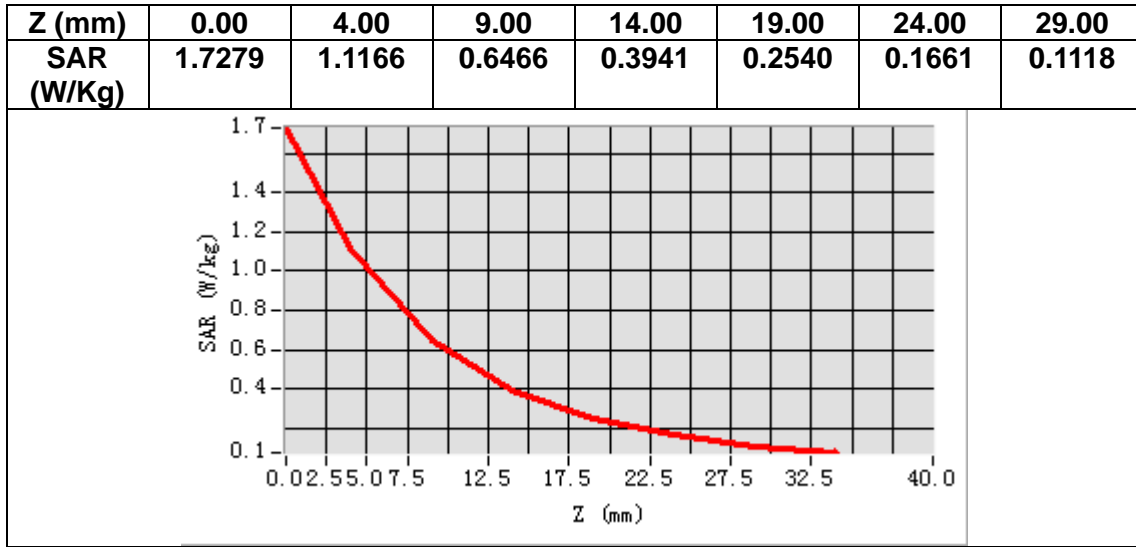

MEASUREMENT 12

Date of measurement: 1/7/2021

A. Experimental conditions.

Area Scan	<u>dx=15mm dy=15mm, h= 5.00 mm</u>
ZoomScan	<u>5x5x7, dx=8mm dy=8mm dz=5mm</u>
Phantom	<u>Validation plane</u>
Device Position	<u>Body</u>
Band	<u>LTE band 66</u>
Channels	<u>Middle</u>
Signal	<u>LTE (Crest factor: 1.0)</u>

B. SAR Measurement Results

Frequency (MHz)	1745.000000
Relative permittivity (real part)	40.204300
Relative permittivity (imaginary part)	14.077863
Conductivity (S/m)	1.364771
Variation (%)	2.010000

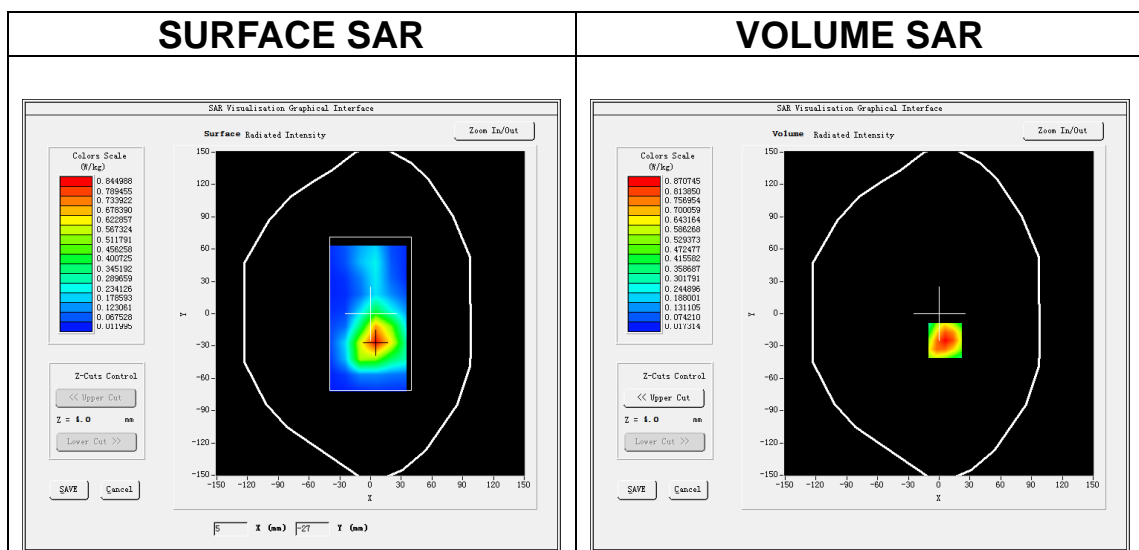

Maximum location: X=6.00, Y=-25.00

SAR Peak: 1.44 W/kg

SAR 10g (W/Kg)	0.436466
SAR 1g (W/Kg)	0.838239

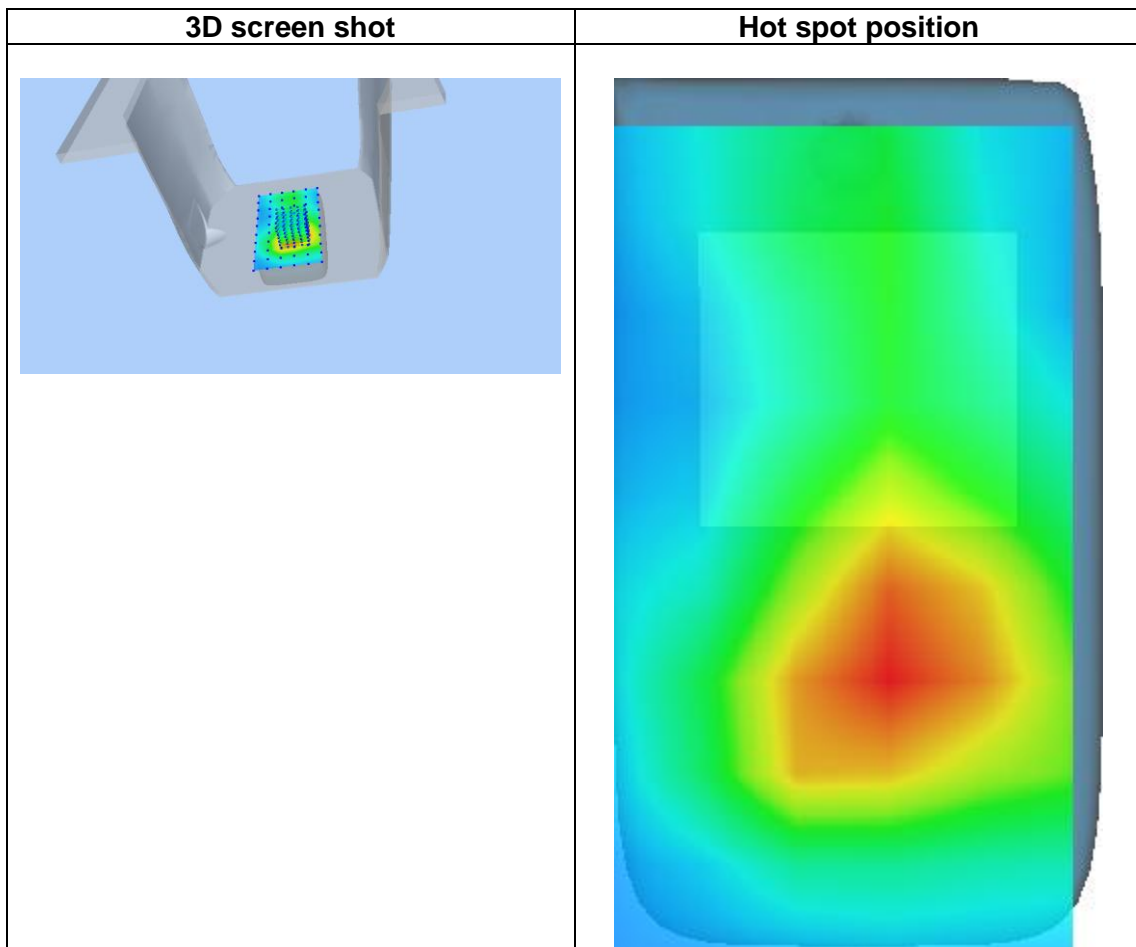
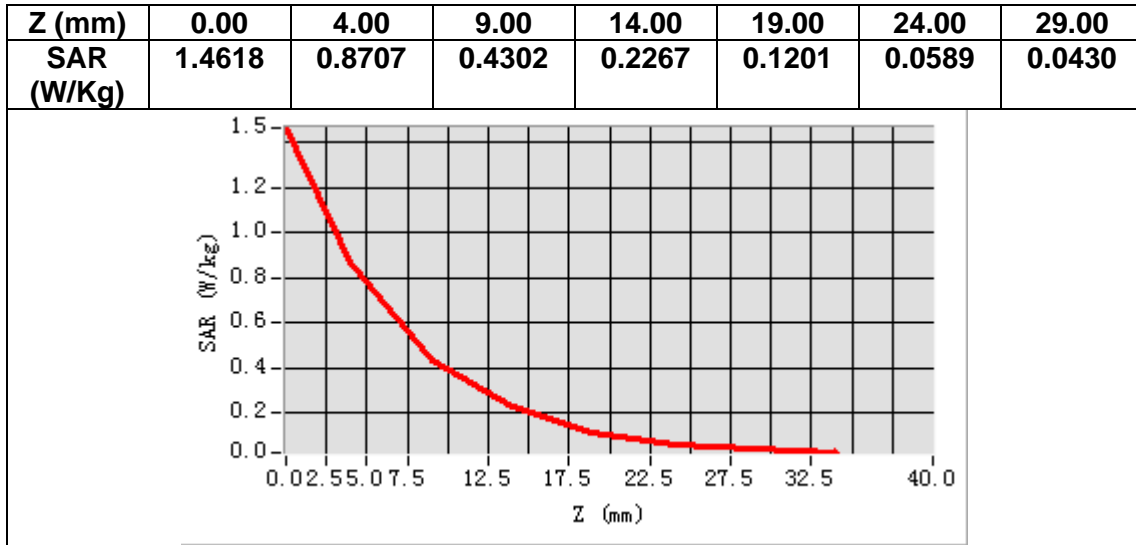

MEASUREMENT 13

Date of measurement: 28/6/2021

A. Experimental conditions.

Area Scan	<u>dx=15mm dy=15mm, h= 5.00 mm</u>
ZoomScan	<u>5x5x7,dx=8mm dy=8mm dz=5mm</u>
Phantom	<u>Validation plane</u>
Device Position	<u>Body</u>
Band	<u>LTE band 71</u>
Channels	<u>Middle</u>
Signal	<u>LTE (Crest factor: 1.0)</u>

B. SAR Measurement Results

Frequency (MHz)	680.500000
Relative permittivity (real part)	41.933569
Relative permittivity (imaginary part)	22.336581
Conductivity (S/m)	0.472171
Variation (%)	-0.090000

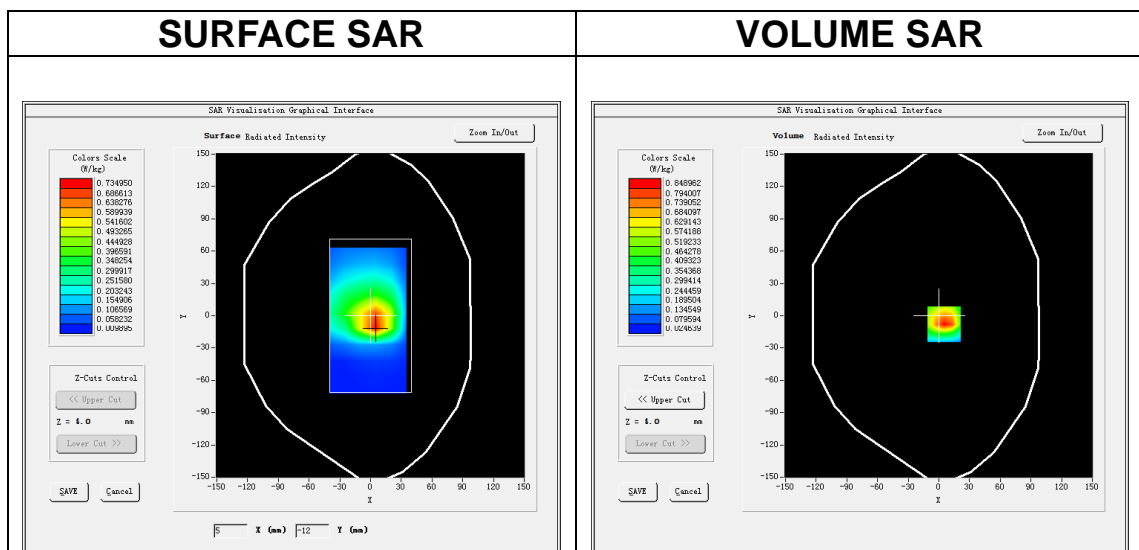

Maximum location: X=5.00, Y=-8.00

SAR Peak: 1.49 W/kg

SAR 10g (W/Kg)	0.431223
SAR 1g (W/Kg)	0.828381

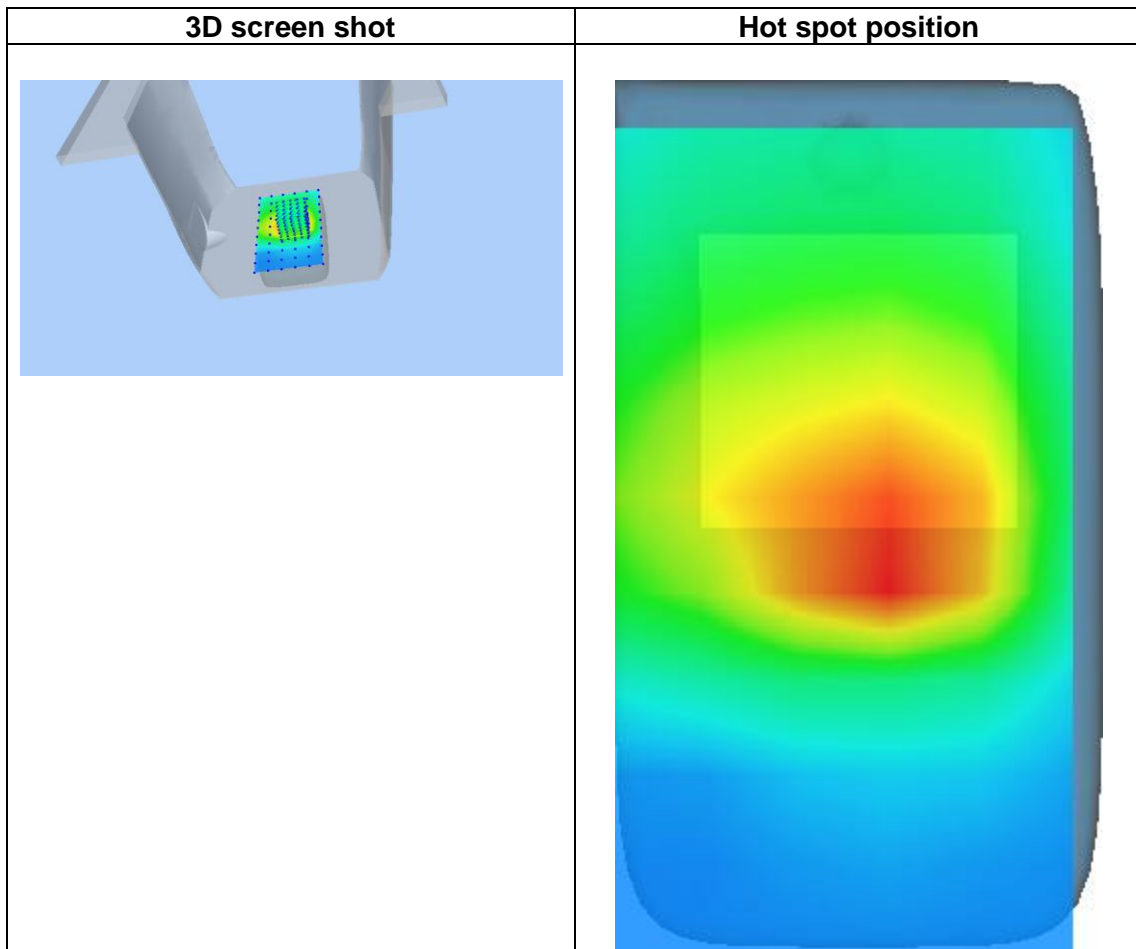
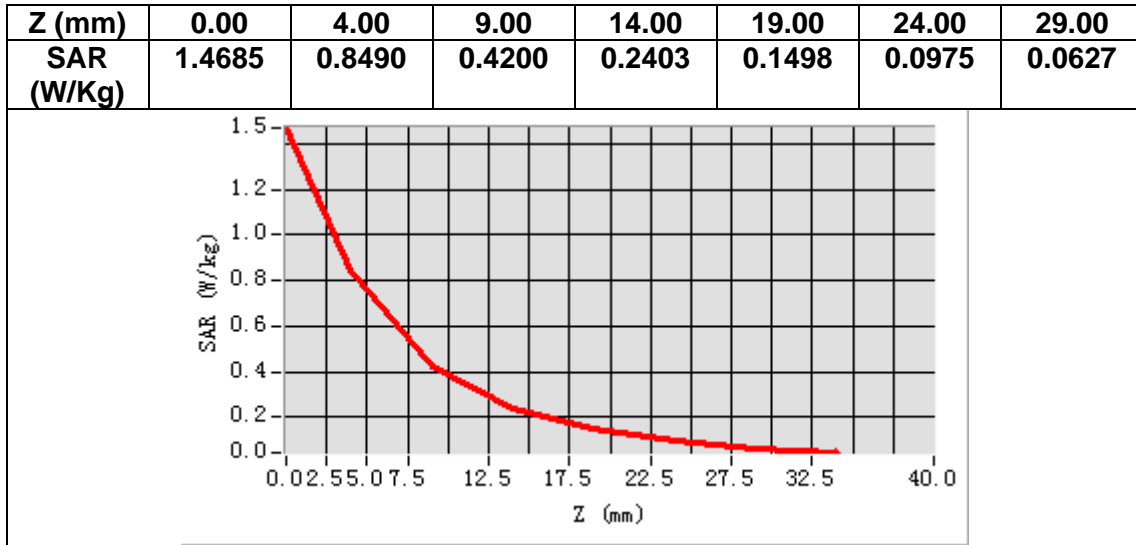

14. Appendix D. Calibration Certificate

Table of contents
E Field Probe - SN 08/16 EPGO287
750 MHz Dipole - SN 03/15 DIP 0G750-355
835 MHz Dipole - SN 03/15 DIP 0G835-347
1800 MHz Dipole - SN 03/15 DIP 1G800-349
1900 MHz Dipole - SN 03/15 DIP 1G900-350
2450 MHz Dipole - SN 03/15 DIP 2G450-352
5000-6000 MHz Dipole - SN 13/14 WGA 33



COMOSAR E-Field Probe Calibration Report

Ref : ACR.60.1.21.MVGB.A

SHENZHEN NTEK TESTING TECHNOLOGY CO., LTD.

BUILDING E, FENDA SCIENCE PARK, SANWEI
COMMUNITY, XIXIANG STREET,
BAO'AN DISTRICT, SHENZHEN GUANGDONG, CHINA
MVG COMOSAR DOSIMETRIC E-FIELD PROBE
SERIAL NO.: SN 08/16 EPGO287

Calibrated at MVG

Z.I. de la pointe du diable

Technopôle Brest Iroise – 295 avenue Alexis de Rochon
29280 PLOUZANE - FRANCE

Calibration date: 03/01/2021



Accreditations #2-6789 and #2-6814
Scope available on www.cofrac.fr

Summary:

This document presents the method and results from an accredited COMOSAR E-Field Probe calibration performed at MVG, using the CALIPROBE test bench, for use with a MVG COMOSAR system only. The test results covered by accreditation are traceable to the International System of Units (SI).



COMOSAR E-FIELD PROBE CALIBRATION REPORT

Ref: ACR.60.1.21.MVGB.A

	Name	Function	Date	Signature
Prepared by :	Jérôme Luc	Technical Manager	3/1/2021	<i>JL</i>
Checked by :	Jérôme Luc	Technical Manager	3/1/2021	<i>JL</i>
Approved by :	Yann Toutain	Laboratory Director	3/1/2021	<i>Yann Toutain</i>

2021.03.0
1 13:07:12
+01'00'

PHILIPS

	Customer Name
Distribution :	SHENZHEN NTEK TESTING TECHNOLOGY CO., LTD.

Issue	Name	Date	Modifications
A	Jérôme Luc	3/1/2021	Initial release



COMOSAR E-FIELD PROBE CALIBRATION REPORT

Ref: ACR.60.1.21.MVGB.A

TABLE OF CONTENTS

1 Device Under Test 4

2 Product Description 4

 2.1 General Information 4

3 Measurement Method 4

 3.1 Linearity 4

 3.2 Sensitivity 5

 3.3 Lower Detection Limit 5

 3.4 Isotropy 5

 3.1 Boundary Effect 5

4 Measurement Uncertainty 6

5 Calibration Measurement Results 6

 5.1 Sensitivity in air 6

 5.2 Linearity 7

 5.3 Sensitivity in liquid 8

 5.4 Isotropy 9

6 List of Equipment 10



COMOSAR E-FIELD PROBE CALIBRATION REPORT

Ref: ACR.60.1.21.MVGB.A

1 DEVICE UNDER TEST

Device Under Test	
Device Type	COMOSAR DOSIMETRIC E FIELD PROBE
Manufacturer	MVG
Model	SSE2
Serial Number	SN 08/16 EPGO287
Product Condition (new / used)	Used
Frequency Range of Probe	0.15 GHz-6GHz
Resistance of Three Dipoles at Connector	Dipole 1: R1=0.211 MΩ Dipole 2: R2=0.199 MΩ Dipole 3: R3=0.199 MΩ

2 PRODUCT DESCRIPTION

2.1 GENERAL INFORMATION

MVG’s COMOSAR E field Probes are built in accordance to the IEEE 1528, FCC KDB865664 D01, CENELEC EN62209 and CEI/IEC 62209 standards.



Figure 1 – MVG COMOSAR Dosimetric E field Dipole

Probe Length	330 mm
Length of Individual Dipoles	2 mm
Maximum external diameter	8 mm
Probe Tip External Diameter	2.5 mm
Distance between dipoles / probe extremity	1 mm

3 MEASUREMENT METHOD

The IEEE 1528, FCC KDB865664 D01, CENELEC EN62209 and CEI/IEC 62209 standards provide recommended practices for the probe calibrations, including the performance characteristics of interest and methods by which to assess their affect. All calibrations / measurements performed meet the fore mentioned standards.

3.1 LINEARITY

The evaluation of the linearity was done in free space using the waveguide, performing a power sweep to cover the SAR range 0.01W/kg to 100W/kg.



COMOSAR E-FIELD PROBE CALIBRATION REPORT

Ref: ACR.60.1.21.MVGB.A

3.2 SENSITIVITY

The sensitivity factors of the three dipoles were determined using a two step calibration method (air and tissue simulating liquid) using waveguides as outlined in the standards.

3.3 LOWER DETECTION LIMIT

The lower detection limit was assessed using the same measurement set up as used for the linearity measurement. The required lower detection limit is 10 mW/kg.

3.4 ISOTROPY

The axial isotropy was evaluated by exposing the probe to a reference wave from a standard dipole with the dipole mounted under the flat phantom in the test configuration suggested for system validations and checks. The probe was rotated along its main axis from 0 to 360 degrees in 15-degree steps. The hemispherical isotropy is determined by inserting the probe in a thin plastic box filled with tissue-equivalent liquid, with the plastic box illuminated with the fields from a half wave dipole. The dipole is rotated about its axis (0°–180°) in 15° increments. At each step the probe is rotated about its axis (0°–360°).

3.1 BOUNDARY EFFECT

The boundary effect is defined as the deviation between the SAR measured data and the expected exponential decay in the liquid when the probe is oriented normal to the interface. To evaluate this effect, the liquid filled flat phantom is exposed to fields from either a reference dipole or waveguide. With the probe normal to the phantom surface, the peak spatial average SAR is measured and compared to the analytical value at the surface.

The boundary effect uncertainty can be estimated according to the following uncertainty approximation formula based on linear and exponential extrapolations between the surface and $d_{be} + d_{step}$ along lines that are approximately normal to the surface:

$$SAR_{uncertainty} [\%] = \delta SAR_{be} \frac{(d_{be} + d_{step})^2}{2d_{step}} \frac{(e^{-\alpha_{be}(\delta/\beta)})}{\delta/2} \text{ for } (d_{be} + d_{step}) < 10 \text{ mm}$$

where

- SAR_{uncertainty} is the uncertainty in percent of the probe boundary effect
- d_{be} is the distance between the surface and the closest *zoom-scan* measurement point, in millimetre
- Δ_{step} is the separation distance between the first and second measurement points that are closest to the phantom surface, in millimetre, assuming the boundary effect at the second location is negligible
- δ is the minimum penetration depth in millimetres of the head tissue-equivalent liquids defined in this standard, i.e., $\delta \approx 14$ mm at 3 GHz;
- ΔSAR_{be} in percent of SAR is the deviation between the measured SAR value, at the distance d_{be} from the boundary, and the analytical SAR value.



COMOSAR E-FIELD PROBE CALIBRATION REPORT

Ref: ACR.60.1.21.MVGB.A

The measured worst case boundary effect SAR uncertainty [%] for scanning distances larger than 4mm is 1.0% Limit ,2%).

4 MEASUREMENT UNCERTAINTY

The guidelines outlined in the IEEE 1528, OET 65 Bulletin C, CENELEC EN50361 and CEI/IEC 62209 standards were followed to generate the measurement uncertainty associated with an E-field probe calibration using the waveguide technique. All uncertainties listed below represent an expanded uncertainty expressed at approximately the 95% confidence level using a coverage factor of k=2, traceable to the Internationally Accepted Guides to Measurement Uncertainty.

Uncertainty analysis of the probe calibration in waveguide					
ERROR SOURCES	Uncertainty value (%)	Probability Distribution	Divisor	ci	Standard Uncertainty (%)
Expanded uncertainty 95 % confidence level k = 2					14 %

5 CALIBRATION MEASUREMENT RESULTS

Calibration Parameters	
Liquid Temperature	20 +/- 1 °C
Lab Temperature	20 +/- 1 °C
Lab Humidity	30-70 %

5.1 SENSITIVITY IN AIR

Normx dipole 1 (µV/(V/m) ²)	Normy dipole 2 (µV/(V/m) ²)	Normz dipole 3 (µV/(V/m) ²)
0.72	0.66	0.77

DCP dipole 1 (mV)	DCP dipole 2 (mV)	DCP dipole 3 (mV)
107	110	110

Calibration curves $e_i=f(V)$ (i=1,2,3) allow to obtain E-field value using the formula:

$$E = \sqrt{E_1^2 + E_2^2 + E_3^2}$$



COMOSAR E-FIELD PROBE CALIBRATION REPORT

Ref: ACR.60.1.21.MVGB.A

Calibration curves

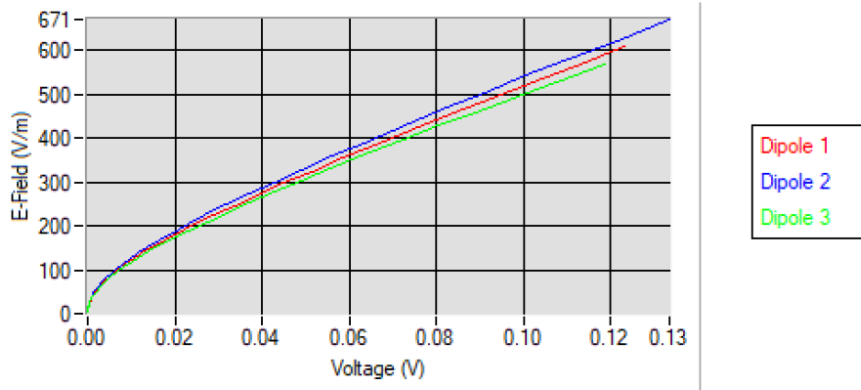

5.2 LINEARITY

Linearity

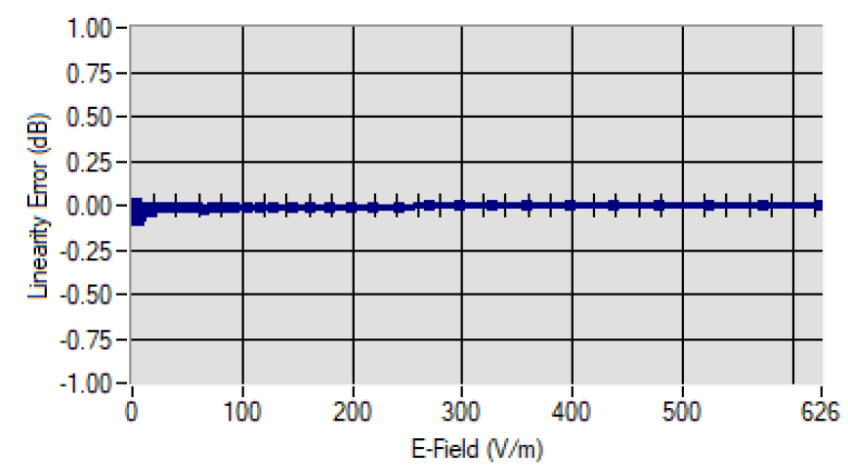

Linearity: +/-1.90% (+/-0.08dB)



COMOSAR E-FIELD PROBE CALIBRATION REPORT

Ref: ACR.60.1.21.MVGB.A

5.3 SENSITIVITY IN LIQUID

Liquid	Frequency (MHz +/- 100MHz)	ConvF
HL750	750	1.49
HL850	835	1.50
HL900	900	1.61
HL1800	1800	1.73
HL1900	1900	1.91
HL2000	2000	1.97
HL2300	2300	1.92
HL2450	2450	1.98
HL2600	2600	1.87
HL3300	3300	1.79
HL3500	3500	1.85
HL3700	3700	1.79
HL3900	3900	2.07
HL4200	4200	2.21
HL4600	4600	2.25
HL4900	4900	2.05
HL5200	5200	1.80
HL5400	5400	2.05
HL5600	5600	2.16
HL5800	5800	2.07

LOWER DETECTION LIMIT: 8mW/kg



COMOSAR E-FIELD PROBE CALIBRATION REPORT

Ref: ACR.60.1.21.MVGB.A

5.4 ISOTROPY

HL1800 MHz

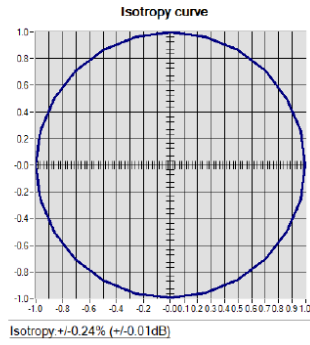



COMOSAR E-FIELD PROBE CALIBRATION REPORT

Ref: ACR.60.1.21.MVGB.A

6 LIST OF EQUIPMENT

Equipment Summary Sheet				
Equipment Description	Manufacturer / Model	Identification No.	Current Calibration Date	Next Calibration Date
Flat Phantom	MVG	SN-20/09-SAM71	Validated. No cal required.	Validated. No cal required.
COMOSAR Test Bench	Version 3	NA	Validated. No cal required.	Validated. No cal required.
Network Analyzer	Rohde & Schwarz ZVM	100203	05/2019	05/2022
Network Analyzer – Calibration kit	Rohde & Schwarz ZV-Z235	101223	05/2019	05/2022
Multimeter	Keithley 2000	1160271	02/2020	02/2023
Signal Generator	Rohde & Schwarz SMB	106589	04/2019	04/2022
Amplifier	Aethercomm	SN 046	Characterized prior to test. No cal required.	Characterized prior to test. No cal required.
Power Meter	NI-USB 5680	170100013	05/2019	05/2022
Directional Coupler	Narda 4216-20	01386	Characterized prior to test. No cal required.	Characterized prior to test. No cal required.
Waveguide	Mega Industries	069Y7-158-13-712	Validated. No cal required.	Validated. No cal required.
Waveguide Transition	Mega Industries	069Y7-158-13-701	Validated. No cal required.	Validated. No cal required.
Waveguide Termination	Mega Industries	069Y7-158-13-701	Validated. No cal required.	Validated. No cal required.
Temperature / Humidity Sensor	Testo 184 H1	44220687	05/2020	05/2023